

# TOC – Critical chain I

J.Skorkovský  
ESF-MU, KPH



# TOC concisely I (see PWP presentation about TOC)

- origin: E.M.Goldratt, Jerusalem
- cost world<->throughput world
- analogy weight of the chain – solidity of the chain
- how to find a bottleneck?
- tools of TOC – tree structures
  - CRT – EC – TT – PT – FRT **meaning:**
  - Current Reality Tree - Evaporating Cloud Tree– Transition Tree -
    - Prerequisite Tree – Future Reality Tree



# TOC concisely I (see PWP presentation about TOC)

- **bottleneck** in project management is critical path
- finding (assessment) of bottleneck is not easy and often it is not explicit (uncompromising)
- everybody knows something about TOC and nobody knows how to implement it to the real world- and this is again another bottleneck (tendon of Achilles from the heel to the scruff)



# TOC-five steps (revision)

## Five steps process:

**Step 0. Identify the Goal of the System/Organization**

**Step 0.5 Establish a way to measure progress to Goal**

- **Step 1. *Identify*** the system's constraint.
- **Step 2. *Exploit*** the system's constraint.
- **Step 3. *Subordinate*** everything else to the above decision.
- **Step 4. *Elevate*** the system's constraint.
- **Step 5.** If a constraint is broken (that is, relieved or improved), go back to Step 1. But don't allow *inertia* to become a constraint.



# Linear image of the project

- activities – abscissas – Gantt graph
- constantly changing conditions (Parkinson law, Murphy law, Student syndrome, customer changes - „fancies“, „caprices“ .. .... ),

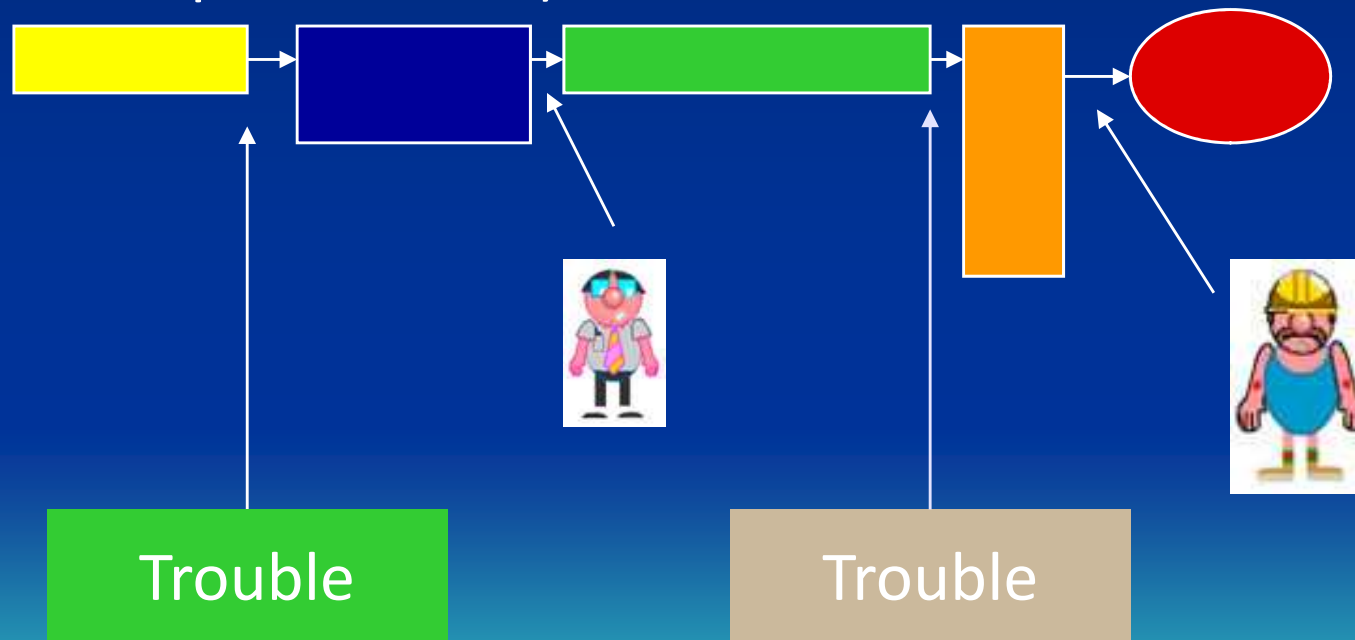

# Parallel image of the project

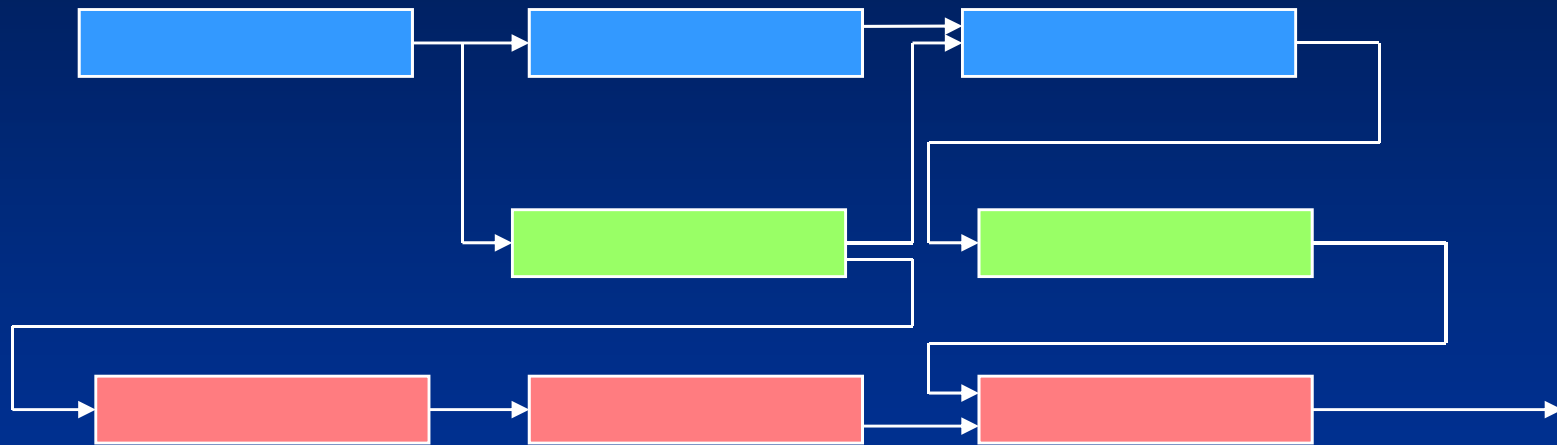

# Project and its budget

- price of the whole project
- project length (time)
- project stages and length of each activity
- assigned resources to every activity and their capacities (time per defined period)
- time reserves (buffers) and their estimation
- unfavourable influences (see Murphy's laws - <http://murphy.euweb.cz>, etc.)



# Selected Murphy's laws

- If your attack is going well, you have walked into an ambush.
- Planner is alerted about modification of the plan exactly in the moment, when the plan is finally adjusted
- To carry out **n+1** trivialities you need two times more time than time necessary to carry out **n** trivialities (law 99 %)
- If anything can go wrong, it will
- Any given program, when running, is obsolete
- No matter how many resources you have, it is never enough
- **Brains x Beauty x Availability = Constant.**  
**This constant is always zero.**





# Project Pyramid - principle

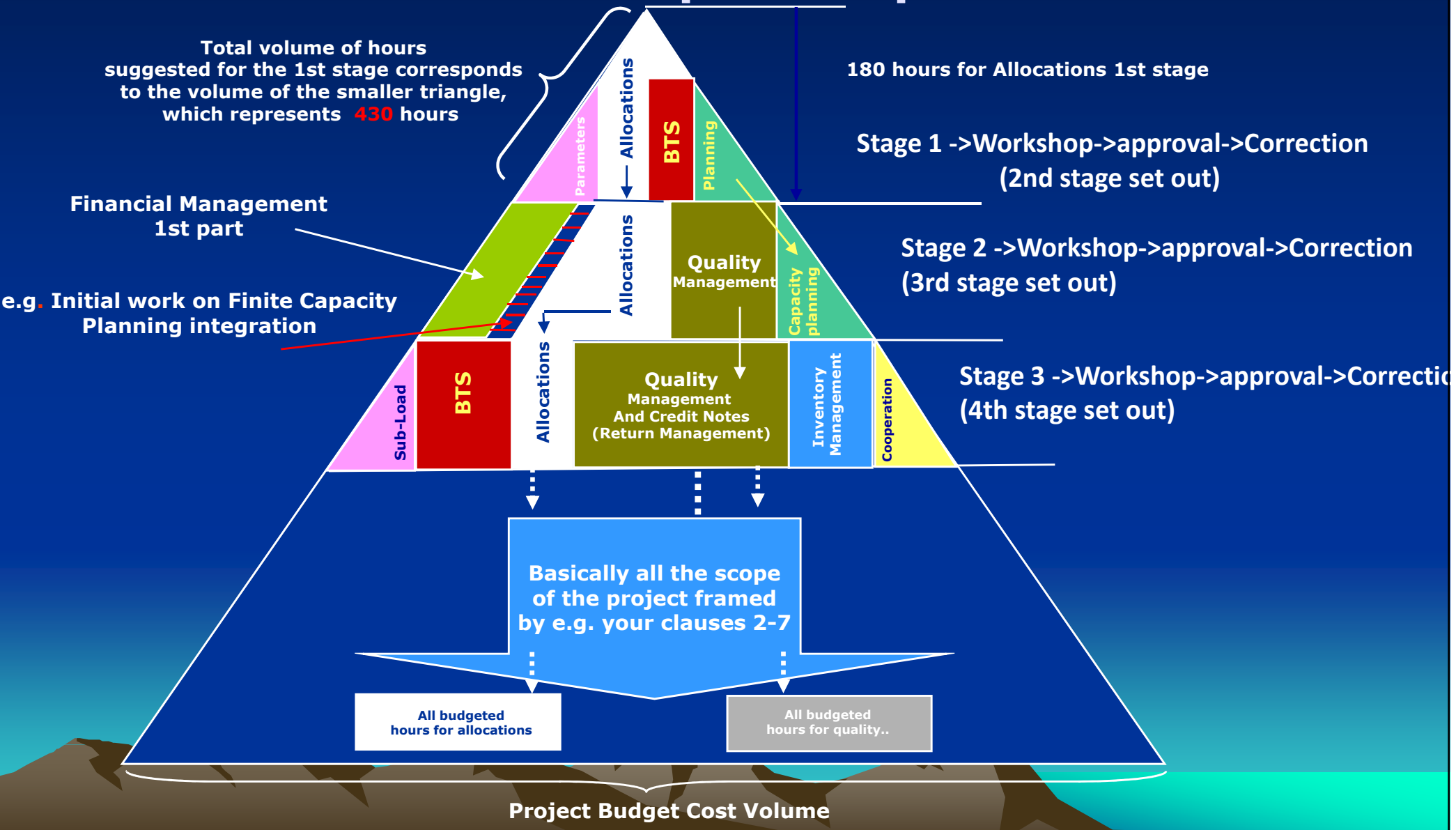

# Example of the real budget- data is modified

Process	Add on / Bespoke (mods) Subproject	Task Description	III.Stage	III.Stage after reshuffling
Development Planning			20	20
<b>Add on / Bespoke Modules Development</b>			<b>422</b>	<b>284</b>
	Call-Offs (it pertains to Purchase area, EDI, JIT,..)	Call- Offs header and lines List of Customer Requirements	70	0
	Allocations (BLUE system) (Adjusted CAP)	<i>Allocation logic</i>	24	32
		The tree structure of allocations (headers, lines, links)	8	8
	Modification to Capacity Planning std nav(Adjusted CAP)	Modification of Machine Centres and Working Centres, links to planning system, allocations, BTS Links to BTS and production planning (1st part of FCS study)	8	0
	Press Tools Management - FE std Model	Maintenance for the machines and cutting tools	8	12
		Routings used for maintenance a links to planning system, <i>Parameters</i>	16	16
	Production Orders, Consumptions Journals, Output Journals, etc. std nav - (Data Capture system)	Checking of the consumption <i>in production, Production Automation</i> Batch Tracking System	8	8
		Design of Touch Pads screens for production reporting ,statistics	16	16
	Customer Order, Job card, Instructions for stocking, <i>Item Card</i>	System of grids and links to BTS, QM, <i>Item Cards, Parameters...</i>	16	16

# Capacity assignment

						Current Status		Plan
Resource	1 / 2008	2 / 2008	3 / 2008	4 / 2008	5 / 2008	6 / 2008	7 / 2008	8 / 2008
John								28,0
Pepa				58,0	105,0	151,2	87,6	70,0
Miki		124,0	124,0	64,0	112,0	0,0	0,0	70,0
Franta						0,0	0,0	0,0
Bob						0,0	0,0	0,0
Antonio					16,0	49,2	26,4	56,0
Blanka					16,0	36,0	31,2	28,0
Caroline						12,0	0,0	42,0
Frederico						0,0	0,0	28,0
Proj.Mng.				32,0	48,0	32,0	182,0	30,0
<b>TOTAL</b>	<b>0</b>	<b>124</b>	<b>124</b>	<b>154</b>	<b>297</b>	<b>280</b>	<b>327</b>	<b>352</b>

# Resources and orders

Matrix structure of multi-project environment – responsibility of project managers and responsibility of department managers are **in conflict**

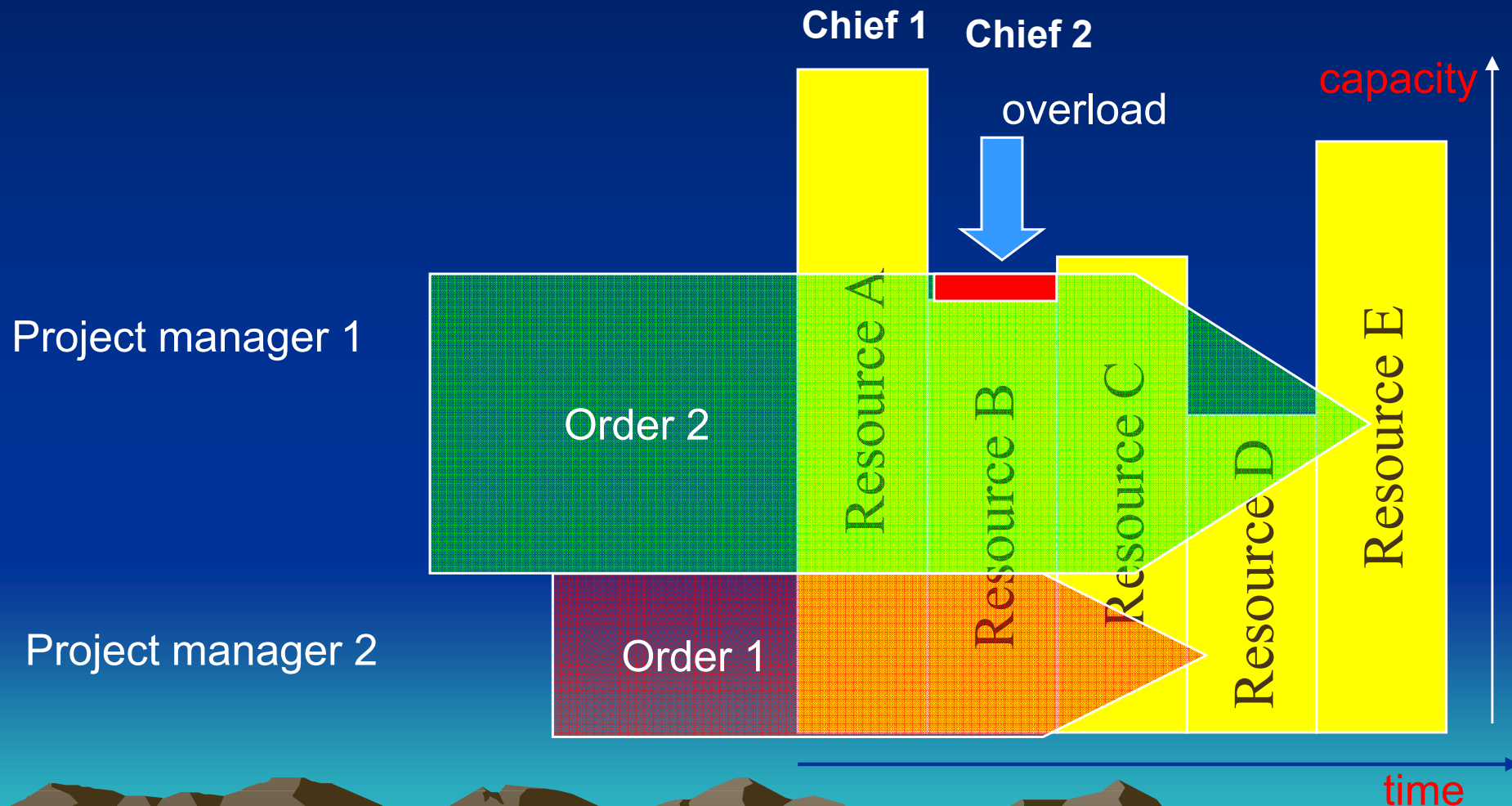

# Partial time of any activity in the project

Variability of the real time assigned to activity

**Probability– median an element of statistical file,**  
which is after sorting in the middle .Median of the set (1,5,2,2,1) is 2



*100 „5-minutes meeting happened.  
How many times it took 5 minutes only ?*

**Colleague ask for a quick rendez-vous: „Do not worry, it will take maximum 5 minutes!“.**  
***How long it takes on average?***

# Project environment is very complicated because of integration linkages and their dependencies

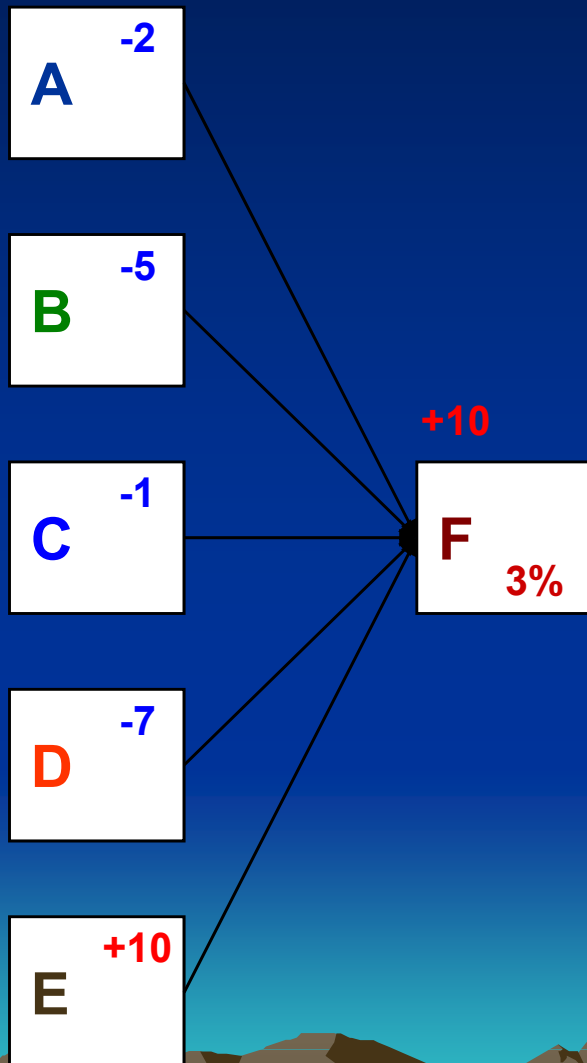

Probability of finishing tasks A to E in time is 50%. ( $50 \times 50 \times \dots \times 50 = 3,125\%$ )

What is a probability, that task F will start in time ?

How the timely finishing of the tasks A,B,C and D will influence the integration point ?

- a) saving are fully wasted
- b) delay in one task will be immediately transferred to the next project task (activity)

Project environment is very complicated because of integration linkages and their dependencies

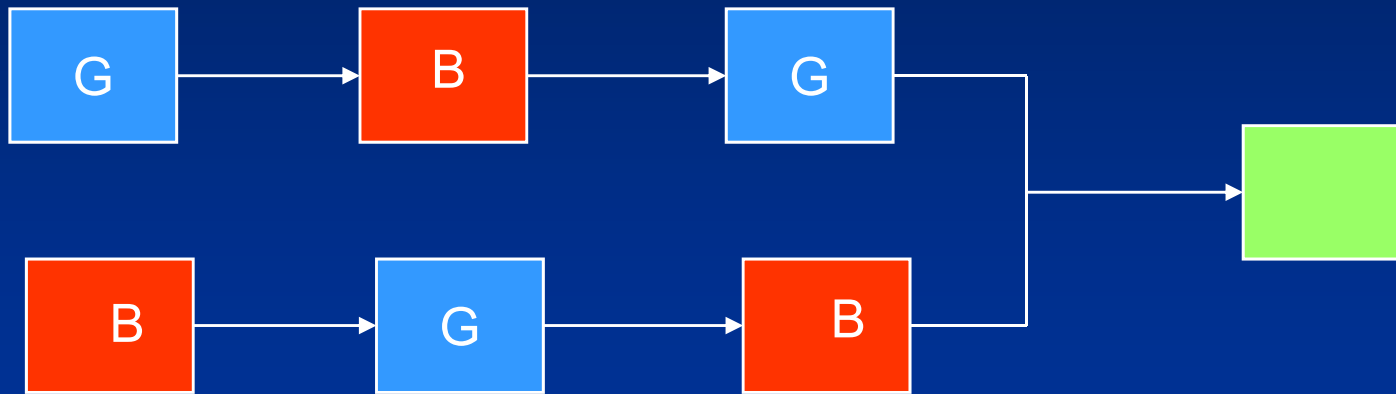

In order to start **B** in the upper branch, you have to finish **G** and also **B** in the lower branch. The probability, that **B** start in time is 50 % worse, than it was shown on the previous slide.

# The project must be protected against influences of breakdowns (troubles)

Standard estimation with protecting buffers for every activity

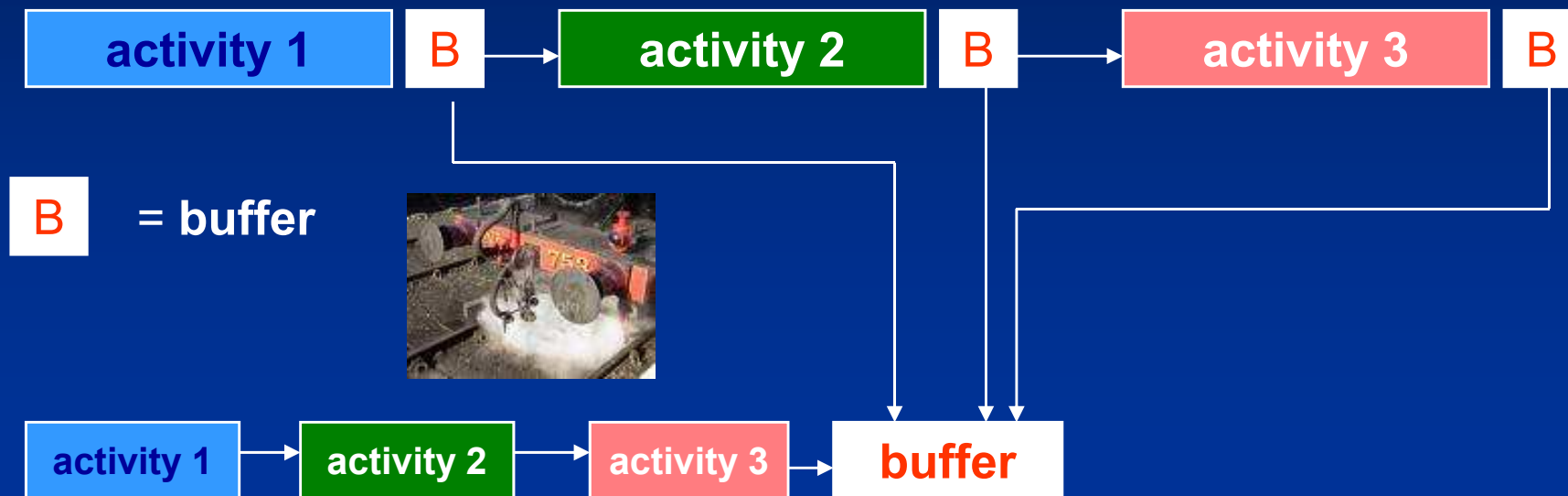

**1st step** : every activity is shorten to 50 % of its original time size.

**2nd step** : **critical path buffer** at the end of the project will have size of 50 % of the total sum of saved time created by shortening all partial activities



# Critical path, adjoining branches of the project and adjoining buffers (AB)

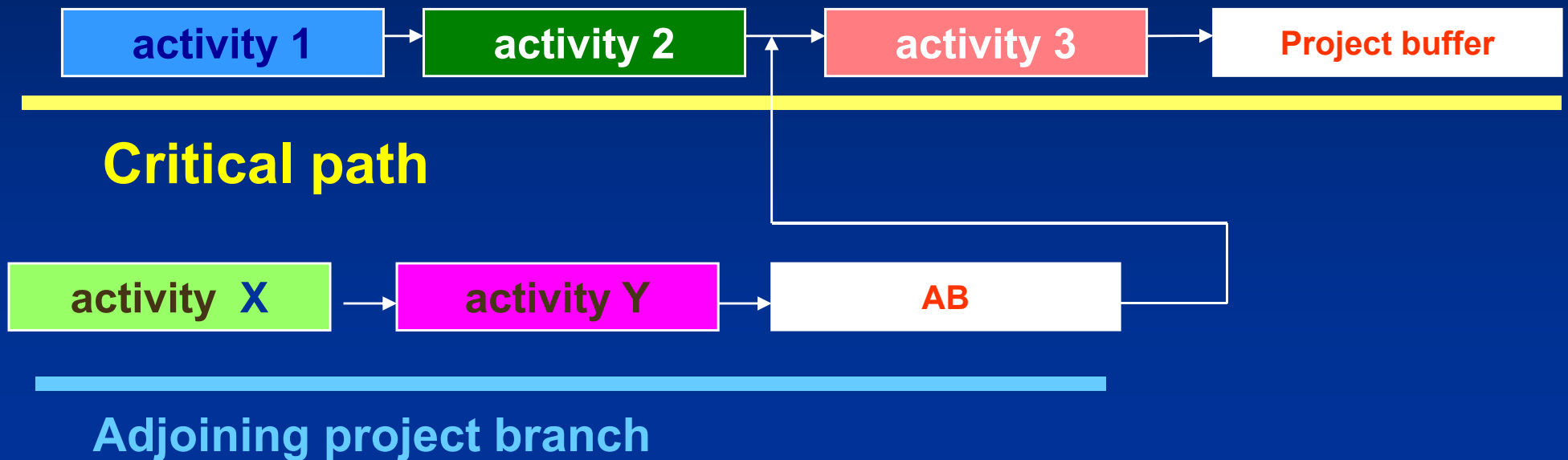

Buffer serves as a safety tool to accumulate reasons of expected and unexpected delays

# Critical Path (CP)

- Critical path is defined as the longest way (meaning time) from the starting point of the project graph to the ending point.

- Every project has at least one critical path

## **The rules of CP:**

- Every delayed task on CP will quintessentially delay the whole project
- Truncation of duration of any task on CP will shorten whole project



# Critical Path (CP)

- **Critical Path Method**, abbreviated **CPM**, or **Critical Path Analysis**, is a mathematically based algorithm for scheduling a set of project activities. It is an important tool for effective project management.

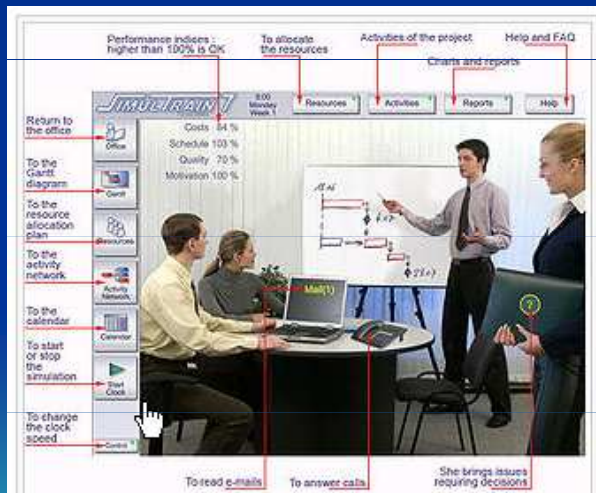

# Critical Path (CP)

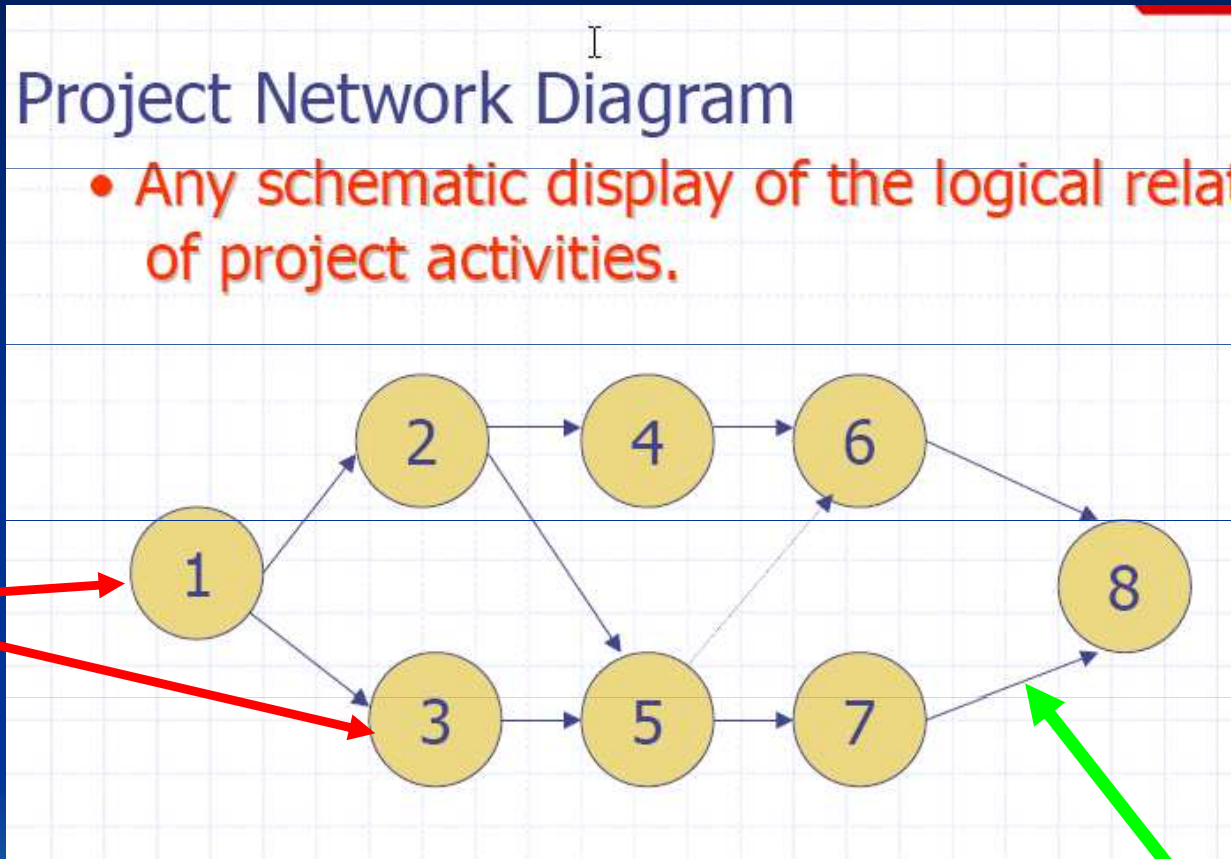

Milestones

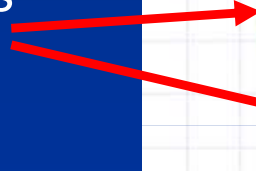

Activity

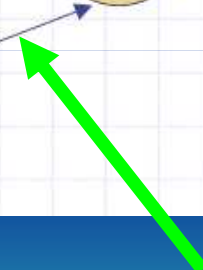

# Critical Path (CP)

## Building a diagram 1

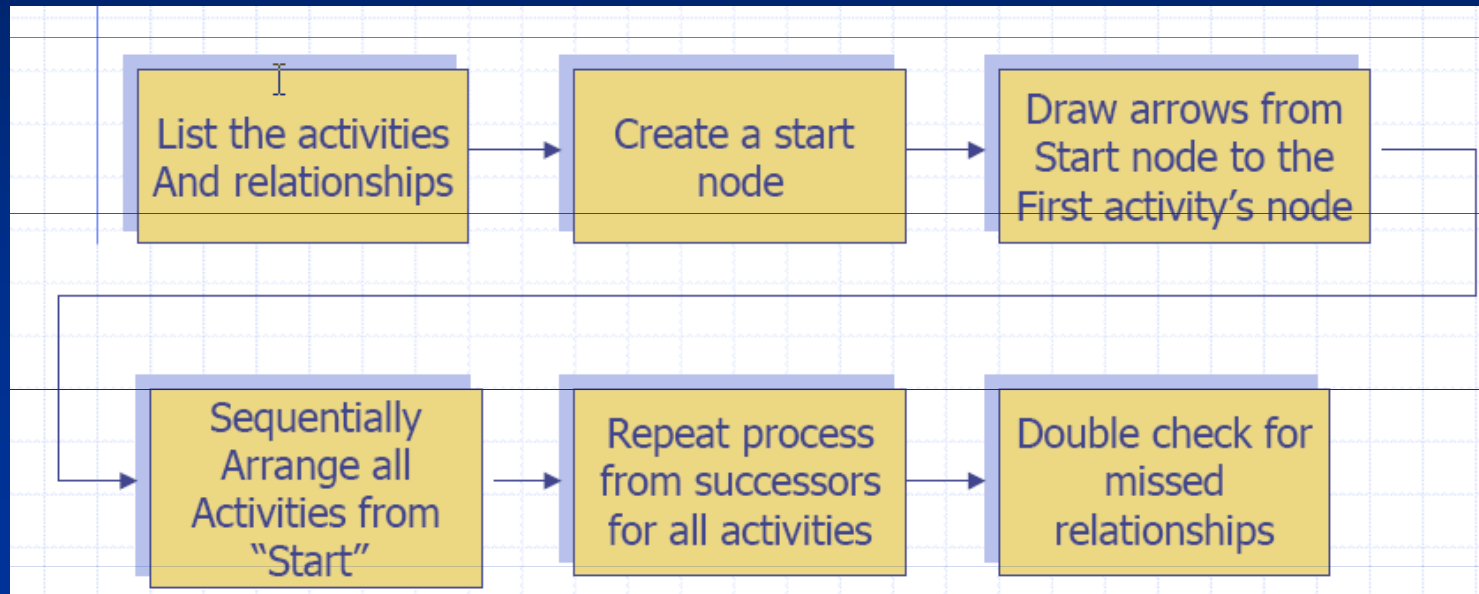

# Critical Path (CP)

Building a diagram 2

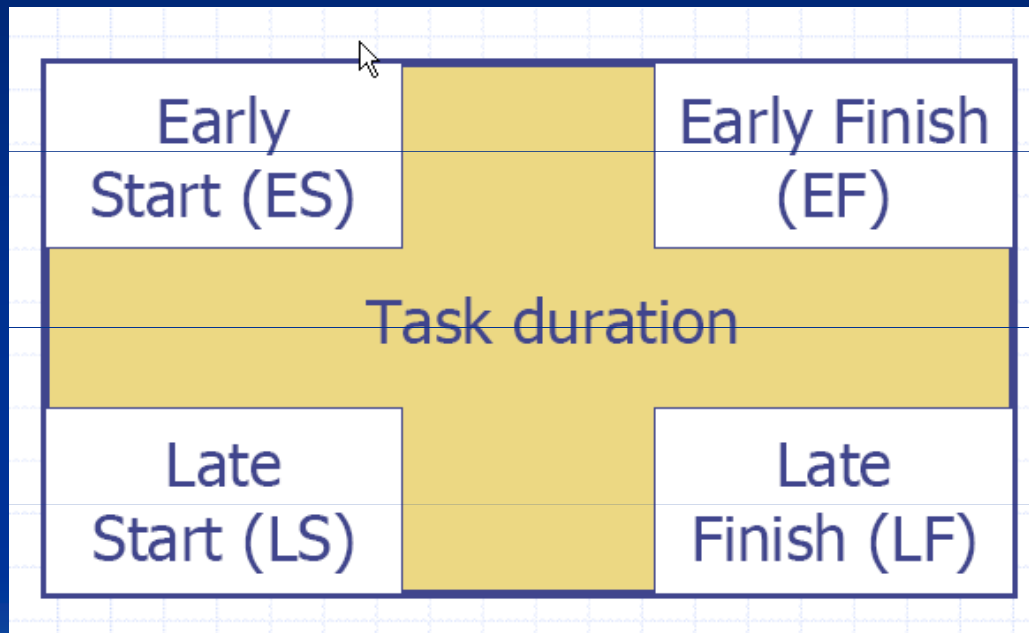

# Critical Path (CP)

Building a diagram 3

<i>Task ID</i>	<i>Duration</i>	<i>Dependency</i>
A	7	
B	3	
C	6	A
D	3	B
E	3	D,F
F	2	B
G	3	C
H	2	E,G

# Critical Path (CP)

Building a diagram 4 – calculating the **FORWARD PASS**

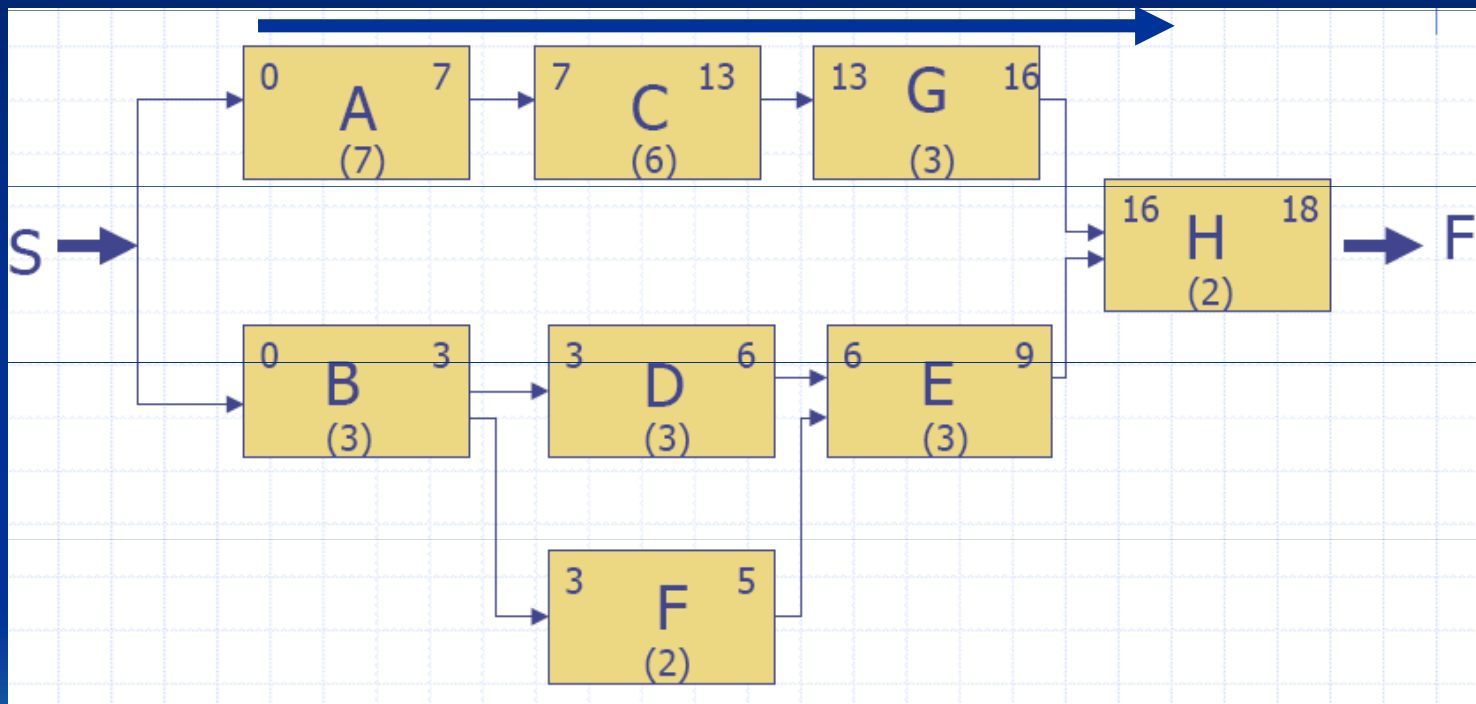

Early Start and finish dates are calculated by means of **Forward Pass**



# Critical Path (CP)

Building a diagram 5 – calculating the **BACKWARD PASS**

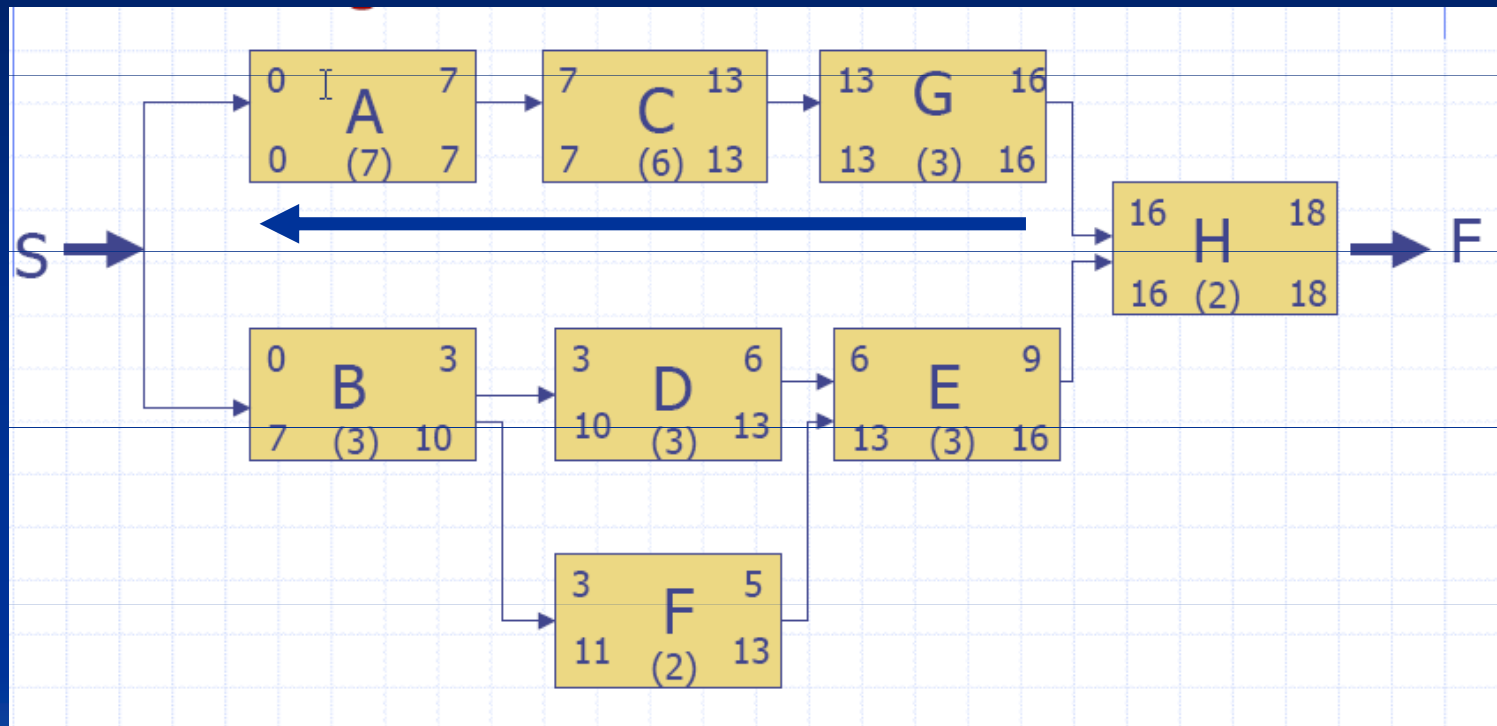

Late Start and Late Finish dates are calculated by means of **Backward Pass**

# Critical Path (CP)

Building a diagram 6 – calculating the **FLOAT(SLACK)/CP**

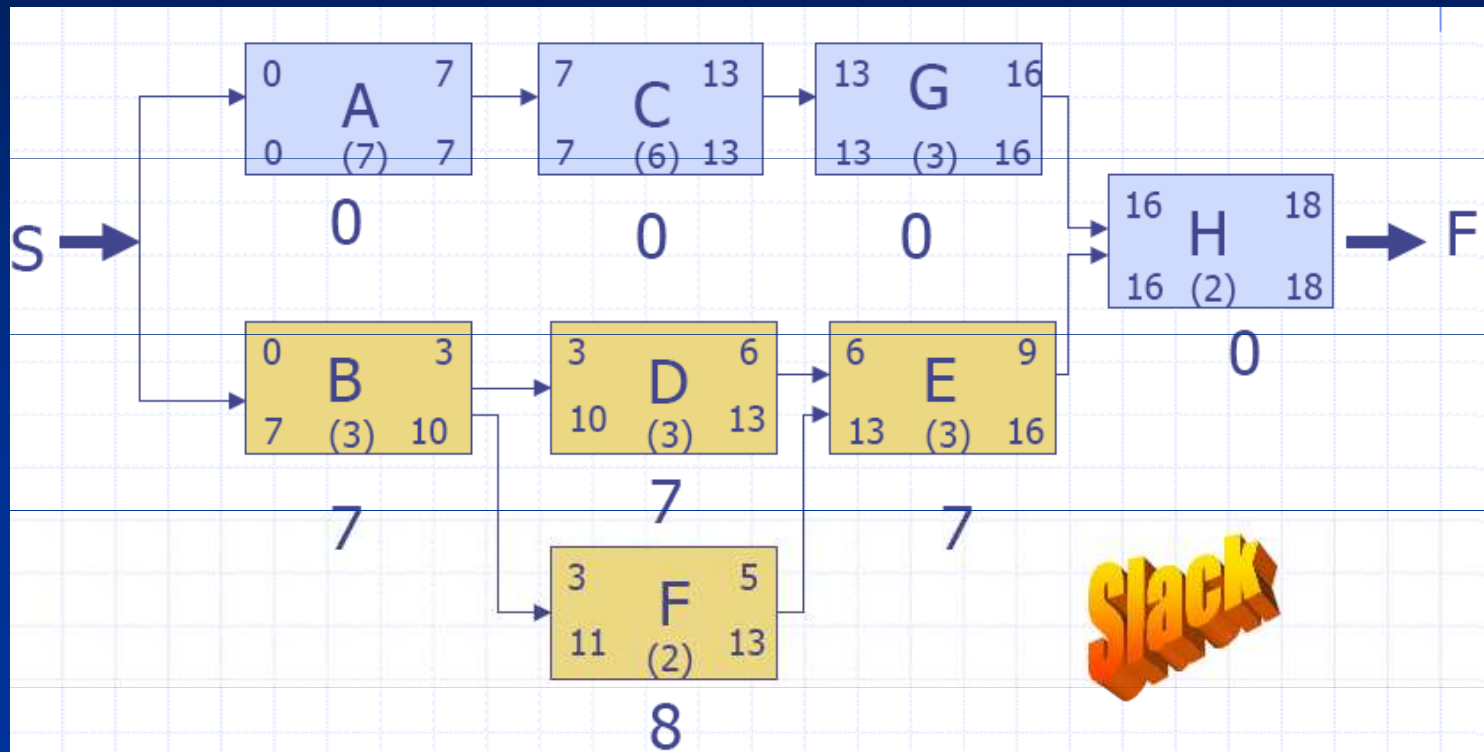

**Free Float:** Amount of time a single task can be delayed without delaying the early start of any successor task =  $LS-ES$  or  $LF-EF$

# Critical Path (CP)

CPM is helpful in :

- Project Planning and control.
- Time-cost trade-offs.
- Cost-benefit analysis.
- Reducing risk.



# Critical Path (CP)

## Limitation of CPM :

- Does not consider resource dependencies.
- Less efficient use of buffer time.
- Less focus on non critical tasks that can cause risk.
- Based on only deterministic task duration.
- Critical Path can change during execution.





# Multitasking characterization

- people always overestimate the length of their tasks
- salesman offers impracticable terms (dates)
- The fight for reserves (capacities) causes, that all saved time is fully wasted (Student's syndrome)
- Reserves (if any) are used badly
- Bad use of reserves causes lack of transparent assignment
- Non transparent priorities are parents of bad multitasking
- Bad multitasking causes longer duration of all activities (tasks) and thus all the projects



# CP definition (more in detail)

Critical path is defined as the longest way (meaning time) from the starting point of the project graph to the ending point

Critical path represents technological dependencies and given times of every task on Critical path inclusive of necessary condition for fulfilment of foregoing tasks (activities) framed by integration points.



# Critical chain definition

In TOC the **Critical chain** is defined as the longest way (meaning time) from the starting point of the project graph (Gantt) to the ending point which takes into account **technological dependencies** as well as time of the tasks and moreover, **capacities of assigned resources**.

With infinite capacities of resources you can consider Critical path=**Critical chain**





# Multi-project management and critical resources (CCR) used in more than one project branch

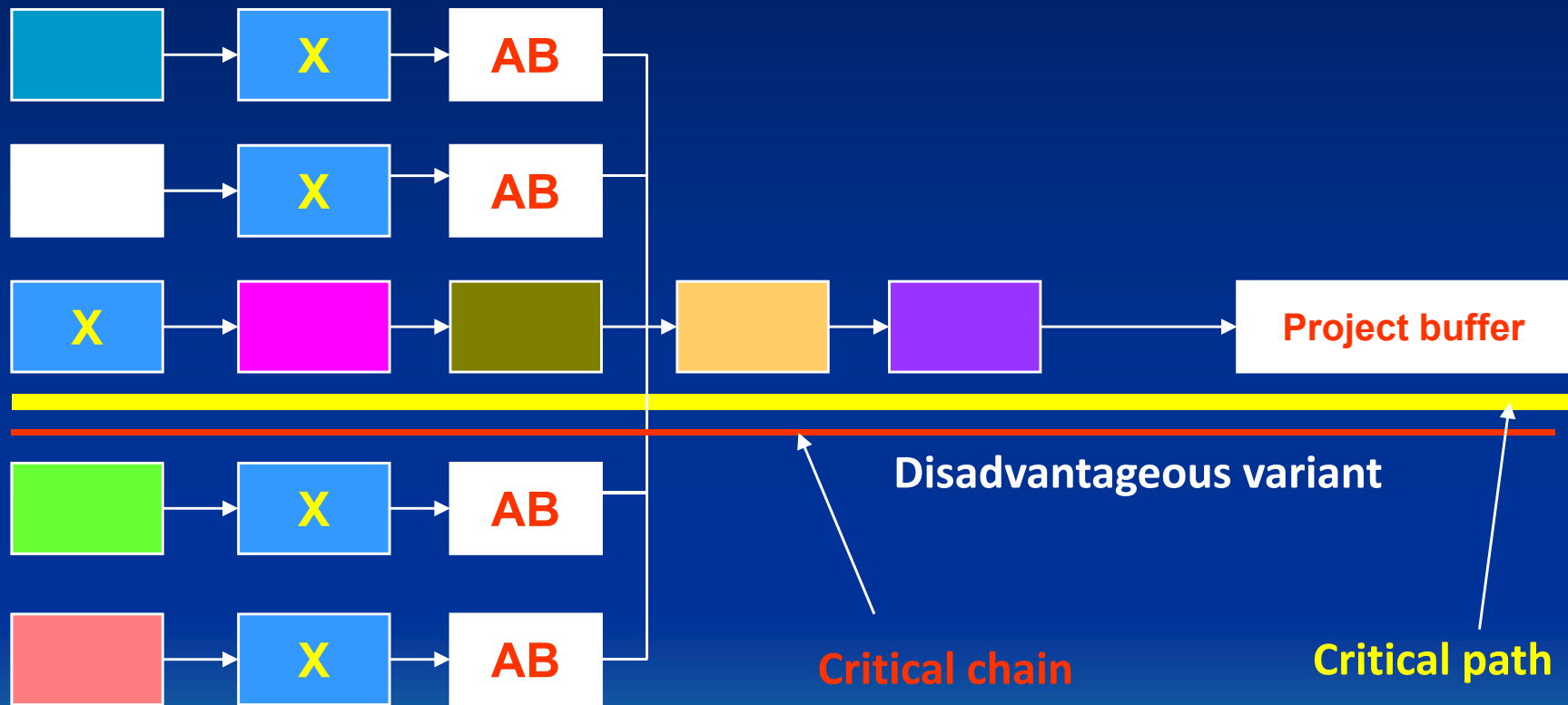

CCR = Capacity Constrained Resource = X

# Multi-project management and critical resources (CCR) used in more than one project branch

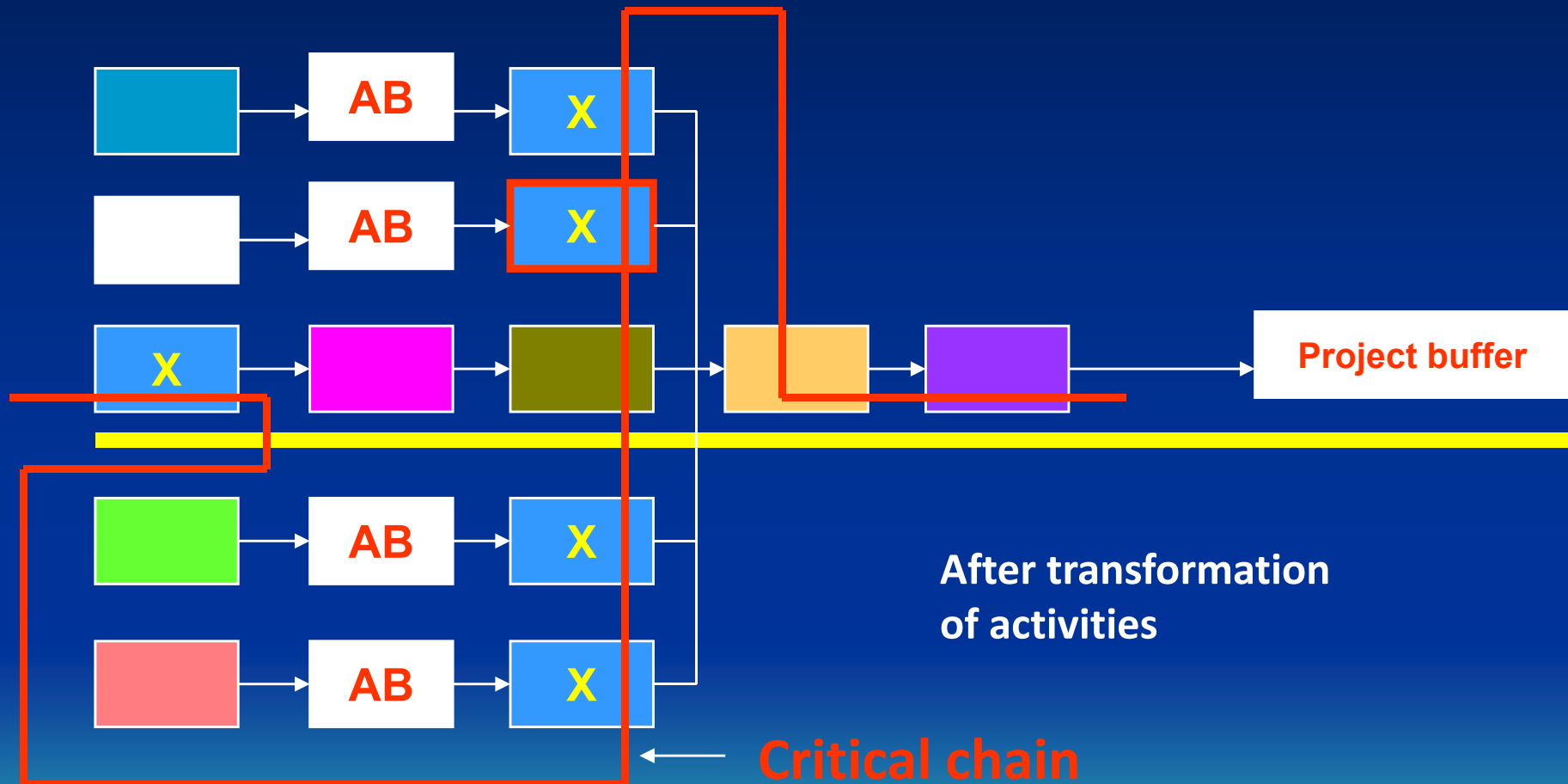

# Project management based on remaining time in buffers – **Buffer Management**

- Buffers are used for timely warning and that is to say predicting and avoiding future problems related to project deadlines (milestones)
- It is also used as a guideline for corrective actions



# Basic metrics showing the project status

- The partial size of Critical chain (CC) fulfilled in days (in %)
- How much of buffer size was used to fulfil above mentioned partial size of CC ?
- Trend of project (buffer consumption graph- [see next slide](#))
- Consumption of the financial buffer
- Priorities – bigger buffer penetration- bigger priority
- Adjoining branches have always lower priorities
- It is not allowed to create bad multitasking



# Trends of the project

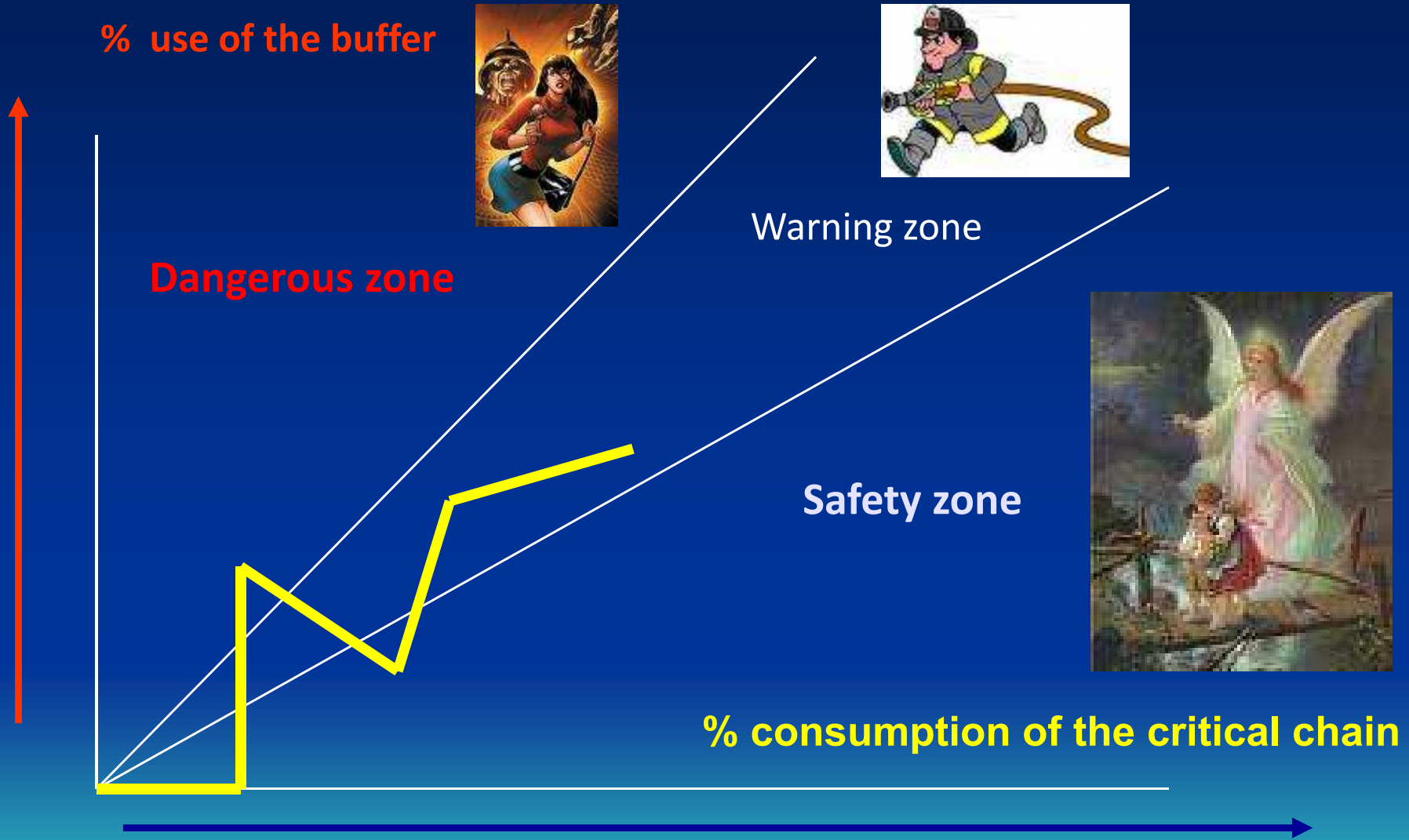

# Project Quick, resources A-E and activities X,Z,X,W, and V

Resource and activity	Median of the required time
A-Y	<b>10 days</b>

Activity=Task

You can say, that 50 % of any activities finish earlier, and other **50 %** will be delayed, meaning, that **10 days** represents **50 %** of the estimated time for chosen activity

Project managers decided, that activity ends if **90 %** of estimated time will be consumed. It means, that they add a time buffer of **8 days** (for the safety reasons).  $10\text{ d} = 50\%$ ,  $20\text{ d} = 100\%$ ,  $2\text{ d} = 10\%$ ,  $20\text{ d} - 2\text{ d} = 18\text{ d}$ ,  $18\text{ d} - 10\text{ d} = 8\text{ d}$



**5 x 10 days = 50 days**

# Time distribution

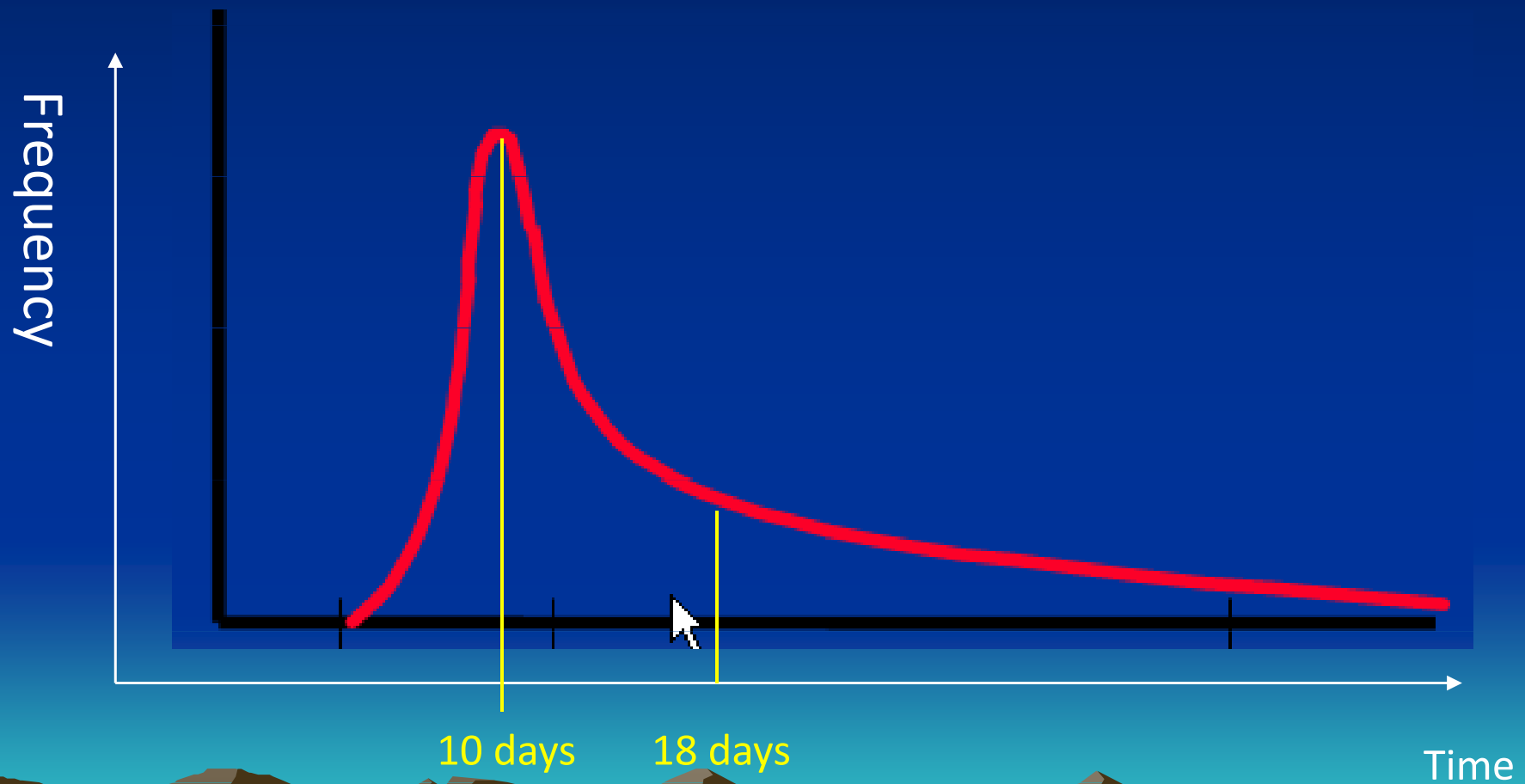

# Five projects and modifications

- If we consider for every activity time buffer 8 days we will get :



5 x 10 days = 50 days

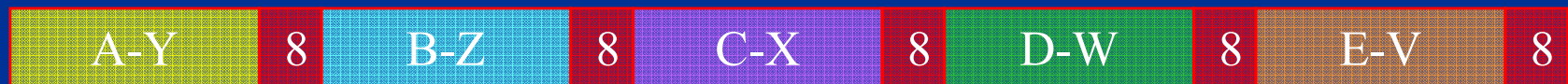

5 x 18 days = 90 days



# Five projects and modifications (added buffers) and four types of troubles

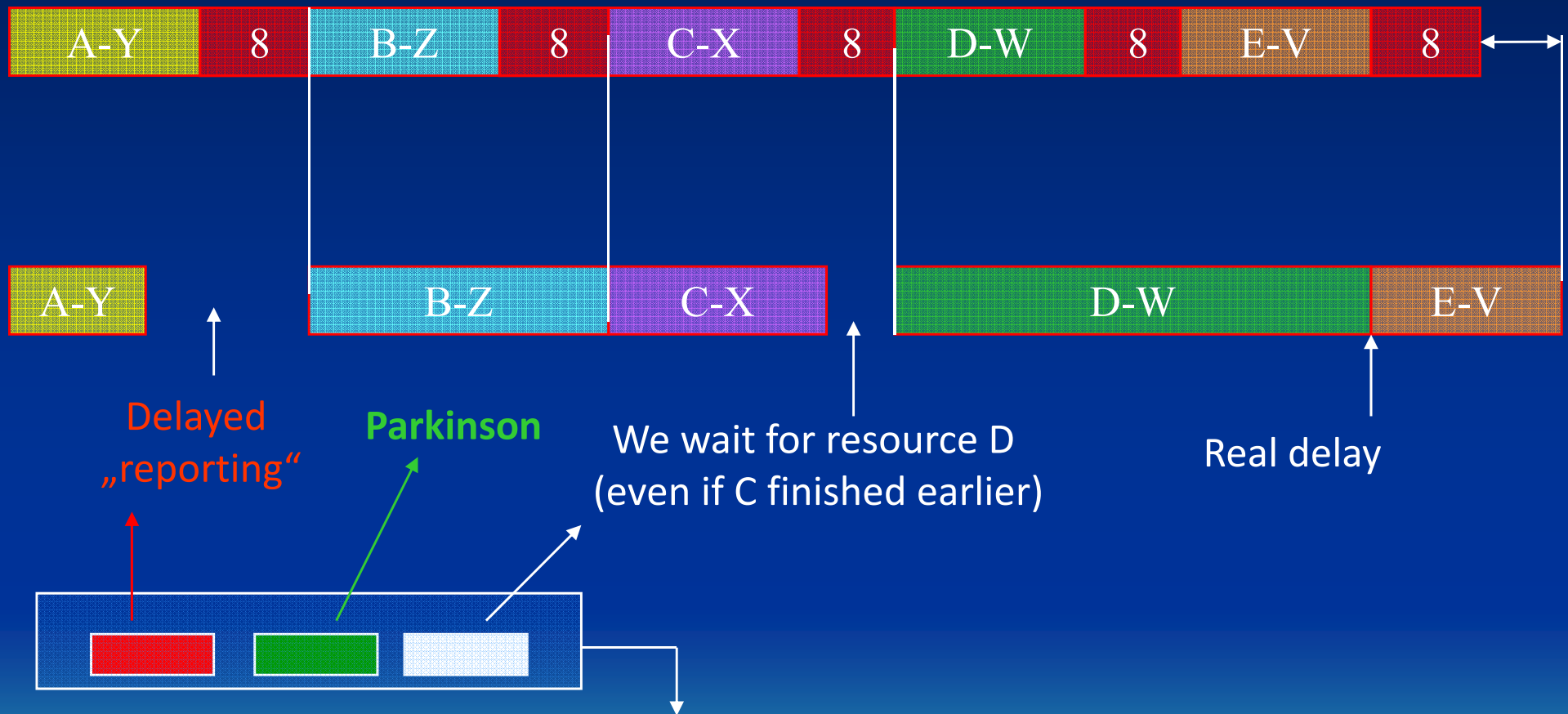

No one trouble causes project delay taking into consideration planned delivery date (agreed date of the project).

Dissipation of acquired time reserves was caused by company strategy saying strictly stick to the planned project schedule (example of rigid management)

# Five projects after modification (buffers united to one and placed to the end of the project)

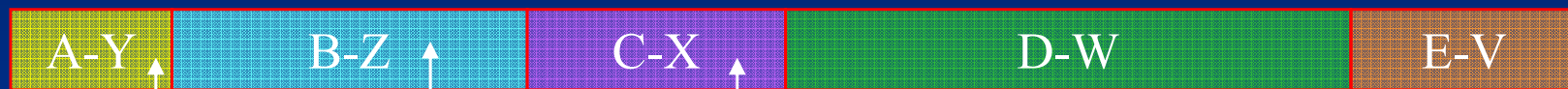

Parkinson

Little bit longer than 20 days median but shorter than 18 days

Earlier end of activity A



= CPB = current project buffer = 40 days



= new buffer = 50 % out of CPB, which makes CPB/2

# Critical path- Critical chain

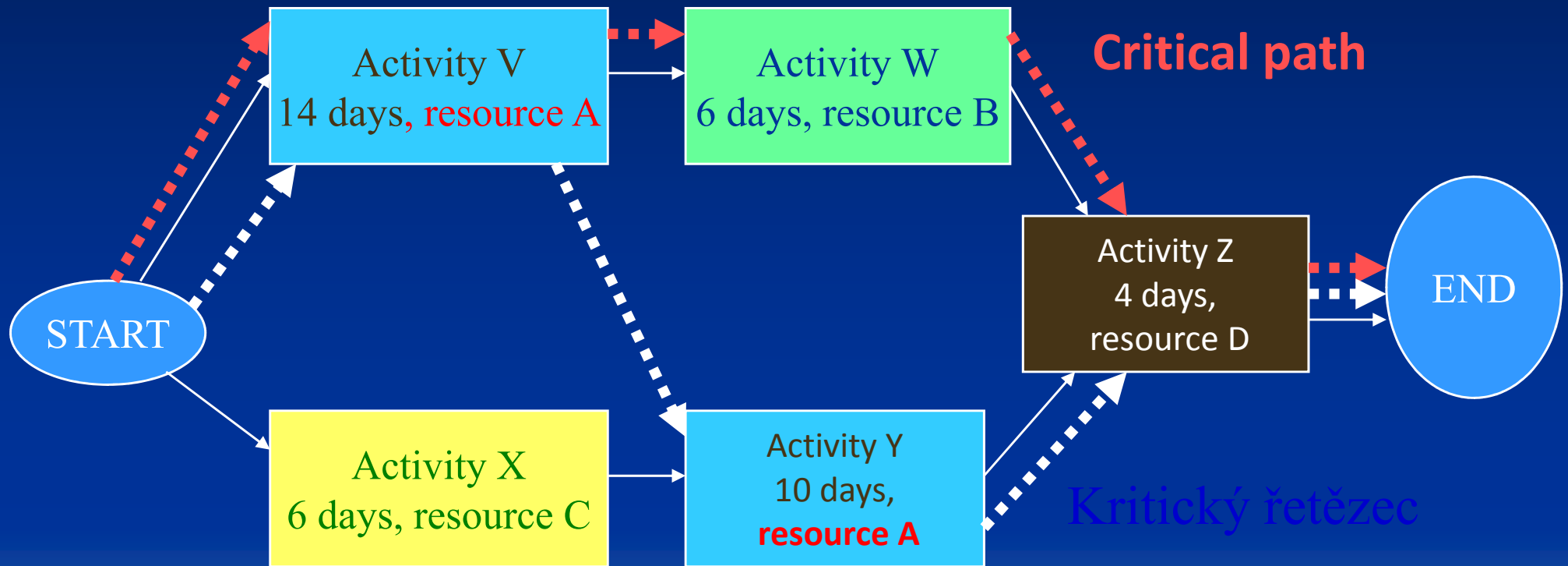

# Gantt graph for X,Z,V,W a Z

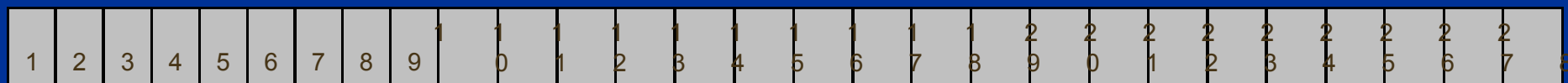
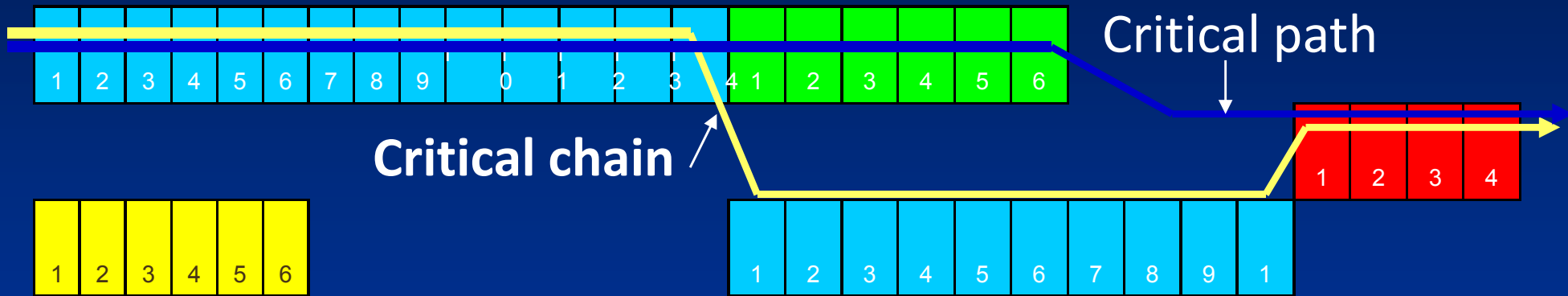

Project is considered as successful if is finished in expected time and financial budget is not exceeded



# Critical chain with buffers

Length of the Critical chain:

$$7+5+2+7=21$$

and originally it was all in all 20 days

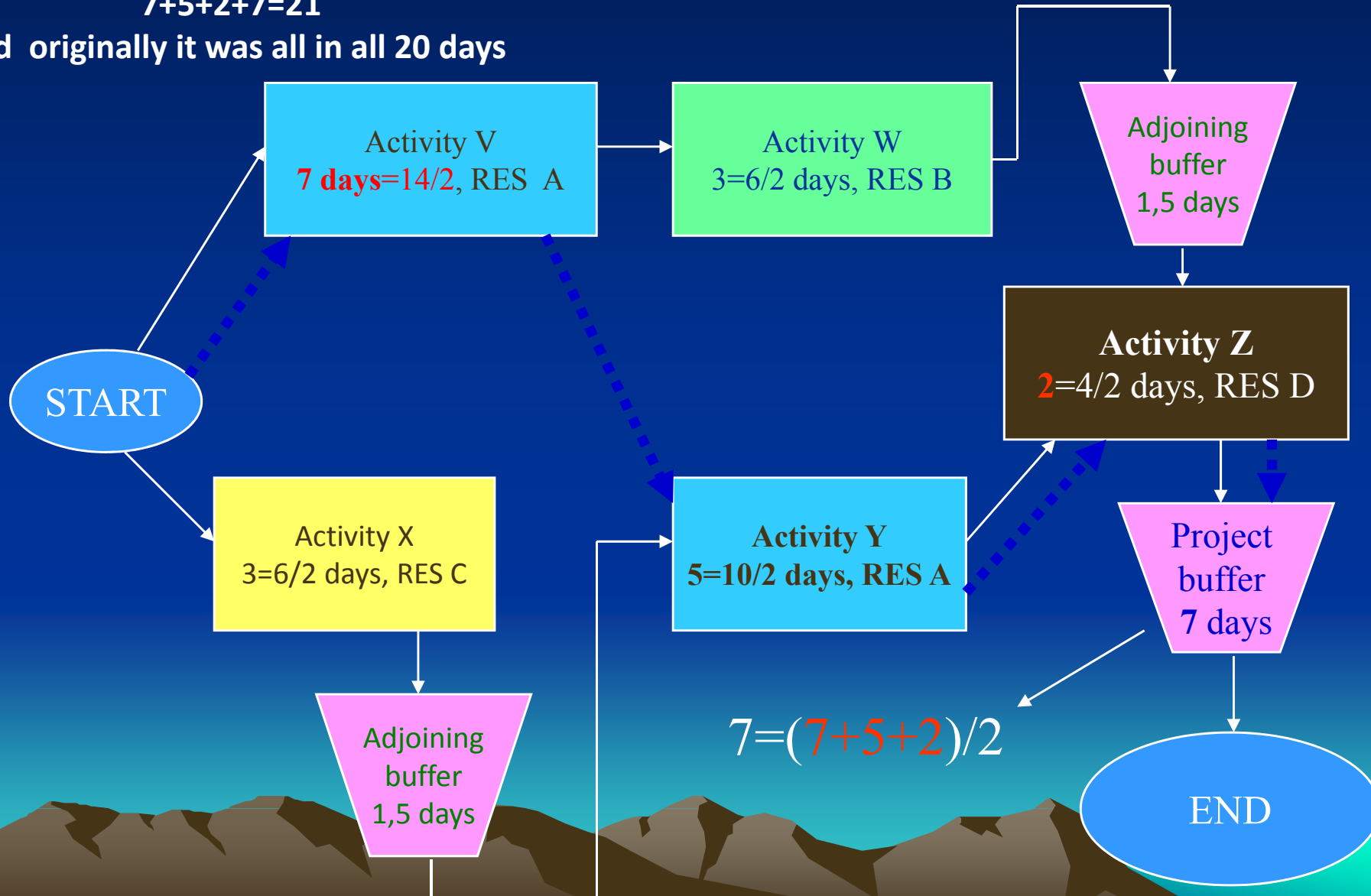

# Multitasking – sequential order of resources

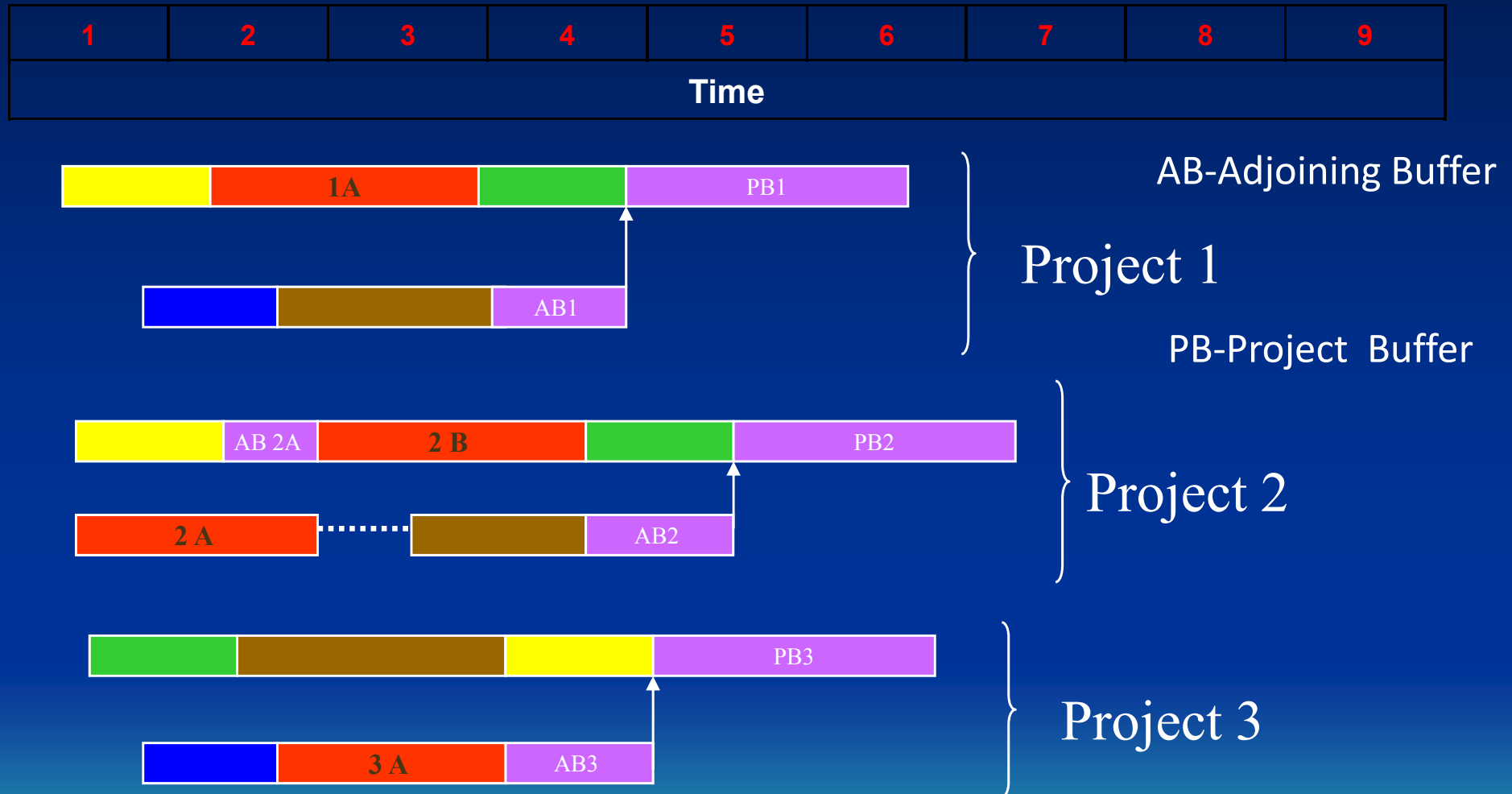

Framed by those three projects we could see collision in utilization of some resources. **GREEN RESOURCE** at the end of projects P1 and P2 and the same by **YELLOW RESOURCE** at the beginning of P1 and P2. In the adjoining branches we could see collision due to the bad resources allocation in P1 and P3 and in all three projects we have collision of BROWN and **RED RESOURCES**.

**This is caused by matrix organisation scheme of the company**

# Matrix scheme

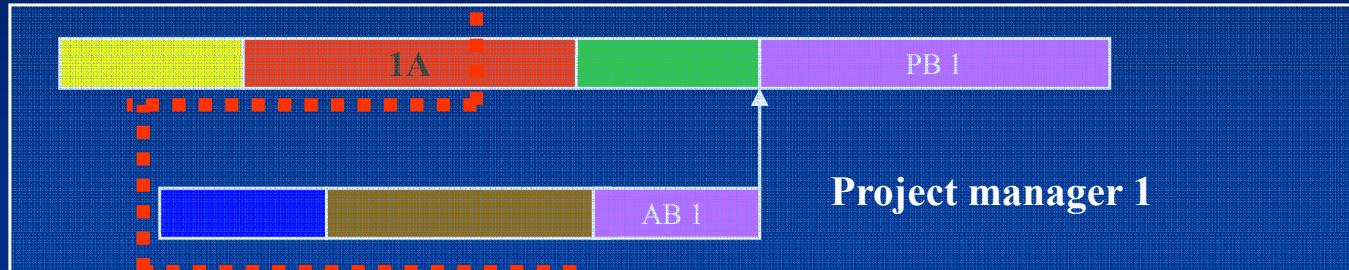
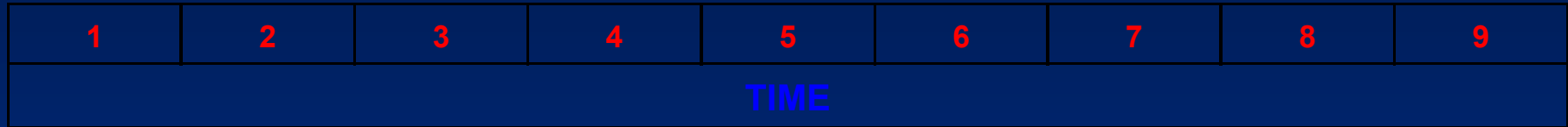

} Project 1

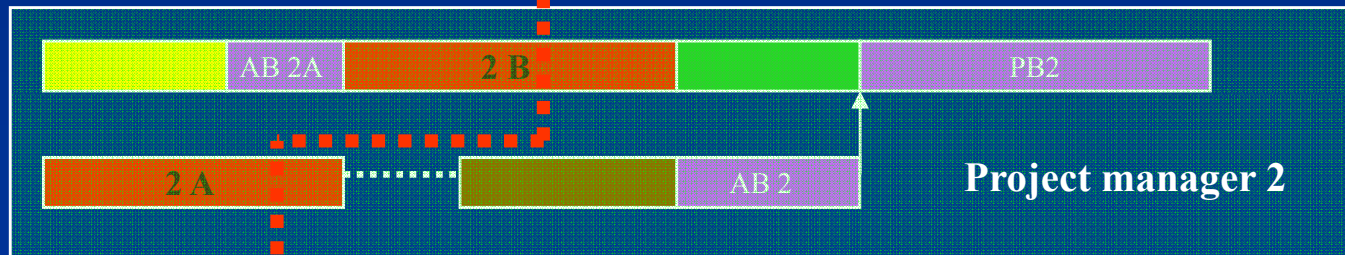

} Project 2

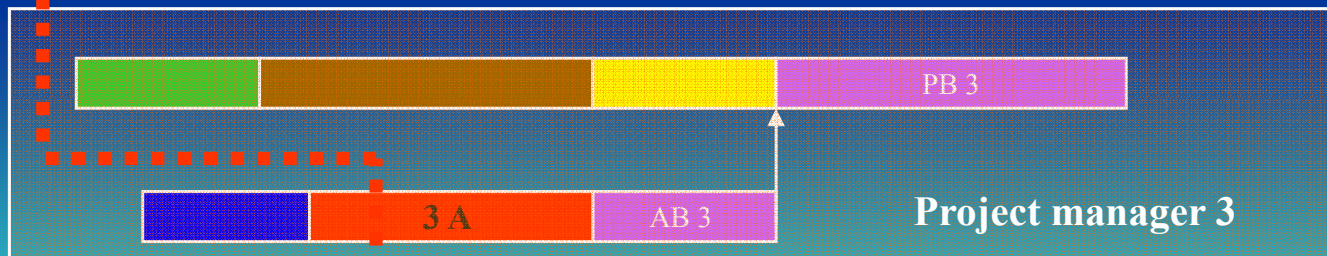

} Project 3

**Manager commanding RED RESOURCE**

# Collisions among project and department

managers ( $M_i$ ) (those who control resources)

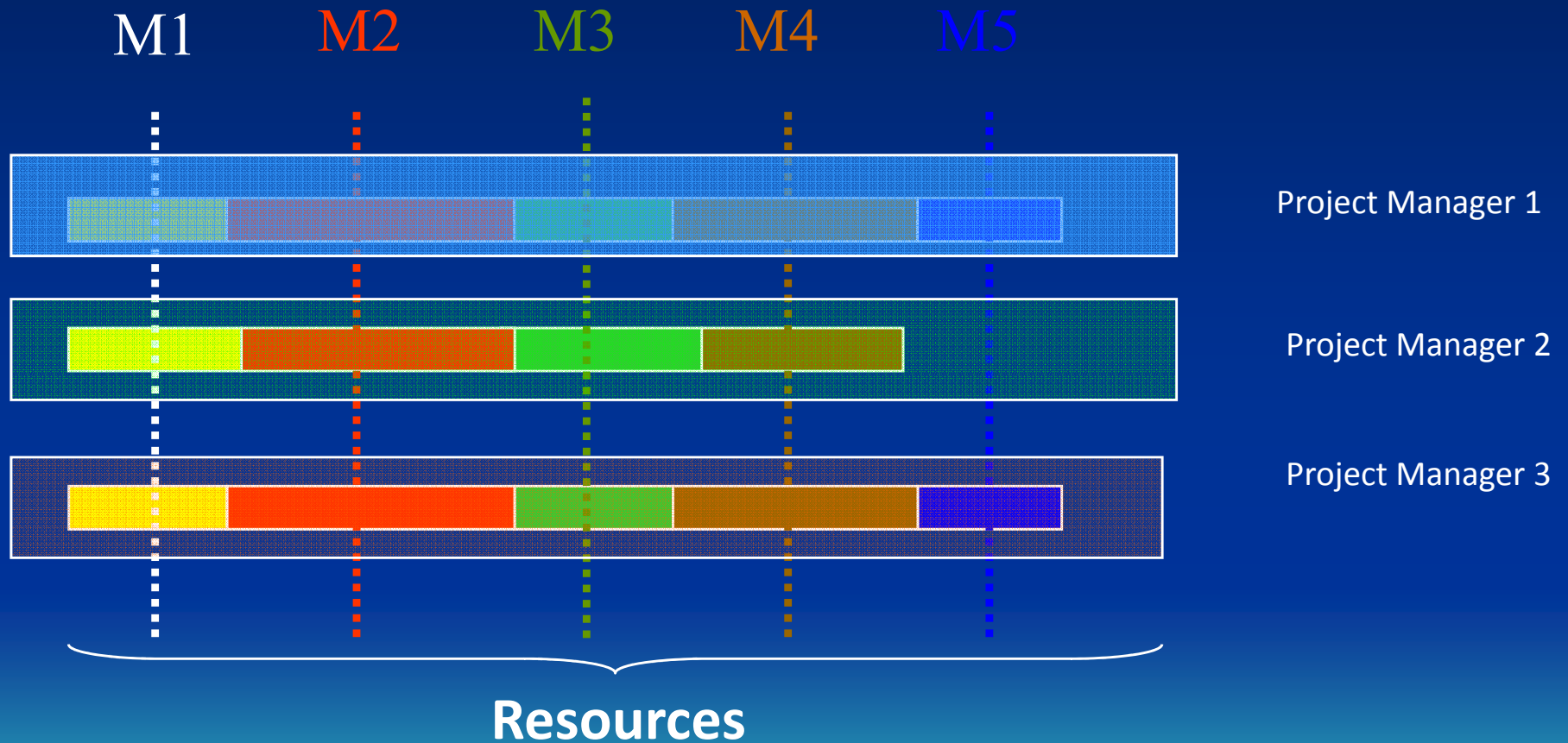

PM always persuade Department managers to assign their resources to their project and department managers want have all projects finished as soon as possible with maximum parallel processing possible



# Collisions among project and department

managers (Mi) (those who control resources)

- The synchronization of the starts of the projects is based on most utilized (overloaded resource which is the cause of prevailing quantity of conflicts
- The above mention statement means, that all your started projects are covered by all most critical resources (CCR) of the organization and due to this fact you will have less started projects.
- Less started projects results in less quantity of conflicts among project managers and department managers



# Multitasking – modified schedule-stage 1

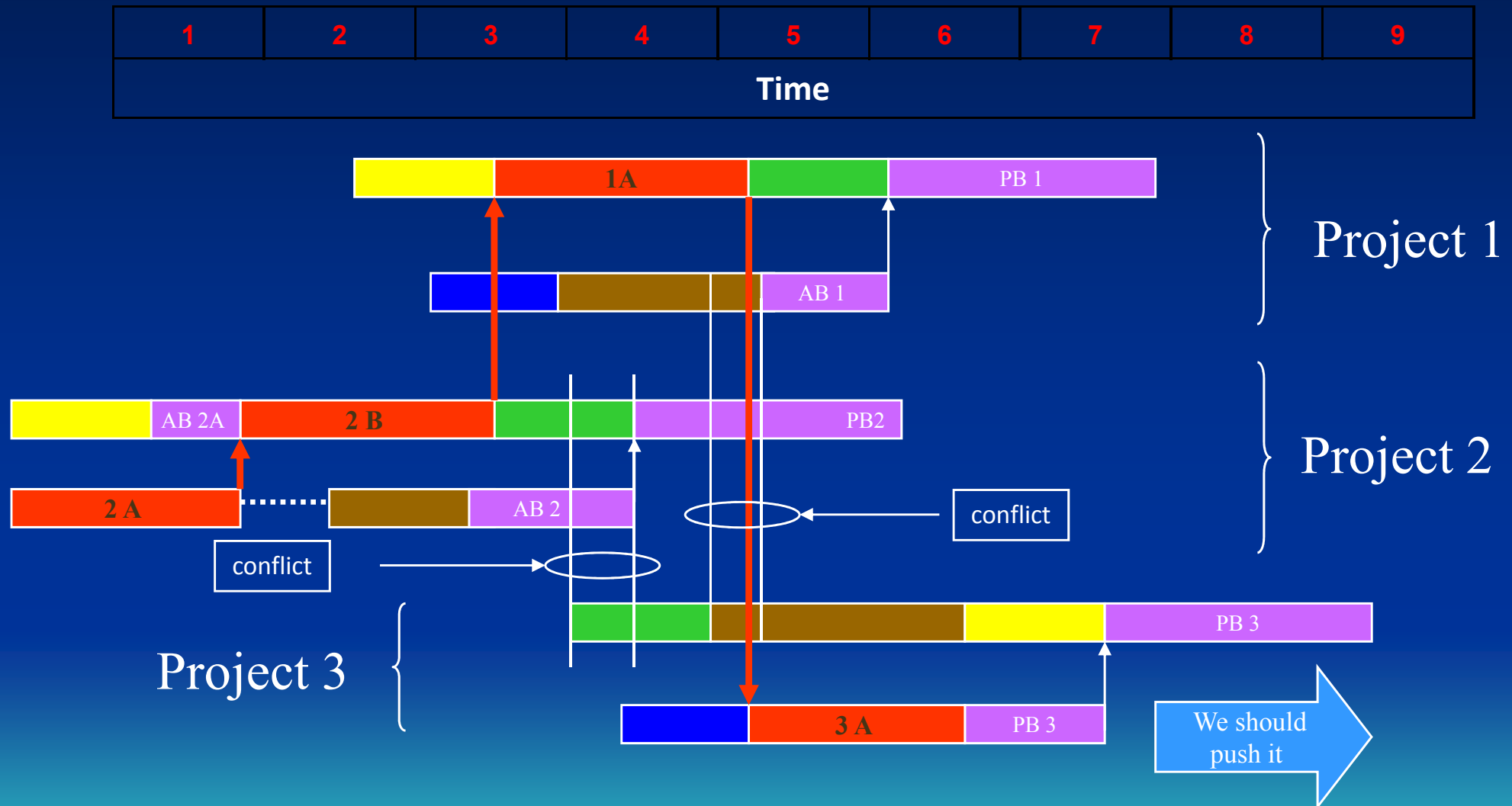

We have to protect critical (DRUM) resource – in our case **RED RESOURCE**. At the first sight it looks like all the scheduled projects will last longer. On the other hand, these reshuffling will result in higher probability, that they end in planned time and that is the reason of less conflicts among PM and DM.

# Collisions among project and department

managers (Mi) (those who control resources)

- To all three projects we have inserted buffers protecting the critical chain
- On the other hand, after reshuffling of the schedule in order to decrease quantity of conflicts we did nothing to protect critical resource (drum, CCR)
- Above mentioned statement is the reason to insert additional protecting buffer before drum resource (Drum-Feeding Buffer) = DFB DFB 1



See next slide

# Multitasking – modified schedule-stage 2

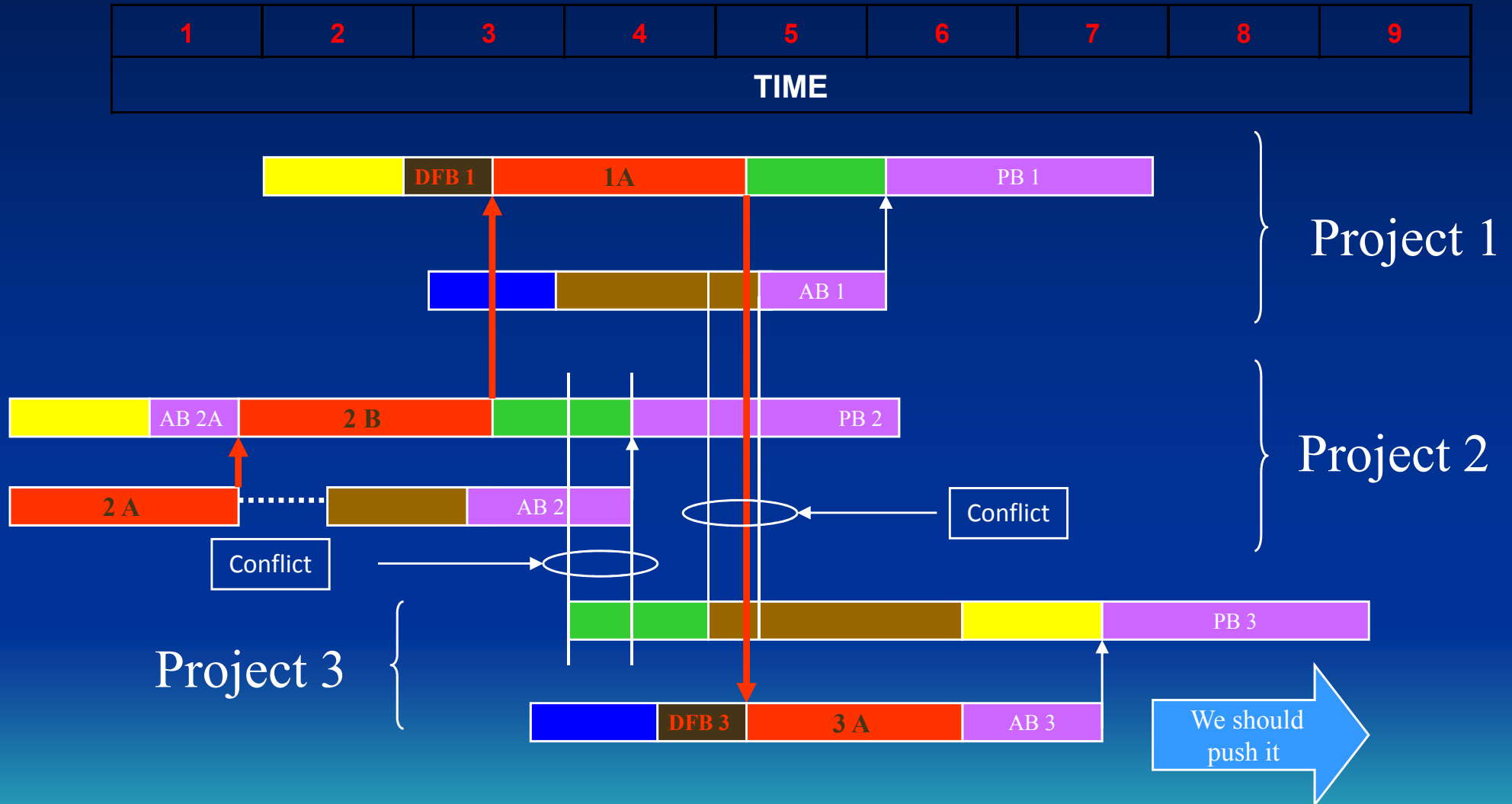

We have to protect critical (DRUM) resource – in our case **RED RESOURCE**. At the first sight it looks like all the scheduled projects will last longer. On the other hand, these reshuffling will result in higher probability, that they end in planned time and that is the reason of less conflicts among PM and DM.

# Buffer consumption - variant A

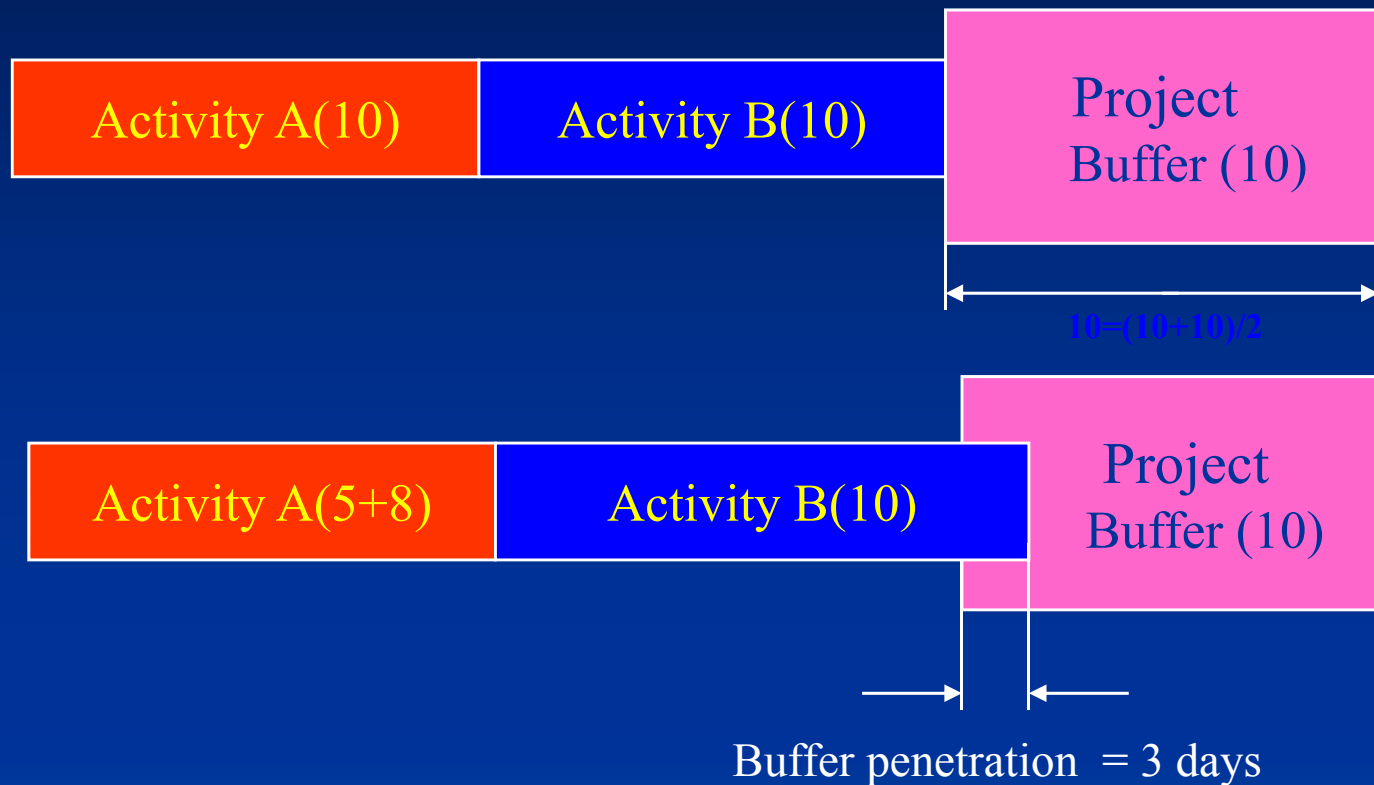

**Rate of penetration** is used to assign priorities to the partial activities



# Priorities assigned to resources

- If one resource have to be assigned to two activities starting in the same moment so the first activity which will start is the one belonging to the project with bigger project buffer penetration
- If none of all project buffers were penetrated with previous activities, so the first starts this activity which belongs to the critical chain. 

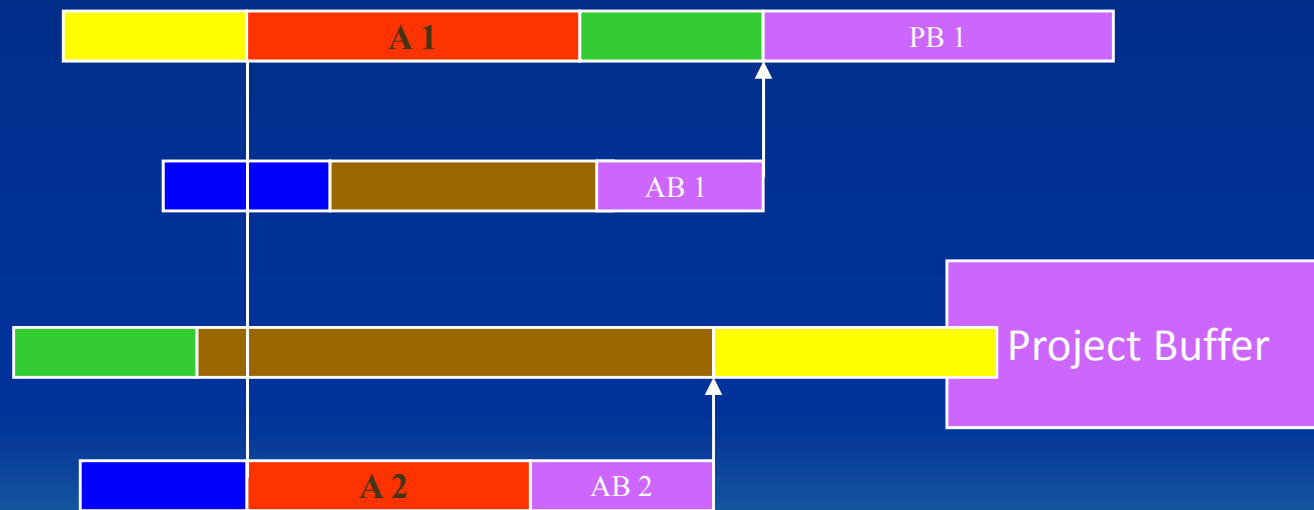

A2 starts first because PB 2 is partially consumed (penetrated)

# Priorities assigned to resources

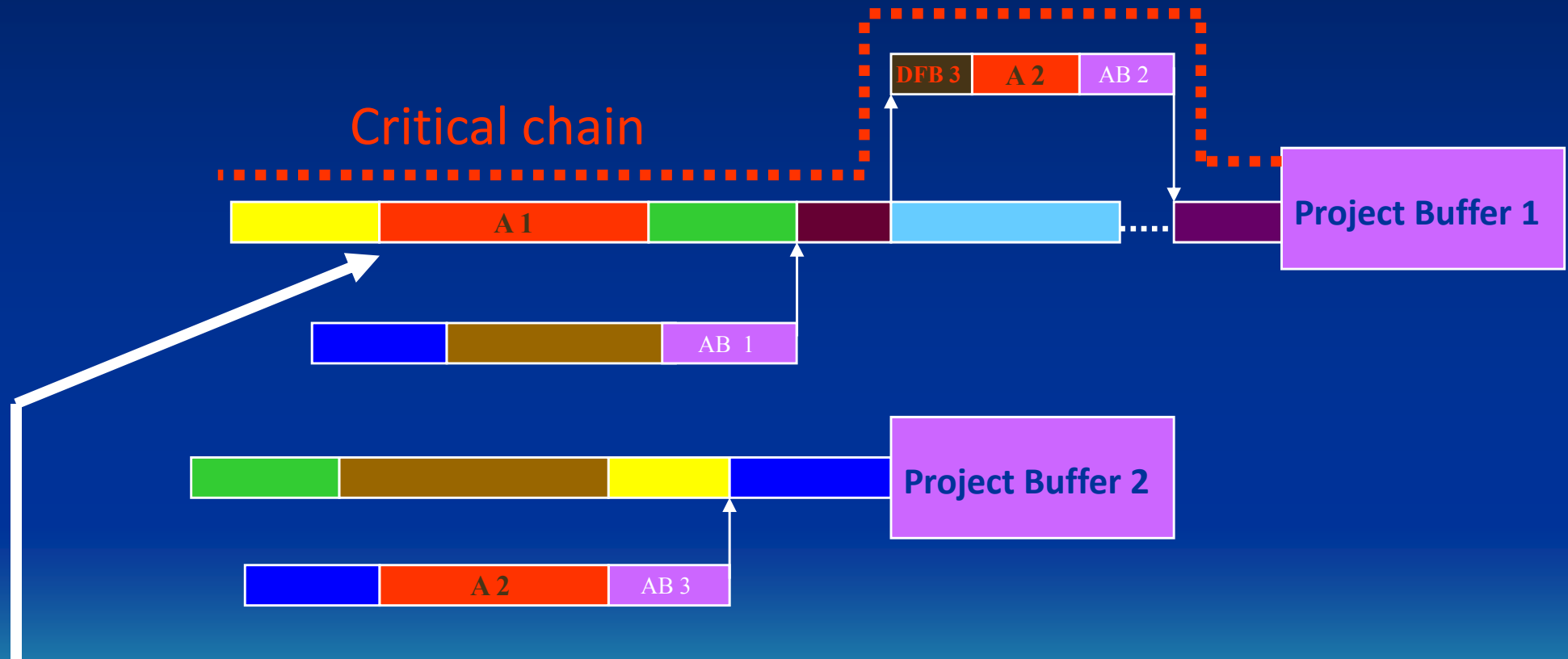

This activity starts first because it is a part of the Critical chain

# Main benefits of the Critical Chain (CC) usage

- Every single project ends significantly earlier, than projects where other project management methods than CC were applied
- Total time needed to end more project than one is markedly shorter
- Promised delivery times are fulfilled with higher rate of credibility
- You will have more free capacity of all used resources



# Main benefits of the Critical Chain (CC) usage

- Better initial estimation about project timing and thus bore accurate planning
- During starting of the projects you did not meet any problem taking into consideration drum resource
- Decrease of unfavourable effects such as Student syndrome, Murphy attacks and impacts of Parkinson's laws by redeployment and integration of all buffers to one and only one project buffer at the end of the project
- Utilization of benefits caused by earlier ended activities
- Use of reporting system which provides you with valuable information of buffer penetration, the extent of time reserves and thus better helping system for assigning priorities

