

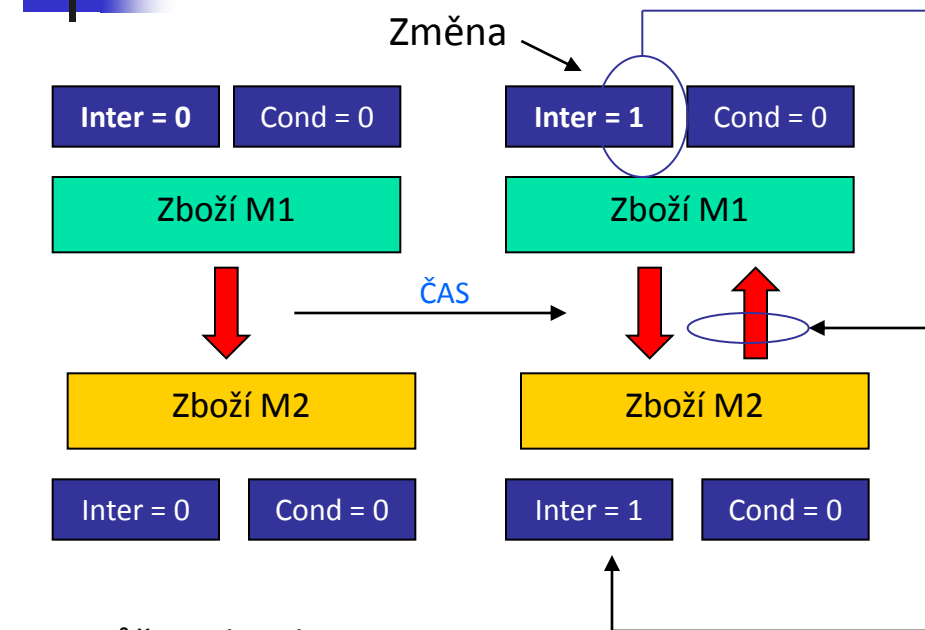

Doplnění kurzu TRADE

Skorkovský
KPH ESF MU
2012

Náhrady



M2 může nahradit M1
M1 **nemůže** nahradit M2

M2 může nahradit M1
M1 může nahradit M2

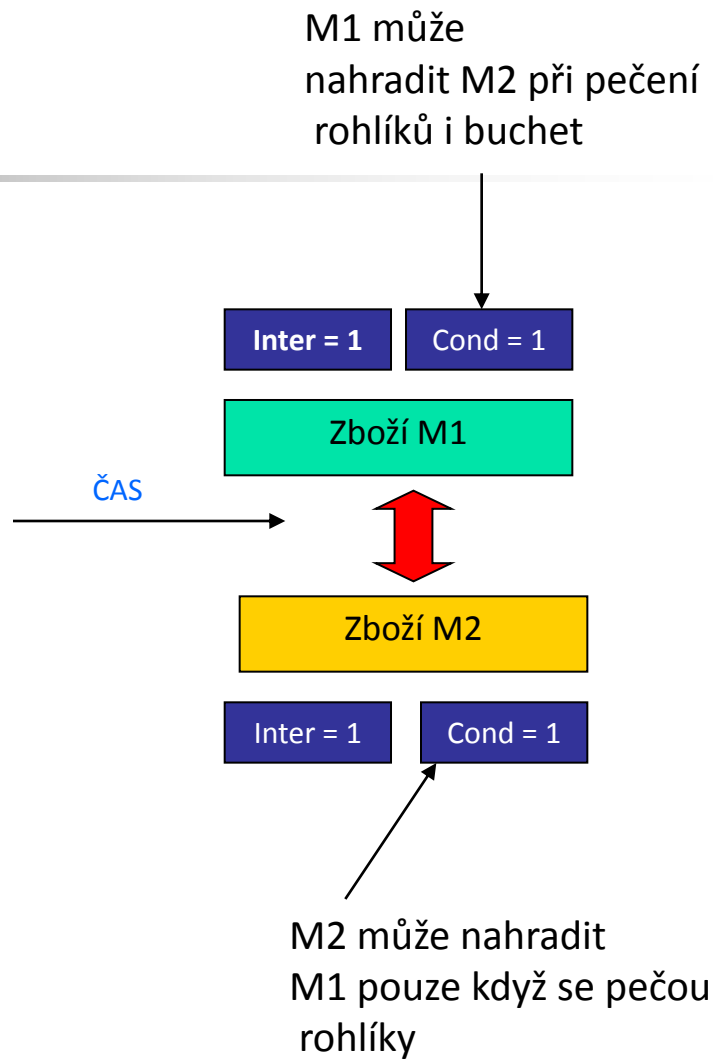

Náhrady

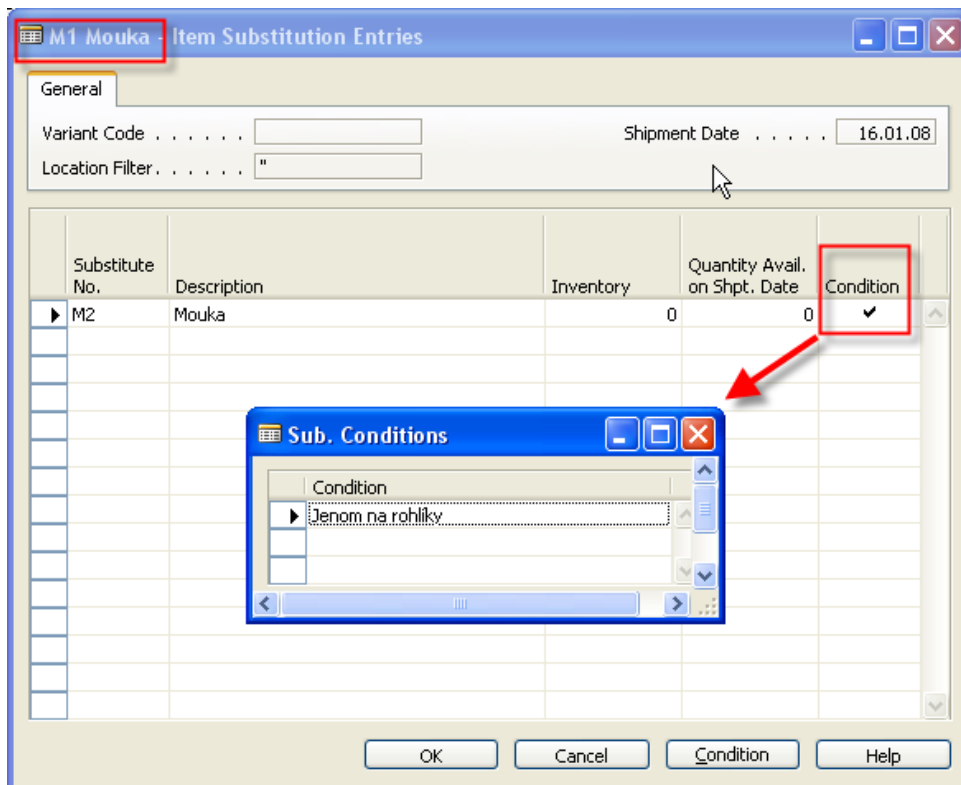

Křížové reference (odkazy)

M1 Mouka - Item Card

General Invoicing Replenishment Planning Foreign Trade Item Tracking E - Commerce Warehouse

No. M1 Search Description . . . MOUKA

Description Mouka Inventory. 270

Base Unit of Measure . . . KG Qty. on Purch. Order . . . 0

Bill of Materials Qty. on Prod. Order . . . 0

Shelf No. B1-T Qty. on Component Lines . . . 0

Automatic Ext. Texts . . . Qty. on Sales Order . . . 0

Created From Nonstoc... Qty. on Service Order . . . 0

Item Category Code. . . Service Item Group . . .

Product Group Code. . . Blocked

Last Date Modified . . . 27.11.08

Item Sales Purchases Functions Help

General Invoicing Replenishment Planning

Replenishment System. . . Purchase

Purchase

Vendor No. 50000

Vendor Item No. M1_DOD_5000

Purch. Unit of Measure . . . KG

Lead Time Calculation . . .

M1 Mouka - Item Cross Reference Entries

Cross-Reference Type	Cross-Reference Type No.	Cross-Reference No.	Variant Code	Unit of Measure	Description	Discontinue Bar Code
Vendor	60000	M1-DOD_2008		KG	Mouka na pečení rohlíků	

Křížové reference (odkazy)

General Invoicing Shipping Foreign Trade E - Commerce Prepayment

No. 106046 ...

Buy-from Vendor No. 60000 ↑

Buy-from Contact No. CT000139 ↑

Buy-from Vendor Name Grassblue Ltd.

Buy-from Address 8 One Way

Buy-from Address 2

Buy-from Post Code/City N12 5XY ↑ London ↑

Buy-from Contact

No. of Archived Versions. 0

Posting Date 26.11.08

Order Date 26.11.08

Document Date 26.11.08

Quote No.

Vendor Order No.

Vendor Shipment No.

Vendor Invoice No.

Order Address Code. ↑

Purchaser Code RL ↑

Campaign No. ↑

Responsibility Center LONDON ↑

Status Open

Vendor Information

Buy-from Vendor

- Order Addresses (0)
- Contacts (1)
- Purchase History

Pay-to Vendor



Item Information

- Item Card
- Availability (270)

T..	No.	Cross-Reference No.	Description	Location ...	Quantity	Reserve...	Unit of M...	Direct U..
▶ I...	M1	M1-DOD_2008	Mouka na pečení rohlíčů	BLUE	100		↓	10,(

Buď zadám přímo Křížový odkaz (nutno zobrazit) a dostanu i moje číslo zboží nebo naopak (do kříže)

Křížové reference (odkazy)

General Invoicing Shipping Foreign Trade E - Commerce Prepayment

No. 1017

Sell-to Customer No. 01121212

Sell-to Contact No. CT000006

Sell-to Customer Name Spotsmeyer's Furnishings

Sell-to Address 612 South Sunset Drive

Sell-to Address 2

Sell-to Post Code/City US-FL 37125 Miami

Sell-to Contact Mr. Mike Nash

No. of Archived Versions. 0

Posting Date 26.11.08

Order Date 26.11.08

Document Date 26.11.08

Requested Delivery Date

Promised Delivery Date

Quote No.

External Document No.

Salesperson Code JR

Campaign No.

Responsibility Center

Status Open

T..	No.	Cross-Reference No.	Substitut... Available	Description	Quantity	Location Code	Unit of Measure Code	Qty. to Ship
▶ I...	M1	M1-CUST 011	✓	Flour for croissant		YELLOW	KG	

Cross-Reference No.	Cross-Refer... Type	Cross-R... Type	Item No.	Variant Code	Unit of Measure	Discontinue Bar Code	Description
▶ M1-CUST_011212	Customer	01121212	M1		KG		Flour for croissant
M1-DOD_2008	Vendor	60000	M1		KG		Mouka na pečení rohlíků
BAR_M1_60000	Bar Code	60000	M1		KG	✓	Mouka na pečení rohlíků
BAR_M1_60000-NEW	Bar Code	60000	M1		KG		Mouka na pečení rohlíků

Křížové reference (odkazy)

Cross-Reference No.	Cross-Refer... Type	Cross-R... Type	Item No.	Variant Code	Unit of Measure	Discontinue Bar Code	Description
M1-CUST_011212	Customer	01121212	M1		KG		Flour for croissant
M1-DOD_2008	Vendor	60000	M1		KG		Mouka na pečení rohlíčů
BAR_M1_60000	Bar Code	60000	M1		KG	✓	Mouka na pečení rohlíčů
BAR_M1_60000-NEW	Bar Code	60000	M1		KG		Mouka na pečení rohlíčů

The **bar code** can still be used as a secondary identification, for example, if you still have inventory with the old bar code.

However, you will not be able to use the old cross-reference number in the program once you have discontinued the bar code.

Skladová jednotka

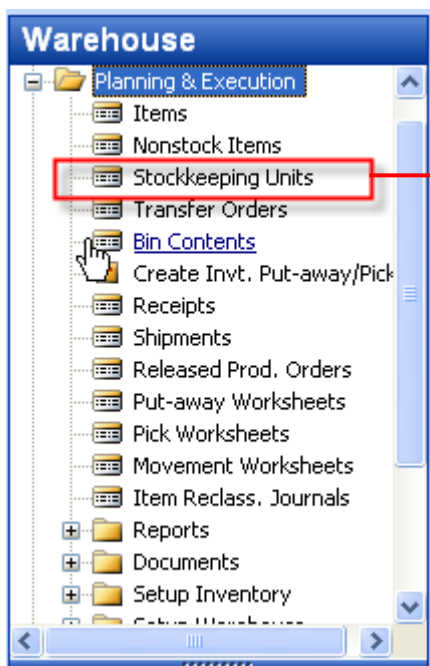

General Invoicing Replenishment Planning Warehouse

Item No.	70001	Inventory.	2 310
Description	Base	Qty. on Purch. Order . .	0
Location Code.	BLUE	Qty. on Prod. Order . .	0
Variant Code		Qty. in Transit	0
Bill of Materials	<input type="checkbox"/>	Qty. on Component Lines	0
Shelf No.	A2	Qty. on Sales Order . .	0
		Qty. on Service Order . .	0
		Last Date Modified . . .	

Skladová jednotka

Zboží 70001
centrální
sklad



Skladová jednotka (ENG description)

You use the Stockkeeping Unit table to record information about your stockkeeping units.

Stockkeeping units do not replace item cards, but they are related to them. Stockkeeping units allow you to differentiate information about an item for a specific location (such as a warehouse or distribution centre) or a specific variant (such as different shelf numbers and different replenishment information), for the same item.

It is important to note that the information on the Stockkeeping Unit card has priority over the Item card.

Skladová jednotka

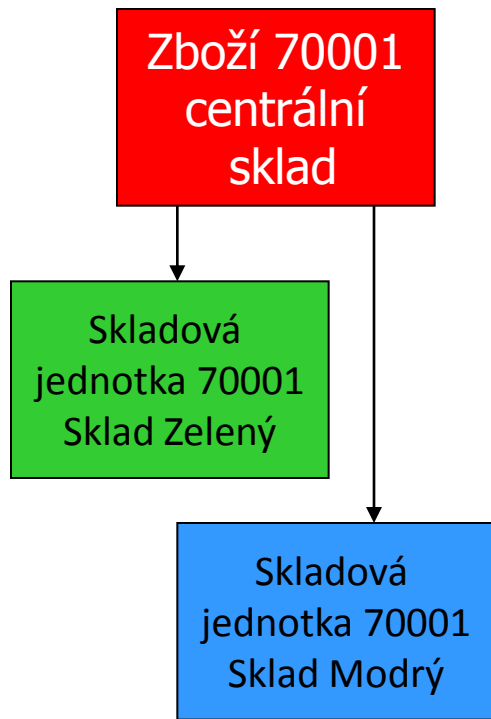

70000 Side Panel - Item Card

General Invoicing Replenishment Planning Foreign Trade Item Tracking E - Commerce Warehouse

No. 70000 Search Description . . . SIDE PANEL

Description Side Panel Inventory. 4 182

Base Unit of Measure . . . PCS Qty. on Purch. Order . . . 0

Bill of Materials Qty. on Prod. Order . . . 0

Shelf No. A1 Qty. on Component Lines . . . 0

Automatic Ext. Texts . . . Qty. on Sales Order . . . 0

Created From Nonstoc. . . Qty. on Service Order . . . 0

Item Category Code . . . Service Item Group . . .

Product Group Code . . . Blocked

Last Date Modified . . . 18.06.08

Item Sales Purchases **Functions** Help

Vytvoř skladovou jednotku



Skladová jednotka

Vytvoř skladovou jednotku

Item Options

Field	Filter
No.	70000
Inventory Posting Group	
Location Filter	GREEN
Variant Filter	

OK Cancel Help

Item Options

Create Per Location

Item In Inventory Only . . .

Replace Previous SKUs . . .

*Pouze pro ty položky,
které mají nenulový stav*

OK Cancel Help

V tomto příkladě nezaškrťávejte !
V reálném případě použijte Lokace Červený (RED)

Skladová jednotka

General		Invoicing	Replenishment	Planning	Warehouse		
Item No.	70000					Inventory.	44
Description	Side Panel					Qty. on Purch. Order . . .	0
Location Code.	RED					Qty. on Prod. Order . . .	0
Variant Code						Qty. in Transit	0
Bill of Materials	<input type="checkbox"/>					Qty. on Component Lines	0
Shelf No.	A1					Qty. on Sales Order . . .	0
						Qty. on Service Order . .	0
						Last Date Modified . . .	26.11.08

Skladová jednotka

General | Transfer-from | Transfer-to | Foreign Trade

No. 1013 [...]

Posting Date 26.11.08

Transfer-from Code . . . BLUE [↑]

Department Code . . . [↑]

Transfer-to Code . . . RED [↑]

Project Code [↑]

In-Transit Code OWN LOG. [↑]

Assigned User ID [↑]

Status Open

Item No.	Description	Quantity	Reserve...	Reserve...	Reserve...	Unit of M...	Qty. to ...	Quantity...	Qty. to ...
▶ 70000	[↑] Side Panel	44				PCS	44		



Skladová jednotka

General		Invoicing		Replenishment		Planning		Warehouse	
Item No.	70000	Inventory.	88						
Description	Side Panel	Qty. on Purch. Order . .	0						
Location Code.	RED	Qty. on Prod. Order. . .	0						
Variant Code		Qty. in Transit	0						
Bill of Materials	<input type="checkbox"/>	Qty. on Component Lines	0						
Shelf No.	A1	Qty. on Sales Order . . .	0						
		Qty. on Service Order . .	0						
		Last Date Modified . . .	26.11.08						

Byly provedeny dva transfery po 44 ks každý

Skladová jednotka

General	Invoicing	Replenishment	Planning	Warehouse		
Item No.	70000				Inventory.	88
Description	Side Panel				Qty. on Purch. Order . .	0
Location Code.	RED				Qty. on Prod. Order . . .	0
Variant Code					Qty. in Transit	10
Bill of Materials	<input type="checkbox"/>				Qty. on Component Lines	0
Shelf No.	A1				Qty. on Sales Order . . .	0
					Qty. on Service Order . .	0
					Last Date Modified . . .	26.11.08

**Nová objednávka transferu na 10 ks po
zaúčtování první části
BLUE->Vlastní doprava**

Skladová jednotka

General	Invoicing	Replenishment	Planning	Warehouse	
Item No.	70000			Inventory.	98
Description	Side Panel			Qty. on Purch. Order . .	0
Location Code.	RED			Qty. on Prod. Order . . .	0
Variant Code				Qty. in Transit	0
Bill of Materials	<input type="checkbox"/>			Qty. on Component Lines	0
Shelf No.	A1			Qty. on Sales Order . . .	0
				Qty. on Service Order . .	0
				Last Date Modified . . .	26.11.08

98=88+10

Skladová jednotka

General Invoicing Shipping Foreign Trade E - Commerce Prepayment

No. 1018 [edit]
Posting Date 26.11.08
Sell-to Customer No. 61000 [up]
Order Date 26.11.08
Sell-to Contact No. CT000137 [up]
Document Date 26.11.08
Sell-to Customer Name Fairway Sound
Requested Delivery Date
Sell-to Address 159 Fairway
Promised Delivery Date
Sell-to Address 2
Quote No.
Sell-to Post Code/City W2 8HG [up] London [up]
External Document No.
Sell-to Contact
Salesperson Code P5 [up]
No. of Archived Versions. 0
Campaign No. [up]
Responsibility Center LONDON [up]
Status Open

Customer Information
Sell-to Customer [edit]
• Ship-to Addresses (0)
• Contacts (1)
• Sales History
Bill-to Customer
• Avail. Credit 0

Type	No.	Cross-Reference No.	Substitut... Available	Description	Quantity	Location Code	Unit of Measure Code	Qty. to Ship	Qty. to Invoice	Requested Delivery Date	Promis Delive Date
▶ Item	70000			Side Panel	110	RED [up]	PCS	110	110		

Item Information
• Item Card [edit]
• Availability (-12)
• Substitutions (0)
• Sales Prices (0)

Skladová jednotka – sešit požadavků

Name DEFAULT

	Action Message	Accept Action M...	Replenish System	Description	Location Code	Original Quantity	Quantity	Unit of Measure...	Direct Unit Cost	Original Due Date	Due Date	Vendor No.	Vendor Item No.
▶	70000	New	✓	Purchase	Side Panel	RED		12 PCS	15,70008		26.11.08	10000	10-102

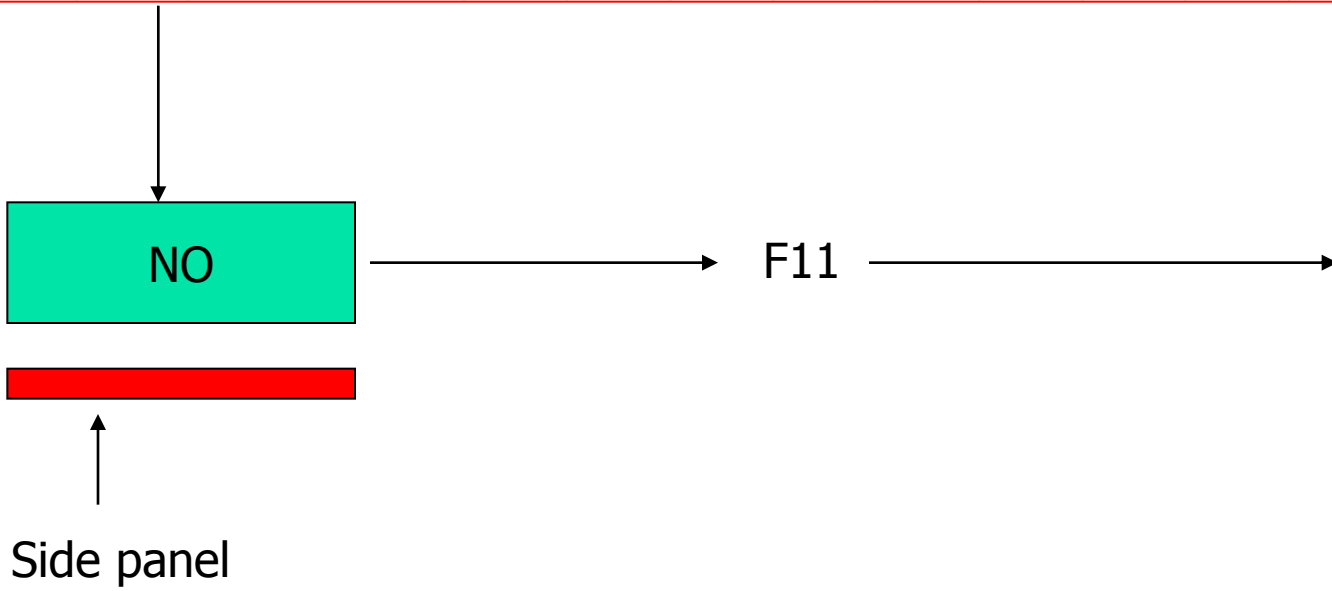

Skladová jednotka

General	Invoicing	Replenishment	Planning	Warehouse		
Item No.	70000				Inventory.	110
Description	Side Panel				Qty. on Purch. Order . .	0
Location Code.	RED				Qty. on Prod. Order . . .	0
Variant Code					Qty. in Transit	0
Bill of Materials	<input type="checkbox"/>				Qty. on Component Lines	0
Shelf No.	A1				Qty. on Sales Order . . .	110
					Qty. on Service Order . .	0
					Last Date Modified . . .	27.11.08



CTRL-F5

Posting Date	Entry Type	Document Type	Document No.	Item No.	Description	Lot No.	Warranty Date	Expiration Date	Location Code
▶ 26.11.08	Transfer	Transfer Receipt	109004	70000					RED
26.11.08	Transfer	Transfer Receipt	109005	70000					RED
26.11.08	Transfer	Transfer Receipt	109006	70000					RED
26.11.08	Purchase	Purchase Receipt	107049	70000					RED

Rezervace

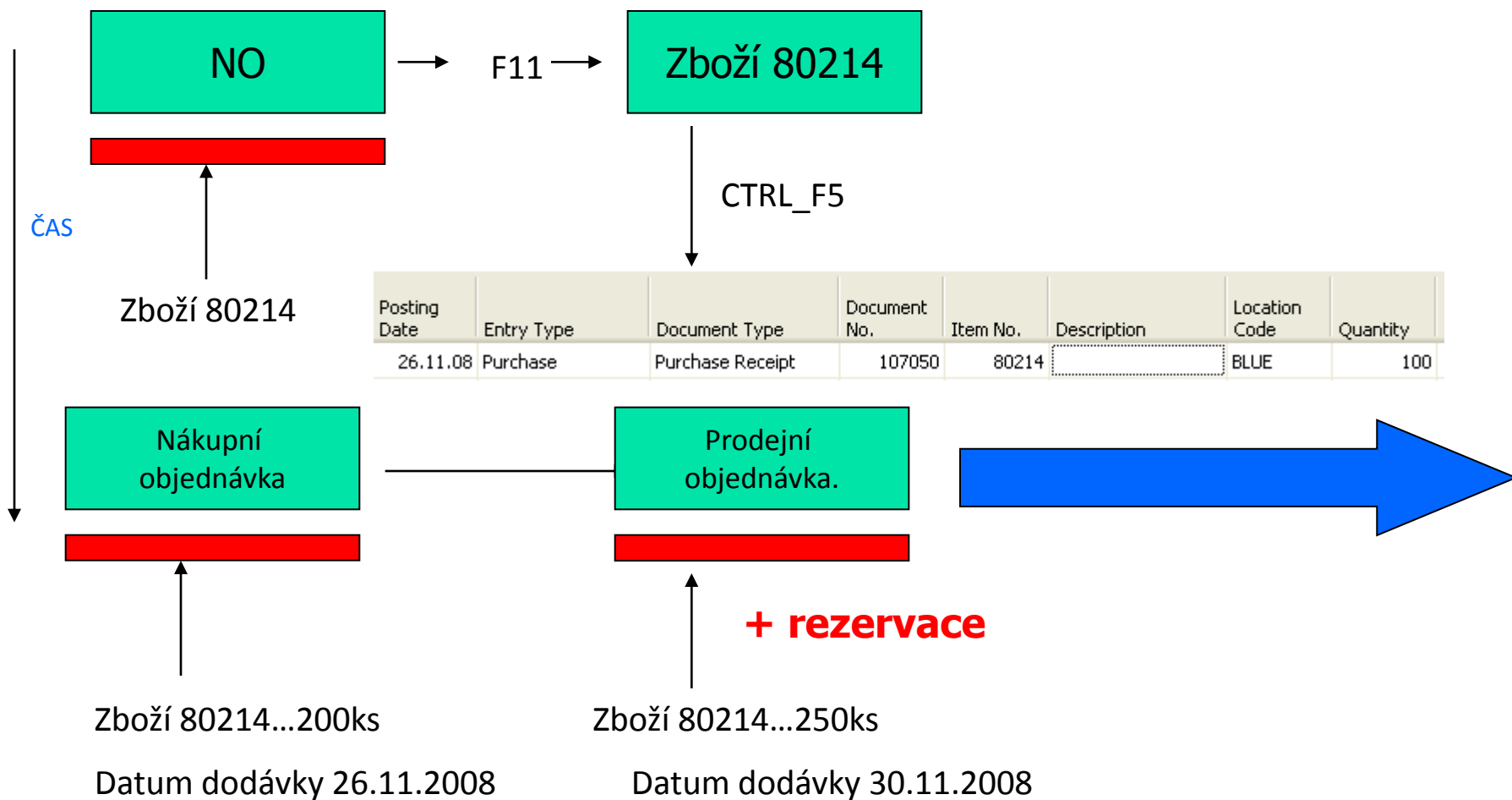

Rezervace (from PO->Function-Reserve)

General Filters

Item No. 80214 Quantity to Reserve. . . 250
Shipment Date 30.11.08 Reserved Quantity . . . 0
Description Unreserved Quantity . . . 250

Summary Type	Total Quantity	Total Reserved Quantity	Qty. Allocate...	Total Available...	Current Reserve...
▶ Item Ledger Entry	100		↓	100	
Purchase Line, Order	200			200	

Line Functions Help

Rezervace z aktuálního řádku nebo rezervace automatická

General Filters

Item No. 80214 Quantity to Reserve. . . 250
Shipment Date 30.11.08 Reserved Quantity . . . 250
Description Unreserved Quantity . . . 0

Summary Type	Total Quantity	Total Reserved Quantity	Qty. Allocate...	Total Available...	Current Reserve...
▶ Item Ledger Entry	100	100	↓		100
Purchase Line, Order	200	150		50	150

Rezervace

Prodejní
objednávka.

Description	Quantity	Location Code	Unit of Measure Code	Qty. to Ship	Reserved Quantity	Qty. to Invoice	Requested Delivery Date
250MB Disks/2pack	250	BLUE	PCS	250	250	250	

Rezervační položky

Reservation Status	Item No.	Location Code	Quantity (Base)	Reserved For	Reserved From	Entry No.	Transfer... from Ent...
Reservation	80214	BLUE	-100	Sales Order 1019	Item Ledger Entry 389	56	0
Reservation	80214	BLUE	-150	Sales Order 1019	Purchase Order 106049	57	0

Rezervace-Tracing (if Lot No)

Prodejní
objednávka- hlavička



Type	No.	Cross-Reference No.	Substitut... Available	Description	Quantity	Location Code	Unit of Measure Code	Qty. to Ship	Reserved Quantity	Q Ir
Item	M1	--	✓	Mouka	500	BLUE	KG	500		

Item Information

- Item Card
- Availability (-230)
- Substitutions (1)

Name DEFAULT

Sešit požadavků

T.. No.	Action Message	Accept Action M...	Replenish... System	Description	Location Code	Original Quantity	Quantity	Unit of Measure...	Direct Unit Cost	Original Due Date	Due Date
I... M1	New	✓	Purchase	Mouka	BLUE		230	KG	10,00		26.11.08

Nákupní
objednávka

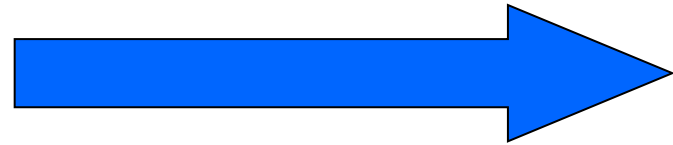

Rezervace-Tracing (if Lot No)

Nákupní
objednávka- hlavička



Description	Location Code	Quantity	Reserved Quantity	Unit of Measure Code	Direct Unit Cost Excl. VAT	Line Amount Excl. VAT	Line Disc... %	Qty. to Receive
Mouka	BLUE	230		KG	10,00	2 300,00		230

from Purchase Order>Function->Reserve

General Filters

Item No. M1 Quantity to Reserve. . . 230

Shipment Date 26.11.08 Reserved Quantity . . . 230

Description Unreserved Quantity . . . 0

Summary Type	Total Quantity	Total Reserved Quantity	Qty. Allocate...	Total Available...
▶ Sales Line, Order	500	230	↓	270

Rezervace-Tracing (if Lot No)

Nákupní
objednávka- hlavička



Description	Location Code	Quantity	Reserved Quantity	Unit of Measure Code	Direct Unit Cost Excl. VAT	Line Amount Excl. VAT	Line Disc... %	Qty. to Receive
Mouka	BLUE	230	230	KG	10,00	2 300,00		230

Sledování zakázky

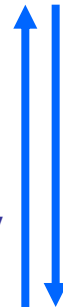

Prodejní
objednávka- hlavička



Description	Location Code	Quantity	Reserved Quantity	Unit of Measure Code	Direct Unit Cost Excl. VAT
Mouka	BLUE	230	230	KG	10,00

Rezervace-Tracing (if Lot No)

Nákupní
objednávka- hlavička

Přiřazení dávek

	Purchase ...	Item Trac...	Undefined
Quantity	230	130	100,00
Qty. to Handle	230	130	100,00
Qty. to Invoice	230	130	100,00
Item Tracking Code . . .	LOTALLEXP Lot specific tracking, manual Expiration		

A. S. Serial No.	A. L. Lot No.	Expiration Date	Warranty Date	Quantity (Base)	Qty. to Handle (...)
	MOUKA_100	31.12.08	31.12.08	100	100
	MOUKA_200	02.02.09	02.02.09	30	30

Před F11 – vytvořené položky rezervací

Rezervace-Tracing (if Lot No)

Reservation Status	Item No.	Location Code	Lot No.	Quantity (Base)	Reserved For	Reserved From	Entry No.
Reservation	M1	BLUE		100	Sales Order 1020	Purchase Order 106050	62
Reservation	M1	BLUE	MOUKA_100	100	Sales Order 1020	Purchase Order 106050	63
Reservation	M1	BLUE	MOUKA_200	30	Sales Order 1020	Purchase Order 106050	64



RESERVATION
SURPLUS
TRACKING
PROSPECT

Rezervace-Tracing (if Lot No)

Prodejní
objednávka- hlavička

Description	Location Code	Quantity	Reserved Quantity	Unit of Measure Code	Direct Unit Cost Excl. VAT
Mouka	BLUE	230	230	KG	10,00

Přiřazení rezervovaných dávek + F11

Sales Line	Item Trac...	Undefined	
Quantity	<input type="text" value="230"/>	<input type="text" value="230"/>	<input type="text"/>
Qty. to Handle	<input type="text" value="230"/>	<input type="text" value="230"/>	<input type="text"/>
Qty. to Invoice	<input type="text" value="230"/>	<input type="text" value="230"/>	<input type="text"/>
Item Tracking Code . . .	<input type="text" value="LOTALLEXP"/>	<input type="text" value="Lot specific tracking, manual Expiration"/>	

Serial No.	Lot No.	Expiration Date	Warranty Date	Quantity (Base)	Qty. to Handle (...)
<input type="checkbox"/>	MOUKA_100	31.12.08		100	100
<input type="checkbox"/>	MOUKA_200	02.02.09		30	30
<input checked="" type="checkbox"/>	MOUKA_300	02.02.09		100	100

Rezervace-Tracing (if Lot No)

(Go firstly to Sales->History->Item Tracing)

General

Serial No. Filter ↑

Lot No. Filter ↑

Item Filter M1 ↑

Variant Filter ↑

Show Components . . . Item-tracked Only ▾

Trace Method Usage -> Origin
 Origin -> Usage

Serial No.: , Lot No.: , Item: M1, Variant: , Origin->Usage, Item-tracked Only

Expand/Coll...	Description	Serial No.	Item No.	Lot No.	Item Description	Location Code	Quantity	Remaining Quantity
	Item Ledger Entry T00002		M1	MOUKA_001	Mouka	BLUE	100	100
[-]	Item Ledger Entry T00003		M1	MOUKA_002	Mouka	BLUE	200	90
	Sales Shipment Header 102040		M1	MOUKA_002	Mouka	BLUE	-110	0
	Item Ledger Entry T00004		M1	MOUKA_003	Mouka	BLUE	80	80
[-]	Purch. Rcpt. Header 107051		M1	MOUKA_300	Mouka	BLUE	100	0
	Sales Shipment Header 102044		M1	MOUKA_300	Mouka	BLUE	-100	0
[-]	Purch. Rcpt. Header 107051		M1	MOUKA_100	Mouka	BLUE	100	0
	Sales Shipment Header 102044		M1	MOUKA_100	Mouka	BLUE	-100	0
▶ [-]	Purch. Rcpt. Header 107051		M1	MOUKA_200	Mouka	BLUE	30	0
	Sales Shipment Header 102044		M1	MOUKA_200	Mouka	BLUE	-30	0

Analýzy rozpočtu+rozpočet

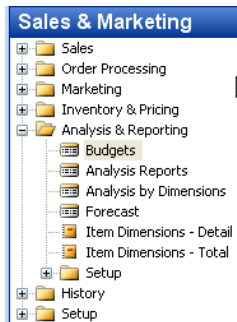

General Filters Options

Item Budget Name BUDGET 08 ↑

Show as Lines Item ↑

Show as Columns Period ↑

Date Filter

Customer Filter ↑

Item Filter ↑

Show Value as Quantity ↓

Code	Name	Budgete...	Budgeted Sal...	26.11.08	27.11.08	28.11.08	29.11.08	30.11.08	01
80213	Drive250	0	0,00						
80214	250MB Disks/2pack	1 500	15 000,00	100,00	200,00	300,00	400,00	500,00	
80215	250MB Disks/4pack	3 200	32 000,00	600,00	700,00	800,00	900,00	200,00	
80216	Ethernet Cable	0	0,00						

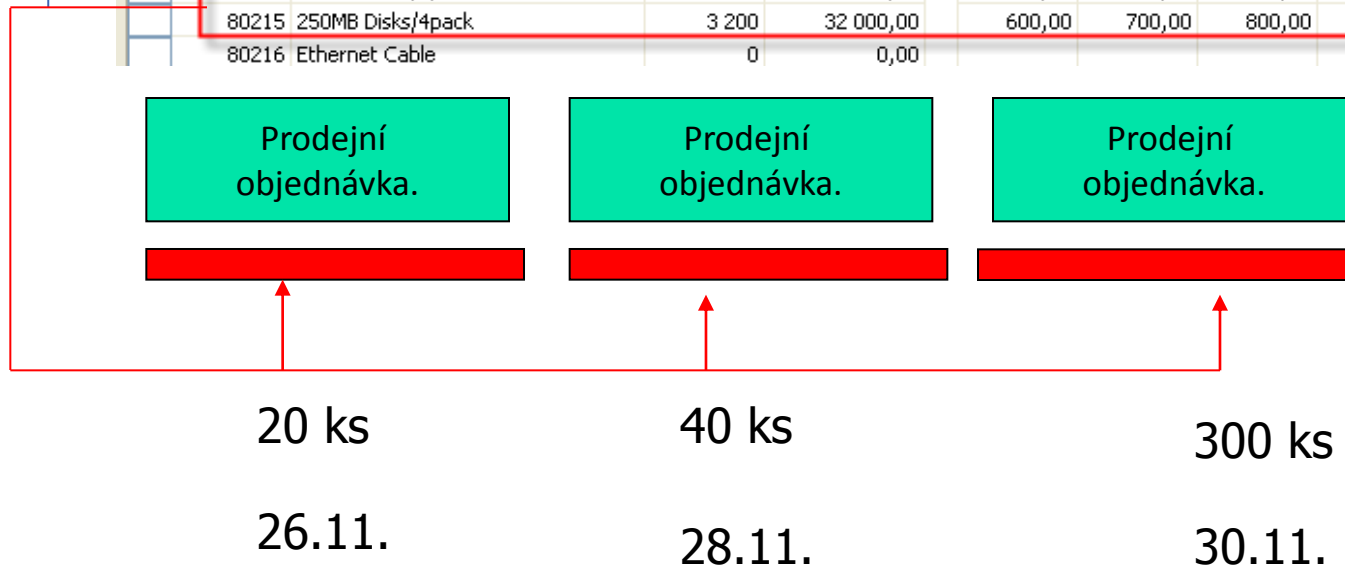

Analýzy rozpočtu+rozpočet

	Posting Date	Entry Type	Document Type	Document No.	Description	Location Code	Quantity	Invoiced Quantity	Remaining Quantity
▶	26.11.08	Purchase	Purchase Receipt	107050		BLUE	100	100	100
	26.11.08	Sale		T00014		BLUE	-20	-20	-20
	28.11.08	Sale		T00014		BLUE	-40	-40	-40
	30.11.08	Sale		T00014		BLUE	-300	-300	-300

Zboží 80214

Ctrl-F5

Analýzy rozpočtu+rozpočet

Name	Description
BUDGET	Turnover, actual vs. budget
PRICES	Prices Analysis
PROFIT	Profitability
SALES	Turnover, actual vs last

Nastavení sloupců

Name BUDGET 

Column No.	Column Header	Invoiced	Column Type	Ledger Entry Type	Formula	Show Op...	Compari...	Analysis Type C...
A1	Turnover in Amount, actual	✓	Net Change	Item Entries				SALES-AMT
A2	Turnover in Qty, actual	✓	Net Change	Item Entries		✓		SALES-QTY
A3	Turnover in Amount, budget		Net Change	Item Budget Entries				SALES-AMT
A4	Turnover in Qty, budget		Net Change	Item Budget Entries				SALES-QTY
A5	Deviation % Amount		Formula	Item Entries	(A1/A3)*100			
A6	Deviation % Qty		Formula	Item Entries	(A2/A4)*100			

Analýzy rozpočtu+rozpočet

Name	Description
BUDGET	Budget test
CUSTGR...	Customers Groups, All
CUST-ALL	Customers All
FURNIT-...	Furniture Total
MY-CUST	My Customers
MY-ITEMS	My Items, Total

Nastavení řádků

Name MY-ITEMS

Row Ref...	Description	T..	Range
▶ 1896-S	ATHENS Desk	I...	1896-S
1900-S	PARIS Guest Chair, black	I...	1900-S
1906-S	ATHENS Mobile Pedestal	I...	1906-S
1908-S	LONDON Swivel Chair, blue	I...	1908-S
1920-S	ANTWERP Conference Table	I...	1920-S
1924-W	CHAMONIX Base Storage Unit	I...	1924-W
1928-S	AMSTERDAM Lamp	I...	1928-S
1928-W	ST.MORITZ Storage Unit/Draw...	I...	1928-W
1936-S	BERLIN Guest Chair, yellow	I...	1936-S
1952-W	OSLO Storage Unit/Shelf	I...	1952-W
1960-S	ROME Guest Chair, green	I...	1960-S
1964-S	TOKYO Guest Chair, blue	I...	1964-S
1964-W	INNSBRUCK Storage Unit/G.Door	I...	1964-W
1968-S	MEXICO Swivel Chair, black	I...	1968-S
1968-W	GRENOBLE Whiteboard, red	I...	1968-W
1972-S	MUNICH Swivel Chair, yellow	I...	1972-S
1972-W	SAPPORO Whiteboard, black	I...	1972-W
1976-W	INNSBRUCK Storage Unit/W.D...	I...	1976-W
1980-S	MOSCOW Swivel Chair, red	I...	1980-S
1984-W	SARAJEVO Whiteboard, blue	I...	1984-W
1988-S	SEOUL Guest Chair, red	I...	1988-S
1988-W	CALGARY Whiteboard, yellow	I...	1988-W
1992-W	ALBERTVILLE Whiteboard, green	I...	1992-W
1996-S	ATLANTA Whiteboard, base	I...	1996-S
2000-S	SYDNEY Swivel Chair, green	I...	2000-S
80214	250MB Disks/2pack	I...	80214
80215	250MB Disks/4pack	I...	80215

Analýzy rozpočtu+rozpočet

Analysis view card

General Dimensions

Code	<input type="text" value="CUSTOMERS"/>	Last Date Updated . . .	<input type="text" value="27.11.08"/>
Name	<input type="text" value="Customers"/>	Last Entry No.	<input type="text" value="542"/>
Item Filter	<input type="text"/> ↑	Last Budget Entry No. . .	<input type="text" value="33"/>
Location Filter	<input type="text"/> ↑	Update on Posting. . . .	<input checked="" type="checkbox"/>
Date Compression	Day ↓	Include Budgets	<input checked="" type="checkbox"/>
Starting Date	<input type="text" value="01.01.01"/>	Blocked	<input type="checkbox"/>

Analysis ▼ Update Help

Microsoft Dynamics NAV

Do you want to update Item Analysis View CUSTOMERS?

Ano Ne

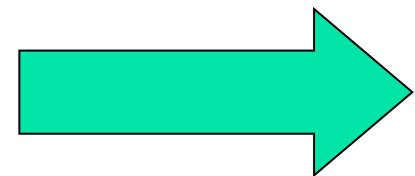

Analýzy rozpočtu + rozpočet

General Filters Options

Analysis Report Name . . . BUDGET [↑]

Analysis Line Template . . . MY-ITEMS [↑]

Analysis Column Templ... BUDGET [↑]

Date Filter 01.01.01..31.12.08

Item Budget Filter BUDGET 08 [↑]

Row Ref. No.	Description	Turnover in Amount, actual	Turnover in Qty, actual	Turnover in Amount, budget	Turnover in Qty, budget	Deviation % Amount	Deviation % Qty
▶ 1896-S	ATHENS Desk						
1900-S	PARIS Guest Chair, black	750,60	6,00				
1906-S	ATHENS Mobile Pedestal	281,40	1,00				
1908-S	LONDON Swivel Chair, blue						
1920-S	ANTWERP Conference Table	840,80	2,00				
1924-W	CHAMONIX Base Storage Unit						
1928-S	AMSTERDAM Lamp	671,06	19,00				
1928-W	ST.MORITZ Storage Unit/Drawers	290,79	1,00				
1936-S	BERLIN Guest Chair, yellow						
1952-W	OSLO Storage Unit/Shelf	134,72	1,00				
1960-S	ROME Guest Chair, green	994,55	8,00				
1964-S	TOKYO Guest Chair, blue						
1964-W	INNSBRUCK Storage Unit/G.Door	3 416,40	12,00				
1968-S	MEXICO Swivel Chair, black	1 337,80	11,00				
1968-W	GRENOBLE Whiteboard, red	1 657,16	2,00				
1972-S	MUNICH Swivel Chair, yellow	863,10	7,00				
1972-W	SAPPORO Whiteboard, black						
1976-W	INNSBRUCK Storage Unit/W.Door	1 152,46	5,00				
1980-S	MOSCOW Swivel Chair, red	369,90	3,00				
1984-W	SARAJEVO Whiteboard, blue						
1988-S	SEOUL Guest Chair, red						
1988-W	CALGARY Whiteboard, yellow	877,32	1,00				
1992-W	ALBERTVILLE Whiteboard, green	877,32	1,00				
1996-S	ATLANTA Whiteboard, base	7 842,96	9,00				
2000-S	SYDNEY Swivel Chair, green	123,30	1,00				
80214	250MB Disks/2pack	3 600,00	360,00	15 000,00	1 500,00	24,00	24,00
80215	250MB Disks/4pack			32 000,00	3 200,00		

1 7 31 3 12 [Navigation icons]

Functions [Print] [Help]

Prognóza-forecast

General

Production Forecast N... 2008 Forecast Type Both

Location Filter Date Filter

No.	Description	26.11.08	27.11.08	28.11.08	29.11.08	30.11.08
80213	Drive250					
80214	250MB Disks/2pack					
80215	250MB Disks/4pack					
80216	Ethernet Cable					
80217	Power Supply Cable	10 000	20 000	30 000	40 000	

Forecast

Bude integrováno díky Lot-for-lot a 1D
 $30000=10000+20000$

Bude integrováno díky Lot-for-lot a 1D
 $70000=30000+40000$

Prognóza-forecast

Name DEFAULT

Plánovací sešit z výroby

T..	No.	Action Message	Accept Action M...	Replenish... System	Description	Location Code	Original Quantity	Quantity	Unit of Measure...
▶ I...	80214	Chang...	✓	Purchase	250MB Disks/2pack	BLUE	200	150	PCS
I...	80214	New	✓	Purchase	250MB Disks/2pack	BLUE		100	PCS
I...	80217	New	✓	Purchase	Power Supply Cable			30 000	PCS
I...	80217	New	✓	Purchase	Power Supply Cable			70 000	PCS



ATP-CTP

- **Available-to-Promise** (Lze slíbit)
- **Capable-to-Promise** (Možné slíbit)

- **ATP** – based on the inventory reservation system – performing the availability check
(calculation of the date of delivery)

- **CTP** – based on WHAT IF scenarios. Earliest date in which an item will be available

If no items that can be available, no inbound orders- purchase, transfer , return, production – it calculates Earliest Date, creates Order lines, and reserves the inventory.

Maybe integrated to the production scheduling, transfer and purchase

ATP -CTP

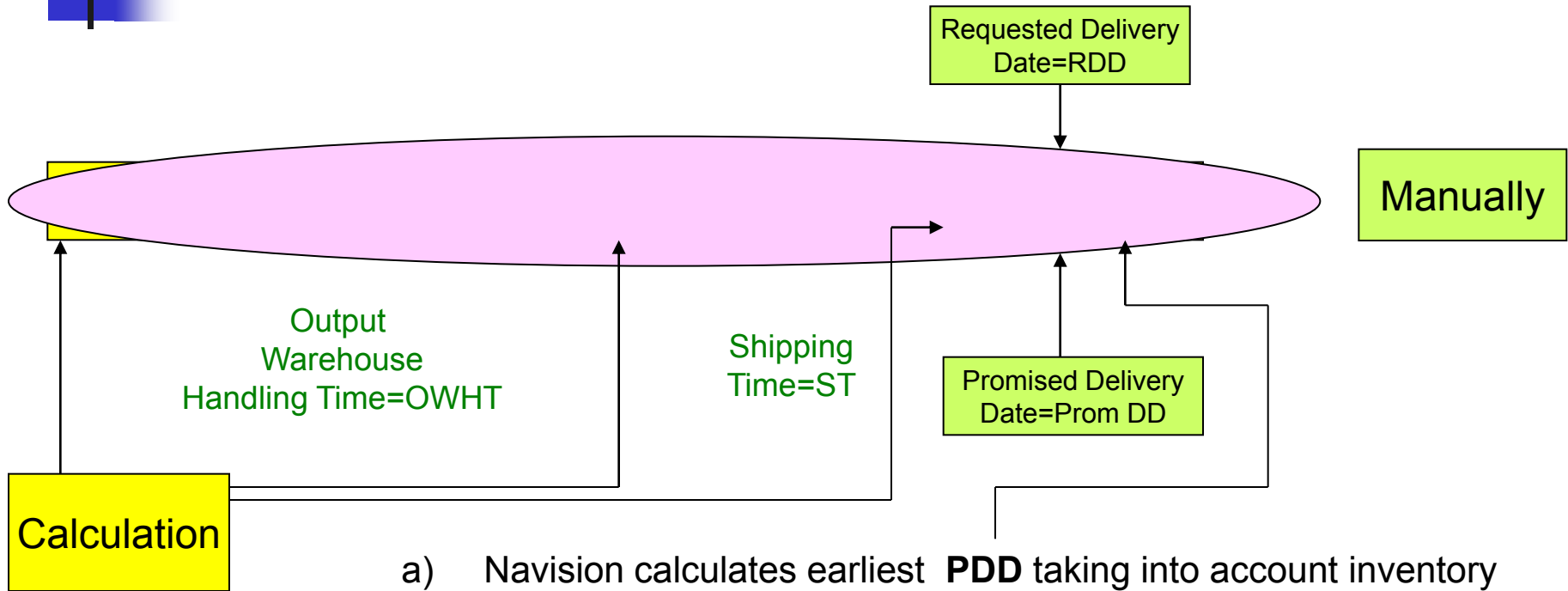

- a) Navision calculates earliest **PDD** taking into account inventory availability without customer's requirements
- b) Navision verifies, if by hand entered RDD is realistic taking into account inventory availability (backward calculation)

 Next

ATP -CTP



Location
BLUE

Output
Warehouse
Handling
Time=OWHT

Shipping
Time=ST

Customer->Shipping->Shipping Agent Services->
Shipping Time and Calendars



Customer

MODRÝ Modrý sklad - Location Card

General Communication Warehouse Bins Bin Policies

Outbound Whse. Han... 1D

Inbound Whse. Handl... 2D

Base Calendar Code . . .

Customized Calendar . No

FEDEX Federal Express Corporation - Shipping Agent Services

Code	Description	Shipping Time	Base Calendar...	Customized Calendar
DRUHÝDEN	Dodávka druhý den	1D		No
STANDARD	Standardní dodávka	2D		No

ATP –CTP – Order Promising Setup

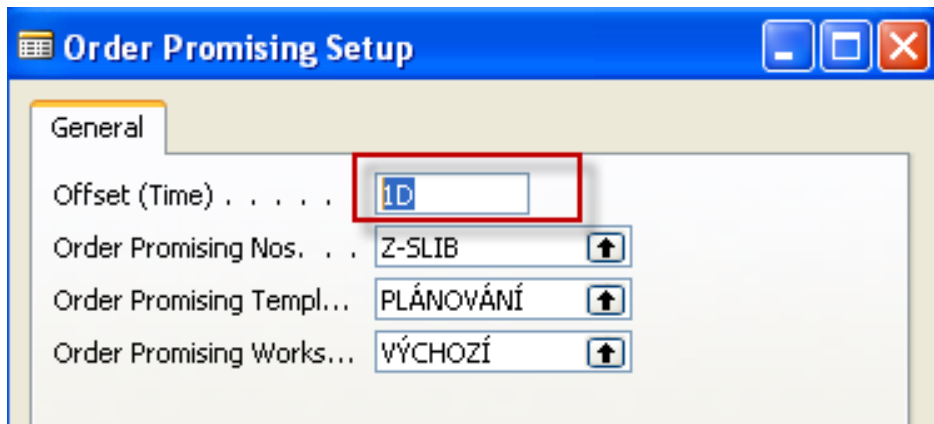

Order Promising Setup

General

Offset (Time) 1D

Order Promising Nos. . . . Z-SLIB ↑

Order Promising Templ... PLÁNOVÁNÍ ↑

Order Promising Works... VÝCHOZÍ ↑

This field contains the period of time that the program must **wait** before it is allowed to issue a new purchase order, production order or transfer order. **The period starts with the current date.**

The time units of measure that you can use are days, workdays, weeks, months, quarters or years.

ATP –CTP – simple example

Options

Location Filter MODRÝ Variant Filter

Period Start	Period Name	Gross Require...	Scheduled Receipt	Planned Order Receipt	Projected Available Balance	Planned Order Releases
21.11.09	Saturday	0	0	0	71	0
22.11.09	Sunday	0	0	0	71	0
23.11.09	Monday	0	0	0	71	0
24.11.09	Tuesday	0	0	0	71	0
25.11.09	Wednesday	0	0	0	71	0
26.11.09	Thursday	0	0	0	71	0
27.11.09	Friday	0	0	0	71	0

1 7 31 3 12 Item Help

Availability by period

ATP –CTP – simple example

1043 BYT-KOMPLET s.r.o. - Sales Order

General Invoicing **Shipping** Foreign Trade E - Commerce Advance

Ship-to Code Location Code. MODRÝ

Ship-to Name BYT-KOMPLET s.r.o. Outbound Whse. Han... 1D

Ship-to Address Vrchlického 5 Shipment Method Code EXW

Ship-to Address 2 Shipping Agent Code DHL

Ship-to Post Code/City CZ-678 01 Blansko Shipping Agent Servic... PŘESNOC

Ship-to Contact Pan Jonas Brandel Shipping Time **3D**

Late Order Shipping

Package Tracking No.

Shipment Date 23.11.09

Shipping Advice Partial

Customer Information

- Sell-to Customer
- Ship-to Addresses (2)
- Contacts (5)
- Sales History
- Bill-to Customer
- Avail. Credit 0

	Price . VAT	Line Amount Excl. VAT	Line Disc... %	Qty. to Ship	Quantity Shipped	Qty. to Invoice	Quantity Invoiced	Qty. to Assign	Qty. Assigned	Planned Delivery Date	Planned Shipment Date	Shipment Date	Appl. to Item Entry
▶	10,00	500,00		50		50				27.11.09	24.11.09	23.11.09	0

Item Information

- Item Card
- Availability (21)
- Substitutions (0)
- Sales Prices (0)
- Sales Line Di... (0)

Order Line Functions Posting Print Help

Output Warehouse Handling Time=OWHT

On the customer Card ST=1D and Shipping agent ST = 3D (agent setup has a priority)

ATP –CTP – simple example

The button Order->Order promising



Sales Order - Order Promising Lines

No. 1043

Item No.	Description	Requested Delivery Date	Requested Shipment Date	Planned Delivery Date	Original Shipment Date	Earliest Shipment Date	Quantity	Unavailable Quantity	Unit of Measure Code
▶ X3	Komponenta 3		23.11.09		23.11.09		50	0	KS

Calculate Accept Cancel Help

ATP –CTP – simple example

1043 BYT-KOMPLET s.r.o. - Sales Order

General Invoicing **Shipping** Foreign Trade E - Commerce Advance

Ship-to Code [] Location Code. MODRÝ []
Ship-to Name BYT-KOMPLET s.r.o. Outbound Whse. Han... [] 1D
Ship-to Address Vrchlického 5 Shipment Method Code EXW []
Ship-to Address 2 [] Shipping Agent Code DHL []
Ship-to Post Code/City CZ-678 01 [] Blansko [] Shipping Agent Servic... PŘESNOC []
Ship-to Contact Pan Jonas Brandel Shipping Time 3D
Late Order Shipping
Package Tracking No. []
Shipment Date 23.11.09
Shipping Advice Partial []

Customer Information

Sell-to Customer []
• Ship-to Addresses (2)
• Contacts (5)
• Sales History
Bill-to Customer
• Avail. Credit 0

Type	No.	Cross-Reference No.	Substitut... Available	Description	Location Code	Quantity	Reserved Quantity	Unit of Measure Code	Unit Price Excl. VAT	Line Amount Excl. VAT
Item	X3			Komponenta 3	MODRÝ	100			10,00	1 000,00

Item Information

• Item Card []
• Availability (-29)
• Substitutions (0)
• Sales Prices (0)
• Sales Line Dj... (0)

Order Line Functions Posting Print Help

ATP –CTP – simple example

ITEM CARD SETUP (LEAD TIME and SAFETY LEAD TIME)

X3 Komponenta 3 - Item Card

General Invoicing **Replenishment** Planning Foreign Trade Item Tracking E - Commerce Warehouse

Replenishment System . . . Purchase

Purchase

Vendor No. 10000

Vendor Item No. 10-111

Purch. Unit of Measure . . . KS

Lead Time Calculation . . . **1W**

Production

Manufacturing Policy . . . Make-to-Stock

Routing No.

Production BOM No. . . .

Rounding Precision . . . 1

Flushing Method. Manual

Scrap % 0

Lot Size. 0

X3 Komponenta 3 - Item Card

General Invoicing Replenishment **Planning** Foreign Trade Item Tracking E - Commerce Warehouse

Reordering Policy Lot-for-Lot

Include Inventory

Reserve Optional

Order Tracking Policy . . . None

Reorder Cycle. 1D

Safety Lead Time 1D

Safety Stock Quantity . . . 0

Reorder Point 1 200

ATP –CTP – simple example

Instead of ATP calculation based on reservation system we will calculate CTP based on WHAT_IF scenario

Price VAT	Line Amount Excl. VAT	Line Disc... %	Qty. to Ship	Quantity Shipped	Qty. to Invoice	Quantity Invoiced	Qty. to Assign	Qty. Assigned	Planned Delivery Date	Planned Shipment Date	Shipment Date	Appl.-to Item Entry
10,00	1 000,00		100		100				27.11.09	24.11.09	23.11.09	

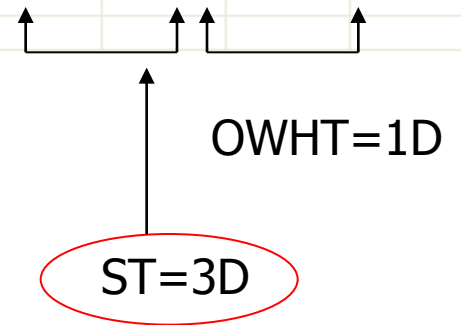

Before CTP calculation the situation is the same

ATP –CTP – simple example

MODRÝ Modrý sklad - Location Card

General | Communication | **Warehouse** | Bins | Bin Policies

Require Receive.	<input type="checkbox"/>		Default Bin Selection. . .	<input type="text" value=""/>
Require Shipment	<input type="checkbox"/>	OWHT	Outbound Whse. Han...	<input type="text" value="1D"/>
Require Put-away	<input type="checkbox"/>	IWHT	Inbound Whse. Handli...	<input type="text" value="2D"/>
Use Put-away Worksheet	<input type="checkbox"/>		Base Calendar Code. . .	<input type="text" value=""/>
Require Pick.	<input type="checkbox"/>		Customized Calendar	<input type="text" value="No"/>
Bin Mandatory	<input type="checkbox"/>		Use Cross-Docking . . .	<input type="checkbox"/>
Directed Put-away an...	<input type="checkbox"/>		Cross-Dock Due Date ...	<input type="text" value=""/>
Use ADCS.	<input type="checkbox"/>			

Location ▼ Help

ATP –CTP – simple example

After CTP calculation

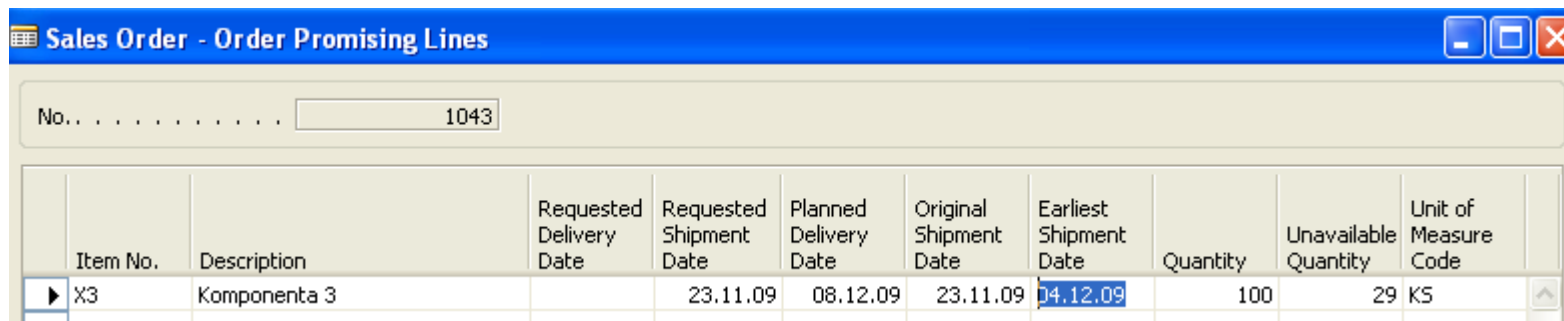

Item No.	Description	Requested Delivery Date	Requested Shipment Date	Planned Delivery Date	Original Shipment Date	Earliest Shipment Date	Quantity	Unavailable Quantity	Unit of Measure Code
X3	Komponenta 3		23.11.09	08.12.09	23.11.09	04.12.09	100	29	K5

4.12-2009 – 23.11.2009 = 11 DAYS = **1D** SLT + **2D** IWHT + **1D** OWHT + **7D** LT

Where LT= Lead Time and SLT= Safety Lead Time

8.12.2009 – 4.12.2009 = 4 Days more = 3 Days ST + 1 Day OWHT



ATP –CTP – simple example

Price . VAT	Line Amount Excl. VAT	Line Disc... %	Qty. to Ship	Quantity Shipped	Qty. to Invoice	Quantity Invoiced	Qty. to Assign	Qty. Assigned	Planned Delivery Date	Planned Shipment Date	Shipment Date	Appl.-to Item Entry
10,00	1 000,00		100		100				08.12.09	05.12.09	04.12.09	0

After CTP calculation is accepted



ATP –CTP - Setup

- **Customer**->Shipping->Shipping Agent Services->Shipping Time and Calendars
- **Administration**->Application Setup->General->Company Information->Shipping->Check Available Period Calculation and Check Available Time Bucket (see next slide)
- **Sales and Marketing**->SETUP->Order Promising Setup
- **Warehouse** ->Setup->Locations->Warehouse ->Inbound and Outbound Warehouse Handling Time
- **ITEM Card**->Lead Time

Setting up an Availability

Setup scenario : **Application Setup** – **General** -**Company Information**

The screenshot shows the 'Shipping' tab in SAP with the following fields:

Ship-to Name	CRONUS CZ s.r.o.	Location Code	
Ship-to Address	Okružní 5	Responsibility Center	
Ship-to Address 2	Vratislavice	Check-Avail. Period Calc.	90D
Ship-to Post Code/City	CZ-460 01 Liberec	Check-Avail. Time Bucket	Week
Ship-to Country Code	CZ	Base Calendar Code	
Ship-to Contact		Customized Calendar	No
		Cal. Convergence Tim...	1Y

90 days

1 week

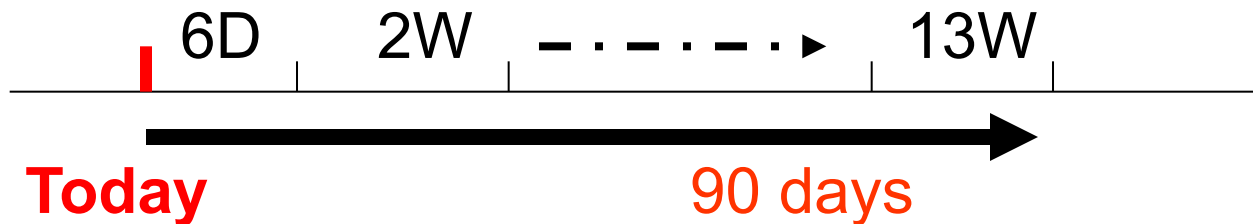

W=week



ATP-CTP

SEE XLS FILE ATP_CTP CALCULATIONS PLEASE

28.11.2008

12.12.2008



10 ks = Inventory , Lead Time=5D

20 ks = Purchase Order

Drop shipment

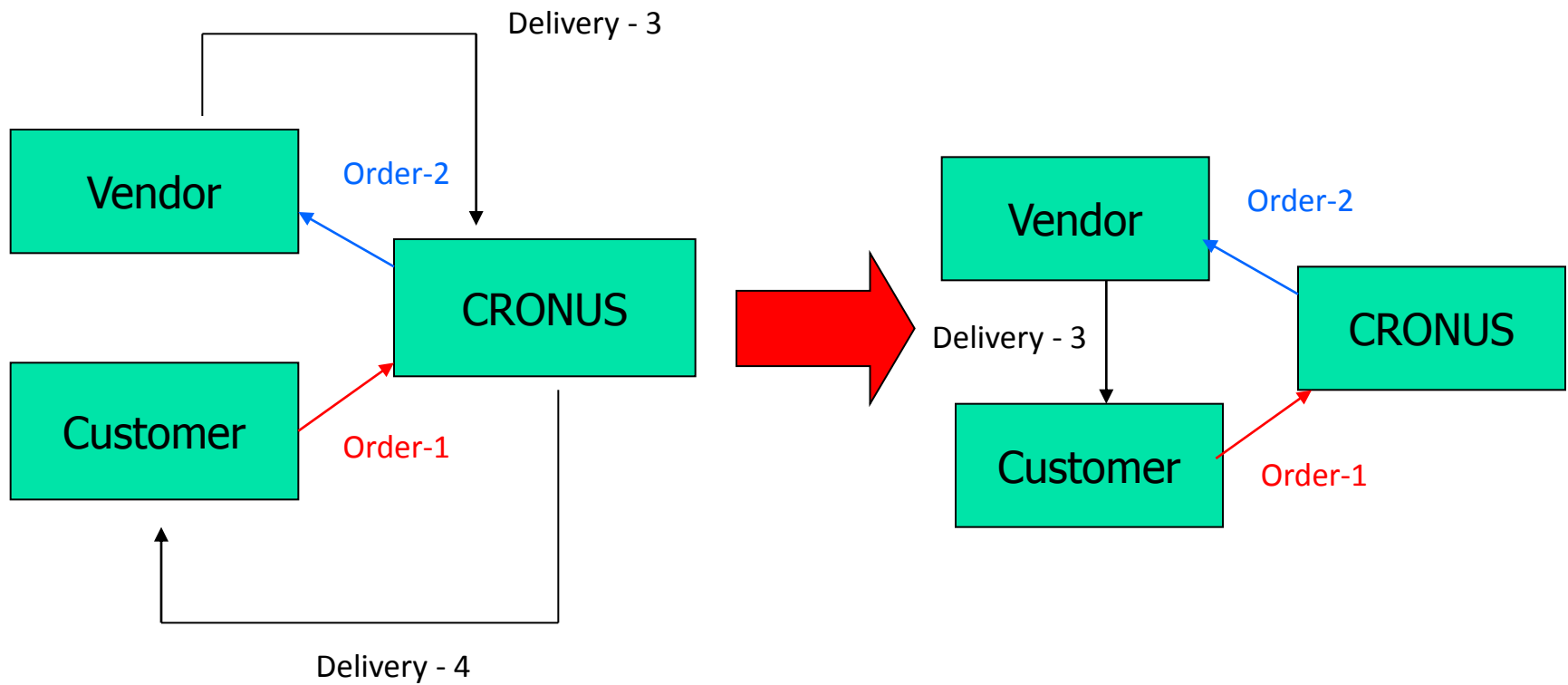

Drop shipment

1044 BYT-KOMPLET s.r.o. - Sales Order

General Invoicing Shipping Foreign Trade E - Commerce Advance

No. 1044 Posting Date 23.11.09
Sell-to Customer No. 10000 Order Date 23.11.09
Sell-to Contact No. KT000001 Document Date 23.11.09
Sell-to Customer Name BYT-KOMPLET s.r.o. Requested Delivery Date
Sell-to Address Vrchlického 5 Promised Delivery Date
Sell-to Address 2 External Document No.
Sell-to Post Code/City CZ-678 01 Blansko Salesperson Code PK
Sell-to Contact Pan Jonas Brandel Campaign No.
No. of Archived Versions. 0 Responsibility Center BLANSKO
Status Open

Purchasing Code List

Code	Description	Drop Shipment	Special Order
OVĚŘIT	Objednávka musí být ověřena		
PRIMDOD	Ověřit a poslat zákazníkovi	✓	
SPECOBJ	Ověřit a poslat k nám		✓

Substitut... Available Purchasing Code Description Special Order Location Code Quantity Reserved Quantity Unit of Measure Code Unit Price Excl. VAT Line Am Excl. VA

Type	Substitut... Available	Purchasing Code	Description	Special Order	Location Code	Quantity	Reserved Quantity	Unit of Measure Code	Unit Price Excl. VAT	Line Am Excl. VA
Item		PRIMDOD	Komponenta 3		MODRÝ	2		KS	10,00	

Order Line Functions Posting Print Help

Drop shipment

Purchase->Planning->Requisition worksheet->Functions->Drop Shipment->Get Sales orders

Page	Accept Action M...	Description	Location Code	Original Quantity	Quantity	Unit of Measure...	Direct Unit Cost	Original Due Date	Due Date
▶	✓	Komponenta 3	MODRÝ		2	KS	5,00		23.11.0

Functions -> Carry Out Action Messages



Drop shipment - Sales

Type	No.	Purchasing Code	Description	Location Code	Quantity	Reserved Quantity	Unit of Measure Code	Unit Price Excl. VAT	Line Amount Excl. VAT	Line Disc... %	Qty. to Ship	Quantity Shipped	Qty. to Invoice
Item	X3	PŘÍMDOD	Komponenta 3	MODRÝ	2		K5	10,00	20,00			2	



and afterward you must invoice also Purchase order.....



Drop shipment

Transfer Order (using warehouse logistics)

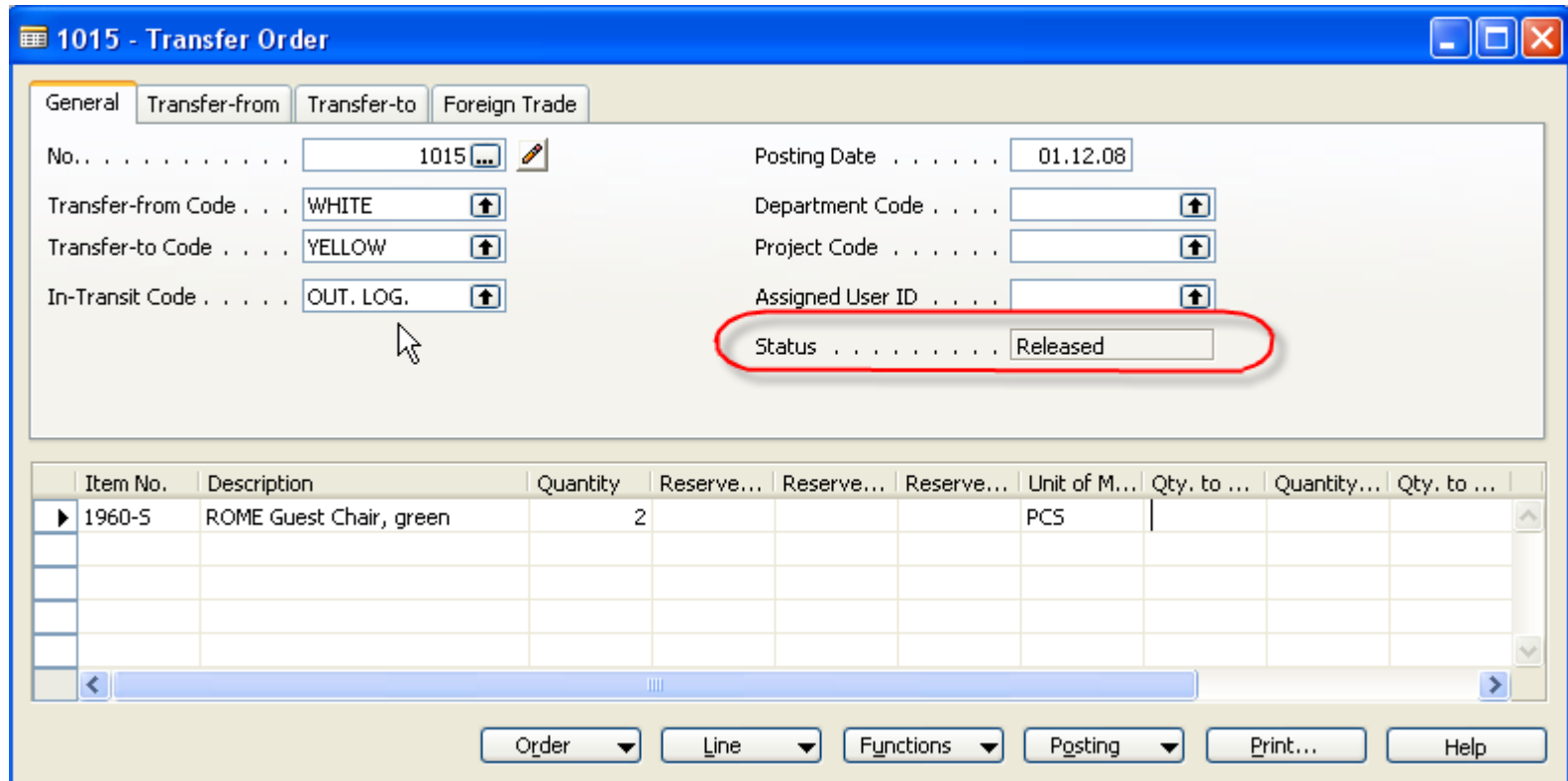

The screenshot shows the SAP Transfer Order (TO) entry screen for order 1015. The window title is "1015 - Transfer Order". The "General" tab is active, showing various fields for order details. The "Status" field is highlighted with a red oval and contains the value "Released". Below the form is a table with one data row for item 1960-5, described as "ROME Guest Chair, green", with a quantity of 2 and unit of measure "PCS".

Item No.	Description	Quantity	Reserve...	Reserve...	Reserve...	Unit of M...	Qty. to ...	Quantity...	Qty. to ...
▶ 1960-5	ROME Guest Chair, green	2				PCS			

Buttons at the bottom: Order, Line, Functions, Posting, Print..., Help.

Transfer Order (using warehouse logistics)

1960-S ROME Guest Chair , green - Item Availability by Location

Options

Date Filter : ..01.12.08 Variant Filter : "

Code	Name	Gross Re...	Schedule...	Planned ...	Projecte...	Planned ...
BLUE	Blue Warehouse	0	0	0	153	0
GREEN	Green Warehouse	0	0	0	0	0
GREEN_01	Skladová jednotka GREEN_01	0	0	0	0	0
RED	Red Warehouse	0	0	0	24	0
SILVER	Silver Warehouse	0	0	0	0	0
WEST W...	WEST WORK	0	0	0	0	0
WHITE	White Warehouse	2	0	0	1 170	0
YELLOW	Yellow Warehouse	0	0	0	50	0

1 7 31 3 12 Item Help

Transfer Order (using warehouse logistics)

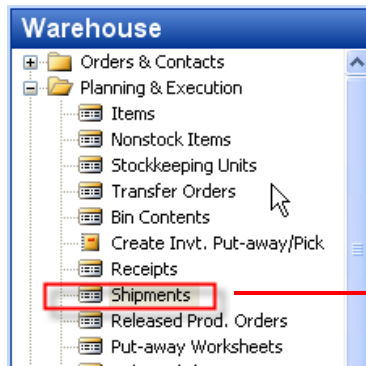

SH000006 - Warehouse Shipment

General Shipping

No. SH000006

Location Code. WHITE

Zone Code SHIP

Bin Code W-09-0001

Posting Date 01.12.08

Assigned User ID

Assignment Date

Assignment Time

Document Status

Status Open

Sorting Method

Source Document	Source No.	Item No.	Description	Location Code	Zone Code	Bin Cod

Shipment Line Functions Posting Print... Help

GET SOURCE DOCUMENT

Transfer Order (using warehouse logistics)

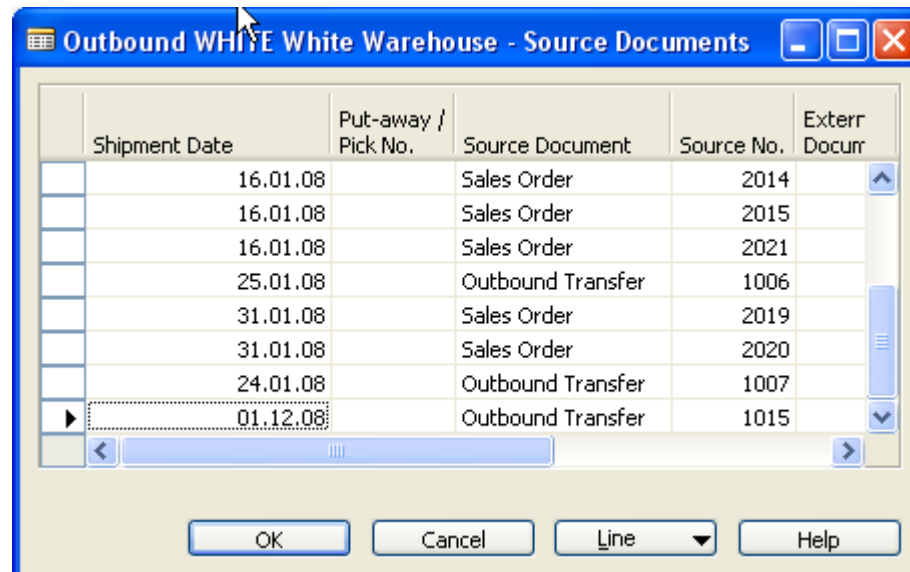

The screenshot shows a window titled "Outbound WHITE White Warehouse - Source Documents". It contains a table with the following columns: Shipment Date, Put-away / Pick No., Source Document, Source No., and Exterr Docurr. The table lists several source documents, with the last one selected. Below the table are buttons for "OK", "Cancel", "Line", and "Help".

Shipment Date	Put-away / Pick No.	Source Document	Source No.	Exterr Docurr
16.01.08		Sales Order	2014	^
16.01.08		Sales Order	2015	
16.01.08		Sales Order	2021	
25.01.08		Outbound Transfer	1006	
31.01.08		Sales Order	2019	
31.01.08		Sales Order	2020	
24.01.08		Outbound Transfer	1007	
01.12.08		Outbound Transfer	1015	v

Transfer Order (using warehouse logistics)

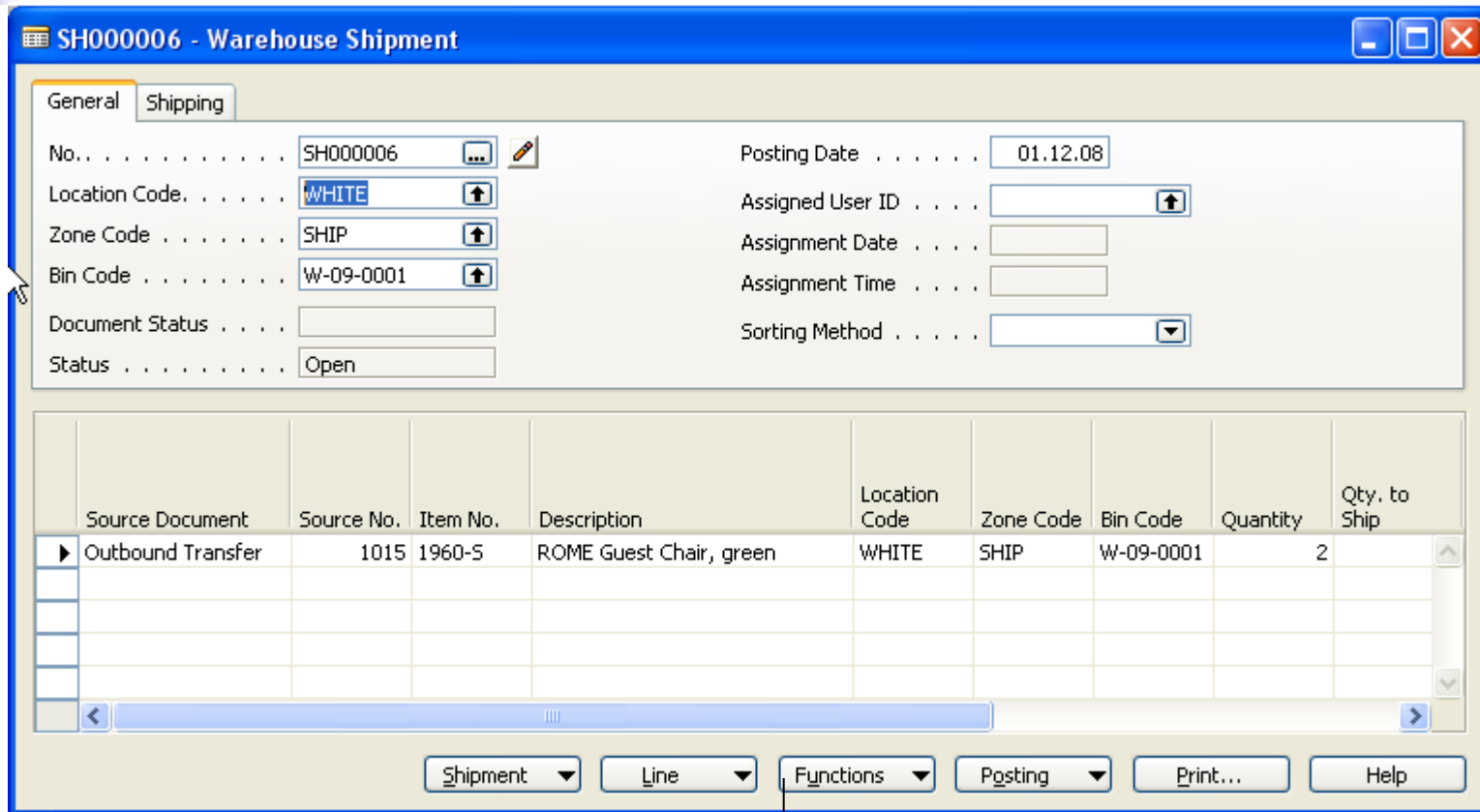

The screenshot shows the SAP 'Warehouse Shipment' window for document SH000006. The window is divided into a header section with various input fields and a table section for item details. The 'Shipping' tab is active.

Header Fields:

- No.: SH000006
- Location Code: WHITE
- Zone Code: SHIP
- Bin Code: W-09-0001
- Document Status: (empty)
- Status: Open
- Posting Date: 01.12.08
- Assigned User ID: (empty)
- Assignment Date: (empty)
- Assignment Time: (empty)
- Sorting Method: (empty)

Table:

Source Document	Source No.	Item No.	Description	Location Code	Zone Code	Bin Code	Quantity	Qty. to Ship
▶ Outbound Transfer	1015	1960-5	ROME Guest Chair, green	WHITE	SHIP	W-09-0001	2	

Footer Buttons: Shipment, Line, Functions, Posting, Print..., Help

CREATE PICK DOCUMENT

Transfer Order (using warehouse logistics)

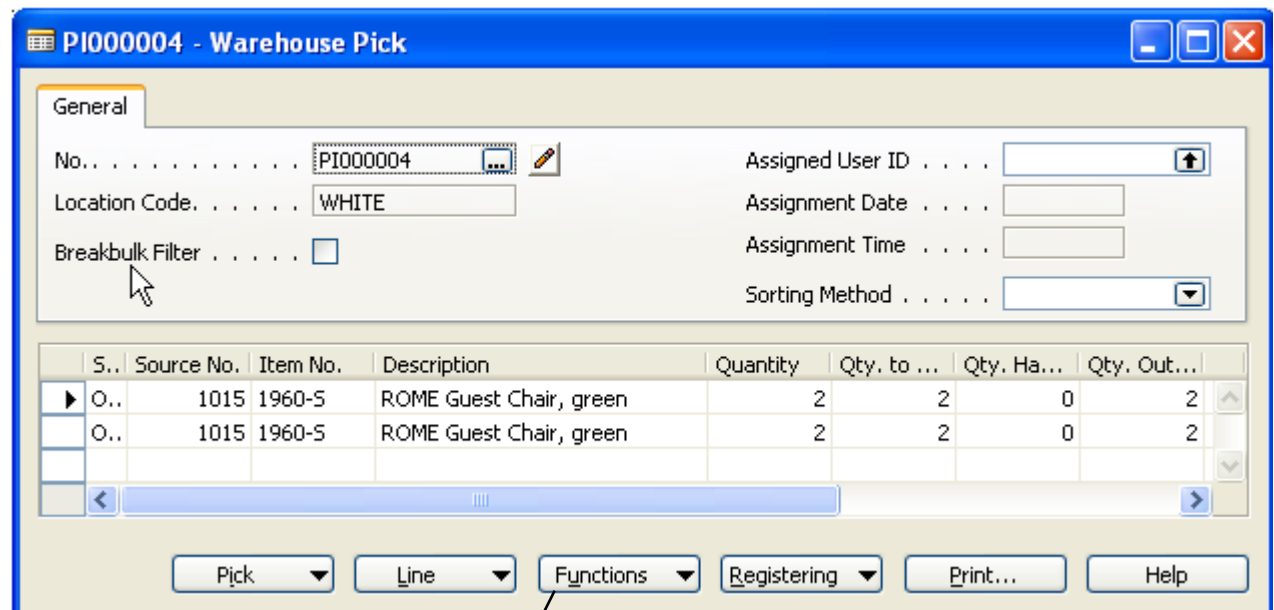
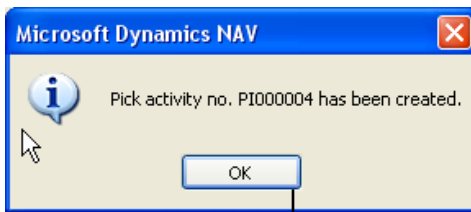

F11

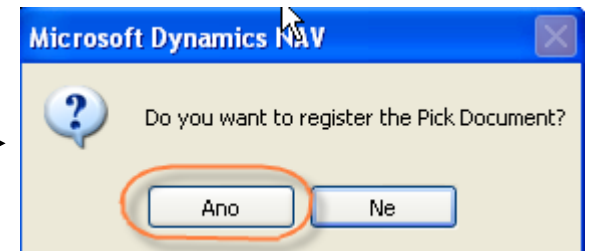

Transfer Order (using warehouse logistics)

SH000006 - Warehouse Shipment

General Shipping

No. SH000006 Posting Date 01.12.08
Location Code. WHITE Assigned User ID
Zone Code SHIP Assignment Date
Bin Code W-09-0001 Assignment Time
Document Status
Status Open Sorting Method

Source Document	Source No.	Item No.	Description	Location Code	Zone Code	Bin Code	Quantity	Qty. to Ship
▶ Outbound Transfer	1015	1960-5	ROME Guest Chair, green	WHITE	SHIP	W-09-0001	2	

Shipment Line Functions Posting Print... Help

Number of source documents posted: 1 out of a total of 1.
Ship lines have been posted.

OK

F11

Microsoft Dynamics ...

Ship
Ship and Invoice

OK Cancel

Transfer Order (using warehouse logistics)

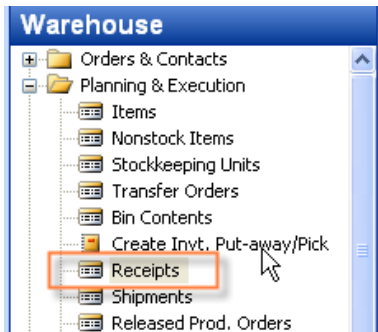

RE000008 - Warehouse Receipt

General

No. RE000008

Location Code YELLOW

Zone Code

Bin Code

Document Status

Posting Date 01.12.08

Vendor Shipment No.

Assigned User ID

Assignment Date

Assignment Time

Sorting Method

S..	Source No.	Item No.	Description	Quantity	Qty. to ...	Qty. Rec...	Qty. Out...
I...	1015	1960-S	ROME Guest Chair, green	2	2	0	2

Receipt Line Functions Posting Print... Help

GET SOURCE DOCUMENT

F11

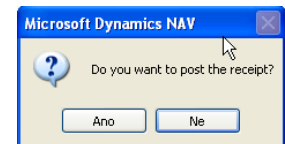

Transfer Order (using warehouse logistics)

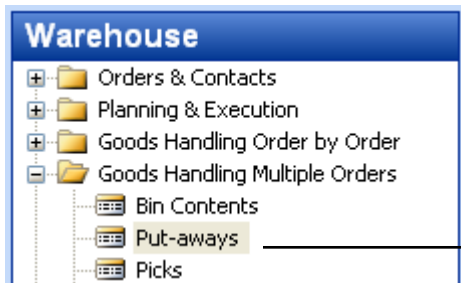

PU000006 Warehouse Put-away

General

No. PU000006

Location Code. YELLOW

Breakbulk Filter

Assigned User ID

Assignment Date

Assignment Time

Sorting Method

S..	Source No.	Item No.	Description	Quantity	Qty. to ...	Qty. Ha...	Qty. Out...
▶ I...	1015	1960-S	ROME Guest Chair, green	2	2	0	2

Put-away Line Functions Registering Print... Help

F11

Do you want to register the Put-away Document?

Ano Ne

Transfer Order (using warehouse logistics)

Item Entries

01.12.08	Transfer	Transfer Shipment	108011	WHITE	-2	-2	0
01.12.08	Transfer	Transfer Shipment	108011	OUT. LOG.	2	2	0
01.12.08	Transfer	Transfer Receipt	109007	OUT. LOG.	-2	-2	0
01.12.08	Transfer	Transfer Receipt	109007	YELLOW	2	2	2

General
Transfer-from
Transfer-to
Foreign Trade

Posted Transfer Receipt

<table style="width: 100%; border-collapse: collapse;"> <tr> <td style="width: 150px;">No.</td> <td style="border: 1px solid gray; padding: 2px;">109007</td> <td style="text-align: right; font-size: small;">✎</td> </tr> <tr> <td>Transfer-from Code . . .</td> <td style="border: 1px solid gray; padding: 2px;">WHITE</td> <td></td> </tr> <tr> <td>Transfer-to Code</td> <td style="border: 1px solid gray; padding: 2px;">YELLOW</td> <td></td> </tr> <tr> <td>In-Transit Code</td> <td style="border: 1px solid gray; padding: 2px;">OUT. LOG.</td> <td></td> </tr> </table>	No.	109007	✎	Transfer-from Code . . .	WHITE		Transfer-to Code	YELLOW		In-Transit Code	OUT. LOG.		<table style="width: 100%; border-collapse: collapse;"> <tr> <td style="width: 150px;">Transfer Order No. . . .</td> <td style="border: 1px solid gray; padding: 2px;">1015</td> </tr> <tr> <td>Transfer Order Date . . .</td> <td style="border: 1px solid gray; padding: 2px;">01.12.08</td> </tr> <tr> <td>Posting Date</td> <td style="border: 1px solid gray; padding: 2px;">01.12.08</td> </tr> <tr> <td>Department Code</td> <td style="border: 1px solid gray; padding: 2px;"></td> </tr> <tr> <td>Project Code</td> <td style="border: 1px solid gray; padding: 2px;"></td> </tr> </table>	Transfer Order No. . . .	1015	Transfer Order Date . . .	01.12.08	Posting Date	01.12.08	Department Code		Project Code	
No.	109007	✎																					
Transfer-from Code . . .	WHITE																						
Transfer-to Code	YELLOW																						
In-Transit Code	OUT. LOG.																						
Transfer Order No. . . .	1015																						
Transfer Order Date . . .	01.12.08																						
Posting Date	01.12.08																						
Department Code																							
Project Code																							

Item No.	Description	Quantity	Unit of M...
▶ 1960-5	ROME Guest Chair, green	2	PCS

Transfer Order (using warehouse logistics)

Posted Transfer Shipment

General | Transfer-from | Transfer-to | Foreign Trade

No.	<input type="text" value="108011"/>		Transfer Order No.	<input type="text" value="1015"/>
Transfer-from Code	<input type="text" value="WHITE"/>		Transfer Order Date	<input type="text" value="01.12.08"/>
Transfer-to Code	<input type="text" value="YELLOW"/>		Posting Date	<input type="text" value="01.12.08"/>
In-Transit Code	<input type="text" value="OUT. LOG."/>		Department Code	<input type="text"/>
			Project Code	<input type="text"/>

Item No.	Description	Quantity	Unit of M...	Shipping ...
▶ 1960-S	ROME Guest Chair, green	2	PCS	

Transfer Order (using warehouse logistics)

ČAS

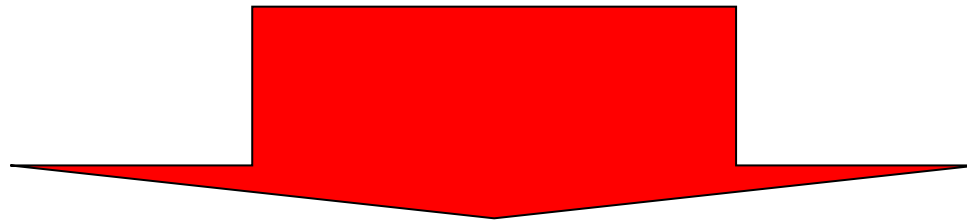
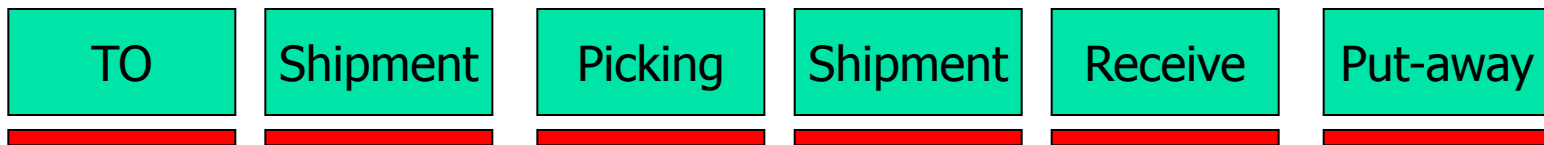

01.12.08	Transfer	Transfer Shipment	108011	WHITE	-2	-2	0
01.12.08	Transfer	Transfer Shipment	108011	OUT. LOG.	2	2	0
01.12.08	Transfer	Transfer Receipt	109007	OUT. LOG.	-2	-2	0
01.12.08	Transfer	Transfer Receipt	109007	YELLOW	2	2	2



ITEM CHARGES (how to do it)

- Nákupní objednávka č. 1 na zboží - vystavit a F11
- Nákupní objednávka č. 2 na poplatek – vystavit
- Tlačítko Řádek - > Přiřazení poplatku
- Tlačítko Funkce - > Nalezení dokumentu (příjemky z NO č.1.)
- Tlačítko Funkce-> Navrhni přiřazení (podle částky nebo rovnoměrně) a ESC
- Zaúčtovat NO č.2.
- Jít do nakoupeného zboží z NO č. 1. a 2 x Ctrl-F5-> položky ocenění – náklad je vidět v druhé položce
- Pro provádění modelového příkladu a sledování vlivu přiřazeného nákladu na cenu mějte v nastavení skladu nastaveno Automatické účtování =Ano. Pokud bude položka skladu adjustována, pak je na kartě Zboží , záložka Fakturace vidět, že je položka adjustována a hodnota je zaúčtována do hlavní knihy.

Pružnost plánování

- Za určitých okolností může být dobré vyhnout se změnám způsobeným na nákupních objednávkách při **výpočtu hlášení akce** programem. K tomuto slouží pole na řádku nákupní objednávky Pružnost plánování při výpočtu hlášení akce programem

T..	Číslo	Pružnost plánování	Popis	Kód lokace	Množství	Rezervo...	Kód
▶ Z..	L0001	Bez omezení	Nafta motorová	MAT	2 000		L
Ú..	66810	Bez omezení	Ostatné finančné výnosy		1		

Bez omezení nebo Žádné

Pružnost plánování

Naplánovaná Nákupní objednávka na základě Prodejní objednávky na 40 ks

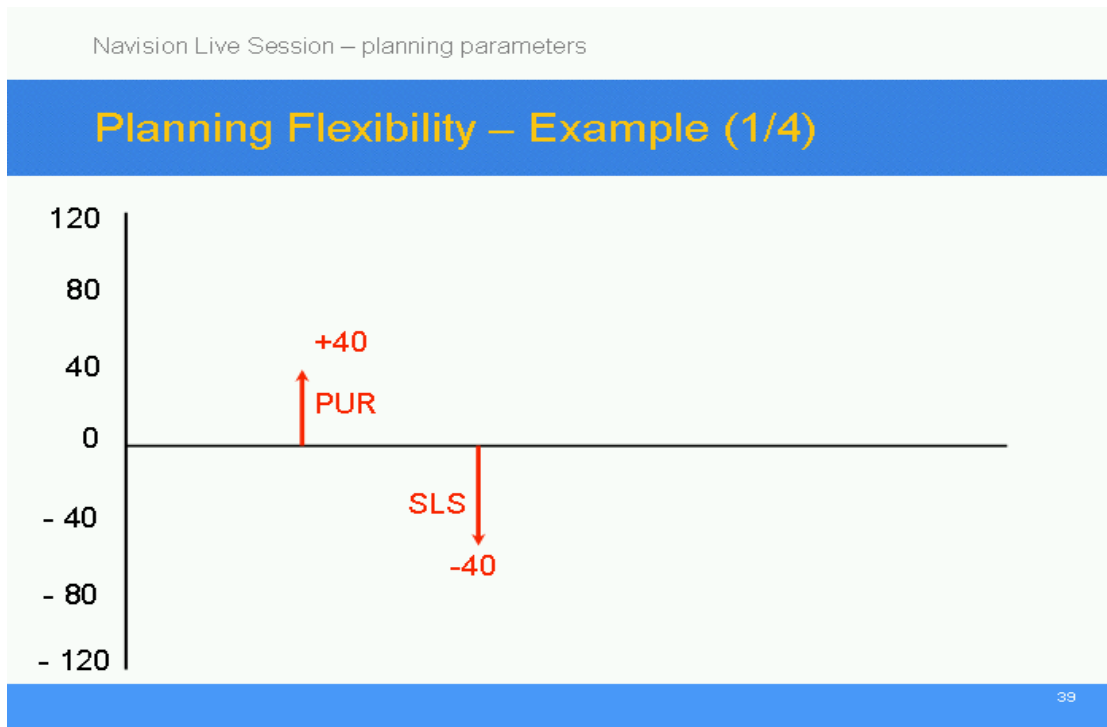

Pružnost plánování

Prodejní objednávka na 40 ks se změní na 80 ks (akce)

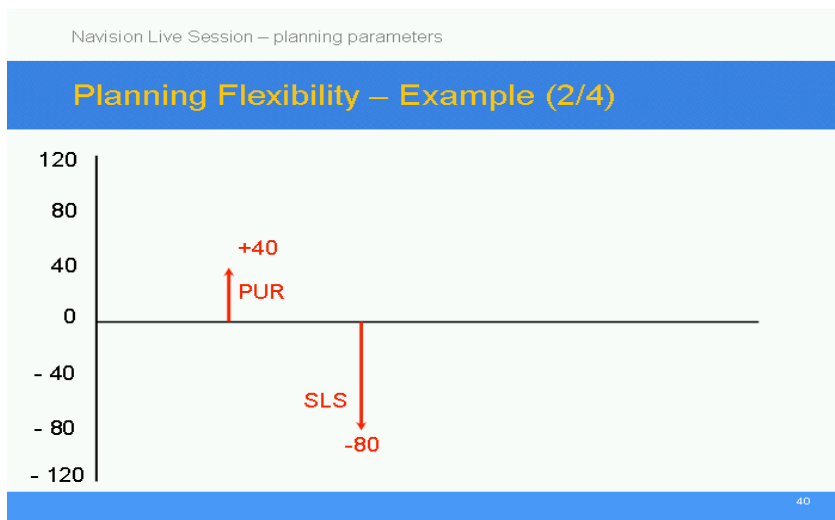

Pružnost plánování

Prodejní objednávka na 40 ks se změní na 80 ks (akce)

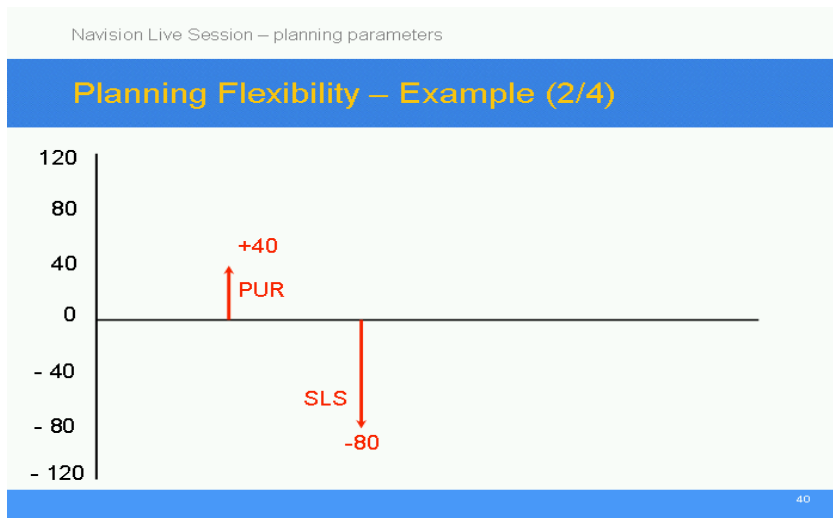

Pružnost plánování

Nákupní objednávka (řádky) zareaguje na výpočet akce a změní se na 80 ks (pokud Pružnost plánování je **Bez omezení**)

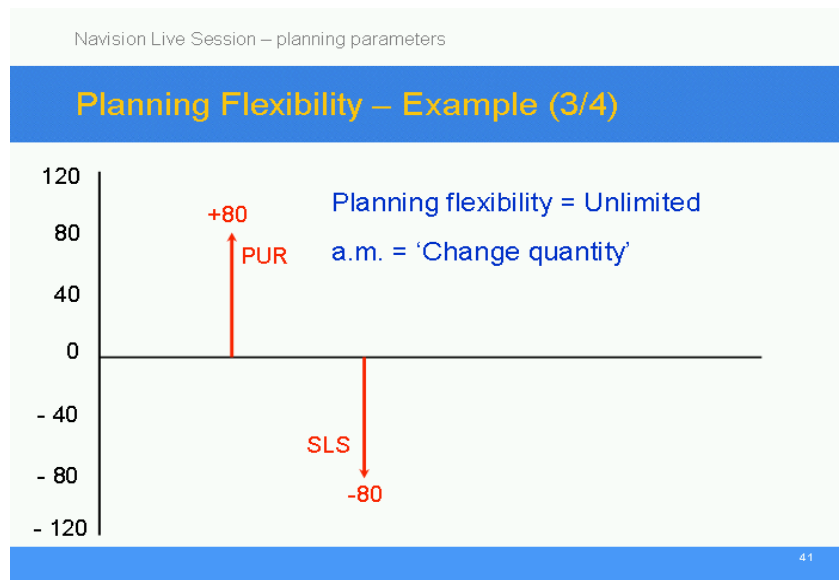

Pružnost plánování

Vytvoří se nová Nákupní objednávka (řádky) a původní NO není změněna.
Obě NO pokrývají změněný požadavek na 80 ks
(pokud Pružnost plánování je **Žádné**)

Navision Live Session – planning parameters

Planning Flexibility – Example (4/4)

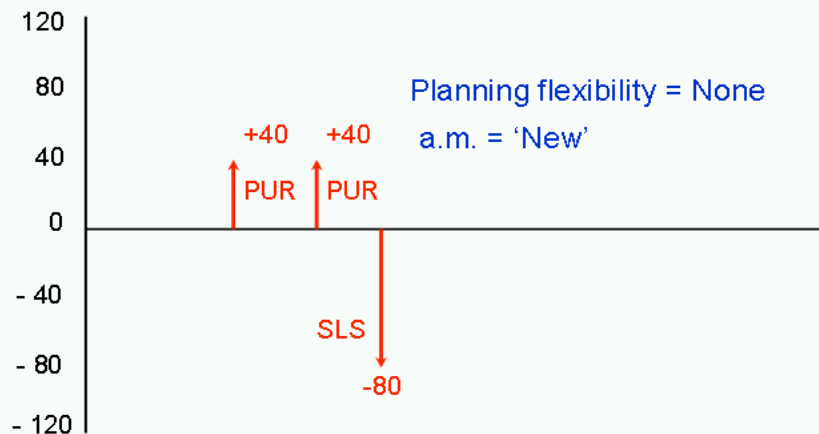

Warranty Date Formula and Expiration Date

The screenshot displays the SAP Item Card for 'ACYLPIRIN Acylpirin'. The 'Item Tracking' tab is active, showing the following settings:

- Item Tracking Code: LOTALL
- Serial Nos.: (empty)
- Lot Nos.: (empty)
- Expiration Calculation: 1M

The 'Item Tracking Codes' window is also shown, listing the following codes and descriptions:

Code	Description
FREEENTRY	Free entry of tracking
▶ LOTALL	Lot specific tracking
LOTALLEXP	Lot specific tracking, manual Expiration
LOTSNSA...	Lot specific SN Sales Tracking
SNALL	SN specific tracking
SNSALES	SN Sales tracking

Warranty Date Formula and Expiration Date

LOTALL Lot specific tracking - Item Tracking

General Serial No. Lot No. **Misc.**

Lot Specific Tracking

	Inbound	Outbound
Lot No. Info. Must Exist . . .	<input type="checkbox"/>	<input type="checkbox"/>
Lot Purchase Tracking. . .	<input checked="" type="checkbox"/>	<input checked="" type="checkbox"/>
Lot Sales Tracking	<input checked="" type="checkbox"/>	<input checked="" type="checkbox"/>
Lot Positive Adjmt. Trac...	<input checked="" type="checkbox"/>	<input checked="" type="checkbox"/>
Lot Negative Adjmt. Tra...	<input checked="" type="checkbox"/>	<input checked="" type="checkbox"/>
Lot Manufacturing Tracki...	<input checked="" type="checkbox"/>	<input checked="" type="checkbox"/>
Lot Warehouse Tracking .	<input type="checkbox"/>	
Lot Transfer Tracking . . .	<input checked="" type="checkbox"/>	

Help

LOTALL Lot specific tracking - Item Tracking

General Serial No. Lot No. **Misc.**

Warranty Date Formula . . .

Man. Warranty Date Ent...

Man. Expir. Date Entry R...

Strict Expiration Posting . .

Help

Warranty Date Formula and Expiration Date

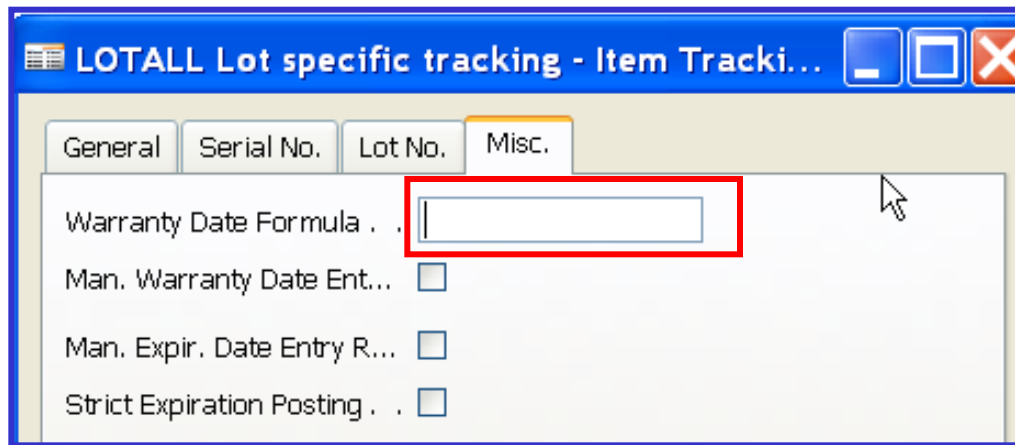

The screenshot shows a software window titled "LOTALL Lot specific tracking - Item Tracki...". The window has a blue title bar with standard Windows window controls (minimize, maximize, close). Below the title bar, there are four tabs: "General", "Serial No.", "Lot No.", and "Misc.". The "Misc." tab is selected and highlighted with a yellow border. Inside the "Misc." tab, there are four fields:

- "Warranty Date Formula . . ." with a text input field that is highlighted by a red rectangular box.
- "Man. Warranty Date Ent..." with an unchecked checkbox.
- "Man. Expir. Date Entry R..." with an unchecked checkbox.
- "Strict Expiration Posting . ." with an unchecked checkbox.

A mouse cursor is visible over the "Warranty Date Formula" field.

In the Warranty Date Formula field you can enter a formula that calculates the warranty date on the item tracking line. E.g. =14 D

If the Man. Warranty Date Entry Required field contains a check mark, the formula will be ignored and you will have to manually enter a date on the item tracking line.

If this field is blank, no warranty date will be referenced or required for the item tracking entries.

Warranty Date Formula and Expiration Date

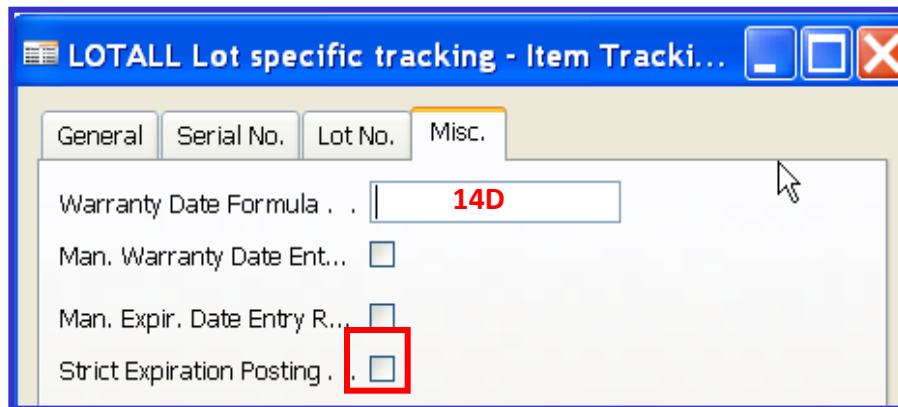

The screenshot shows a software window titled "LOTALL Lot specific tracking - Item Tracki...". It has four tabs: "General", "Serial No.", "Lot No.", and "Misc.". The "Misc." tab is active. The "Warranty Date Formula" field contains the text "14D". Below it are three checkboxes: "Man. Warranty Date Ent...", "Man. Expir. Date Entry R...", and "Strict Expiration Posting". The "Strict Expiration Posting" checkbox is checked and is highlighted with a red rectangular box.

A check mark in this field indicates that an expiration date assigned to the item tracking number as it entered inventory must be respected when it exits inventory.

This field is mostly used together with the Man. Expir. Date Entry Req'd. field, which gives a system message if you forget to define the expiration date upon entering inventory.

If you do not checkmark that field, the strict posting principle will use work date as expiration date on the inbound item tracking line in question.

Warranty Date Formula and Expiration Date

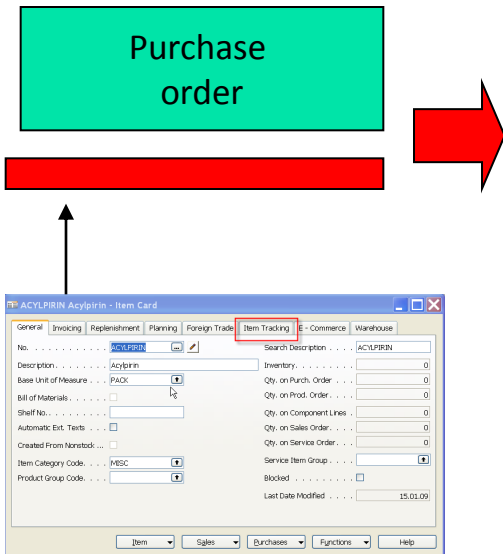

ACYLPIRIN Acylpirin - Item Tracking Lines

	Purchase L...	Item Track...	Undefined
Quantity	10	10	
Qty. to Handle	10	10	
Qty. to Invoice	10	10	
Item Tracking Code . . .	LOTALL	Lot specific tracking	

Availability, Serial No.	Serial No.	Availability, Lot No.	Lot No.	Warranty Date	Expiration Date	Location Code	Quantity (Base)	Qty. to Handle (Base)	Qty. to Invoice (Base)
			ACYL_01		13.12.08	BLUE	10	10	10

ACYLPIRIN ACYL_01 Acilpiriny Bayer 100 m...

General Inventory

Item No. ACYLPIRIN

Variant Code

Lot No. ACYL_01

Description Acilpiriny Bayer 100 mg

Test Quality Good

Certificate Number ACYL03948547

Blocked

Navigate Lot No. Help

F11 →

Warranty Date Formula and Expiration Date

Posting Date	Document Type	Entry Type	Document No.	Item No.	Description	Expiration Date	Lot No.	Location Code	Quantity	Invoiced Quantity	Remaining Quantity	Sales # (Actual)
20.11.08	Purchas...	Purch...	107037	ACYLPIRIN		13.12.08	ACYL_01	BLUE	10	10	10	

NO1

Lot No.	ACYL_01
Warranty Date	04.12.08
Expiration Date	13.12.08
Item Tracking	Lot No.



Ctrl-F8 to see Warranty date

Posting Date	Document Type	Entry Type	Document No.	Item No.	Description	Expiration Date	Lot No.	Location Code	Quantity	Invoiced Quantity	Remaining Quantity
15.01.09	Purchas...	Purch...	107038	ACYLPIRIN		20.01.09	ACYL_02	BLUE	20	20	20

NO2

Warranty Date Formula and Expiration Date

Selling 11 packs of Acylpirin

	Sales Line	Item Track...	Undefined
Quantity	<input type="text" value="11"/>	<input type="text" value="11"/>	<input type="text"/>
Qty. to Handle	<input type="text" value="11"/>	<input type="text" value="11"/>	<input type="text"/>
Qty. to Invoice	<input type="text" value="11"/>	<input type="text" value="11"/>	<input type="text"/>
Item Tracking Code	<input type="text" value="LOTALL"/>	<input type="text" value="Lot specific tracking"/>	

	Availability, Serial No.	Serial No.	Availability, Lot No.	Lot No.	Warranty Date	Expiration Date	Location Code	Quantity (Base)	Qty. to Handle (Base)	Qty. to Invoice (Base)
				ACYL_01		13.12.08	BLUE	10	10	10
▶				ACYL_02		20.01.09	BLUE	1	1	1