

Operation Management (OM)

Introduction

Ing.J.Skorkovský, CSc,
Department of Corporate Economy
FACULTY OF ECONOMICS AND ADMINISTRATION
Masaryk University Brno
Czech Republic

What is going on ?

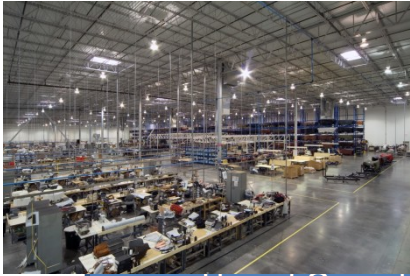

Use of Operations Management (OM) in external environment
(main target)



General knowledge of OM methods acquired at university and long-standing experiences

$$= \frac{\sum_{x_1} f_1(x_1) f_2(x_2, x_1)}{\sum_{x_1} f_1(x_1) \sum_{x_2} f_2(x_2, x_1)}$$

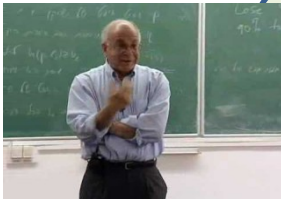
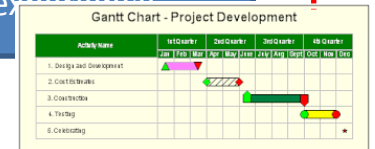

Knowledge of methods and experience from research and literature - **teachers**



Knowledge of methods and experience from outside world – **consultants, managers, ...**

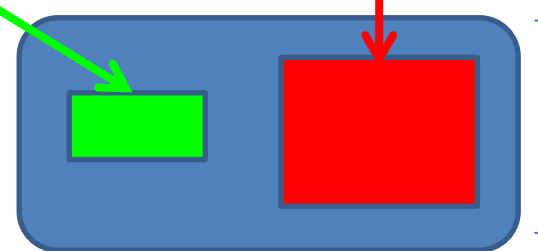
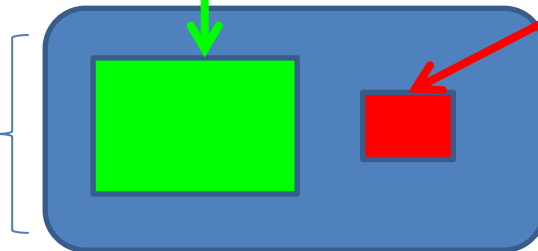

Extent of knowledge

Extent of knowledge



Synergy and put OM into practice

OM all around us

OM is the management of all processes used to design, supply, produce, and deliver valuable goods and services to customers



IN

Processing-transformation

Out

TQM = Total Quality Management

ERP: Logistics, Transportation

MRP, JIT, APS, Lean Manufacturing, Little's law

ERP: Marketing, Selling, Invoicing, Payment,....

Some OM methods

- Theory of Constraints
- Balanced Scorecard
- Project Management methods (Critical Chain, SCRUM,...)
- Material Requirement Planning (MRP) and Just-in-Time
- Advanced Planning and Scheduling (APS)
- Six Sigma – quality management
- Boston, SWOT and Magic Quadrant Matrices
- Little's Law (relations between WIP, Throughput and Cycle time)
- Linear programming - optimisation
- Yield Management
- Kepner-Tregoe (support of decision making)
- Decision trees

Some tools which have to be used

- **ERP**-Enterprise Resource Planning (MS Dynamics NAV)
 - Basic installation, handling and setup
 - Inventory – Items – Transports –Availability of components
 - Purchase –dealing with Suppliers (**SCM**)
 - Selling – dealing with Customers
 - Payment – bank operations
 - Accounting basics
 - **CRM**- **C**ustomer **R**elationship **M**anagement
 - Manufacturing – Planning and Shop Floor Control
 - Cost management

Controlling processes in Supply Chain Management (SCM)

		Supply	Production	Orders	
Planning levels	Strategic	← Operation Strategies and Innovations , R&D →			Demand Planning
	Tactical	Forecasts, Blank Orders	Long term planning	Marketing	
	Operational	Logistic operations	Routing control, TQM	Packaging , Transportation	
	Operational	MRP, Replenishment	MRP_II ; JIT, Capacities	Cash flow	

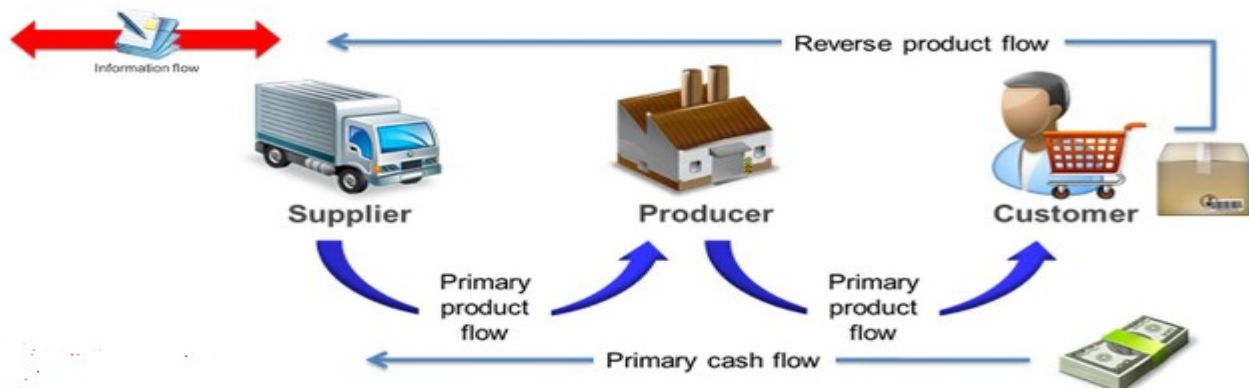

Used abbreviations : R&D –Research and Development; TQM-Total Quality Management; JIT- Just –In-Time; MRP_II-Manufacturing and Resource Planning

Used abbreviations (slide number 3) : ERP - Enterprise Resource Planning ; APS – Advanced Planning and Scheduling

Deming cycle (based on periodicity)

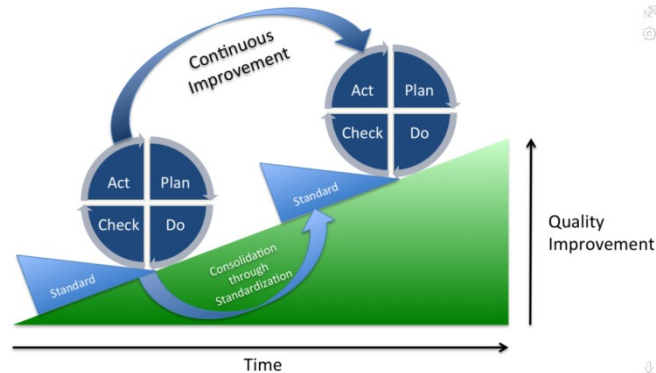

Plan: Define the problem to be addressed, collect relevant data, and ascertain the **problem's root cause** (e.g. by use of TOC)

Do: Develop and implement a solution; decide upon a measurement to gauge its effectiveness.

Check: Confirm the results through before-and-after data comparison.

Act: Document the results, inform others about process changes, and make recommendations for the problem to be addressed in the next PDCA cycle.

Another angle of view



This will be modified in following **South African** project show (use of **Balanced Score Card**)

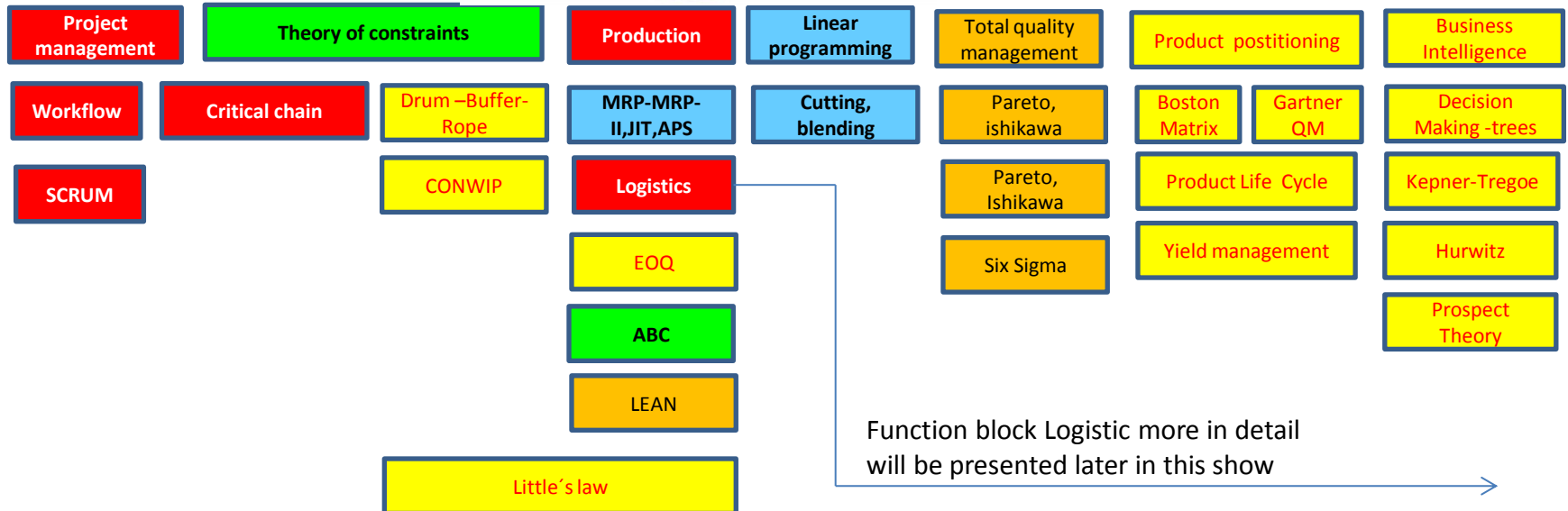

Another angle of view

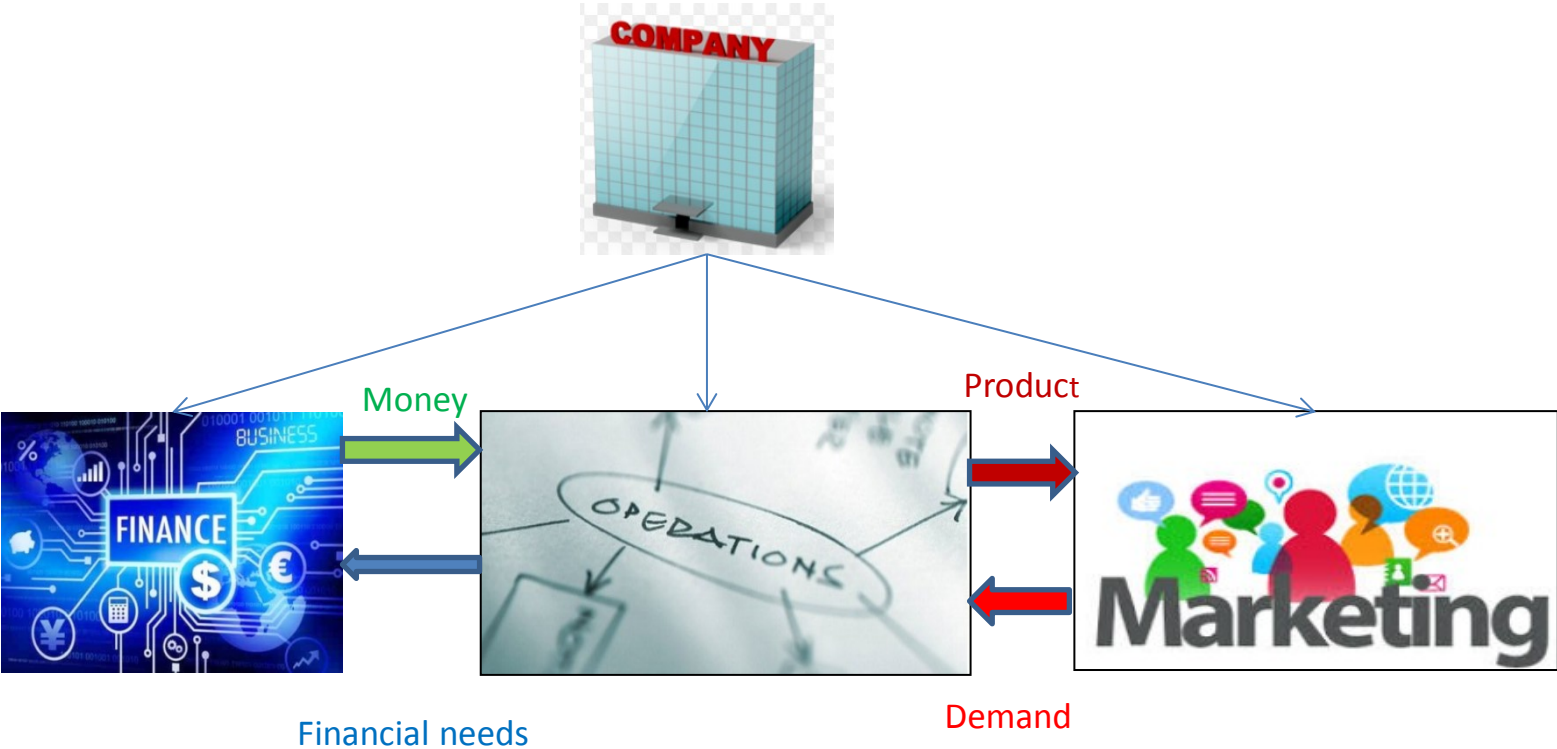

Operations

See next slide

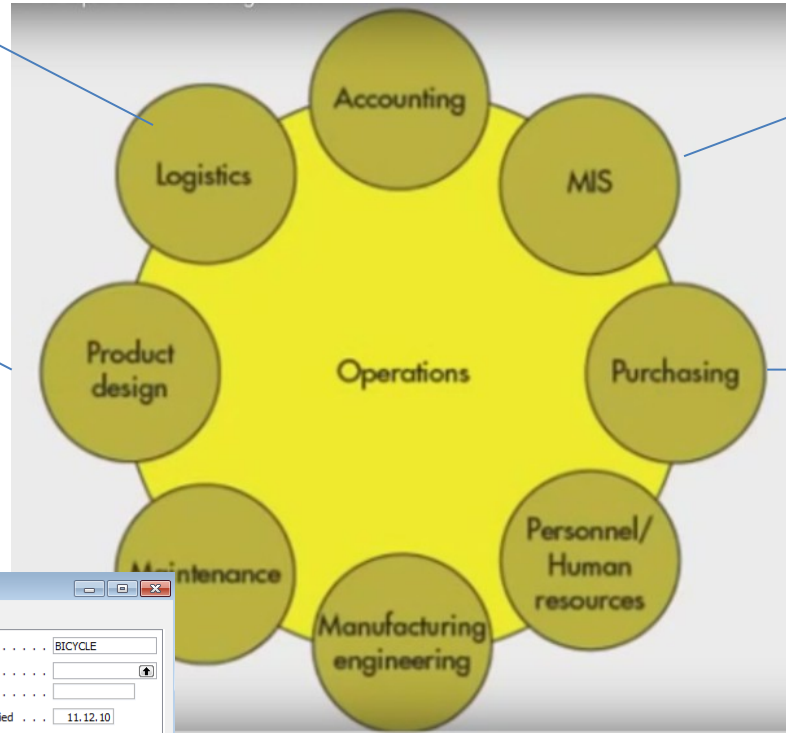

Manufacturing

- Product Design
 - Items
 - Production BOM
 - Routings
 - Families
 - Exchange Production BOM Item
 - Delete Expired Components
 - Calculate Low-Level Code
- Reports
- Capacities
- Planning
- Execution
- Costing

1000 Bicycle - Production BOM

General

No. 1000 Search Name BICYCLE

Description Bicycle Version Nos.

Unit of Measure Code PCS Active Version.

Status Certified Last Date Modified 11.12.10

Type	No.	Description	Quantity	Unit of Measu...	Scrap...	Routing Li...
Item	1000	Front Wheel	1	PCS	0	
Item	1200	Back Wheel	1	PCS	0	
Item	1300	Chain Assy	1	PCS	0	
Item	1400	Mudguard front	1	PCS	0	
Item	1450	Mudguard back	1	PCS	0	
Item	1500	Lamp	1	PCS	0	
Item	1600	Bell	1	PCS	0	
Item	1700	Brake	1	PCS	0	
Item	1800	Handlebars	1	PCS	0	
Item	1850	Saddle	1	PCS	0	
Item	1900	Frame	1	PCS	0	

Prod. BOM Component Functions Help

Bill of material

Microsoft Dynamics NAV 2009 R2

Version W1 6.0 R2 (6.00.32012)

Copyright (C) 2010 Microsoft. All rights reserved.

This product is licensed to:
4805500
NAVERTICA a.s.
Sumavska 15

Brno 602 00

[Check your license information](#)
Warning: This computer program is protected by copyright law and international treaties. Unauthorized reproduction or distribution of this program, or any portion of it, may result in severe civil and criminal penalties, and will be prosecuted to the maximum extent possible under the law.

Purchase

- Planning
 - Items
 - Vendors
 - Requisition Worksheets
 - Recurring Req. Worksheet
 - Order Planning
 - Production Forecasts
 - Purchase Orders
 - Sales Orders
 - Blanket Sales Orders
 - Planned Production Orders
 - Firm Planned Prod. Orders
 - Transfer Orders
- Reports
- Documents
- Setup
- Order Processing
- Inventory & Costing
- Analysis & Reporting
- History
- Setup

Function block Logistic-simplified

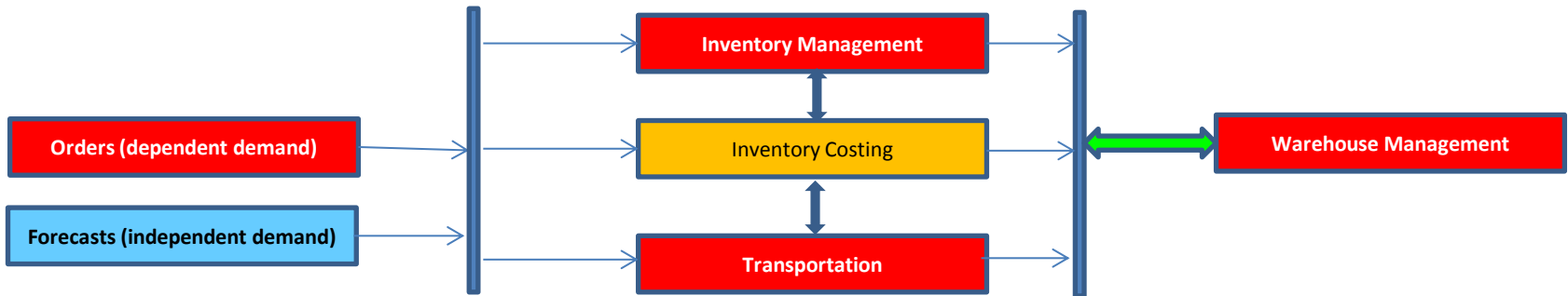

Will be part of our course regarding ERP system MS Dynamics NAV

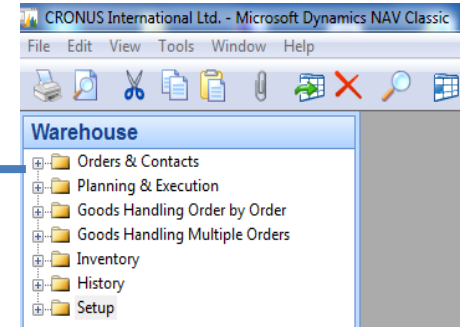
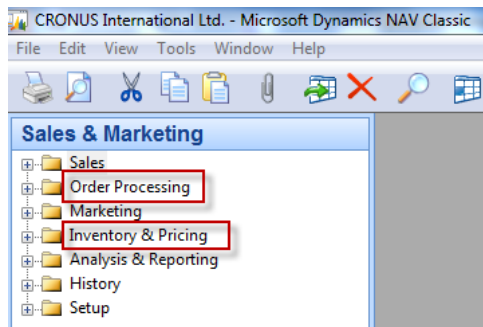

Procedures-simplified

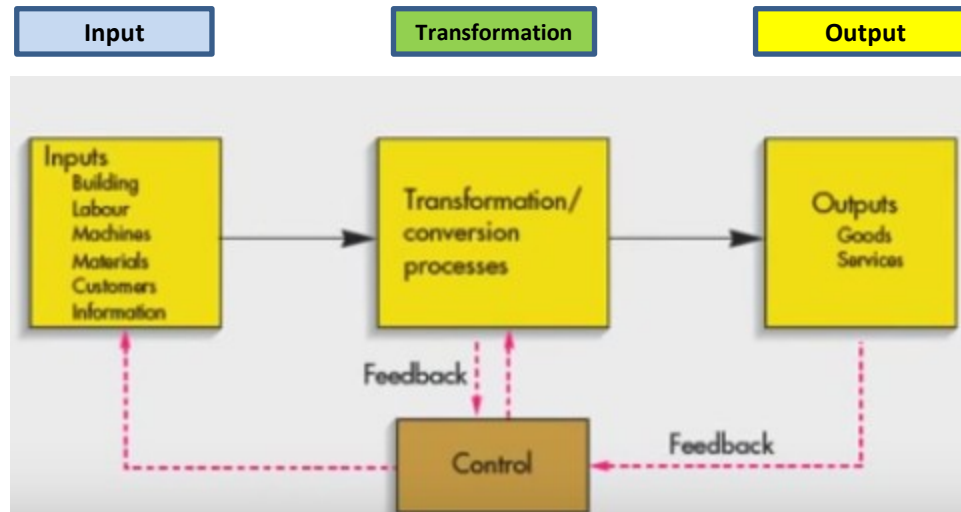

} Color agenda used later

Processing

(not organised set of processes, will be presented also as a introduction to project management PWP presentation later)

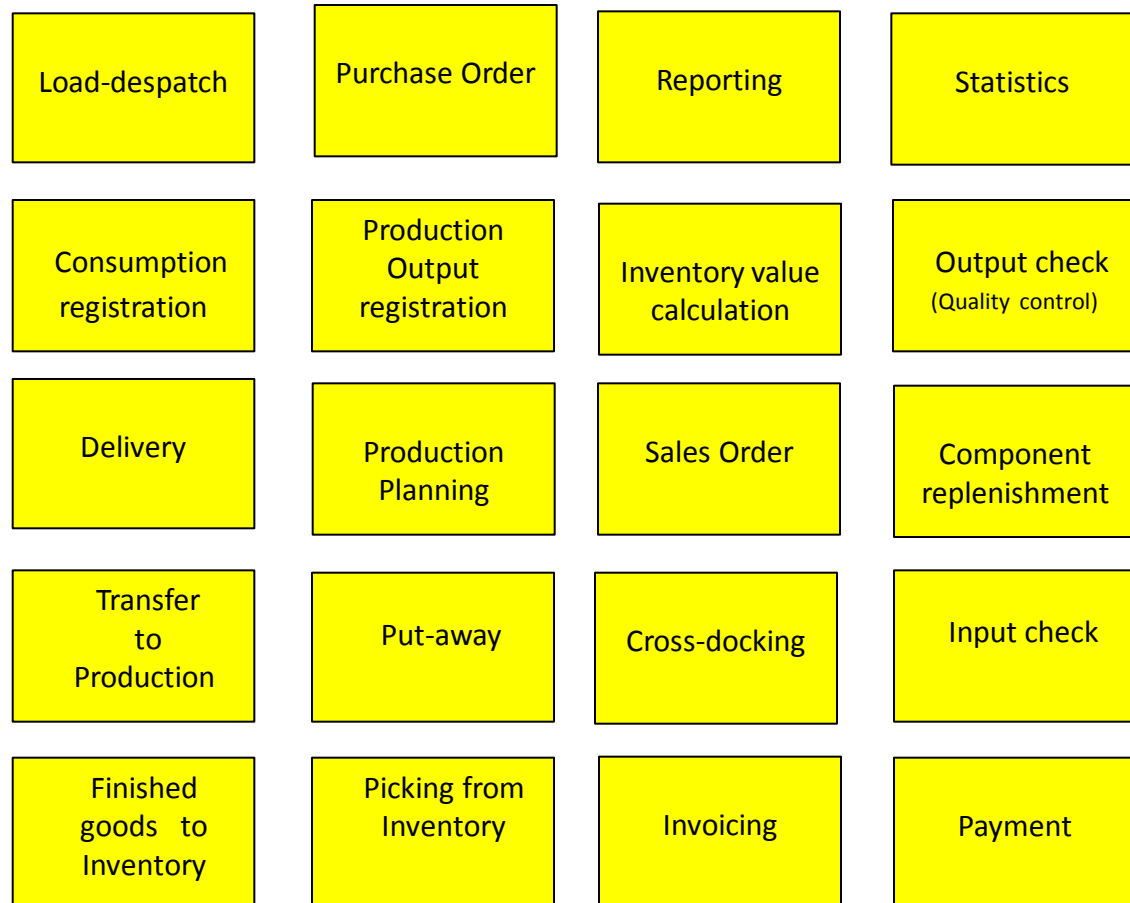

Your main task (to organize processes based on business logic)

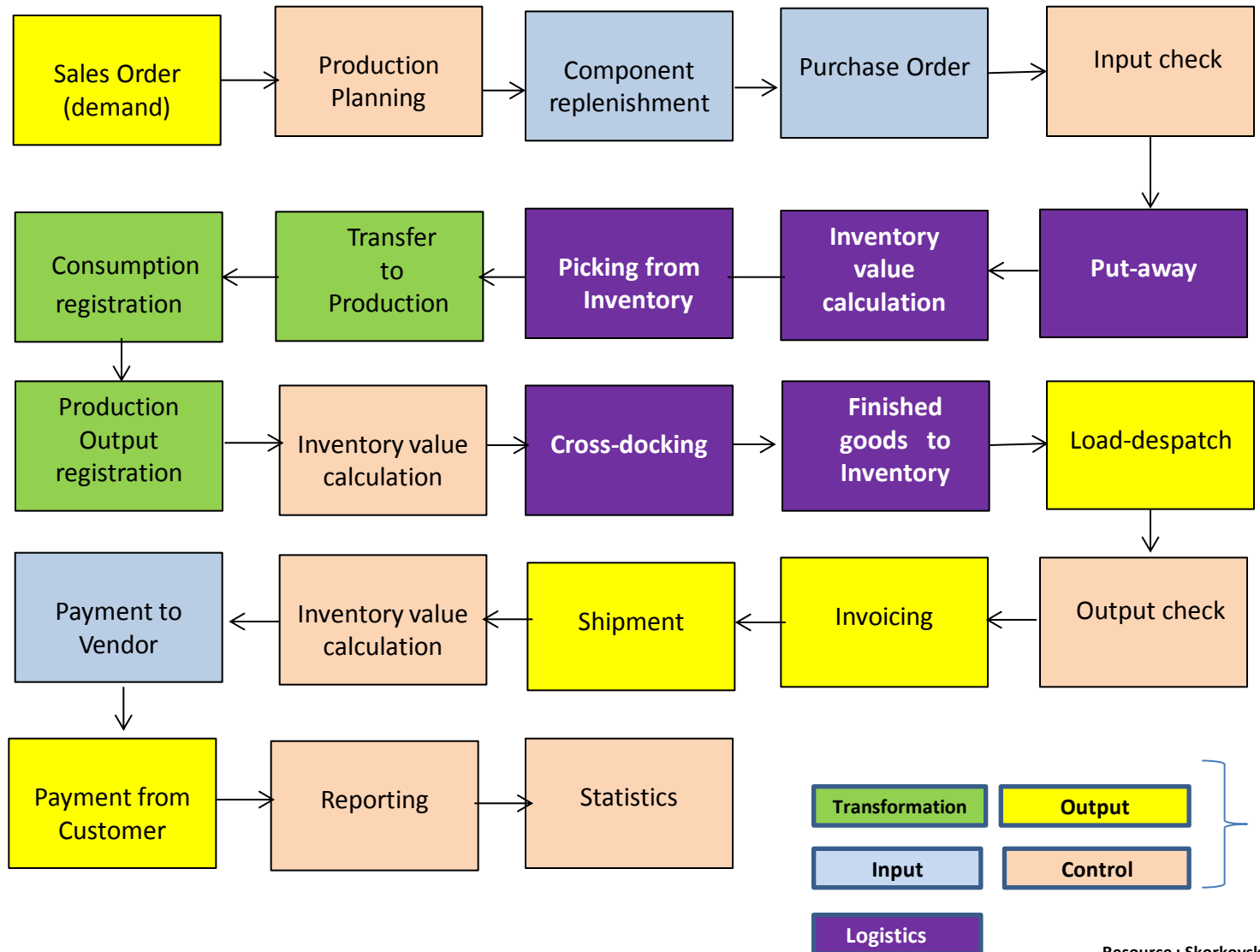

Your main task (possible problems, bottlenecks, undesirable effects..)

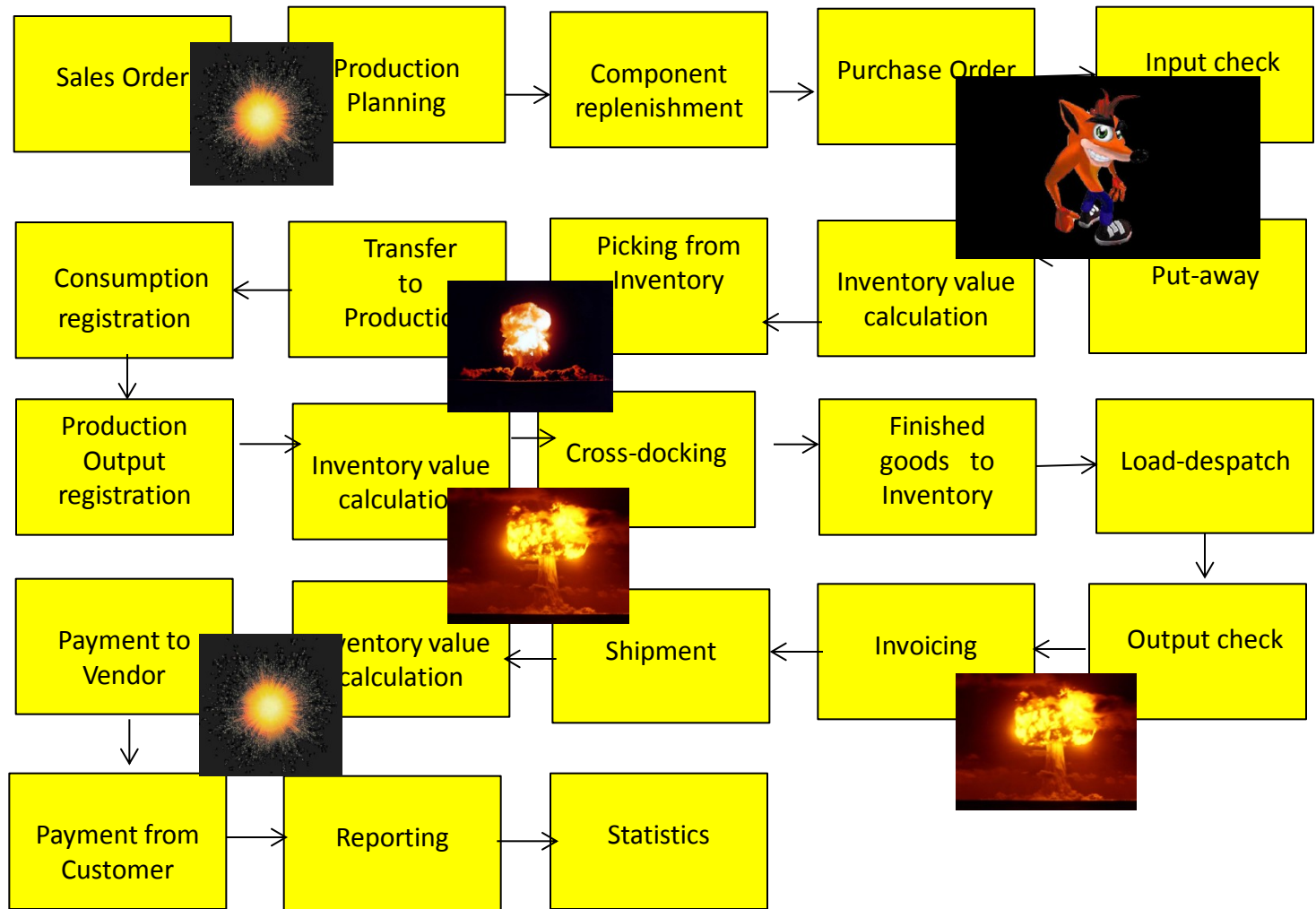

Application of TOC ->thinking tools->Current Reality Tree – first stage

Your main task

(Search - **HOW** ??? Measure impacts -**HOW** ??? and Destroy - **HOW** ???)

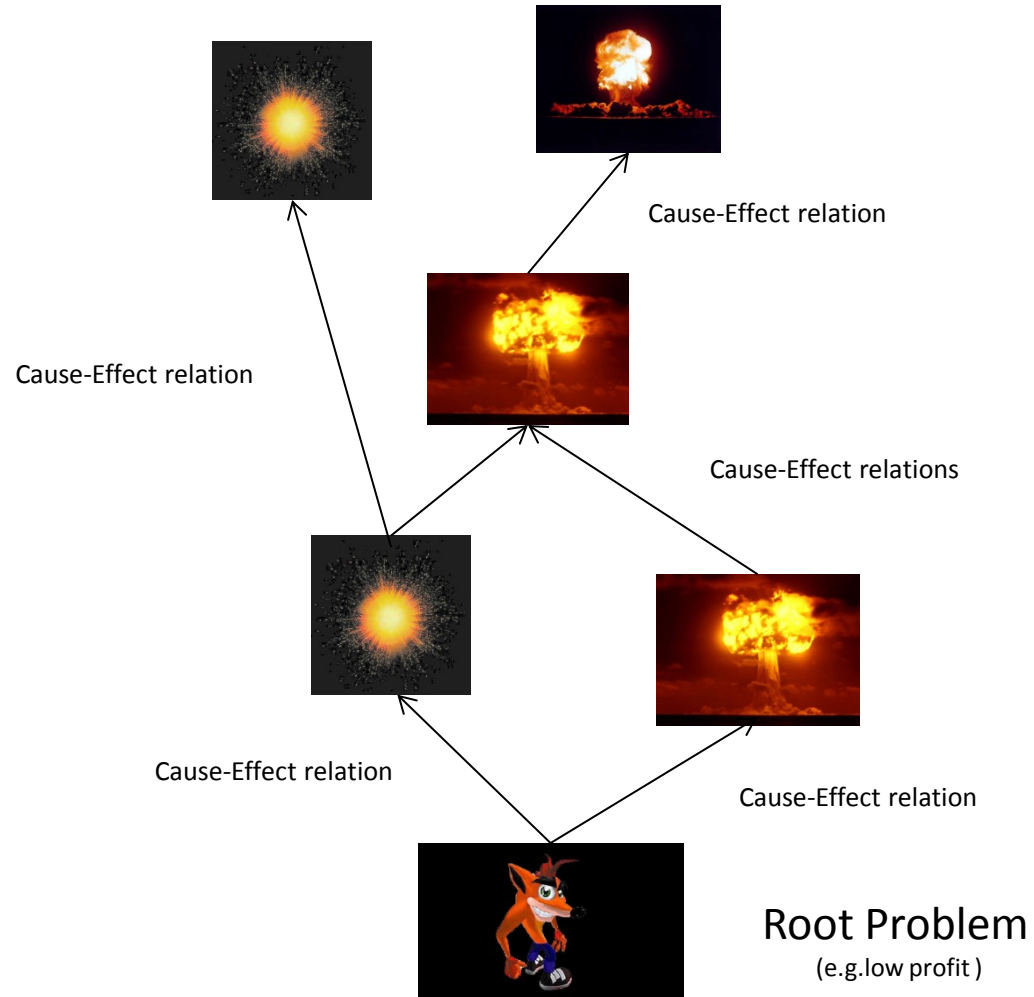

Basic problem I. (one of many)

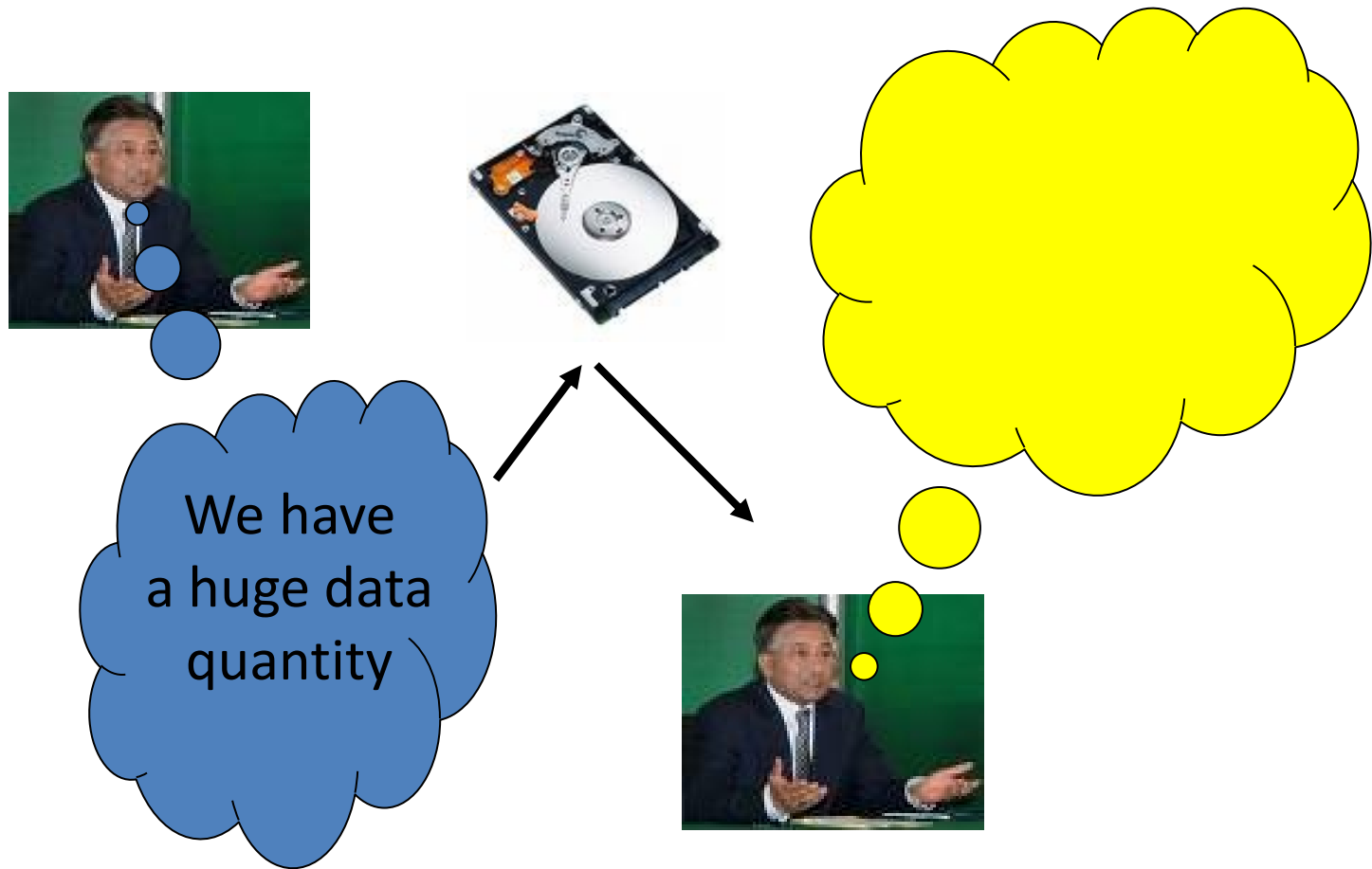

Moore's law is the observation that the number of transistors in a dense integrated circuits doubles approximately every two years – so -> capacity of memory is going up

Big data and analysis problem

In test and measurement applications, engineers and scientists can collect vast amounts of data every second of every day.

- For **every second** that the Large Hadron Collider at CERN runs an experiment, the instrument can generate 40 terabytes of data.
- For **every 30 minutes** that a Boeing jet engine runs, the system creates 10 terabytes of operations information.
- For a single journey across the Atlantic Ocean, a four-engine jumbo jet can create 640 terabytes of data.
- Multiply that by the more than 25,000 flights flown each day, and you get an understanding of the enormous amount of data that exists (Rogers, 2011). **That's "Big Data."**

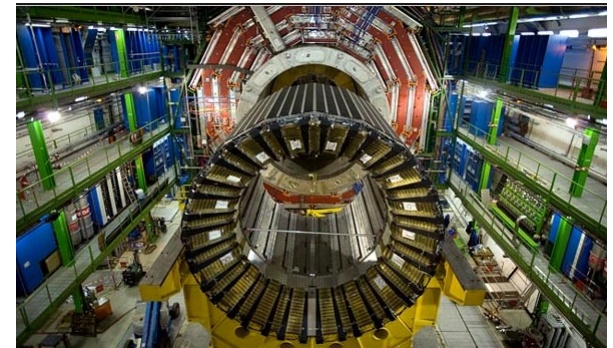

* Basic problem II. (we need reliable data)

To solve it we should use finite capacity scheduling (APS)- will be presented later

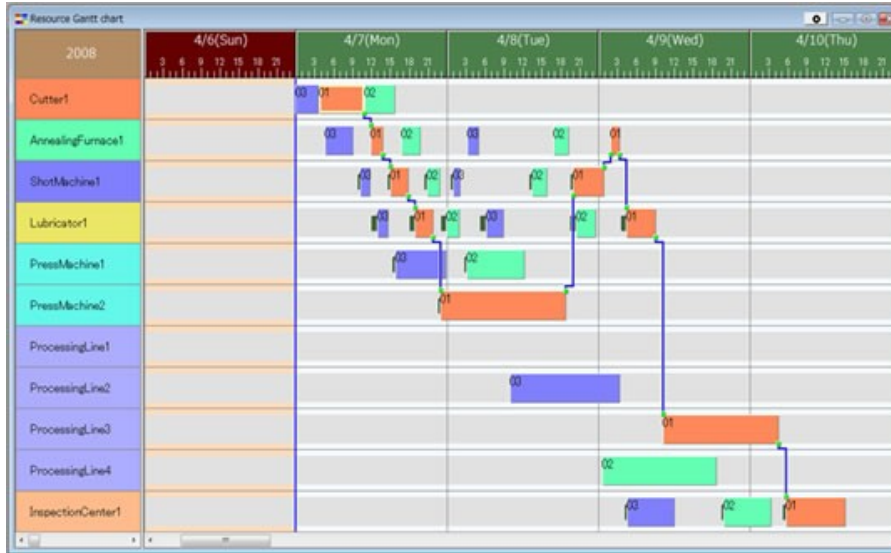

$$T1 + T2 = X$$

$$Opt = \text{Min}(X)$$

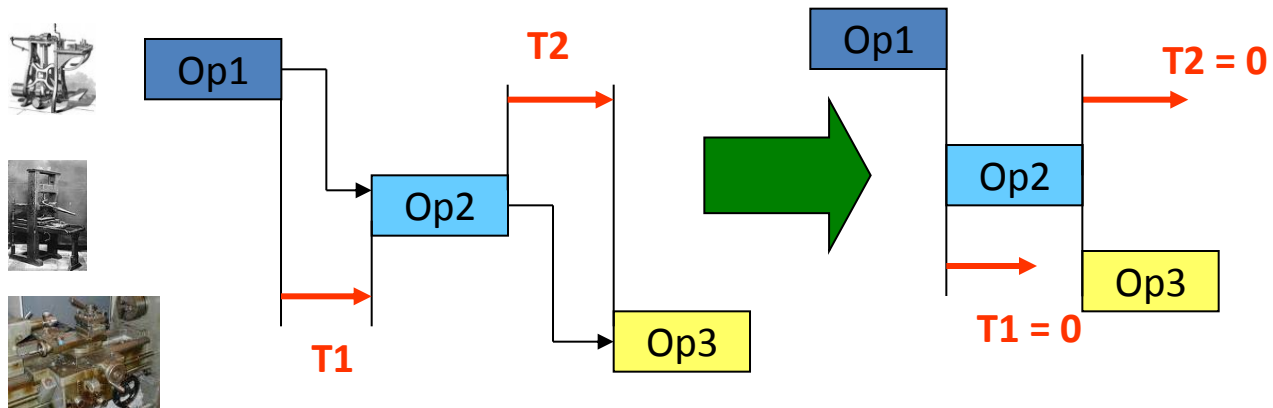

Basic problem III.

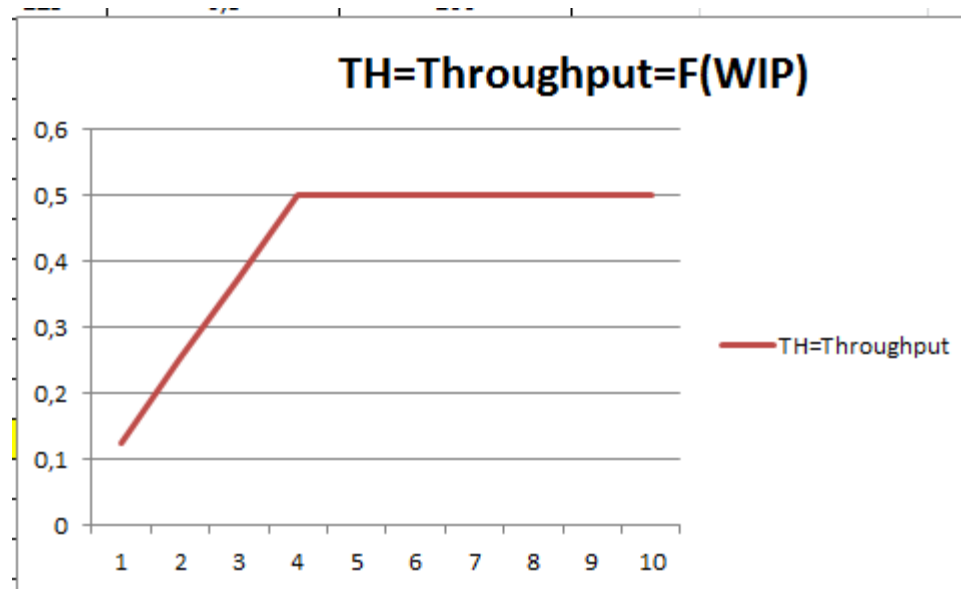

Will be explained in Little's law presentation . **WIP** = **W**ork **I**n **P**rogress

Basic problem IV.

Black

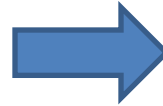

White



White

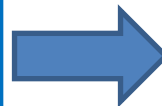

Black



(Black ->White, Setup time=60 minut)

(White->Black, Setup time = 20 minut)

Basic problem V-I. (availability of components)

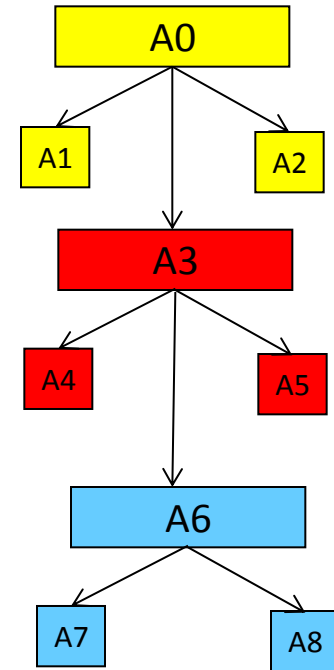
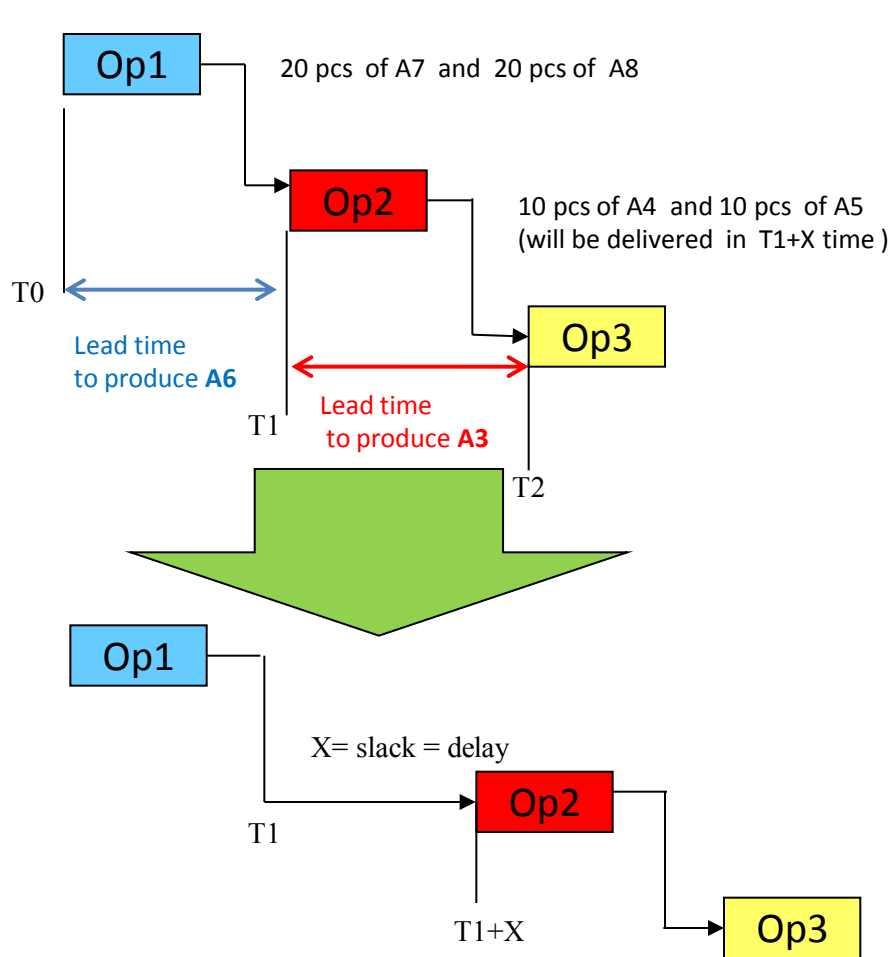

Bill Of Material=BOM

For sake of simplicity we did not mention components A1 and A2 and possible delays having cause in delivery times of bad quality !!!
 Same with capacities of machines allocated to OP1-OP2-OP3 (sudden breakdowns)

Basic problem V-II. (availability of components)

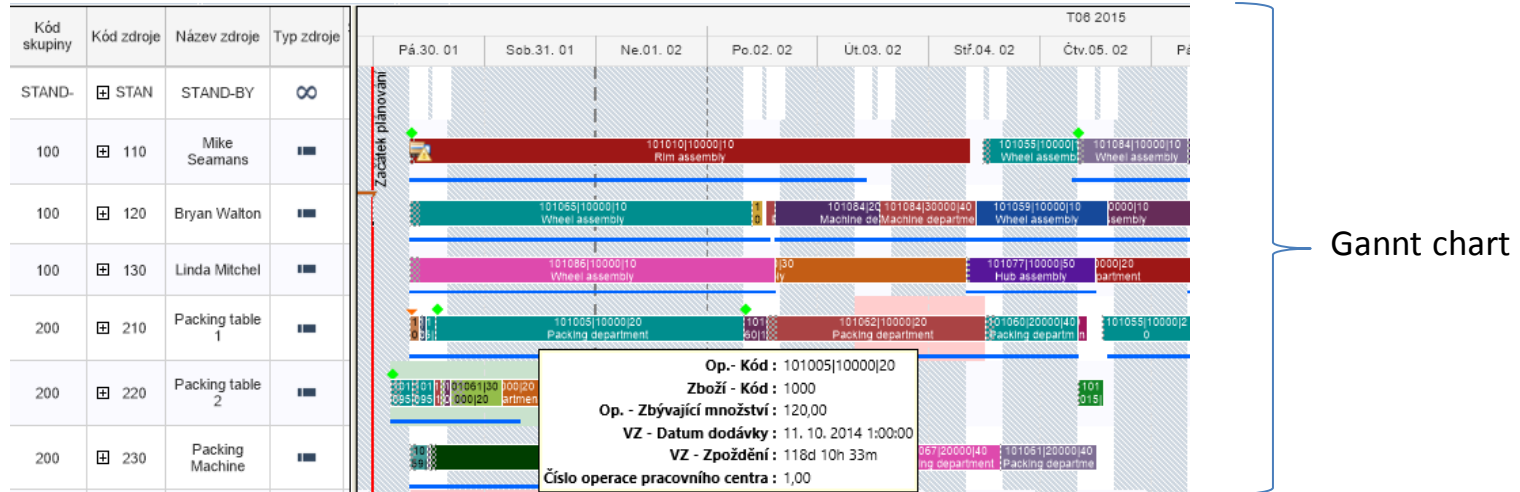

Prod. Order Routing

Type to filter (F3) Prod. Order No. Filter: Firm Planned • 101005 • 10000 • 10

Operati... No.	Type	No.	Description	Starting Date-Time	Ending Date-Time	Setup Time	Run Time	Material Fixed Date
10	Work Center	100	Wheel assembly	18. 8. 2014 14:41	22. 8. 2014 8:31	110	12	23. 8. 2014 0:00
20	Work Center	200	Packing department	27. 8. 2014 8:31	1. 9. 2014 14:46	15	15	10. 9. 2014 0:00
30	Work Center	300	Painting department	1. 9. 2014 14:46	4. 9. 2014 10:46	10	20	
40	Work Center	400	Machine department	4. 9. 2014 11:11	5. 9. 2014 12:21	10	8	

APS result ->18.8.->23.8. a 27.8.->10.9

Basic problem VI-I. (over budget)

2012 - Budget

General Filters Options

Budget Name 2012 ↑

Show as Lines G/L Account ↑

Show as Columns Period ↑

Code	Name	Budgeted Amount	26.03.12	02.04.12
8100	Building Maintenance Expenses			
8110	Cleaning	1 160,00	1 000,00	
8120	Electricity and Heating	1 120,00	1 000,00	
8130	Repairs and Maintenance	1 160,00	1 000,00	
8190	Total Bldg. Maint. Expenses	3 440,00	3 000,00	
8200	Administrative Expenses			
8210	Office Supplies	510,00	500,00	
8230	Phone and Fax	800,00	800,00	
8240	Postage	1 390,00	1 200,00	
8290	Total Administrative Expenses	2 700,00	2 500,00	
8300	Computer Expenses			
8310	Software	1 000,00	1 000,00	

1 7 31 3 12 ⋮ ⏪ ⏩ Balance Functions Help

* Basic problem VI-II. (over budget)

1015 London Postmaster - Purchase Invoice

General Invoicing Shipping Foreign Trade E-Commerce

No. 1015

Buy-from Vendor No. 10000

Buy-from Contact No. CT000066

Buy-from Vendor Name London Postmaster

Buy-from Address 10 North Lake Avenue

Buy-from Address 2

Buy-from Post Code/City N12 5XY London

Buy-from Contact Mrs. Carol Philips

Posting Date 26.03.12

Document Date 26.03.12

Vendor Invoice No. Miki-0983

Order Address Code.

Purchaser Code RL

Campaign No.

Responsibility Center LONDON

Assigned User ID

Status Open

Type	No.	Description	Location Code	Quantity	Unit of Measure ...	Direct Unit Cost Excl...	Line Amount Excl. VAT	Line Disco...	Qty. to Assign
G/L Ac...	8110	Cleaning		10	HOUR	100,00	1 000,00		
G/L Ac...	8120	Electricity and Heating		20	HOUR	200,00	4 000,00		
G/L Ac...	8130	Repairs and Maintenance		30	HOUR	300,00	9 000,00		
G/L Ac...	8210	Office Supplies		10	HOUR	100,00	1 000,00		
G/L Ac...	8230	Phone and Fax		20	HOUR	200,00	4 000,00		
▶ G/L Ac...	8240	Postage		30	HOUR	300,00	9 000,00		

Invoice Line Functions Posting Help



Basic problem VI-III.

(over budget)

G/L Balance/Budget

Options

Date Filter 01.03.12..31.03.12 Budget Filter 2012

Department Filter Closing Entries Include

Project Filter

No.	Name	I... Debit Amount	Credit Amount	Balance/Budget (%)	Budgeted Debit Amount	Budge... Credit Amount	Budgeted Amount
8100	Building Maintenance Expenses	L...					
▶ 8110	Cleaning	I... 1 000,00		100,0	1 000,00		1 000,00
8120	Electricity and Heating	I... 4 000,00		400,0	1 000,00		1 000,00
8130	Repairs and Maintenance	I... 9 000,00		900,0	1 000,00		1 000,00
8190	Total Bldg. Maint. Expenses	L... 14 000,00		466,7	3 000,00		3 000,00
8200	Administrative Expenses	L...					
8210	Office Supplies	I... 1 000,00		200,0	500,00		500,00
8230	Phone and Fax	I... 4 000,00		500,0	800,00		800,00
8240	Postage	I... 9 000,00		750,0	1 200,00		1 200,00
8290	Total Administrative Expenses	L... 14 000,00		560,0	2 500,00		2 500,00
8300	Computer Expenses	L...					
8310	Software	I...			1 000,00		1 000,00

1 7 31 3 12 | Account | Functions | Help