

TOC – Critical chain

J.Skorkovský
ESF-MU, KPH



TOC concisely I (see PWP presentation about TOC)

- origin: E.M.Goldratt, Jerusalem
- cost world<->throughput world
- analogy weight of the chain – solidity of the chain
- how to find a bottleneck?
- tools of TOC – tree structures
- CRT – EC – TT – PT – FRT **meaning:**
- Current Reality Tree - Evaporating Cloud Tree– Transition Tree -
 - Prerequisite Tree – Future Reality Tree



TOC concisely I (see PWP presentation about TOC)

- **bottleneck** in the project management is a critical path
- finding (assessment) of bottleneck is not easy and often it is not explicit (uncompromising)
- everybody knows something about TOC and nobody knows **how to implement it** to the real world- and this is again another bottleneck (tendon of Achilles from the heel to the scruff)



TOC-five steps (revision)

Five steps process:

Step 0. Identify the Goal of the System/Organization

Step 0.5 Establish a way to measure progress to Goal

- **Step 1. *Identify*** the system's constraint.
- **Step 2. *Exploit*** the system's constraint.
- **Step 3. *Subordinate*** everything else to the above decision.
- **Step 4. *Elevate*** the system's constraint.
- **Step 5.** If a constraint is broken (that is, relieved or improved), go back to Step 1. But don't allow *inertia* to become a constraint.



Linear image of the project

- activities – abscissas – Gantt graph
- constantly changing conditions (Parkinson law, Murphy law, Student syndrome, customer changes - „fancies“ „caprices“)

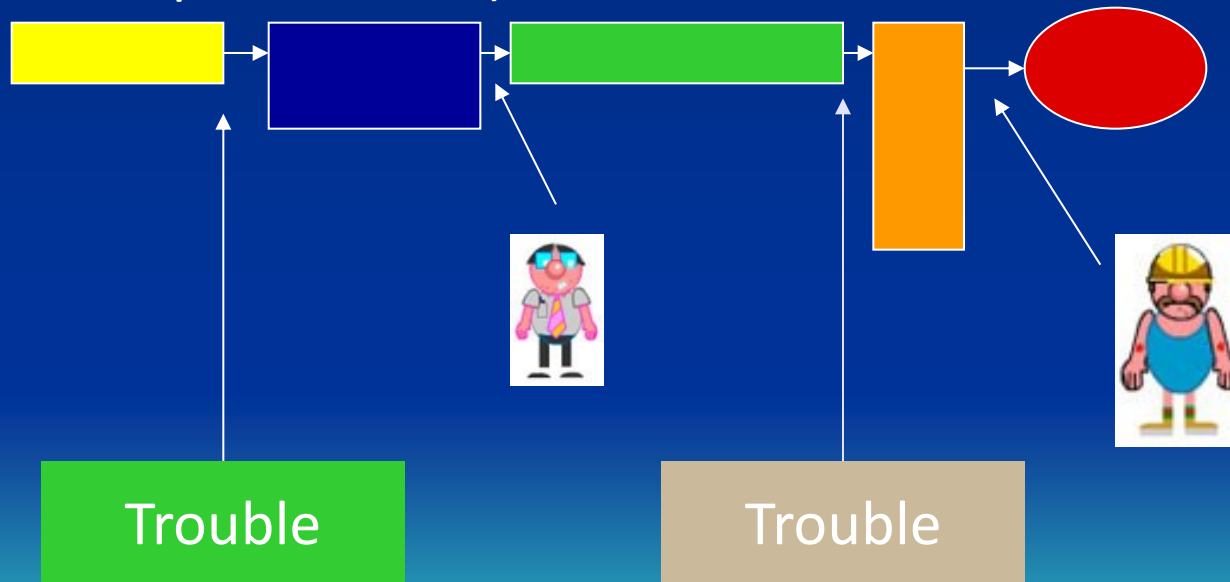

Parallel image of the project

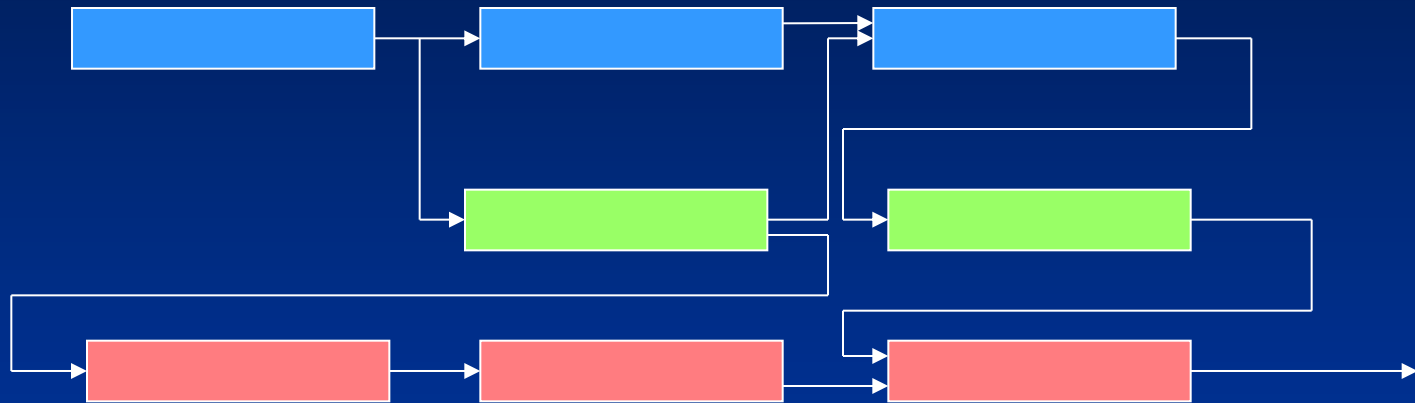

PlannerOne Resource Planner

View - PlannerOne Resource Planner - Microsoft Dynamics NAV

CRONUS International Ltd. ▶ Departments ▶ Resource Planning ▶ PlannerOne ▶ PlannerOne Resource Planner

Search (Ctrl+F3)

POWERED BY ORTEMA

Plánování | Zobrazit | Akce | Filtr

Dnes | Předchozí období | Počátek plánování | Vybrat datum | Následující období | Konec plánování | Přejít na | Týden | Den | Měsíc | Pokročilé | Časové měřítko | Skrytí nepracovní doby | Zvětšit aktivity | Aktivita barvy | Výška řádku | Štítky aktivit | Popisky aktivit | Uživateléské úpravy | Zvětšení | Zmenšení | Zrušit | Zoom | Automatické obnovení | Obnovení | Obnovit výchozí | Zobrazit

Resource Gantt chart | Job Gantt chart | Load Chart | Resource Sequence | Calendar view | Job planner

SO000013 Service Order for Planner...
SO000013 Service Order for Planner...

SO000015 Servis order for our priority... +

Přehled

- ★ Oblíbené (4)
- 🕒 Plánováno v poslední době
- Pouze částečně naplánováno (12)
- Plně naplánováno (11)
- 🚨 Překročení rozpočtu (7)
- Dokončeno (2)

★ **Oblíbené (4)**

Task Name	Company	Days	Progress	Completion
LONDON, 10 WP Setting up 10 Wc	Deerfield Graphics Company	114 dny	100 %	Dokončeno: 0 %
SERVICE ORDER 1 Service Order 1	The Cannon Group PLC	137 dny	100 %	Dokončeno: 66,67 %
SO000013 Service Order for Plann	The Cannon Group PLC	před 63 dny	100 %	Dokončeno: 51,22 %
SO000015 Servis order for our pric	The Cannon Group PLC	před 63 dny	100 %	Dokončeno: 0 %

Project and its budget

- price of the whole project (see MS Dynamics NAV next slide)
- project length (time)
- project stages and length of each activity
- assigned resources to every activity and their capacities (time per defined period)
- time reserves (buffers) and their estimation
- unfavourable influences (see Murphy's laws - <http://murphy.euweb.cz>, etc.)
- additional activities (unexpected costs)

Projects and MS Dynamics NAV

Jobs

- Jobs
- Job Task Lines
- Job Journals
- Job G/L Journals
- Reports
- History
- Periodic Activities
- Setup



Jobs

No.	Description	Order
DEERFIELD...	DEERFIELD, 8 WP · Setting up Eight Work Areas	
GUILDFOR...		

DEERFIELD, 8 WP · Setting up Eight Work Areas

General

No.:	DEERFIELD, 8 WP	Bill-to City:	Gloucester
Description:	Setting up Eight Wor...	Bill-to Country/Region Code:	GB
Bill-to Customer No.:	40000	Bill-to Contact:	Mr. Kevin Wright
Bill-to Contact No.:		Search Description:	SETTING UP EIGH...
Bill-to Name:	Deerfield Graphics C...	Person Responsible:	MARY
Bill-to Address:	10 Deerfield Road	Blocked:	
Bill-to Address 2:		Last Date Modified:	24.1.2019
Bill-to Post Code:	GL1 9HM		

Posting Order

Duration	14.1.2019	1.2.2019
Foreign Trade		
WIP and Recognition		

Projects and MS Dynamics NAV

Job Task Lines

Type to filter (F3) | Job Task No. | Filter: DEERFIELD, 8 WP

Job Task No.	Description	Job Task Type	Totaling	Job Posting Group	WIP-Total	WIP Method	Start Date	End Date	Schedule (Total Cost)
1000	Setting up Eight Work Areas		Begin-Total						
1100	Preliminary Services		Begin-Total						
1110	Determining Specifications	Posting		SETTING UP			13.1.2019	13.1.2019	107,80
1120	Selecting Furnishings	Posting		SETTING UP			14.1.2019	14.1.2019	107,80
1130	Obtaining Customer Approval	Posting		SETTING UP			17.1.2019	17.1.2019	107,80
1190	Total Preliminary Services		End-Total 1100..1190						323,40
1200	Assembling the Furniture etc.		Begin-Total						
1210	Assembling the Furniture etc.	Posting		SETTING UP			23.1.2019	23.1.2019	11 000,10
1290	Total Assembling the Furniture		End-Total 1200..1290						11 000,10
1300	Closing the Job		Begin-Total						
1310	Meeting with the Customer	Posting		SETTING UP			27.1.2019	31.1.2019	107,80
1390	Total Closing the Job		End-Total 1300..1390						107,80
9990	Total Setting up Eight Work Areas		End-Total 1000..9990						11 431,30

List of tasks and related costs (scheduled and used)

Schedule : The planning line contains expected usage for the job that will not be invoiced to the customer. You use this option if the customer will be invoiced from a different planning line (of type Contract or Both Schedule or Contract), or if the expected usage for this planning line is not chargeable.

Contract : The planning line specifies an amount that should be invoiced to the customer, but no usage relates to the line. You use this option if no schedule of usage has been planned for the job, or if the expected usage for the job has been specified on different planning lines (of type Schedule).

Line Type	Planning Date	Document No.	Job No.	Job Task No.	Type	No.	Description	Unit of Measure Code	Quantity	Unit Cost	Unit Cost (LCY)	Unit Price	Total Cost
Schedule	25.01.12		DEERFIELD, ...	1210	Resource	MARK	Delivering and Assembling	HOUR	20	31,90	31,90	54,00	638,00
Contract	25.01.12		DEERFIELD, ...	1210	Resource	MARK	Delivering and Assembling	HOUR	20	31,90	31,90	54,00	638,00

Selected Murphy's laws

- If your attack is going well, you have walked into an ambush (trap)
- Planner is alerted about modification of the plan exactly in the moment, when the plan is finally adjusted
- To carry out **n+1** trivialities you need two times more time than time necessary to carry out **n** trivialities (law 99 %)
- **If anything can go wrong, it will**
- Any given program, when running, is obsolete
- No matter how many resources you have, it is never enough



Resources and orders

Matrix structure of multi-project environment – responsibility of project managers and responsibility of department managers are **in conflict**



Project manager 1
(manages O2)

Project manager 2
(manages O1)

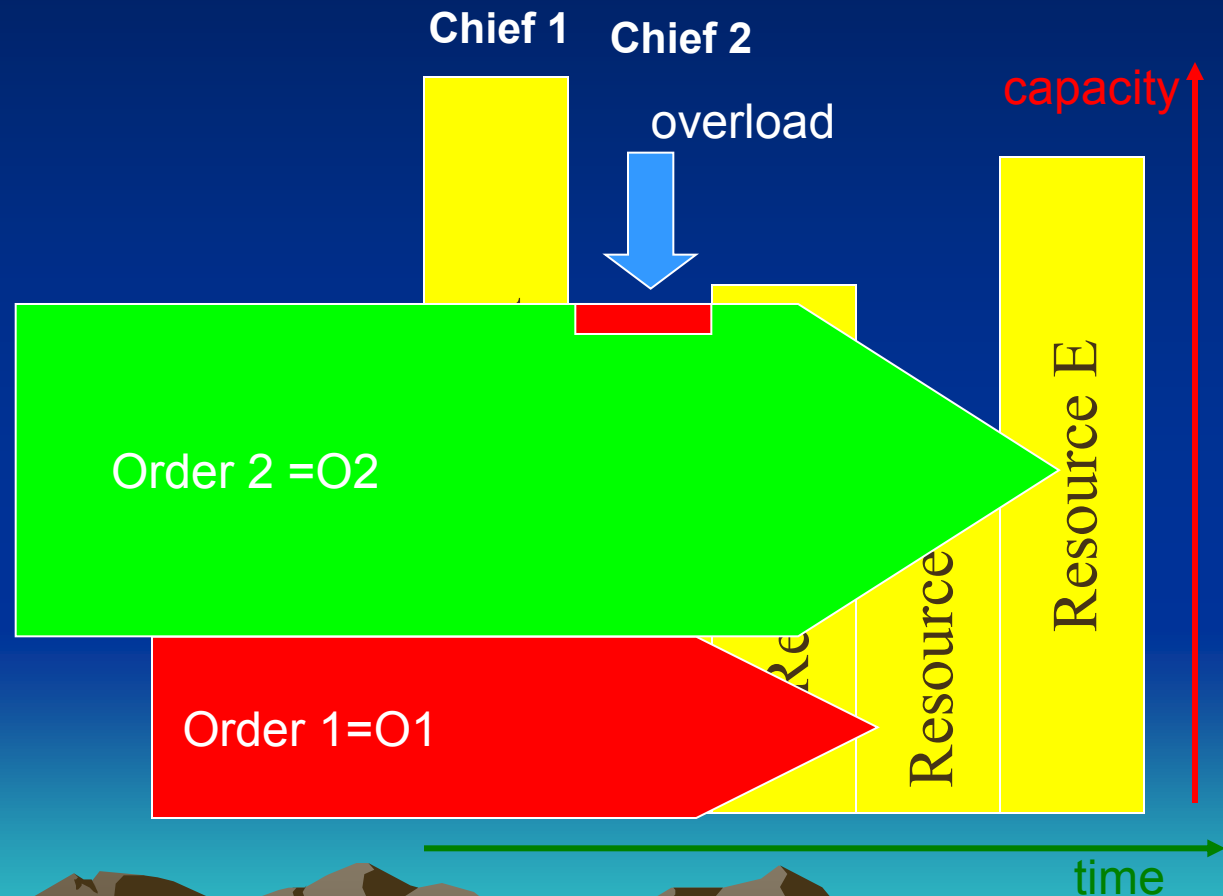

Partial time of any activity in the project

Variability of the real time assigned to activity

Probability– median an element of statistical file,
which is after sorting in the middle .Median of the set (1,5,2,2,1) is 2



*100 „5-miniutes meeting happened.
How many times it took 5 minutes only ?*

Colleague ask for a quick rendez-vous: „Do not worry, it will take maximum 5 minutes!“.

How long it takes on average?

Project environment is very complicated because of integration linkages and their dependencies

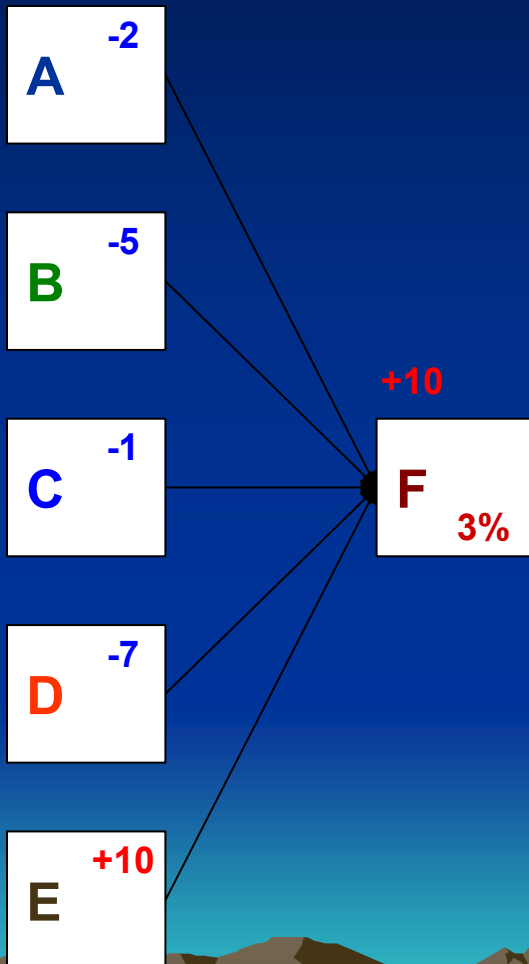

Probability of finishing tasks A to E in time is 50%. ($50 \times 50 \times \dots \times 50 = 3,125 \%$)

What is a probability, that task F will start in time ?

How the timely finishing of the tasks A,B,C and D will influence the integration point ?

- a) saving are fully wasted
- b) delay in one task will be immediately transferred to the next project task (activity) see **+10**

Project environment is very complicated because of integration linkages and their dependencies

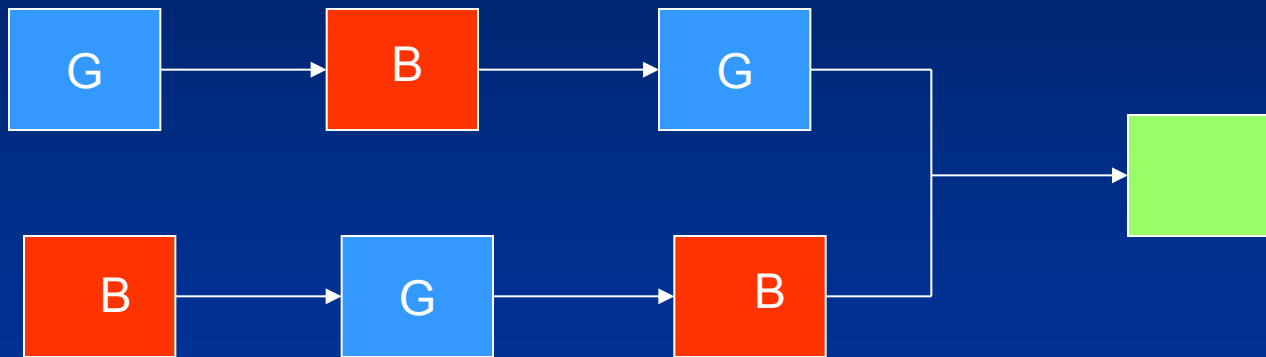

In order to start **B** in the upper branch, you have to finish **G** and also **B** in the lower branch. The probability, that **B** start in time is 50 % worse, than it was shown on the previous slide.

The project must be protected against influences of breakdowns (troubles)

Standard estimation with protecting buffers for every activity

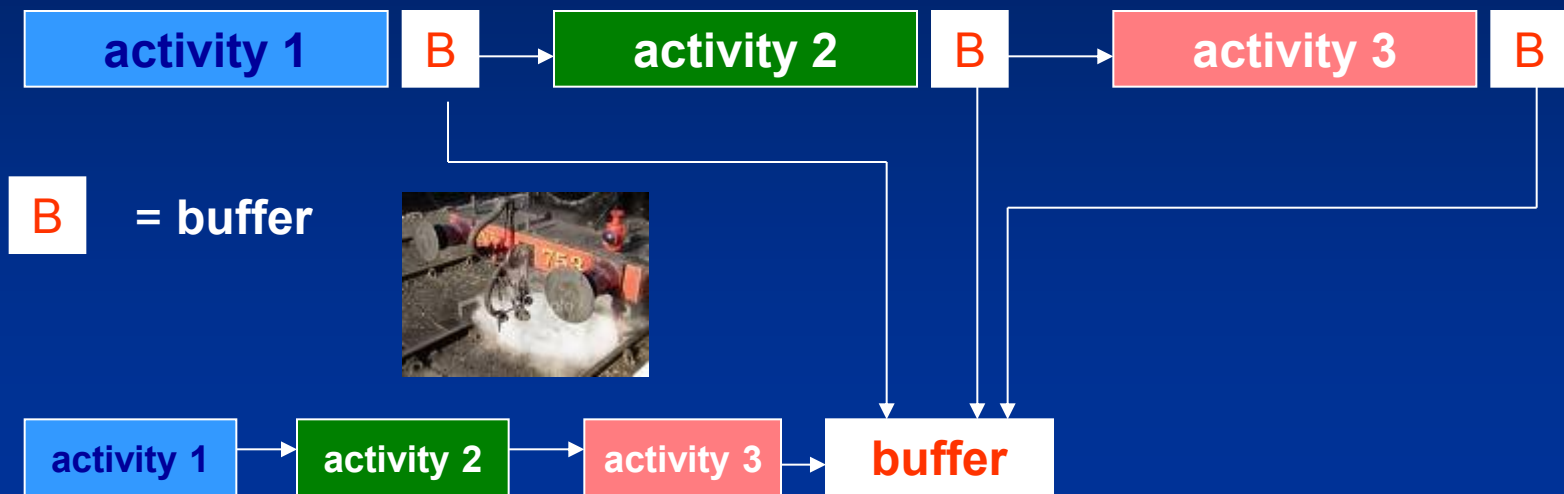

1st step : every activity is shorten to 50 % of its original time size.

2nd step : **critical path buffer** at the end of the project will have size of 50 % of the total sum of saved time created by shortening all partial activities

Simplified scenario CPM and CCPM

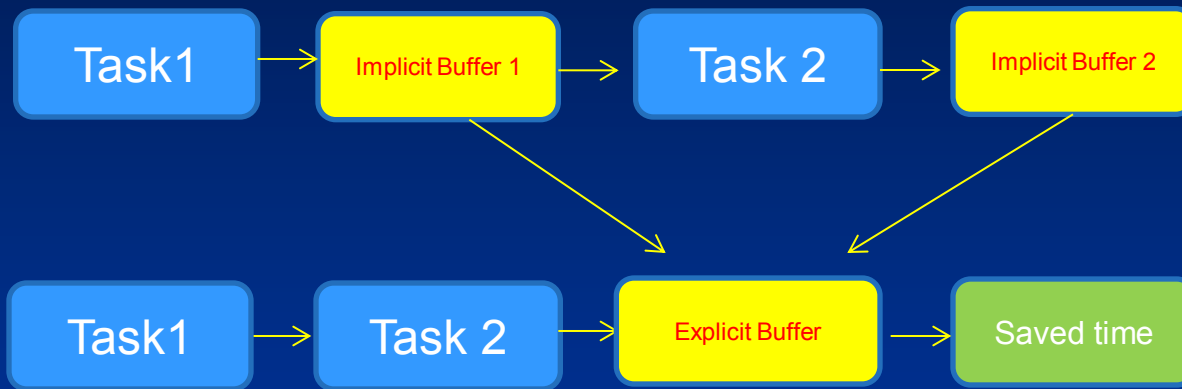

Explicit-directly specified, opened
Implicit= hidden, internally defined, indirect

CPM = Critical Path Method

CCPM = Critical Chain Project Methodology

EC and project management

(EC=evaporating cloud)

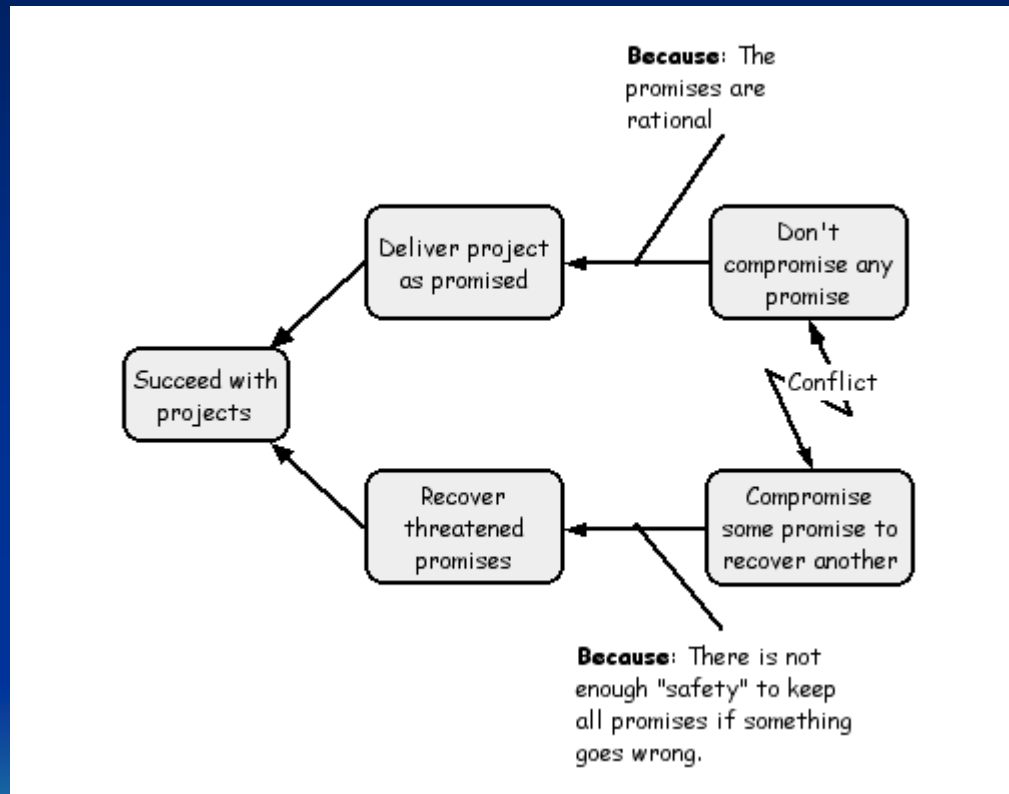

Critical path, adjoining branches of the project and adjoining buffers (AB)

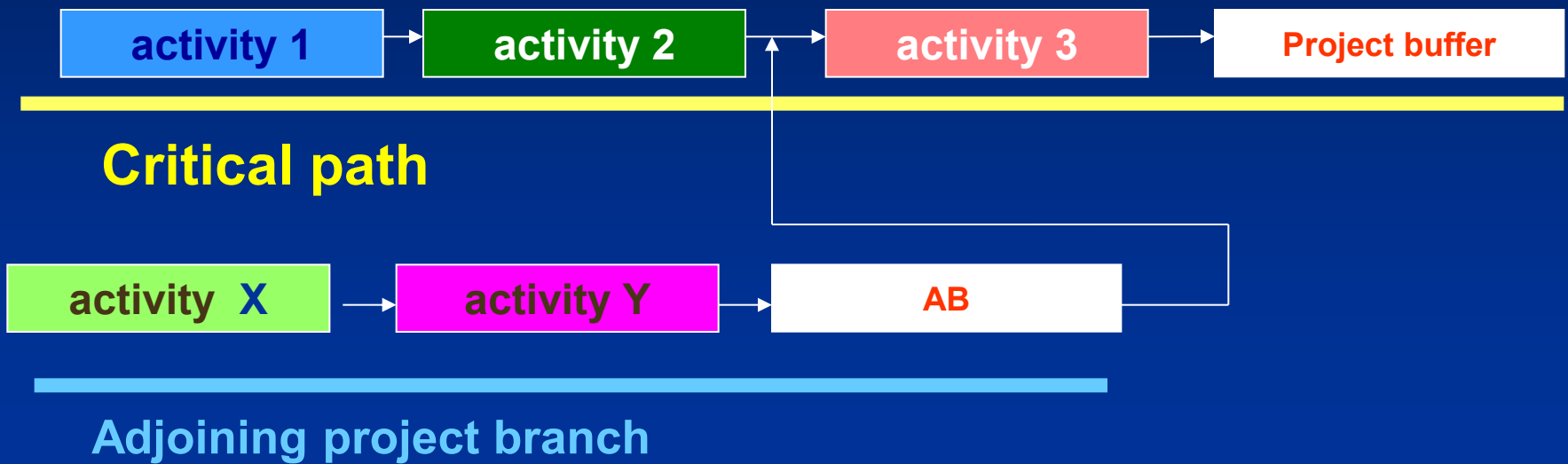

Buffer serves as a safety tool to accumulate reasons of **expected** and **unexpected** delays

Critical Path (CP)

- Critical path is defined as **the longest way** (meaning time) from the starting point of the project graph to the ending point.
- Every project has at least one critical path

The rules of CP:

- Every delayed task on CP will essentially delay the whole project
- Truncation of duration of any task on CP will shorten whole project



Critical Path (CP)

- **Critical Path Method**, abbreviated **CPM**, or **Critical Path Analysis**, is a mathematically based algorithm for scheduling a set of project activities. It is an important tool for effective project management.

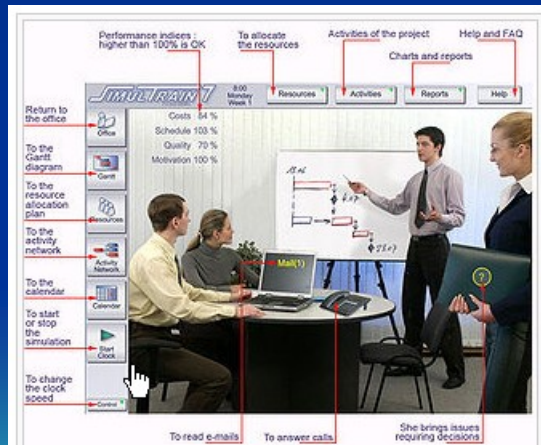

Critical Path (CP)

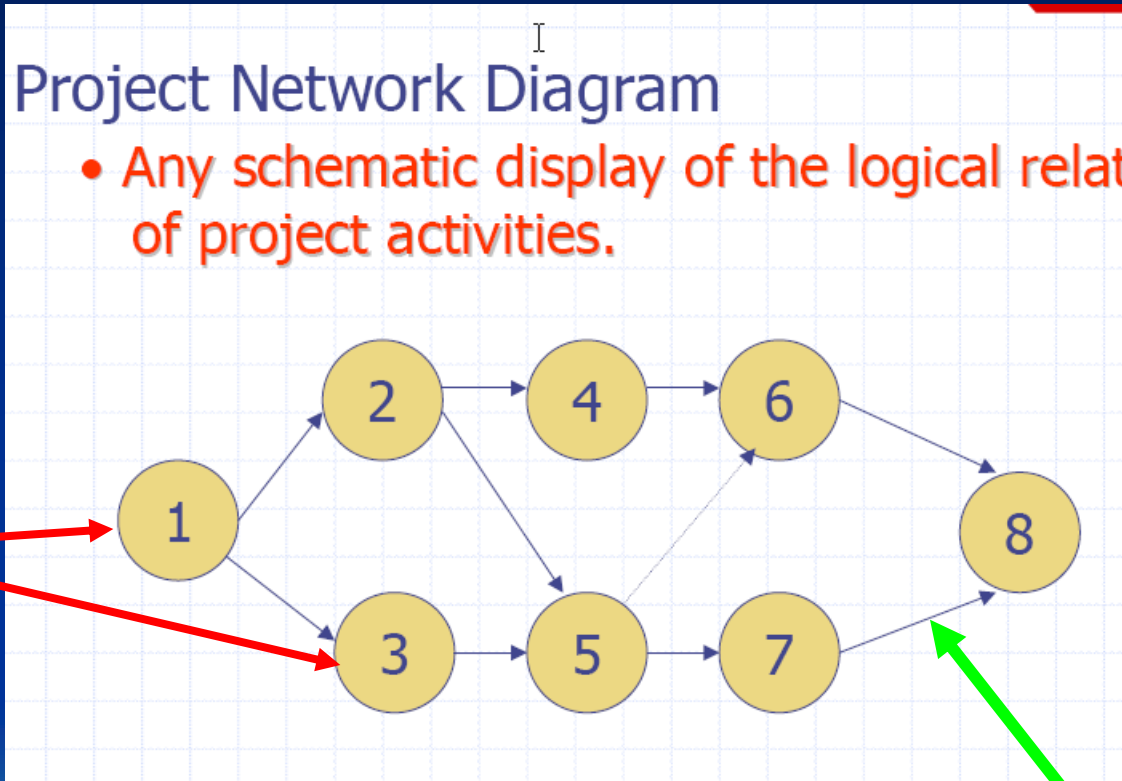

Milestones

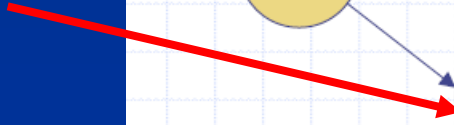

Activity

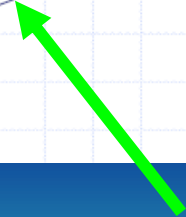

Critical Path (CP)

Building a diagram 1

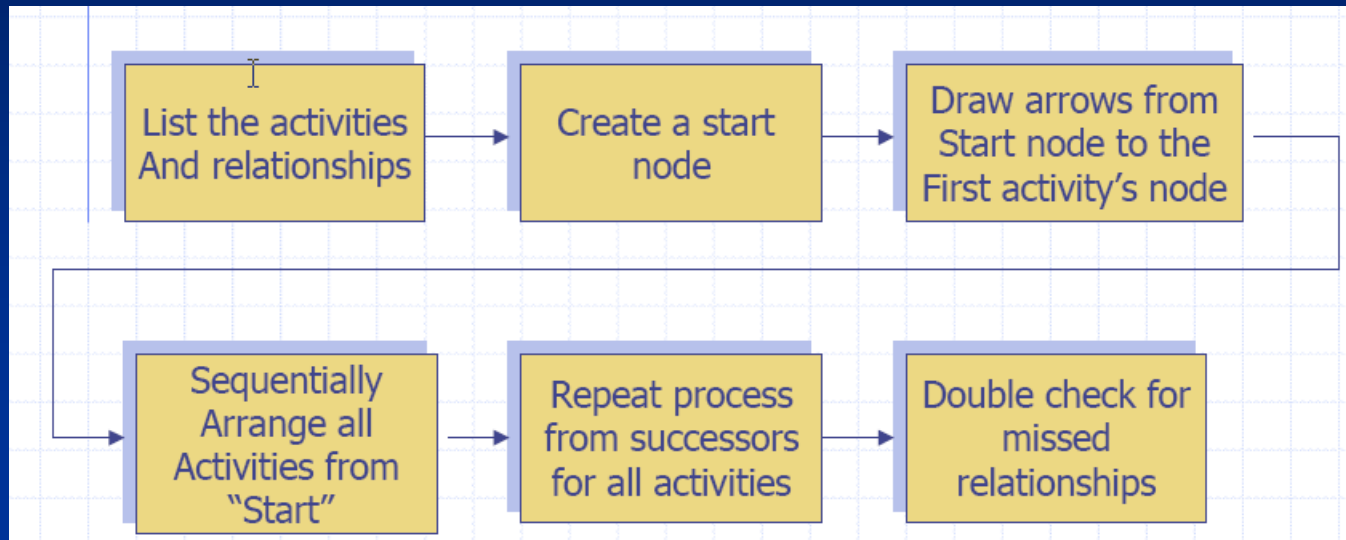

Critical Path (CP)

Building a diagram 2

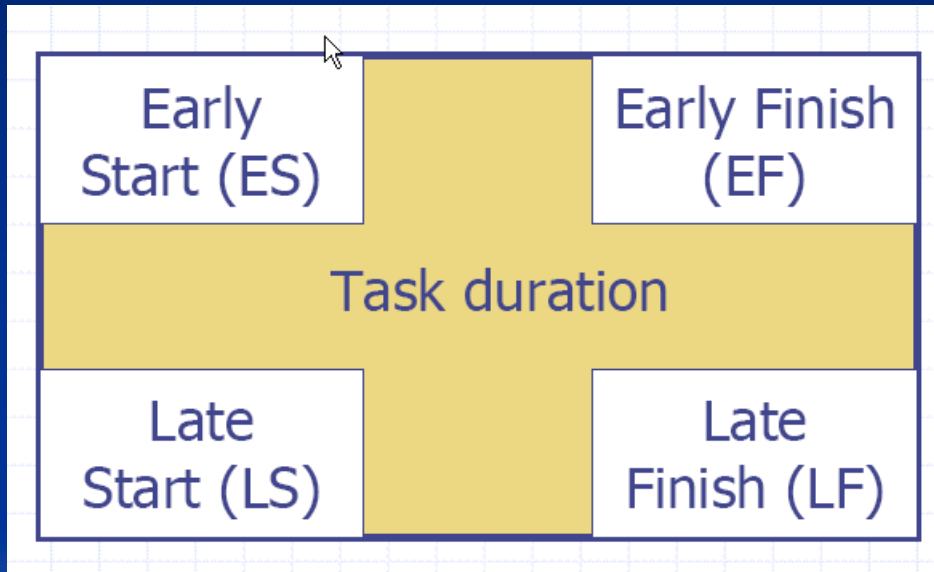

Critical Path (CP)

Building a diagram 3

<i>Task ID</i>	<i>Duration</i>	<i>Dependency</i>
A	7	
B	3	
C	6	A
D	3	B
E	3	D,F
F	2	B
G	3	C
H	2	E,G

Critical Path (CP)

Building a diagram 4 – calculating the **FORWARD PASS**

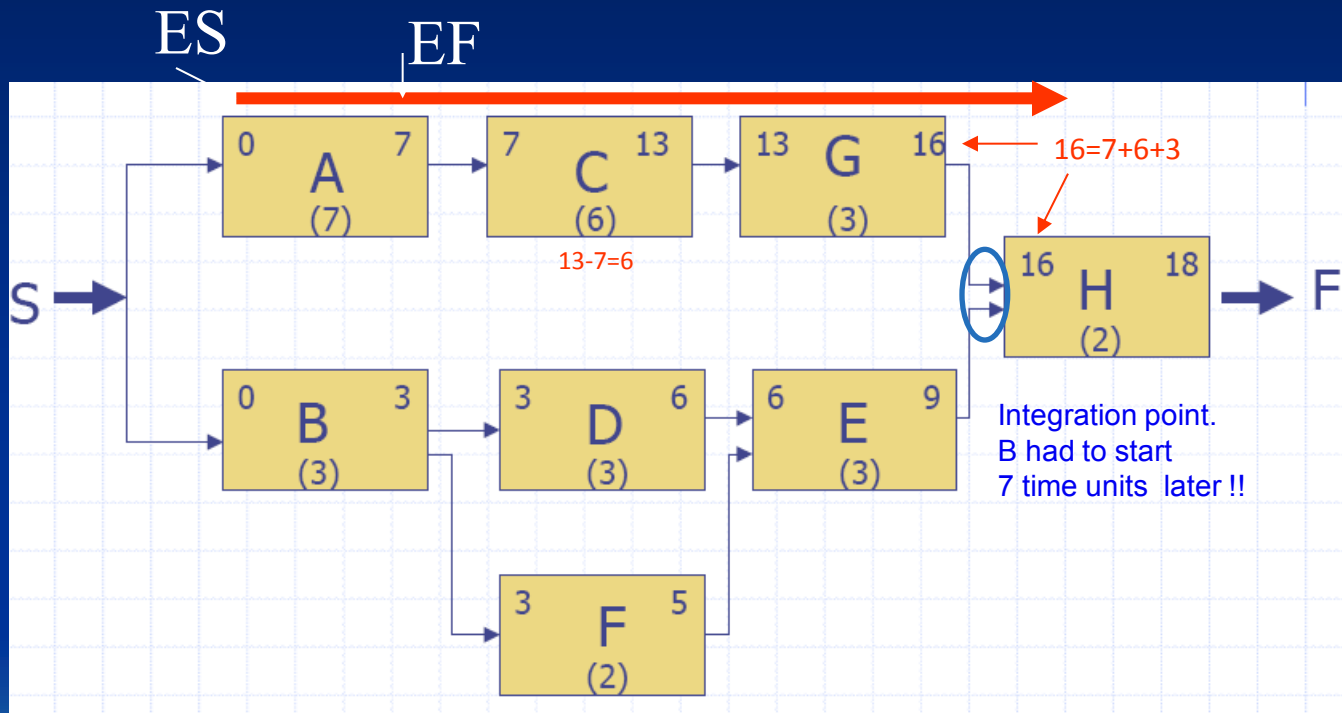

Early Starts and Early finishes dates are calculated by means of **Forward Pass**

Critical Path (CP)

Building a diagram 5 – calculating the **BACKWARD PASS**

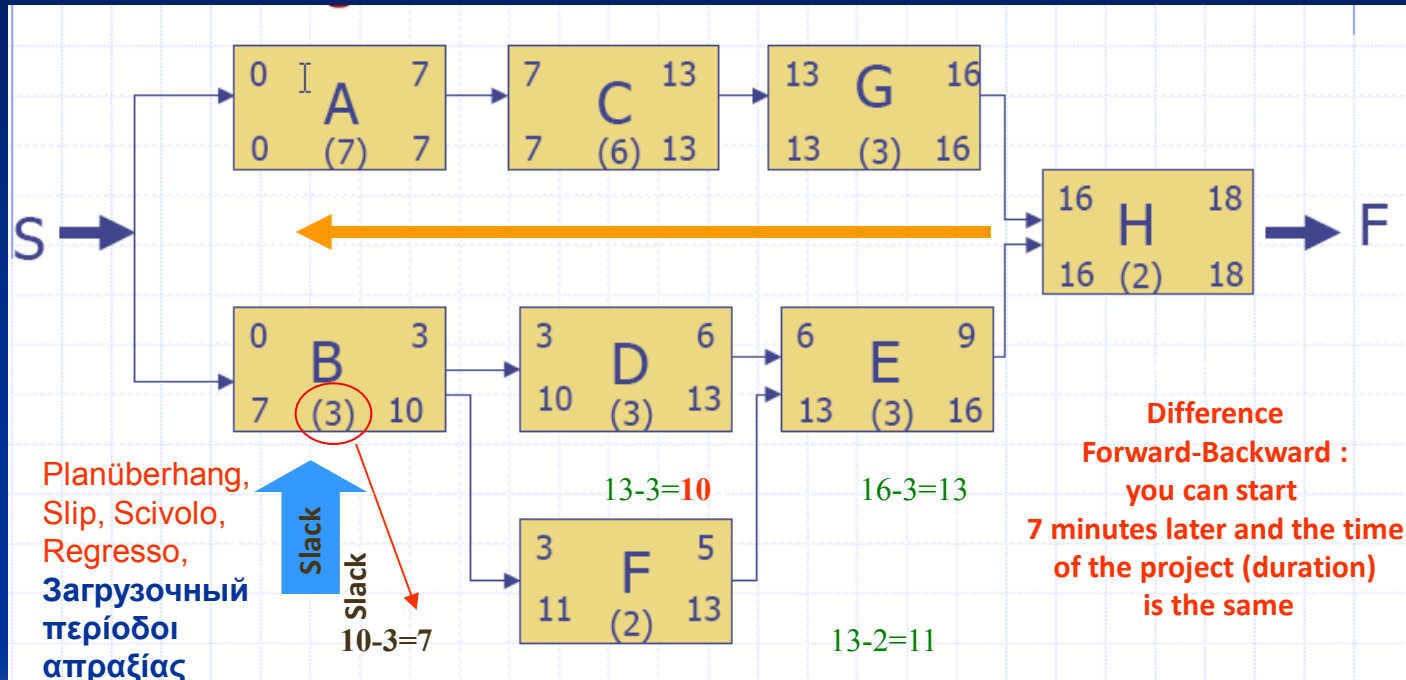

Late Starts and Late Finishes dates are calculated by means of Backward Pass

Critical Path (CP)

Building a diagram 6 – calculating the **FLOAT(SLACK)/CP**

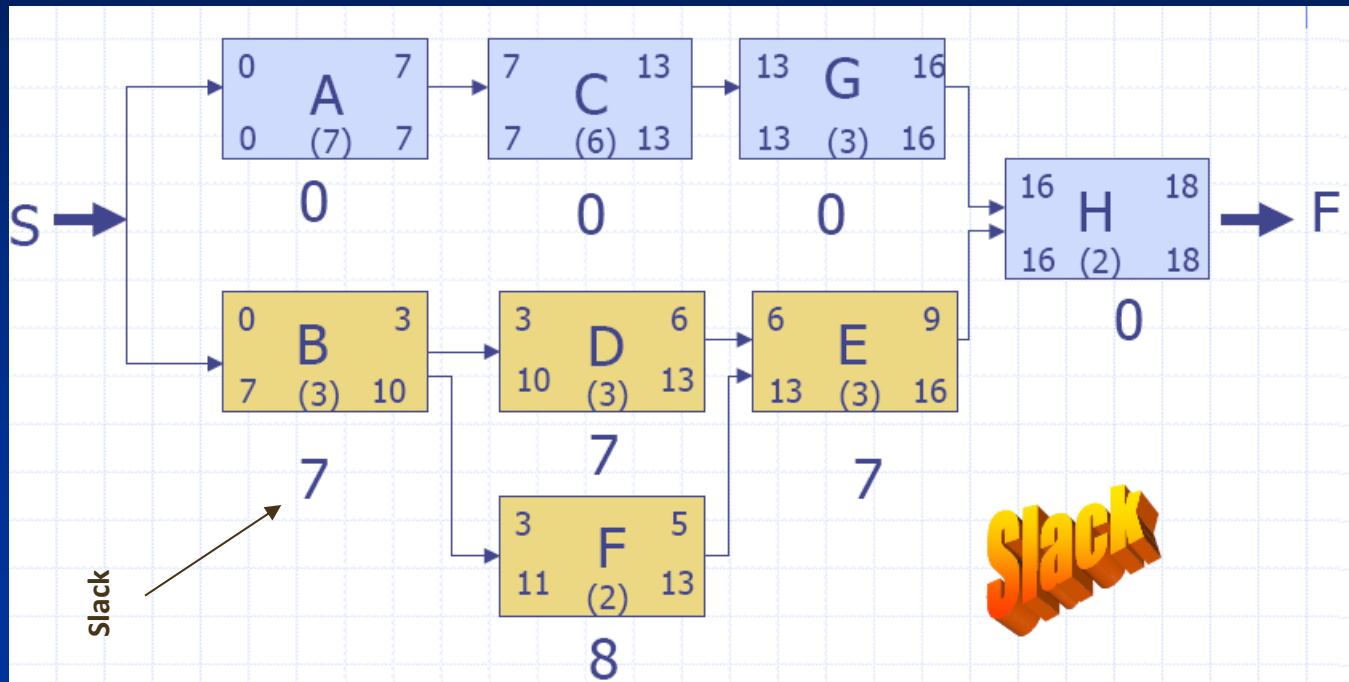

Free Float (Slack): Amount of time a single task **can be delayed** **without** delaying the early start of any successor task = $LS-ES$ or $LF-EF$

Slack=Float

Proper description (Home study) :Slack or Float provide flexibility in the project schedule. When leveraged properly, project managers can shift activities and resources to meet the project objectives and priorities. It is the amount of time an activity can be delayed without impacting other activities or the project end date and changes over the course of the project implementation.

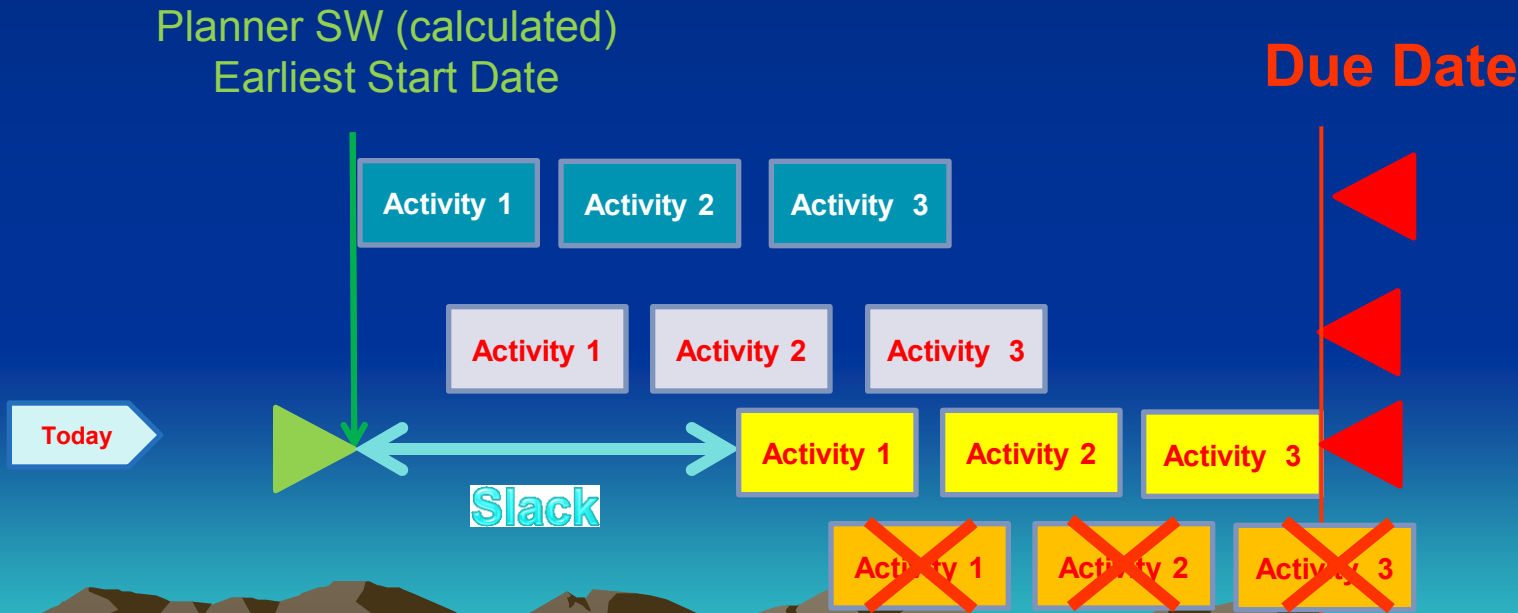

Critical Path (CP)

CPM is helpful in :

- Project Planning and control.
- Time-cost trade-offs.
- Cost-benefit analysis.
- Reducing risk.



Critical Path (CP)

Limitation of CPM :

- Does not consider resource capacities.
- Less efficient use of buffer time.
- Less focus on non critical tasks that can cause risk.
- Based on only deterministic task duration.
- Critical Path can change during execution.



Multitasking characterization

- people always **overestimate the length of their tasks**
- **salesman offers impracticable terms (dates)**
- The fight for reserves (capacities) causes, that all saved time is fully wasted (Student s syndrome)
- **Reserves (if any) are used badly !!!!!**
- Bad use of reserves causes lack of transparent assignment
- Non transparent priorities are parents of bad multitasking
- **Bad multitasking causes longer duration of all activities (tasks) and thus all the projects**



CP definition (more in detail)

Critical path is defined as the longest way (meaning time) from the starting point of the project graph to the ending point

Critical path represents technological dependencies and given times of every task on Critical path inclusive of necessary condition for fulfilment of foregoing tasks (activities) framed by integration points.



Critical chain



~~Task~~

Resource and capacities

Contemplation I.

Computing power

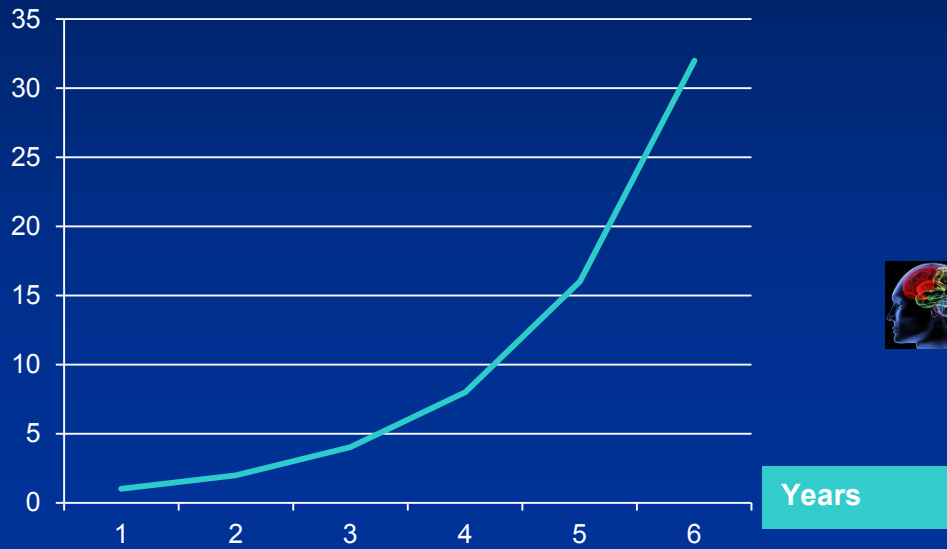

Result -> Stress



Contemplation II.



+



+

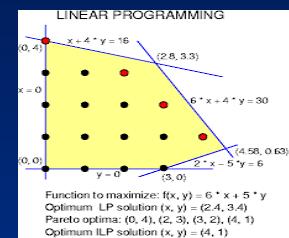

E-mails

Parallel telephoning

Parallel problem solving

a) Am I a multitasker ?

**b) NO !! An my IQ went down 15 point
due to parrel processing !**

Contemplation III.



+



+



Is this the goal of my lifelong efforts?



Maybe not I guess
I reached another peak ...

Critical chain definition

In TOC the **Critical chain** is defined as the longest way (meaning time) from the starting point of the project graph (Gantt) to the ending point which takes into account **technological dependencies** as well as time of the tasks and moreover, **capacities of assigned resources**.

With infinite capacities of resources you can consider Critical path=**Critical chain**



Multi-project management and critical resources (CCR) used in more than one project branch

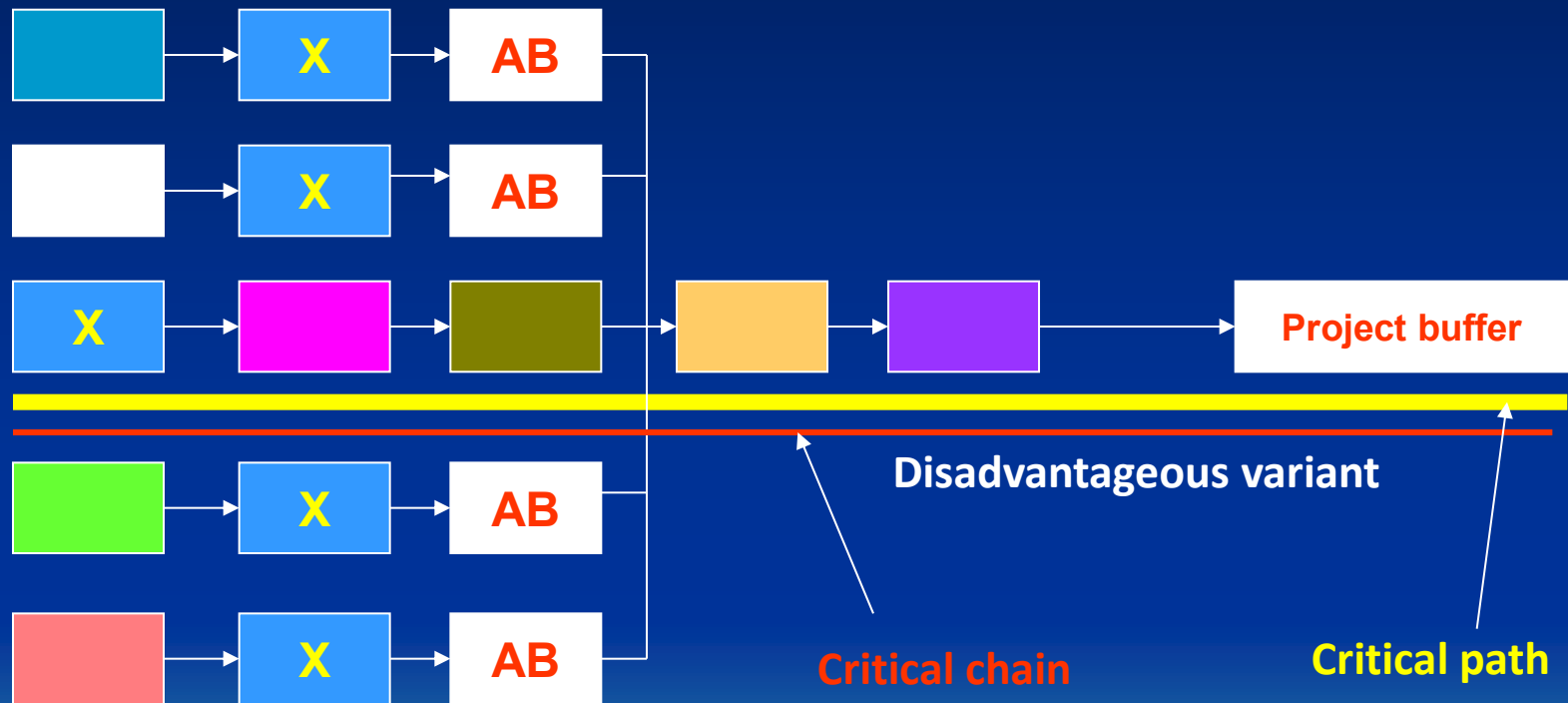

CCR = Capacity Constrained Resource = X

Multi-project management and critical resources (CCR) used in more than one project branch

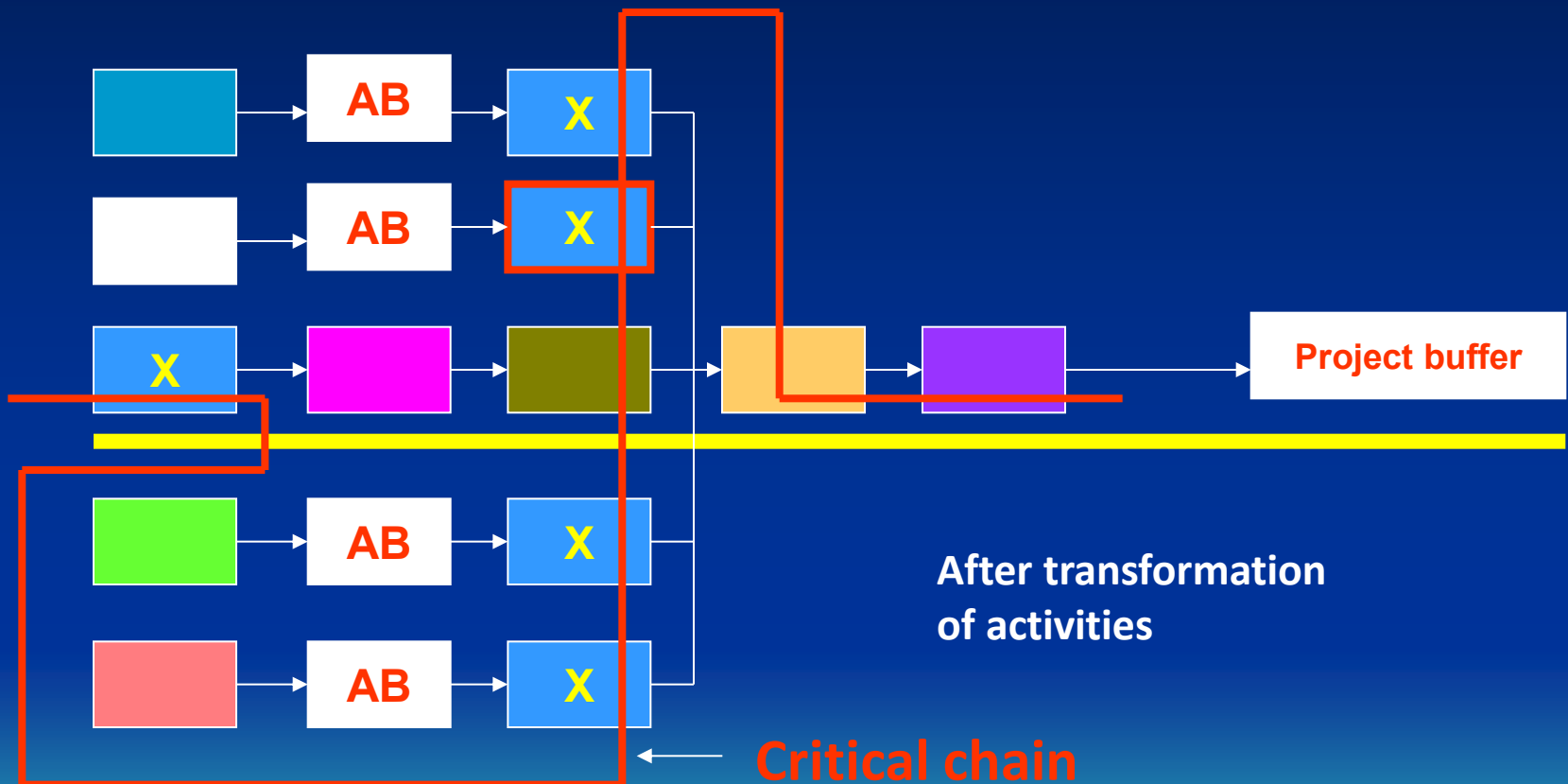

Project management based on remaining time in buffers – **Buffer Management**

- Buffers are used for timely warning and that is to say predicting and avoiding future problems related to project deadlines (milestones)
- It is also used as a guideline for corrective actions



Basic metrics showing the project status

- The partial size of Critical chain (CC) fulfilled in days (in %)
- How much of buffer size was used to fulfil above mentioned partial size of CC ?
- Trend of project (buffer consumption graph- [see next slide](#))
- Consumption of the financial buffer
- Priorities – bigger buffer penetration- bigger priority
- Adjoining branches have always lower priorities
- It is not allowed to create bad multitasking



Trends of the project

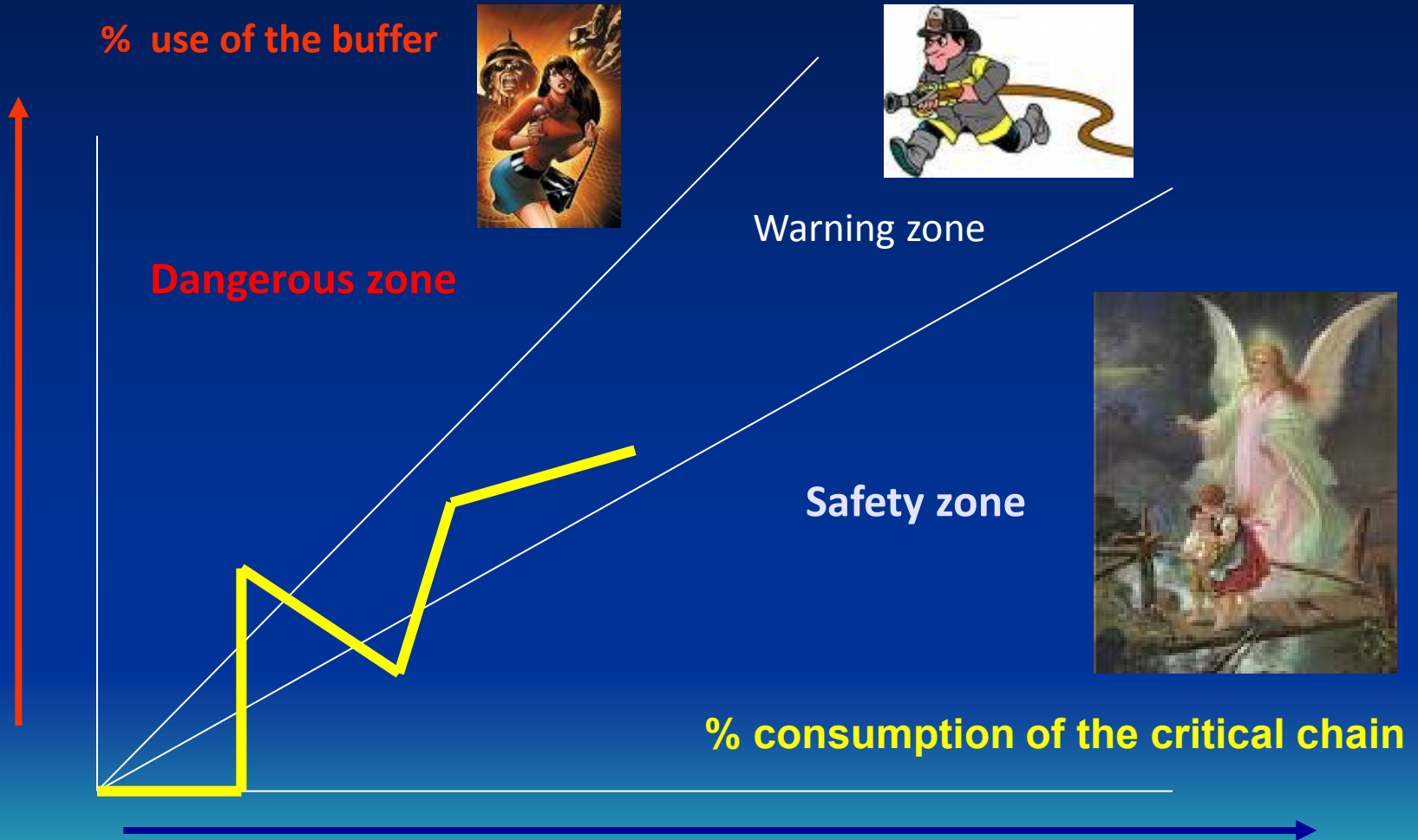

Trend of the project advancement – (another angle of view)

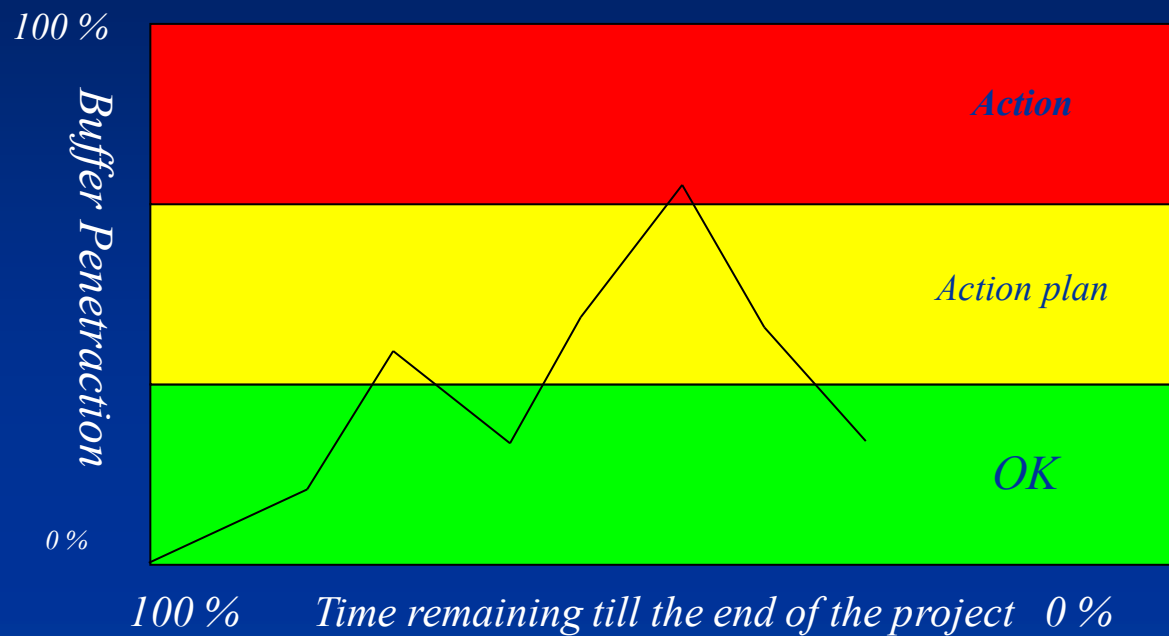

Resource: DP R.Jurka (2006); taken from LEACH, L., P. (2004), s. 12.

Planning - principles

We are working with plan , which takes into account different times of tasks :

- start of the tasks are changed based on termination of preceding tasks
- you have to react in project in such a way , that handover is done as a baton pass during races

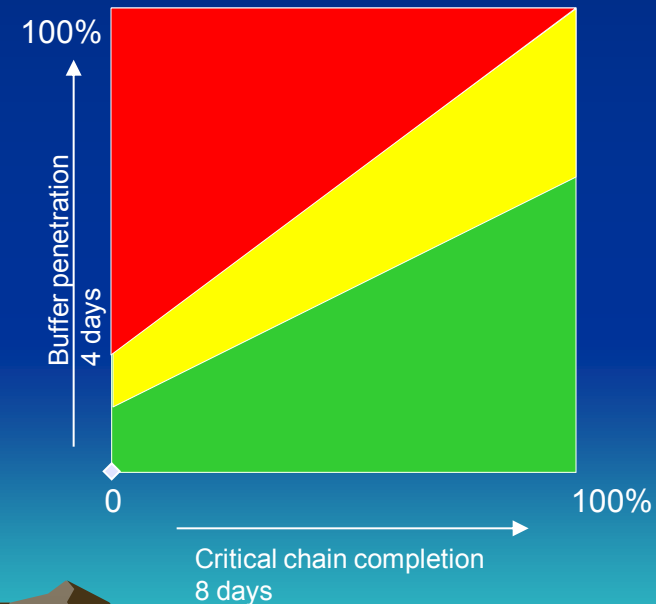
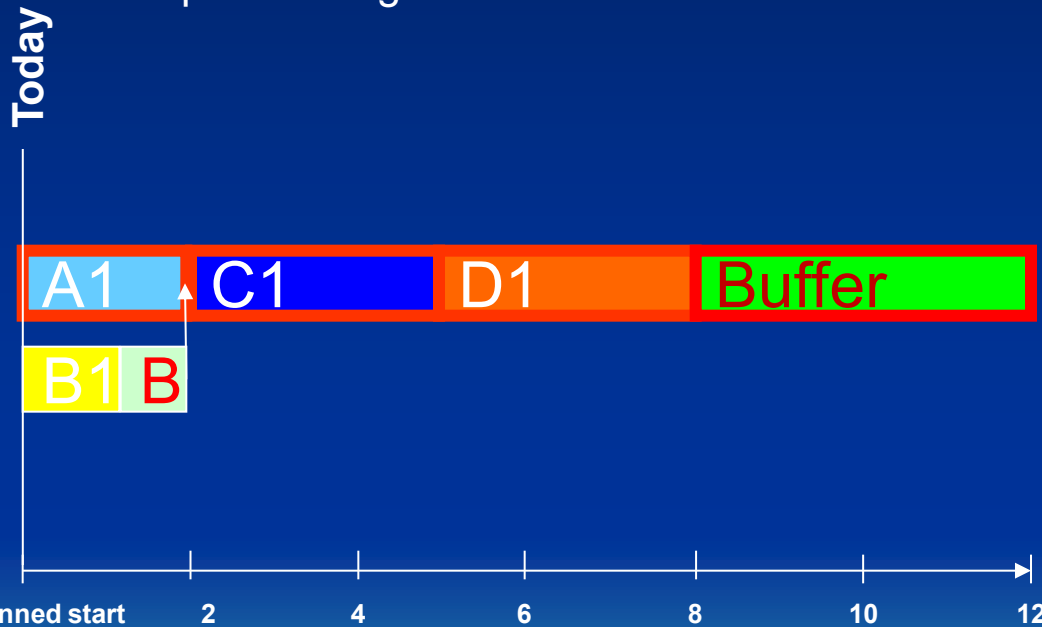

Plan with sharp deadlines with buffers 50% ($2+3+3=8$ $8+4=12$)

Planning - principles

A1 did not started yet , because this A1 resource is still working on another order (task), which may be part of another project

B1 already started an for completion will need another two days

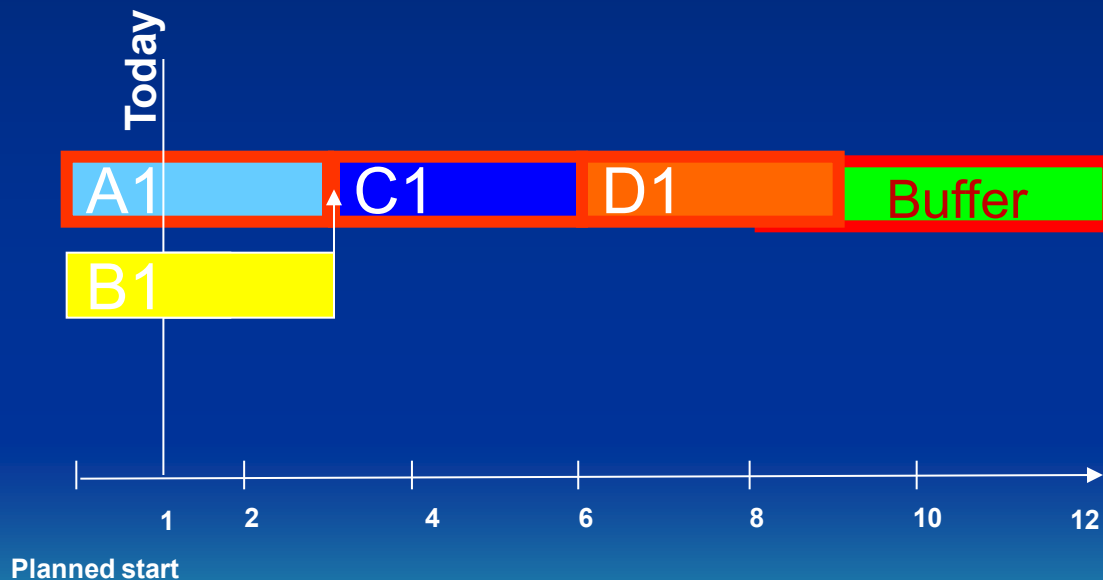

Plan with sharp deadlines with buffers 50% ($2+3+3=8$ $8+4=12$)

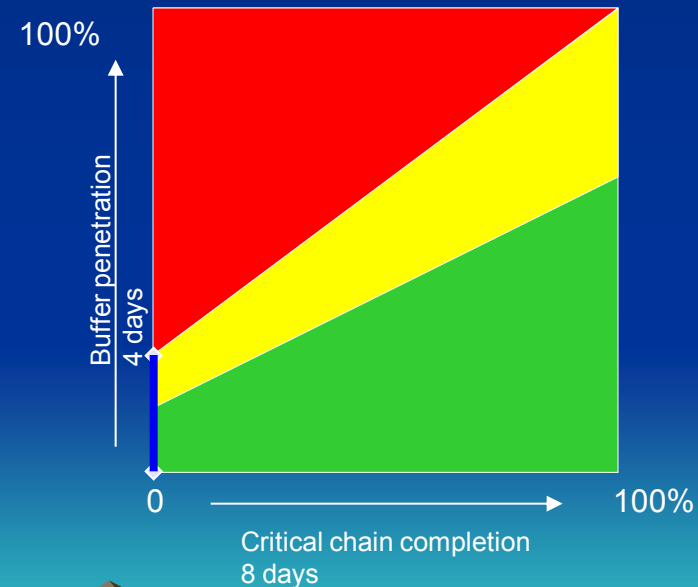

Plan 2nd day after start

A1 started and will be finished (completed) tomorrow.

B1 will be finished (completed) tomorrow

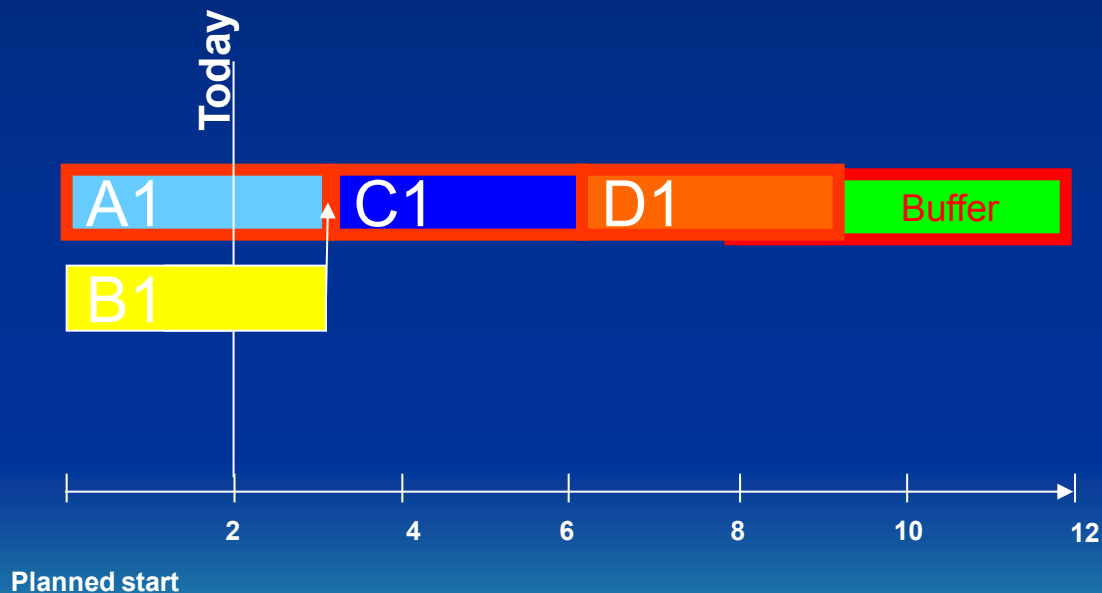

Plan with sharp deadlines with buffers 50% ($2+3+3=8$ $8+4=12$)

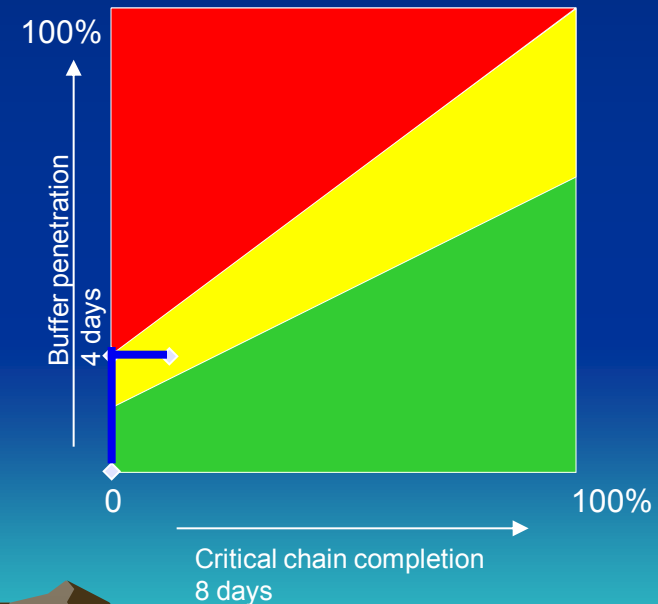

Plan 3rd day after start

A1 despite all efforts resource A1 needs another day to complete.
B1 has completed his work with 2 days delay

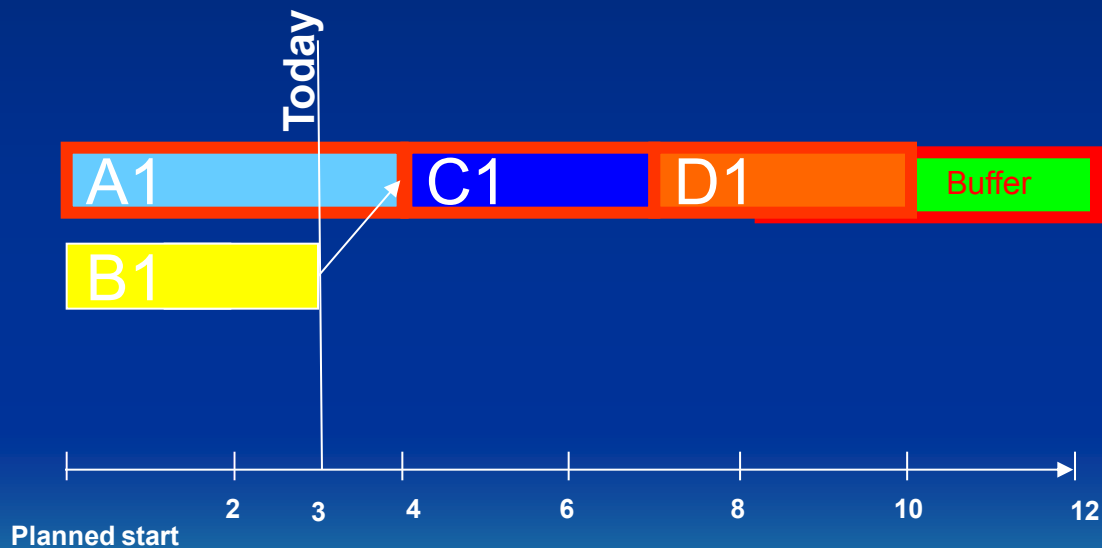

Plan with sharp deadlines with buffers 50% ($2+3+3=8$ $8+4=12$)

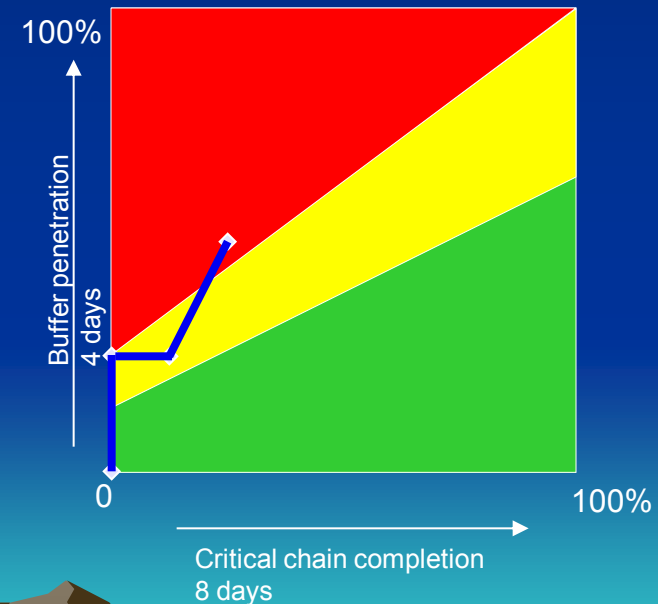

Plan 6 day after start

A1 completed his task with 2 days delay

B1 completed his task with 2 days delay

C1 completed his task 1 day earlier than expected (planned)

D1 will start to work tomorrow

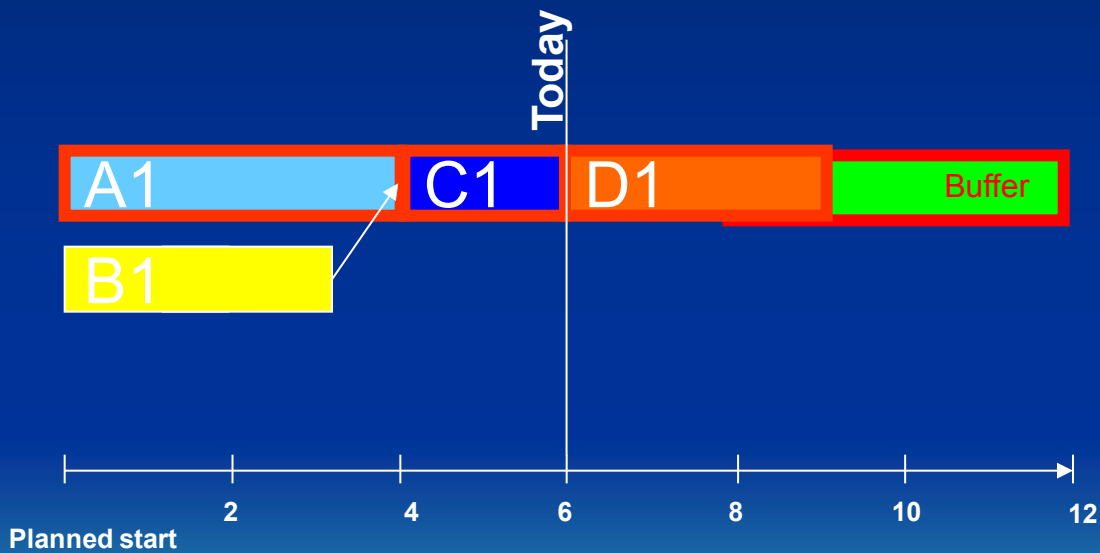

Plan with sharp deadlines with buffers 50% ($2+3+3=8$ $8+4=12$)

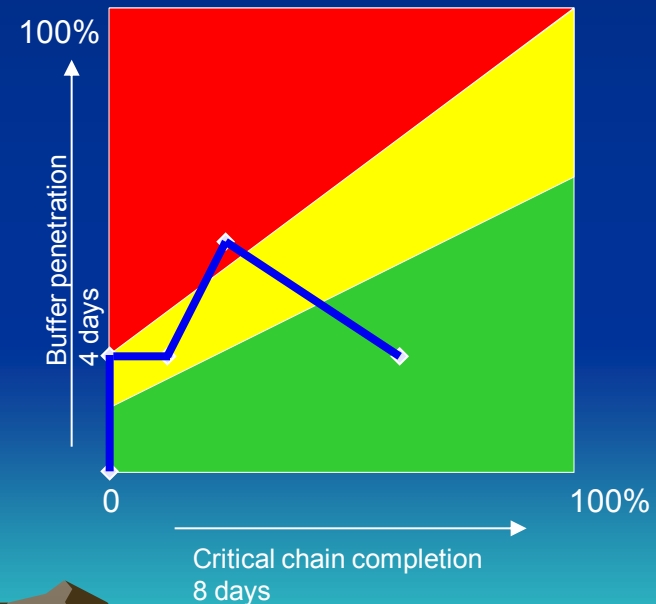

Plan 8 day after start

- A1 completed his task with 2 days delay
- B1 completed his task with 2 days delay
- C1 completed his task 1 day earlier than expected (planned)
- D1 needs one day more to complete

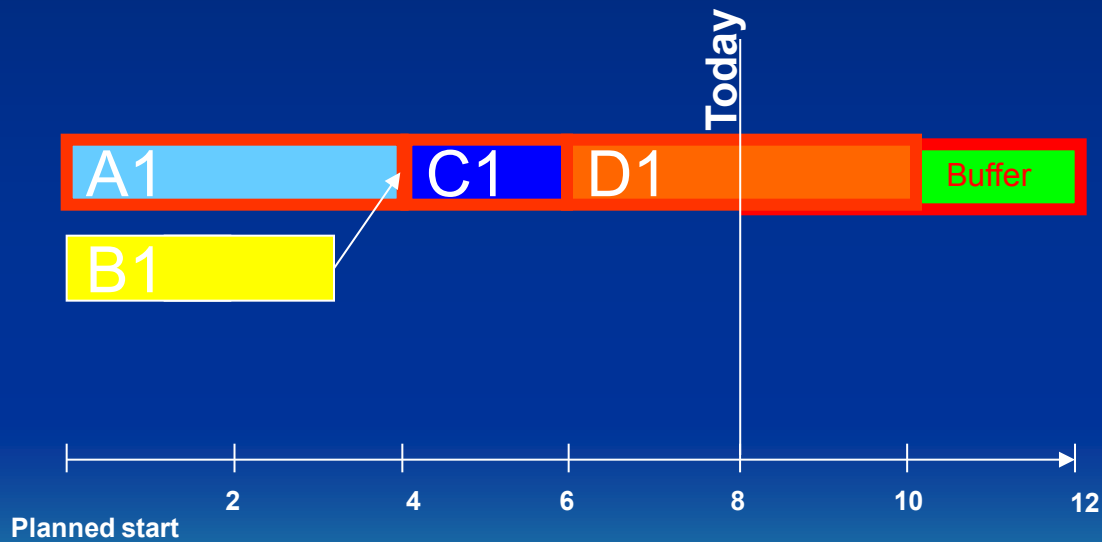

Plan with sharp deadlines with buffers 50% ($2+3+3=8$ $8+4=12$)

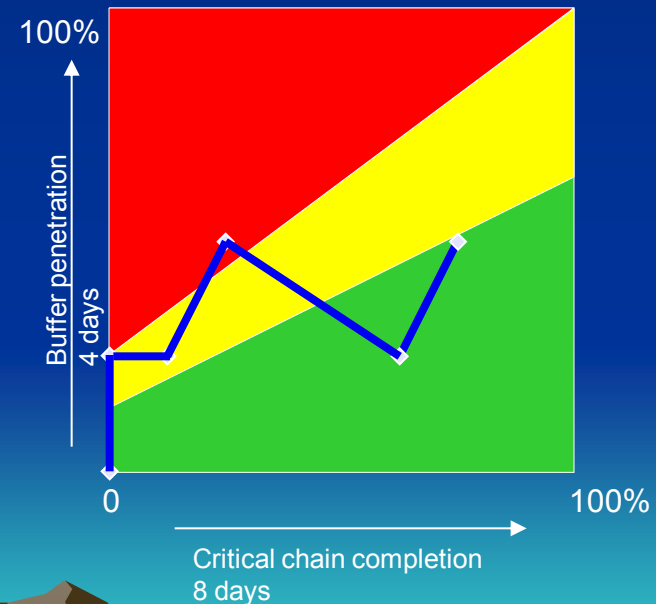

Plan 11 day after start

- A1 completed his task with 2 days delay
- B1 completed his task with 2 days delay
- C1 completed his task 1 day earlier than expected (planned)
- D1 completed his task with 2 days delay

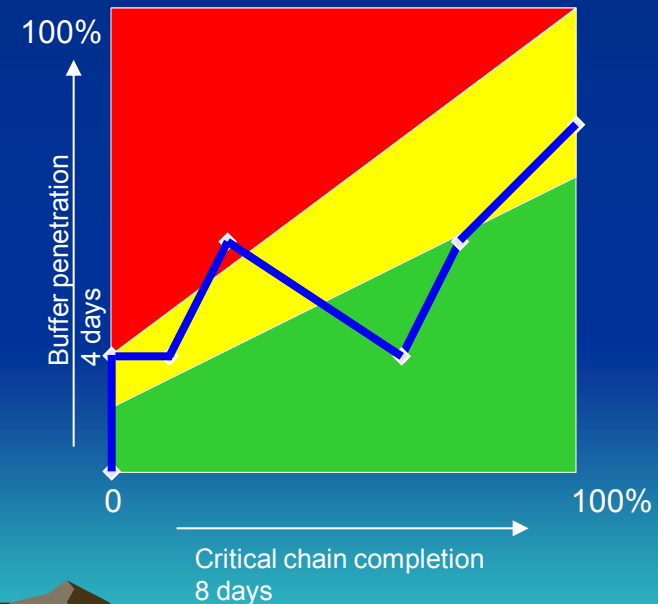
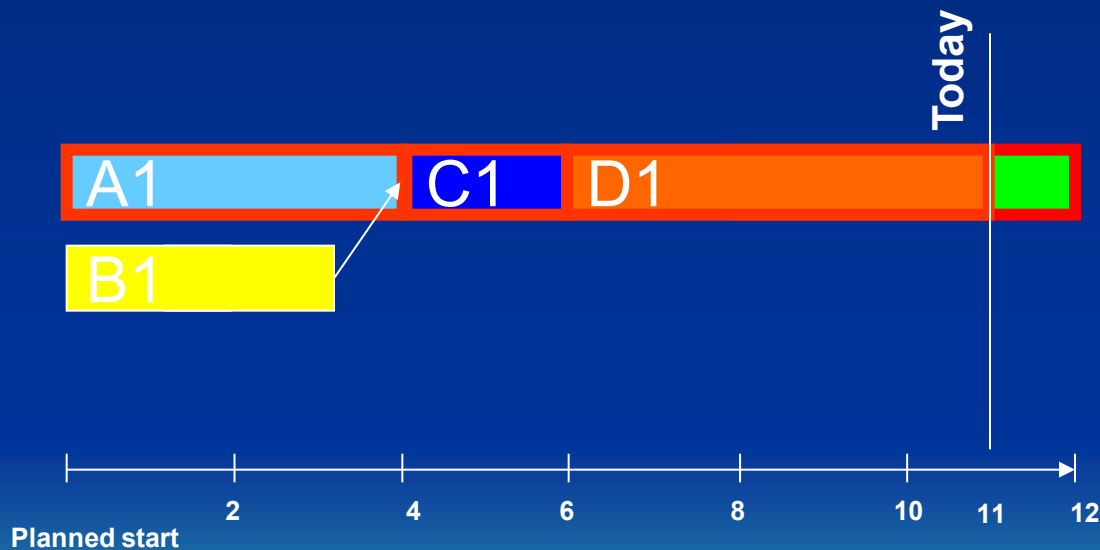

Plan with sharp deadlines with buffers 50% ($2+3+3=8$ $8+4=12$)

Clear way to setup and control priorities.

Setup of priorities of partial tasks based on assigned reserves.

Do as good as you can, but only where it is needed

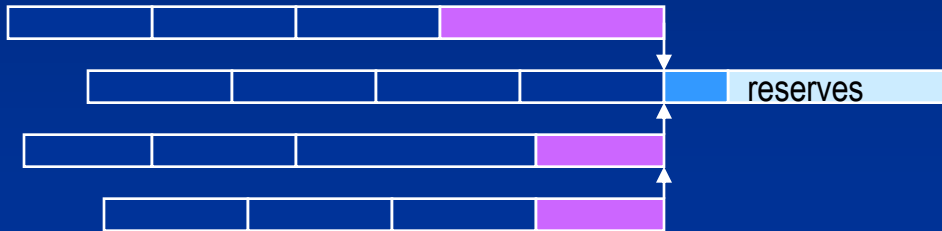

Project Quick, resources A-E and activities X,Z,X,W, and V

Resource and activity	Median of the required time
A-Y	10 days

Activity=Task

You can say, that 50 % of any activities finish earlier, and other 50 % will be delayed, meaning, that **10 days** represents 50 % of the estimated time for chosen activity

Project managers decided, that activity ends if 90 % of estimated time will be consumed. It means, that they add a time buffer of **8 days** (for the safety reasons). $10\text{ d} = 50\%$, $20\text{ d} = 100\%$, $2\text{ d} = 10\%$, $20\text{ d} - 2\text{ d} = 18\text{ d}$, $18\text{ d} - 10\text{ d} = 8\text{ d}$



5 x 10 days = 50 days

Time distribution

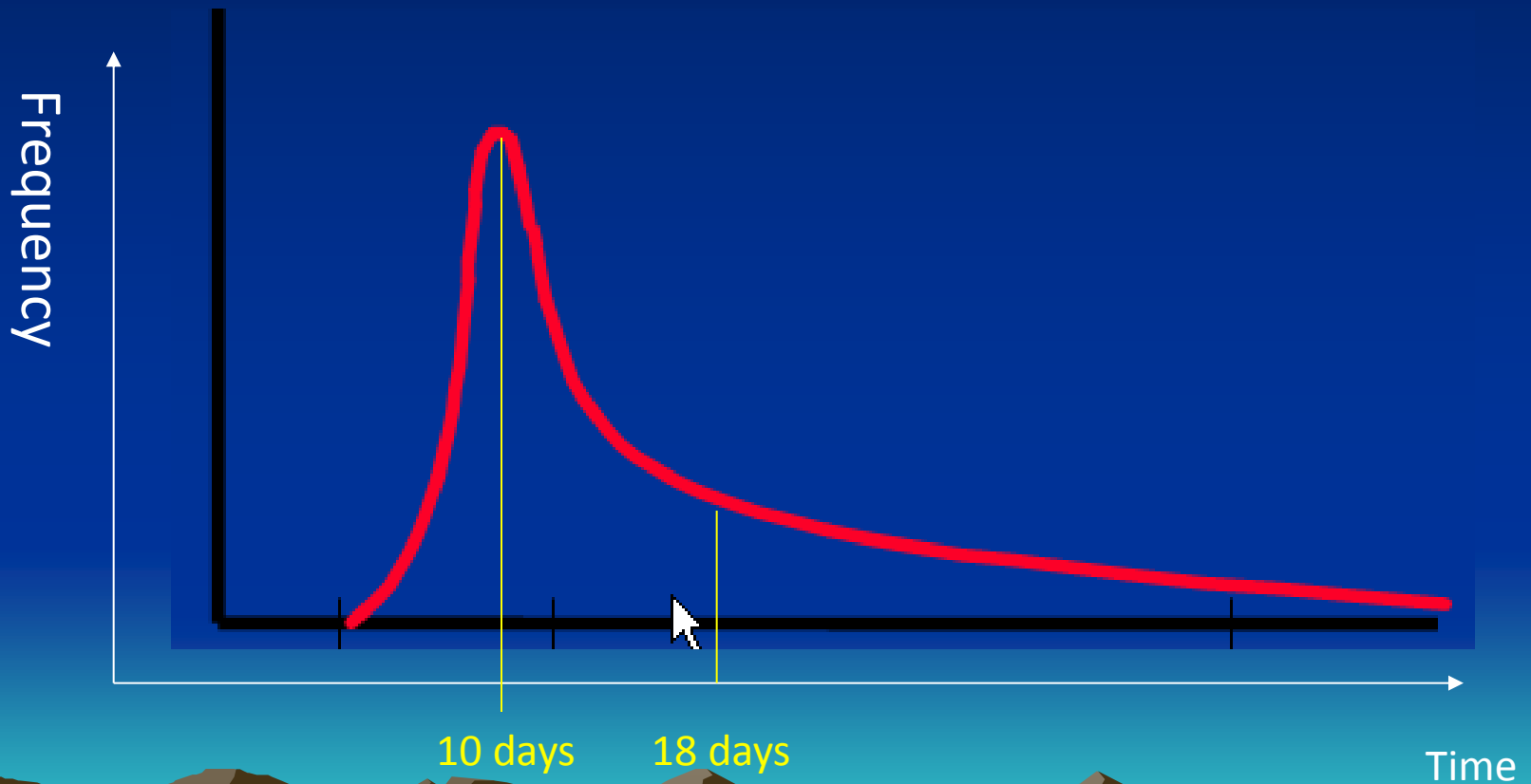

Five activities (tasks) and applied modifications

- If we consider for every activity time buffer 8 days we will get :

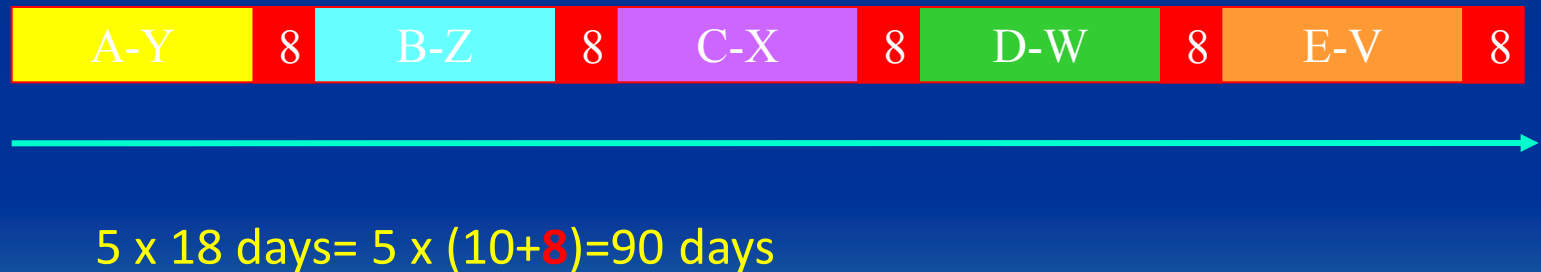
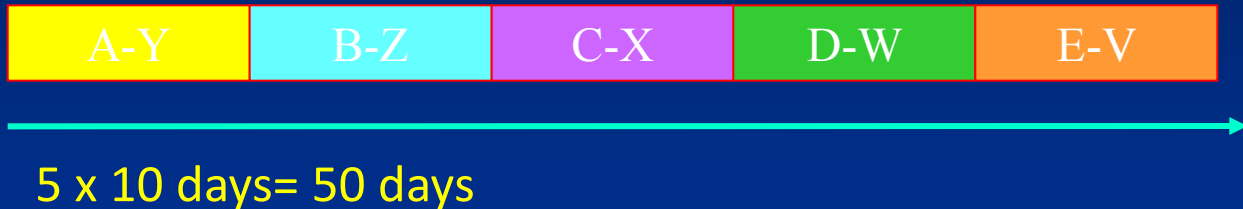

Five activities and modifications (added buffers) and four types of troubles

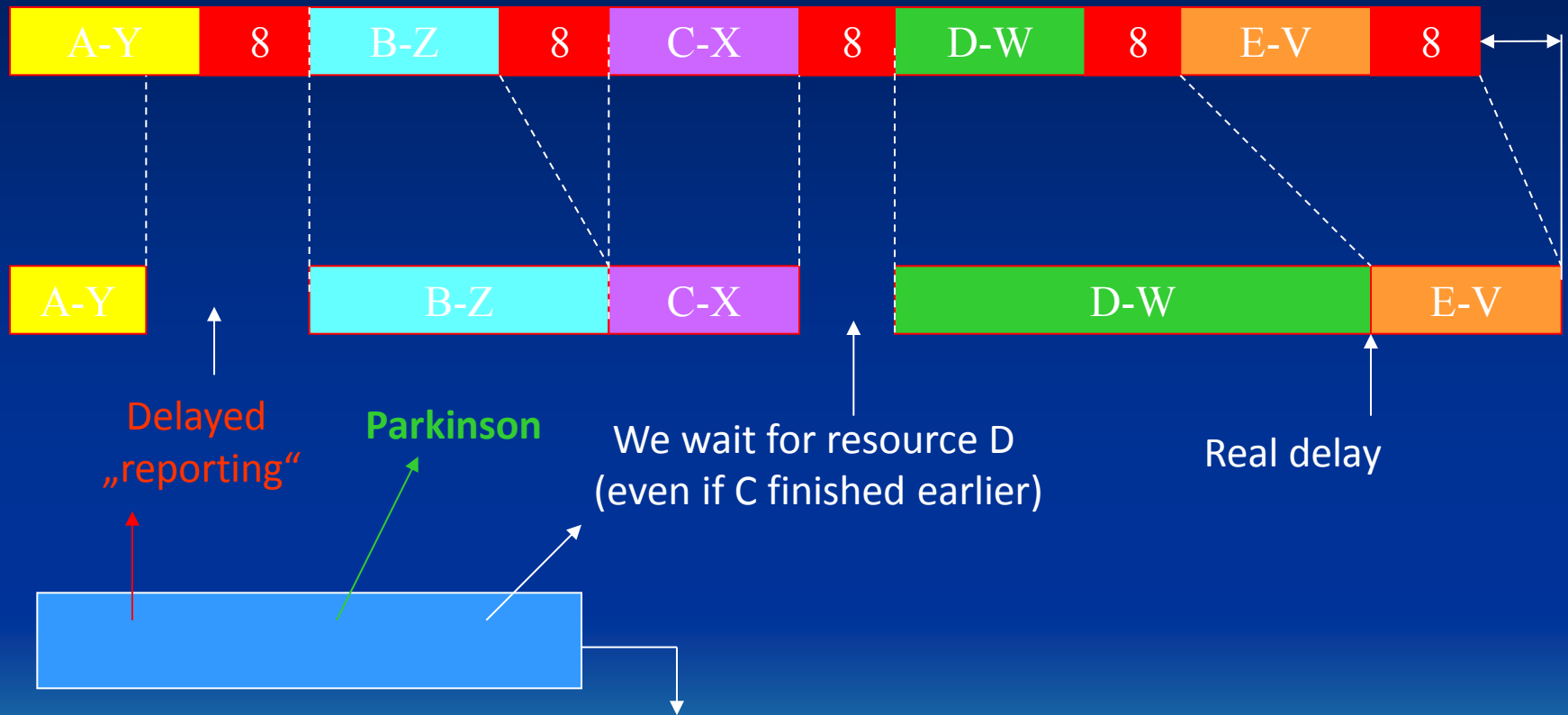

No one trouble causes project delay taking into consideration planned delivery date (agreed date of the project).

Dissipation of acquired time reserves was caused by company strategy saying strictly stick to the planned project schedule (example of rigid management)

Five projects after modification (buffers united to one and placed to the end of the project)



Parkinson

Little bit longer than 20 days median
but shorter than 18 days

Earlier end of
activity A



= CPB = current project buffer = 40 days



= new buffer = 50 % out of CPB, which makes $CPB/2$

Critical path- Critical chain

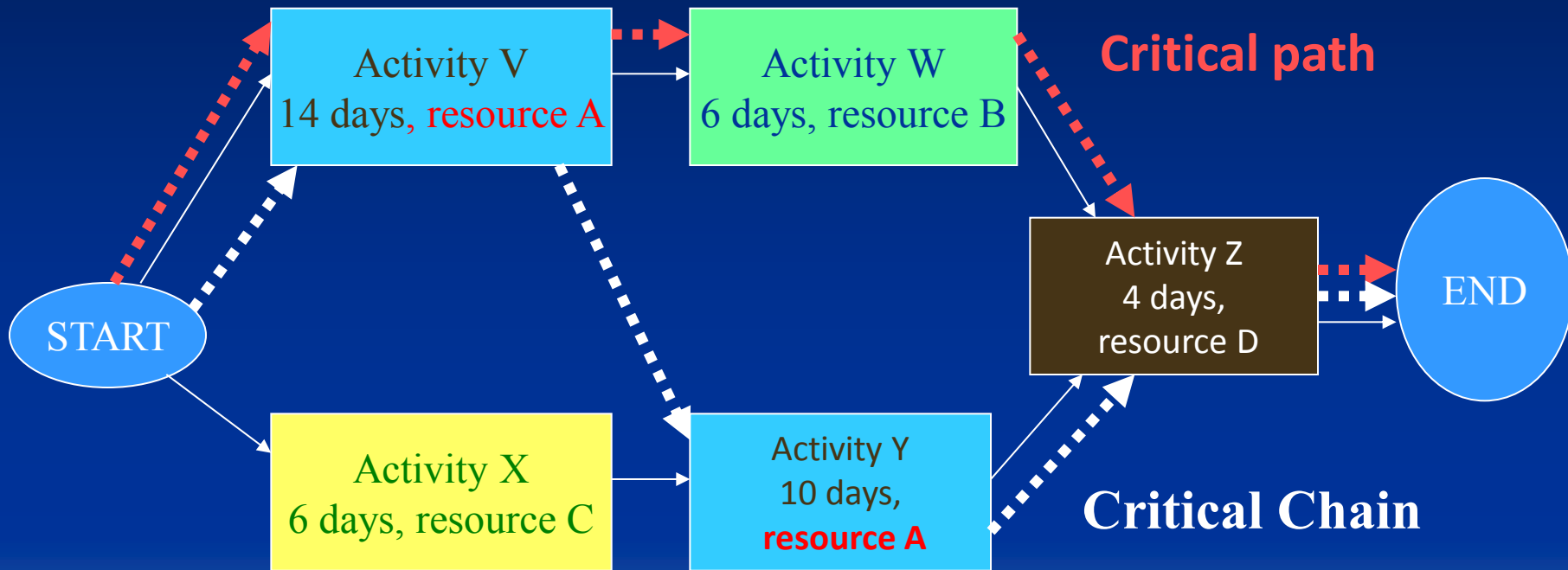

Project is considered as successful if is finished in expected time and financial budget is not exceeded

Critical chain with buffers

Length of the Critical Chain (white line):

$$7+5+2+7=21$$

and originally it was all in all 28 days

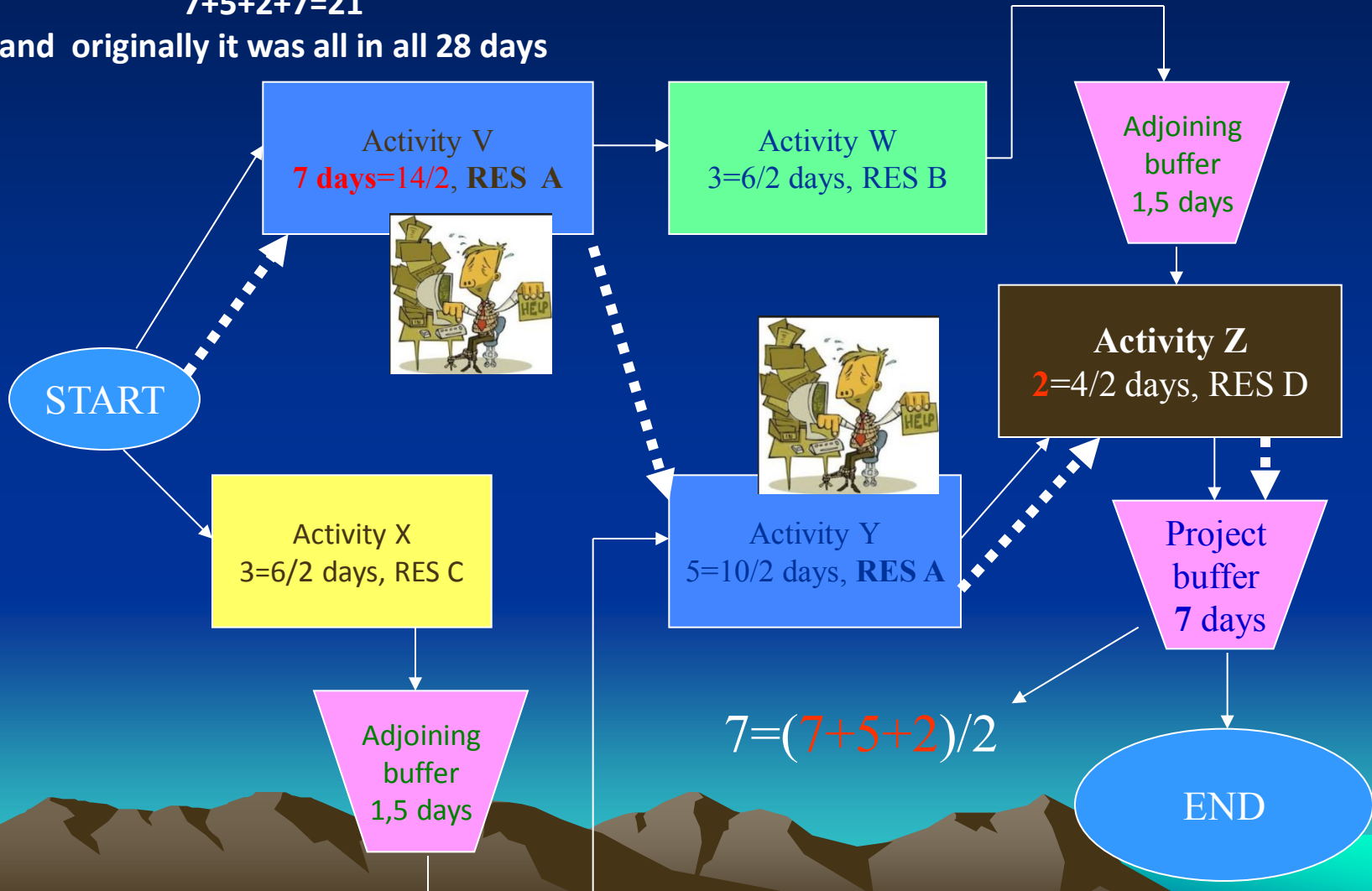

Buffer consumption

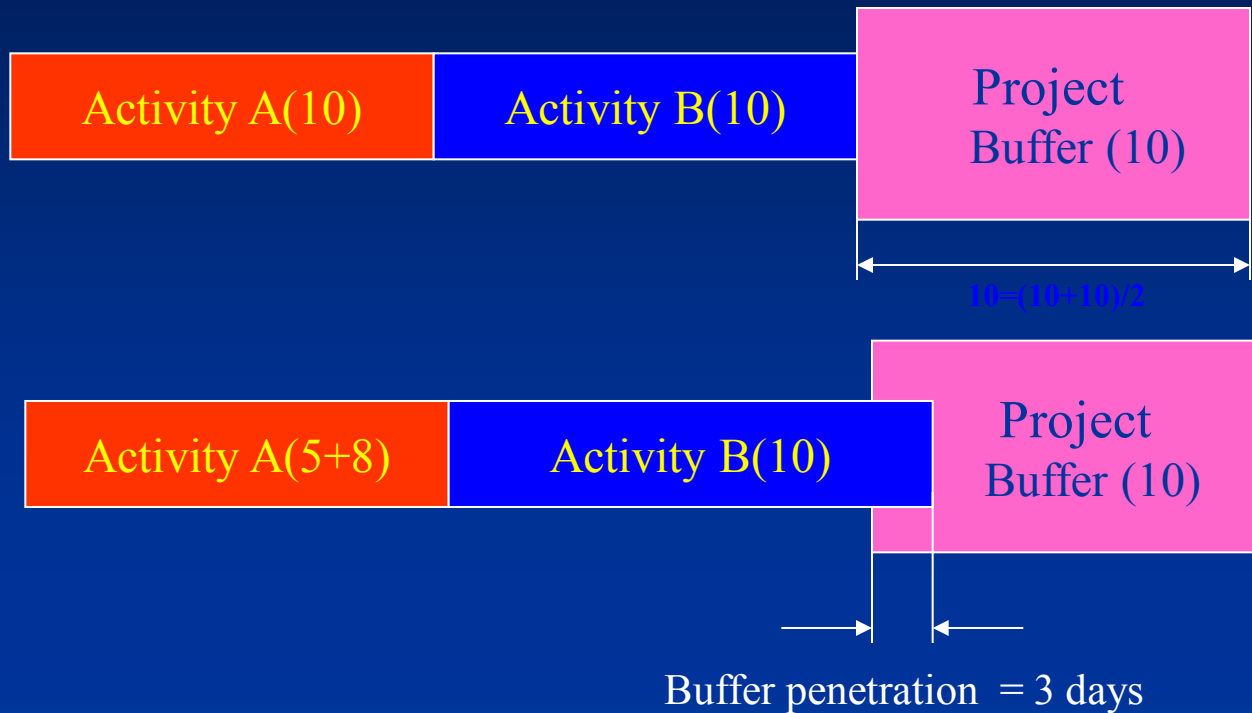

Rate of penetration is used to assign priorities to the partial activities



Priorities assigned to resources

- If one resource have to be assigned to two activities starting in the same moment so the first activity which will start is the one belonging to the project with bigger project buffer penetration
- If none of all project buffers were penetrated with previous activities, so the first starts this activity which belongs to the critical chain. 

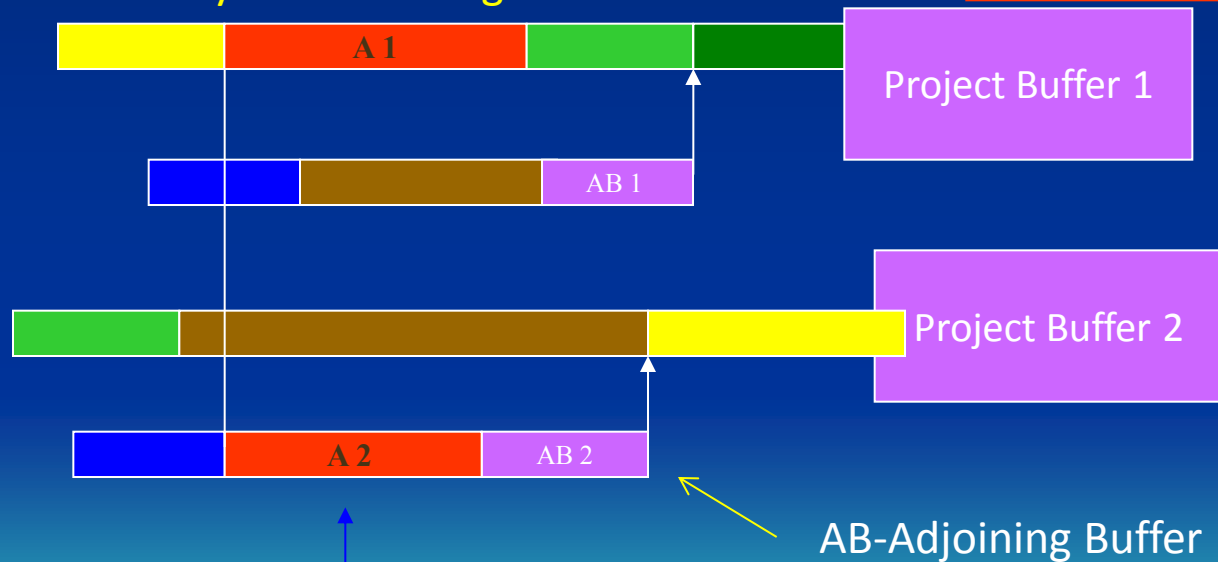

A2 starts first because PB 2 is partially consumed (penetrated)

Priorities assigned to resources

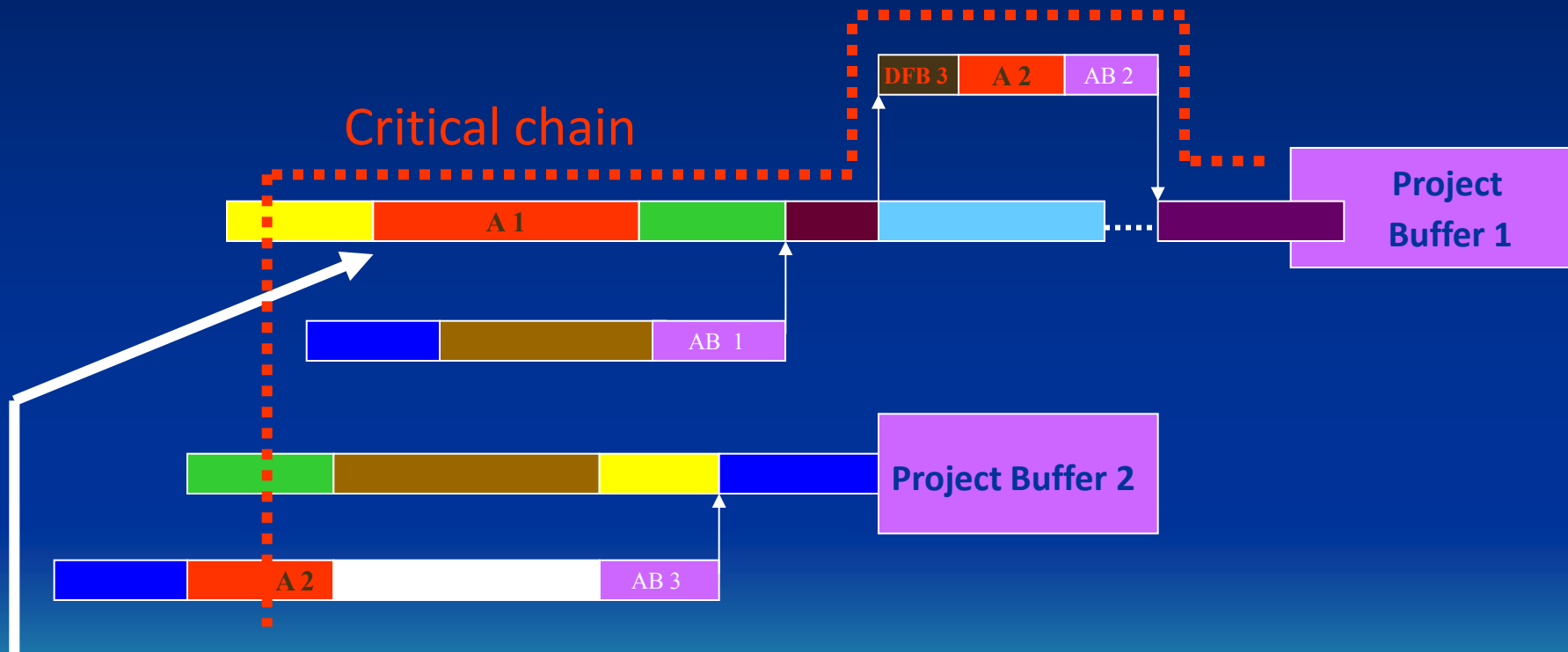

This activity (A1) starts first because it is a part of the Critical chain and Project Buffer 1 is penetrated

Main benefits of the Critical Chain (CC) usage

- Every single project ends significantly earlier, than projects where other project management methods than CC were applied
 - Total time needed to end more project than one is markedly shorter
 - Promised delivery times are fulfilled with higher rate of credibility
 - You will have more free capacity of all used resources
- 

Main benefits of the Critical Chain (CC) usage

(Home study)

- Better initial estimation about project timing and thus bore accurate planning
- During starting of the projects you did not meet any problem taking into consideration drum resource
- Decrease of unfavourable effects such as Student syndrome, Murphy attacks and impacts of Parkinson s laws by redeployment and integration of all buffers to one and only one project buffer at the end of the project
- Utilization of benefits caused by earlier ended activities
- Use of reporting system which provides you with valuable information of buffer penetration , the extent of time reserves and thus better helping system for assigning priorities



Desirable attributes of a Project Manager

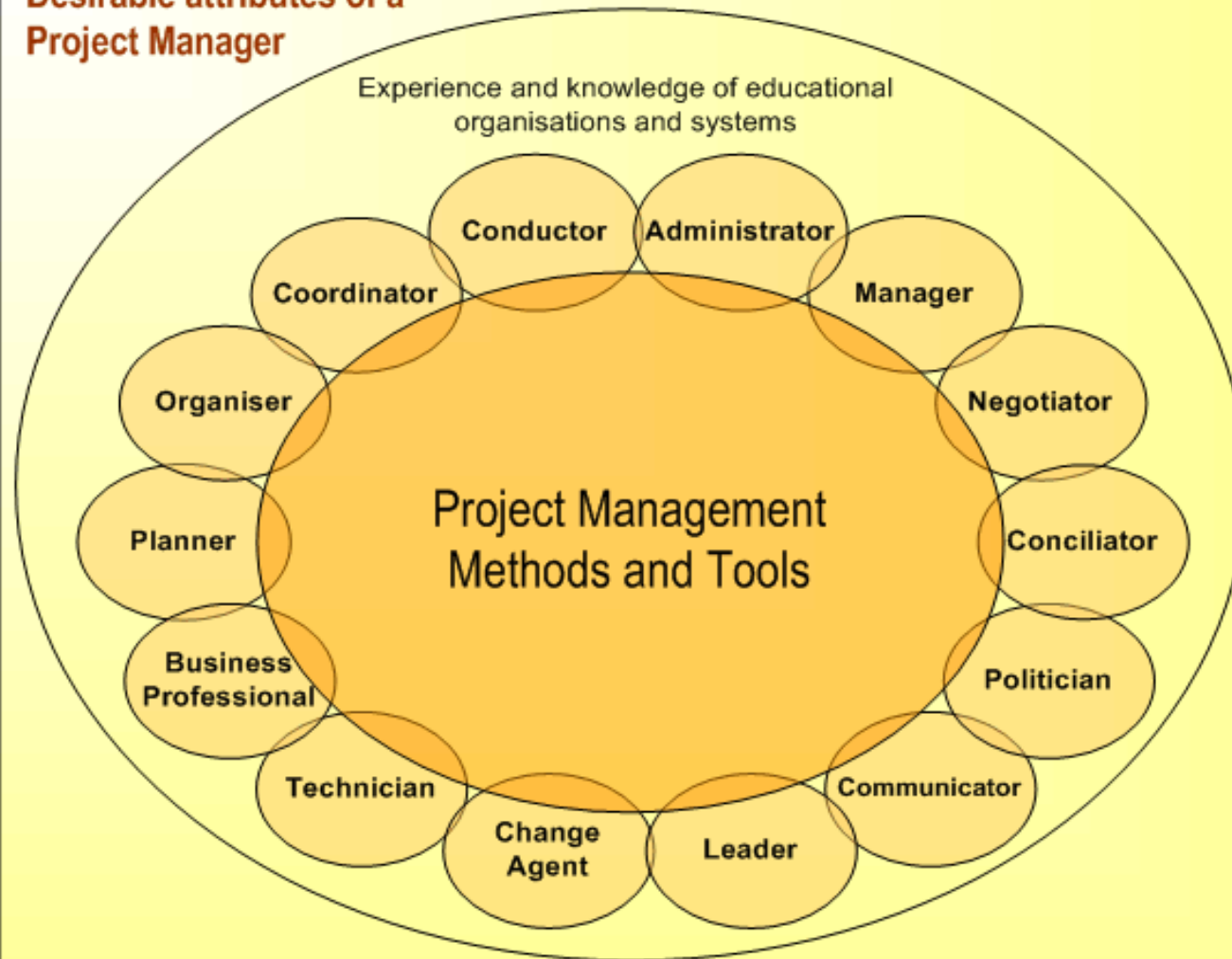

Waterfall –Big design up front, milestones,..no iterations !!

Agile methodology– Scrum (Sprints,..)

Critical Chain- based on TOC –
(see https://www.youtube.com/watch?v=mpc_FdAt75A)

Prince2 -Projects IN Controlled Environments (rolling wave planning)

Lean



Waterfall - predictive approach

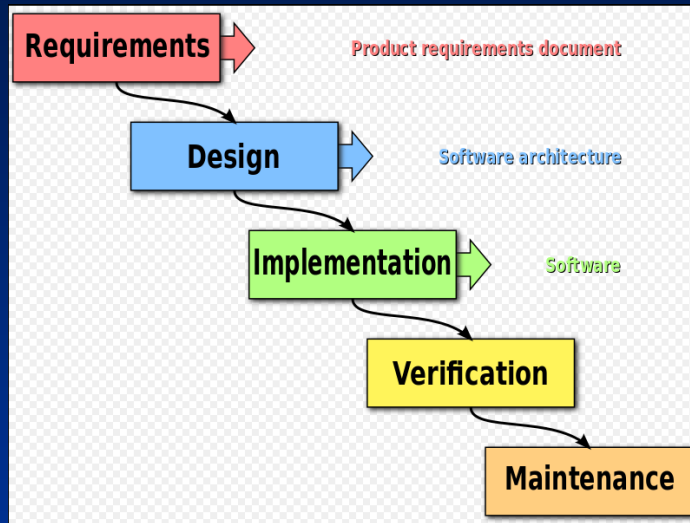

Clients may not know exactly what their requirements are before they see working software and so change their requirements, leading to redesign, redevelopment, and retesting, and increased costs

One of the differences between agile software development methods and waterfall is the approach to quality and testing. In the waterfall model, there is always a separate **testing phase** after a **build phase**; however, in **agile software development** (see next slide) testing is completed in the same iteration as programming

Agile PM approach – for instance SCRUM

Scrum is an iterative and incremental agile SW development framework for managing product development

A key principle of **Scrum** is the dual recognition that customers will change their minds about what they want or need (often called requirements volatility) and that there will be unpredictable challenges for which a **predictive** or planned approach is not suited

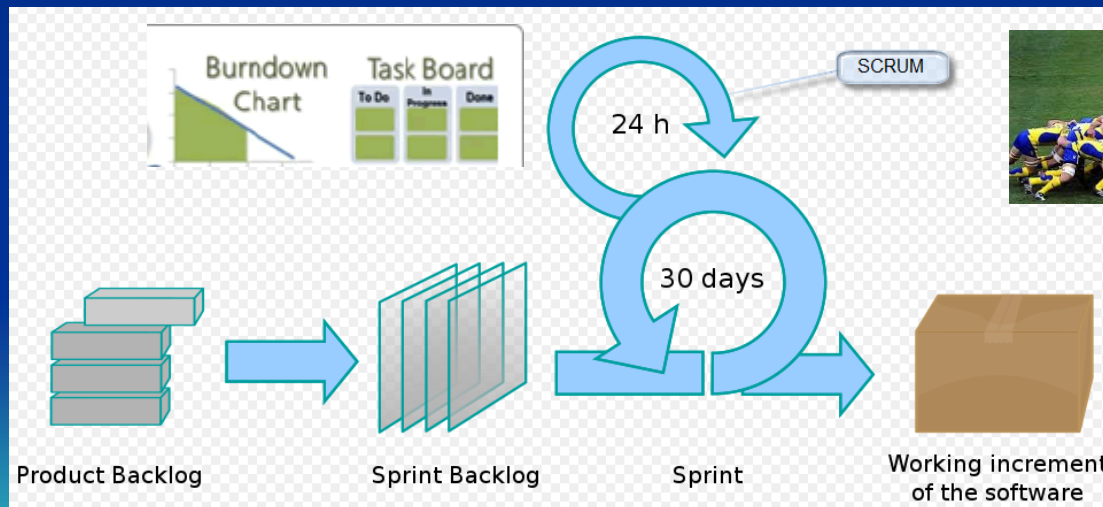

Sprint->Stage
Scrum ->Iteration, daily work

SCRUM

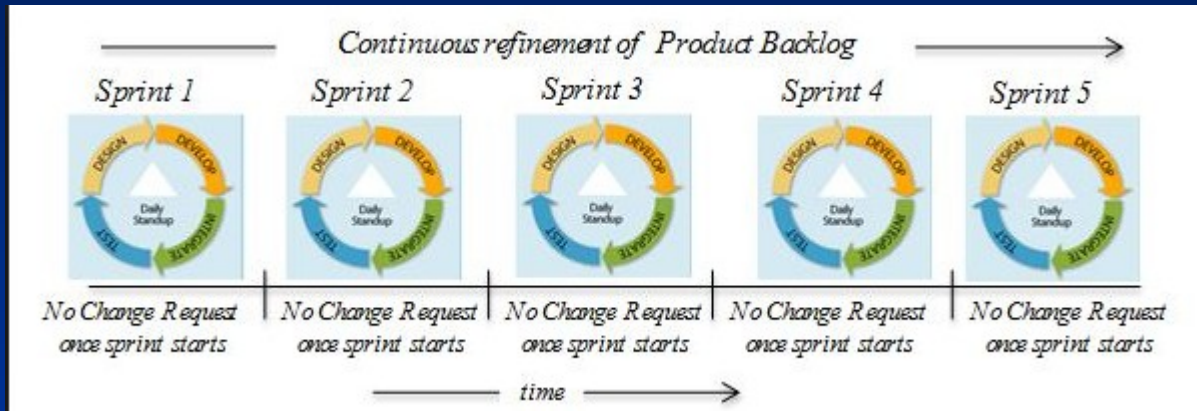

Prince2

The seven Prince2 principles are:

1. Continued Business Justification
2. Learn from Experience
3. Defined Roles and Responsibilities
4. Manage by Stages
5. Manage by Exception
7. Focus on Products
8. Tailor to Suit the Project Environment

Not suitable for SW project e.g. SRUM,
based on best practice, use WBS,roles,... suitable for corporate projects,



Prince2

Corporate or Programme Management

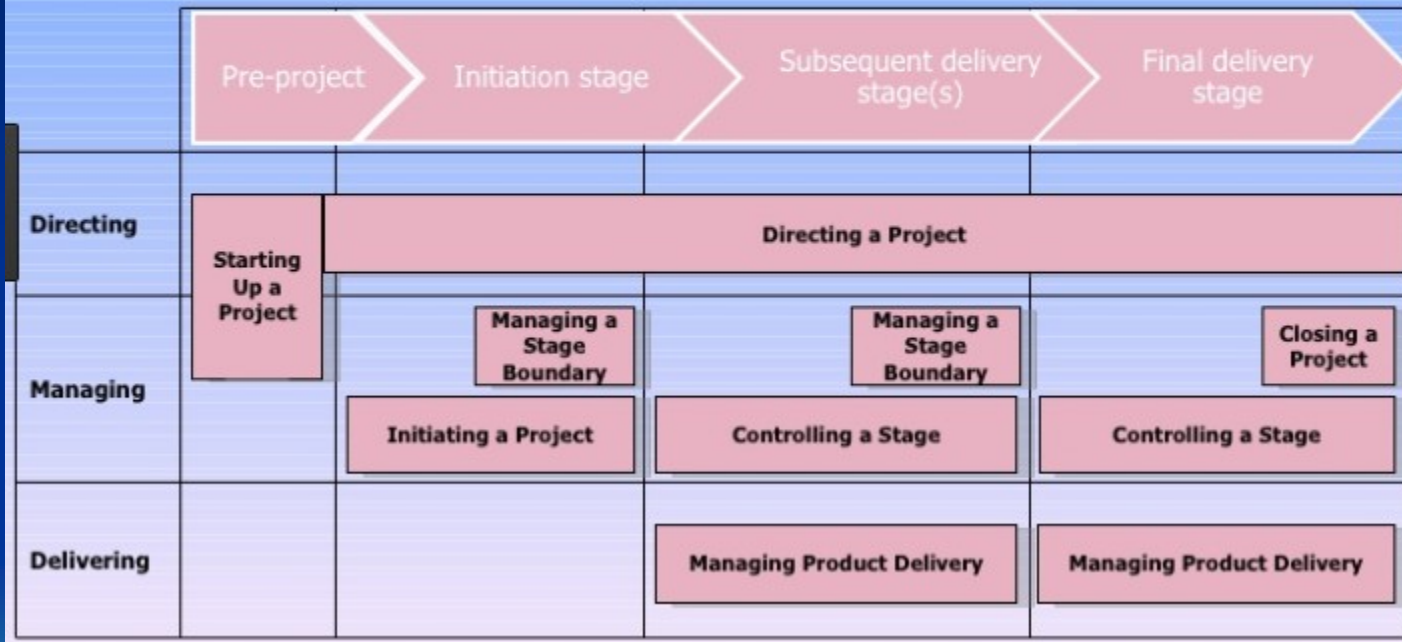

Prince2

7 crucial themes, limitless benefits:



<http://www.fortezzaconsulting.com/blog/5-myths/>

<https://www.workflowmax.com/blog/choose-your-project-management-methodology-pros-and-cons-of-agile-waterfall-prism-and-more>



Thanks for Your Attention

