

Analysis Patterns

PV167 Project in Object-oriented Design of Information Systems

Analysis Patterns

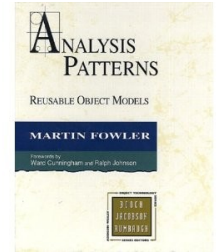

✧ **Analysis Patterns: Reusable Object Models** by Martin Fowler, 1997

- Accountability
- Observations and Measurements
- Observations for Corporate Finance
- Referring to Objects
- Inventory and Accounting
- Planning
- Trading
- Derivative Contracts
- Trading Packages

Accountability – Party pattern

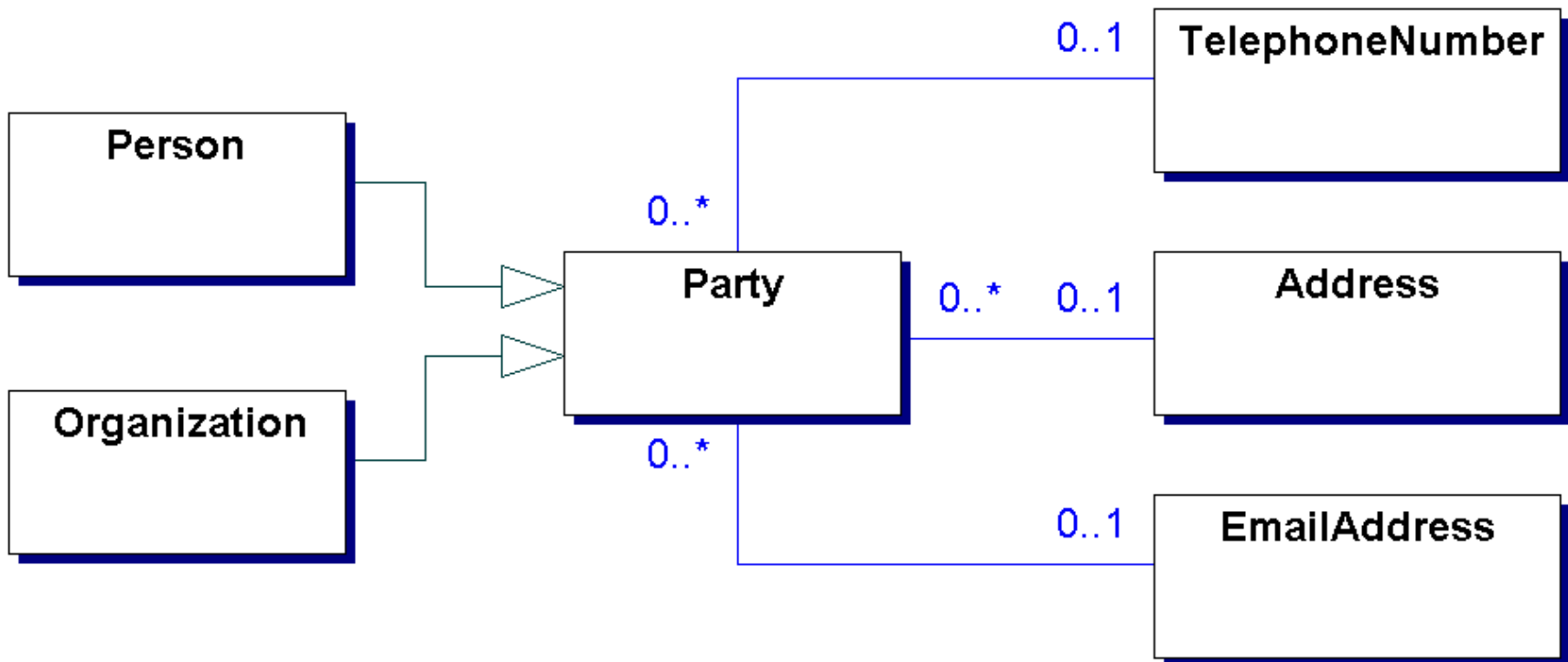
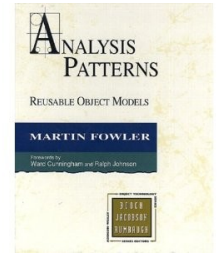

Ollie's Order Center: Party pattern

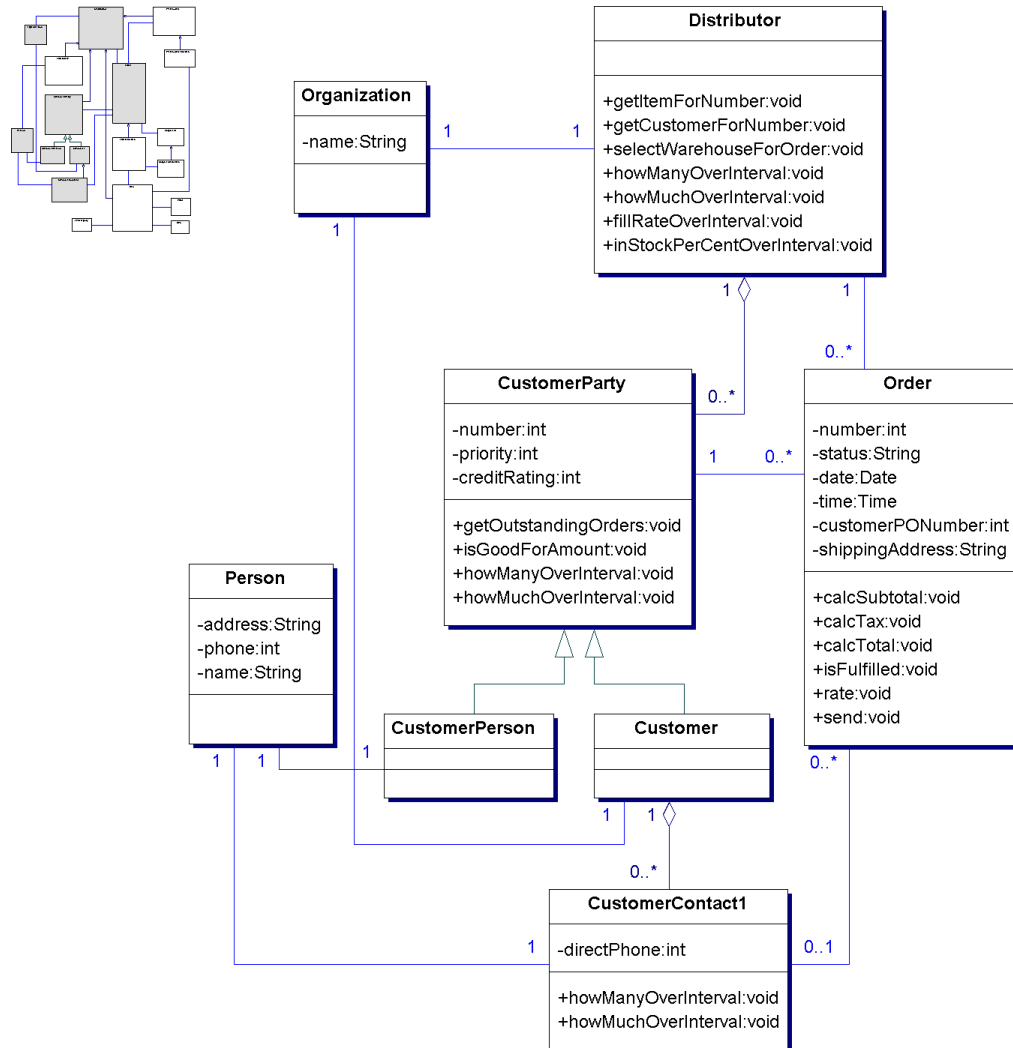
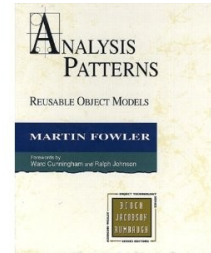

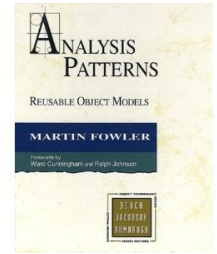

Accountability – Accountability pattern

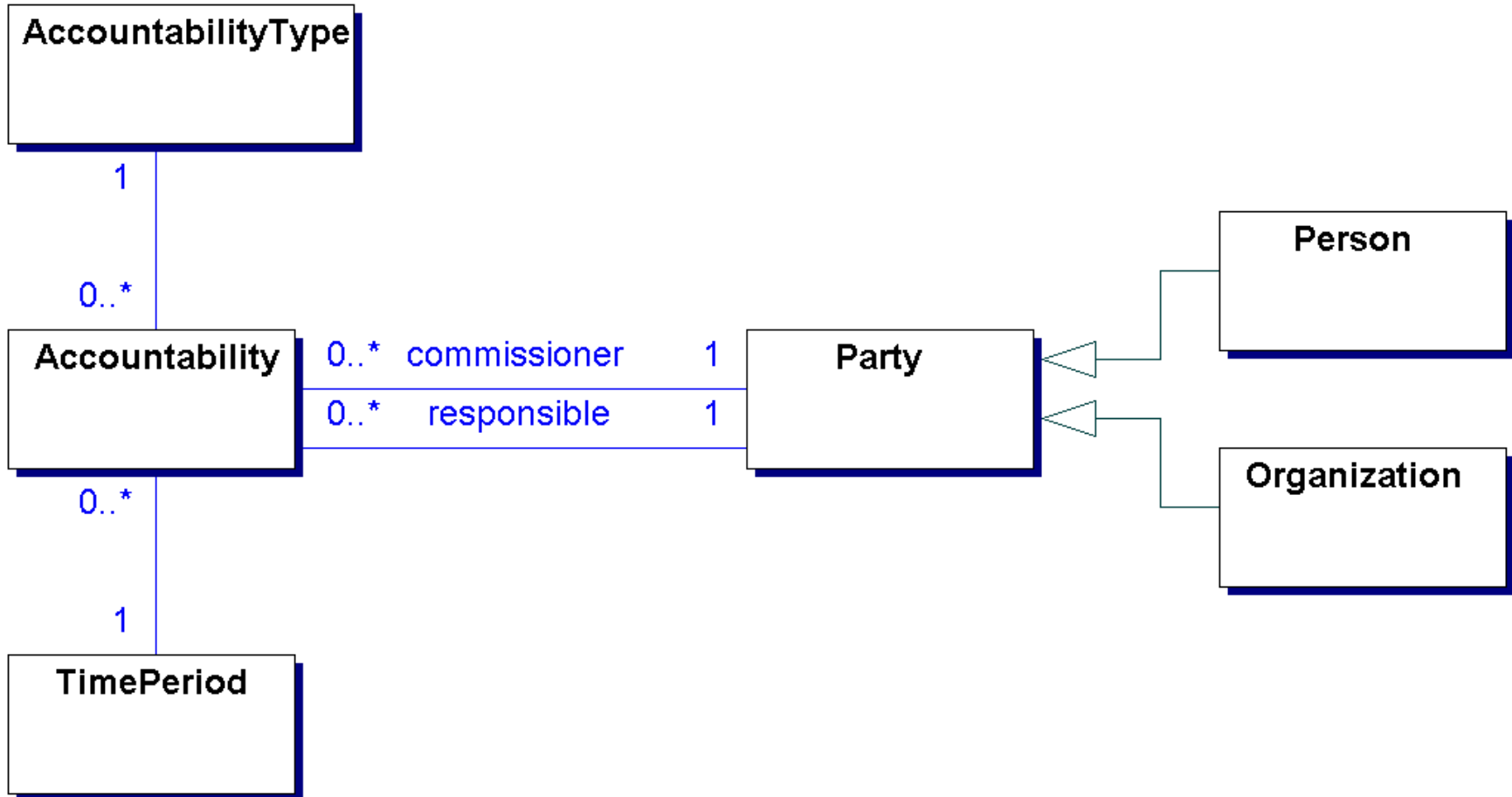

Observations and Measurements – Quantity pattern

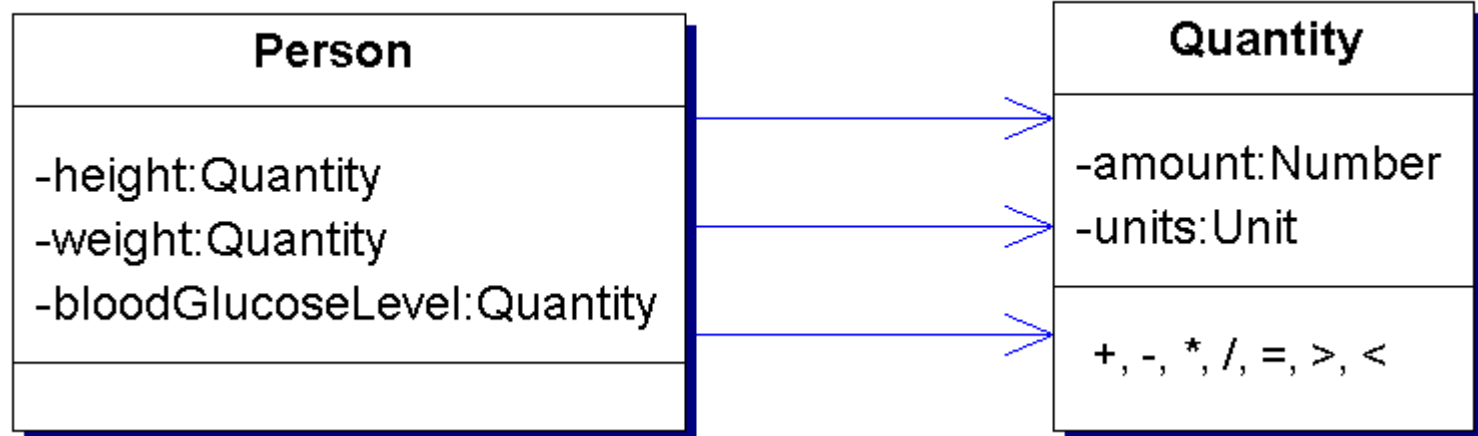
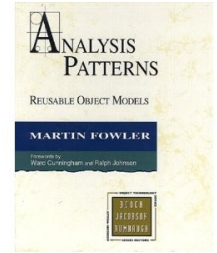

Ollie's Order Center: Quantity pattern

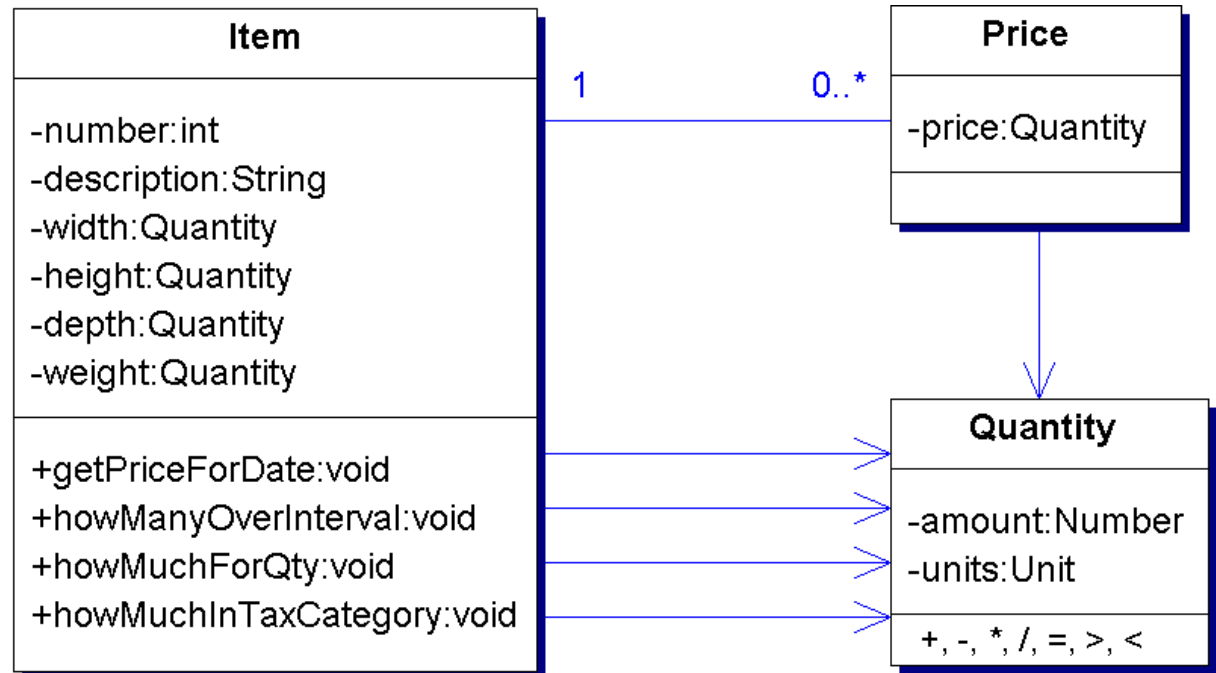
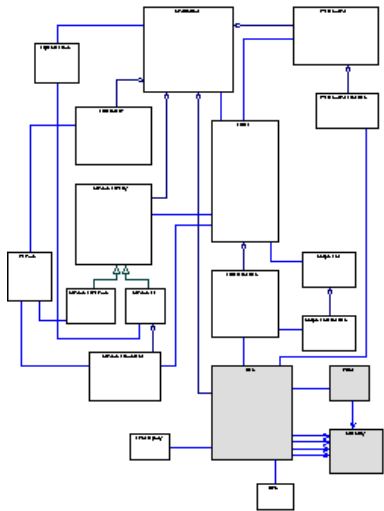
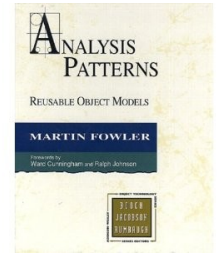

Observations and Measurements – Conversion Ratio pattern

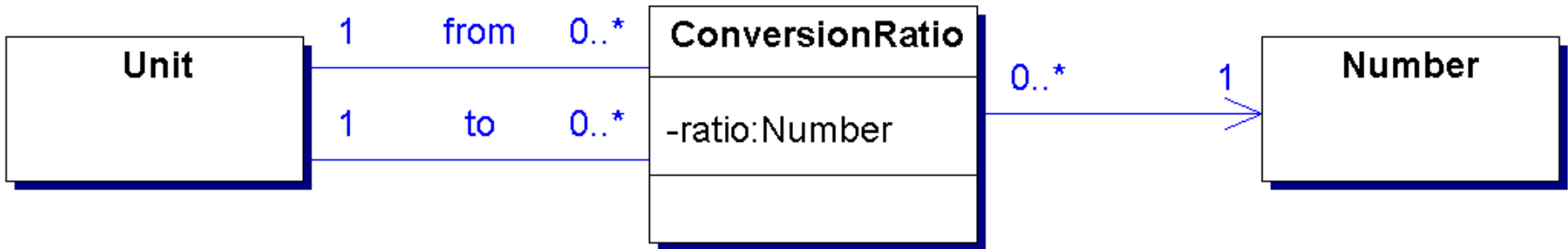
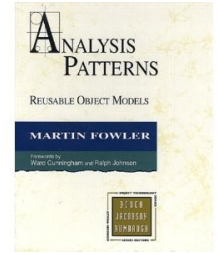

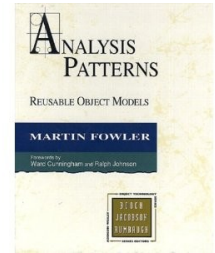

Ollie's Order Center: Conversion Ratio pattern

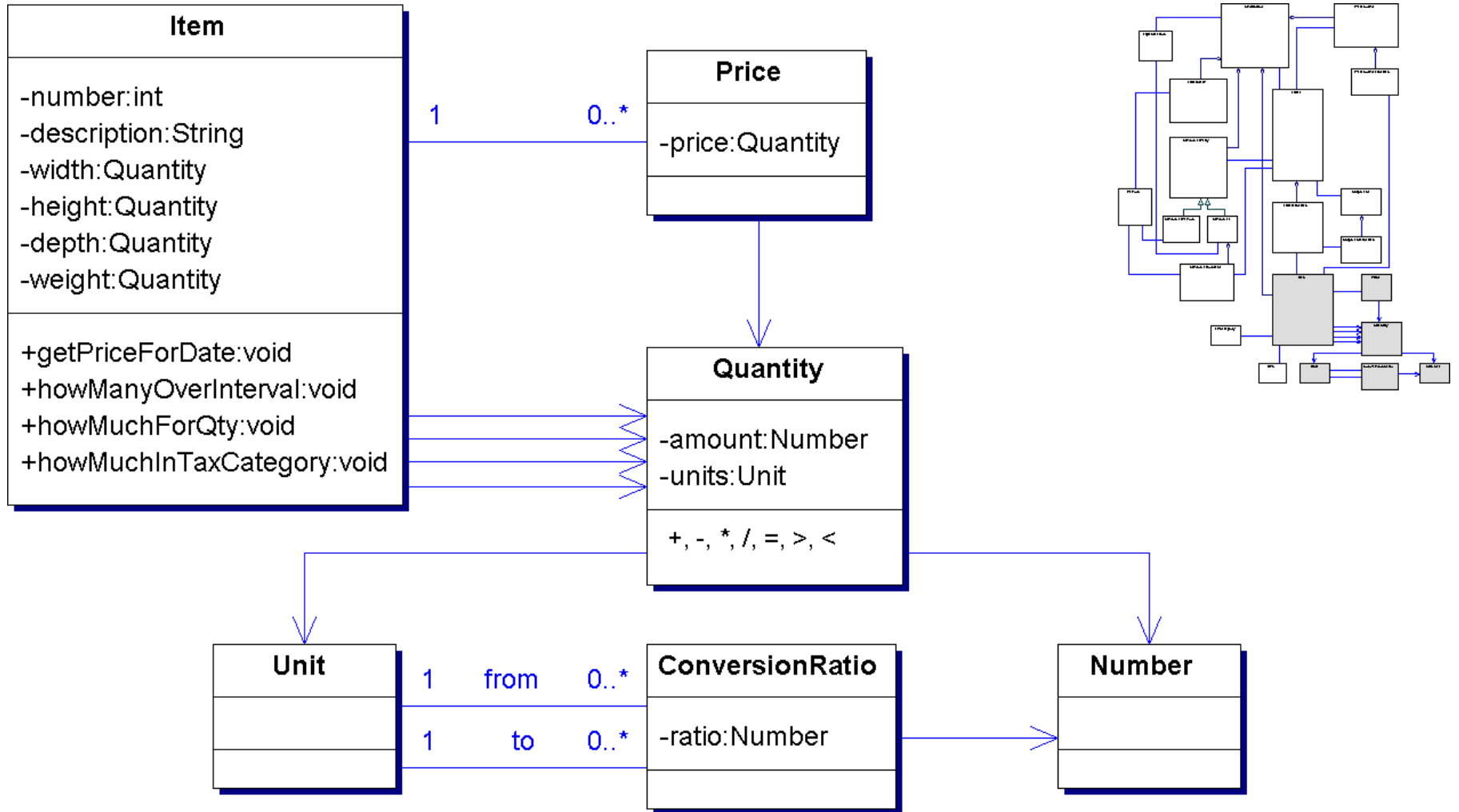

Observations for Corporate Finance – Enterprise Segment pattern

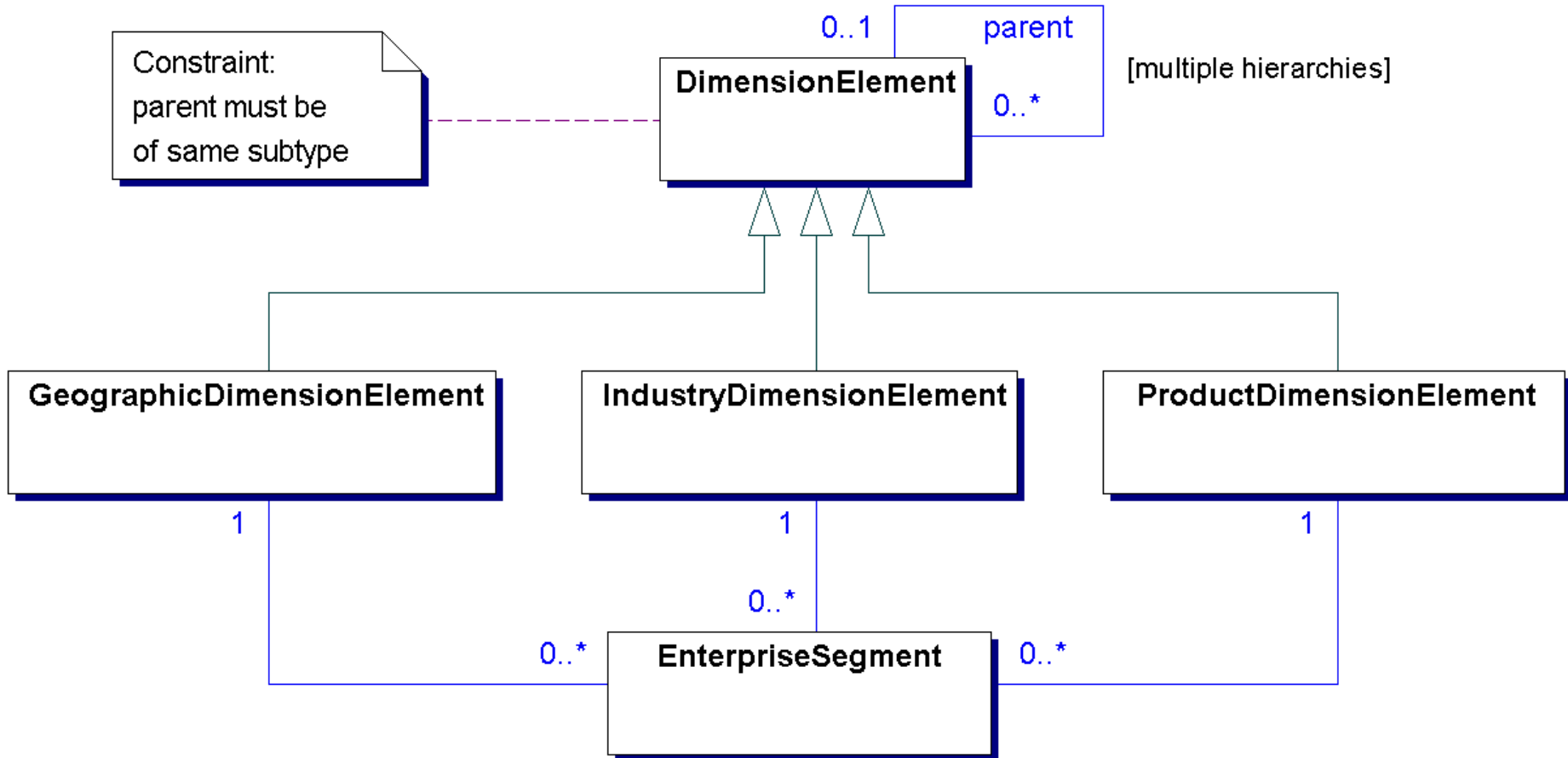
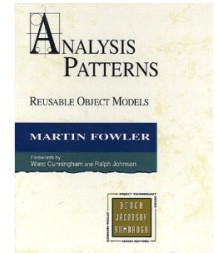

Referring to Objects – Name pattern

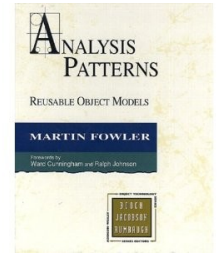

One name:

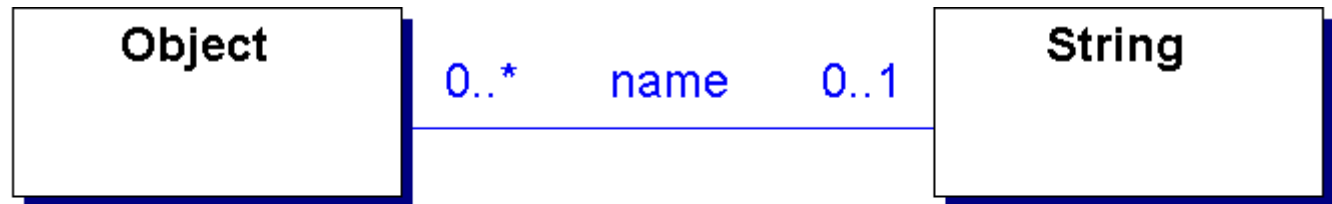

More names:



Identifier:



Referring to Objects – Identification Scheme pattern

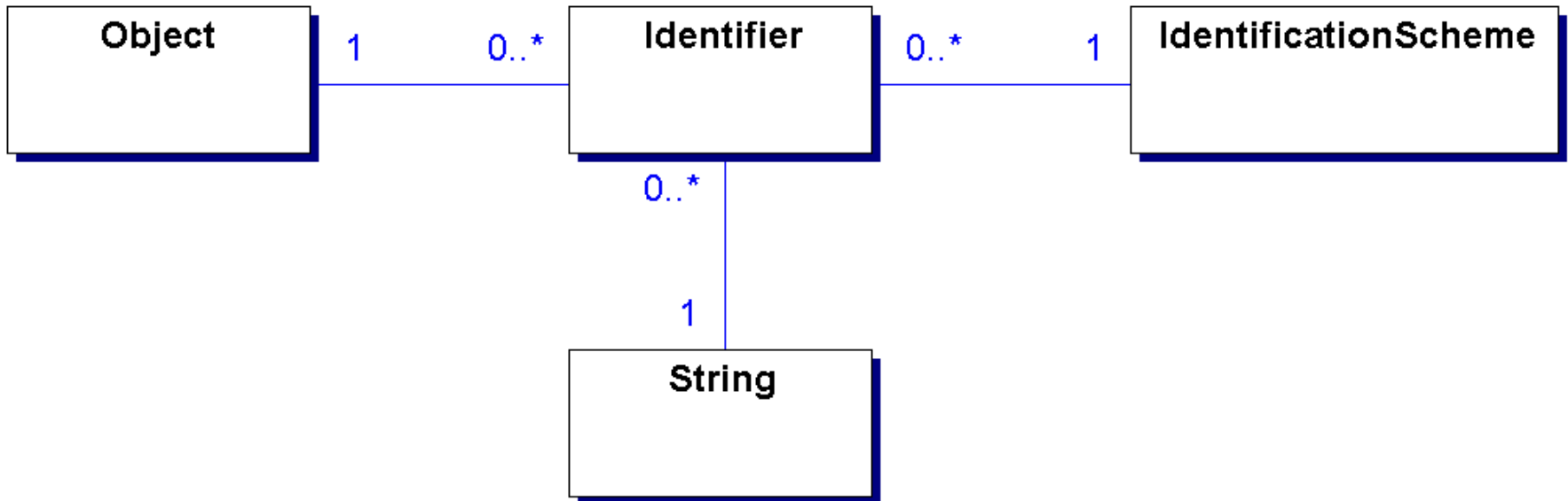
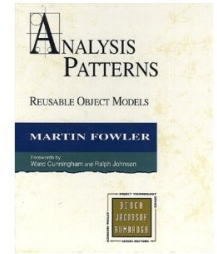

Ollie's Order Center: Identification Scheme pattern

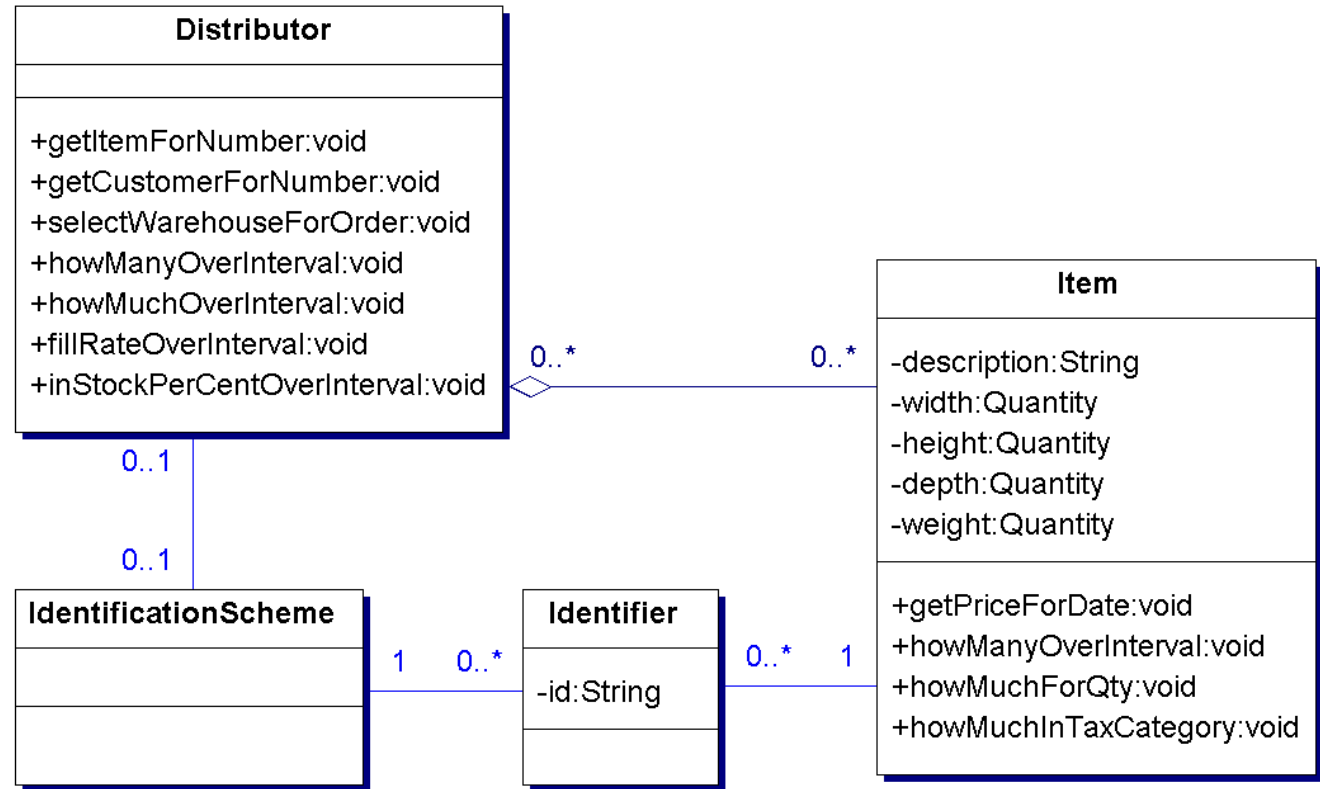
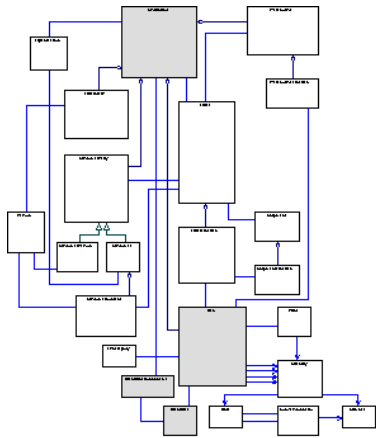
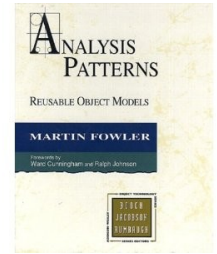

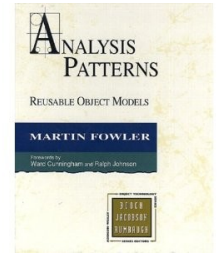

Inventory and Accounting – Account pattern

Constraint:
balance = sum(entries.amount)

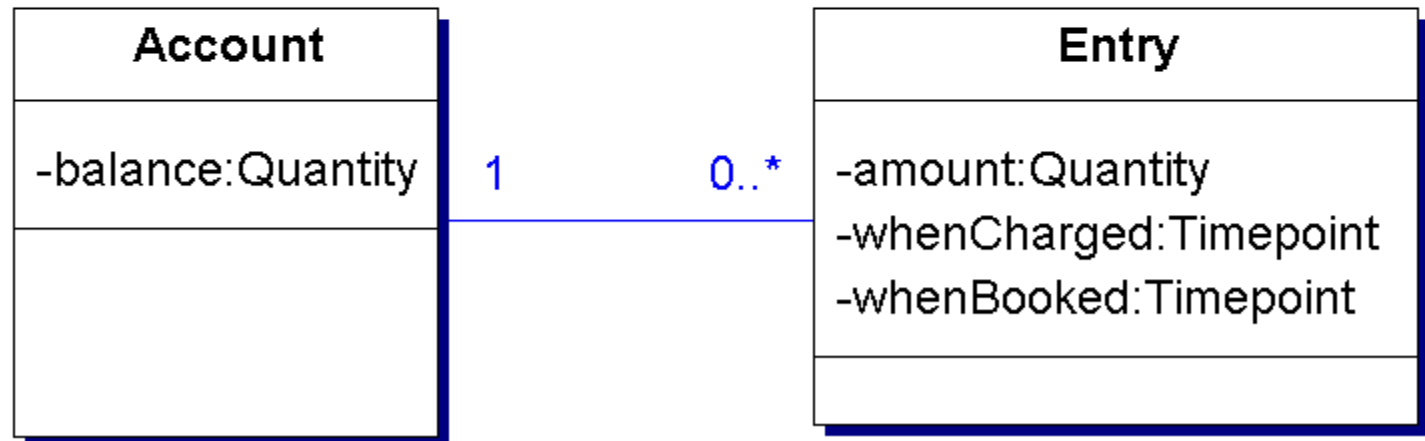

Ollie's Order Center: Account pattern

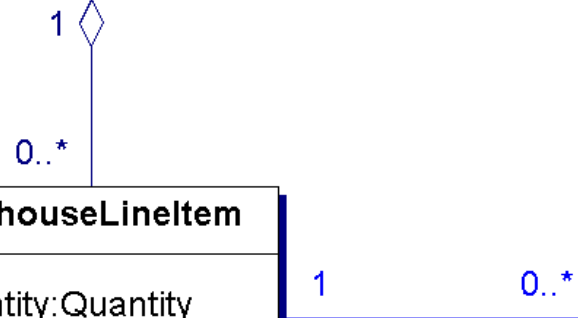
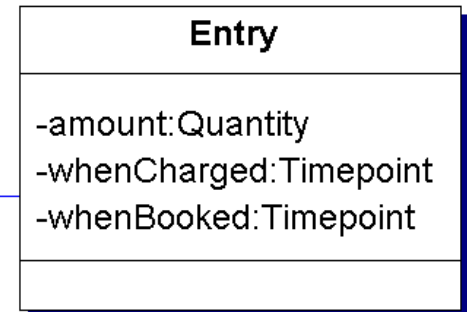
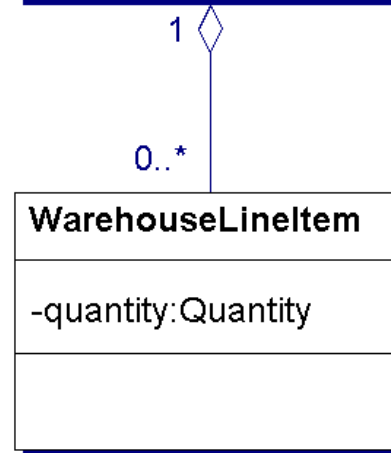
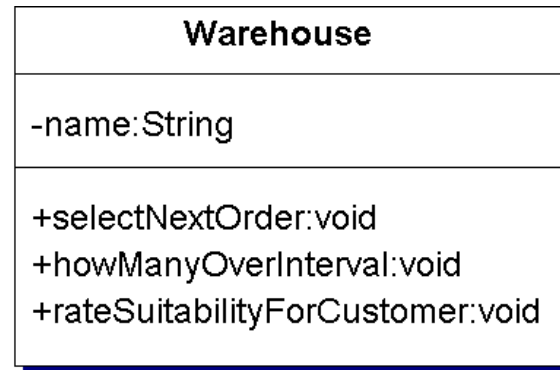
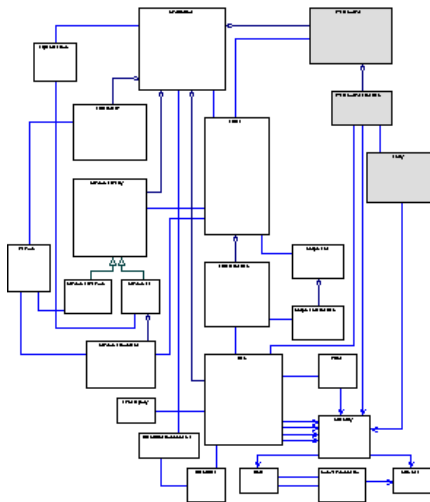
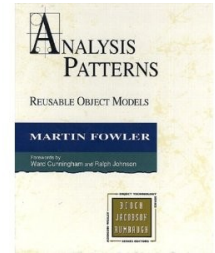

Inventory and Accounting – Transactions pattern

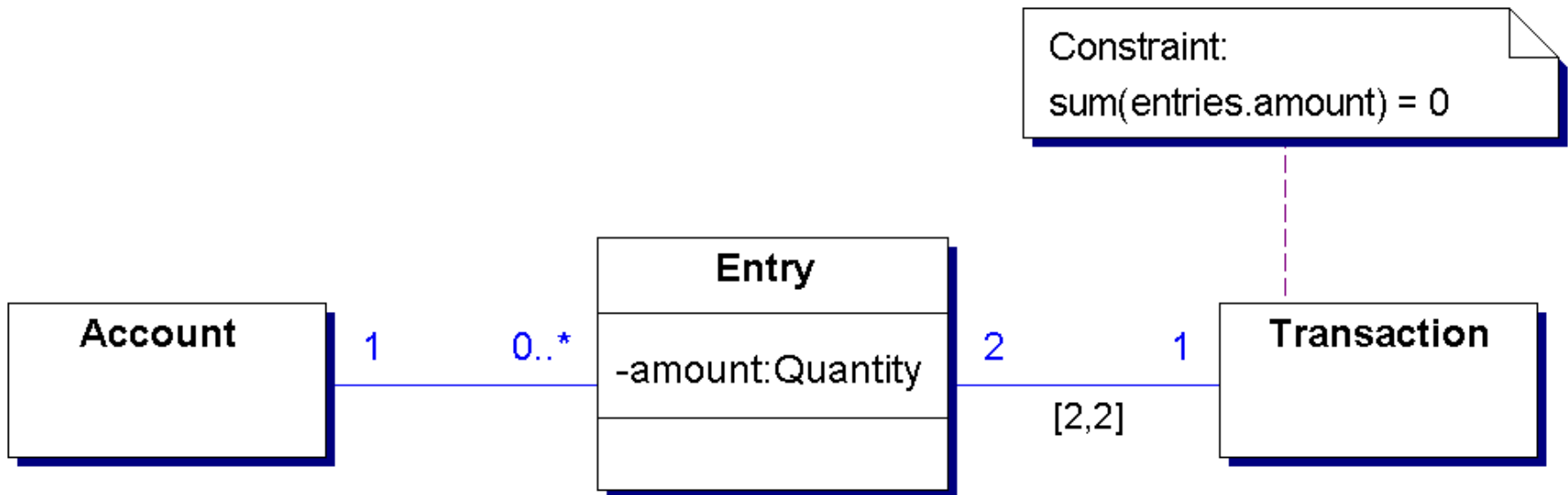
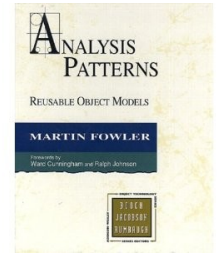

Planning – Proposed and Implemented Action pattern

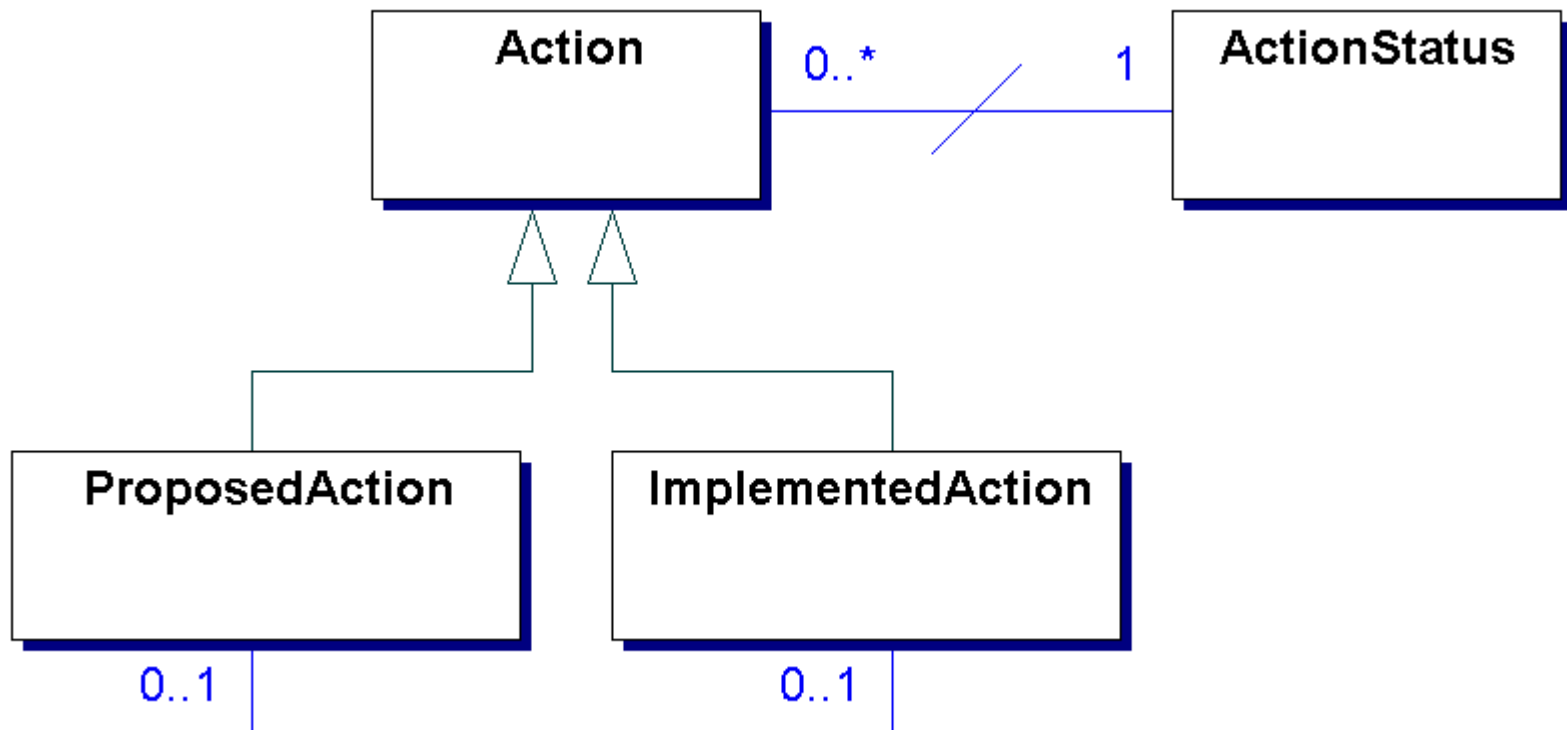
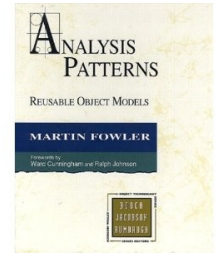

Ollie's Order Center: Proposed and Implemented Action pattern

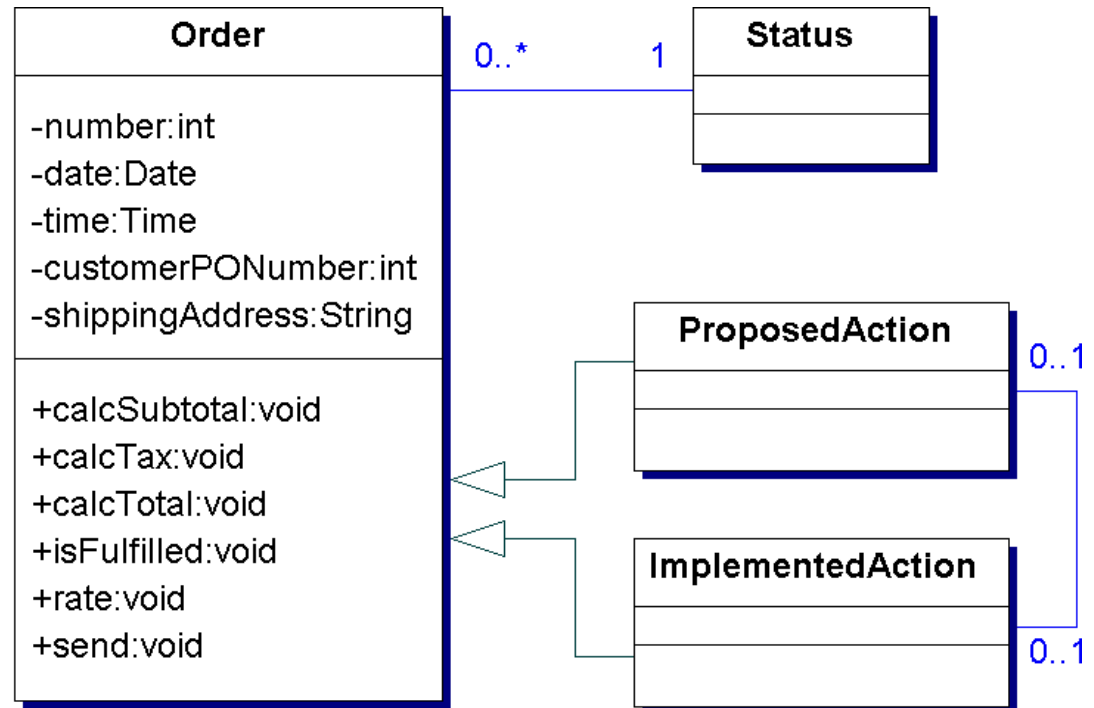
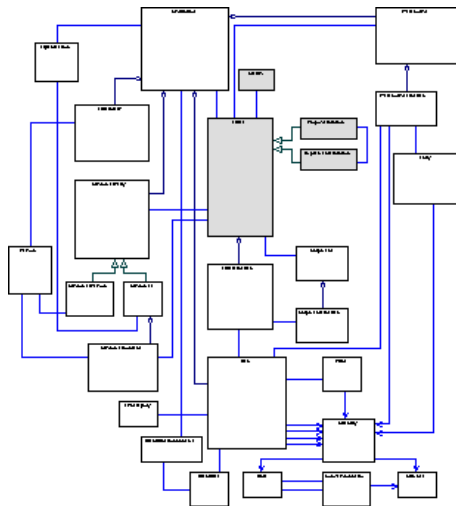
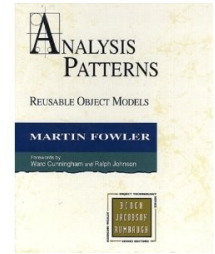

Planning – Completed and Abandoned Actions pattern

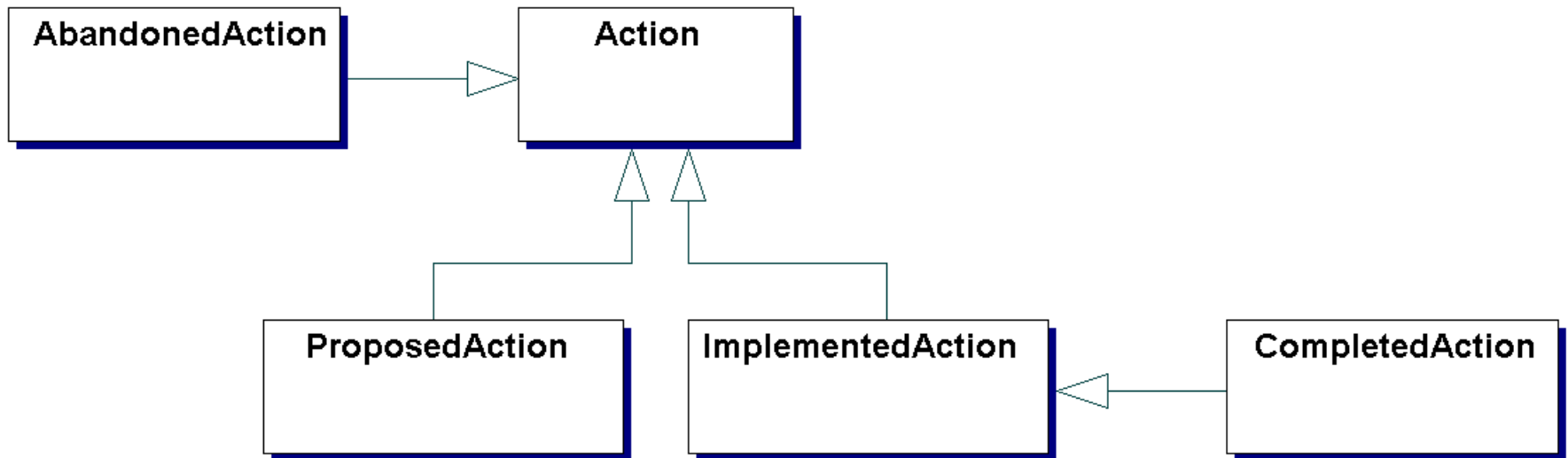
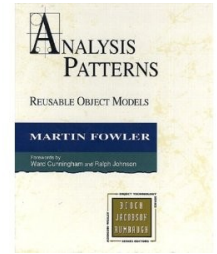

Ollie's Order Center: Completed and Abandoned Actions pattern

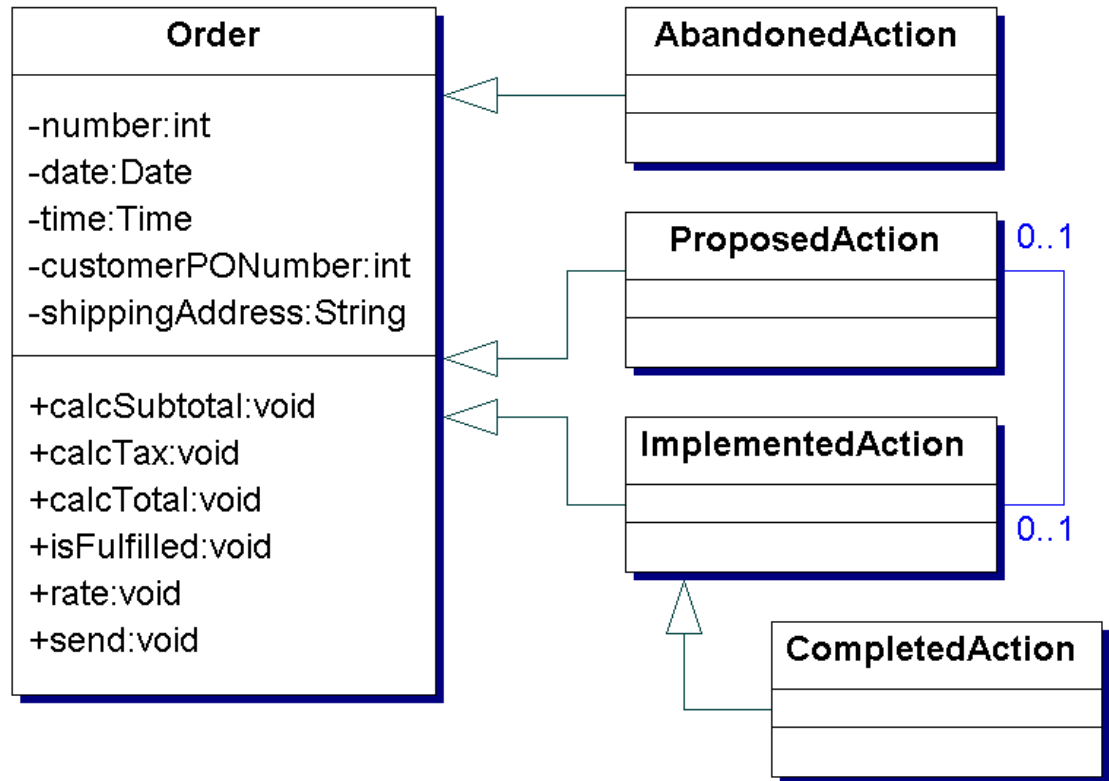
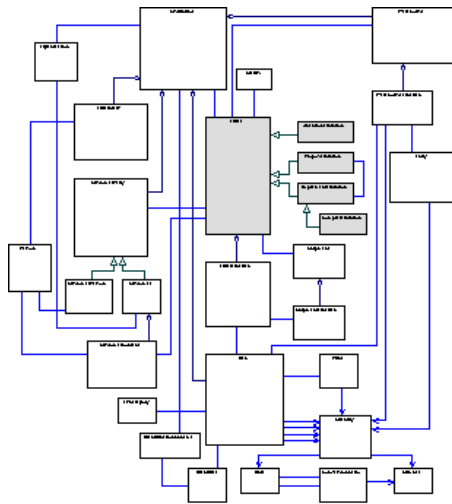
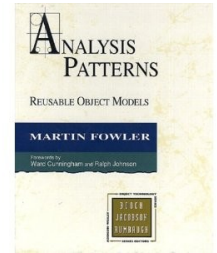

Trading – Contract pattern

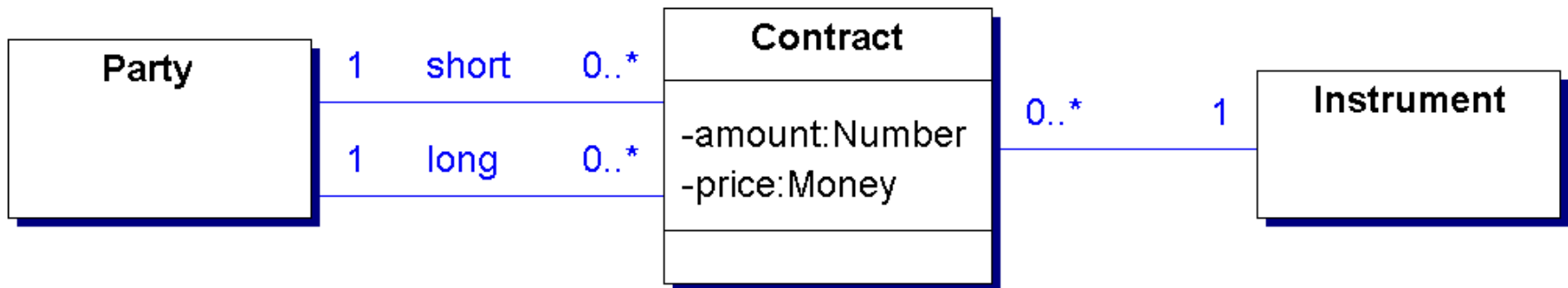
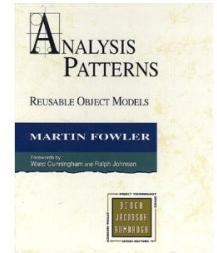

Ollie's Order Center: Contract pattern

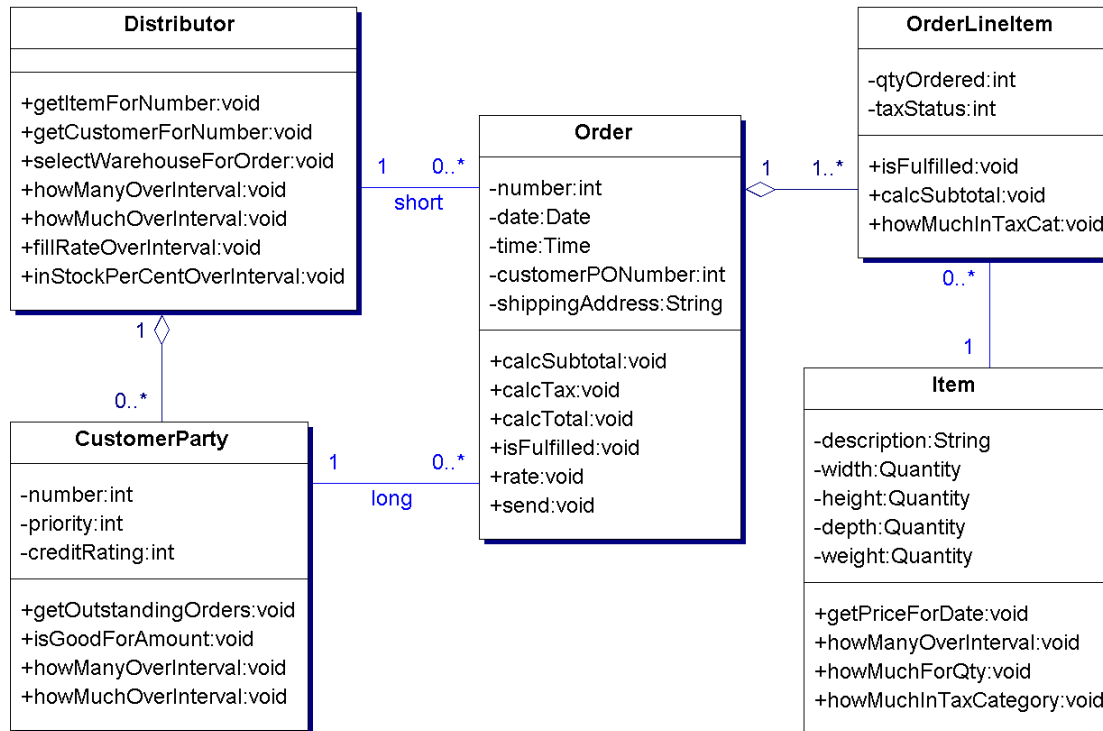
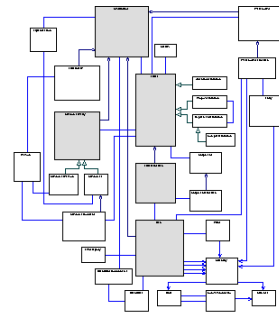
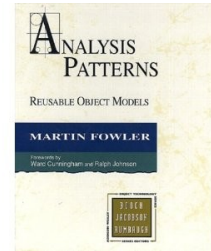

Trading – Portfolio pattern

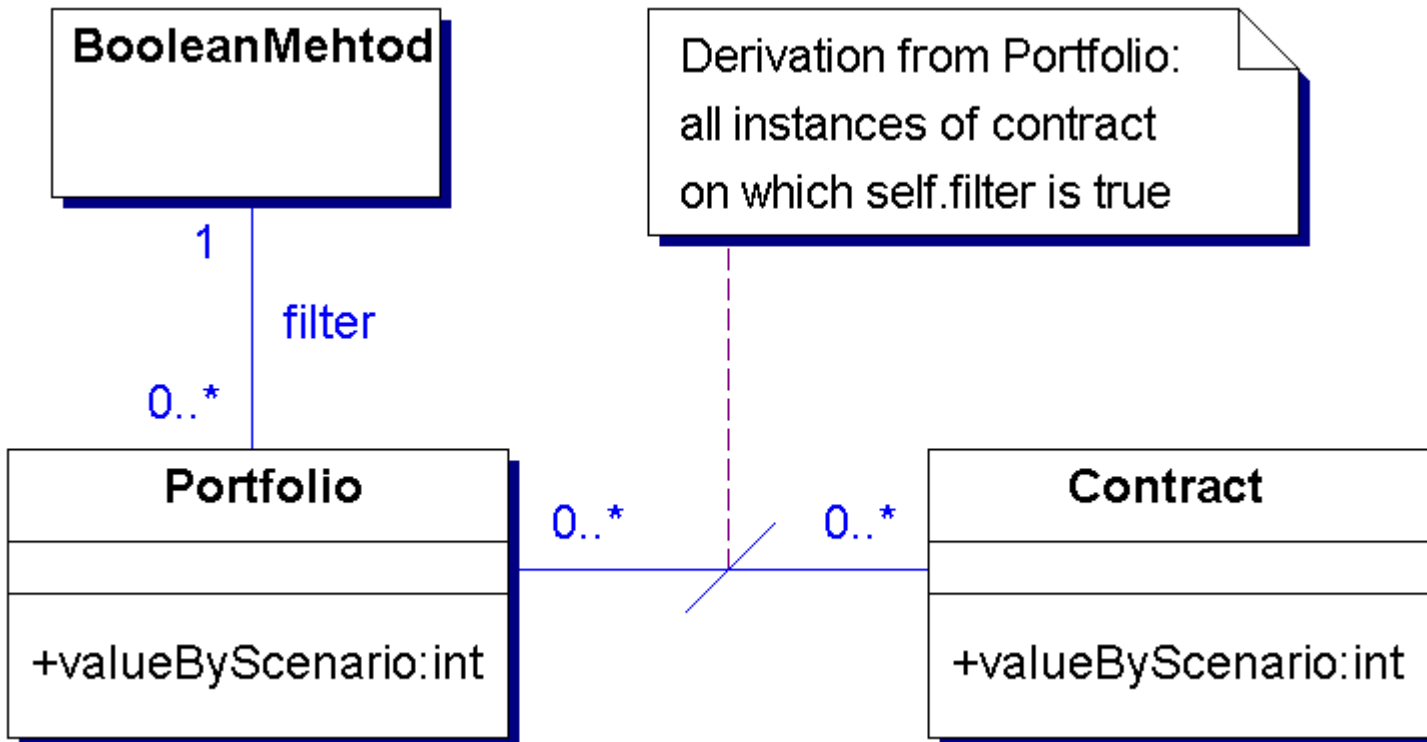
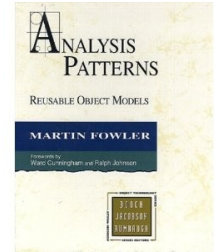

Derivative Contracts – Forward Contracts pattern

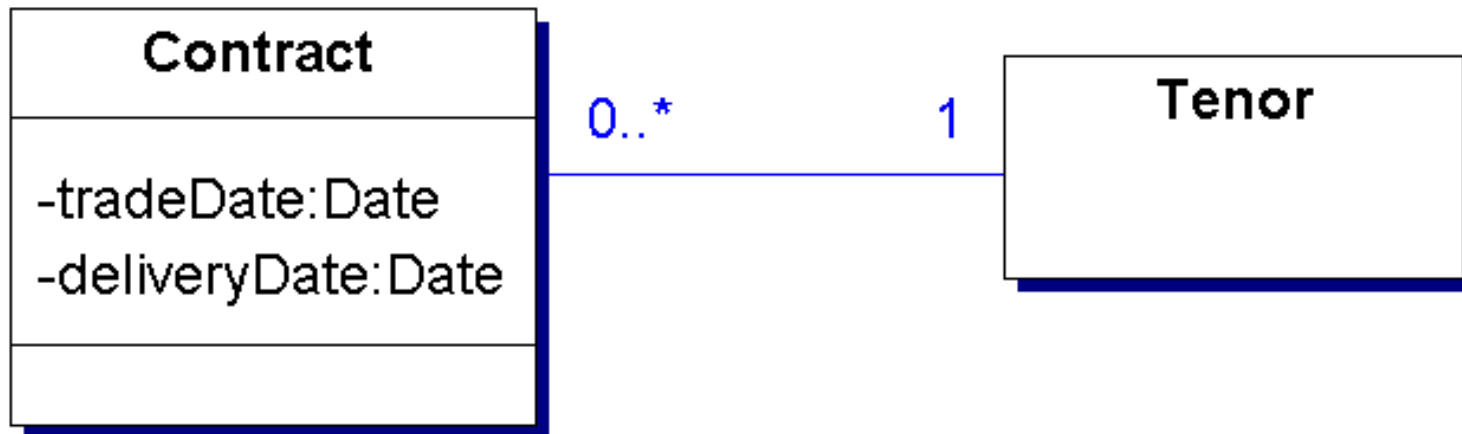
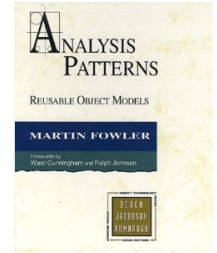

Ollie's Order Center: Forward Contracts pattern

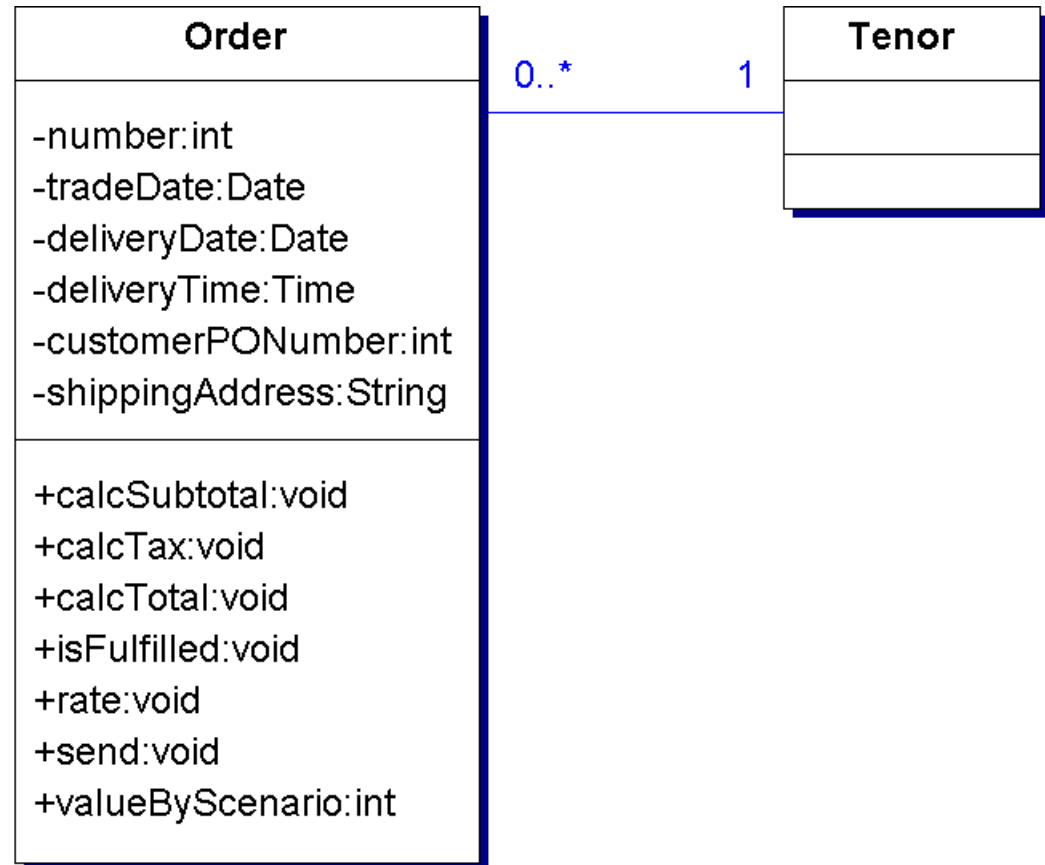
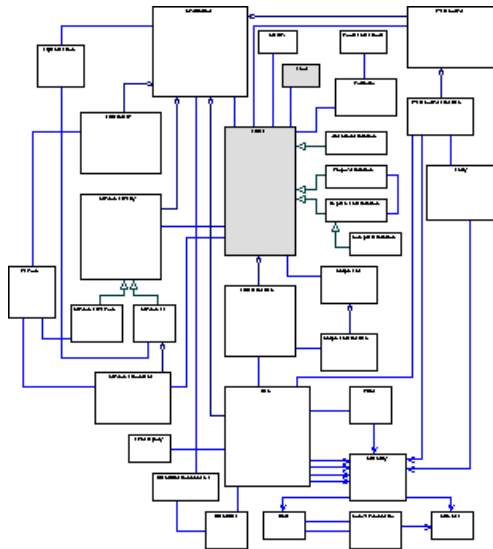
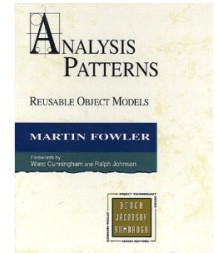

Ollie's Order Center after patterns inclusion

