

PA197 Secure Network Design



Cryptography aspects in Wireless Sensor Networks

Petr Švenda svenda@fi.muni.cz

Faculty of Informatics, Masaryk University

CRCS

Centre for Research on
Cryptography and Security

Lecture overview

- Cryptography and key management in WSNs
 - Approaches and typical issues
- Partial compromise and what can be done
 - Dealing with partially compromised network
- Case study: WSNProtectLayer

Network lifetime

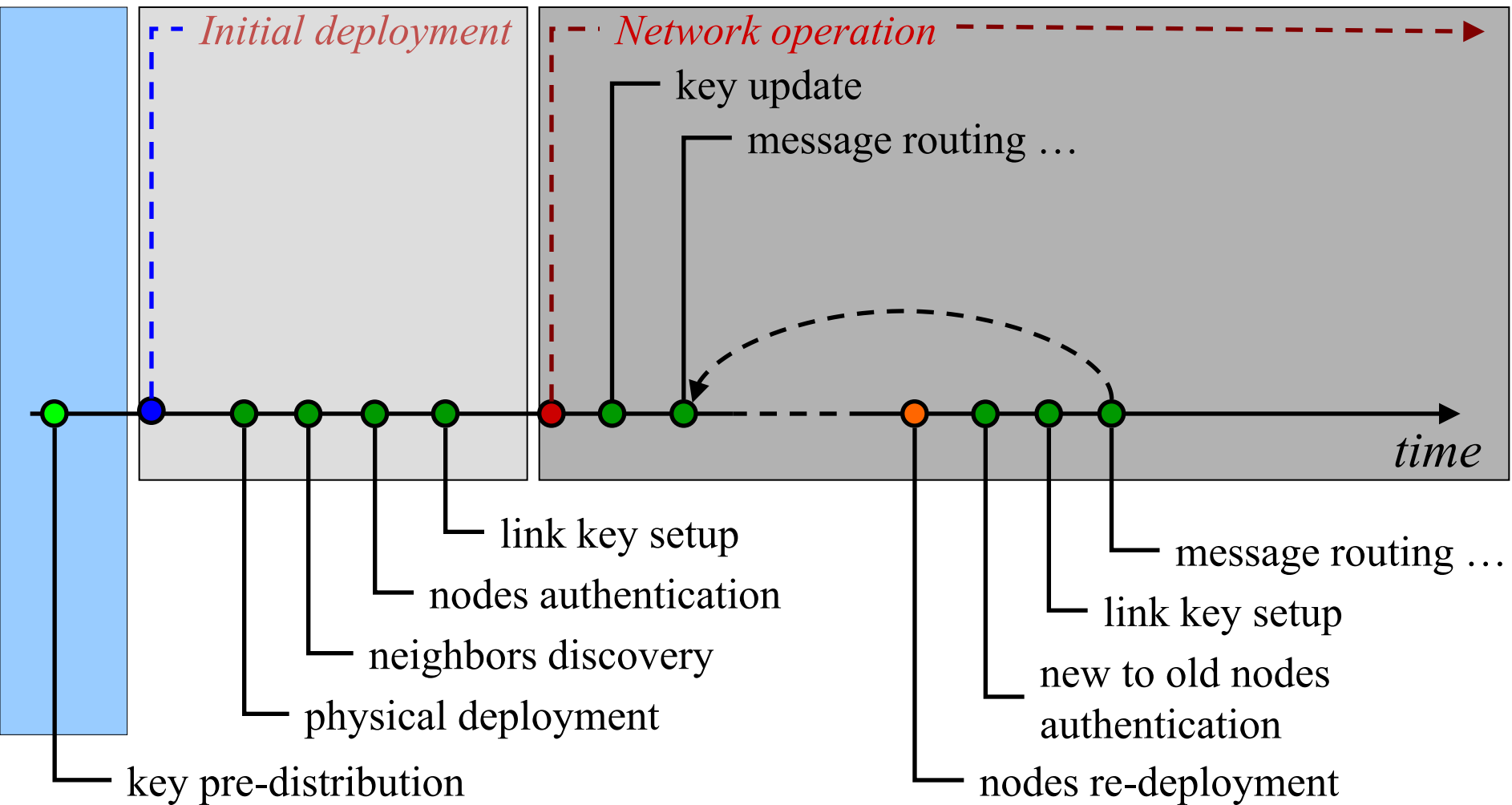

Wireless Sensor Networks – Crypto

CRYPTOGRAPHIC ASPECTS

Do we have need for on-node crypto?

- Data for base-station (end-to-end)
- Data for neighbors (hop-by-hop encryption)
- Nodes authentication
- Authenticated broadcast
- Group/cluster-keys (aggregation)
- Traffic analysis resistance (phantom routing...)
- No-keys, symmetric crypto, asymmetric crypto
- Random number generation (IV, padding, keys...)

Recall: WSN specifics

- Limited computation power and memory
- Limited energy
 - Consumed by communication, computation, storage...
- Limited connectivity
- No direct central synchronization
 - Low-range radio
 - No or loosely synchronized clocks
- Limited or no tamper resistance

Native vs. software-only cryptography

- I. Native support inside radio module
- II. Software execution on main processor
- III. Additional cryptographic co-processor

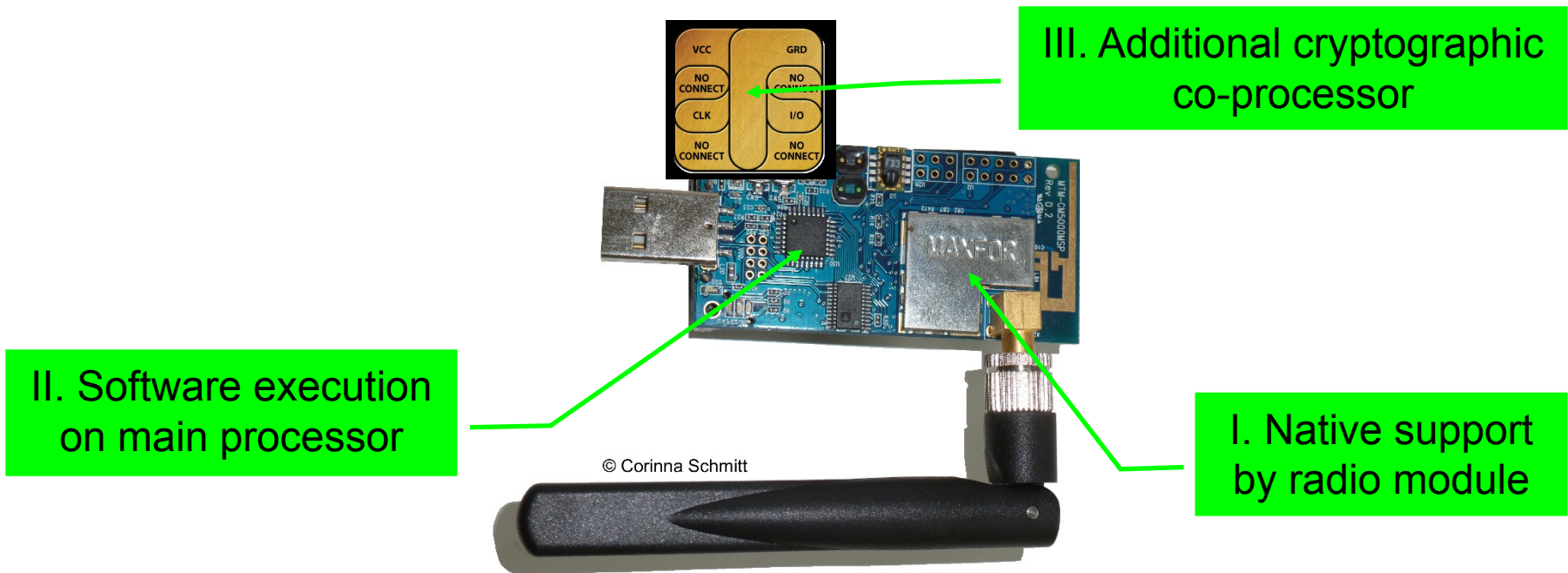

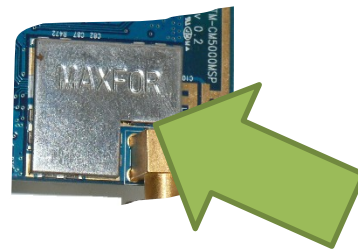

I. CRYPTO IN RADIO MODULE

Native cryptographic support by radio

- Cryptographic functionality provided by radio module
 - Supported algorithms depend on used standard, only very few
 - Usually easy to use and transparent to developer/user
 - Energy efficient (ASIC)
- Usually focus only on link-level security
 - Encryption, integrity (MAC), node authentication, key establishment
- Performance matched to radio's transmission rate
- Allows for better parallelization => lower latency
 - Main processor not occupied with cryptographic operation
- Customized crypto protocols usually not possible

Native cryptographic support - examples

- IEEE 802.15.4 (ZigBee, AES-128b)
 - AES-CBC-MAC-32/64 (no encryption, 4/8B MAC)
 - AES-CTR (CTR mode for encryption, no MAC)
 - AES-CCM-32/64 (encryption + MAC)
- Bluetooth LE/Smart (AES-128b, ECDH P-256)
 - AES-CCM (encryption + MAC)
 - ECDH (key establishment)
- ...

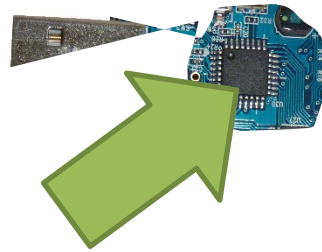

II. CRYPTO ON MAIN PROCESSOR

Crypto on main processor

- Cryptographic functionality executed on main processor
 - Performance highly depends on main processor
 - Usually less energy efficient and possibly slower than other options
- High flexibility: customized algorithms and protocols
 - Anything that can be compiled, fit and executed on MCU
 - Important parameters: code size (EEPROM), state (RAM), speed
- Introduces additional latency
 - Main processor occupied with crypto operation, serialization
- Possibility to update implementation in the field
 - Over-the-air (OTA) updates
- Keys can be extracted after node capture
 - no tamper resistance

Available implementations

1. Standalone algorithms (e.g., AES)
2. General-purpose libraries (mostly C)
3. Platform specific libraries (TinySec...)
4. Kernel modules (part of embedded OS)

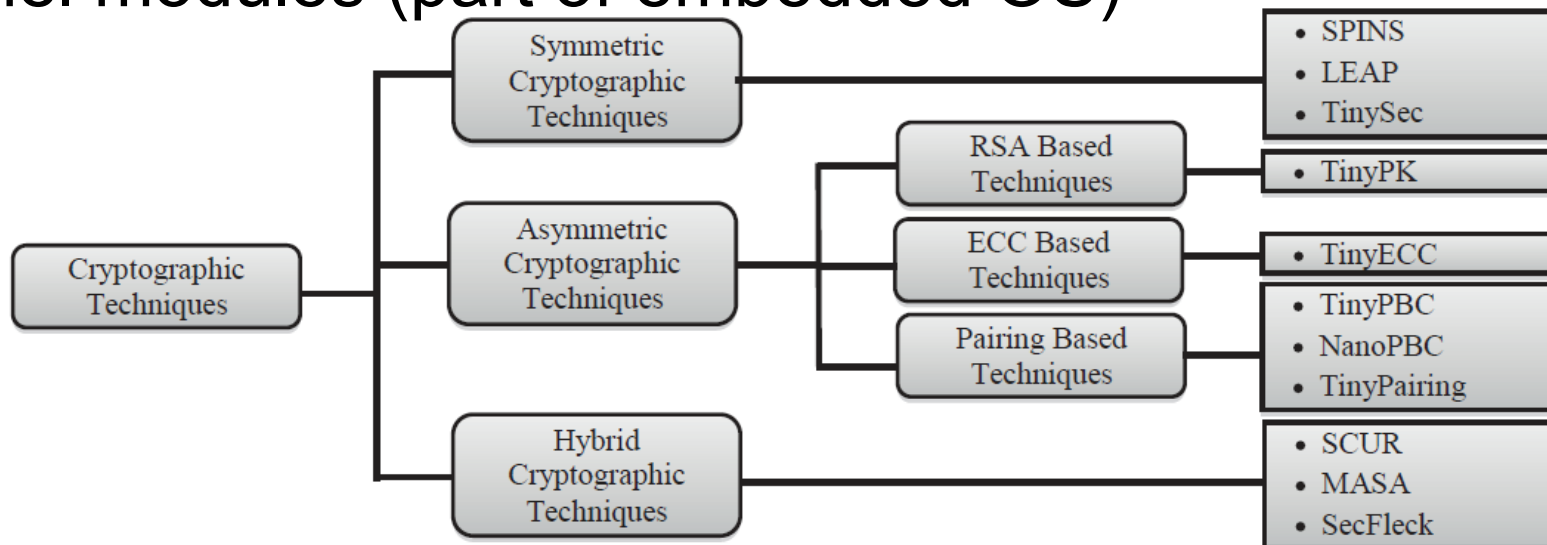

Framework	Encryption	Cipher	Freshness (CTR)	Key Agreement	Code Requirement	Authentication	Cost (time/energy)	Support
SPIN	CTR mode	RC5 (Block)	Yes	Master Key & Delayed Disclosure	2674B	CBC-MAC	7.24 ms	SmartDust
LEAP	RC5	RC5 (Block)	No	Pre-deployed (Master Variable)	ROM: 17.9KB RAM: no. of neighbours	CBC-MAC	Variable (No. of neighbours)	Mica2
TinySec	CBC mode (Optional)	Cipher independent	No	Any	RAM: 728B program space: 7146B	CBC-MAC	RC5(C): 0.90ms Skipjack(C): 0.38ms RC5(C, assembly): 0.26ms	Mica, Mica2, & Mica2Dot
TinyPK	RSA	-	No	PK-RSA	13387B (512 bit key)	CA-signed Diffie-Hellman public value	3.8 s	Mica1, Mica2
TinyECC	ECIES	-	No	ECDH	20818B (micaz)	ECDSA	20266.47ms / 486.4 mJ (micaz)	Mica2/MicaZ, TelosB/Tmote Sky, BSNV3, & Imote2
TinyPBC	PBC	-	No	ID-NIKDS	Stack: 2,867B RAM: 368B ROM: 47,948B	ID-NIKDS	5.45s (pairing computation)	Mica2 & MicaZ
NanoPBC	-	-	-	-	-	-	-	MicaZ
TinyPairing	PBC	-	No	-	RAM: 392B ROM: 21,742B	-	21.95 s	MICA family, Telos, eyesIFX, Intel's Imote,
SCUR	Rabbit	Rabbit (Stream) (128bit)	Yes	Pre-Deployed key	-	-	-	-
MASA	-	-	No	-	-	-	-	-
SecFleck	RSA	RSA (Block) (2048 bit) & XTEA	No	-	RAM: 52B Program space: 1.082B	RSA	RSA (s/w): 219,730 μ s / 7,030.0 μ J RSA (h/w): 27 μ s / 5.4 μ J XTEA (s/w): 18 μ s / 0.6 μ J	Fleck sensor node

Modes for encryption / integrity

- CBC used often in software libraries (simple)
 - Need for initialization vector update and synchronization
- CTR mode
 - possibility for precomputation => lower latency when packet arrives
 - No message length extension
 - (used also in Bluetooth LE / IEEE 802.15.4 ZigBee)
- CBC-MAC - same underlying code reused

Initialization vector management

1. IV is send with every packet
 - Shorter than normally (e.g., 2 bytes only), ~10% overhead
 - Relatively low number of messages (65k) before key update
 - Advantage in high packet loss environments
 - Example: TinySec, ZigBee
2. IV is kept synchronized (counter), no IV send
 - Resynchronization on packet loss required
 - Example: SPINS
3. Only part of IV send (last few bits)
 - Balance between overhead and expected number of lost packets
 - Example: MiniSec-U

SPINS/SNEP (Perrig et al., 2002)

- Suite of lightweight protocols
 - Based on symmetric cryptography only, RC5 (stream c.)
- SNEP: Sensor Network Encryption Protocol
 - Semantic security, Data authentication
 - Replay protection – synchronized counters
 - Freshness – weak (counter), strong (challenge)
 - Low communication overhead
- De-facto benchmark for protocols proposed later

SPINS – energy consumption

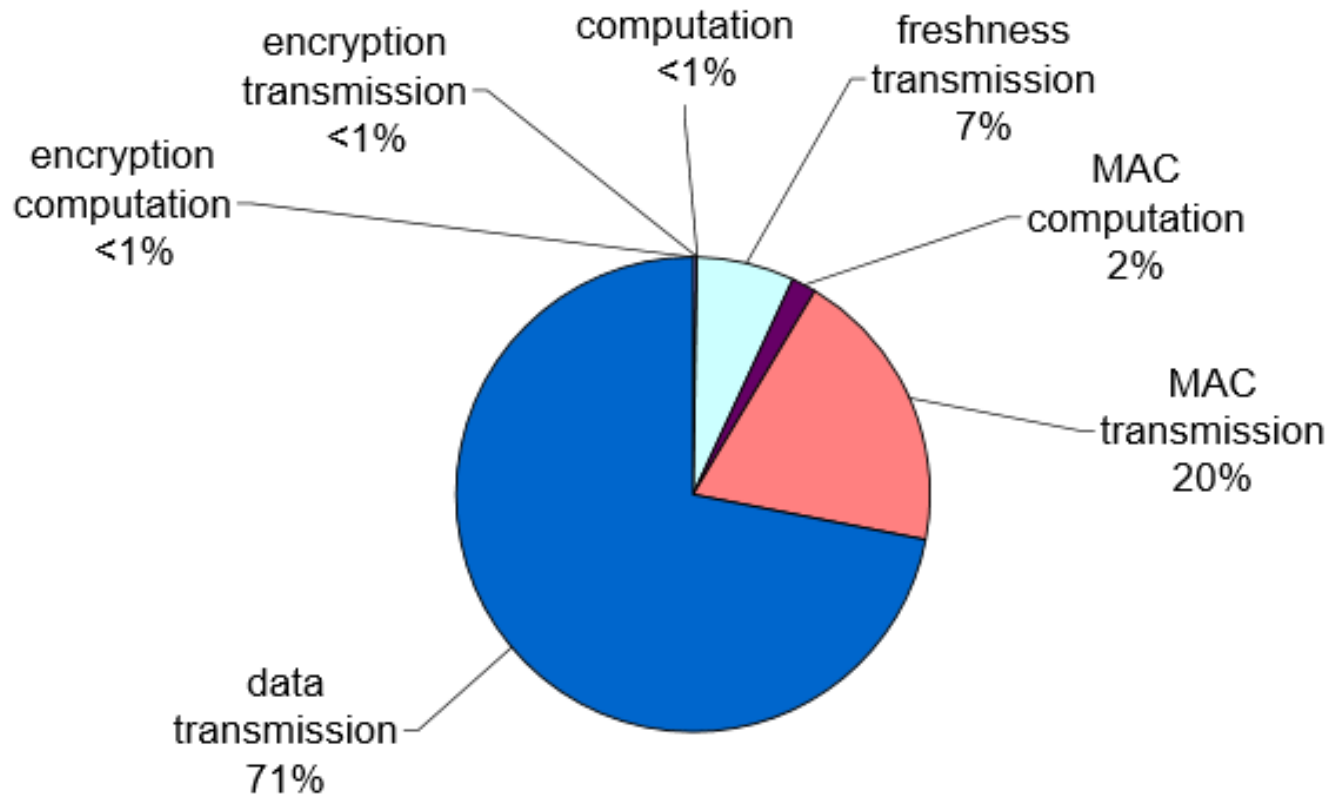

<http://users.ece.cmu.edu/~adrian/projects/mc2001/mc2001.pdf>

Asymmetric crypto – energy consumption

- Significantly different ratio w.r.t. symmetric crypto
 - Most energy consumed by computation of operation (MCU)
 - Transmission accounts only to about 1% of energy use
 - Even when significantly longer signature is transmitted
 - 128B RSA signature vs. 4-8B MAC
- Overall impact on network lifetime is still very small
 - Relevant only to networks with high number of signed messages
- More important factors are code size, state and increased probability of collision during transmission
- https://www.ics.uci.edu/~steffenp/files/SASN_piotrowski.pdf

Authenticated Broadcast

- Authenticated message to be delivered to “all” nodes
- Solution1: Asymmetric crypto
 - Potentially high computation and transmission overhead
- Solution2: Single network-wide key for MAC verification
 - Single compromised node => attacker can forge BS’s messages
- Solution3: Unique key between every node and BS
 - Compromised node => only messages to this node can be forged
 - But separate message (or at least MAC) for every node needs to be computed and delivered (overhead)
- Can we use symmetric crypto and have only single key?

μTesla: Authenticated Broadcast

1. Message broadcasted from base station with MAC
 - Node stores received message, but cannot verify yet
2. Base station later broadcasts key used for MAC (“epoch”)
 - Once broadcasted, nodes can verify messages from given epoch
 - New messages from previous epoch are not accepted any more
 - As MAC key for that epoch is now public
3. Message authentication keys form hash key chain
 - No need to store keys for older epochs
 - Validity of MAC keys can be verified against pre-distributed root

Hash chains (as used in μ Tesla)

- $\text{root} = H^1(H^2(\dots H^X(\text{seed})\dots))$
- Knowledge of root will not allow to compute any H^i
 - Inversion of hash function H is hard
- H^i can be quickly verified against H^{i-1}
 - Unlimited length of chain (if root is not required)
 - Length X chosen in advance (if root is pre-distributed)
- Knowledge of *seed* allows to compute any chain value
 - Used by base station for MAC key computation
- *root* used for verification of μ Tesla MAC keys

μ Tesla properties

- Very low overhead (MAC/message + key/epoch)
- Requires loosely synchronized clock ("epochs")
- Robust against packet loss
- Overhead independent from number of nodes

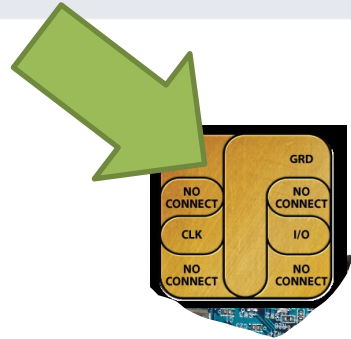

Tamper Resistant Hardware and Asymmetric crypto on WSN node

III. CRYPTO CO-PROCESSOR

Cryptographic co-processor

- Additional dedicated co-processor for crypto ops
 1. Only cryptographic speedup (no tamper protection)
 2. Also tamper protection of cryptographic secrets
- Possibility to parallelize (MCU/Crypto/Radio)
- Small to medium flexibility (fixed set of algorithms)
- Energy efficient
- E.g., cryptographic smart card provides:
 - Strong tamper resistance, RSA-1024/2048, ECC...
 - Strong protection also for keys for symmetric crypto
 - Relatively cheap (\$2, Feitian A40 Infineon SLE78)

Smart card to sensor node connection

- Direct connection via serial interface (UART)
 - Communication speed 9600 baud, APDU commands
- Keys and crypto operation executed only on-card

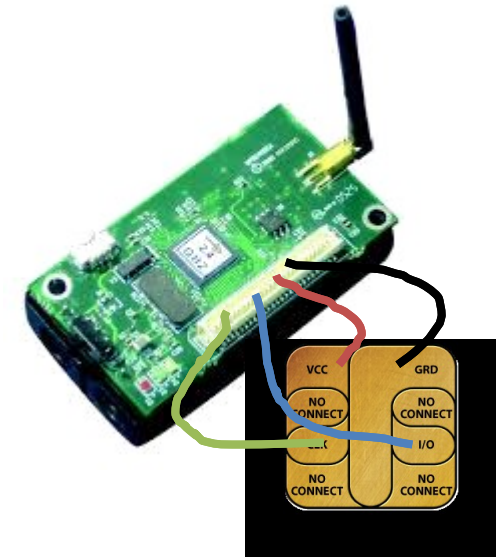
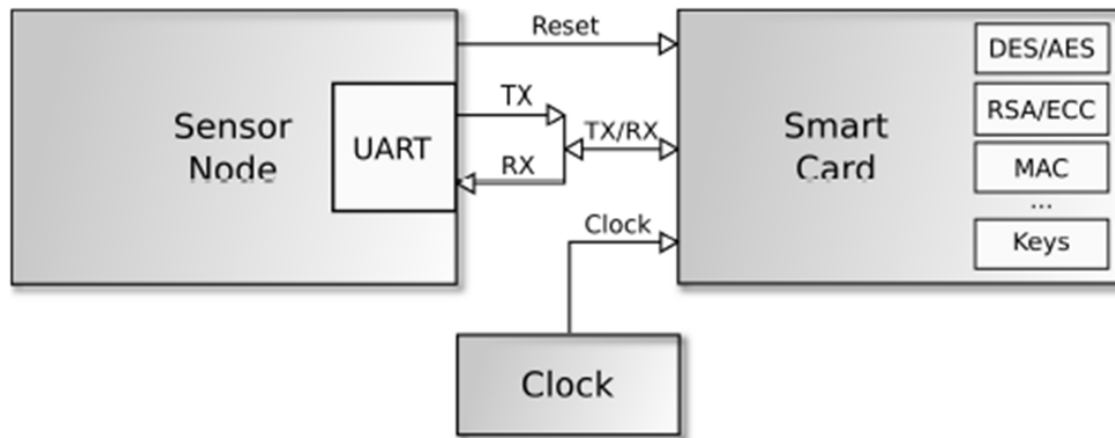

Hanáček, Nagy, Pecho: *Power Consumption of Hardware Cryptography Platform for Wireless Sensor*, IEEE CS, 2009, s. 6, ISBN 978-0-7695-3914-0

Performance with cryptographic smartcard

- Total time = $T(\text{dataIn}) + T(\text{operation}) + T(\text{dataOut})$
- Experiment: MICAz (ATmega128L), GemXpress
- Performance for RSA-1024b
 - 30x faster (750ms), 27x more energy efficient (27mW)
- Performance for RSA-2048b
 - 88x faster (1900ms), 70x more energy efficient (79mW)

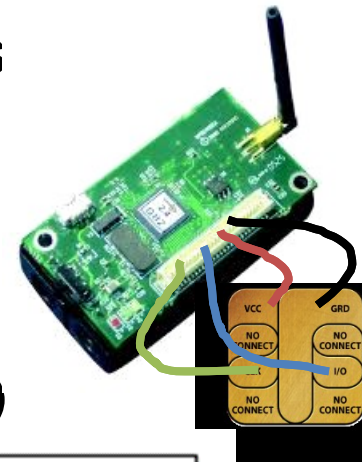

Algorithm and realization			Key length (bit)	T (s)	W (mWs)
Software solution ²	Signature	RSA	1024	22.03	726.99
Software solution	Signature	RSA	2048	166.85	5506.05
Hardware solution	Signature	RSA	1024	0.75	27.15
Hardware solution	Signature	RSA	2048	1.89	79.09

Performance with newer cards

- Even faster with current cards and faster UART
 - 9600 baud → 128000 baud => 12x faster data I/O
- \$2 Feitian A40 smart card (Infineon SLE78)
 - 25ms per single RSA-1024b operation
 - 150ms per single RSA-2048b operation
- Expected performance
 - below 50ms (440x faster) for RSA-1024
 - below 200ms (900x faster) for RSA-2048
- Even cheaper and efficient ASICs available...

Multiple keys / engines can be stored

- <https://www.fi.muni.cz/~xsvenda/jcalgtest>

Type of object	NXP CJ2A081	NXP CJ2D081 80K	NXP JCOP21 v2.4.2R3 145KB
AESKey 128	877	729	678
AESKey 256	658	607	565
DESKey 196	748	607	565
Cipher AES	79	74	74
Cipher DES	147	136	136
RSA CRT PRIVATE 1024	72	93	86
RSA PRIVATE 1024	203	152	141
RSA CRT PRIVATE 2048	61	51	47
RSA PRIVATE 2048	108	82	77

Wireless Sensor Networks – Key Distribution

KEY DISTRIBUTION

Problem: wide range of assumptions

- Different works assume different types of WSNs
 - network architecture and topology
 - network nodes hardware and required lifetime
 - degree of (de)centralism, level of nodes mobility
 - communication medium used, quality of links
 - computational power, memory limitations, energy source
 - routing and data collection algorithms
 - assumptions about attacker capabilities
 - ...
- One security approach doesn't fit all scenarios

Level of keys pre-distribution (I.)

1. No pre-distribution

- all keys established after nodes are deployed
- e.g., Key Infection (exchange keys in plaintext)
- problem: usually assumes period of limited attacker

2. Fixed network wide “master” key(s)

- pre-distributed keys allowing key establishment with all others
- problem: very low node capture resilience

2. Fixed network wide “master” key(s)

- Single master key shared by whole network
- All transmission encrypted/MAC by master key
 - What are possible attacks?
 - Reuse of key for long time, no origin authentication...
 - Compromise of master key (node capture)
- Link keys derived from master key
 - $\text{linkKey} = \text{KDF}(\text{nodeID1} \mid \text{nodeID2} \mid \text{random})$
- What attacks are possible?

Why “Master key” pre-distribution fails

- Perfect in terms of memory storage
- Completely fails with single node

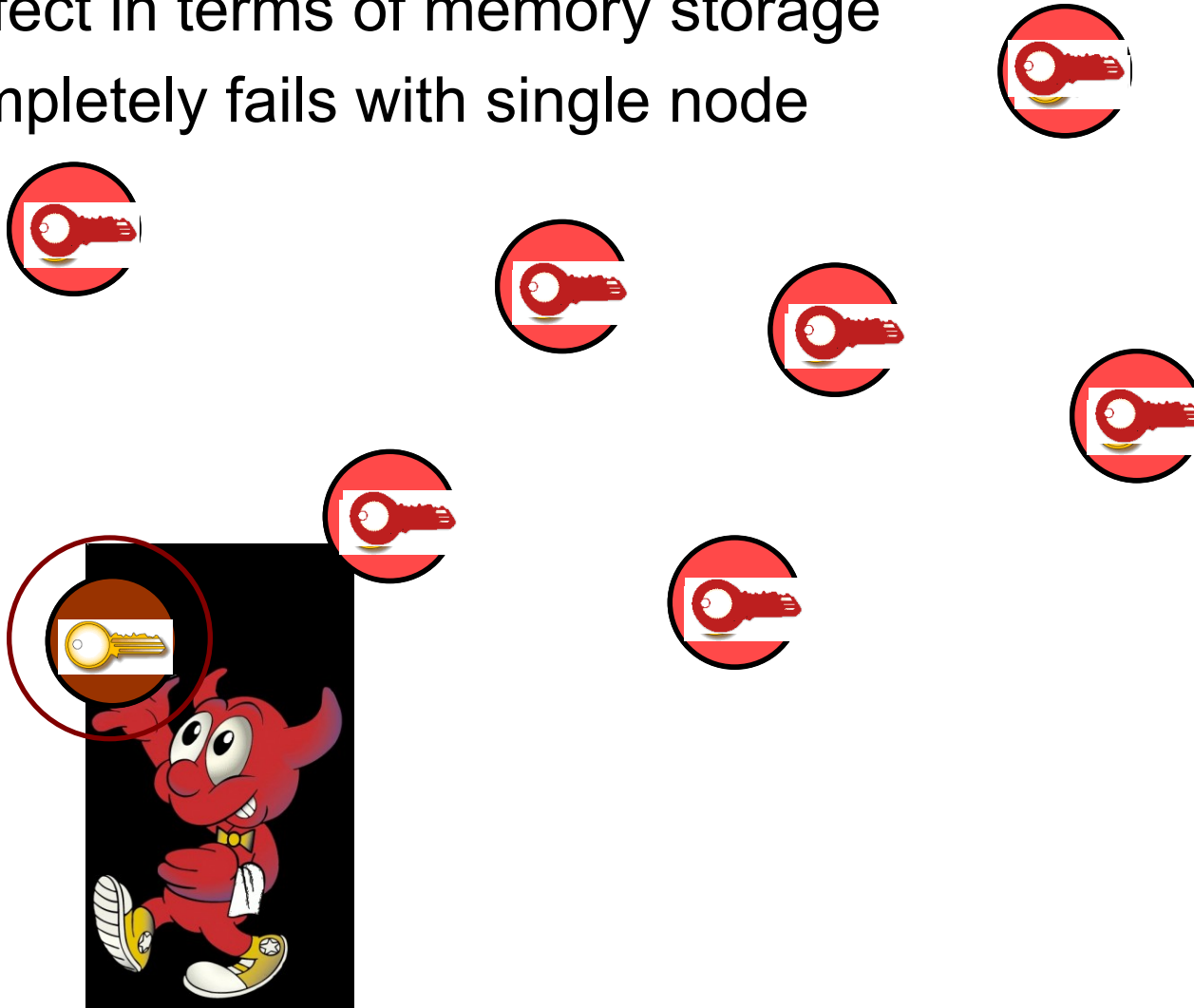

Level of keys pre-distribution (II.)

1. No pre-distribution

- all keys established after nodes are deployed
- e.g., Key Infection (exchange keys in plaintext)
- problem: usually assumes period of limited attacker

2. Fixed network wide “master” key(s)

- pre-distributed keys allowing key establishment with all others
- problem: very low node capture resilience

3. Partial pre-distribution

- not all nodes can establish key directly
- e.g., probabilistic pre-distribution [EG02]
- problem: node capture resiliency

Probabilistic key pre-distribution

- *Eschenauer & Gligor 2002*
- Elegant idea with low memory requirements
 - based on birthday paradox
 - large pool of cryptographic keys with unique IDs used
- For every node prior deployment:
 1. randomly select keys from large key pool
 2. return selected keys back to pool
 3. proceed with next node

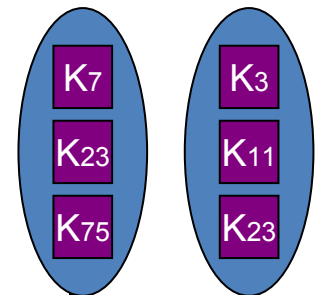
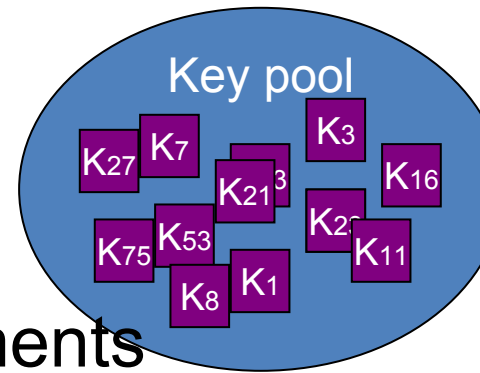

Probabilistic key pre-distribution (2)

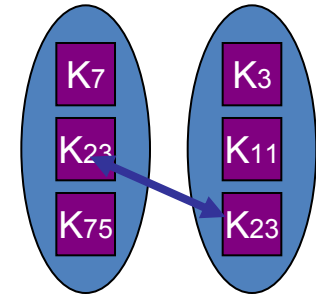

- During neighbour discovery:
 1. neighbours establish radio communication
 2. nodes iterate over their keyrings for shared key(s)
 3. if shared (by chance) key(s) are found, secure link is established
 - e.g., 100 keys from 10000 \Rightarrow 60% probability at least one key shared
- Not all nodes can establish secure link
 - but sufficient connectivity probability can be set
- Node capture resilience (NCR) is a problem

How probabilistic pre-distribution fails

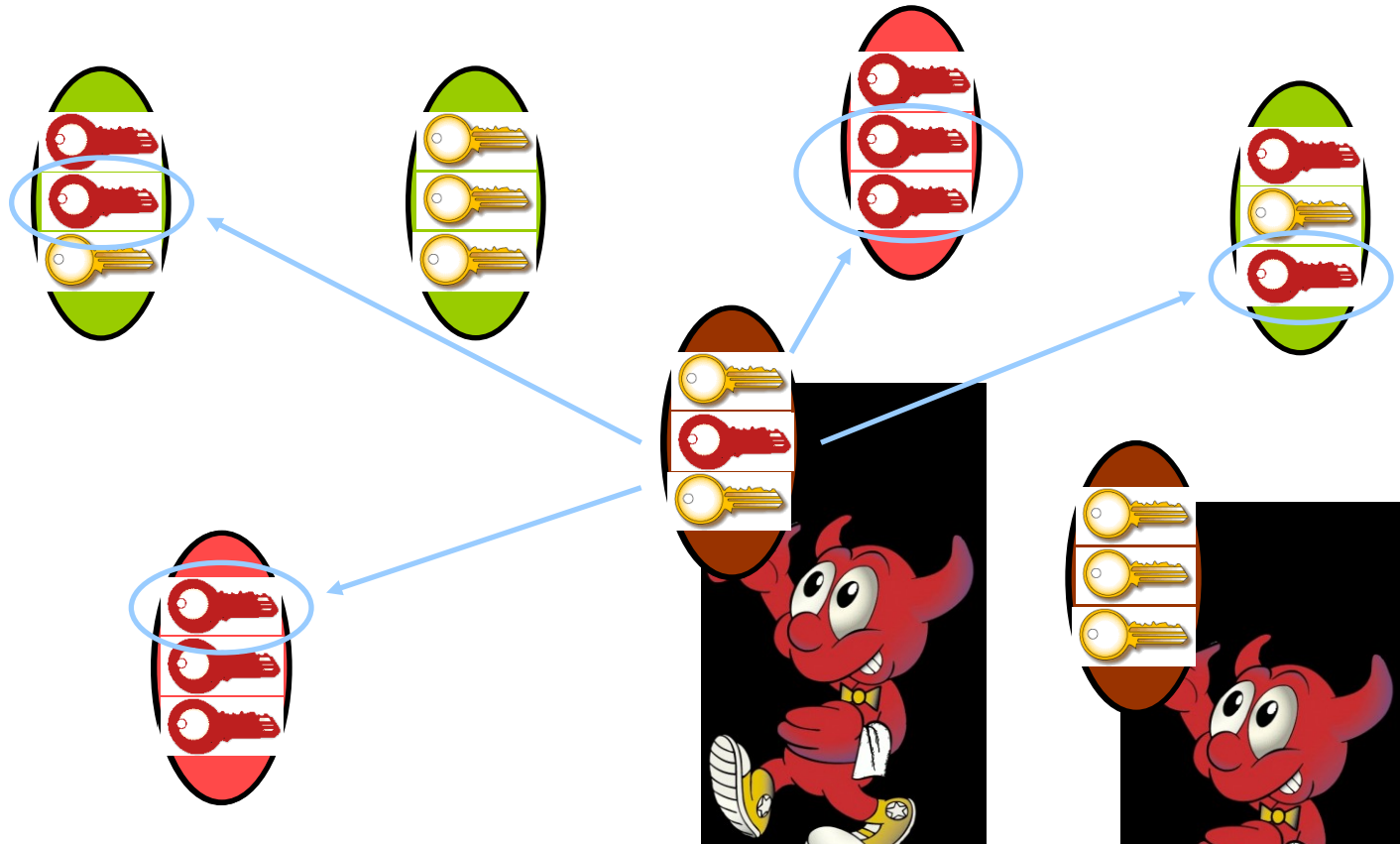

- Keys from uncaptured nodes compromised as well

Level of keys pre-distribution (III.)

4. Pairwise keys (node2BS, node2node)
 - all nodes can establish keys if necessary
 - Every node to BS, every node to every node

Pairwise keys – every node to BS

- Predistributed unique key(s) between BS and every node
 - BS holds database of all keys, node holds just single key to BS
- End-to-end encryption/MAC
 - Intermediate nodes just forward towards BS
 - Low latency, memory and computation overhead (no processing on intermediate nodes)
- Possibility for periodic key update
 - $\text{newKey} = \text{KDF}(\text{oldKey}, \text{"Period}_i\text{"})$, erase previous *oldKey*
 - Better than $\text{newKey} = \text{KDF}(\text{masterKey}, \text{"Period}_i\text{"})$ – why?
- Disadvantages of scheme?
 - No data aggregation, insertion of corrupted packets...

Pairwise keys – every node to every node

- Predistributed unique key(s) between every two nodes
 - Every node holds keys to all other potential neighbours
 - (1MB flash storage => 65k of 16B keys)
 - Proper key is found and used when needed
- Unused keys may be erased after neighbour discovery
 - When unused keys will not be necessary
 - No need for a priori knowledge of network layout
- Keys to not yet deployed nodes can be also included
 - Later redeployment of fresh nodes
 - Authentication between old and new nodes possible
- Node capture resiliency
 - no keys except for compromised node are revealed

How “Pairwise keys” pre-distribution fails?

- Only links to captured node are compromised
- Key from captured node can be used everywhere

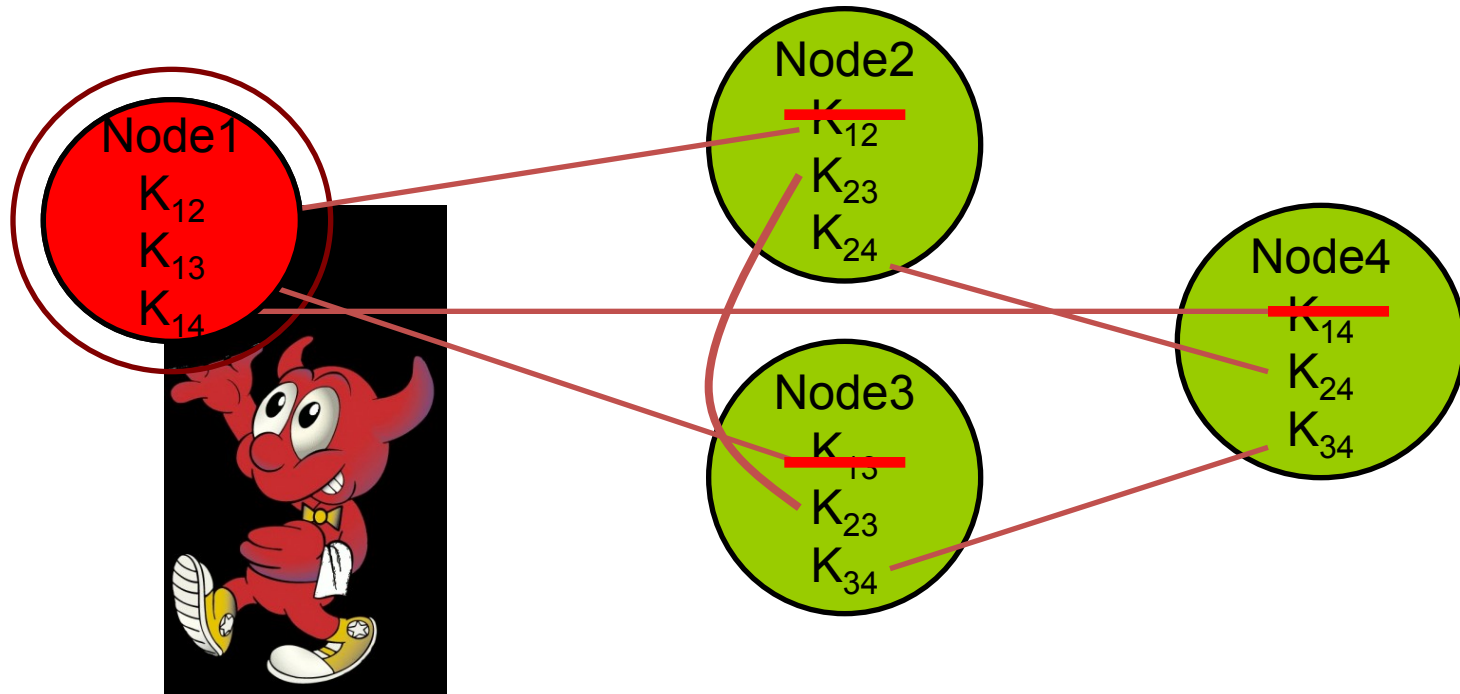

Level of keys pre-distribution (2)

4. Pairwise keys (node2BS, node2node)

- all nodes can establish keys if necessary

5. Asymmetric cryptography

- all nodes can establish keys if necessary
- e.g., ECC, pairing-based crypto
- shown to be feasible (2.5 sec verification, 20KB ROM)
- problem: revocation of compromised keys/nodes

Why asymmetric cryptography may fail?

- Only links to captured node are compromised
- High computational/transmission overhead ($> 128B$)
- Private key from captured node can be used everywhere
- Revocation is hard

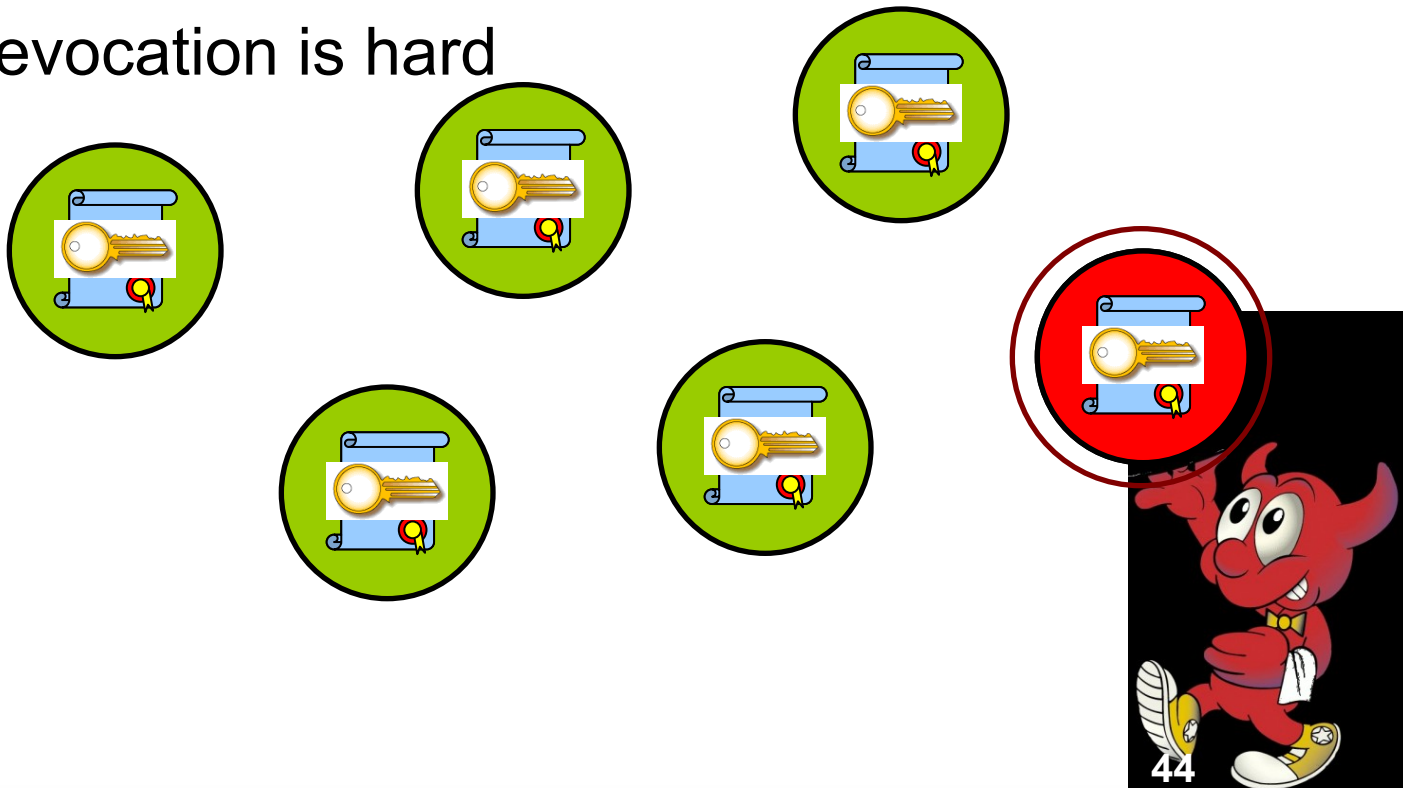

Level of keys pre-distribution (2)

4. Pairwise keys

- all nodes can establish keys if necessary

5. Asymmetric cryptography

- all nodes can establish keys if necessary
- e.g., ECC, pairing-based crypto
- shown to be feasible (2.5 sec verification, 20KB ROM)
- problem: revocation of compromised keys/nodes

6. Central key distribution (via Base Station)

- BS acts as trusted third party, centralized solution (SPINS)
- problem: multi-hop communication to BS

How TTP distribution fails?

- Every key is established via base station (good control)
- Communication is multi-hop and energy expensive
- Network may be temporarily disconnected

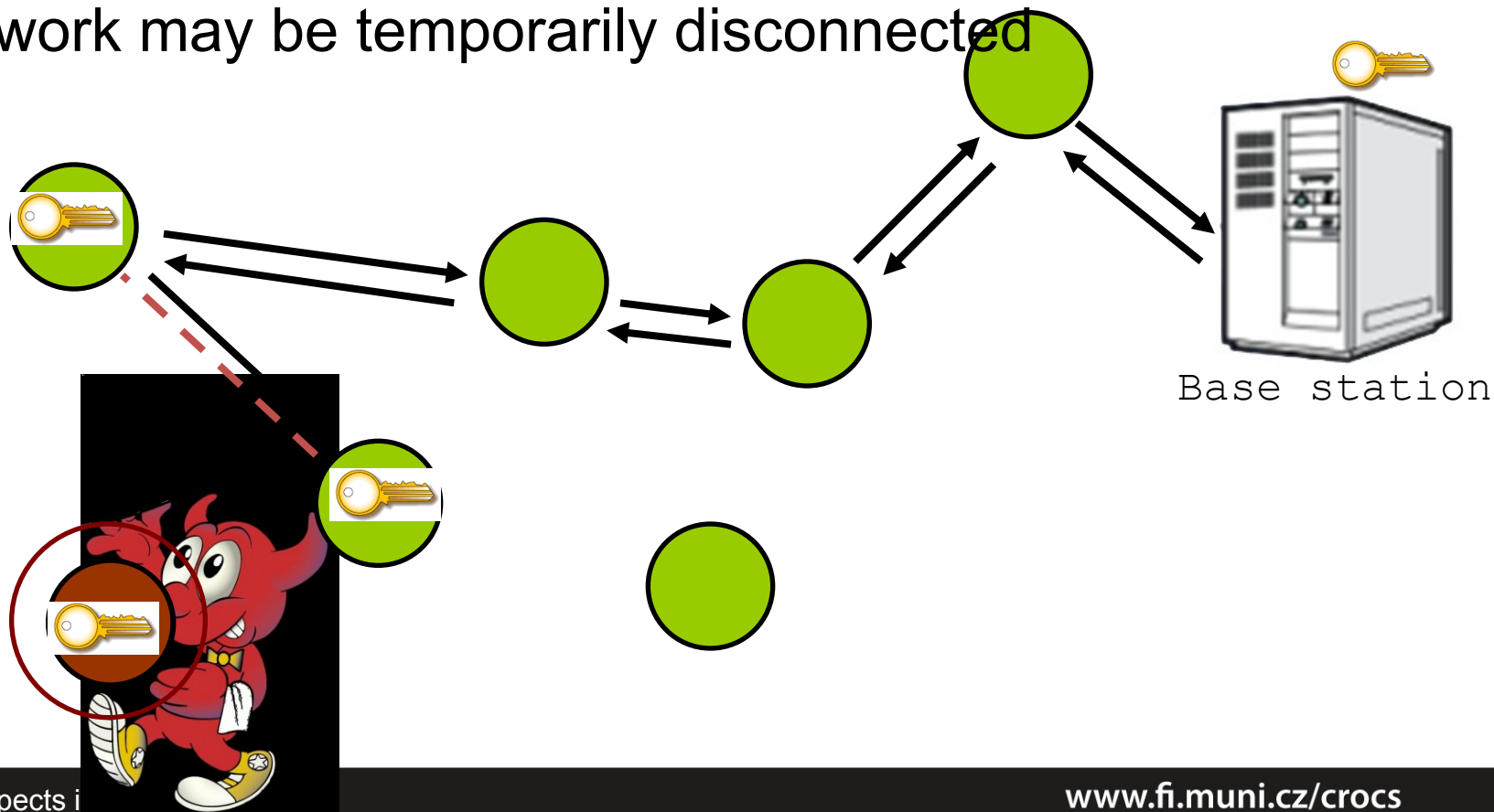

All approaches vulnerable to some extent.
What should we do with partial compromise?

PARTIAL COMPROMISE

Secrecy amplification protocols

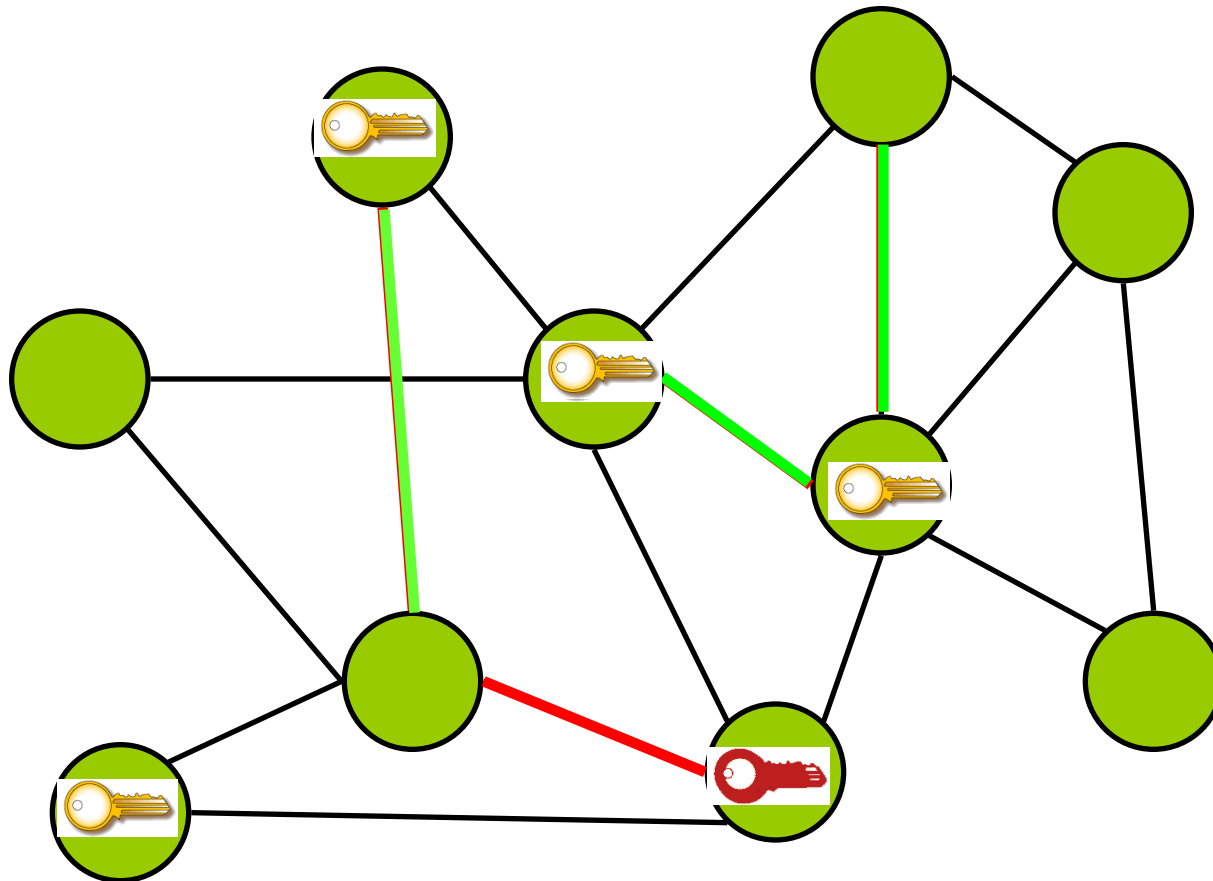
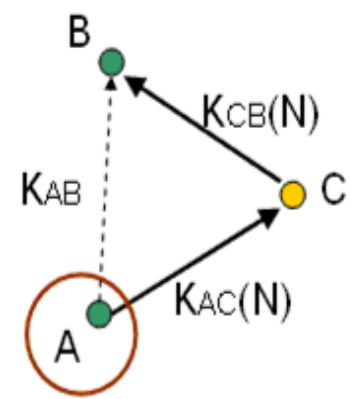

Secrecy amplification protocols

- Additional protocol executed atop of distributed keys
 - network partially compromised after some attack
 - some link keys known to attacker (eavesdropped, captured)
- Secrecy amplification is able to secure previously compromised link(s)
 - transport of fresh link key over secure path
 - success depends on compromise pattern
- Protocol can be executed even when information about compromise is not available
 - old and new key is combined

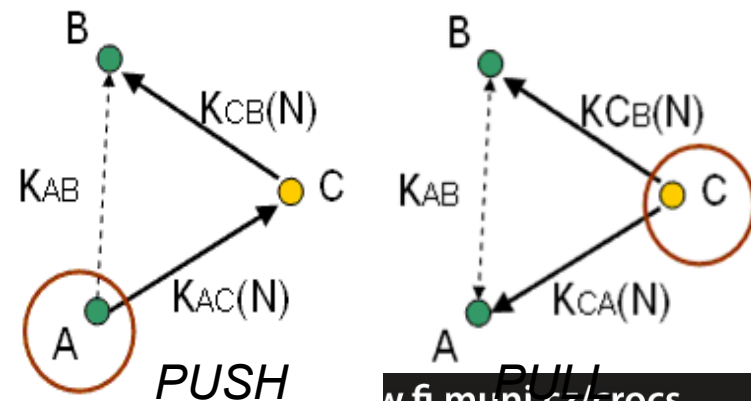

- NO_3PUSH04 [1] / NO_3PULL05 [4]
- NO_4PUSH04 [1] / NO_4PULL05 [4]
- NO_EA09 [15]
- GO_EA09 [15]
- GO_EA12_RP [14]
- GO_EA12_KI [14]
- HD_PULLPUSH14_RP [12]
- HD_PULLPUSH14_KI [12]
- HD_PULLPUSHOPT14_RP [12] / HD_PULLPUSHOPT14_KI [12]

Comparison: total success rate

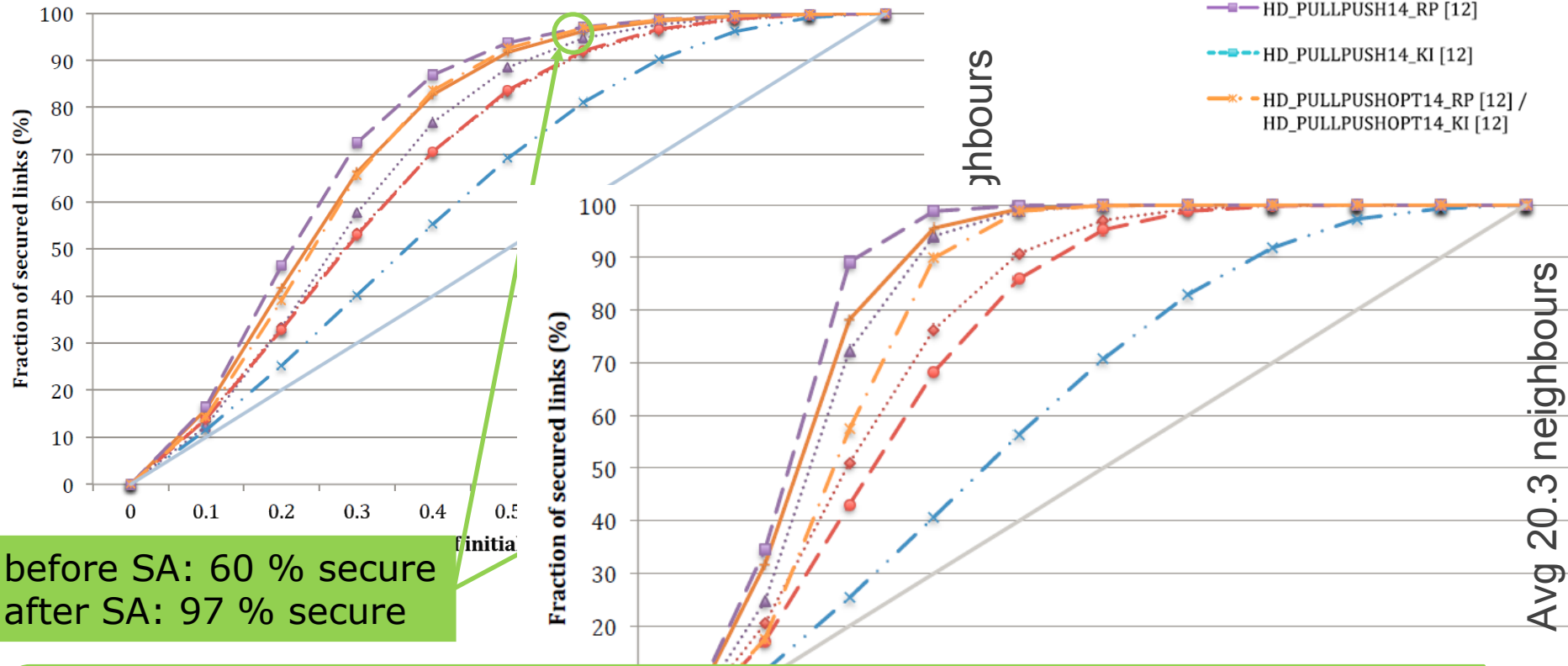

before SA: 60 % secure
after SA: 97 % secure

Depending on network density, up to 30 % → 95 %

Main advantages of secrecy amplification

1. Is preventive measure (no detection/reaction)
 2. Can work in (partially) compromised environment
 3. Work with different underlying (pre)distributions
 4. Are introducing secrets (keys) usable only locally
 5. Can be (automatically) parameterized/optimized
 6. Can run continuously – attacker must maintain its presence
- Survey: <http://www.crcs.cz/papers/wistp2015>

Practical implementation – results

- Scenario: 10 neighbours on average
- Hybrid secrecy amplification protocol
- TinyOS 2.1.2 implementation
 - < 500B RAM (peak usage, reusable later), ~3KB code
 - Seconds to minutes to reliably map radio propagation
 - highly depends on surrounding noise, etc.
 - ~1 KB of payload is transmitted during whole secrecy amplification phase (by every node)
 - 1 second worth local computation
 - 1-10 seconds to transmit all amplification messages

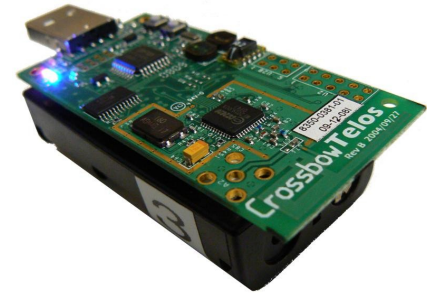

<https://github.com/crocs-muni/WSNProtectLayer>

CASE STUDY: WSNPROTECTLAYER

Scenario 1 - Warehouse

- Monitored devices with RFID-based radio tags
- Tracking of person movement
- Static routes
- Long-living network

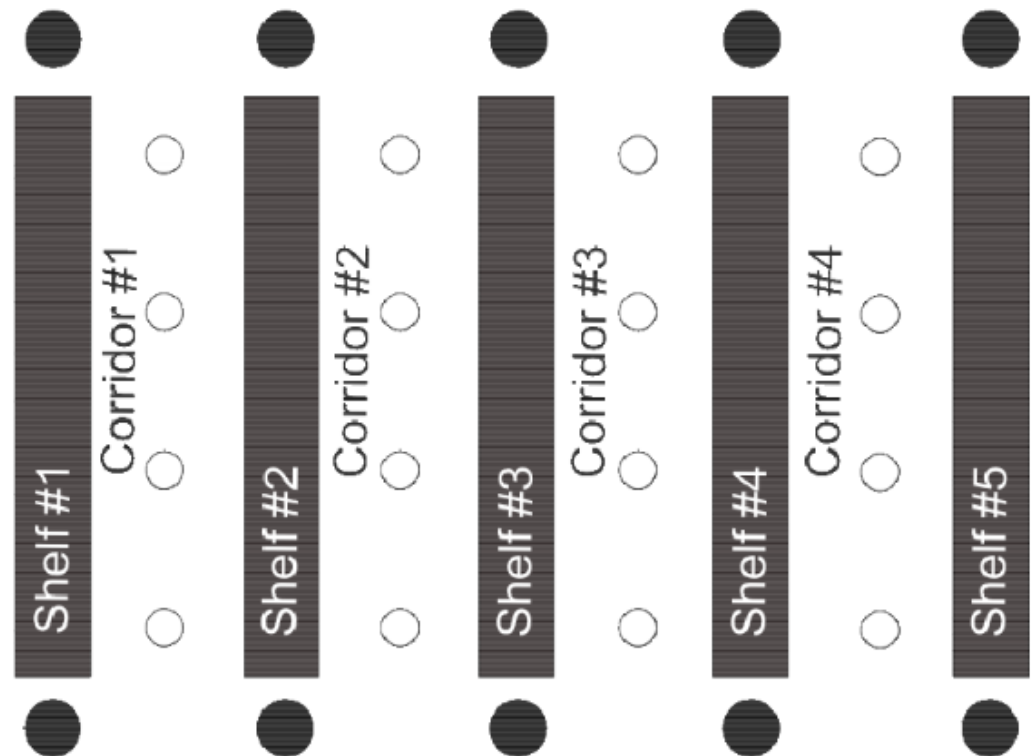

Scenario 2 – Police unit

- Defense of central point (base station)
- Detection of moving attacker
- Reporting of moving policeman
- Jamming detection
- Dynamic routes
- Short-living network

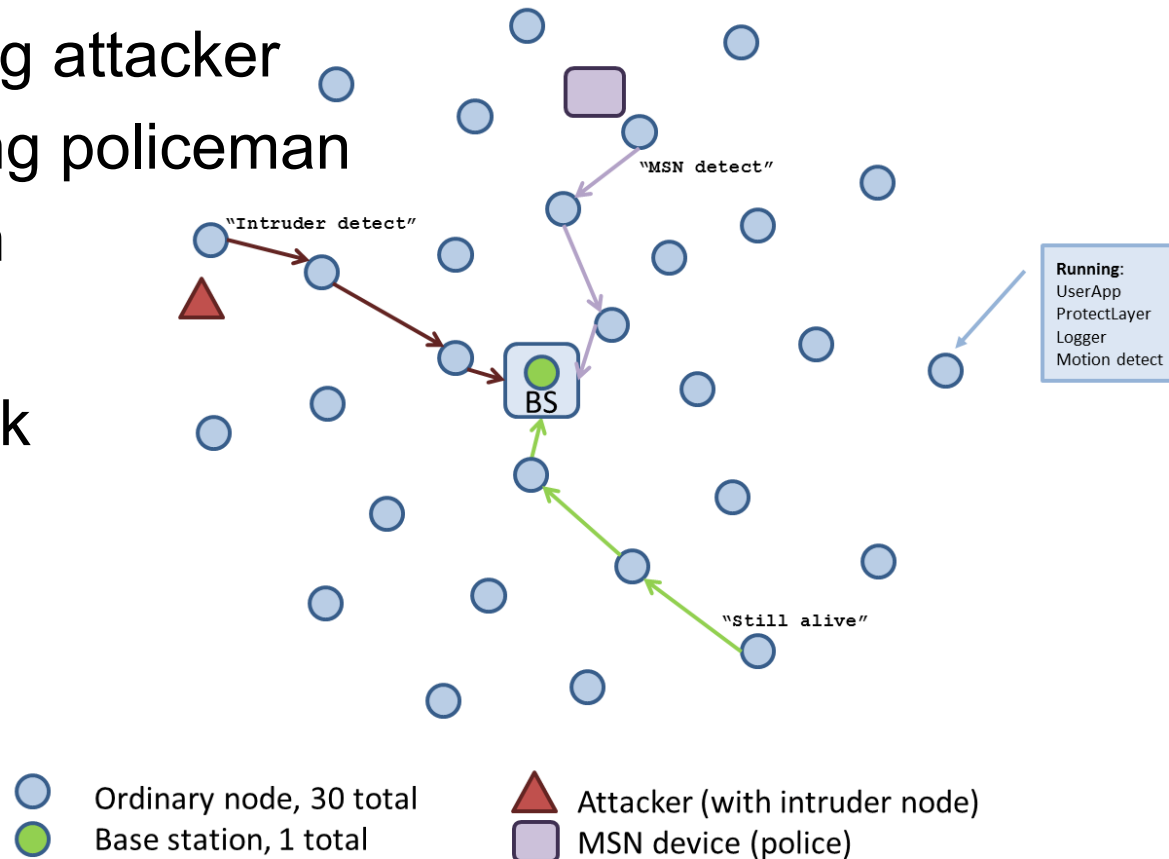

Scenario 3 – Building monitoring

- Tracking of selected person movement
- Multiple levels of privacy protection
- Static routes
- Long-living network

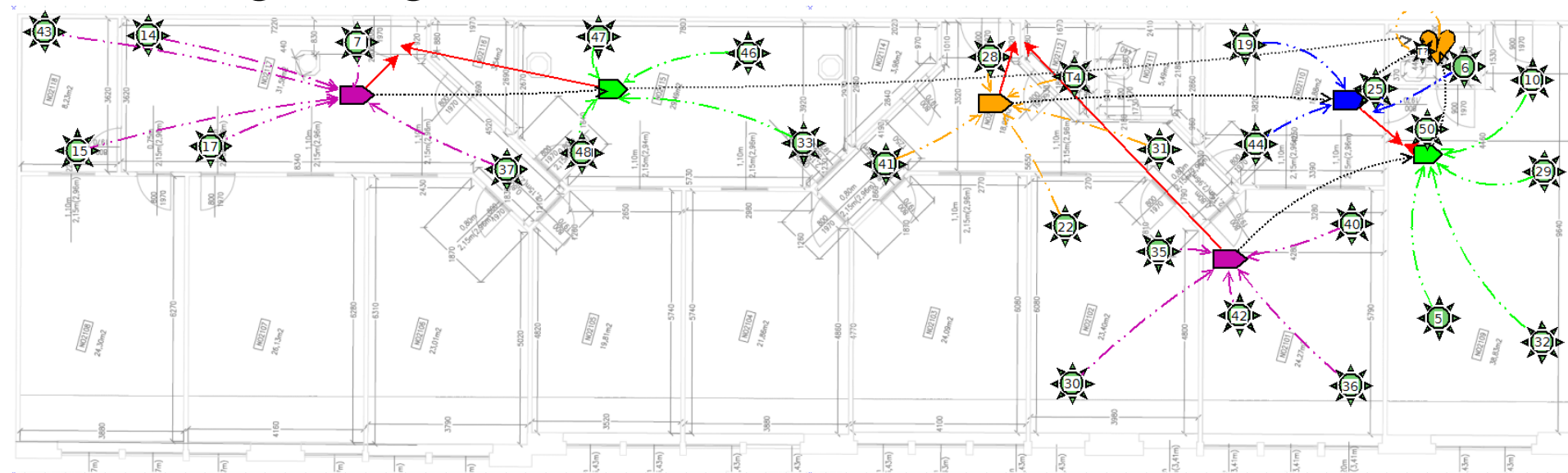

Attacker models assumed

- Local / global passive eavesdropping
 - Packet capture, traffic analysis
- Active attacker manipulating traffic
 - Packet dropping, injection, jamming
- Active attacker capturing nodes
 - And extracting cryptographic keys

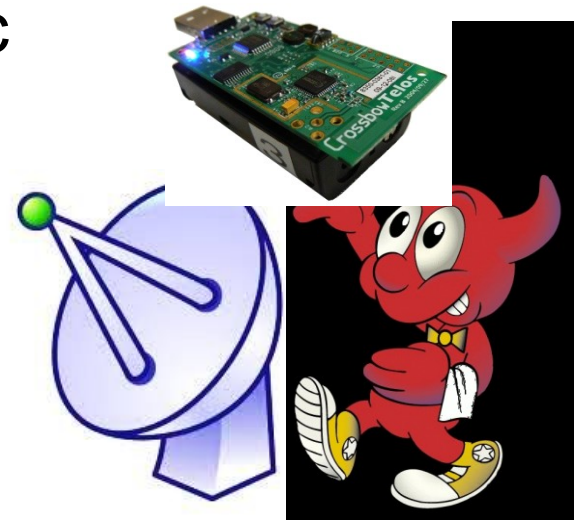

Core architecture components

- **Intrusion detection component**
 - Distributed packet dropper and jamming detection
 - Local neighbour reputation metric
 - Base station notified when misbehaving node is detected
- **Privacy protection component**
 - 4 levels of protection, controlled by authenticated broadcast
 - Open communication
 - Message integrity and authentication
 - Packet encryption
 - Traffic analysis-resistant phantom routing
- **Key management component**
 - Cryptographic key distribution and establishment (node, base stations)
 - Cryptographic services for other components



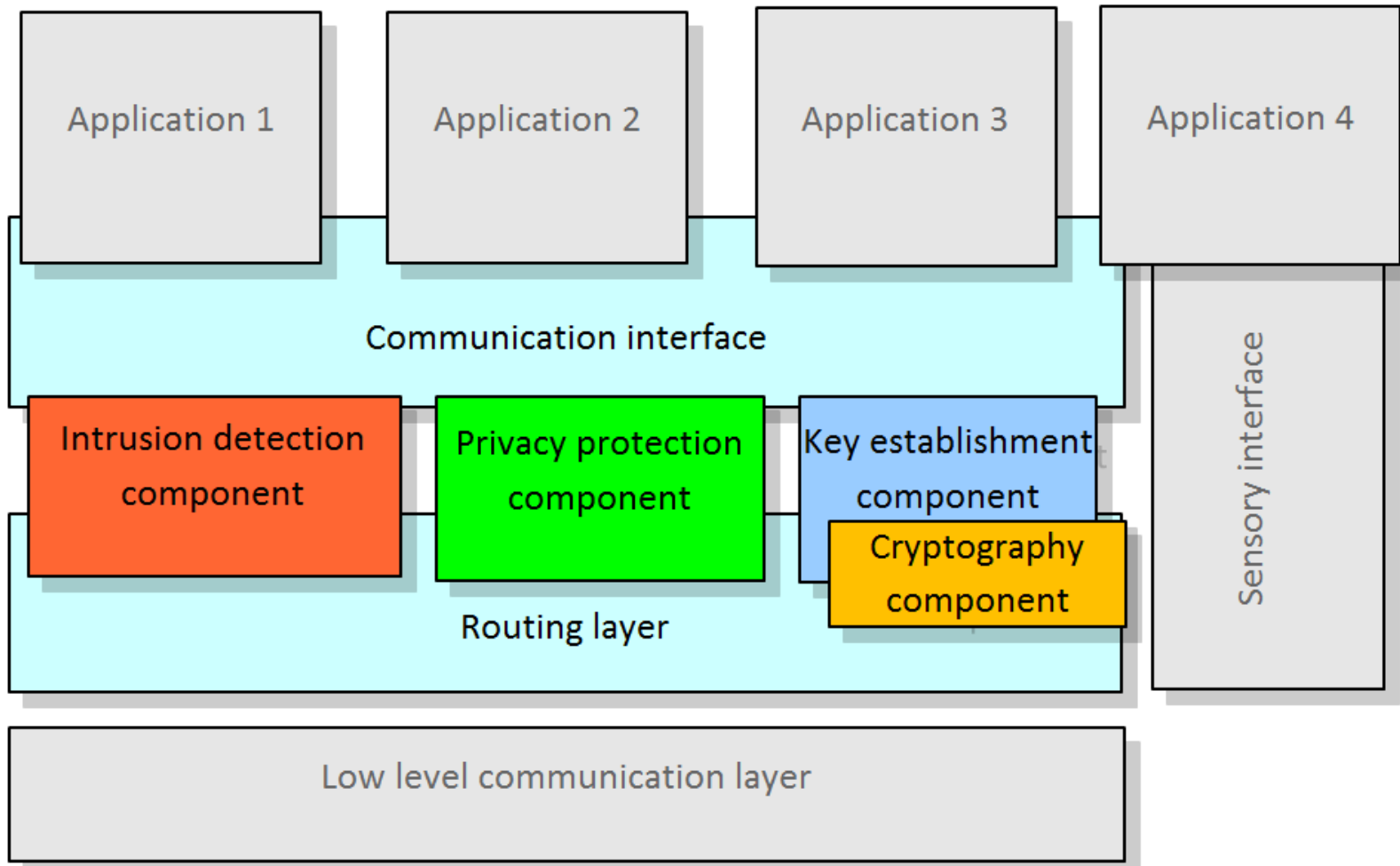

Architecture

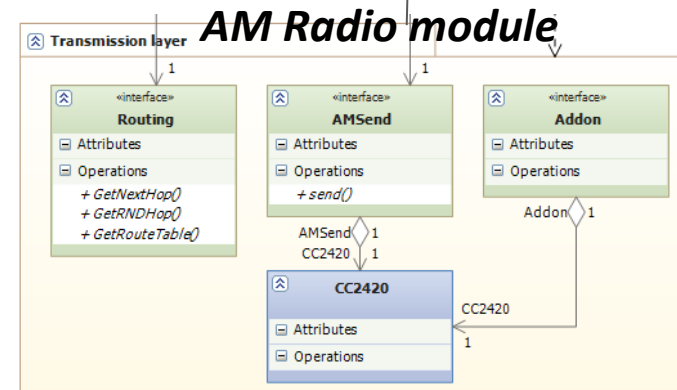
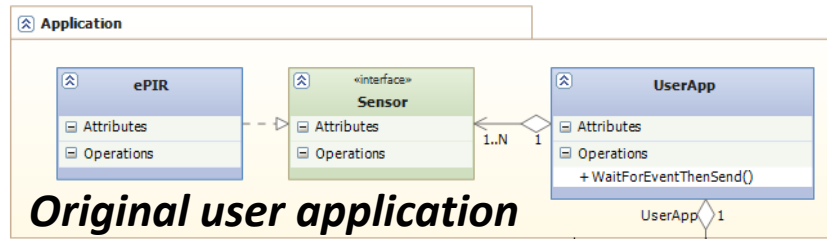

Hardware used, testbed

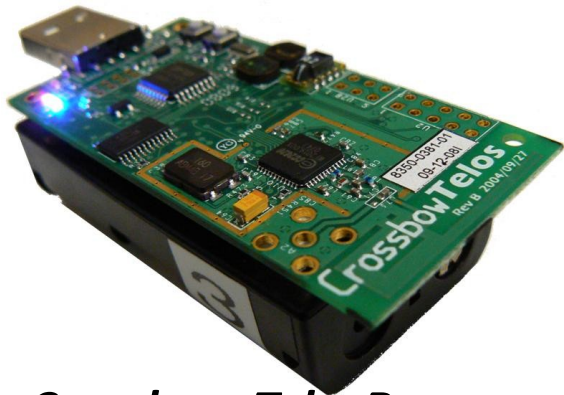

Crossbow TelosB



Crossbow MICAz

Zilog ePIR



RFID reader 125kHz

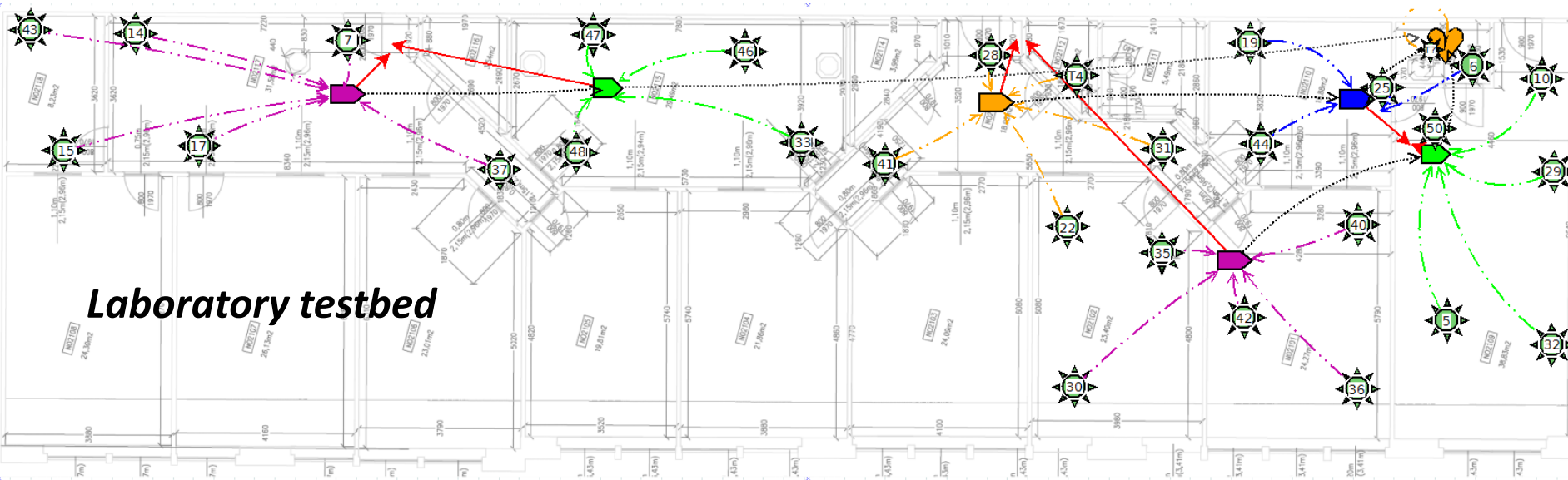

Laboratory testbed

```

configuration BlinkToRadioAppC {
}
implementation {
  components MainC;
  components LedsC;
  components BlinkToRadioC as App;
  components new TimerMilliC() as Timer0;
  components new TimerMilliC() as InitTimer;

```

---> Original Components

```

components ActiveMessageC;
components new AMSenderC(AM_BLINKTORADIO);
components new AMReceiverC(AM_BLINKTORADIO);

```

---> Replaced by new ProtectLayerC

```

// Basic components wiring
App.Boot -> MainC;
App.Leds -> LedsC;
App.Timer0 -> Timer0;
App.InitTimer -> InitTimer;

```

---> Original wirings

```

App.Packet -> AMSenderC;
App.AMPacket -> AMSenderC;
App.AMControl -> ActiveMessageC;
App.AMSend -> AMSenderC;
App.Receive -> AMReceiverC;

```

---> Replaced by new one to ProtectLayerC

```

}

```

```

configuration BlinkToRadioAppC {
}
implementation {
  components MainC;
  components LedsC;
  components BlinkToRadioC as App;
  components new TimerMilliC() as Timer0;
  components new TimerMilliC() as InitTimer;

```

components ProtectLayerC;

```

// Basic components wiring
App.Boot -> MainC;
App.Leds -> LedsC;
App.Timer0 -> Timer0;
App.InitTimer -> InitTimer;

```

```

App.Packet -> ProtectLayerC.Packet;
App.AMControl -> ProtectLayerC.AMControl;
App.AMSend -> ProtectLayerC.AMSend;
App.Receive -> ProtectLayerC.Receive;

```

```

}

```

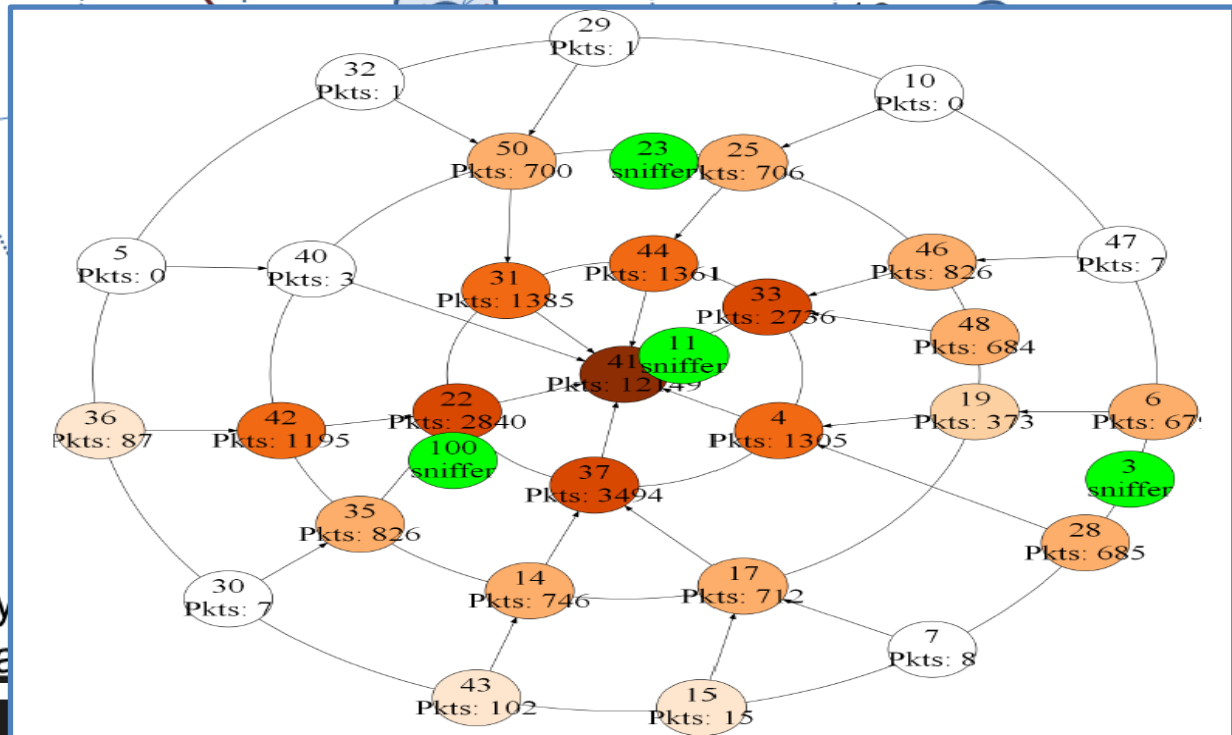
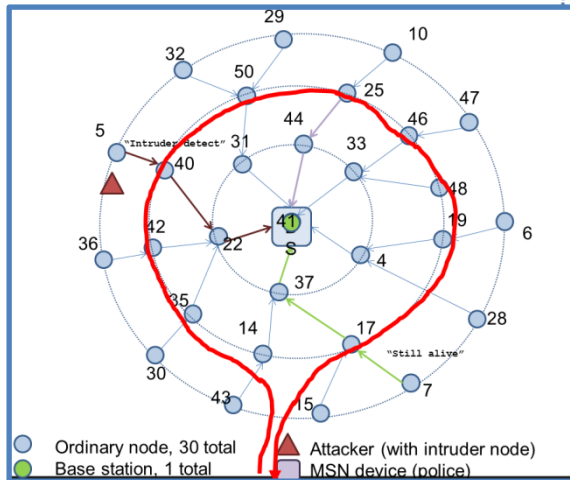
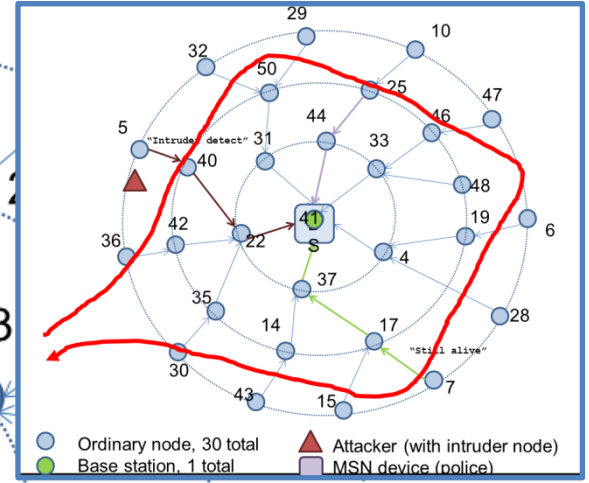
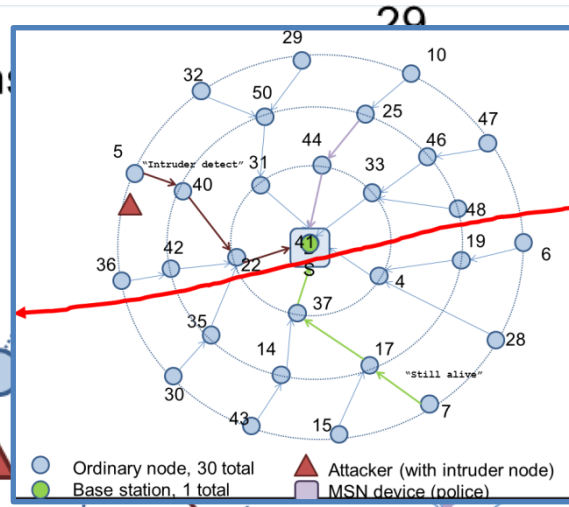
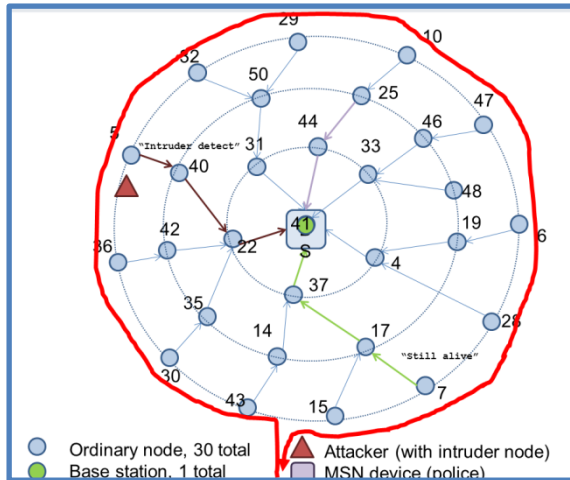

Try it!

- TinyOS 2.x-based (TelosB nodes used)
- *Václav MATYÁŠ, Petr ŠVENDA, Andriy STETSKO, Dušan KLINEC, Filip JURNEČKA a Martin STEHLÍK.*
WSNProtectLayer – security middleware for wireless sensor networks. Securing Cyber-Physical Systems. USA: CRC Press, 2015. s. 119-162, 44 s. CRC Press. ISBN 978-1-4987-0098-6.
- <https://github.com/crocs-muni/WSNProtectLayer>

Summary

- Common security protocols often cannot be used
 - Preference for symmetric crypto-only solutions
 - Low transmission overhead important due to energy
- Key distribution is (as usual) critical factor
- Partial compromise should be anticipated
 - And protocols designed to be able to cope with it
- Mandatory reading
 - A. Perrig et al: SPINS: Security Protocols for Sensor Networks
 - <https://users.ece.cmu.edu/~adrian/projects/mc2001/mc2001.pdf>