

# Cloud Service Delivery Models

# Agenda

- Internet and Cloud
- Elasticity and scalability
- Multitenancy
- Cloud service models - IaaS, PaaS, SaaS
- Common cloud management platform reference architecture
- Cloud Management

# Internet & Cloud

- It is important to distinguish the term “cloud” and the cloud symbol from the Internet.
- Cloud computing is the next stage of evolution of the Internet.
- Cloud computing is Internet-based computing, whereby shared resources, software and information are provided to computers (hardware) and other devices on-demand, like the electricity grid.
- Cloud is a new consumption and delivery model inspired by consumer Internet services

# Cloud terms

- IT Resources
- Cloud provider
- Cloud consumer
- Cloud service owner
- Cloud administrator
- Cloud broker

# Key Characteristics of Cloud

There are 6 specific characteristics common to all cloud environment:

On demand usage

Ubiquitous access

Multitenancy

Elasticity

Measured usage

Resiliency

# Elasticity and scalability

- The Elasticity and scalability is the ability to respond to the increased or decreased IT resources demand.
- Scaling UP represent the ability to add resources in term of CPU, memory, storage and even a full servers
- Scaling down is the apposite when you can due to decreased demand get out the unnecessary power that is not being used.
- There are two type of scalability: Horizontal and vertical scalability

# Horizontal scalability

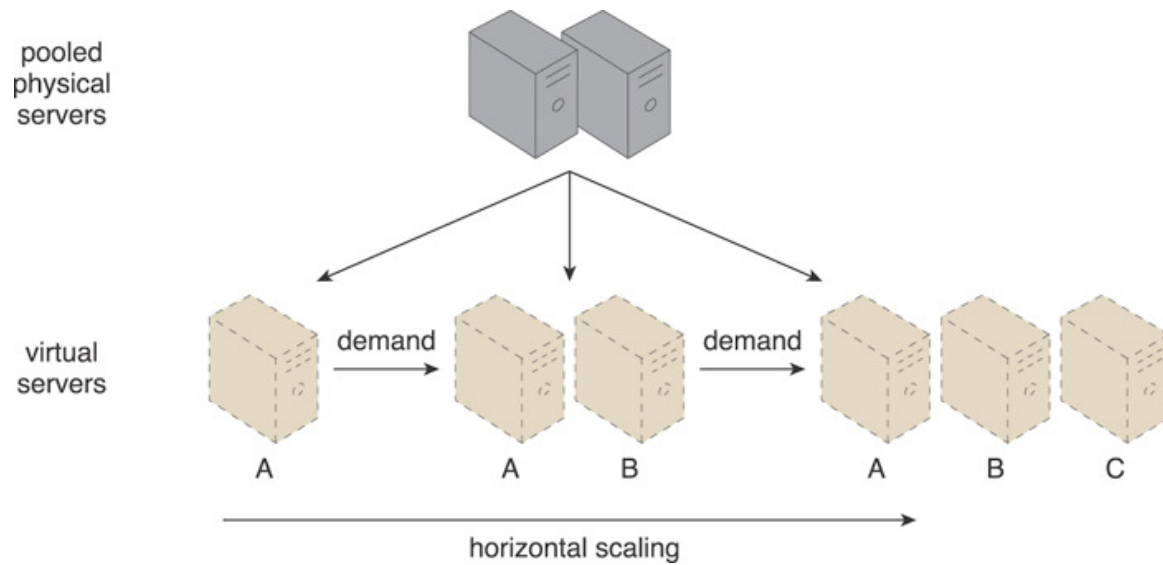

## Vertical scalability

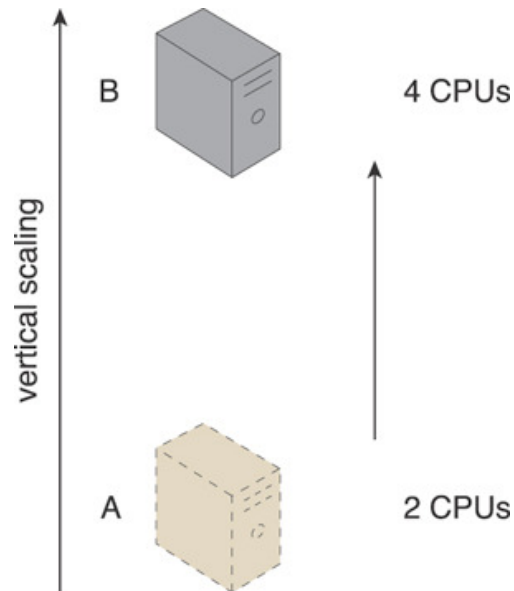

Elasticity and scalability are used to achieve this – Cloud services scale up to meet demand

– Cloud services scale down when higher demand is not required

– Customers only pay for services used



# Multitenancy

- Multitenancy is the ability to deliver an application to multiple client organizations from a single instance of software. When building software as a service applications, or platforms as a service, organizations should design applications with multitenancy in mind to minimize the per-tenant cost of delivery. Technical challenges associated with building a multitenant application include access control, customization (data, user interface, and business logic) and isolation of data.

# Cloud Service Models

- Cloud delivery/service model are the way how services within the cloud are packaged and given to customer for use.
- Three main service model are identified however those models has evolved to produce various other models: IAAS (Infrastructure as a service) PAAS (Platform as a service) SAAS (Software as a service).
- Notes there are many other forms developed like storage as service etc

# Infrastructure as a Service

- In the infrastructure as a service model, the consumer can provision fundamental computer resources such as processors, storage, and networking resources.
- Open stack has become an option for many company due to the easy access and good portability.

# Why Open stack as form of IAAS

## **Open standards:**

- Are embraced by an active community that facilitates innovation at a more rapid pace
- Provide a common foundation and compatible interfaces that enable portability across cloud models and avoid vendor lock-in
- Limit the need for specialized experts to build custom interfaces
- Meet user needs because they are the result of collaboration across clients, providers, vendors and developers

# Platform as a Service

In this model, the computing platform and solution stack are made available as a service. Customers can develop, test, and deploy their applications on the cloud.

# Software as a Service

- In the software as a service model, the same software or applications are provided to different customers, or consumers via a network, usually the Internet. The software no longer resides on the consumer's workstation. Instead, the consumer accesses the provider's applications running on a cloud infrastructure using various client devices through a thin-client interface such as a web browser. A good example could be web-based email running on a cloud infrastructure.

# Comparison Of level of Control

Cloud Delivery Model	Typical Level of Control Granted to Cloud Consumer	Typical Functionality Made Available to Cloud Consumer
SaaS	usage and usage-related configuration	access to front-end user-interface
PaaS	limited administrative	moderate level of administrative control over IT resources relevant to cloud consumer's usage of platform
IaaS	full administrative	full access to virtualized infrastructure-related IT resources and, possibly, to underlying physical IT resources

# Comparison of Activities

Cloud Delivery Model	Common Cloud Consumer Activities	Common Cloud Provider Activities
SaaS	uses and configures cloud service	implements, manages, and maintains cloud service monitors usage by cloud consumers
PaaS	develops, tests, deploys, and manages cloud services and cloud-based solutions	pre-configures platform and provisions underlying infrastructure, middleware, and other needed IT resources, as necessary monitors usage by cloud consumers
IaaS	sets up and configures bare infrastructure, and installs, manages, and monitors any needed software	provisions and manages the physical processing, storage, networking, and hosting required monitors usage by cloud consumers



# Common cloud management platform reference architecture

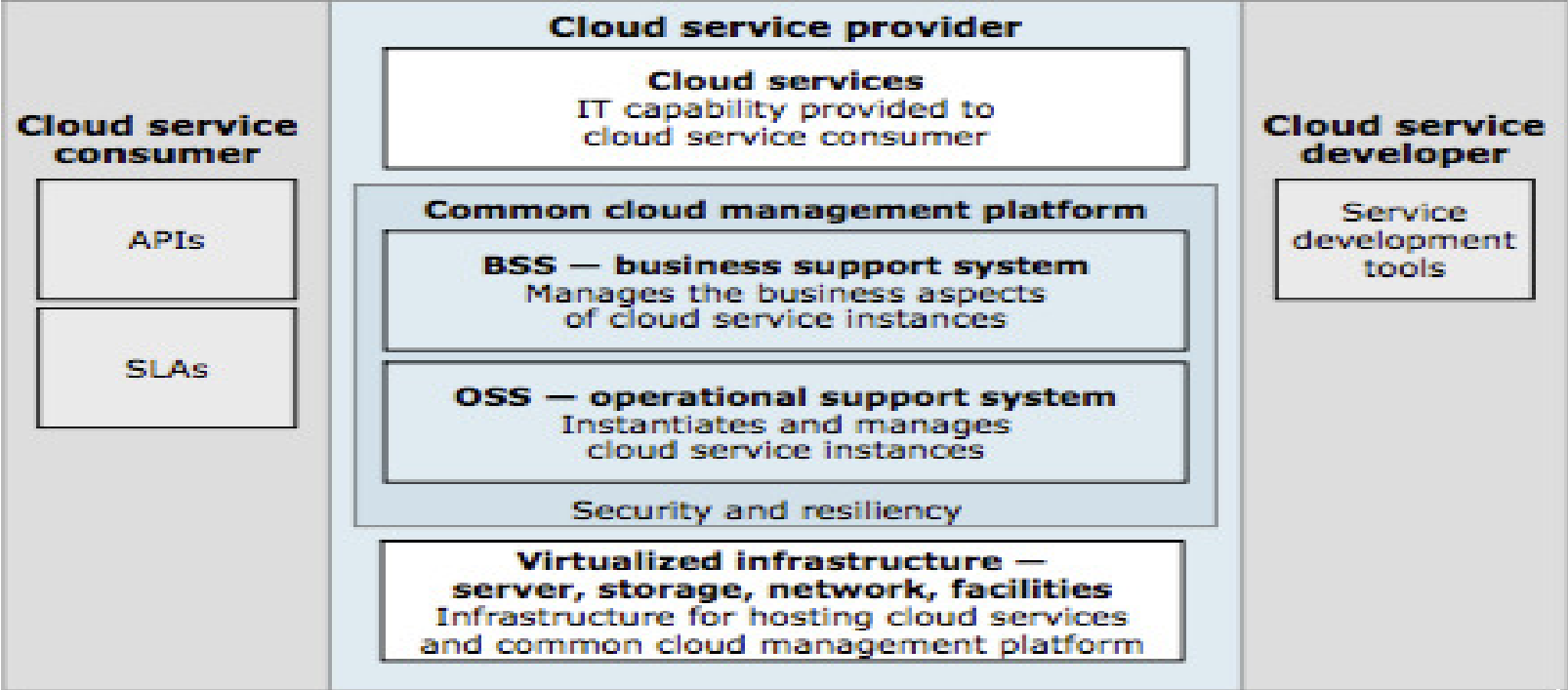

# Management of the cloud

- Cloud-based IT resources need to be set up, configured, maintained, and monitored.
- The following management-related mechanisms are necessary for the management of the cloud
  - Remote administration system
  - Resource management system
  - SLA Management system
  - Billing Management system
- Through the API cloud manager have the ability to control and monitor the Cloud within the contract boundaries as per the cloud delivery model agreed.

Backup Slide

- IBM example for deploying open stack

# How IBM Cloud OpenStack Services meets key requirements for cloud solutions.

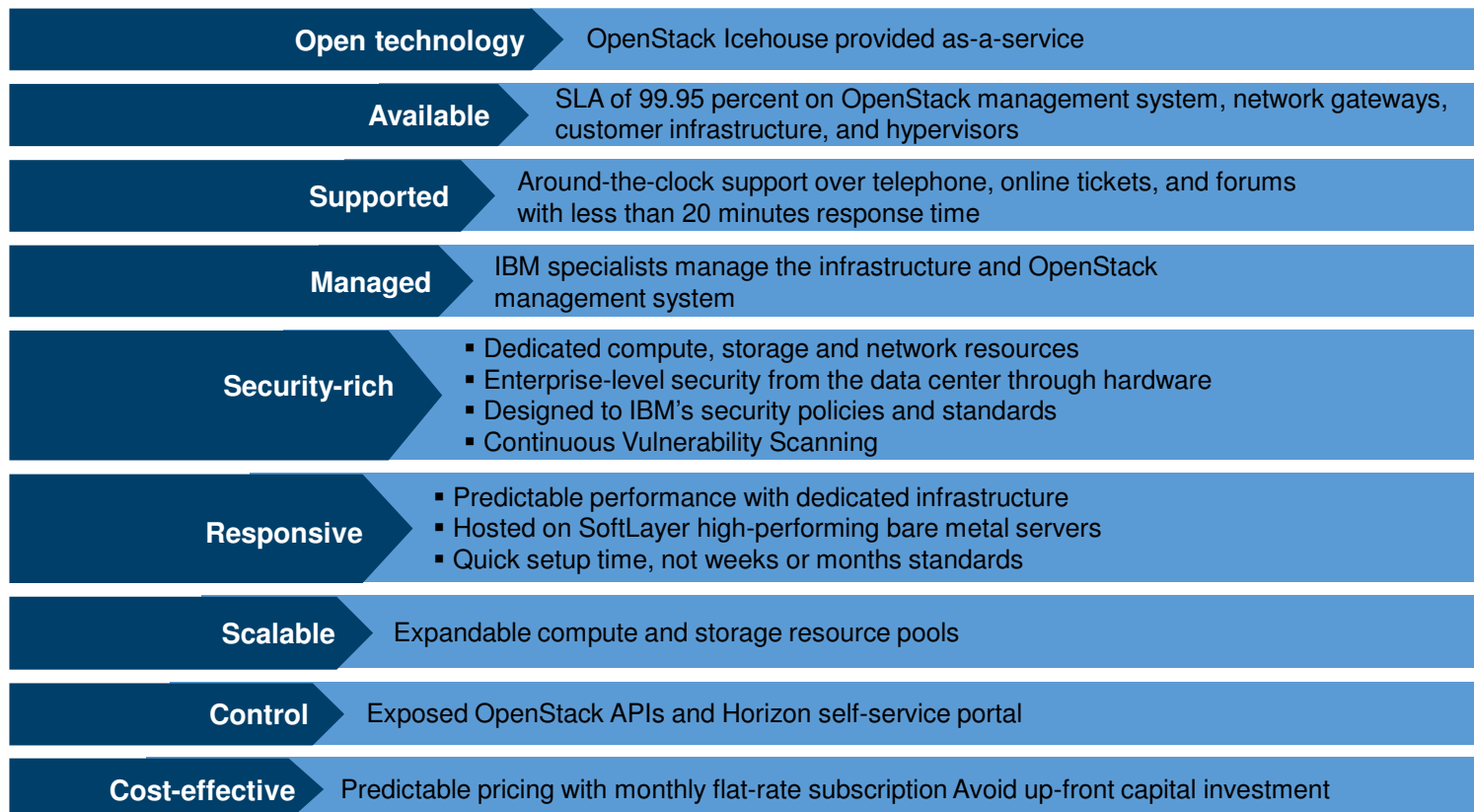

# With IBM Cloud OpenStack Services, you can have a managed private cloud environment set up at worldwide locations.

- Turnkey solution for workloads such as hosted enterprise, analytics, and web and mobile applications
- Dedicated infrastructure on high-performing, easily scalable SoftLayer bare metal
- IBM manages the OpenStack management systems, network gateways, compute and storage hardware and hypervisor.

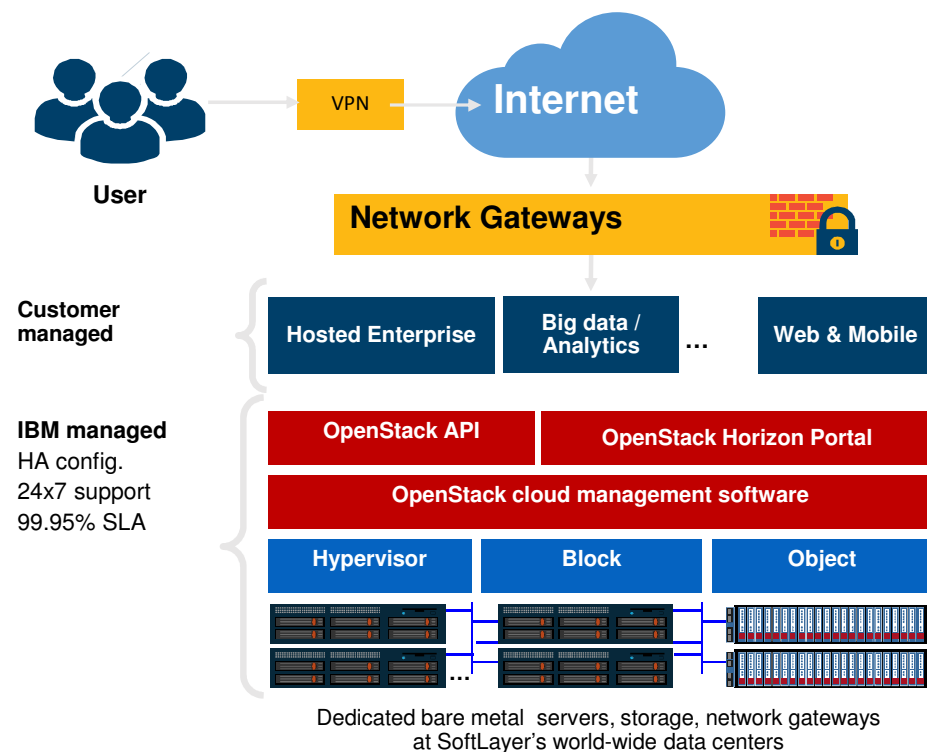

IBM Cloud OpenStack Services runs on OpenStack Icehouse to provide you with an environment built on open standards.

**Other OpenStack components included:**

- **Heat** – for pattern orchestration
- **Ceilometer** – for reporting, metering

**OpenStack experimental projects are not enabled by default:**

- Trove
- Sahara

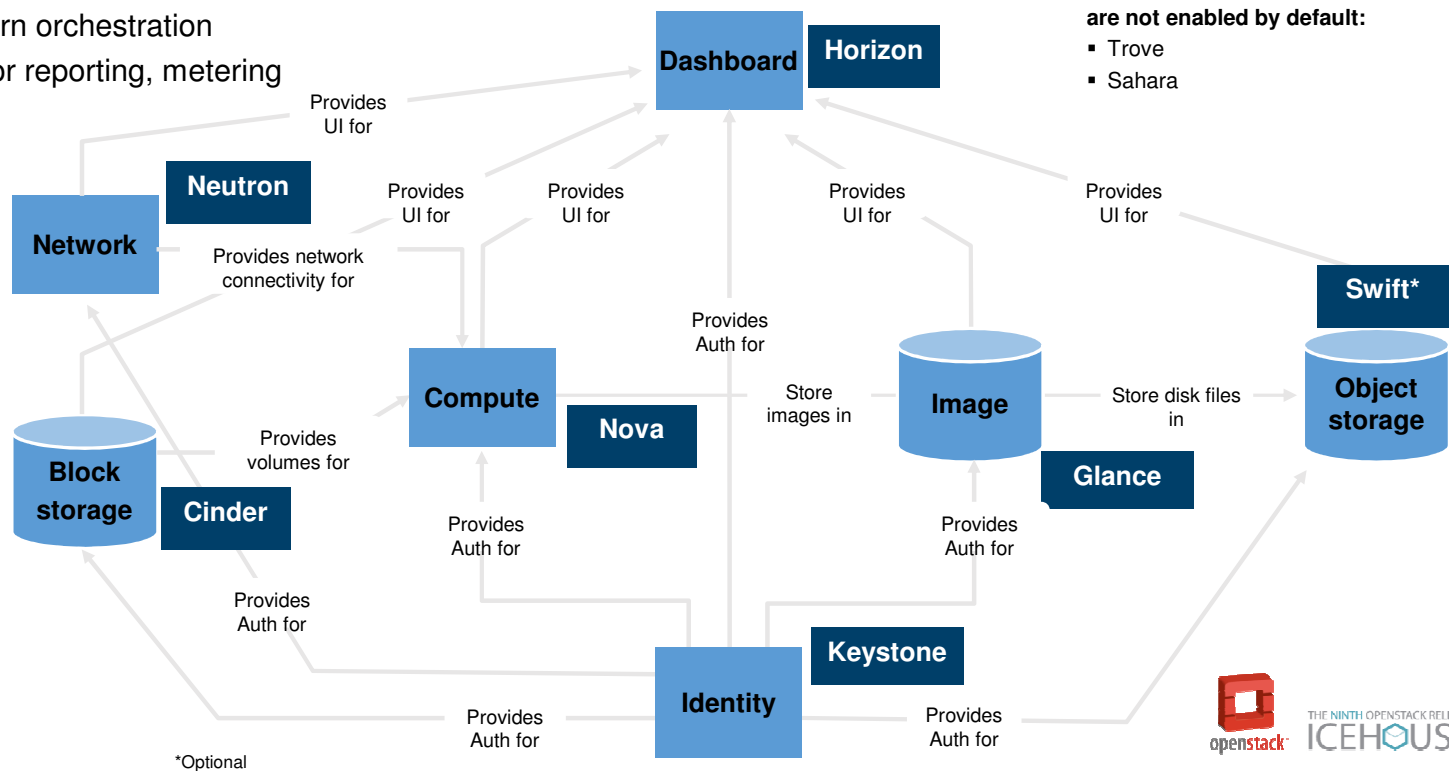

Your OpenStack management environment is configured with redundancy for high availability and diversity in data paths for security.

## Management System

## Compute nodes

Balanced  
Memory Optimized  
I/O Optimized

## Block storage

8 TB, 16 TB,  
32 TB, 64 TB, 96TB

## Object storage

16 TB, 32 TB,  
64 TB, 128TB

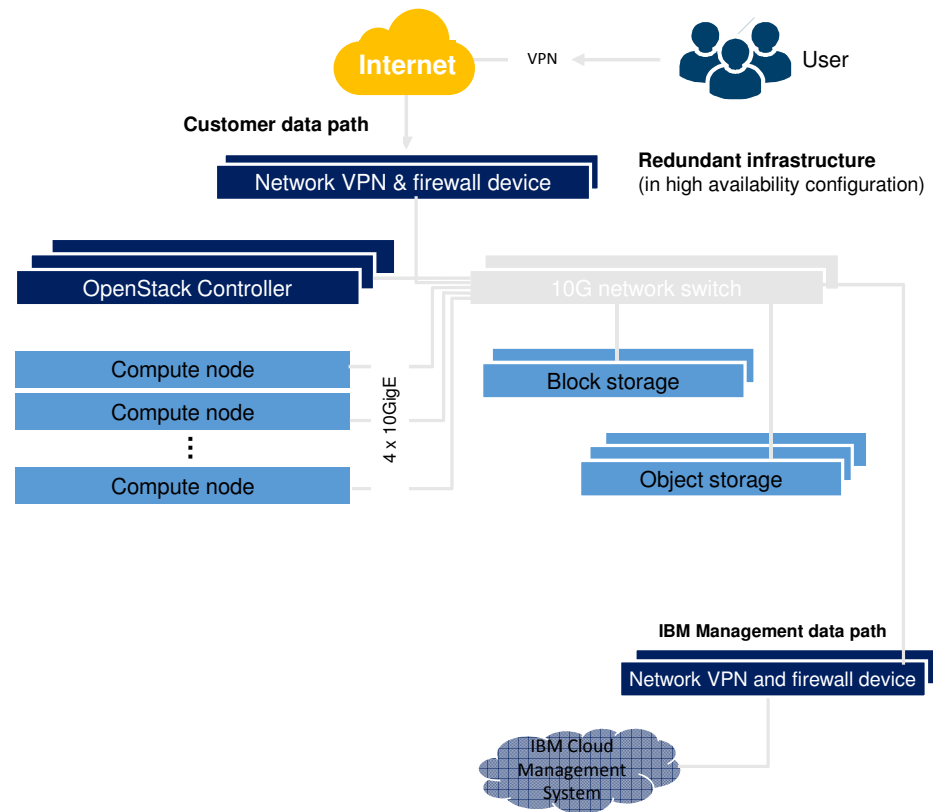



Integrated Software-defined networking (SDN) provides a multi-tier network architecture that is dynamically configured and self-service.

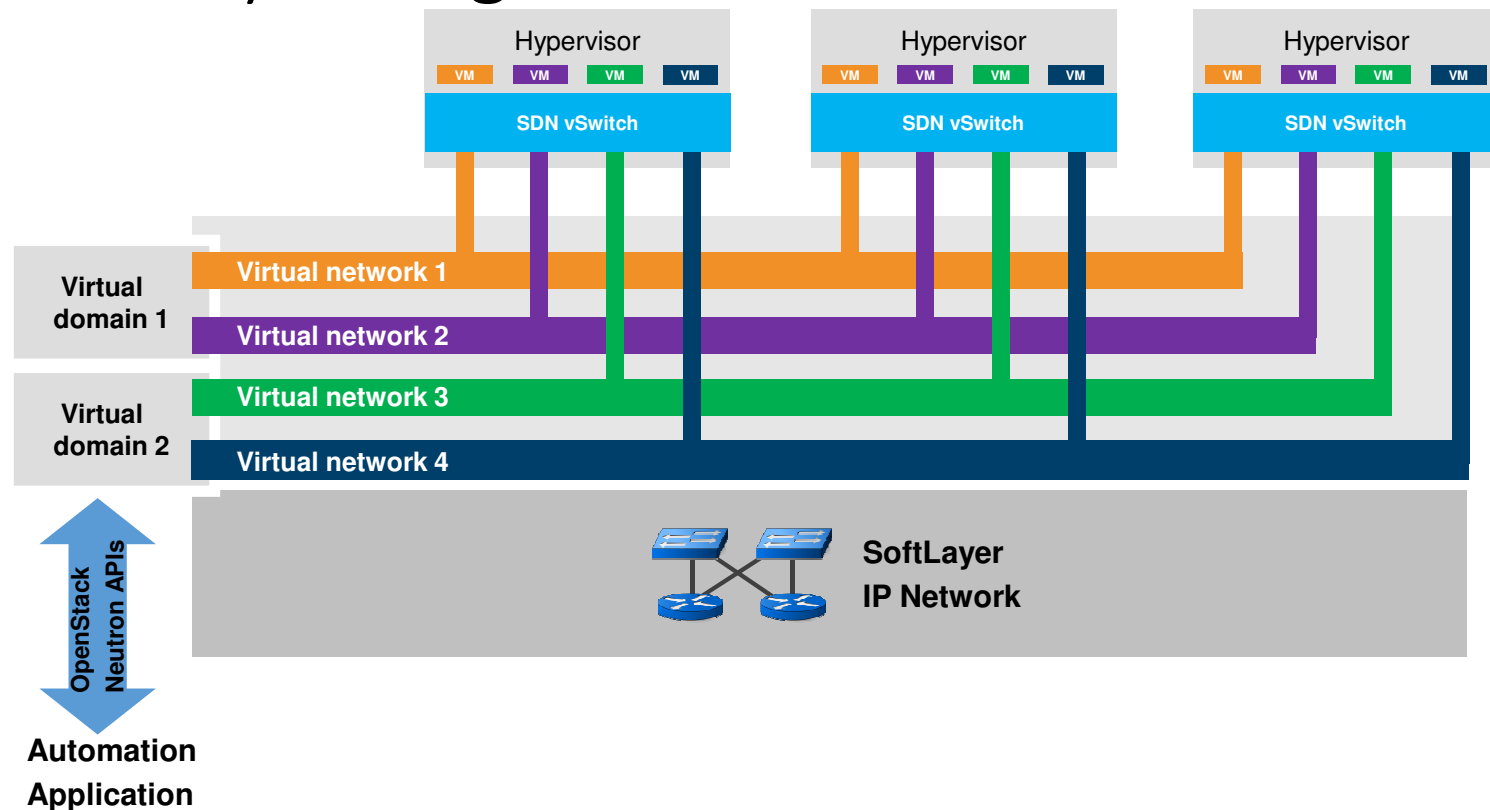

You can access SoftLayer services over the public network to expand the capabilities of your solution.

- SoftLayer storage
  - SoftLayer object storage
  - SoftLayer backup
  - SoftLayer NAS
  - SoftLayer lockbox
  - SoftLayer iSCSI
- SoftLayer bare metal servers
- SoftLayer dedicated hardware like firewalls
- SoftLayer load balancer
- SoftLayer Cloudera, MongoDB, CloudPlatform, Riak
- SoftLayer monitoring

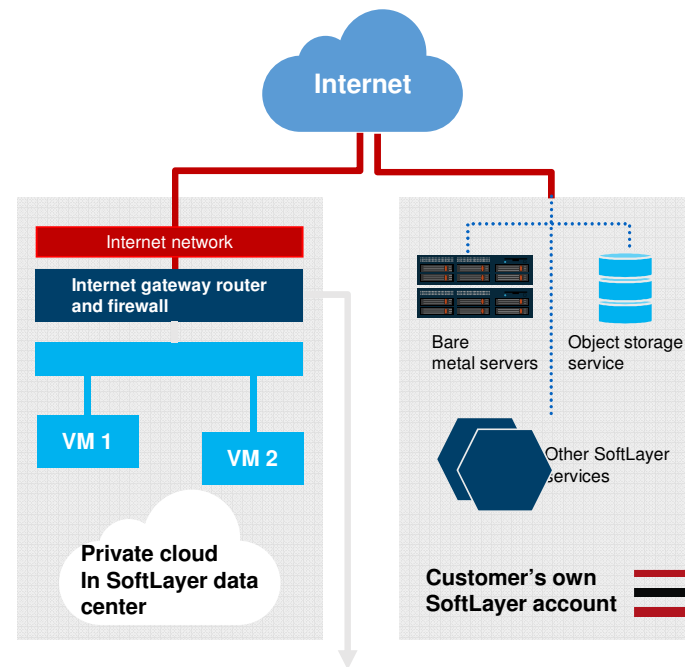

Internet gateway router establishes secure connectivity between IBM Cloud OpenStack Services private cloud infrastructure and your other servers running elsewhere in SoftLayer data centers worldwide.