

The world of Technical Writing



Shweta Jalgaonkar
Content Strategist

Vendula Ferschmannova
Associate Manager

Šárka Jana Janderková
Technical Writer

Who we are



- Studied Economics in Brno
- 1 year in techcomm
- Currently working remotely from Znojmo for Red Hat Brno
- Linux enthusiast

Šárka Jana Janderková
Technical Writer, CCS



- Studied Chemistry in India
- More than 12 years in techcomm
- Currently working remotely from Prague for Red Hat Brno
- Cross-functional collaboration

Shweta Jalgaonkar
Associate Content Strategist



- Studied Archeology in Pilsen
- More than 20 years in techcomm
- Currently working remotely from Pilsen for Red Hat Brno
- Minimalism

Vendula Ferschmannova
Technical Writing Manager

What will we talk about today



What documents are these

IMPORTANT

READ THIS INSTRUCTION MANUAL CAREFULLY before attempting to operate the transceiver.

SAVE THIS INSTRUCTION MANUAL. This manual contains important safety and operating instructions for the IC-7200.

FOREWORD

We understand that you have a choice of many different radios in the market place. We want to take a couple of moments of your time to thank you for making the IC-7200 your radio of choice, and hope you agree with Icom's philosophy of "technology first." Many hours of research and development went into the design of your IC-7200.

FEATURES

- IF DSP features
- Digital Twin PBT
- Manual notch function
- ±0.5 ppm of high frequency stability
- Simple operation
- Tough and compact body
- Standard voice synthesizer

EXPLICIT DEFINITIONS

WORD	DEFINITION
⚠WARNING	Personal injury, fire hazard or electric shock may occur.
⚠CAUTION	Equipment damage may occur.
NOTE	If disregarded, inconvenience only. No risk of personal injury, fire or electric shock.

SUPPLIED ACCESSORIES

The transceiver comes with the following accessories.

	Qty.
① Hand microphone (HM-36)	1
② DC power cable (OPC-1457)	1
③ Spare fuse (ATC 5 A)	1
④ Spare fuse (ATC 30 A)	2
⑤ ACC cable	1
⑥ 3.5 (d) mm plug	1
⑦ 6.3 (d) mm Electronic keyer plug	1
⑧ Microphone hanger	1
⑨ Jack cap (for [PHONES])	1

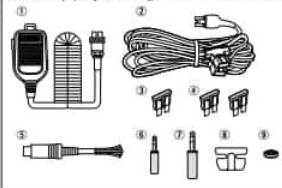

FCC INFORMATION

• FOR CLASS B UNINTENTIONAL RADIATORS:
This equipment has been tested and found to comply with the limits for a Class B digital device, pursuant to part 15 of the FCC Rules. These limits are designed to provide reasonable protection against harmful interference in a residential installation. This equipment generates, uses and can radiate radio frequency energy and, if not installed and used in accordance with the instructions, may cause harmful interference to radio communications. However, there is no guarantee that interference will not occur in a particular installation. If this equipment does cause harmful interference to radio or television reception, which can be determined by turning the equipment off and on, the user is encouraged to try to correct the interference by one or more of the following measures:

(A)

Components

1. Self-Drilling / Taping Screw
2. Wire Nuts
3. Side Brackets
4. Light Fixture
5. Power Supply
6. CDS Sensor

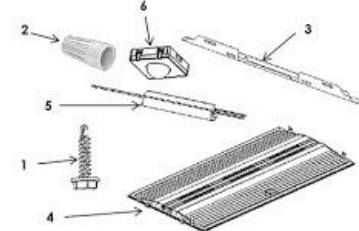

Installation Instructions

The replacement light fixture is pre-assembled at the factory. Some components need to be mounted to the existing 4 foot light housing before the fixture can be installed into its operating position.

1. To reduce the risk of electrical shock, turn off the power at the circuit breaker panel.
2. Remove all the components of the fluorescent light fixture, including diffuser / cover, lamp, lamp pedestals, wiring, reflector and fluorescent light ballast. All that should remain is the bare 4 foot housing with the incoming power wiring.

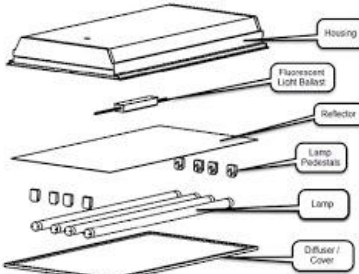

(B)

Restraint System Mounting Zones (Side View)

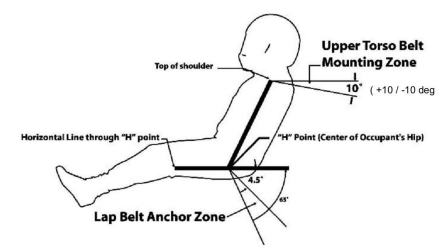

Figure 1: Shoulder and Lap Belt Mounting Zones – Upright Seating Position

The Lap Belts should be mounted off the center of the drivers' hip at an angle of 45 to 65 degrees down from the horizontal, (see Figure 1) All seat belt mounts need to be as close to the seat system as possible. In some cases, it is advantageous to mount the belts inside the seat. The lap belts should be mounted with a double shear type mount and the lap anchor should be allowed to rotate freely.

It is advantageous to have the Pull Up style adjuster on the lap belt inside the seat, just on top of the leg radius. Custom size anchors can be ordered to facilitate this. In some cases, this may not be a viable option because of driver size. If this is the case, the adjuster must be mounted outside the seat with a short pull up mount.

The path that the lap belt takes from the anchor to the buckle must be free of obstruction. If the belt routes through a seat opening, it must allow for the belt to rotate forward by at least 30 degrees without being cut or frayed.

The lap belt mount needs to have a secure anchor to the chassis or frame of the vehicle. The mount should be capable of withstanding a 3500 lb shock load.

Lap Belt Mounting for a Reclined Seating Position (Less than 65 Degrees of back angle) For Lap Belt mounts in a reclined seating position it is necessary to change the lap belt mounting zone to 0 degrees, vertical, +/- 10 degrees. This is because of the lower angle of the pelvis. The belt should route over the flats on your pelvis on both sides.

The Shoulder Belts should be mounted at an angle of 0 to 20 degrees down from the top of the shoulder (see Figure 1) The shoulder belts need to be mounted as close to the driver as possible. They may also angle

www.simpsonraceproducts.com 2 1-800-731-4404
Version 1

(C)

The software documentation

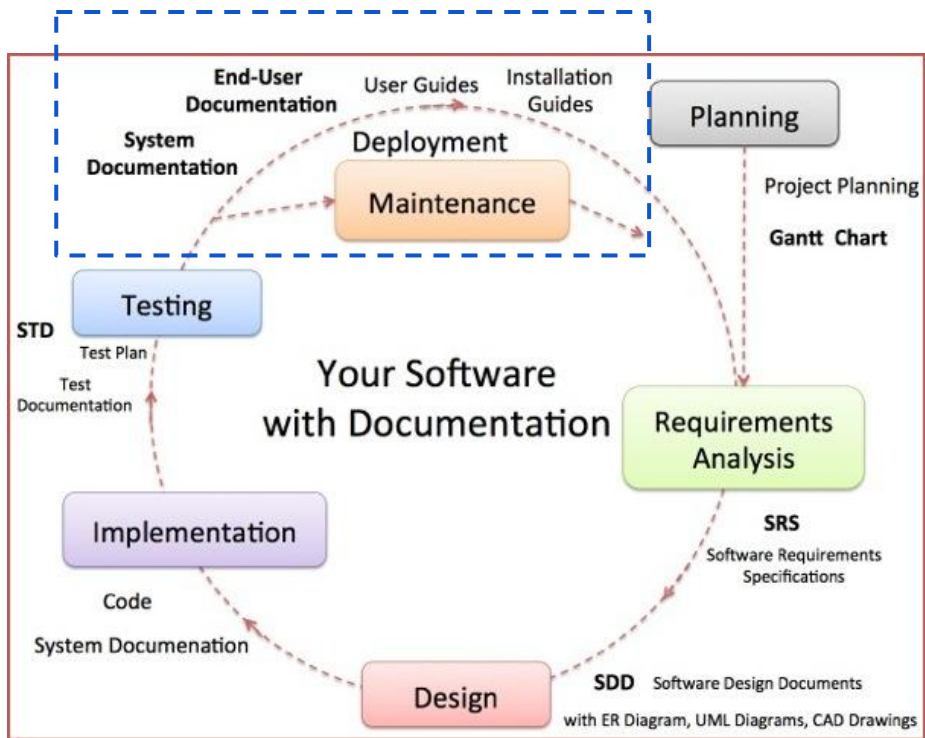

- Release notes
- Installation guide
- Administrator's guide
- Configuration guide
- Online help

What is technical writing



- Process of defining, creating and delivering information
- A broader field that includes any form of communication
- Predominant in the software industry, but also includes communicating about medical procedures, or environmental regulations and so on.
- Communicating by using technology, such as web pages, help files, or social media sites.
- Providing instructions about how to do something, regardless of how technical the task.

Simplifying Complex!

Who are technical writers



- Bridge between users and software developers
- Storytellers who understand and explain technical concepts in simple words
- Creative minds who understand the user requirements and translate the software features as offerings
- Presenters who present the information in user-friendly format

Why do we need writers

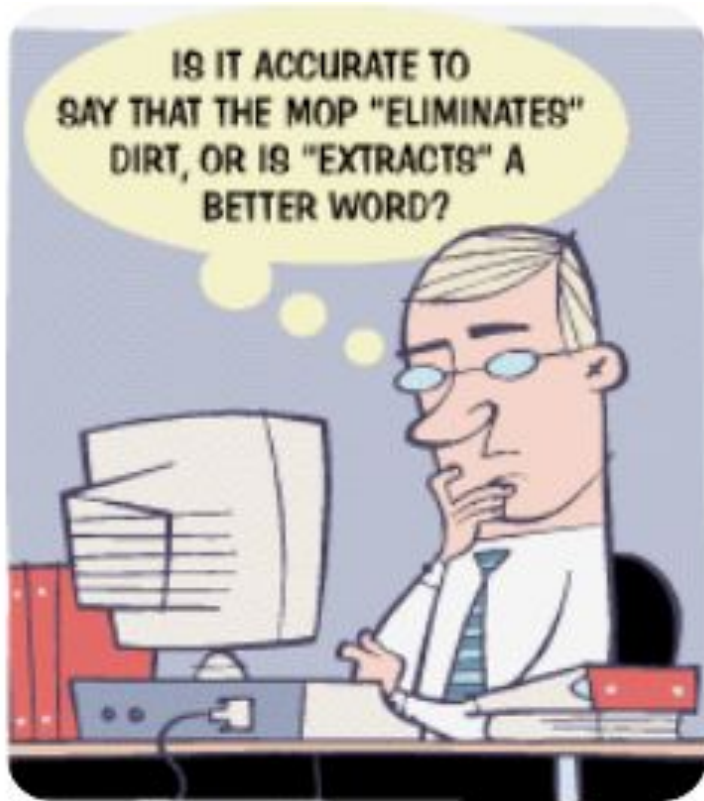

- Focussed on user's perspective
- Ability to express complex things easily
- Simplified English and Grammar
- Information flow
- Minimalism principles
- Authoring languages
- Publishing toolchain
- Analytics
- Single sourcing
- Findability
- User experience
- Microcopy
- Translation

EXERCISE 1: Tea

- ▶ Describe the process of making
1 cup of loose-leaf tea



Academics of Technical Writing

Technical writing means simplifying the complex

Schools:

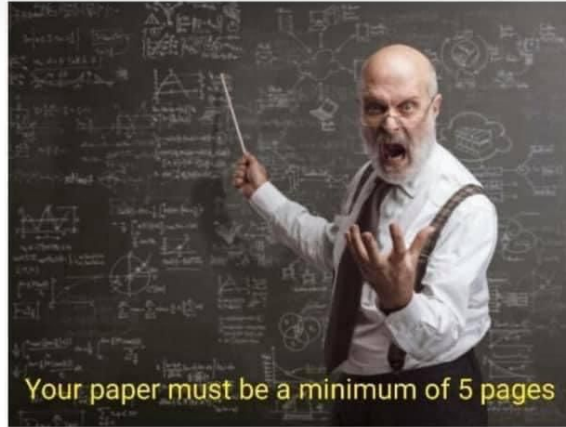

Your paper must be a minimum of 5 pages

The Real World:



Explain it to me in seven seconds or i'm out

Why do we need to simplify the complex?

- ▶ Customers don't have time
- ▶ Customers don't want to feel stupid
- ▶ We want to present our products as simple and easy to use as possible
- ▶ What is not published on the Internet does not exist

Principles of technical writing

PURPOSE

AUDIENCE

CONTENT

WRITING

VISUALS

LAYOUT

STRUCTURE

ETHICS

SEARCHABILITY

How to make a message simple

- ▶ Screenshots | Workflows | Visuals
- ▶ Concepts
- ▶ Procedures
- ▶ Consistent vocabulary
 - Simplified English

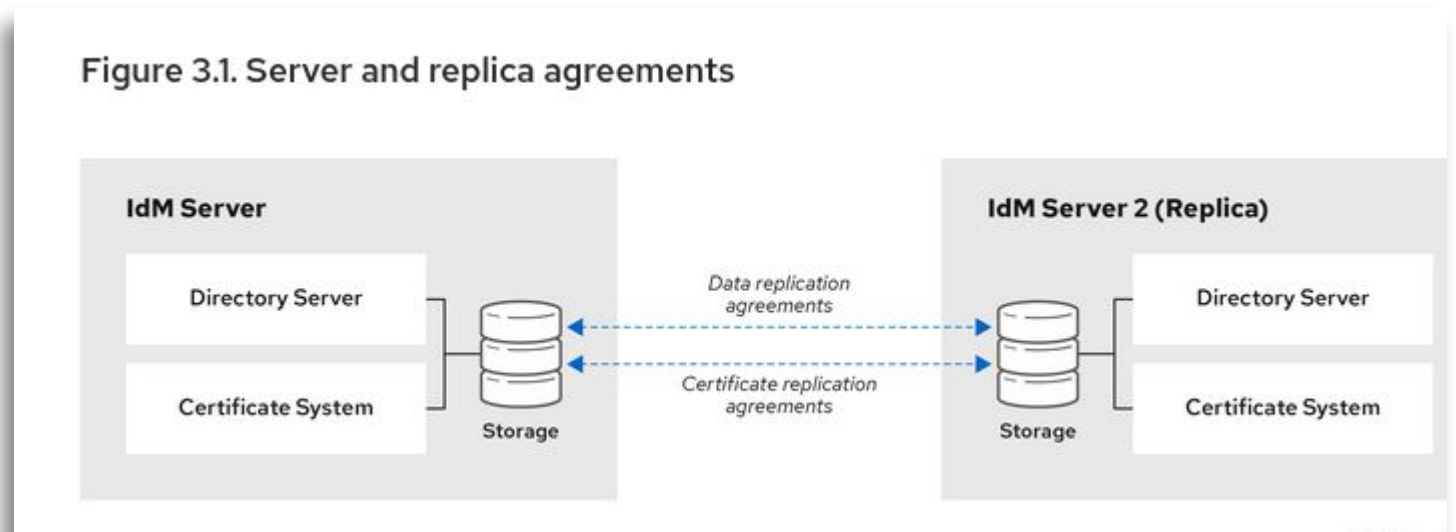

All about structure

Structure allows me to reduce words:

- ▶ Bulleted list vs. Ordered list
- ▶ Consistent highlighting
- ▶ No bricks of text
- ▶ Blank space
- ▶ Admonitions: Note, Warning, Example, Tip
- ▶ Color

All about structure

Structure allows me to reduce words:

- ▶ Bulleted list vs. Numbered list

Bulleted list:

- ▶ Apples
- ▶ Pears
- ▶ Water melons
- ▶ Strawberries

Numbered list:

1. Open a book.
2. See page 37.
3. Read the content.
4. Close the book.



English ▾

Multi-page HTML ▾

Managing systems using the Cockpit web interface

Preface

This is a beta version!

Providing feedback on Red Hat documentation

1. Getting started with Cockpit

1.1. Prerequisites

1.2. What is Cockpit?

1.3. Installing Cockpit

1.4. Logging in to Cockpit

1.5. Adding remote systems

2. Managing user accounts in Cockpit

2.1. Prerequisites

2.2. System user accounts managed in Cockpit

2.3. Adding new accounts in Cockpit

2.4. Enforcing password expiration in Cockpit

1.3. Installing Cockpit

[Feedback](#)

Red Hat Enterprise Linux 8 includes Cockpit installed by default in many installation variants. If this is not the case on your system, install the `cockpit` package and set up the `cockpit.socket` service to enable the Cockpit interface.

Procedure

1. Install the `cockpit` package:

```
$ sudo yum install cockpit
```

2. Optionally, enable and start the `cockpit.socket` service, which runs a web server. This step is necessary, if you need to connect to the system through the web interface.

```
$ sudo systemctl enable --now cockpit.socket
```

To verify the previous installation and configuration, you can [open the web interface](#).

If you are using a custom firewall profile, you need to add the `cockpit` service to `firewalld` to open port 9090 in the firewall:

```
$ sudo firewall-cmd --add-service=cockpit --permanent  
$ firewall-cmd --reload
```



EXERCISE 2: Structure

- ▶ Rewrite the following instructions for RHEL 8 CSB post-installation script for better readability:

Encryption change tool

Please fill out all the fields below.

Your encryption password must contain at least: **14** characters and **3** of the **4** character classes (**uppercase** letter, **lowercase** letter, **number**, **special** character)

(We recommend using your Kerberos password also as encryption password.)

POSSIBLE SOLUTION: Structure

Encryption change tool

Please fill out all the fields below.

Your encryption password must contain at least: **14** characters and **3** of the **4** character classes (**uppercase** letter, **lowercase** letter, **number** , **special** character)

(We recommend using your Kerberos password also as encryption password.)

Setting your hard drive encryption password

Set your encryption password to contain at least **14** characters.

Use **all** of the following character classes:

- ▶ **uppercase** letters
- ▶ **lowercase** letters
- ▶ **numbers**
- ▶ **special** characters

We recommend re-using your Kerberos password as your encryption password.

Procedures



- ▶ Why
- ▶ Prerequisites
- ▶ Steps
- ▶ Order
- ▶ Result

English ▾
Multi-page HTML ▾

Managing systems using the Cockpit web interface

Preface

This is a beta version!

Providing feedback on Red Hat documentation

1. Getting started with Cockpit

- 1.1. Prerequisites
- 1.2. What is Cockpit?
- 1.3. Installing Cockpit
- 1.4. Logging in to Cockpit
- 1.5. Adding remote systems

2. Managing user accounts in Cockpit

- 2.1. Prerequisites
- 2.2. System user accounts managed in Cockpit
- 2.3. Adding new accounts in Cockpit
- 2.4. Enforcing password expiration in Cockpit

1. Log in to the **Cockpit** interface.
2. Click **Accounts**.
3. Click **Create New Account**.
4. In the **Full Name** field, enter the full name of the user.

Cockpit automatically suggests a user name from the full name and fills it in the **User Name** field. If you do not want to use the original naming convention consisting of the first letter of the first name and the whole surname, update the suggestion.

5. In the **Password/Confirm** fields, enter the password and retype it for verification that your password is correct. The color bar placed below the fields shows you security level of the entered password.

Create New Account

Full Name

User Name

Password

Confirm

Excellent password

Access Lock Account

6. Click **Create** to save the settings and close the dialog box.
7. Select the newly created account.

Feedback

Simplified English

Simplified English is a set of approved words and writing rules. Its makers made it to help engineers write manuals (instruction books) so that people all over the world can read them.

- ▶ Restricted grammar (simple present tense, imperative, active voice)
- ▶ Restricted vocabulary
- ▶ Reusing the same words again and again
- ▶ No fluff

Style guides

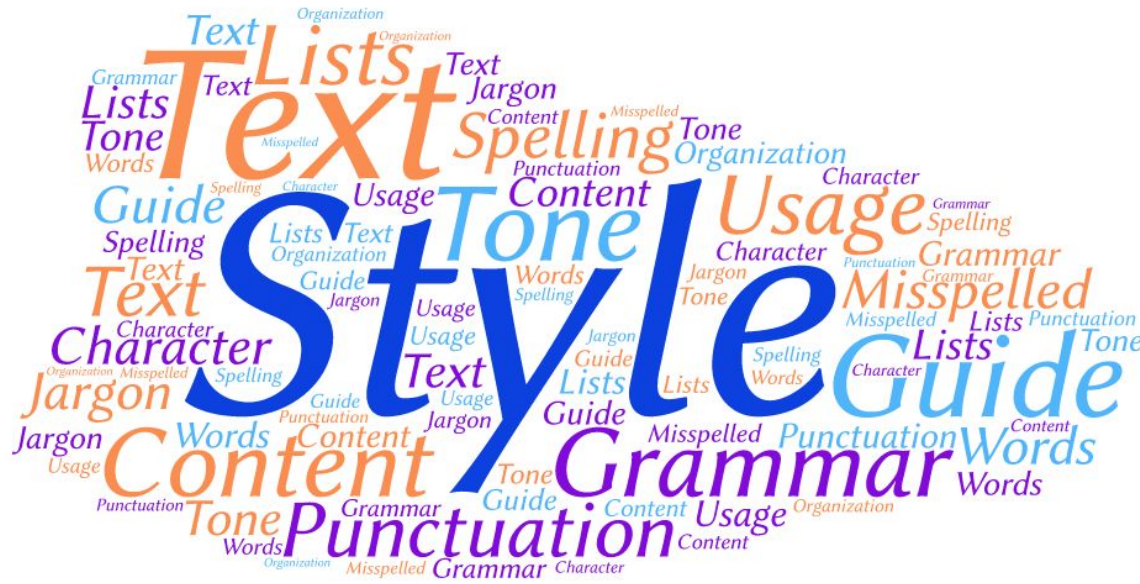

- Chicago Manual of Style
- IBM style guide
- Microsoft Manual of Style

Tenses

- ▶ Simple present tense (Subject+verb+object.)
 - Cockpit loads a certificate.
- ▶ Use imperative
 - Open the web interface.
 - Click **System**.
 - Select **Restart**.
- ▶ Use infinitive
 - To verify the previous configuration, open the web interface.

Remove fluff



- ▶ Adjectives
 - Small, huge, traditional, beautiful, gorgeous, ...
- ▶ Adverbs
 - Always, often, a lot, very, enough, ...
- ▶ Conjunctions
 - Because, although, since, unless, while, ...

Remove fluff

Connect **traditional** enterprise systems and **disruptive** technologies on a single platform with XYZ Cloud Integration. Create **personalized, differentiated** customer experiences, understand customers in context and meet their **evolving** needs. Recognize and react to market shifts as they happen and get a **holistic** view of your organization and the people in it.

EXERCISE 3: Remove fluff

The richness and variety in written texts offers benefits for language teaching/learning. This structure of texts lead to learning opportunities. Scientific texts play a role in educational settings. This study analyzes four different scientific texts. It uses descriptive pattern to determine the effectiveness of texts in foreign language teaching environments. The model for this analysis is based on scientific text analysis through text linguistic approach offered by Şenöz-Ayata(2004): the relatedness with the research field; the contribution of the study to scientific field; the introduction of the study (aim and method); the summary of the study;the research results; and assessment of the study. This sample analysis model is expected to be contributing to students" foreign language learning process,for candidate teachers while planning to conduct academic research and studies, for teachers of English while selecting and interpreting the content of the texts that they would use in their classes.

My (still voluminous) result

The study tries to show benefits of the richness and variety in texts in education base on four scientific texts:

The study uses the Şenöz-Ayata(2004) model for analysis:

- the relatedness with the research field;
- the contribution of the study to scientific field;
- the introduction of the study (aim and method);
- the summary of the study;
- the research results;
- and assessment of the study.

This sample analysis can help:

- to students" foreign language learning process,
- for candidate teachers while planning to conduct academic research and studies,
- for teachers of English while selecting and interpreting the content of the texts that they use in their classes.

EXERCISE 4: Rewrite a tooltip

Background: This tooltip is so large that you cannot see the original dialog box. The content of the tooltip is also not helpful. The tooltip is supposed to help the user pick a LUN (Logical Unit Number) type for computer storage. The tooltip is what you see when you click the question mark next to LUN type.

Purpose: Learn how to apply minimalism and UX writing principles to UI text.

Instructions: Make the text shorter and more informative.

Exercise time: 15 minutes

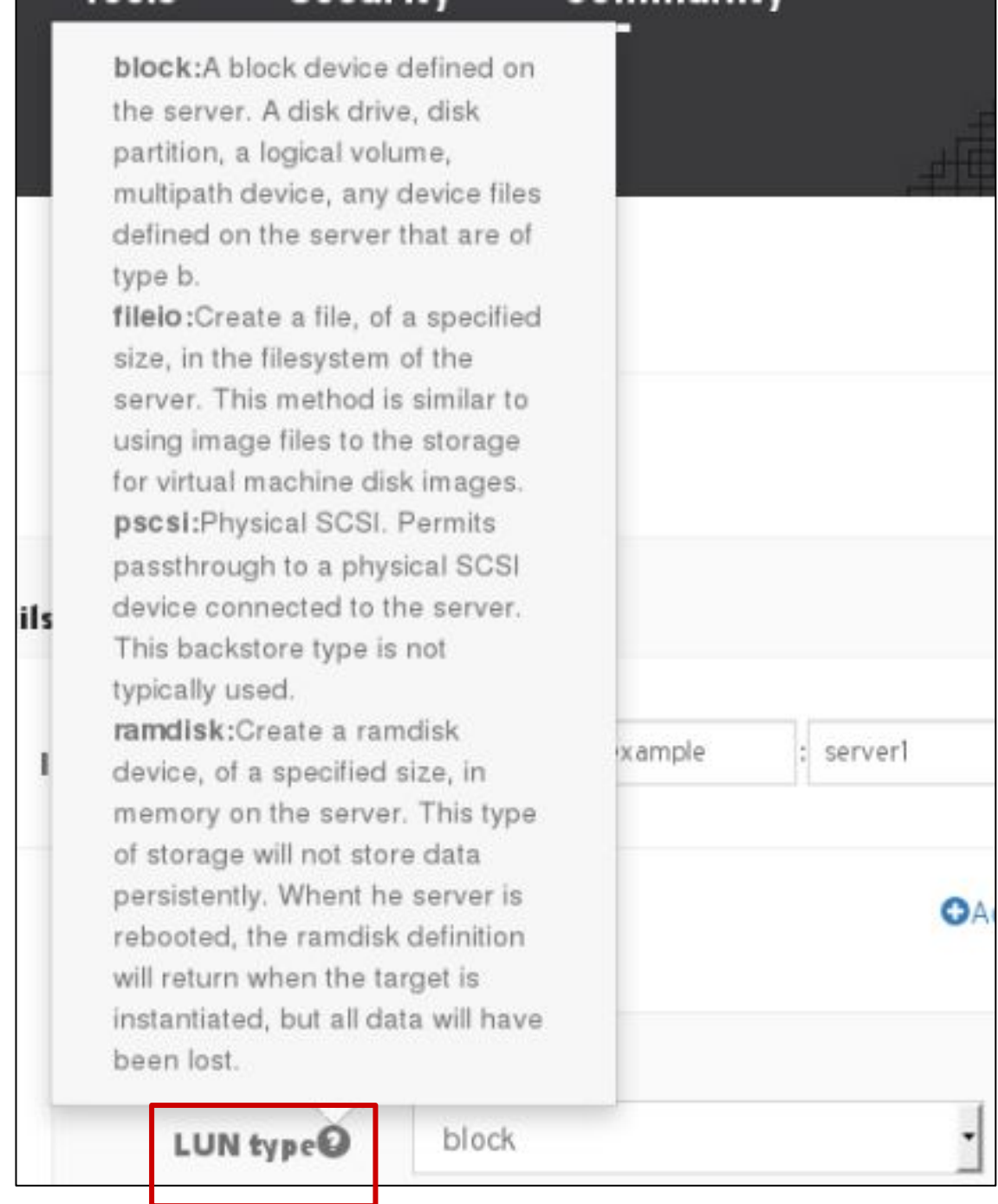

POSSIBLE SOLUTION:

block: Uses a disk drive, disk partition, logical volume, multipath device, or other device file on the server

fileio: Creates a file in the filesystem of the server

pscsi (physical SCSI): Permits passthrough to a physical SCSI device connected to the server

ramdisk: Creates a non-persistent ramdisk device on the server

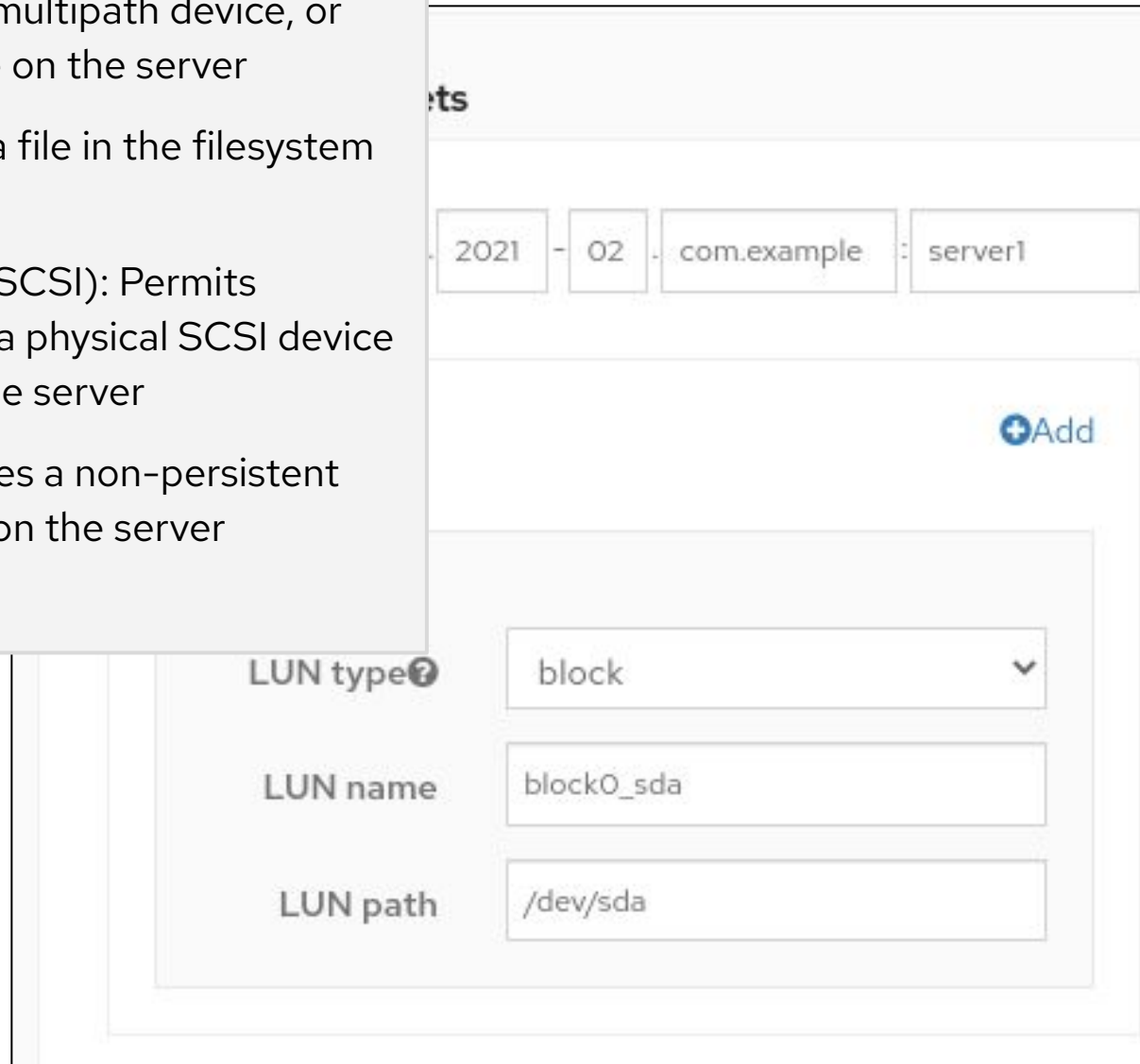

ts

2021 - 02 - com.example : server1

+Add

LUN type? block

LUN name block0_sda

LUN path /dev/sda

The industry look of technical writing

How has technical writing evolved over years

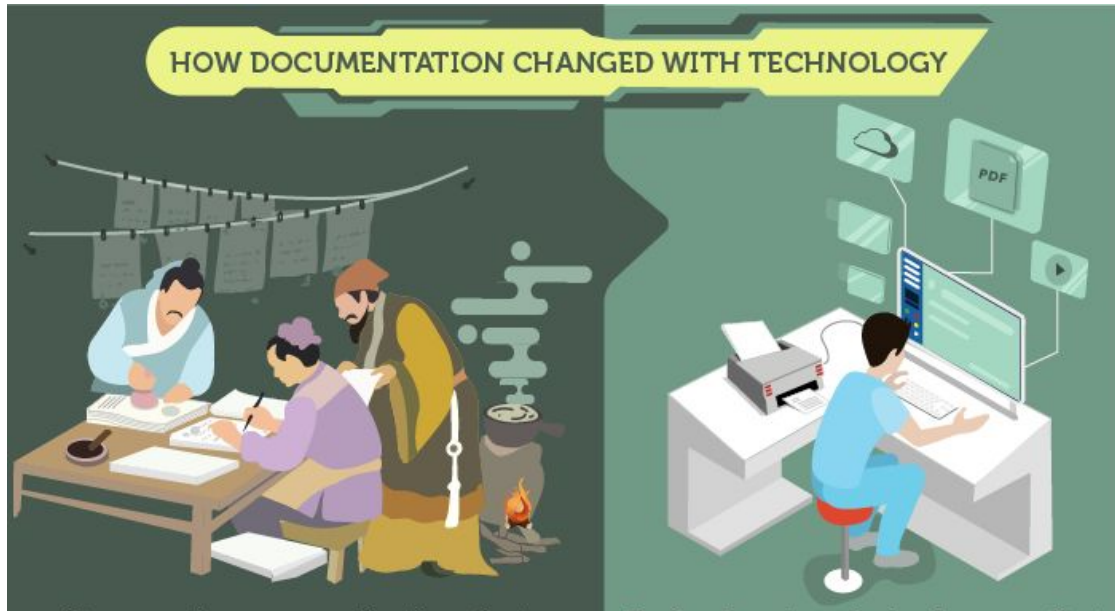

- Early involvement
- User stories
- Cross-functional coordination
- UX writing
- Scrum masters
- Tooling experts
- Content reuse
- User advocates
- Documentation Program Managers
- Content Strategists

How does a technical writer's day look like



- Meetings
- Planning
- Coordinating
- Learning
- Writing
- Improving
- Reviewing

What makes a good technical writer

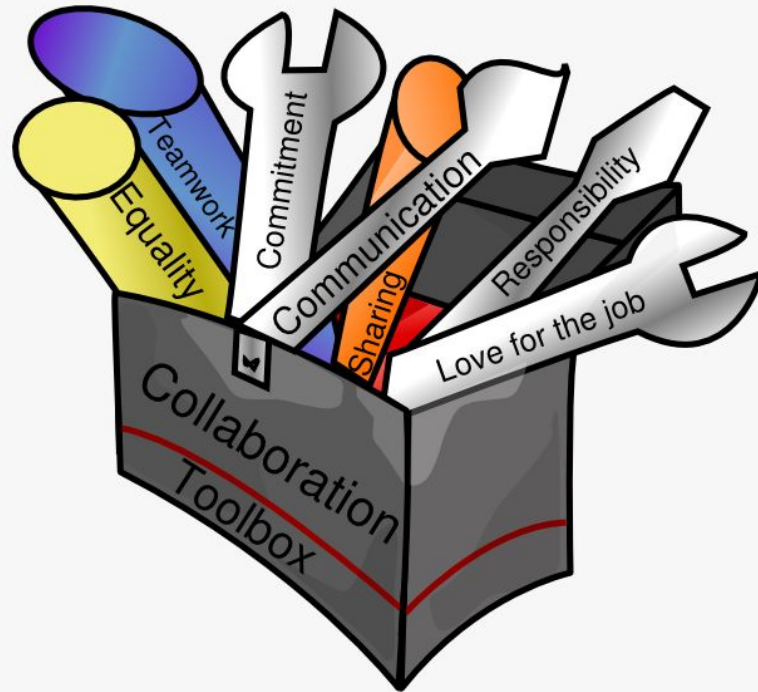

- Simple and concise writing
- Attention to detail
- User's perspective
- Continuous learning
- Collaboration

Technical writing – tools and languages



- DITA
- Markdown
- HTML
- Text Editor
- AsciiDoc
- DocBook

User - The content king



- User personas
- User workflow
- User's perspective
- User requirements
- User scenarios
- **User story**

Why is it required to have a user story



How to build a user story

- Users perspective of a software feature
- A series of conversations about a desired functionality
- Business and user value of a feature



As an Account Manager
I want a sales report of my account to be sent to my inbox daily
So that I can monitor the sales progress of my customer portfolio

- Acceptance criteria:**
1. The report is sent daily to my inbox
 2. The report contains the following sales details: ...
 3. The report is in csv format.

Life with and without a user story

Document Puppet solution

Document Host detail changes

Document Convert2RHEL details

Load balanced content with Capsules with sticky sessions

Support Nutanix AHV in Satellite

Provisioning improvements

- As a Satellite user, I would like to use Puppet to manage configurations, so that I can X, Y, Z
 - As a Satellite new user, I would like to know the prerequisites for Puppet integration, so that I can accordingly prepare my setup
 - As a Satellite new user, I would like to know how Puppet can integrate with Satellite, so that I understand the underlying concepts and workflow
 - As a Satellite existing user, I would like to know the support changes to the Puppet versions, so that I can accordingly update my setup
 - As a Satellite existing user, I would like to know the changes to the deployment workflow, so that I can follow the new workflow when I upgrade my Satellite version

How does a user story help content creation

- Addresses user requirements...Ensures we cover all use cases
- Structures content....Concepts | Procedure | Reference
- Enables content reuse
- Enables information flow
- Sets language tone

EXERCISE 5: User story

Online maps and navigation – try to think of as many user stories as possible:



EXERCISE 6: Tea story again

- ▶ Describe the process of making 1 cup of loose-leaf tea
- ▶ Find various user stories
- ▶ Apply what you have learned so far



Technical writing at Red Hat

Our documentation team

Red Hat Enterprise Linux



- ▶ RHEL is our flagship
- ▶ 1 complex product -> 21 subsystems
- ▶ More than 30 writers
- ▶ Always 2-4 interns
- ▶ 8-10 managers

What people think I do, when I tell them that I am a technical writer:



What I actually do:

whoami

```

1 = Hello, AsciiDoc!
2 Doc Writer <doc@example.com>
3
4 An introduction to http://
5 asciidoc.org[AsciiDoc].
6
7 == First Section
8
9 * item 1
10 * item 2
11
12 [subs="quotes"]
13 ====
14 $ *echo "Hello, AsciiDoc!"*
15 Hello AsciiDoc!
16 ====

```

Hello, AsciiDoc!

An introduction to [AsciiDoc](#).

Table of Contents

First Section

First Section

- item 1
- item 2

```
$ echo "Hello, AsciiDoc!" Hello AsciiDoc!
```

```

[sjanderk@sjanderk ~]$ whoami
sjanderk
[sjanderk@sjanderk ~]$ who killed kennedy
[sjanderk@sjanderk ~]$ who
sjanderk :1          2022-04-19 20:46 (:1)
[sjanderk@sjanderk ~]$ who is the best woman in tech
who: extra operand 'best'
Try 'who --help' for more information.
[sjanderk@sjanderk ~]$ who --help
Usage: who [OPTION]... [ FILE | ARG1 ARG2 ]
Print information about users who are currently logged in.

```



Welcome to Red Hat Bugzilla

Thank you for visiting Red Hat Bugzilla. Red Hat Bugzilla is the Red Hat bug-tracking system and is used to submit and review defects that have been found in Red Hat distributions. Red Hat Bugzilla is not an avenue for technical assistance or support, but simply a bug tracking system. If you submit a defect, please provide detailed information in your submission after you have queried Red Hat Bugzilla to ensure the defect has not been reported yet. Defects will go directly to the engineer responsible for the component you filed the defect against. Engineers have many responsibilities and will get to your defect in due time.

If you are a Red Hat customer with an active subscription, please visit the [Red Hat Customer Portal](#) for assistance with your issue.
If you are a Fedora Project user and require assistance, please consider using one of the [mailing lists](#) we host for the Fedora Project.

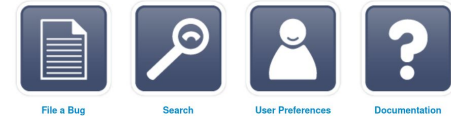

Enter a bug # or some search terms Quick Search [?]

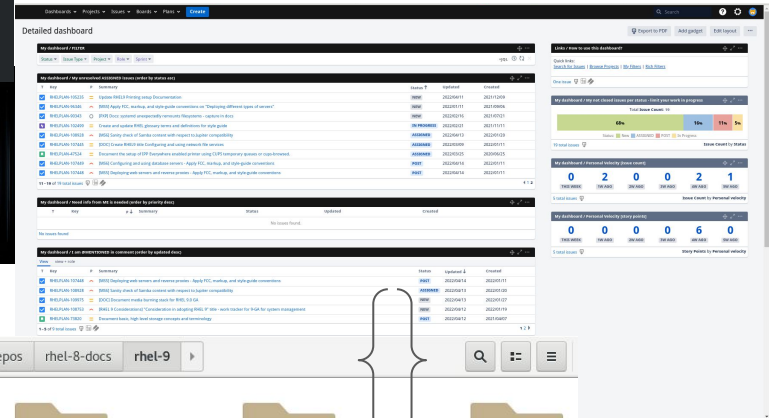

I write to make people's lives simple.

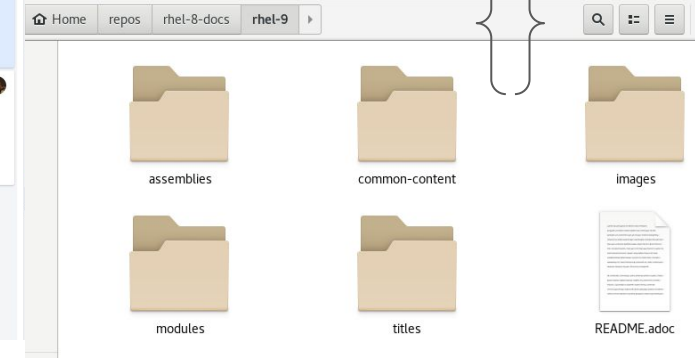
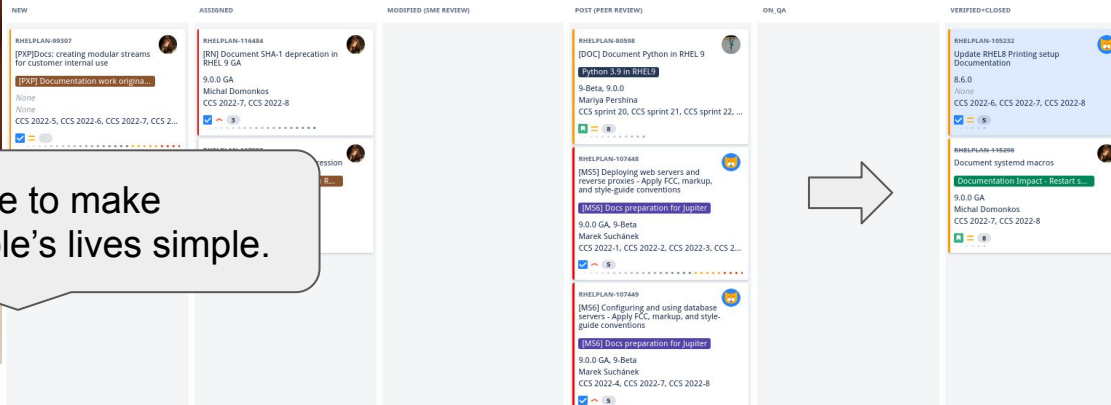

I work on this



Documentation

- ▶ Release notes
- ▶ Considerations
 - ▶ User guide
- ...
- ▶ Knowledgebase articles
- ▶ Internal and administrative guides

using this

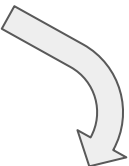

Software we use

- ▶ Fedora, RHEL, MacOS
- ▶ Editor of your choice (Atom, Vim, Emacs...)
- ▶ AsciiDoctor
- ▶ Gitlab, Github
- ▶ Gimp

How is documentation authored in Red Hat

Installing

Upgrading to RHEL 8

Instructions for an in-place upgrade to Red Hat Enterprise Linux 8

Performing a standard RHEL installation

Installing Red Hat Enterprise Linux 8 using the graphical user interface

Composing a customized RHEL system image

Creating customized system images with Image Builder on Red Hat Enterprise Linux 8

Performing an advanced RHEL installation

Installing Red Hat Enterprise Linux 8 using Kickstart

[Installing, managing, and removing user space components](#)

Name	Last
...	
assemblies	spl
images	RH
meta	Me
modules	spl

```

1 = Hello, AsciiDoc!
2 Doc Writer <doc@example.com>
3
4 An introduction to http://
+ asciidoc.org[AsciiDoc].
5
6 == First Section
7
8 * item 1
9 * item 2
10
11 [subs="quotes"]
12 ====
13 $ *echo "Hello, AsciiDoc!"*
14 Hello AsciiDoc!
15 =====

```

Hello, AsciiDoc!

An introduction to [AsciiDoc](#).

Table of Contents

First Section

First Section

- item 1
- item 2

\$ echo "Hello, AsciiDoc!" Hello AsciiDoc!

Documentation based on user stories

37 titles carefully crafted for discoverability, each written based on a user story with a specific target audience in mind.

Single git repository

A single git repository written in a modular fashion. Modules are stored separately from assemblies and titles and many are reused.

Written in AsciiDoc

All documentation is written in AsciiDoc, which is easy to understand and edit even without studying it. We receive many more patches from subject matter experts.

Assemblies and modules

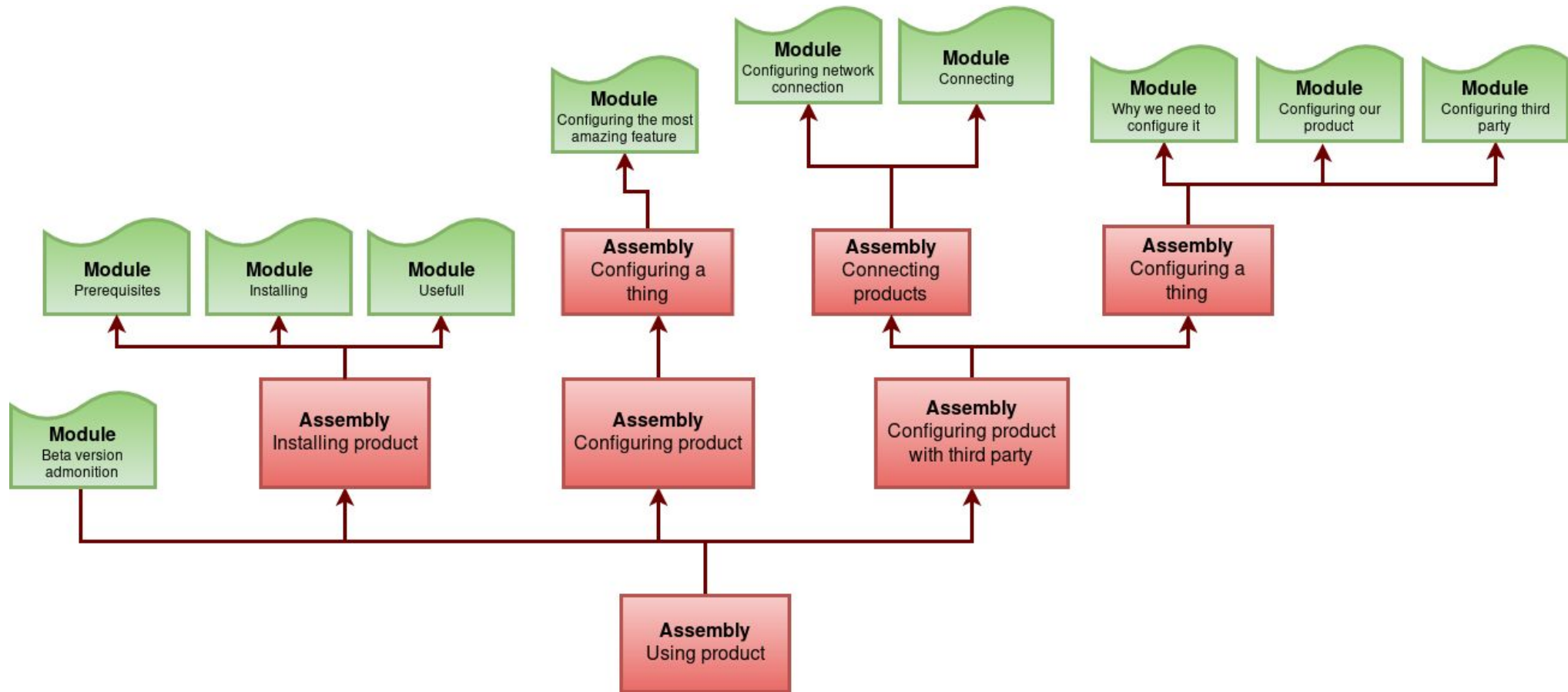

We welcome direct feedback

5.1. Troubleshooting resources

Console output

By default, only error and critical log level messages are the **Leapp** utility. To change the log level, use the `--verbose` `leapp upgrade` command.

- In `verbose` mode, **Leapp** prints info, warning, error

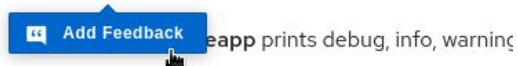

Logs

- The `/var/log/leapp/dnf-debugdata/` directory
This directory is present only if **Leapp** is executed

We use Direct Documentation Feedback

This feature is available to all subscribed customers for all RHEL 8 titles **one the multi-page view**. You need to **log in to the Customer Portal** to see this feature.

[Release notes RHEL 8.6 beta](#)

How it works

Highlight text and click **Add Feedback** to add your own, or click **Feedback** in the top right corner to view existing comments.

Where does the feedback go

Every comment creates a bug for the documentation team.

https://bugzilla.redhat.com/show_bug.cgi?id=2073397

The writer workflow



- ▶ Research
 - What should be documented?
 - Do your homework!
- ▶ Draft
- ▶ Technical review
- ▶ Peer review
- ▶ Publication

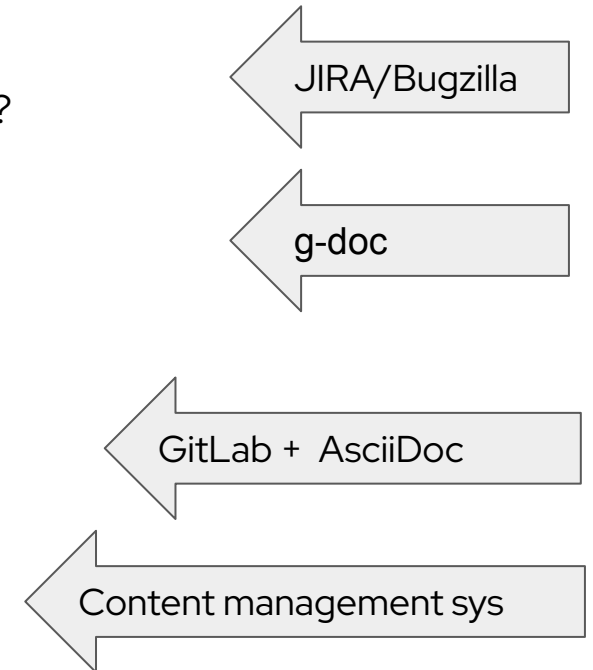



Golden rule

EXAMPLE: Release note

► Research

Please clarify whether "hidepid" is still supported as proc mount option

-> **BZ**

```

Description of problem:
Some customers used "hidepid=2,gid=xxx" in the past (up to RHEL7) to hide processes from other users.
With RHEL8, when setting such option, we can see sys_ptrace and signull AVCs, which seem to prevent normal operations to complete, e.g.
-----
type=PROCTITLE msg=audit(10/18/2022 15:35:30.024:31) : proctitle=/usr/sbin/NetworkManager --no-daemon
type=SYSCALL msg=audit(10/18/2022 15:35:30.024:31) : arch=x86_64 syscall=kill success=no exit=-EACCESS(Permission denied) a0=0x0 a1=5T0 a2=0x0 a3=0x0 itres=0 ppid=1 pid=1148 auid=unset uid=root gid=root
enforcer=audit suid=root fsuid=root egid=root sgid=root fsgid=root tty=(none) ses=unset comm=NetworkManager exe=/usr/sbin/NetworkManager subj=system_u:system_r:NetworkManager_t:s0 key=(null)
type=AVC msg=audit(10/18/2022 15:35:30.024:31) : avc: denied { signull } for pid=1148 comm=NetworkManager scontext=system_u:system_r:NetworkManager_t:s0 tcontext=system_u:system_r:unconfined_service_t:s0
tclass=process permissive=0
-----

Here above NetworkManager tries to "ping" NetworkManager-wait-online process
and
-----
type=PROCTITLE msg=audit(10/18/2022 15:35:32.658:40) : proctitle=/usr/libexec/sss/sss --uid 0 --gid 0 --logger=files
type=SYSCALL msg=audit(10/18/2022 15:35:32.658:40) : arch=x86_64 syscall=openat success=no exit=-ENOENT(No such file or directory) a0=0xffffffff a1=0x7ff06a54020 a2=0 RDONLY a3=0x0 itres=0 ppid=1133 pid=1213
auid=unset uid=root gid=root fsuid=root sgid=root fsgid=root tty=(none) ses=unset comm=sss exe=/usr/libexec/sss/sss subj=system_u:system_r:sss_t:s0 key=(null)
type=AVC msg=audit(10/18/2022 15:35:32.658:40) : avc: denied { sys_ptrace } for pid=1213 comm=sss capability=sys_ptrace scontext=system_u:system_r:sss_t:s0 tcontext=system_u:system_r:unconfined_service_t:s0
tclass=capability permissive=0
-----

Here above "sss_oss" tries to open /proc/XXX/cwd/line to verify the command line, which is typically used to verify who connects to the sssd Unix socket: this happens for "systemd"
sss query.

The mount(8) manpage on RHEL8 doesn't list the option. The manpage on RHEL7 was only listing "gid=xxx" option and was stating "I don't know which effect it has" ...

Please clarify whether "hidepid" is still supported as proc mount option.
Version-Release number of selected component (if applicable):
kernel-4.18.0-348.7.1.el8_5.x86_64 and below

How reproducible:
Always

Steps to Reproduce:
1. Set options in /etc/fstab
proc /proc proc rw,nosuid,nodev,noexec,relatime,hidepid=2,gid=1148 0 0

2. Enable sssd
# yum -y install sssd
# authselect select sssd

3. Reboot and log in as some user

Actual results:
AVCs

Expected results:

Additional info:

```

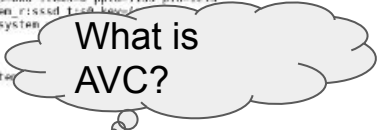

Some customers used "hidepid=2,gid=xxx" in the past (up to RHEL7) to hide processes from other users. With RHEL8, when setting such option, we can see sys_ptrace and signull AVCs, which seem to prevent normal operations to complete.

Version-Release number of selected component (if applicable):
kernel-4.18.0-348.7.1.el8_5.x86_64 and below

The mount(8) manpage on RHEL8 doesn't list the option. The manpage on RHEL7 was only listing "gid=xxx" option and was stating "I don't know which effect it has"

Please clarify whether "hidepid" is still supported as proc mount option

Can Kernel just confirm this kind of hardening is still valid nowadays?

→ redirecting the issue to systemd (what is systemd)

The "hidepid" options does not seem to be covered thus far in the product docs at https://access.redhat.com/documentation/en-us/red_hat_enterprise_linux/8

EXAMPLE: Release note

▶ Draft

.The `hidepid=n` mount option is not supported in RHEL 8 `systemd`

The mount option `hidepid=n`, which controls who can access information in `/proc/[pid]` directories, is not compatible with `systemd` provided in RHEL 8. As a consequence, using this option might cause SELinux AVC denial messages that prevent other operations from completing.

▶ Technical review

.The `hidepid=n` mount option is not supported in RHEL 8 `systemd`

The mount option `hidepid=n`, which controls who can access information in `/proc/[pid]` directories, is not compatible with `systemd` infrastructure provided in RHEL 8.

As a consequence, using this option might cause some services started by `systemd` to produce SELinux AVC denial messages and prevent operations from completing.

For more information, see [link:XXX\[Knowledgebase-article\]](#)

▶ Peer review

.The `hidepid=n` mount option is not supported in RHEL 8 `systemd`

The mount option `hidepid=n`, which controls who can access information in `/proc/[pid]` directories, is not compatible with `systemd` infrastructure provided in RHEL 8.

In addition, using this option might cause some services started by `systemd` to produce SELinux AVC denial messages and prevent operations from completing.

For more information, see [the related link:XXX\[Knowledgebase-article\]](#)

▶ Publish

Resources



▶ Technical writing

- <https://www.technical-communication.org/>
- <https://www.stc.org/about-stc/defining-technical-communication/>

▶ AsciiDoc

- <https://asciidoc.org/>

▶ Minimalism

- [https://en.wikipedia.org/wiki/Minimalism_\(technical_communication\)](https://en.wikipedia.org/wiki/Minimalism_(technical_communication))

▶ Simplified English

- https://simple.wikipedia.org/wiki/Simplified_English

Do you have
what takes to
be a writer?

If you'd like to know, try our **self-test!**

<https://forms.gle/UhACyc8UUy963pWv5>

OR



Want to contribute to open source documentation projects?

- ▶ Google open source project
 - <https://developers.google.com/season-of-docs>
- ▶ Write the Docs
 - <https://www.writethedocs.org/>
- ▶ Open source contribution
 - <https://opensource.com/article/20/1/write-for-us>
 -

We are hiring

- ▶ Contact: Vendula Ferschmannova (vferschm@redhat.com)
- ▶ Openings at RH: <https://www.redhat.com/en/jobs>
- ▶ Internship program
 - Twice a year
 - 15-20 hrs/week
 - 1-2 years

Thank you

Red Hat is the world's leading provider of enterprise open source software solutions. Award-winning support, training, and consulting services make Red Hat a trusted adviser to the Fortune 500.

 [linkedin.com/company/red-hat](https://www.linkedin.com/company/red-hat)

 [youtube.com/user/RedHatVideos](https://www.youtube.com/user/RedHatVideos)

 [facebook.com/redhatinc](https://www.facebook.com/redhatinc)

 twitter.com/RedHat