



Red Hat

CAN'T WE JUST AGREE?

ONDŘEJ CHALOUPKA, VOJTĚCH JURÁNEK

FI MUNI 14. 11. 2019

WHO WE ARE



WORKING AS ENGINEERS AT RED HAT



DISTRIBUTED SYSTEMS ENTHUSIASTS



MEET US AT BRNO DISTRIBUTED SYSTEMS MEET-UP

<https://www.meetup.com/Brno-Distributed-Systems-Meetup-Group>

WHAT IS THIS TALK ABOUT



A BRIEF OVERVIEW OF CONSENSUS ALGORITHMS
IN DISTRIBUTED LEDGER SYSTEMS



WHY CONSENSUS ALGORITHM IS AN ESSENTIAL PART
IN DISTRIBUTED LEDGER SYSTEMS



HOW THE CHOICE OF CONSENSUS ALGORITHM IMPACTS
CAPABILITIES OF DISTRIBUTED SYSTEM

AGENDA



MOTIVATION FOR CONSENSUS IN DISTRIBUTED LEDGER SYSTEM



NON-BYZANTINE FAULT TOLERANT CONSENSUS FOR BLOCKCHAIN



BYZANTINE FAULT TOLERANT CONSENSUS FOR BLOCKCHAIN



BITCOIN CONSENSUS



CONSENSUS ALGORITHMS ON TOP OF DIRECTED ACYCLIC GRAPHS (DAG)

TRANSFER OF THE MONEY

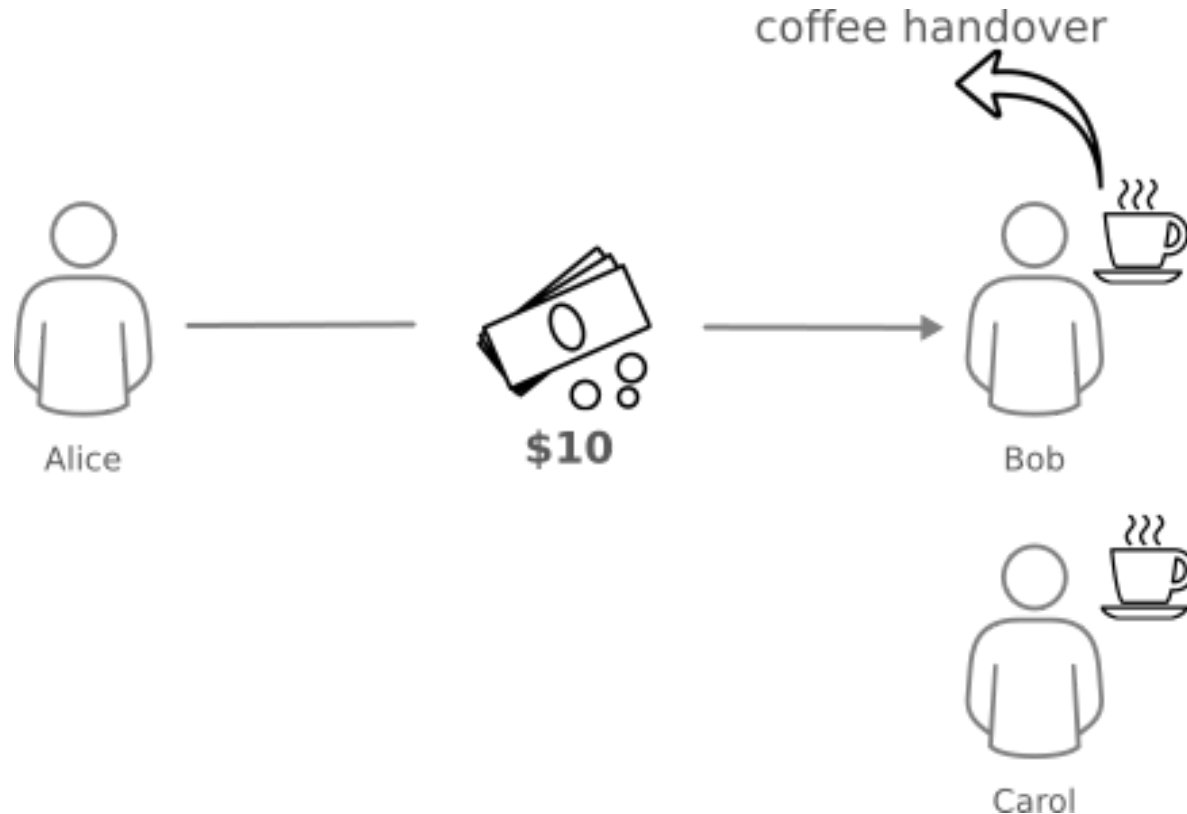

Beware: distributed ledgers are not limited only to cryptocurrencies, there are lots of other applications!

CENTRAL AUTHORITY

Initial state

ACCOUNT	BALANCE
Alice	\$10
Bob	\$0
Carol	\$0

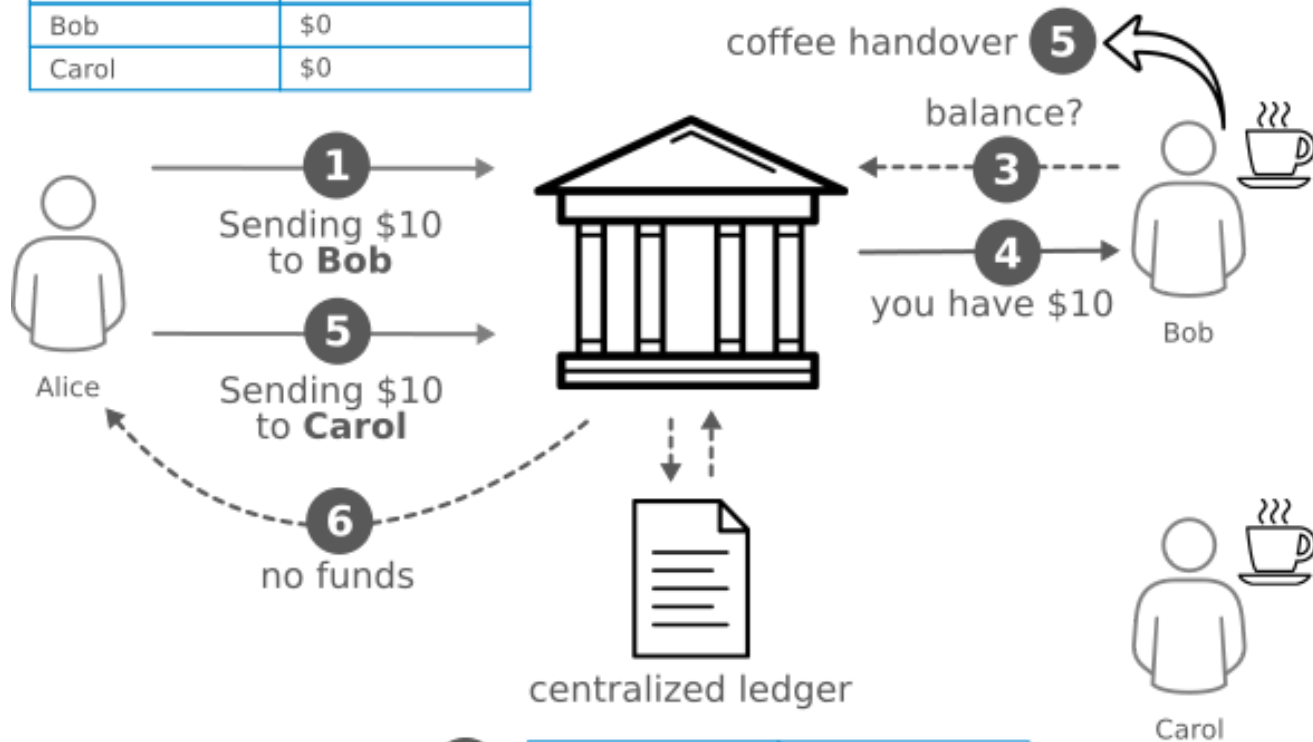

2

ACCOUNT	BALANCE
Alice	\$0
Bob	\$10
Carol	\$0

DOUBLE SPEND PROBLEM

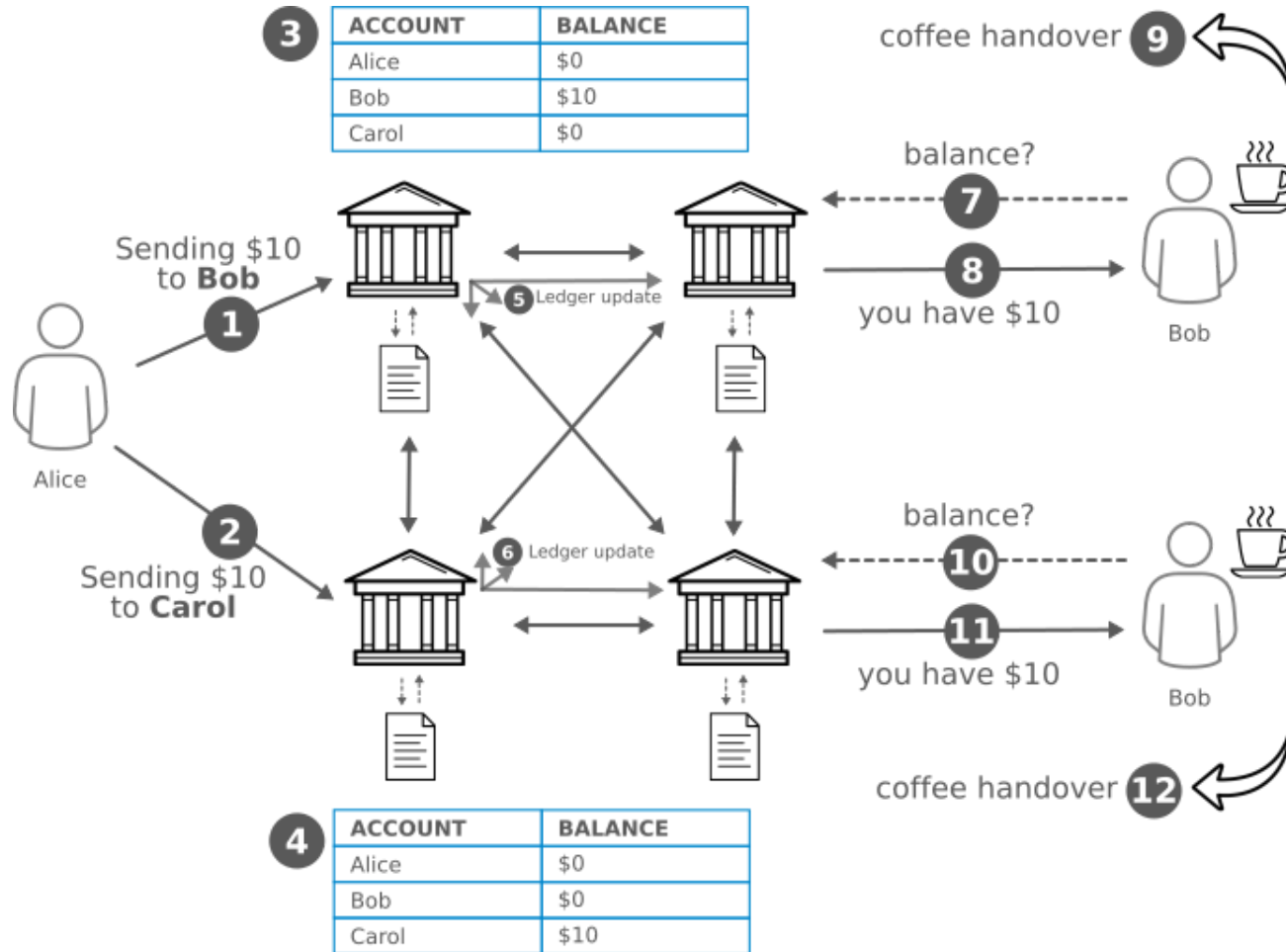

In distributed systems, we need agreement between participants, which transaction is valid.

CONSENSUS

- Agreement between nodes on something, e.g. some value
- Another example: whether to commit a (distributed) transaction to a database
- Hard, network is unreliable
 - delays or failures in communication
- Consensus has to have two properties: **safety** and **liveness**

CONSENSUS



Emin Gün Sirer ✓

@el33th4xor

Follow



Ok, there is a terribly wrong framework emerging around consensus protocols. People think that PoW and PoS are consensus protocols, and that they are the only two consensus protocols out there.

This is false. Let me explain.

9:09 AM - 13 Jun 2018

<https://twitter.com/el33th4xor/status/1006931658338177024>

NON-BYZANTINE FAULT TOLERANT CONSENSUS

- can withstand failures but not a cheating participant
- trust in all involved parties
- protocols like Paxos (Google Spanner), Raft (etcd), Zab (Zookeeper)
 - consensus is affirmed when majority of nodes agrees
 - withstand crashes or connection issues

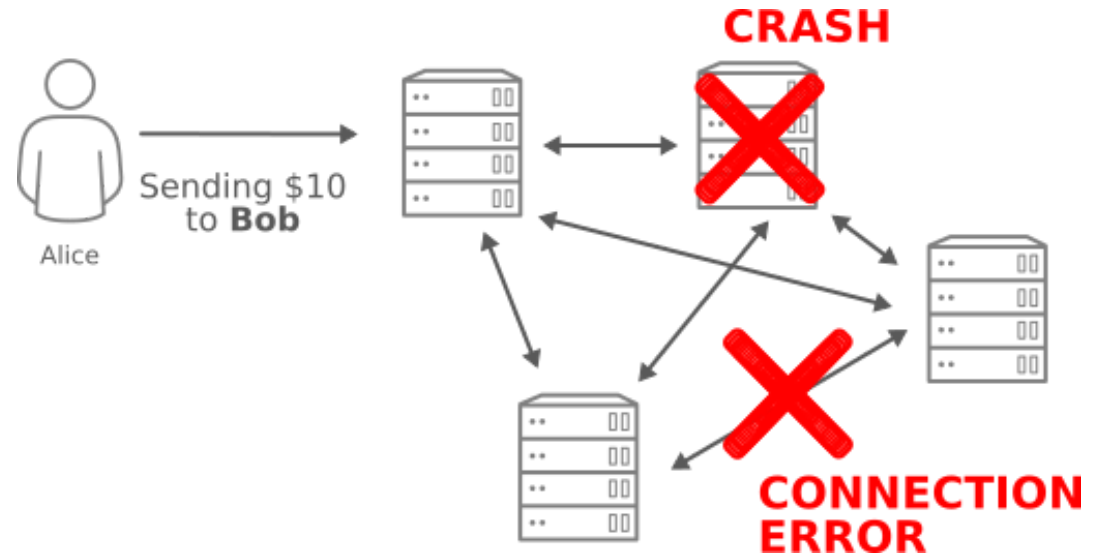

RAFT ALGORITHM

<https://raft.github.io/#raftscope>

PRIVATE BLOCKCHAINS

- all nodes are under control of a **single organization**
- number of participant is small, they know about each other and **trust each** other
 - Raft in Hyperledger (Sawtooth, Fabric)
- **Permissioned** : nodes needs some permission to join the network
- **Permissionless** : nodes can join the network without any permission (public blockchains)

NON-BYZANTINE CONSENS.

SUMMARY

- usually used in distributed database systems
- trust in all involved parties
- used in private permissioned blockchains

BYZANTINE FAILURE

- besides delays and failures in communication over network, the situation can be even worse - there can be malicious participants!
- a byzantine failure is any fault presenting different symptoms to different observers.
 - e.g. attempt to double spend money.

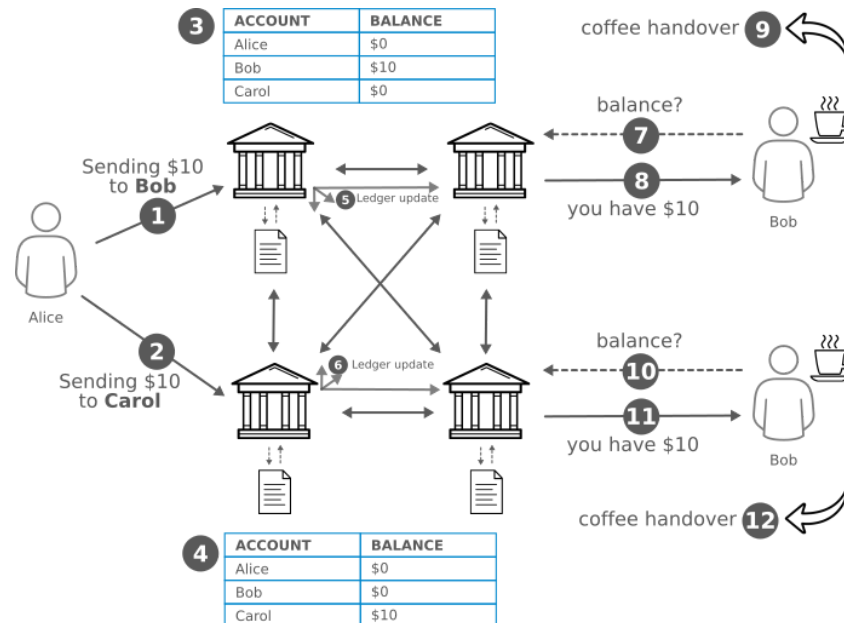

BFT ALGORITHMS

BYZANTINE FAULT TOLERANT

- PBFT, Tendermint, Stellar ...
- Agreement can be imaged like a three-phase commit (propose a value, pre-prepare commit, prepare, commit).

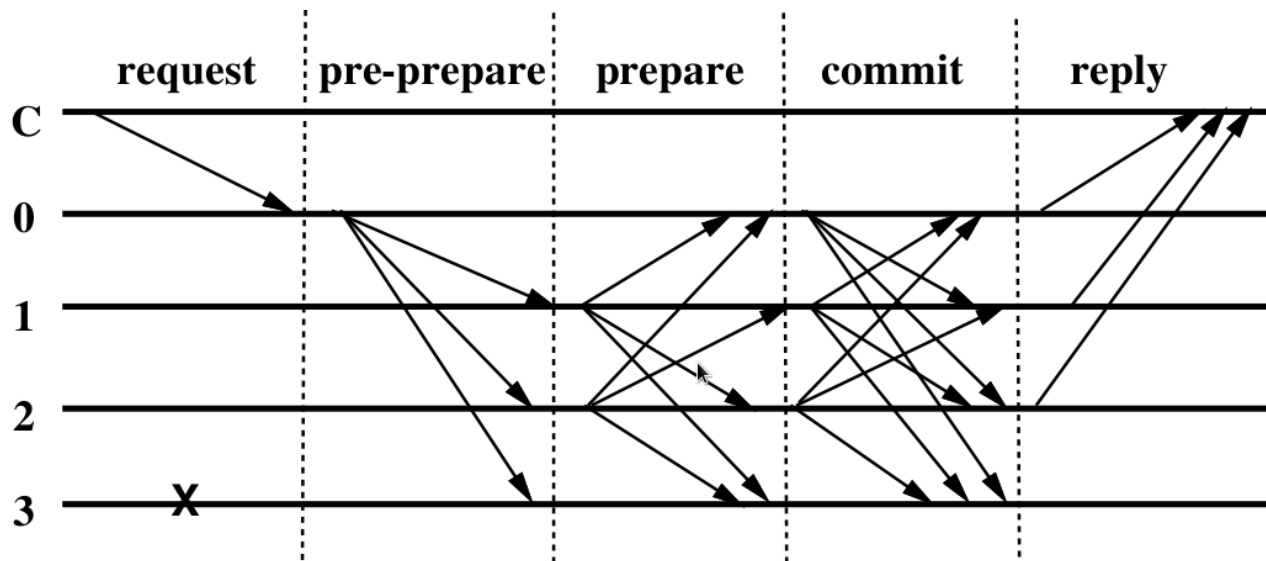

FEDERATED DISTRIBUTED LEDGERS

- Still to some extent centralized.
- Usually to some extent permissioned or have to be combined e.g. with PoS (Tendermint).

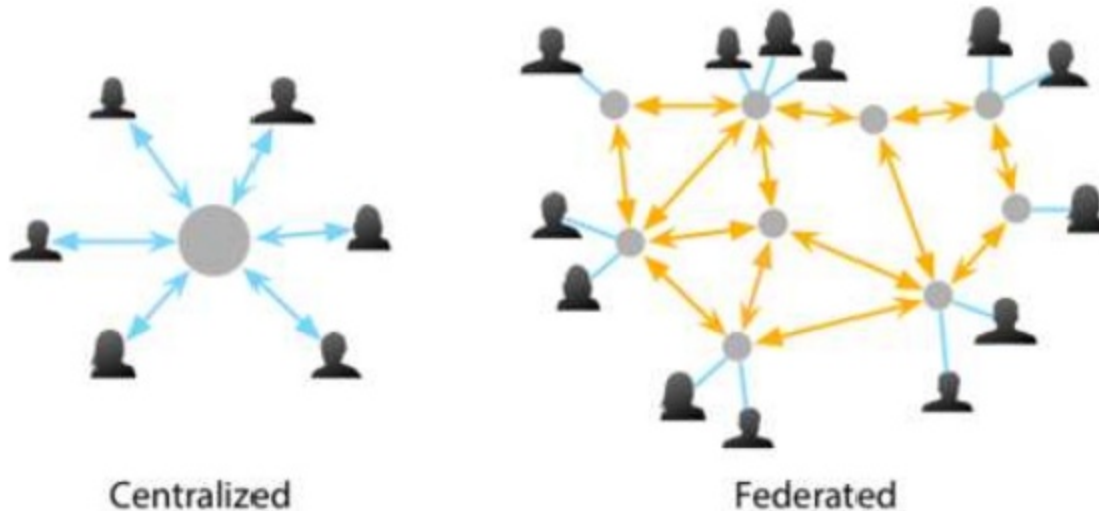

BYZANTINE CONSENSUS

SUMMARY

- usually slow
 - a lot of messages exchanged
- parties don't (fully) trust each other
- usually used in semi-public and public blockchains

PUBLIC BLOCKCHAINS

- any party may connect
 - nobody trusts nobody
- some new challenges evolve

SIBYLS ATTACK

- Forging the identity to subvert the result

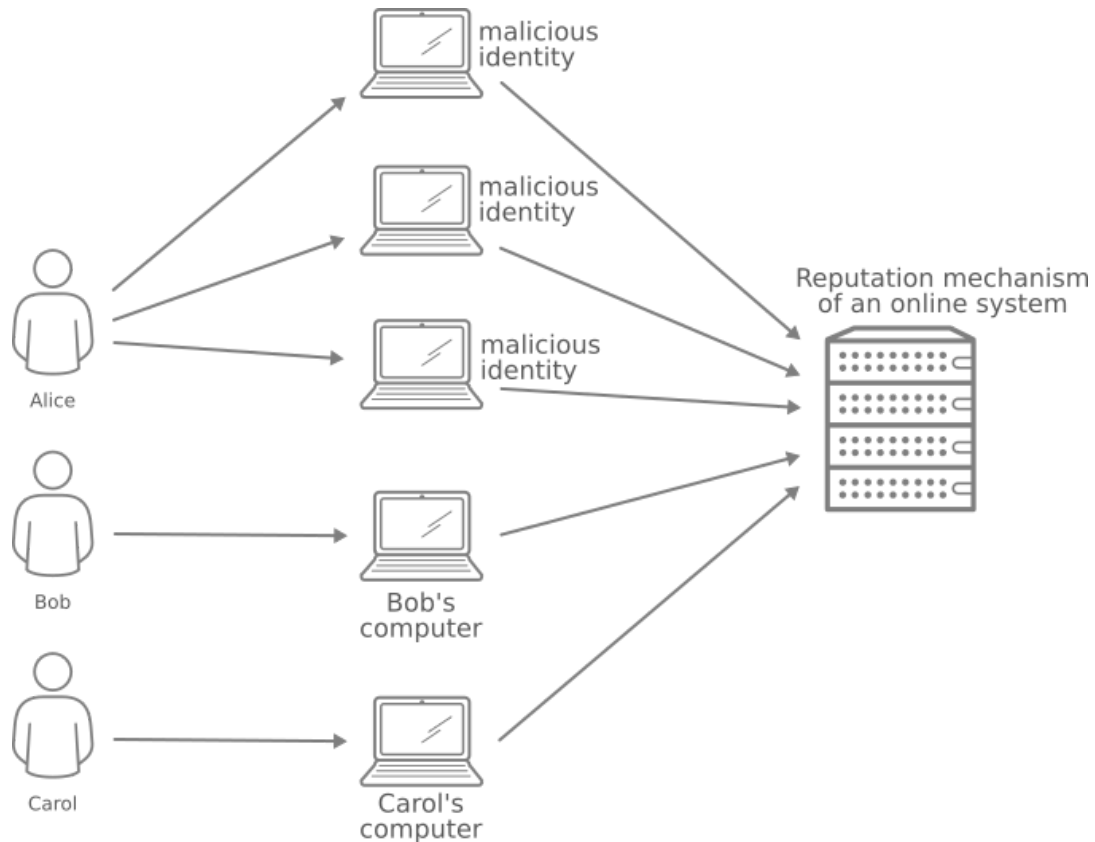

PROOF-OF-WORK

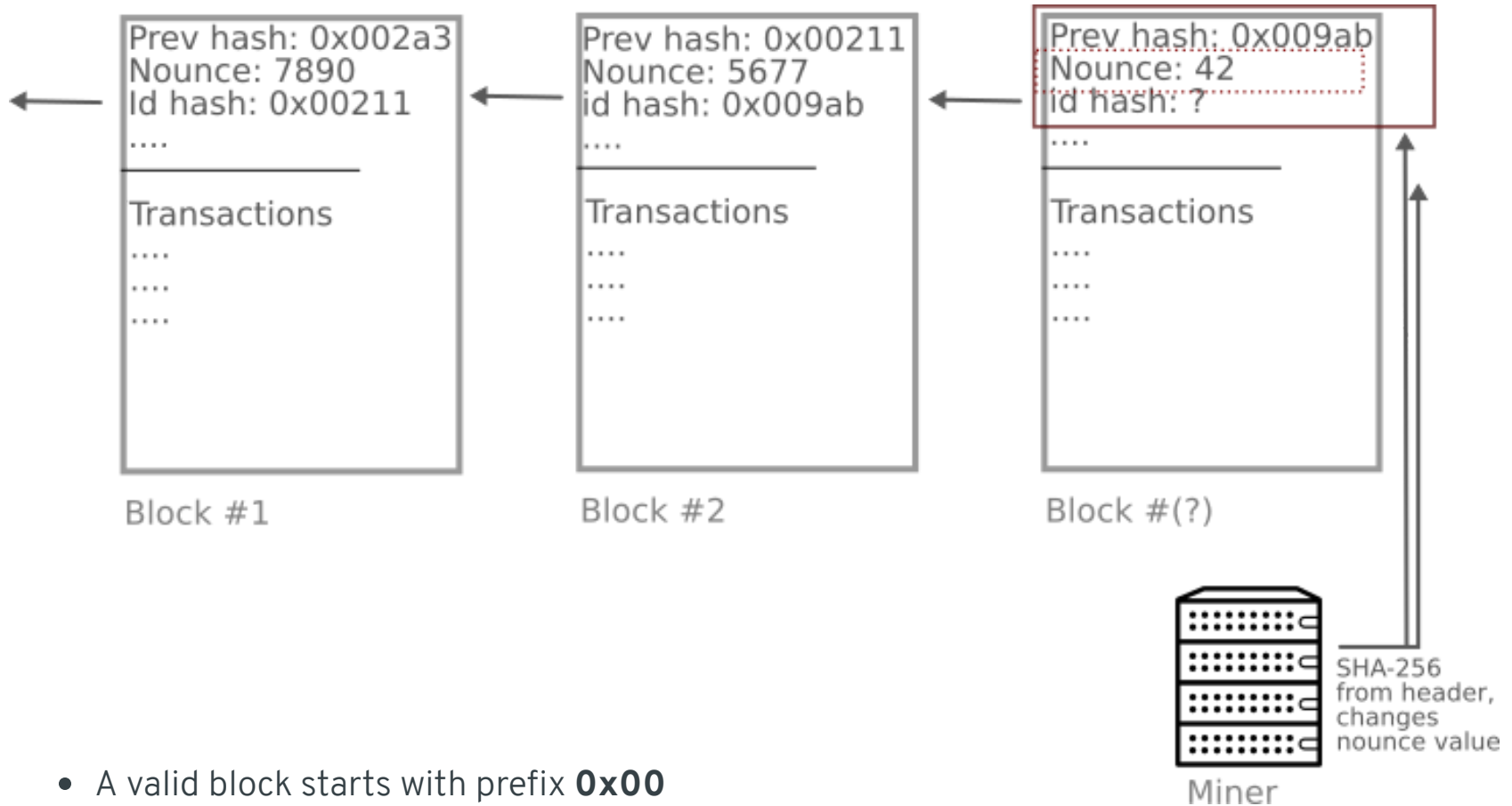

BLOCKCHAIN FORK

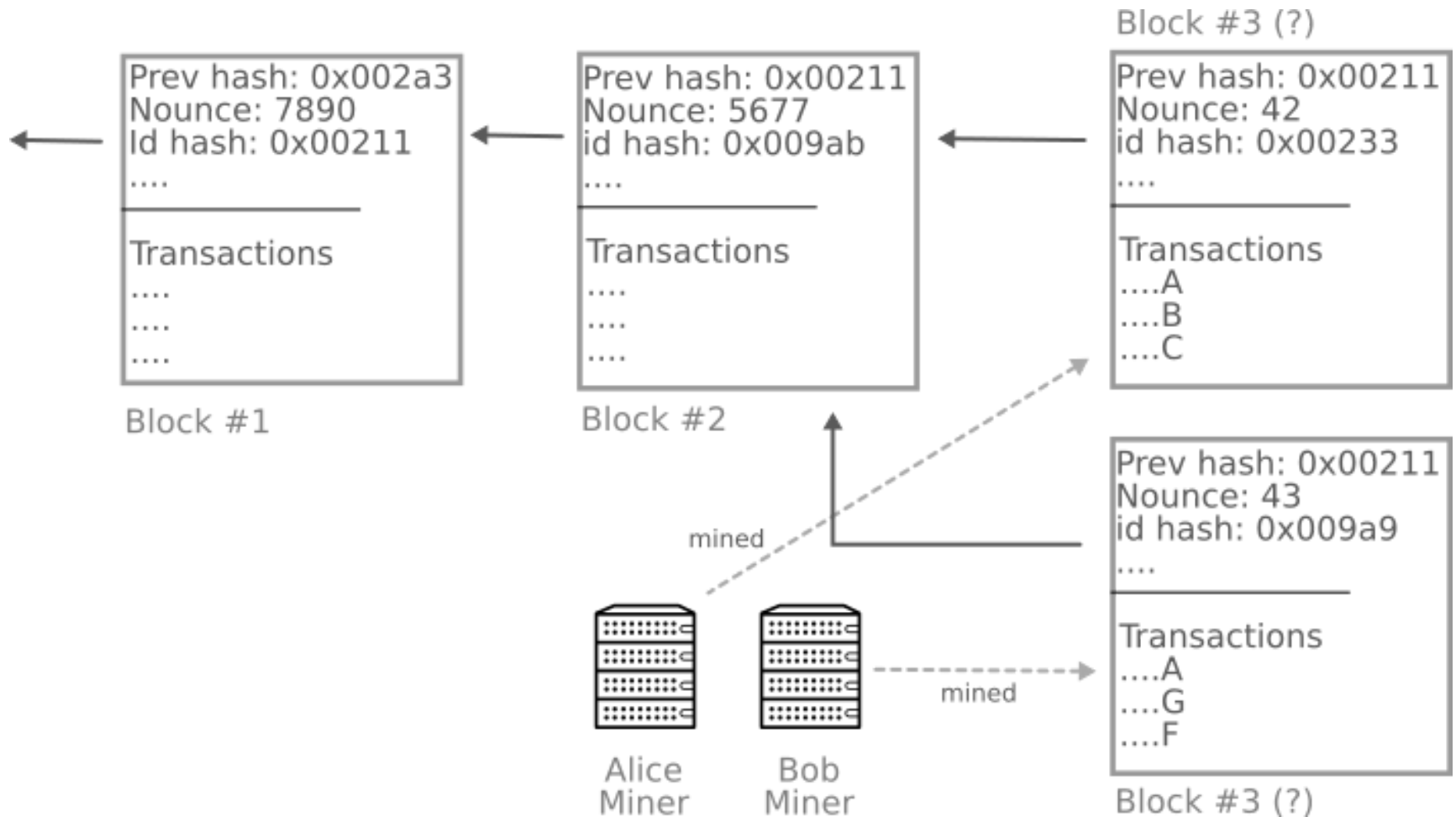

BLOCKCHAIN FORK

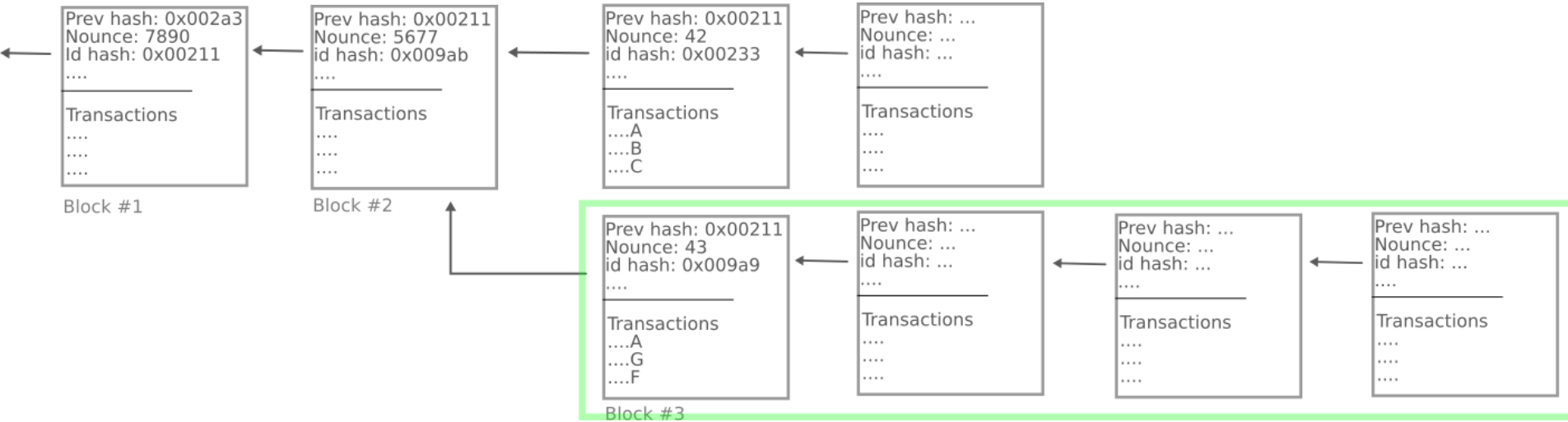

NAKAMOTO CONSENSUS

- Bitcoin is (almost) **Byzantine fault tolerant (BFT)** and also resistant to **Sybil** attack
- Proof-of-Work (PoW) is mechanism how to prevents Sybil attacks
- The truth (agreement) is determined by the longest chain (created by Proof-of-Work) usually called **Nakamoto consensus algorithm**
- **Probabilistic**: probability of consensus is less than 1
- Proof-of-Work finding a new block is stable to 10 minutes
 - Bitcoin network is essentially **synchronous**

BITCOIN CONSENSUS

SUMMARY

- proof-of-work solves sibyls attack + leader election
- consensus is nakamoto consensus which adds "a static rule" on top of PoW and declares that the right chain is the longest chain

WHAT ABOUT POS

PROOF-OF-STAKE

- Proof-of-Stake (PoS) is per se **not a consensus** algorithm
- Proof-of-Stake **solves Sybil** attack
- **Two major types**
 - **Chain-based**
 - **PBFT-style**
- Consensus algorithm is completed with additional flavor
 - as a separate rule of the longest chain wins (chain-based)
 - as a consensus running among all validator to determine the final valid block (PBFT)

CONSENSUS ALGORITHMS ON TOP OF DIRECTED ACYCLIC GRAPHS

Blockchain

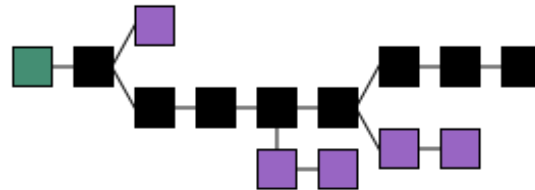

<https://en.wikipedia.org/wiki/Blockchain#/media/File:Blockchain.svg>

DAG

- Hashgraph, Avalanche, Tangle...
- Usually are not resistant to Sibyl attack (needs PoS or something else)

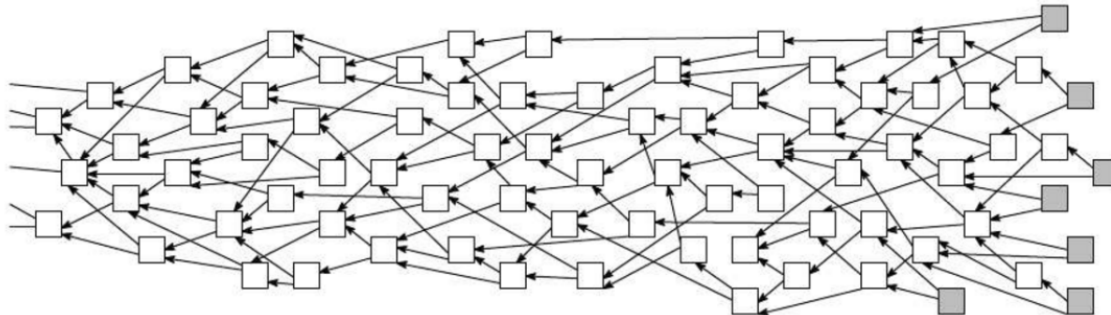

<https://ministryofblockchain.io/is-directed-acyclic-graph-dag-blockchains-new-competitor/>

HASHGRAPH

- Gossip about gossip
- Virtual voting

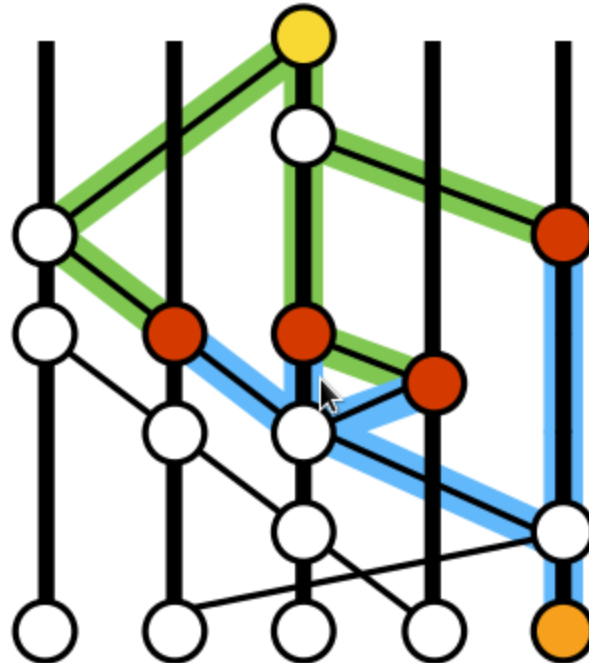

AVALANCHE

- Gossip protocol
- Metastability

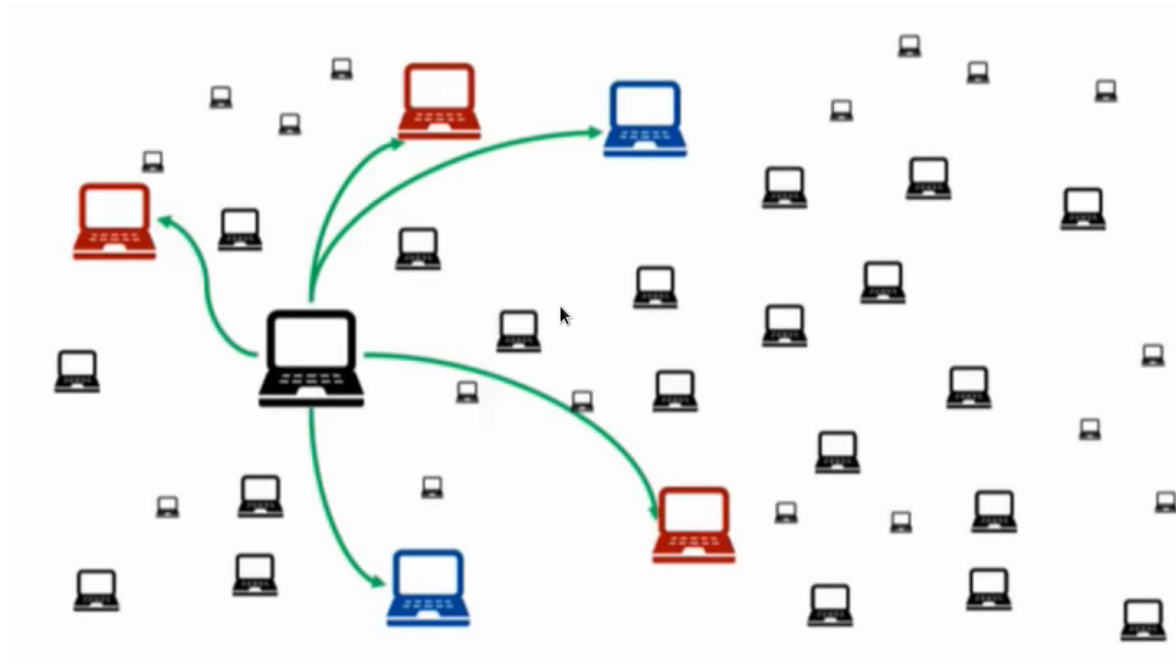

<https://www.youtube.com/watch?v=AXrrqtFIGow>

DAG BASED CONSENSUS

SUMMARY

- different data structure for storing transaction data
- not resistant to sibyls attack - PoS is usually involved

CHALOUPKA-JURÁNEK TAXONOMY

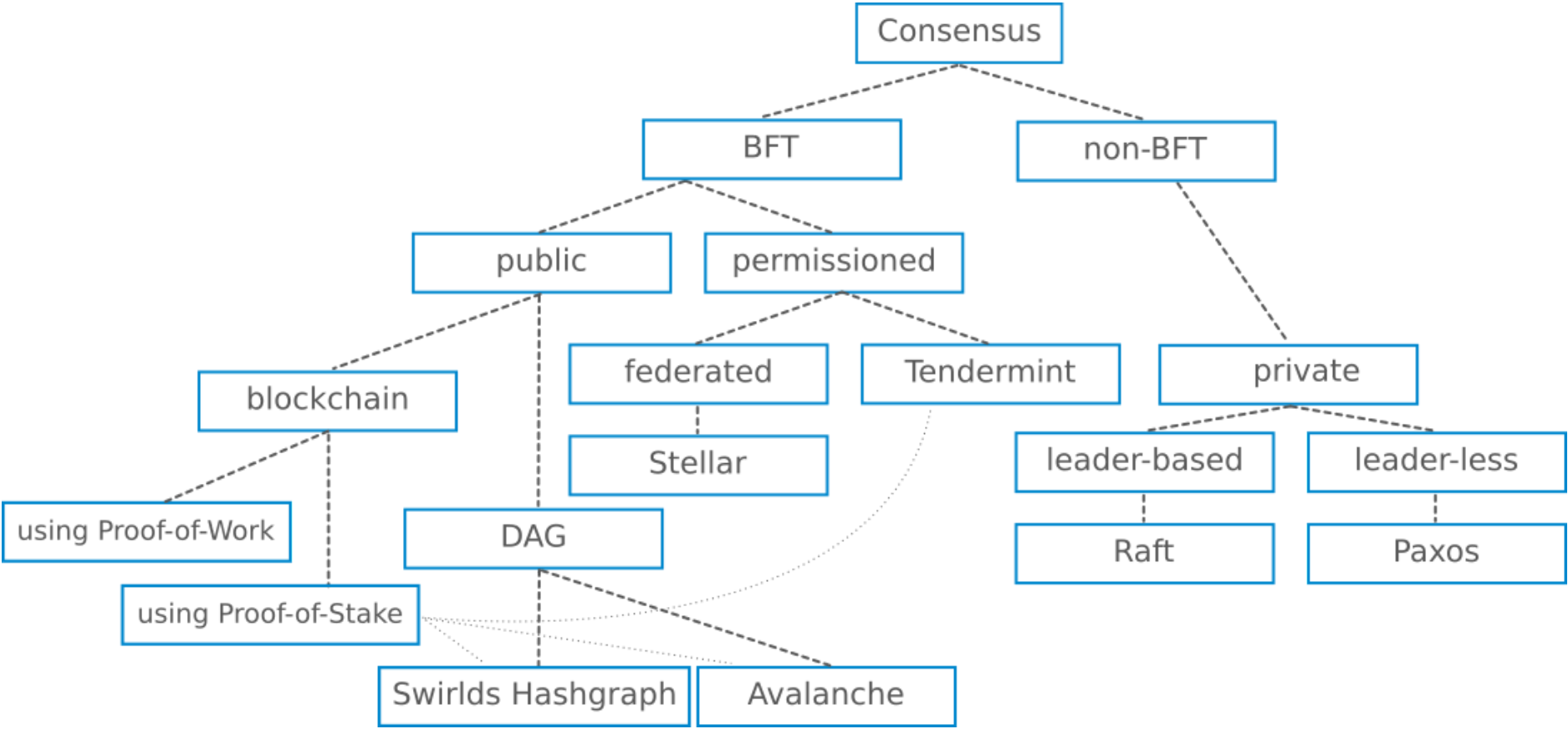

TAKE-OFFS

- Consensus protocol is a crucial part of any distributed ledger.
- Choice of consensus protocol influences heavily many characteristics of distributed ledger (including performance and security).
- There are several types of distributed ledgers, several families of consensus algorithms and not every consensus algorithm is suitable for every distributed ledger.

QUESTIONS

LINKS

- [S. Nakamoto, Bitcoin: A Peer-to-Peer Electronic Cash System](#)
- [D. Ongaro, J. Ousterhout, In Search of an Understandable Consensus Algorithm](#)
- [M. Castro, B Liskov, Practical Byzantine Fault Tolerance](#)
- [D. Mazieres, The Stellar Consensus Protocol](#)
- [The latest gossip on BFT consensus - Tendermint consensus algorithm](#)
- [L. Baird, The Swirlds Hashgraph Consensus Algorithm](#)
- [Team Rocket, Snowflake to Avalanche](#)
- [A Survey on Consensus Mechanisms and Mining Strategy Management in Blockchain Networks](#)



Thank you for your attention!

BACKUP SLIDES

BITCOIN 51% ATTACK

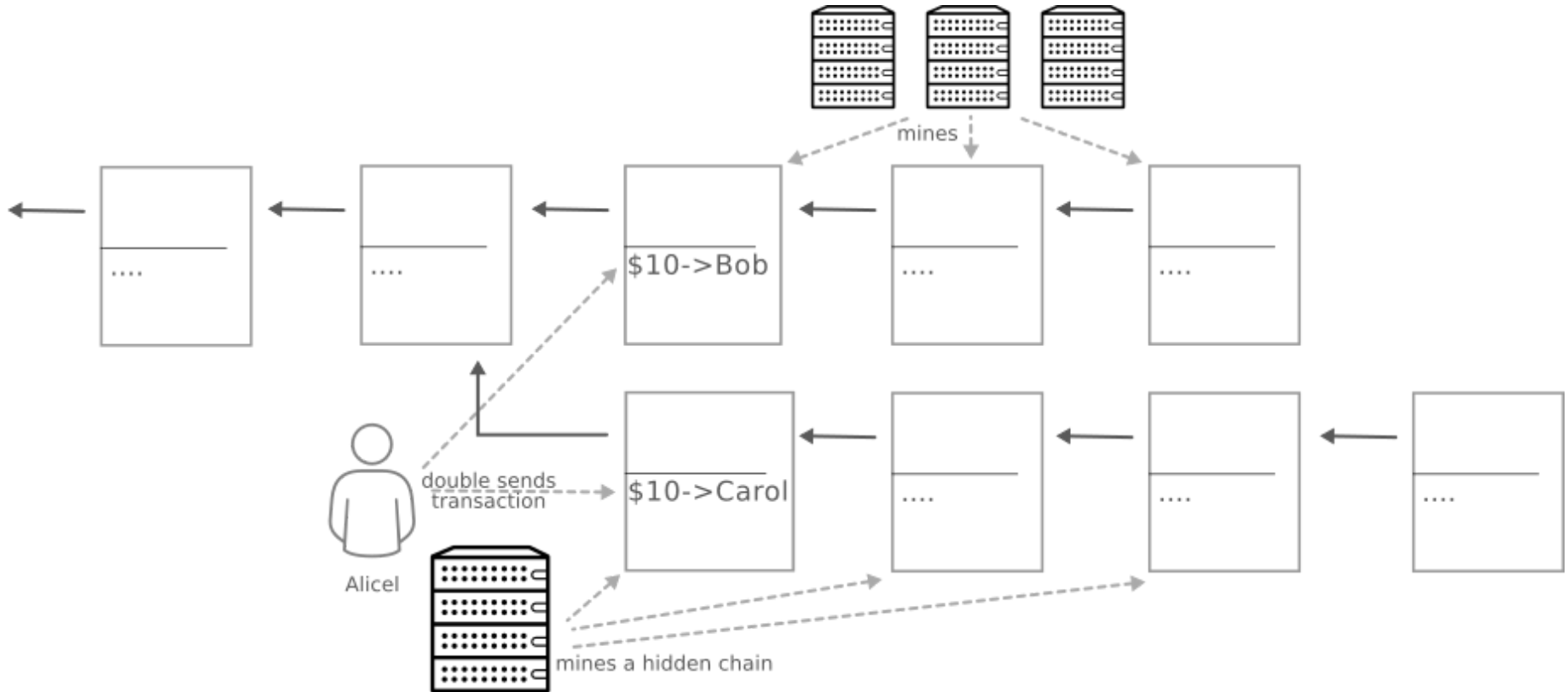

POS: NOTHING AT STAKE

Vote on neither
EV = 0

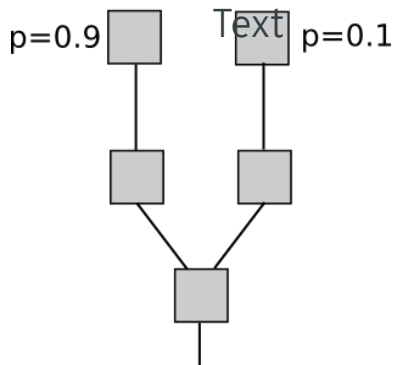

Vote on A
EV = 0.9

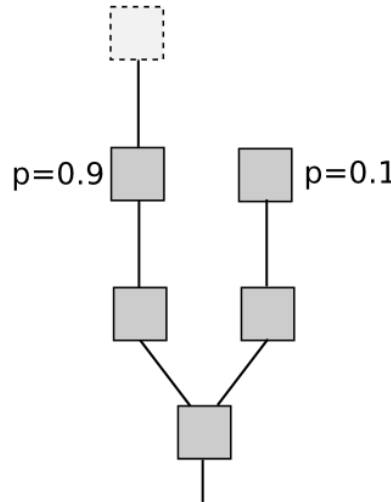

Vote on B
EV = 0.1

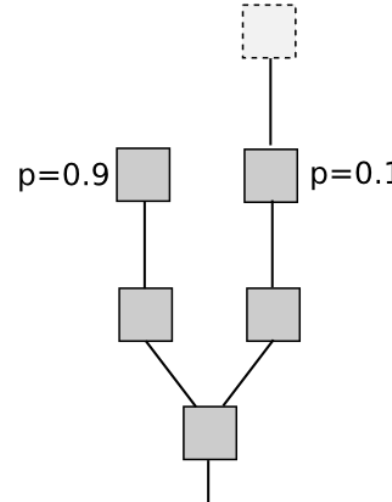

Vote on both
EV = 0.1 + 0.9 = 1

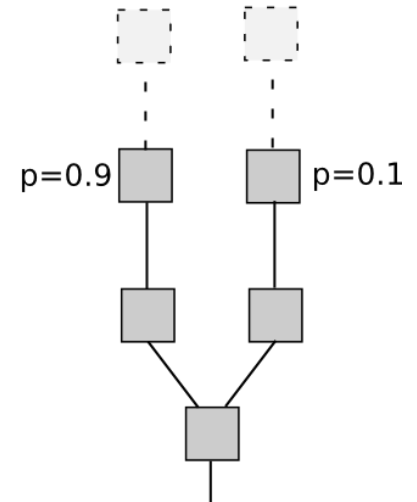

PROOF-OF-X

There are many:

- Proof of Capacity
- Proof of Elapsed Time (PoET)
- Proof of Authority
- Proof of Activity
- Proof of Burn
- Proof of Weight
- ...

Beware: Proof-of-X doesn't mean it's similar to PoW, actually in many cases it's quite different (e.g. centralized).

TAXONOMY TABLE

Proof-of-Work	Bitcoin	Public Permissionless	Byzantine tolerant	Probabilistic
Proof-of-Stake	Ethereum 2.0	Public Permissionless	Byzantine tolerant	Finite
Delegated PoS	Stellar	Permissioned public	Byzantine tolerant	Finite
Raft	Hyperledger	Permissioned private	non-Byzantine tolerant	Finite
Tendermint	Cosmos	Permissionless public	Byzantine tolerant	Finite
Swirlds	Hedera Hashgraph	Permissionless public	Byzantine tolerant	Finite
Avalanche	Ava	Permissionless public	Byzantine tolerant	Probabilistic

BLOCKCHAIN NETWORK IMPL.

