

Access

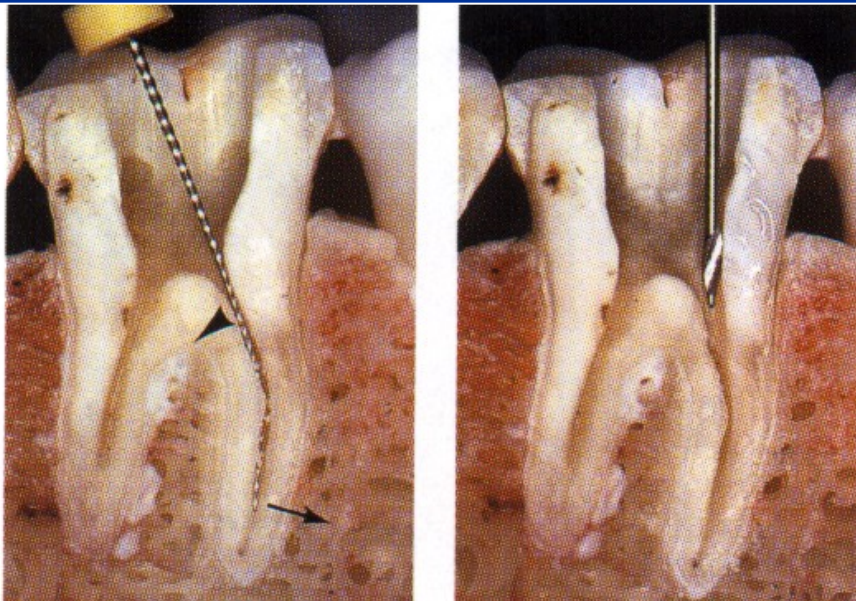

Access

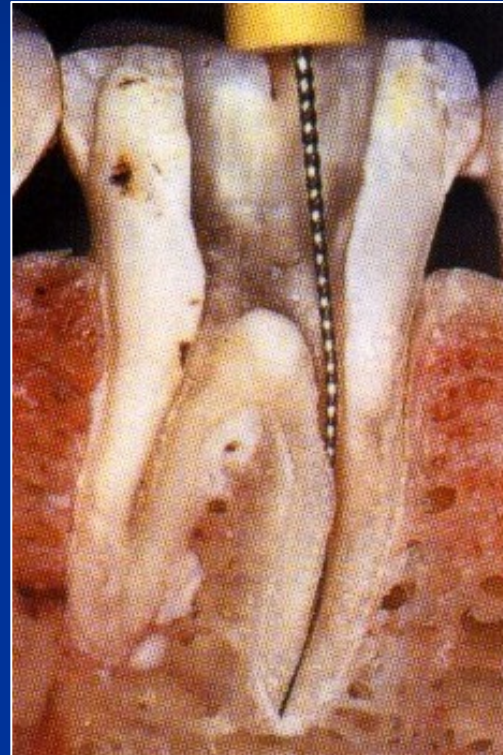
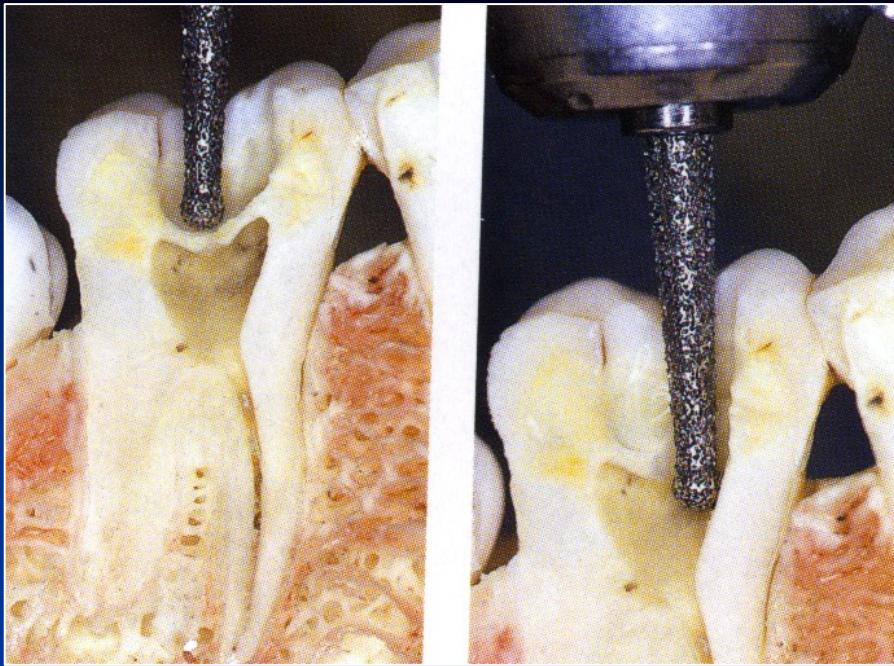

Access – opening of the pulp chamber

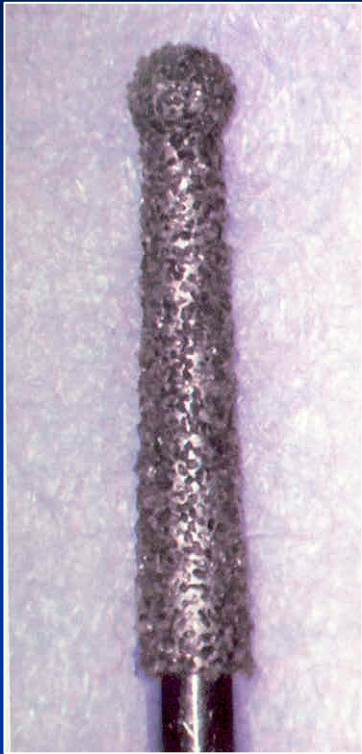

Dia trepan



Dia balls



Round Burs



Preparation of the endodontic cavity –facilitating form

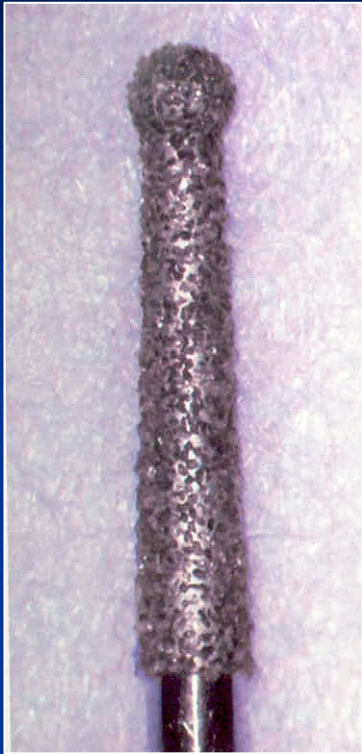

Dia trepan



Fissure burs

Instruments with safe
ended tips),
Acc. to Batt

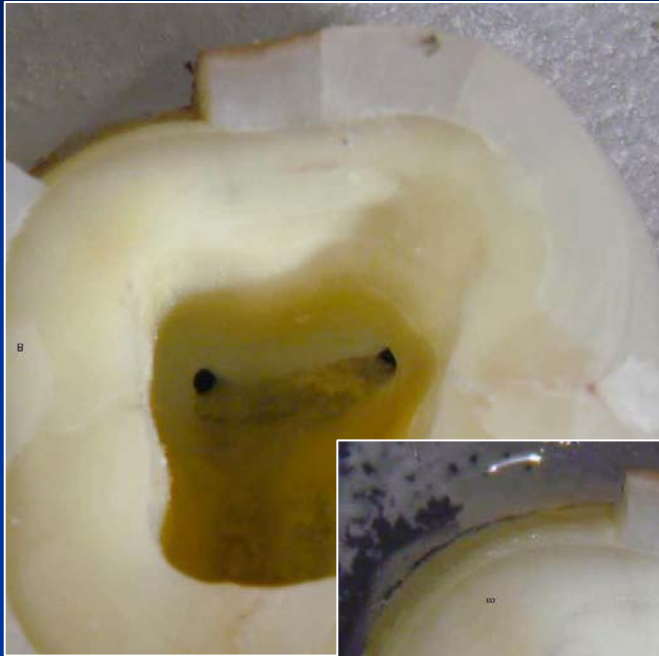

Root canal access

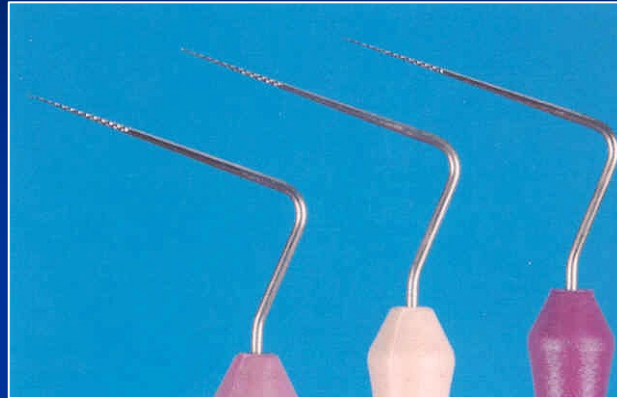
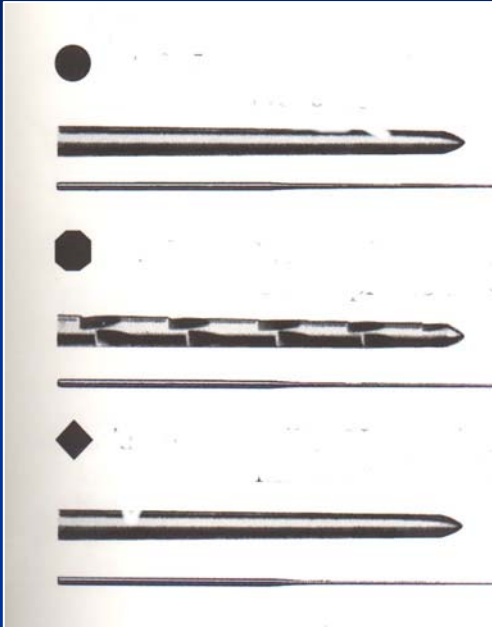

↑
Endodontic probes
Microopeners

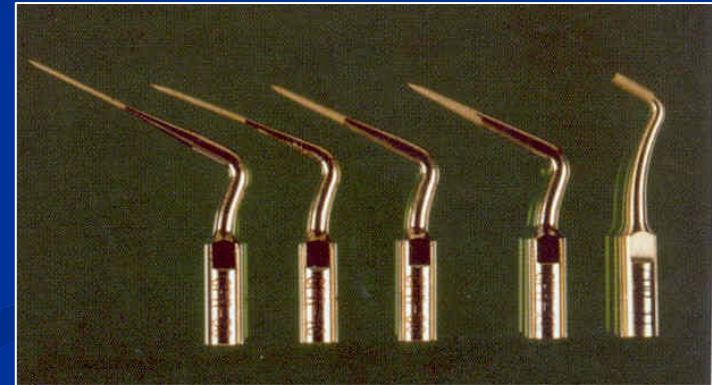

Ultrasound



Dye

Opening of the root canal orifices



Round burs

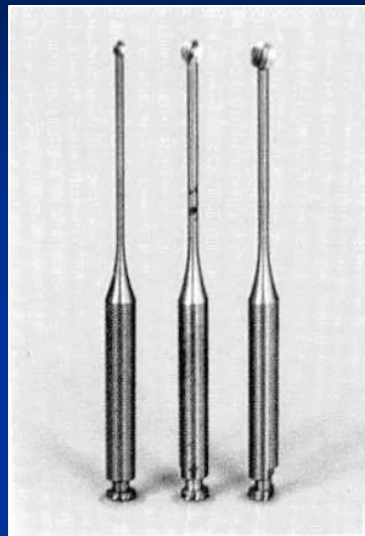

Miller's burs

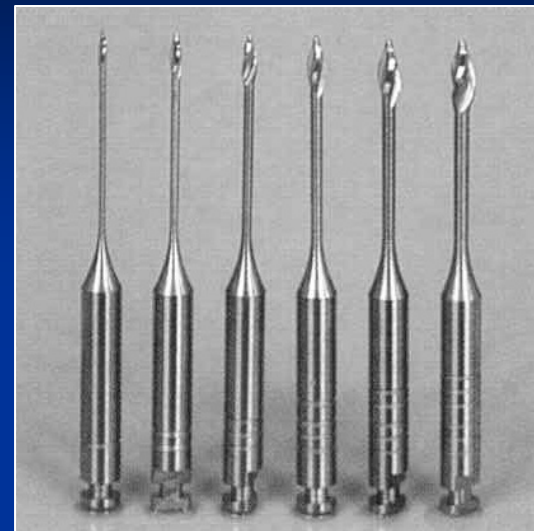

Gates Glidden's burs

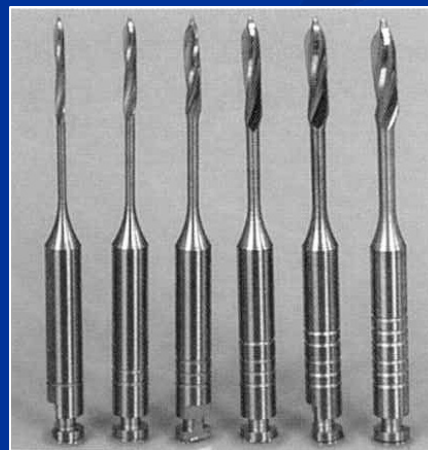

Peeso – Largo burs



Gates - Glidden



Peeso-Largo

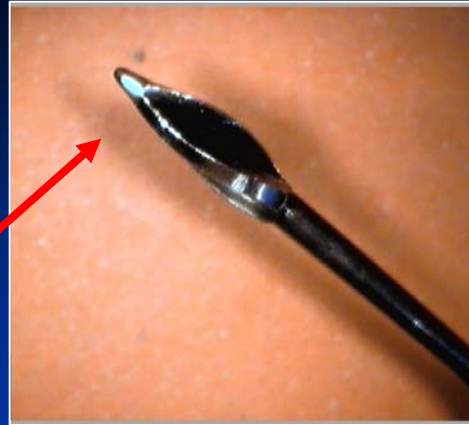

Gates – Glidden:

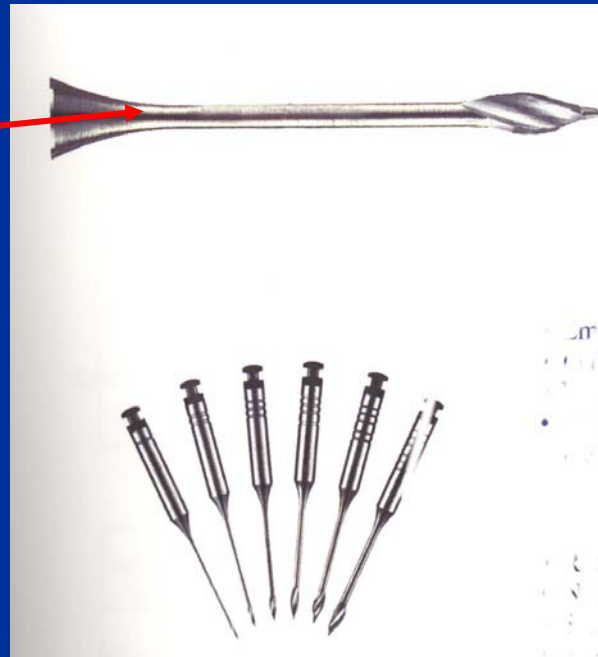

Point of breakage

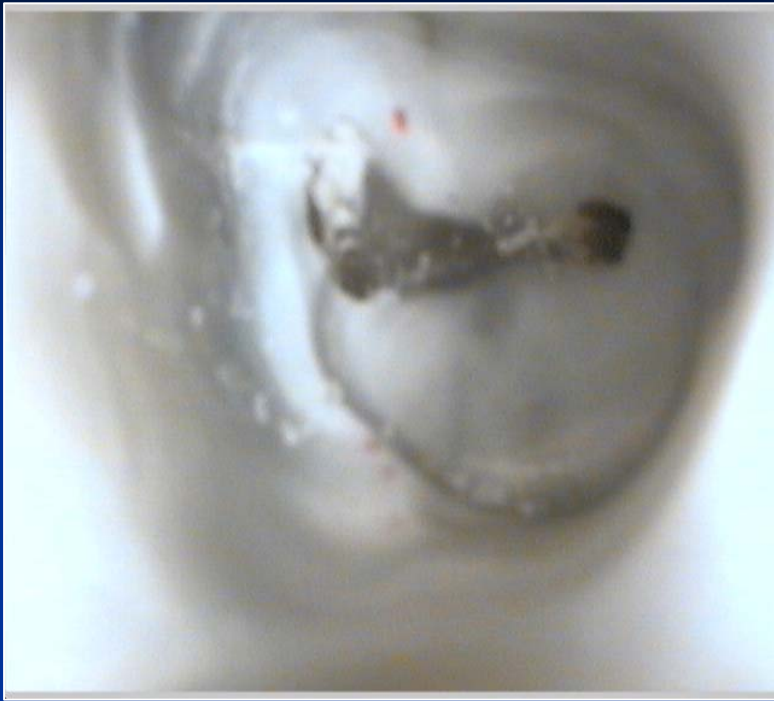

Bad endodontic cavity



Good endodontic cavity

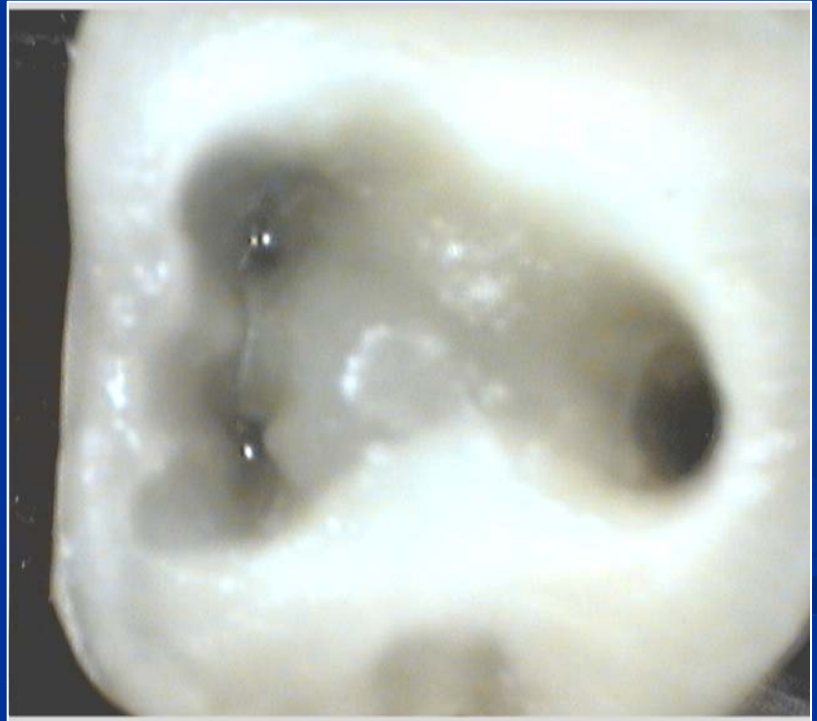

Extraction of the content of the root canal - exstirpation

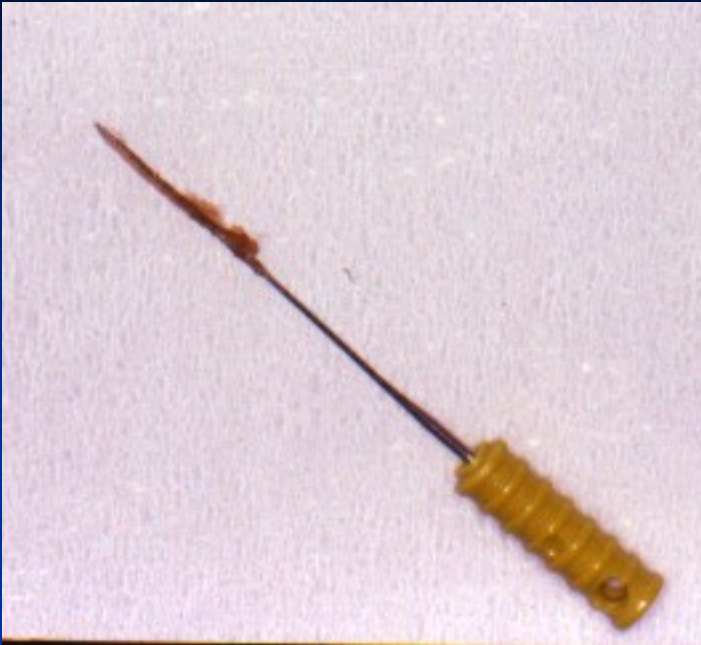

Pulpextraktor – made of soft wire



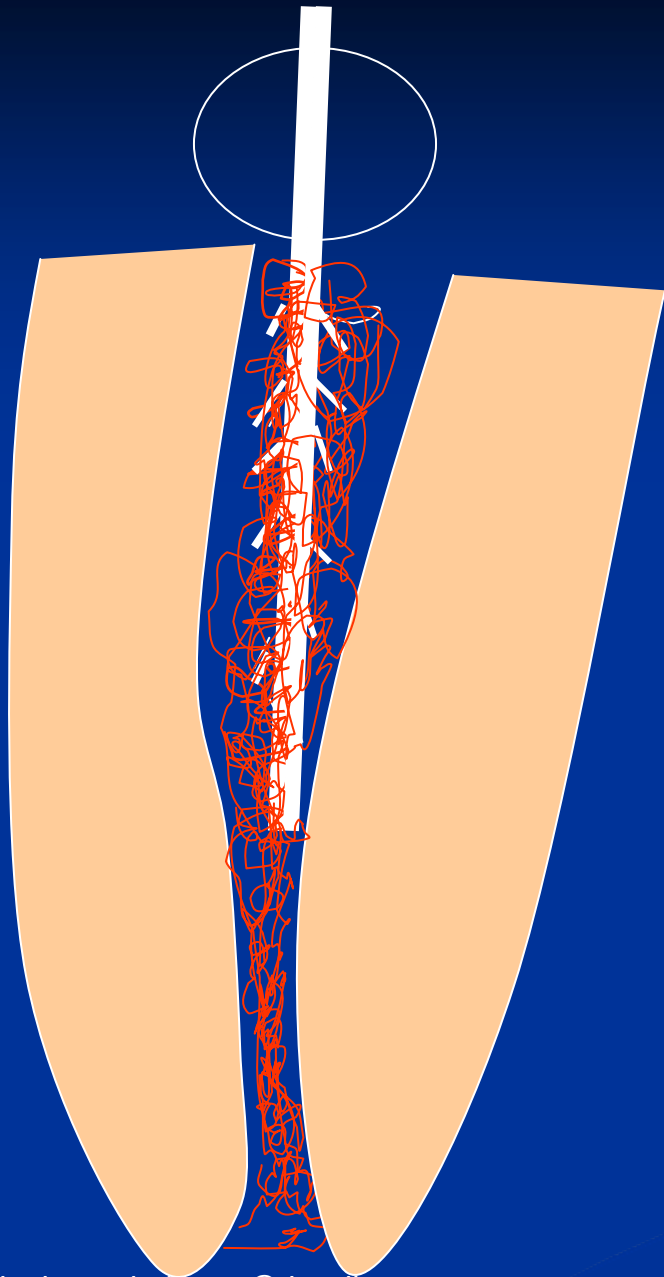

➤ **Rotation and exstirpation!**

Canal shaping

➤ Reamers

➤ Files

Reamer

- **K -reamer**

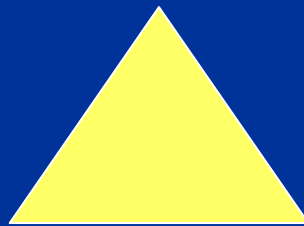

Reamer

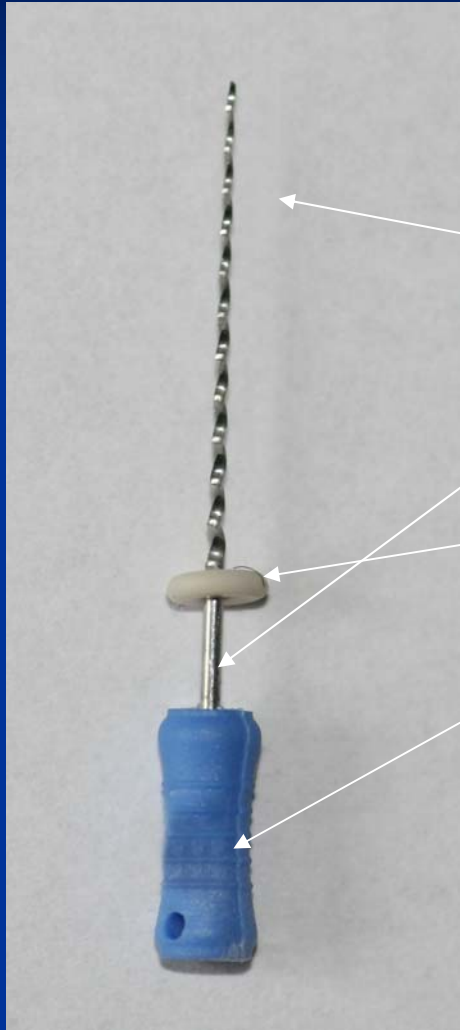

Working –cutting part

Shank

Stopper

Grip



Reamer

Cutting edges

Space for chips

Clockwise rotation

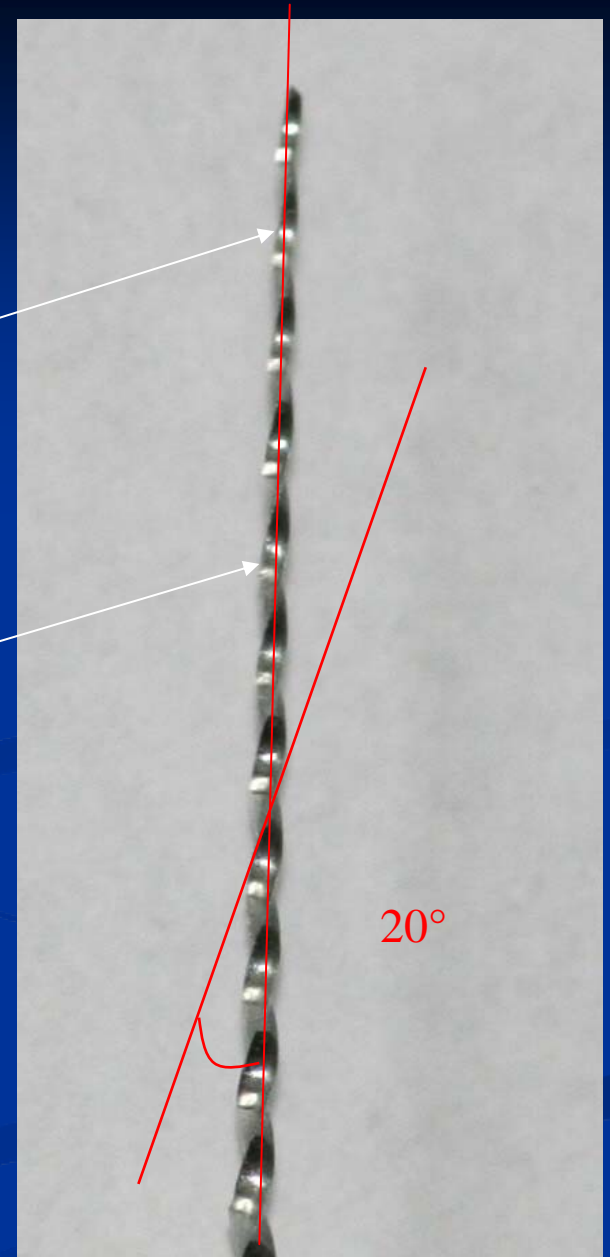

Files

1. K-file
2. K-flexofile, flexicut, flex-R - file
3. K-flex
4. H-file, S-file

K file



K-file

Filing and (or) rotation

Straight canals 45° - 90°

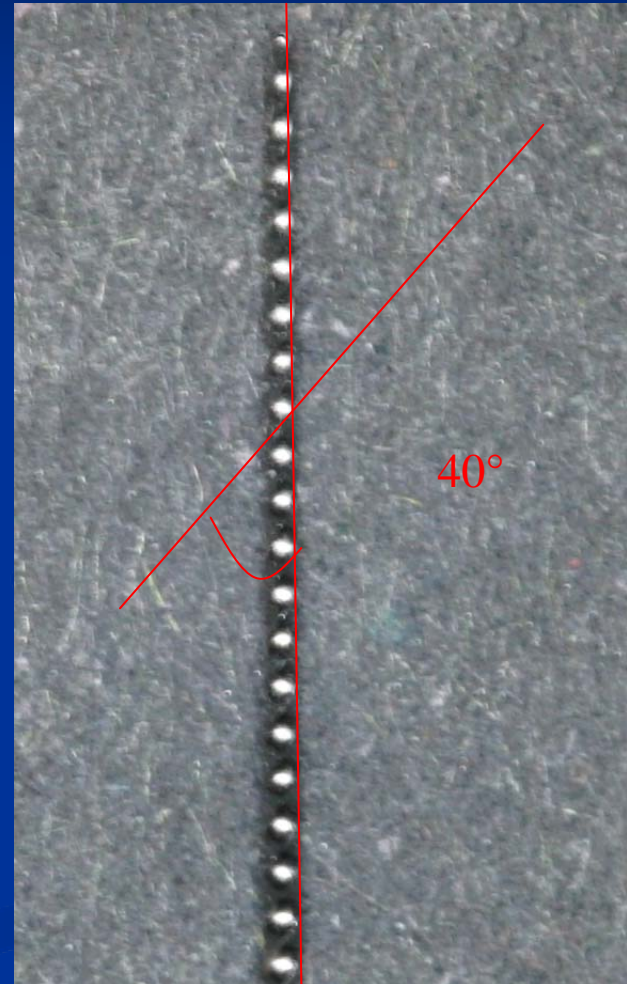

K-file x reamer



H-file

= Hedström file

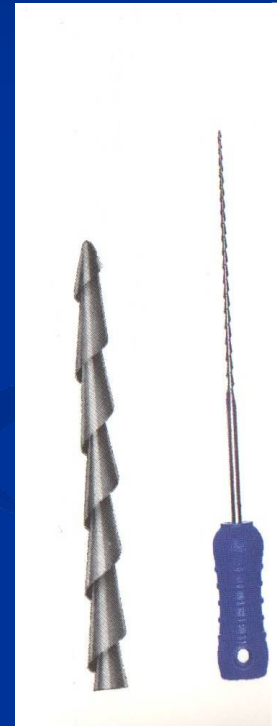
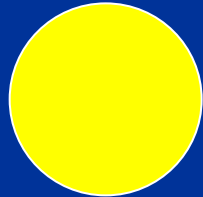

H- file

Filing only!!!!

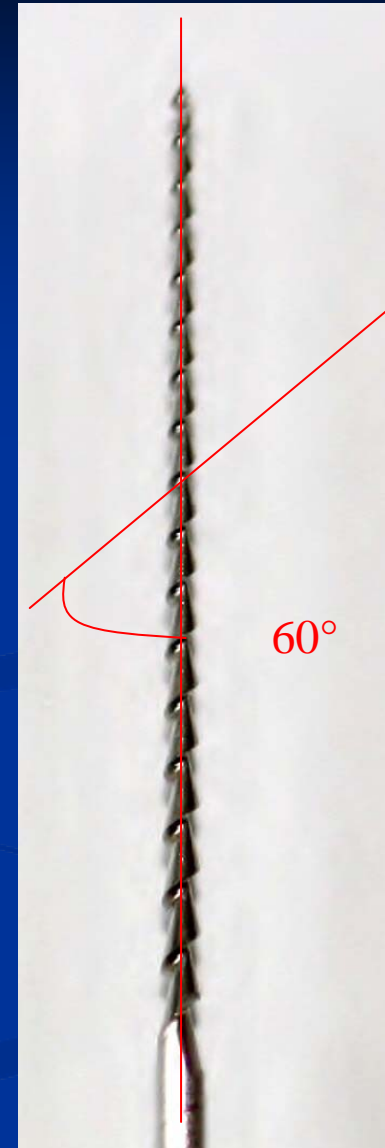
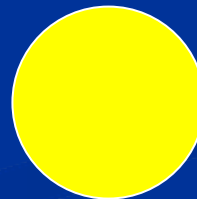

ISO norma

- Diameter
- Length of the cutting part
- Taper



06 pink

08 gray

10 purple

15 white

20 yellow

25 red

30 blue

35 green

40 black

45 white

50 yellow

55 red

60 blue

70 green

80 black

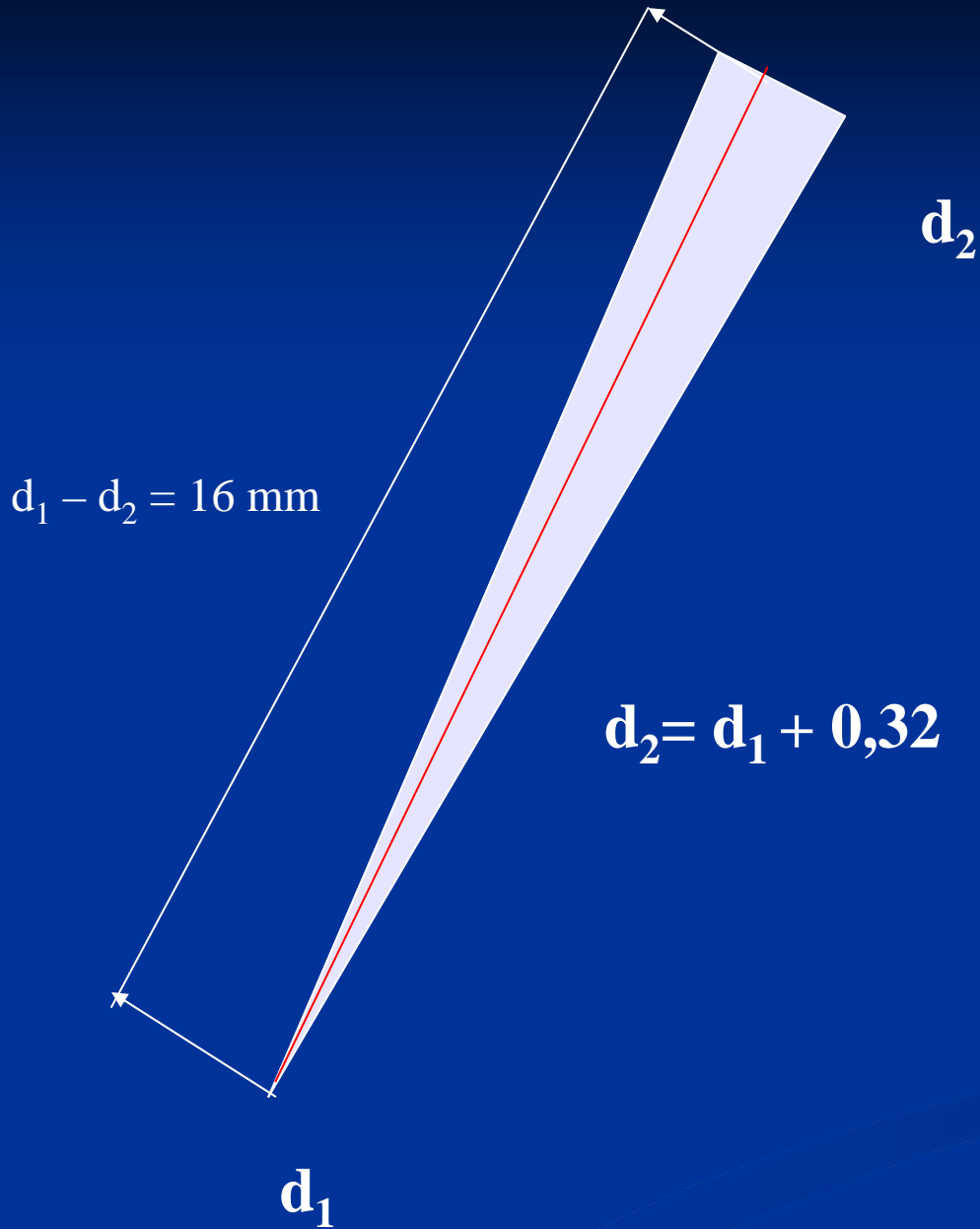

Taper 2%

0,02 mm na 1mm

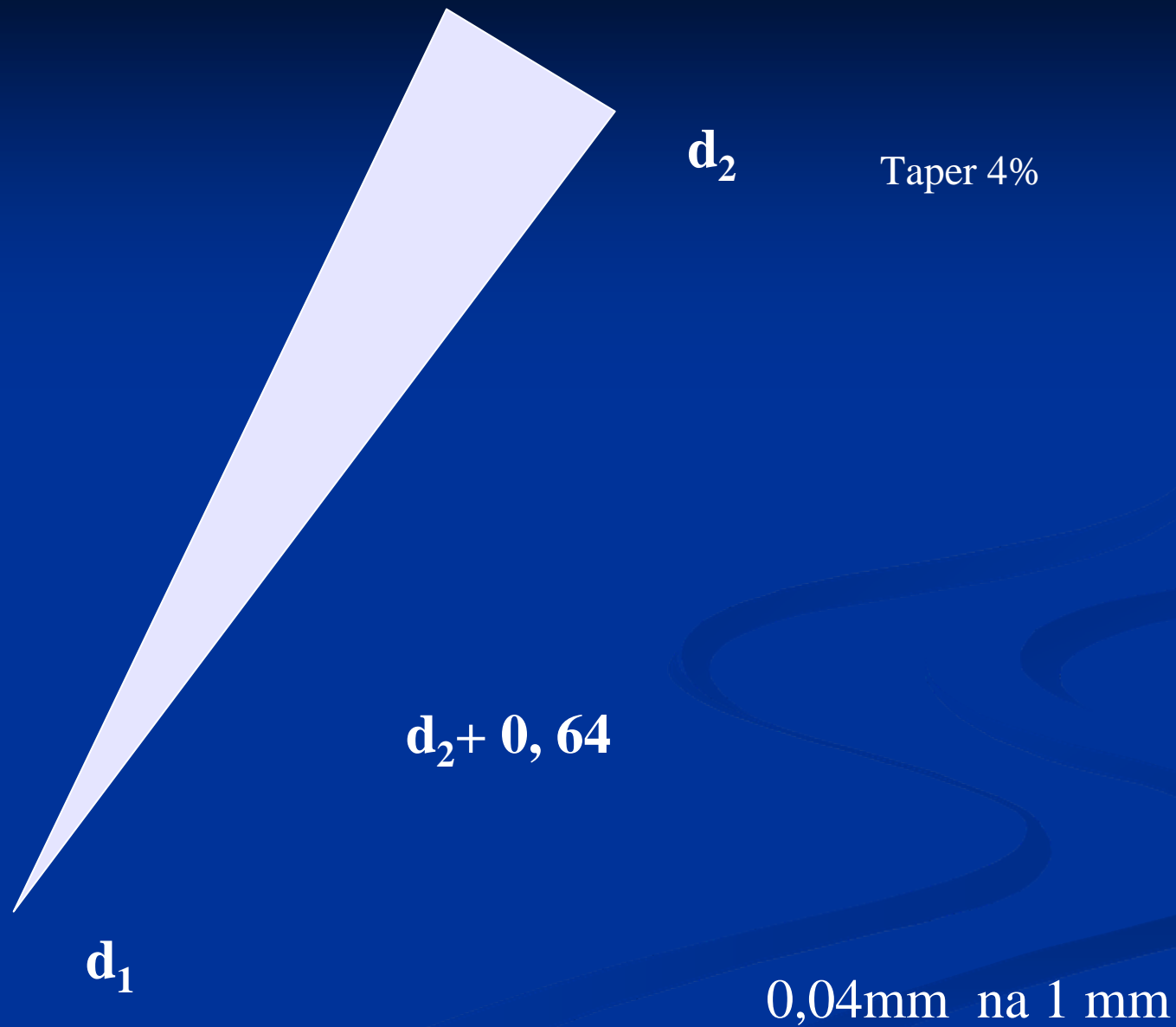

Taper 4%

d_2

$$d_2 = d_1 + 0,96$$

d_1

0,06mm na 1 mm

Instrumentation

- Rotace tam a zpět – 45°

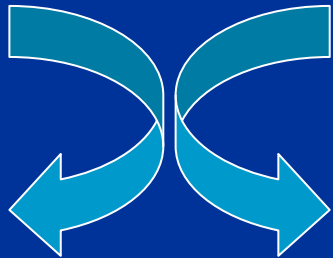

K – reamer

K- file

Instrumentation

- Rotace 45° tlak a vytažení

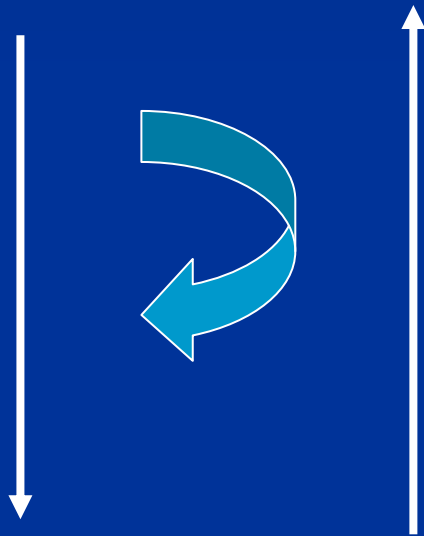

K – reamer

K- file

*Riziko intrakanálového schůdku
Zip a elbow efektu
Via falsa*

Instrumentation

■ Pilování

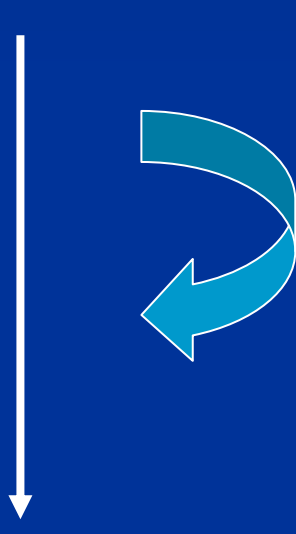

H- file

K – file

Riziko přetlačení obsahu
Riziko vzniku zátky

Instrumentation

- Ttechnika balancované síly – nástroj o 1 číslo větší než apikální velikost

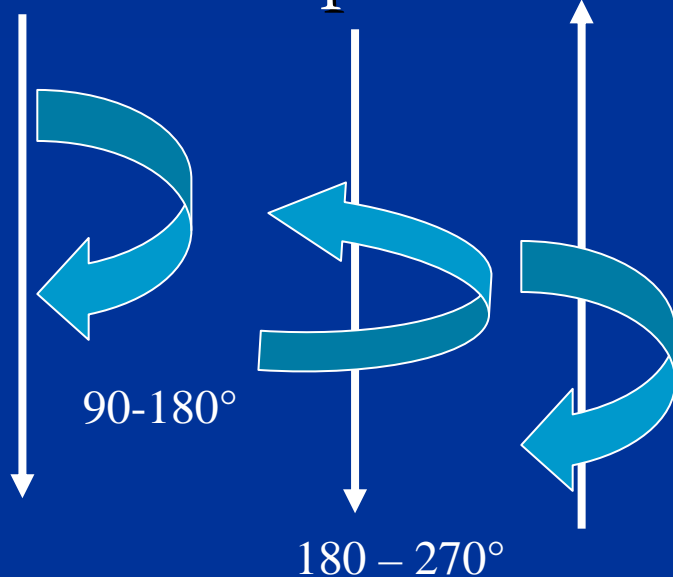

K- flexofile

K – file (?)

Reaming

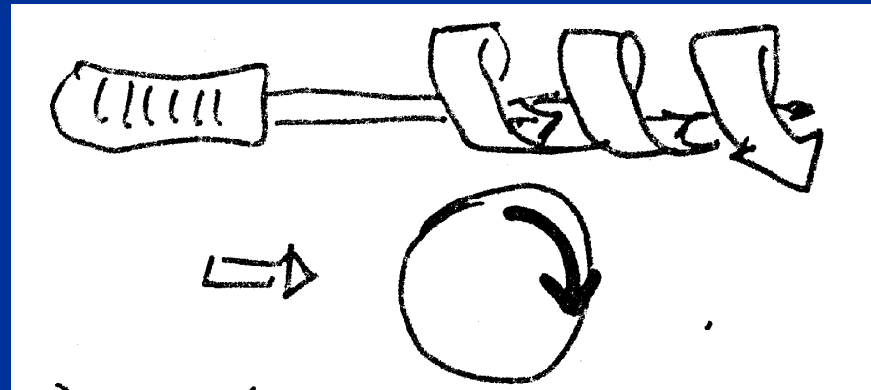

Simple clockwise rotation

Filing

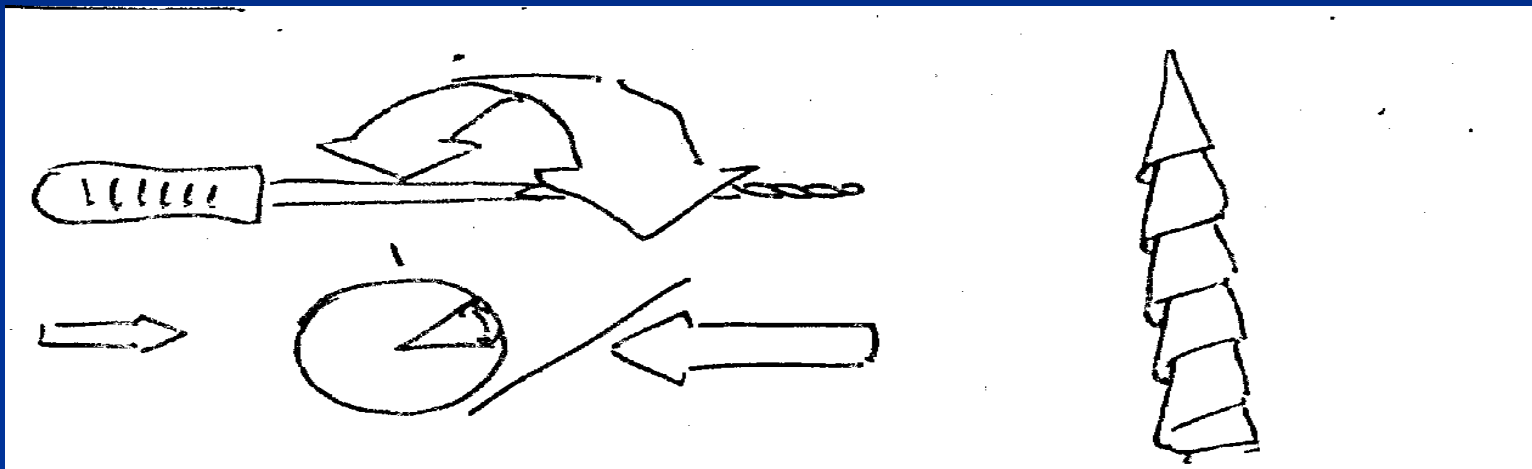

Balance forced technique

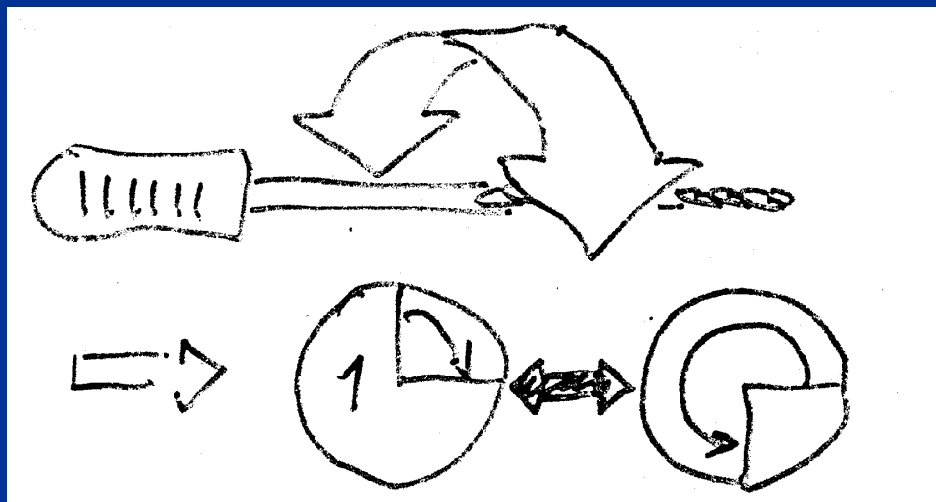

Circumferential filing

