

# *Anesteziologický přístroj, monitorace*

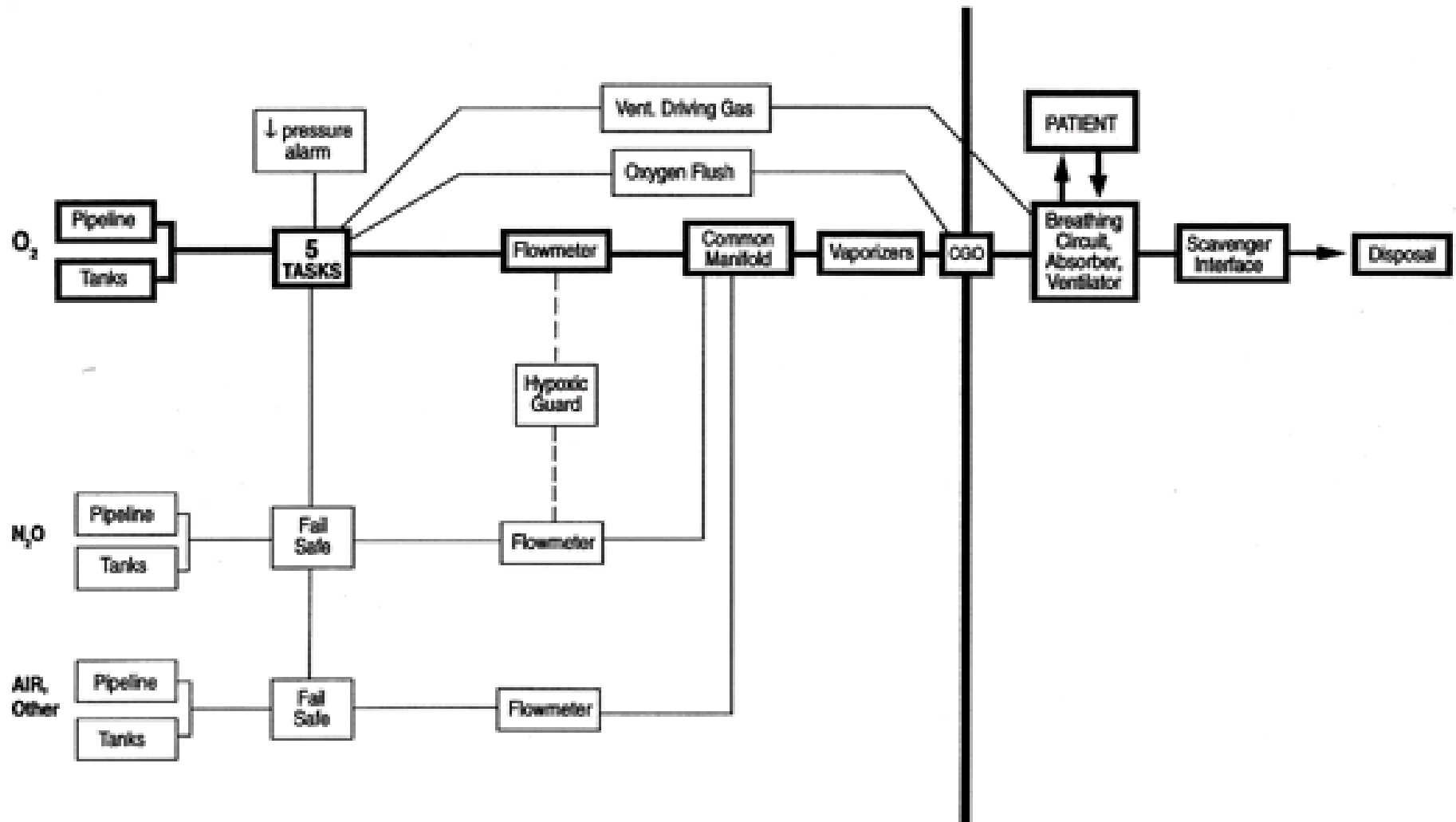

L.Dadák  
ARK FNUSA & LF MU

# 5 úkolü O2



# Plyny – značení ISO

O<sub>2</sub> - bílý

- frakční destilace stlačeného = kapalného vzduchu.
- (N<sub>2</sub> vře dříve než O<sub>2</sub>)

N<sub>2</sub>O - modrý

- tlak 5 MPa

Vzduch bílo/černý

CO<sub>2</sub> - šedý

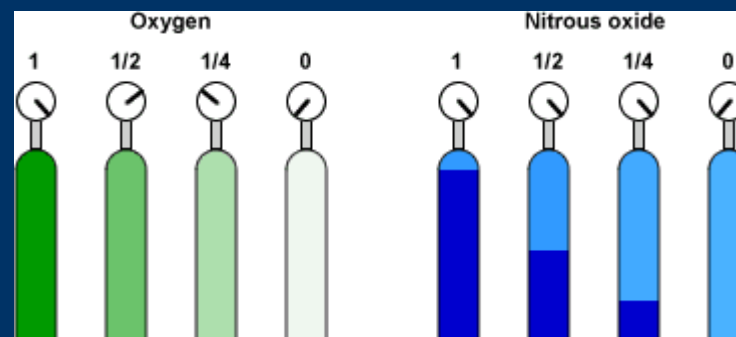

plyn

hladina

# *Anesteziologický přístroj*

umožňuje ventilovat definovanou směsí plynů  
bezpečnostními prvky brání podání hypoxické směsi

části:

- 1.High pressure system
  - 2.Low pressure system - směs plynů, inhalační anestetikum
  - 3.Breathing circuit - vdech, výdech část
  - 4.Ventilation systems (manual and mechanical)
  - 5.Scavenging system - odtah anest.plynů
- 
-

# Části anest. přístroje

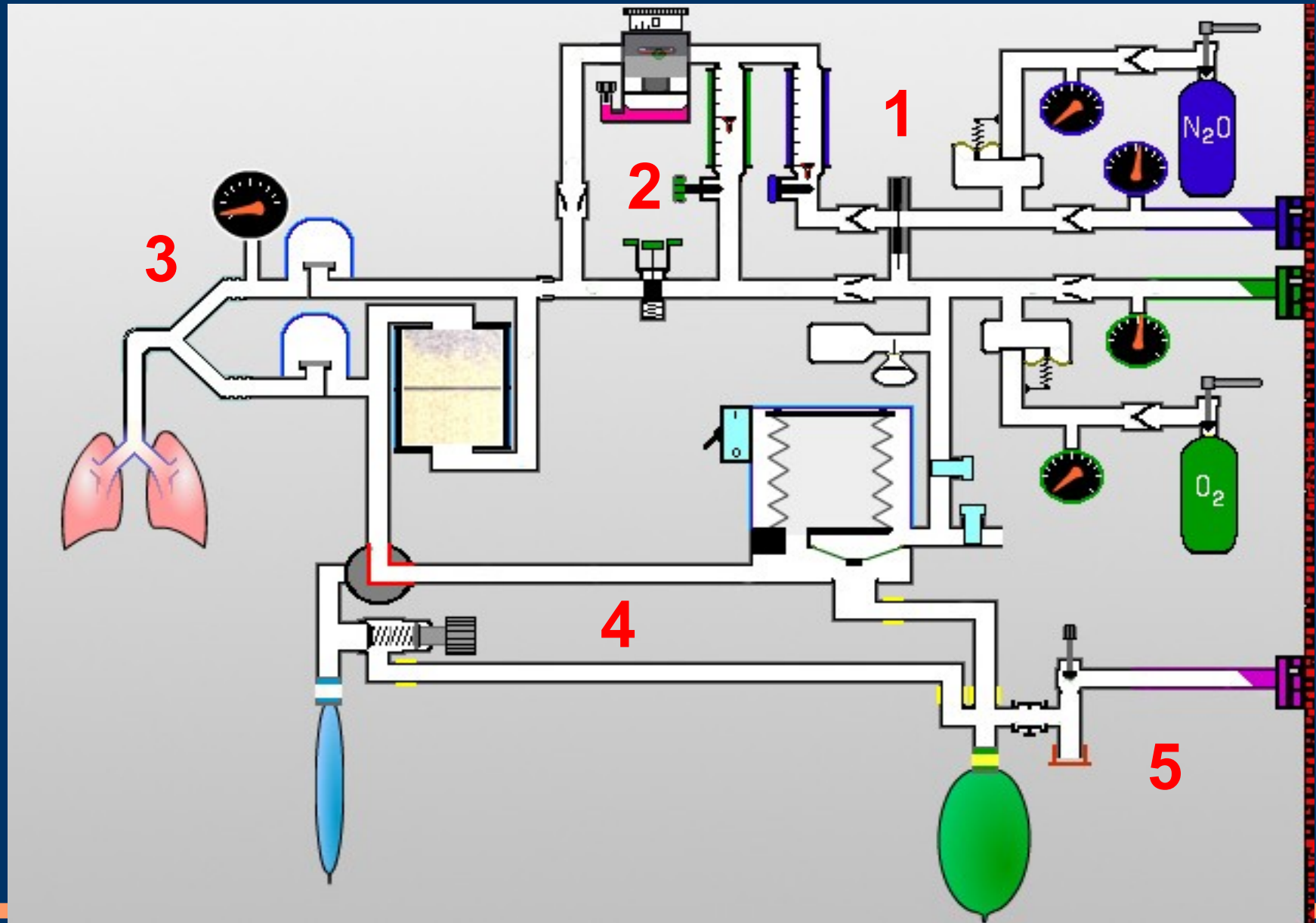

# Vysokotlaká část

Zdroj stlačeného plynu

- tlakové láhve
- centrální rozvod plynů
- alarm nízkého tlaku O<sub>2</sub>
- bezpečnostní chlopeň
- redukční ventil

- manometr

$$p_{O_2} > p_{N_2O}$$

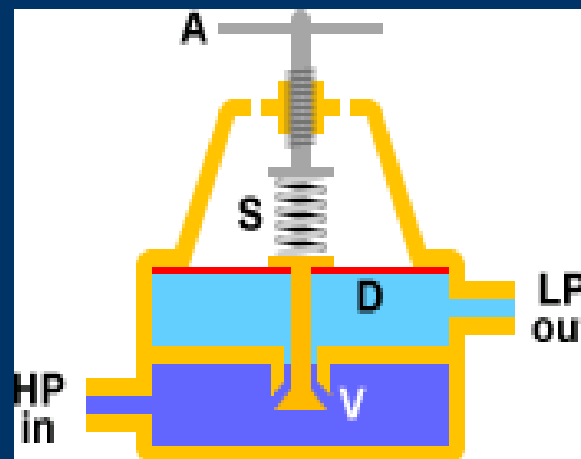

# Nízkotlaková část

- průtokoměry = flowmetr O<sub>2</sub>, AIR, N<sub>2</sub>O
- odpařovač
- bypass

řízení průtoku  
a koncentrace

O<sub>2</sub> a N<sub>2</sub>O -  
spřaženy  
min.  $f_iO_2$  25%

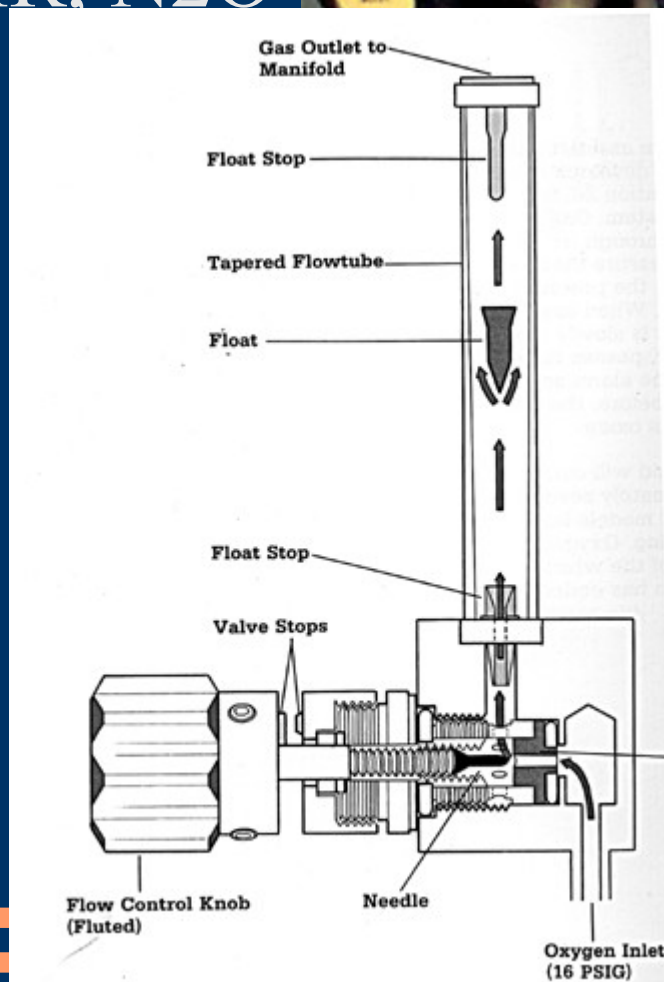
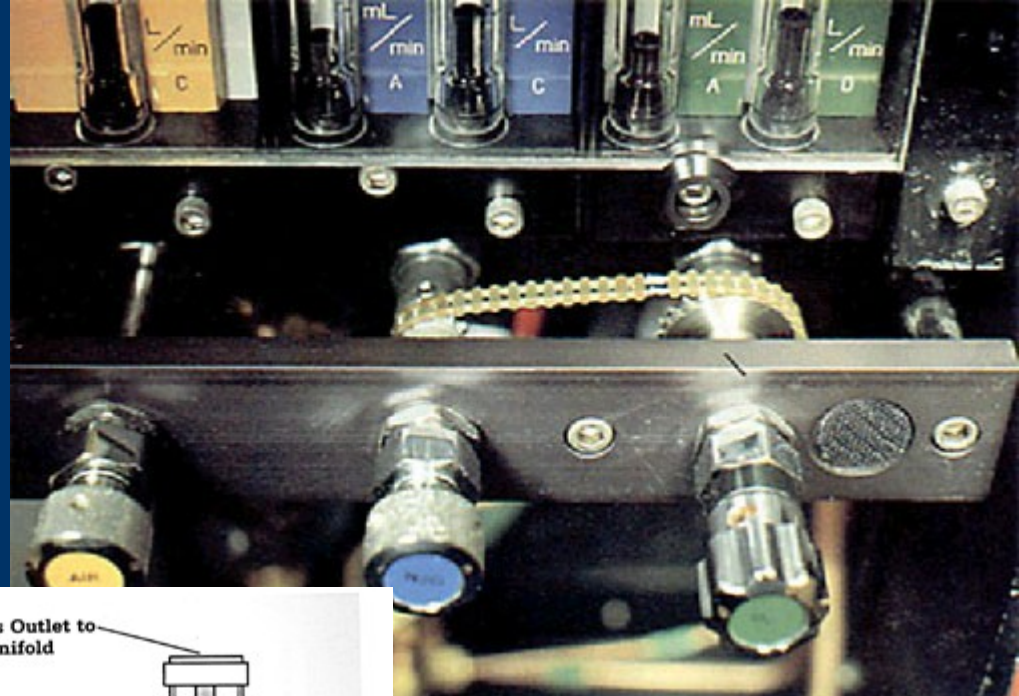

# Průtoky anest. plynů

- dříve :
- low flow
- minimal flow
- uzavřený systém

pod 1 l/min

pod 0,5 l/min

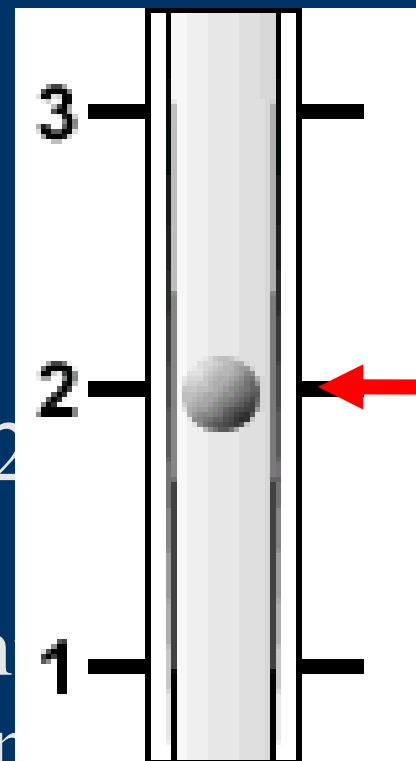

- mandatorní minimální průtok - 200ml/min O<sub>2</sub> -  
minimální příkon O<sub>2</sub> po zapnutí anest. přístroje



# Odpařovače

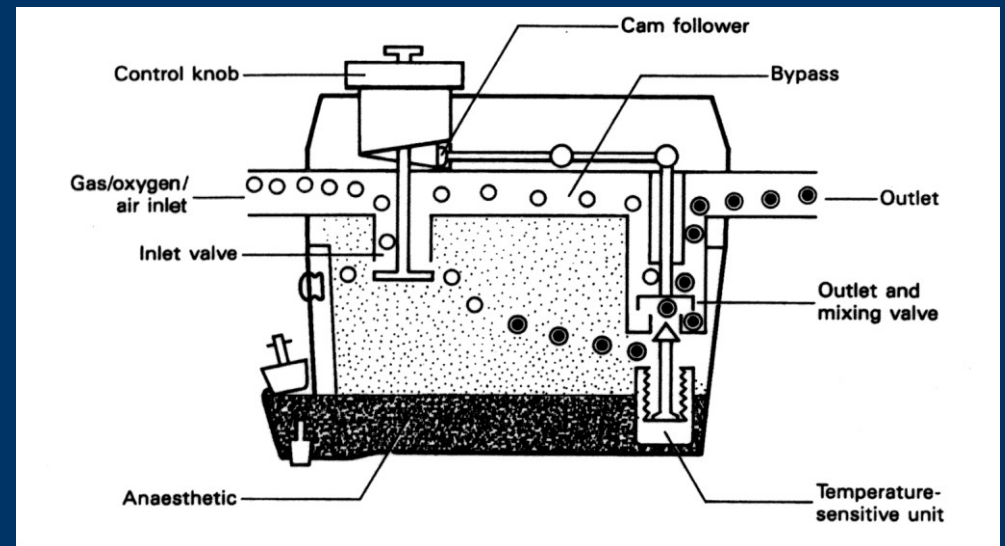
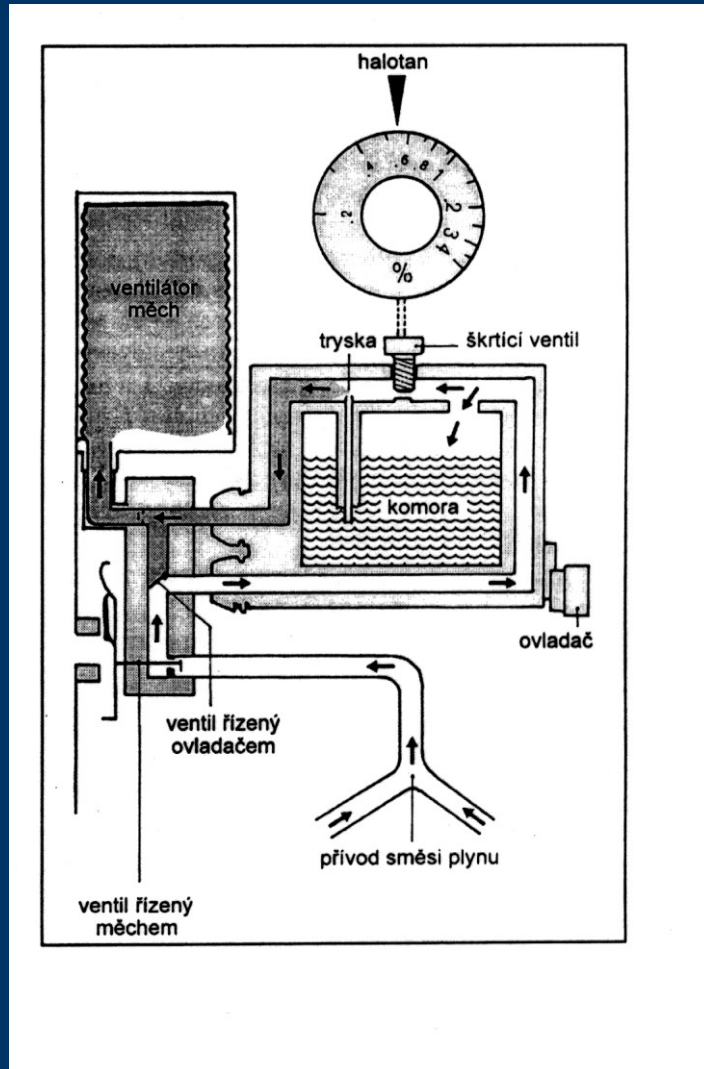
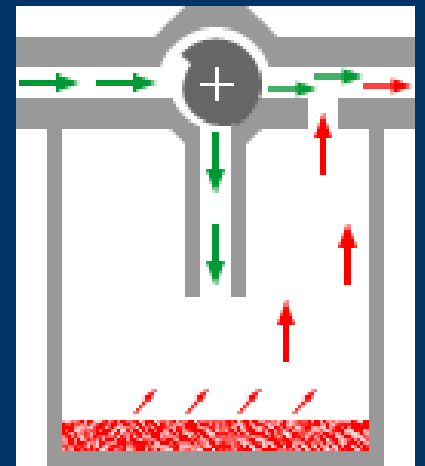

# Všechno je jinak ... Desfluran

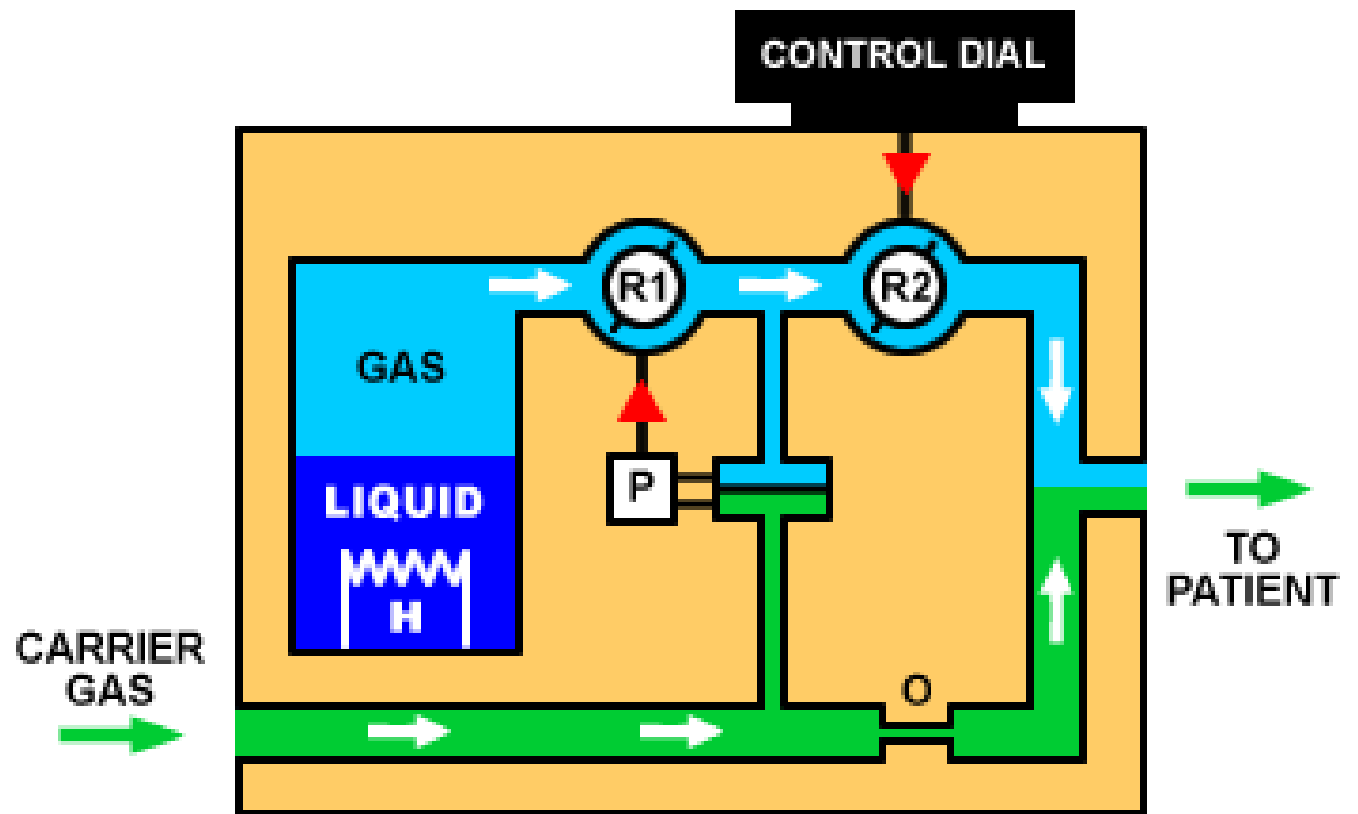

# *Dýchací okruh*

- chlopeň vdechová
- manometr
- hadice
- Y spojka
- chlopeň výdechová
- volumetr
- pohlcovač CO<sub>2</sub>
- přepadový ventil

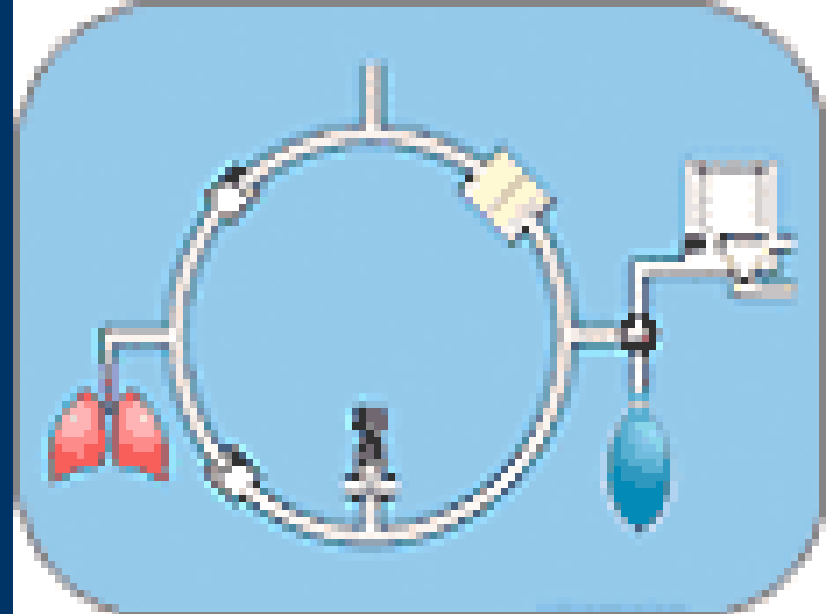

umožní znovu vdechovat plyn zbavený CO<sub>2</sub> – low  
flow

---

---

# *chlopeň vdechová*

1 směr

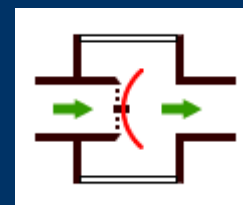
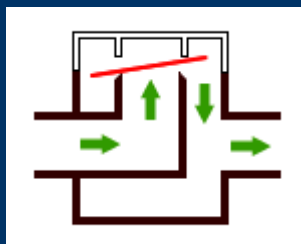

# *manometr*

- tlak v dýchacích cestách  
0..20 ... (40) cm H<sub>2</sub>O

během ventilace obličejovou maskou „nepřekročit“  
Esophageal Opening Pressure 20cm H<sub>2</sub>O



# *Y spojka, filtr, prodlužovací hadice*



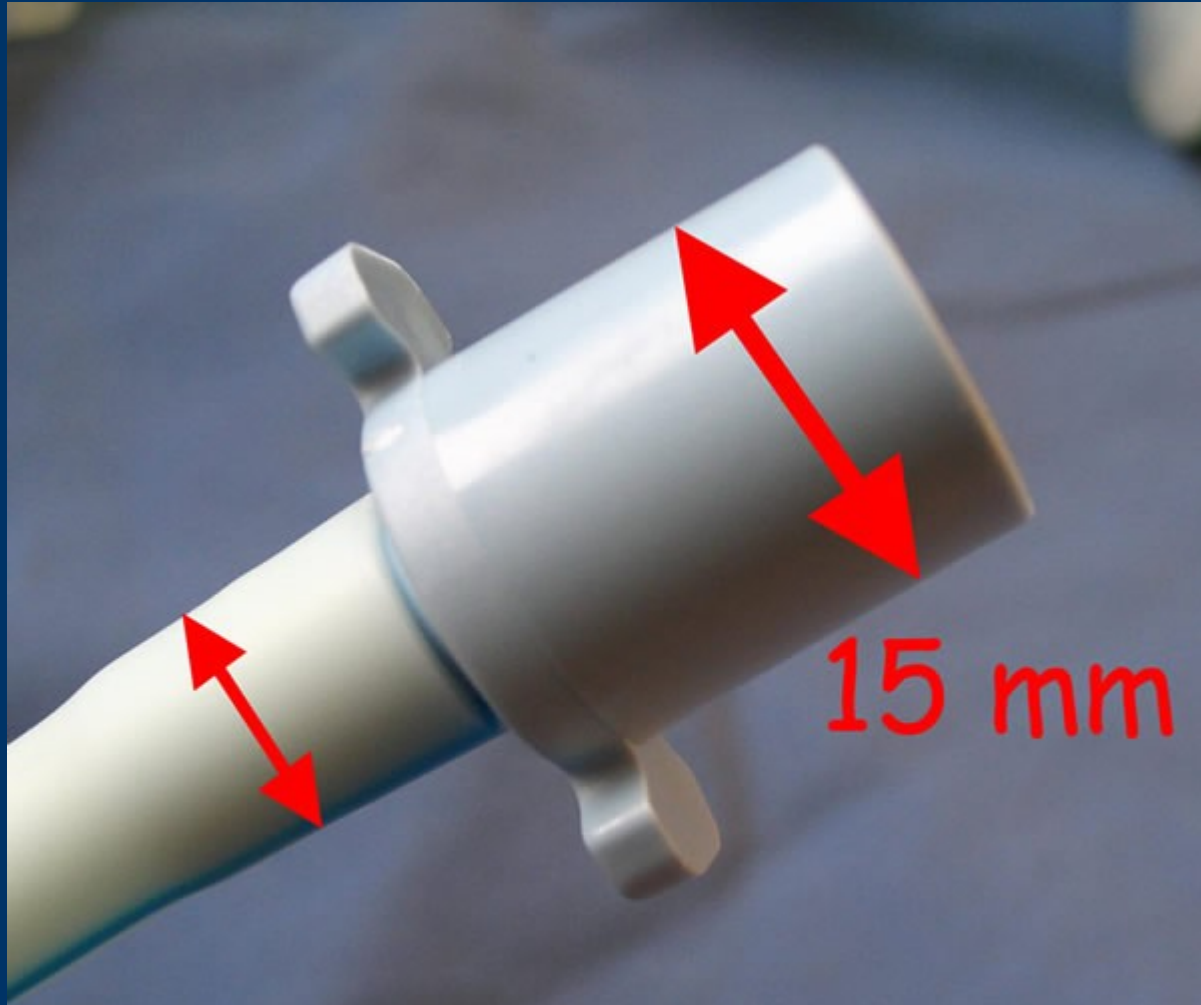

# *pohlčovač CO<sub>2</sub>*

Neutralizační reakce:

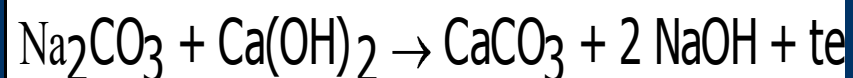
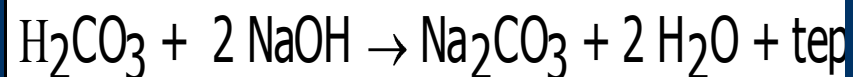
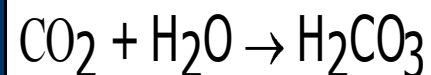

kapacita: (teoreticky 26l) reálně 15-20l CO<sub>2</sub>/100 g



*hadice*

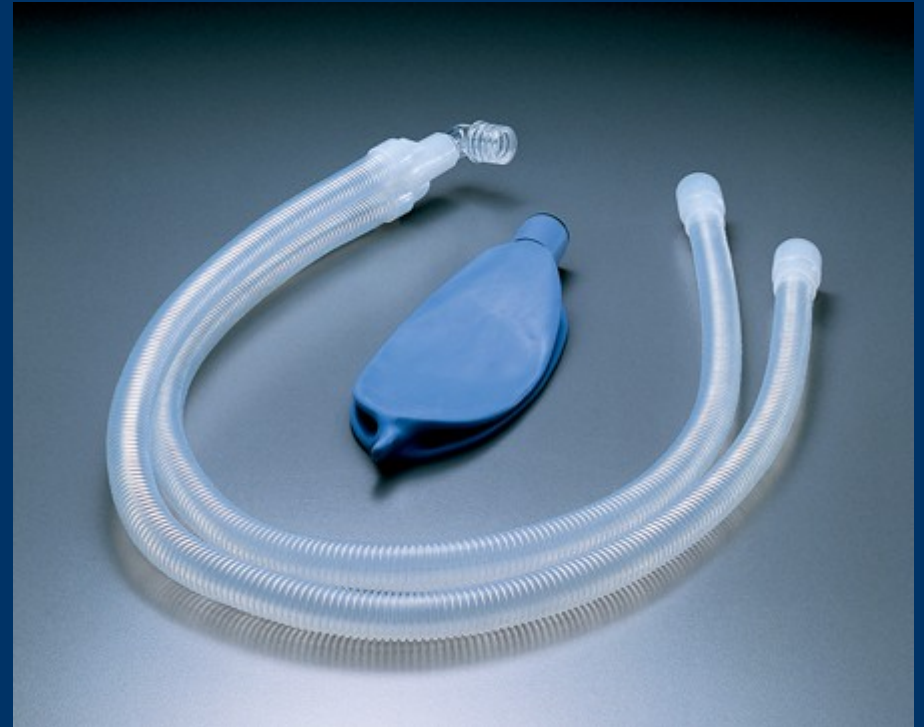

# *přepadový ventil*

adjustable Pressure Limiting (APL) valve

plně otevřen = 0,5 cm H<sub>2</sub>O

uzavřen 60 .. 80 cm H<sub>2</sub>O

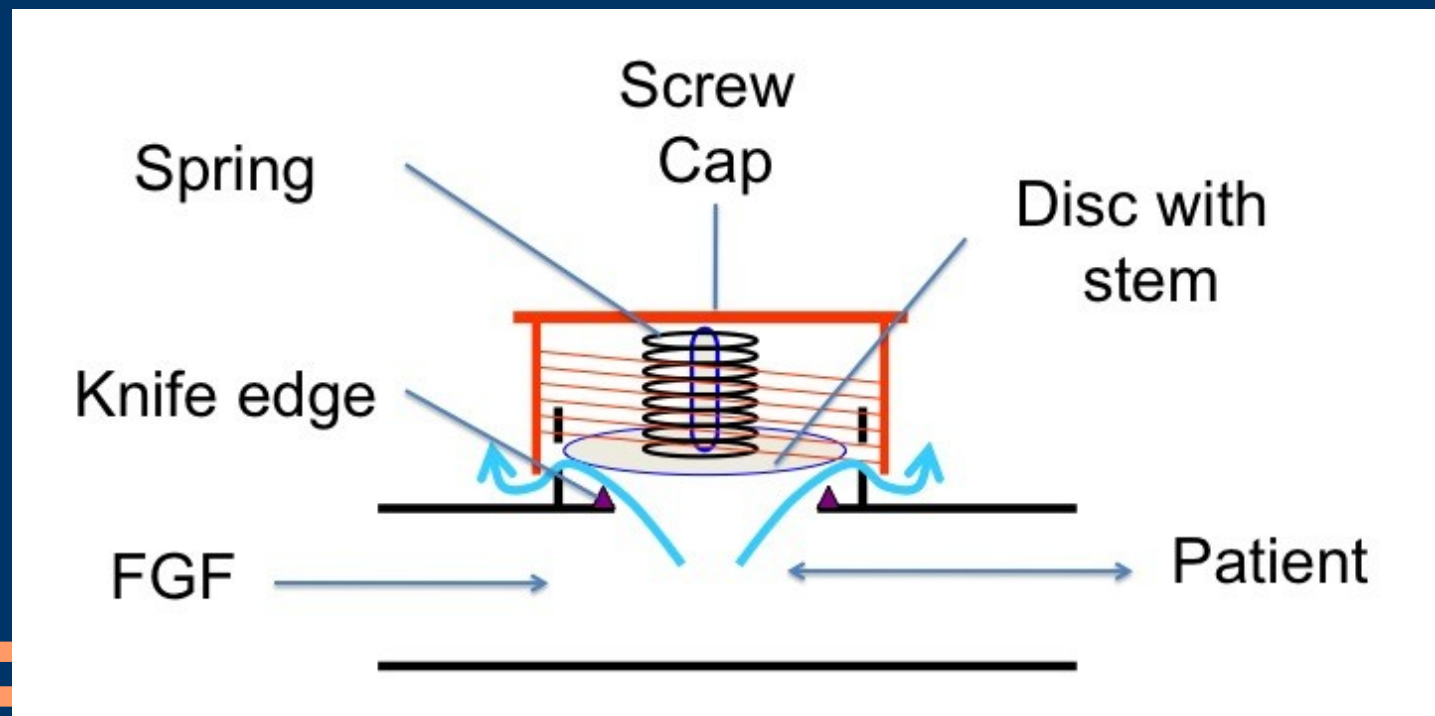

# *Dýchací okruh*

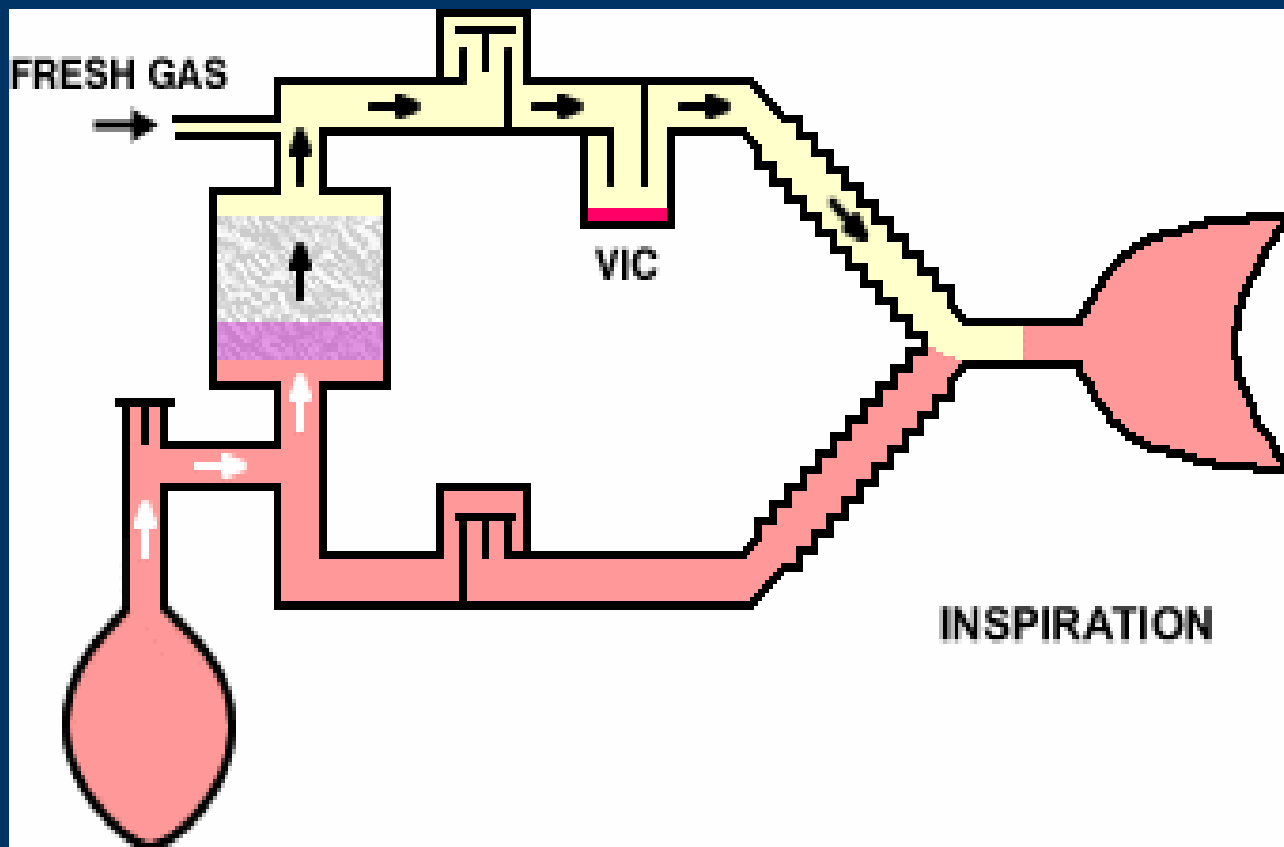

# Manometr

- tlak v manžetě tr.rourky/TS kanyly  
20 - 30 cm H<sub>2</sub>O
- tlak v manžetě LM  
do 40 cm H<sub>2</sub>O

co nejméně, aby nebyl únik  
(ověřeno poslechem krku)

---

---



# Ventilační část

- ventilátor  
(objemově řízená ventilace, (PCV)  
Vt 6 ml/kg, f dle CO<sub>2</sub>, PEEP 5, fiO<sub>2</sub> 25..100
- manuálně - vak

# Odtah anest. plynů

- přebytečné plyny mimo sál

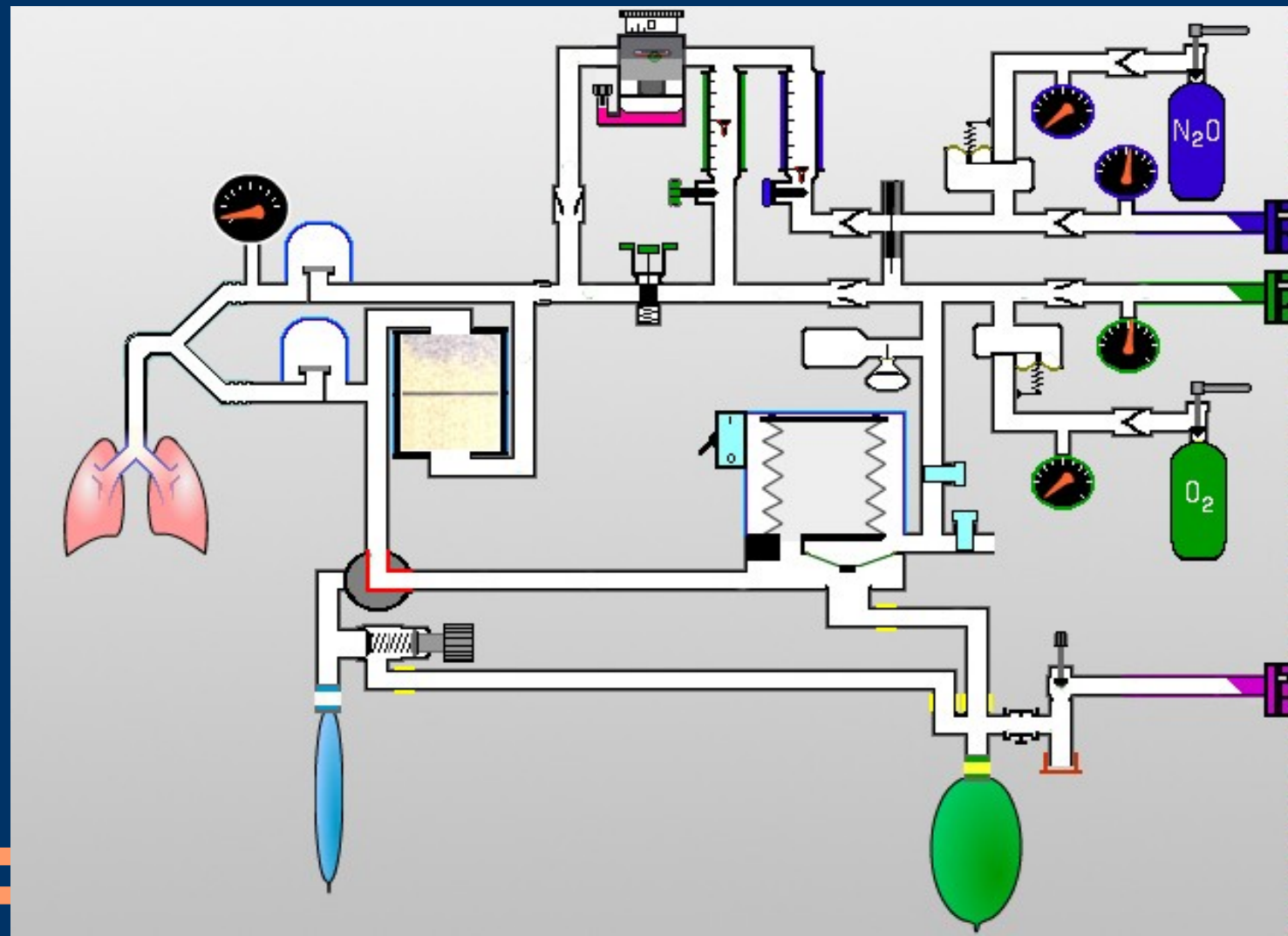

SAL 23:29



ECG  
**96** /min  
 Arrh. analys: Severe



Pleth  
**98** %

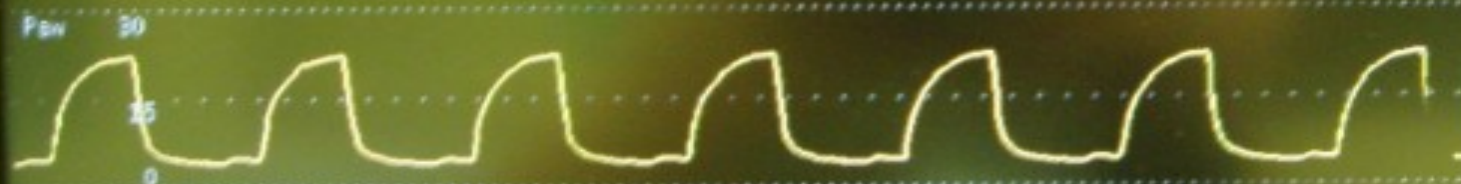

Paw  
 cmH2O  
 Ppeak **22** Adult PEEPtot **5**  
 Pplat **21**

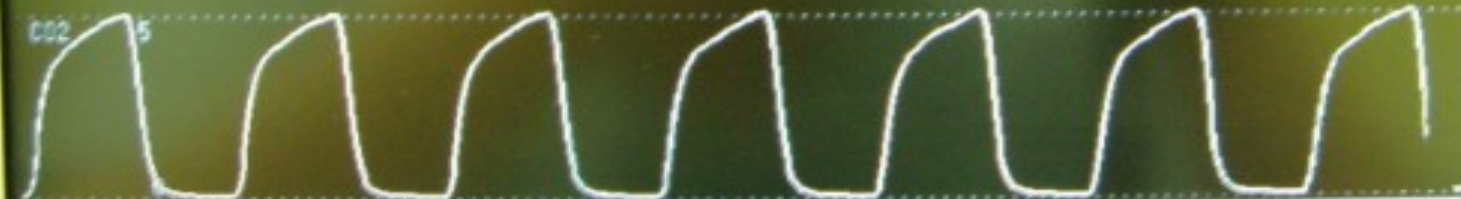

CO2  
 kPa  
 ET **5.1** FI **0.0**  
 RR **13** /min

NIBP		
mmHg	Sys	Dia
<b>122/71</b>		
Mean	(84)	0 5 min

T1	
°C	---
T1	---

Gases			
%	O2 Δ	N2O	Iso
ET	<b>58</b>	<b>29</b>	<b>0.25</b>
FI	<b>59</b>	<b>37</b>	<b>0.40</b>

MAC			
%	N2O	Iso	MAC
ET	<b>29</b>	<b>0.25</b>	<b>0.5</b>
FI	<b>37</b>	<b>0.40</b>	

# *Monitorace pacienta*

monere, "to warn"

systematicky kontrolovat

..použitím smyslů a elektronických zařízení  
opakovaně nebo kontinuálně měřit proměnné  
anestezovaného pacienta.





# Smysly klamou, ...

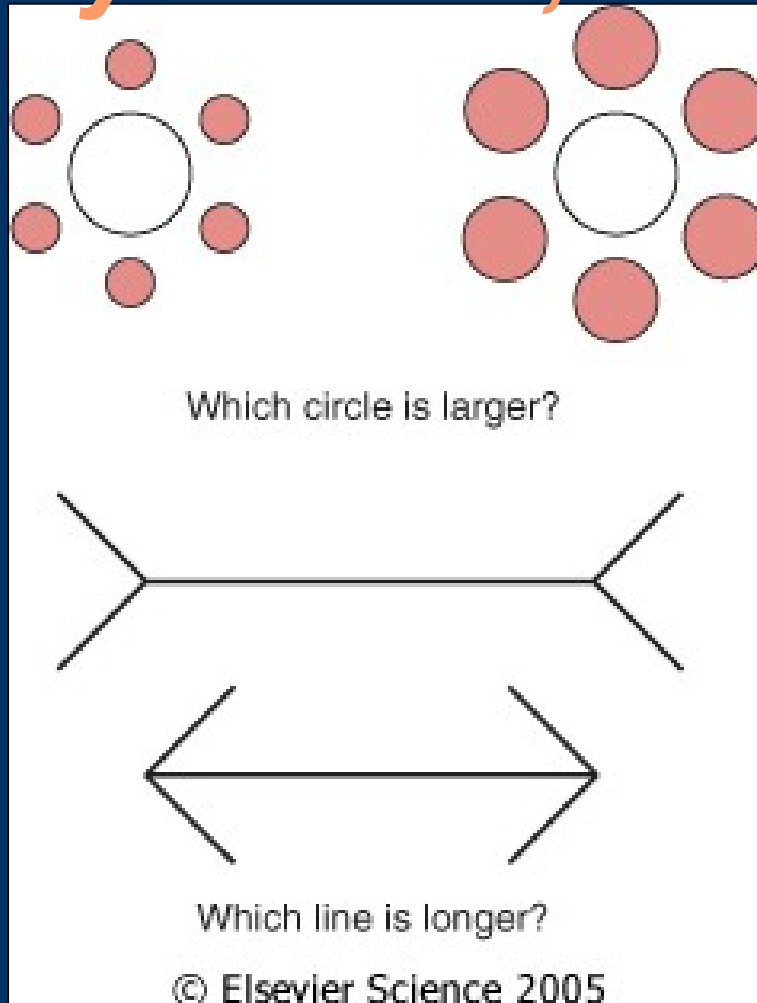

... ale bez smyslů to nejde

Figure 30-1 Optical illusions. We perceive the circles to be different sizes because we infer the size by relative dimensions. The closeness of the smaller circles makes the inner circle appear smaller, and vice versa. The lines appear to be different sizes because we use straight-line perspective to estimate size and distance. This illusion reportedly does not work in cultures where straight lines are not used. Therefore, our internal perceptions lead us to err in estimating size and length. In the same way, the internal programming of our monitors can lead us to misinterpret results.

# Monitorace

1) trvalá **přítomnost** anesteziologa/sestry

Sledovat + hodnotit kontinuálně

- Airway + Breathing

- průchodné d.cesty

- kvalita dýchání, slyšitelné fenomény, poslech

- Circulation

- kvalita a frekvence pulsu, prokrvení, barva sliznic

- hloubka anestezie ~ vědomí

- zornice, pocení, pohyb kk.

Cíl: předejít problému

---

---

# >>>> Alarm <<<<

< ?? co s ním ?? >

- všimnout si
- interpretovat = vyhodnotit
- reagovat = něco změnit
  - vypnout alarm?
  - upravit hranice alarmu?



# Fonendoskop

- + při anestezii okamžitě dostupný.
- ventilační problém  
(bronchospasmus, laryngospasmus při LM)
- SpO<sub>2</sub>, EtCO<sub>2</sub> a EKG detekují problém snadněji než kontinuální poslech.

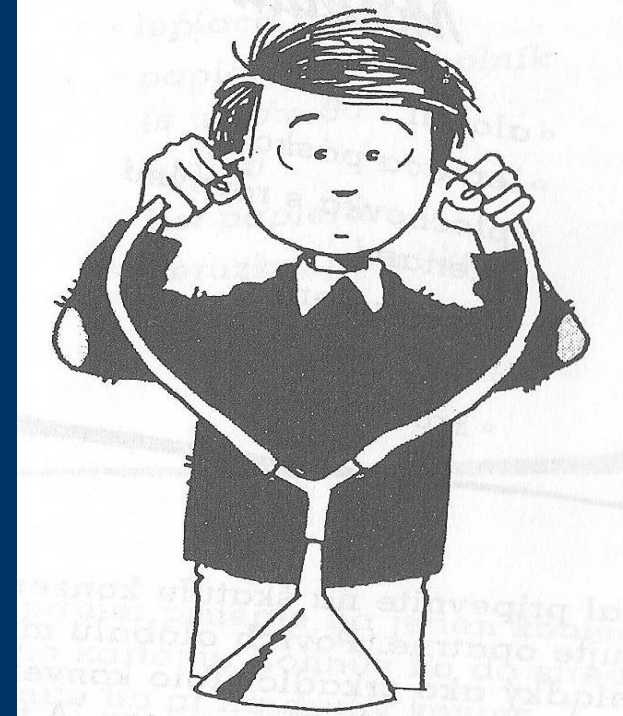

Monitorace oběhu fonendoskopem – jen není-li dostupná elektronická monitorace.

---

---

# EKG

- srdeční frekvence
- rytmus
- extrasystoly
- ST změny  
- ischemie

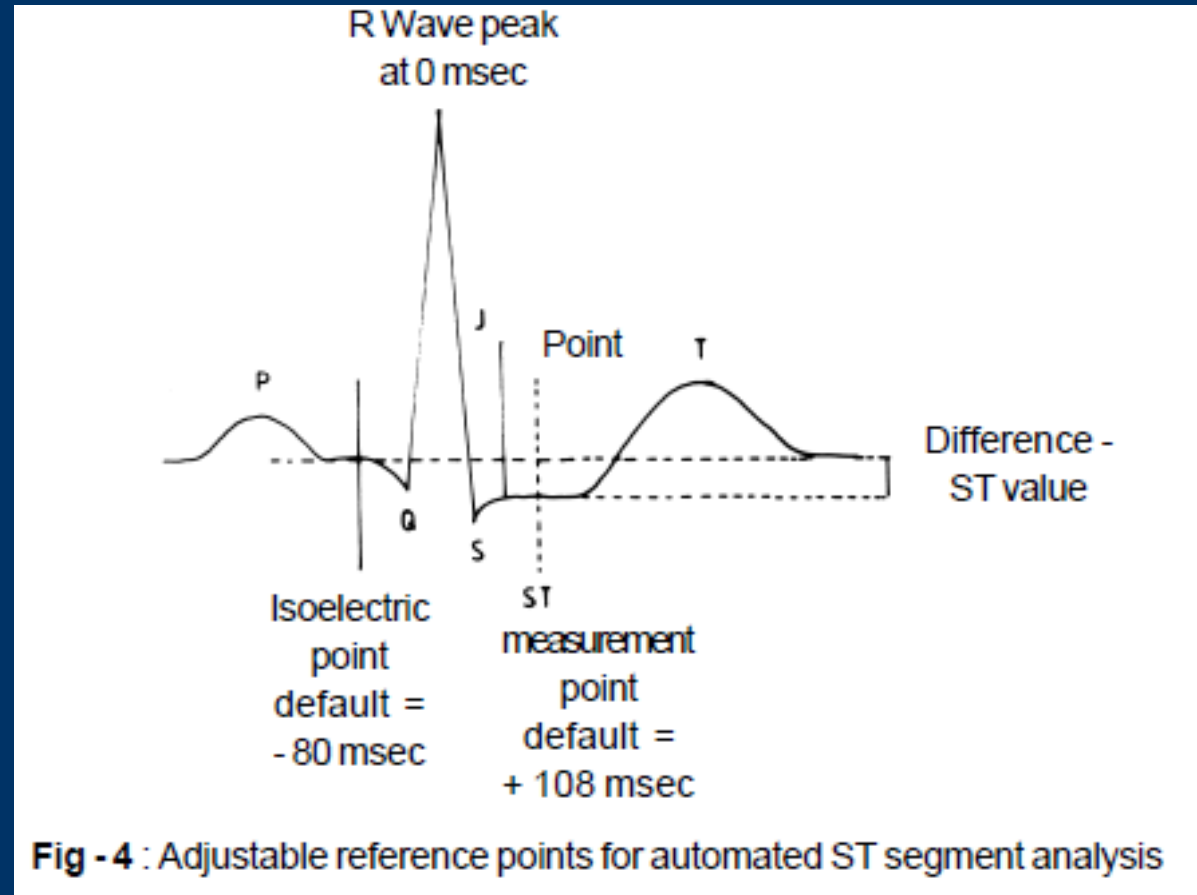

# Polohy elektrod

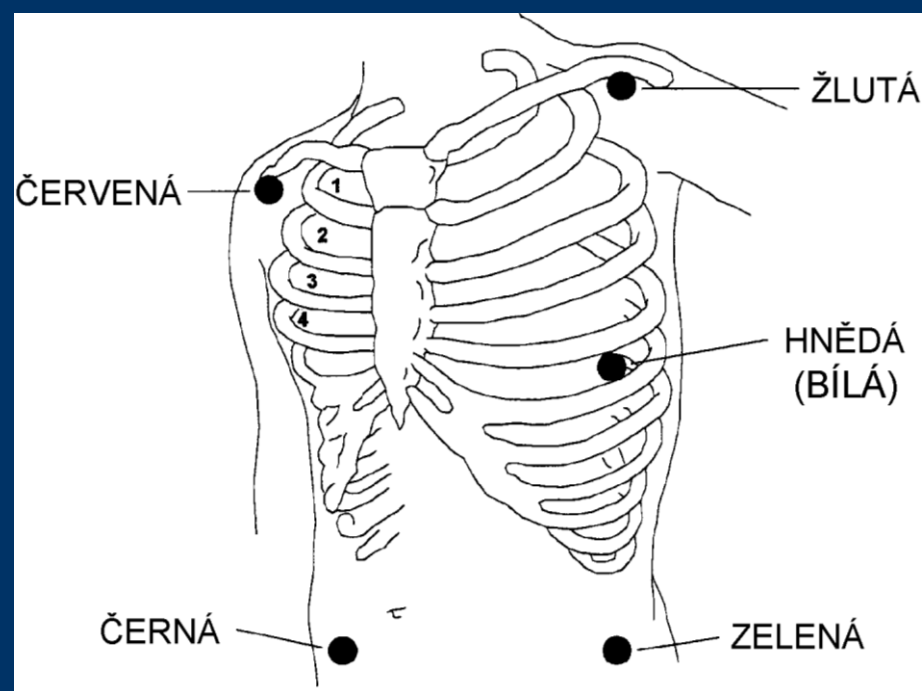
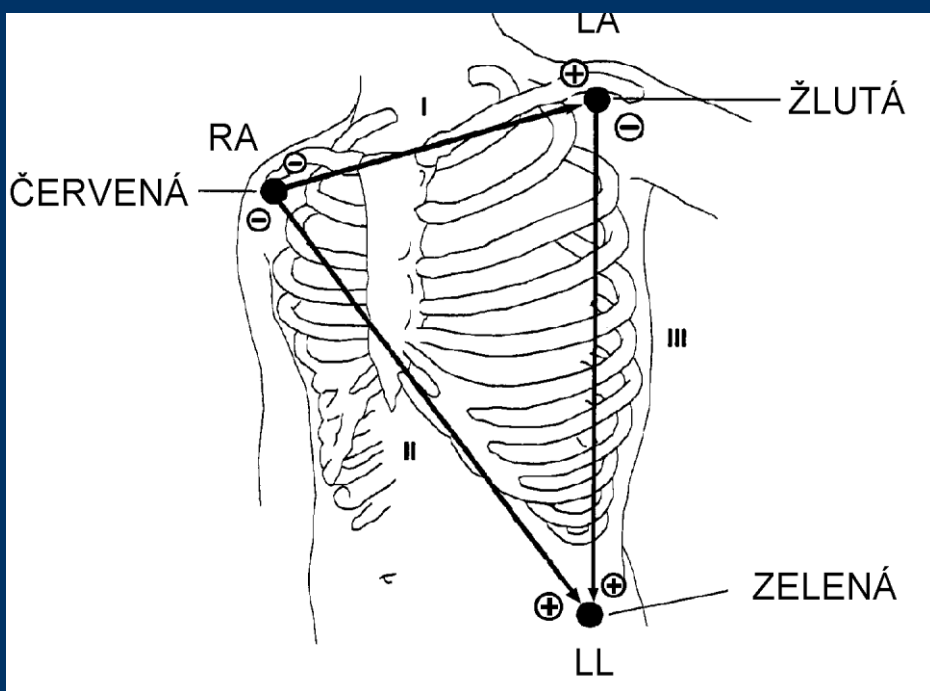

# *sinusový rytmus*



*Obr. 2a: Sinusová tachykardie*



*Obr. 2b: Sinusová bradykardie*

SVT: (není P, QRS štíhlé, pravidelná)



*Obr. 2c: Supraventrikulární tachykardie*



*fisi*

nepravidelná akce, QRS štíhlé



*Obr. 2d: Fibrilace síní - jemnovlnná*



*Obr. 2e: Fibrilace síní - hrubovlnná*

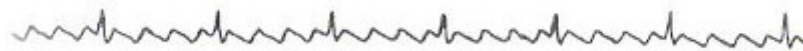

*Obr. 2f: Flutter síní*



# *komorový rytmus*



*Obr. 2g: Komorová tachykardie*

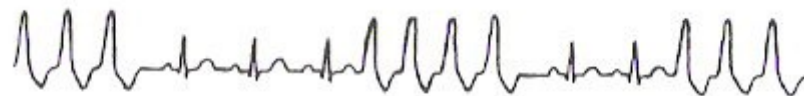

*Obr. 2h: Repetitivní komorová tachykardie*



*Obr. 2j: Preterminální stahy*



*Obr. 2k: Terminální stahy*



*Obr. 2l: Flutter komor, příp. rychlá komorová paroxyzmální tachykardie*

# elektrostimulace

spike, komplex



*Obr. 2m: Elektrostimulace „fixed rate“*

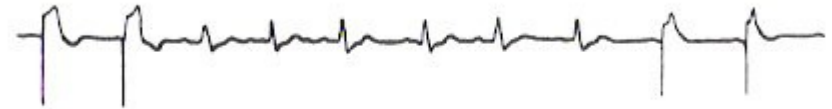

*Obr. 2n: Elektrostimulace „on demand“*

# EKG ... tepová frekvence

- 45/min nebo 150/min nebo ??

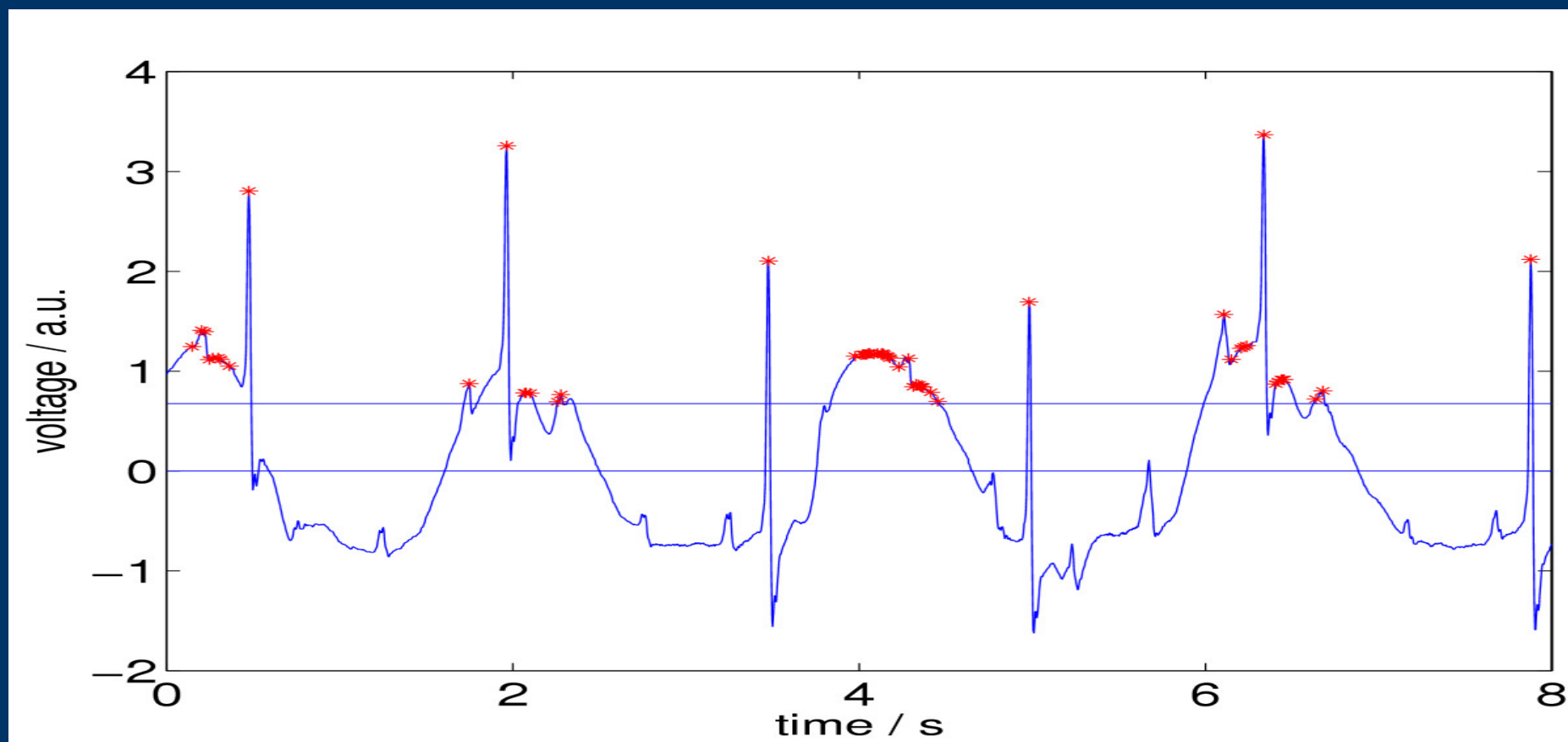

# EKG – komplikace monitorace

- elektrické rušení jinými přístroji (pálení)
- přívodná šňůra kříží EKG kabel
- kabel jako anténa (smyčka)
- defibrilační výboj (norma povoluje 10s)

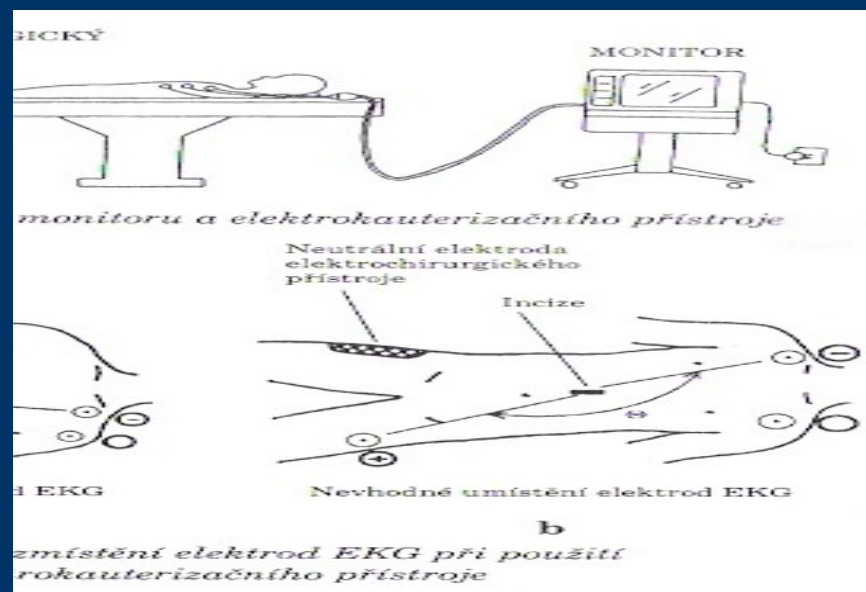

# Princip měření NIBP

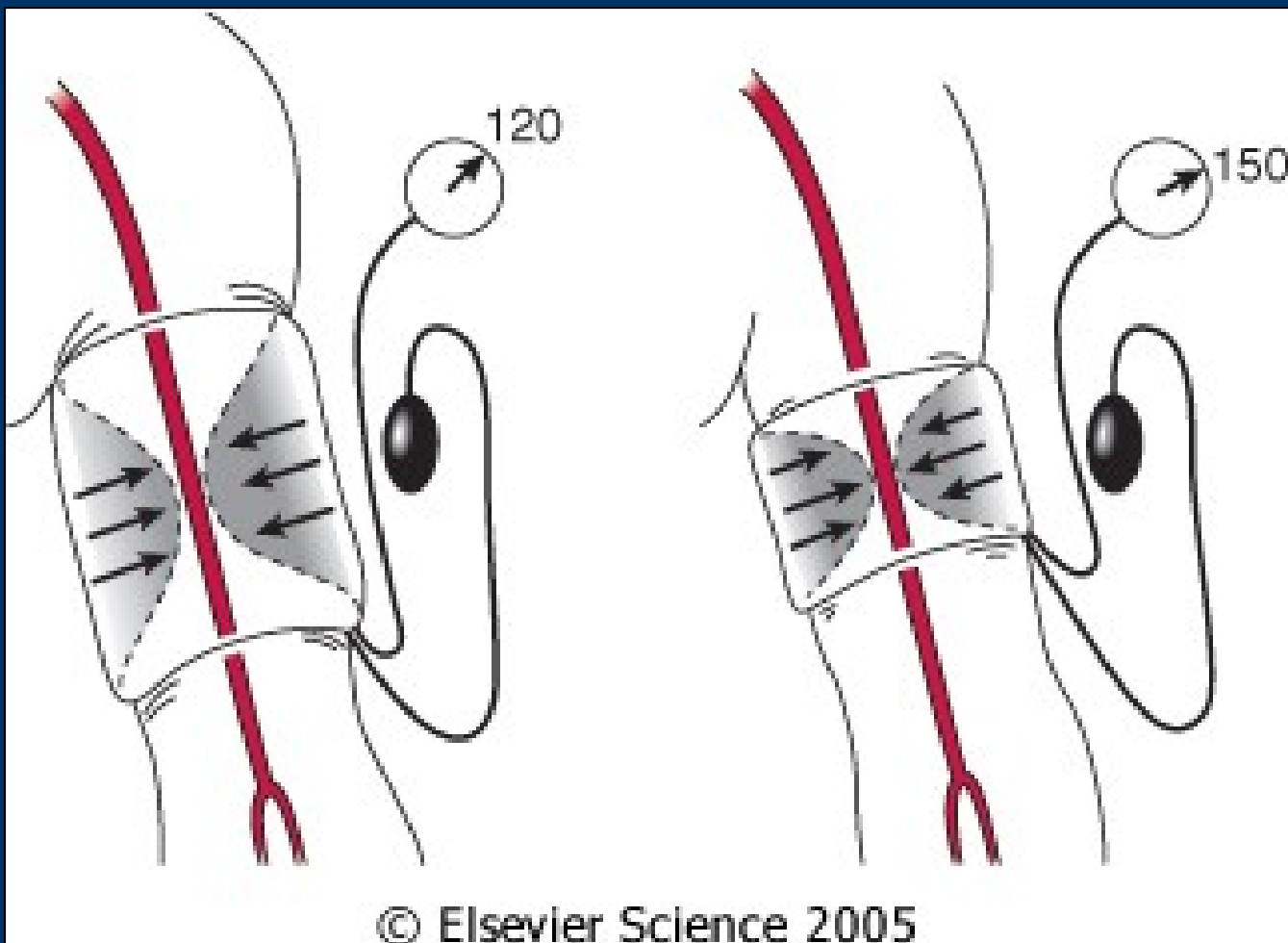

Figure 32-2 Effect of cuff size on manual blood pressure measurement. An inappropriately small blood pressure cuff yields erroneously high values for blood pressure because the pressure within the cuff is incompletely transmitted to the underlying artery.

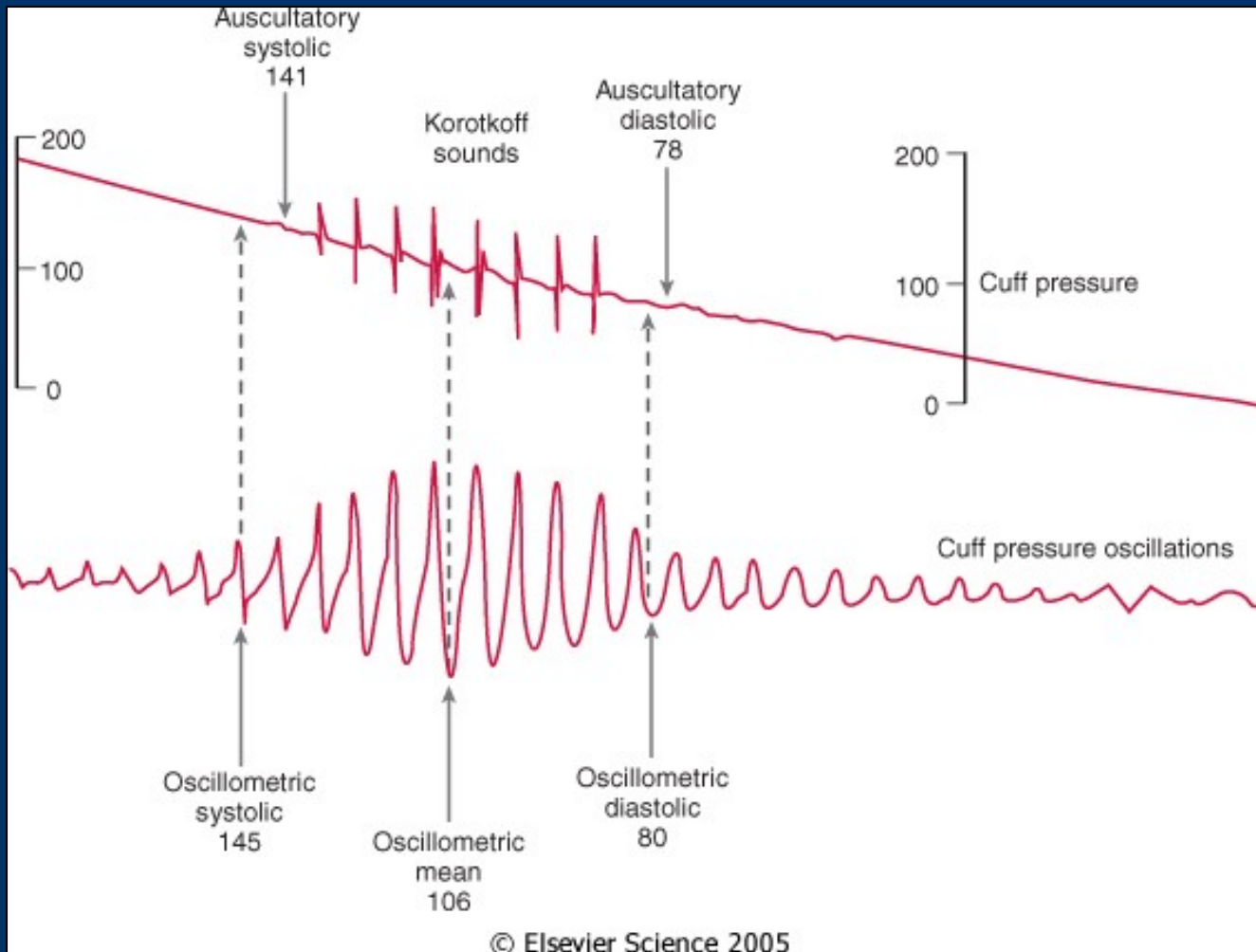

Figure 32-3 Comparison of blood pressure measurements by Korotkoff sounds and oscillometry. Oscillometric systolic blood pressure is recorded at the point where cuff pressure oscillations begin to increase, mean pressure corresponds to the point of maximal oscillations, and diastolic pressure is measured when the oscillations become attenuated. Note the correspondence between these measurements and the Korotkoff sounds that determine auscultatory systolic and diastolic pressure. (Redrawn from Geddes LA: Cardiovascular Devices and Their Applications. New York John Wiley, 1984, Fig 34-2. Reprinted by permission of John Wiley & Sons, Inc.)

# NIBP

komplikace :

- bolest
  - Petechie
  - Otok končetiny
  - Venous stasis, thrombophlebitis
  - Peripheral neuropathy
  - Compartment syndrome
- Nesnadné měření
  - třes, pohyb. aktivita
  - bradykardie < 40/min
  - obezita
  - šok - vazokonstr.
- 
-

# *IBP, kanylace arterie*

- kontinuálně, real-time
  - očekávám ovlivnění oběhu farmaký / mechanicky
  - opakované odběry krve
  - selhání NIBP
  - přídatná informace z pulzové křivky
    - Pulse Pressure Variation
- 
-



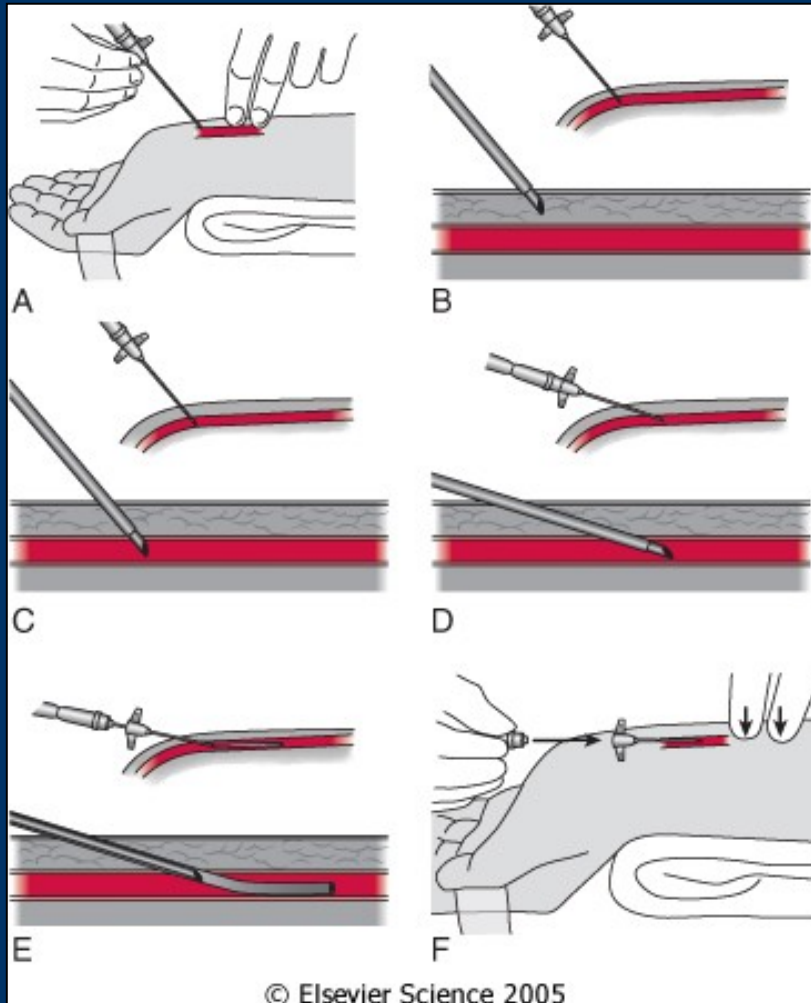
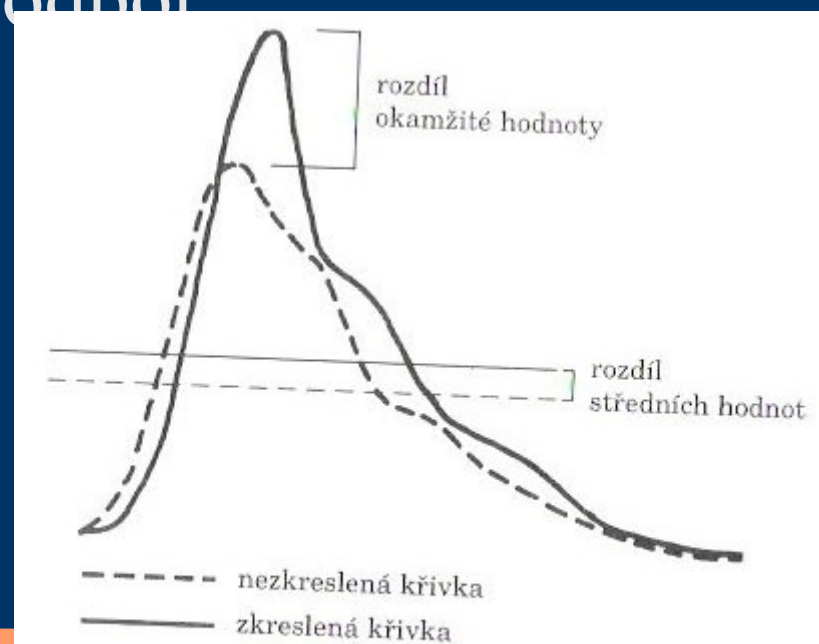
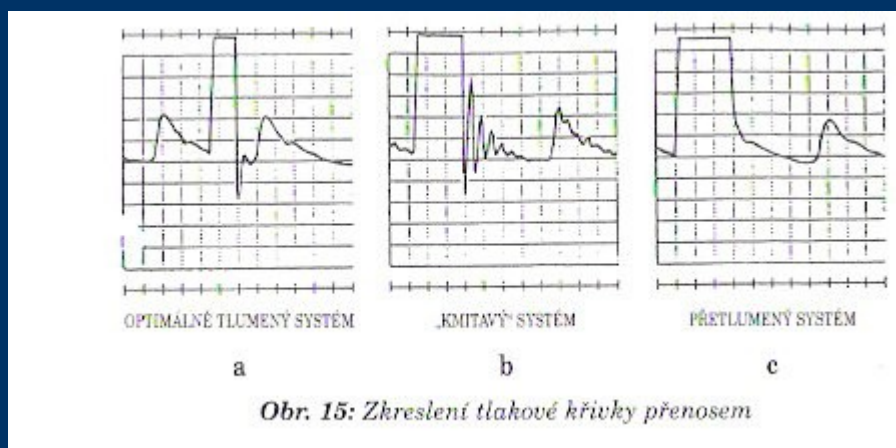

Figure 32-4 Percutaneous radial artery cannulation. A, The wrist is positioned and the artery identified by palpation. B, The catheter-over-needle assembly is introduced through the skin and advanced toward the artery. C, Entry of the needle tip into the artery is identified by the flash of arterial blood in the needle hub reservoir. D, The needle-catheter assembly is advanced at a lower angle to ensure entry of the catheter tip into the vessel. E, If blood flow continues into the needle reservoir, the catheter is advanced gently over the needle into the artery. F, The catheter is attached to pressure monitoring tubing while maintaining proximal occlusive pressure on the artery.

# Měření invazivního tlaku

- a. radialis / a. femoralis / a. brachialis
- arterie – hadička – komůrka – přetlaková manžeta
- s infuzí (trvalý proplach kanyly ml/h)
- kapalina je neztlačitelná X vzduch
- sraženina / zalomení zvyšuje odpor



# !!Alarm!! Low BP

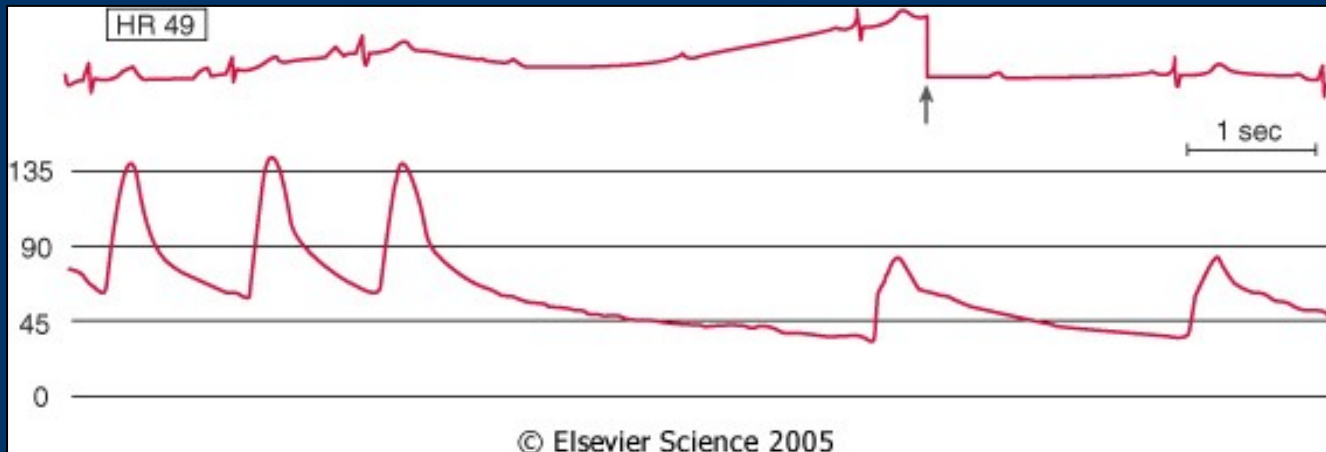
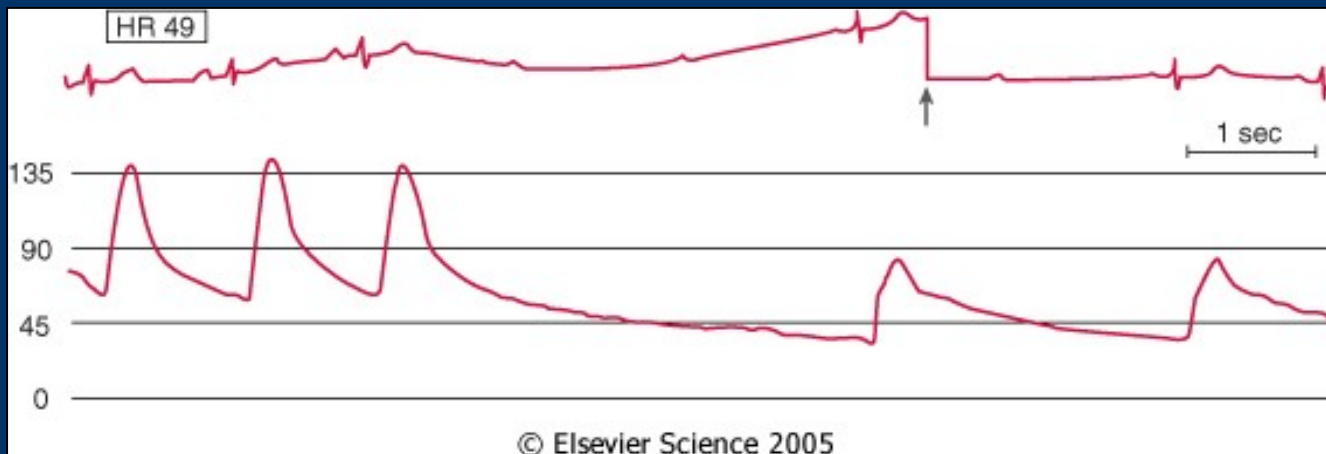

Figure 32-1 Digital heart rate (HR) displays may fail to warn of dangerous bradyarrhythmias. Direct observation of the electrocardiogram (ECG) and the arterial blood pressure traces reveals complete heart block and a 4-second period of asystole, whereas the digital display reports an HR of 49 beats/min. Note that the ECG filter (arrow) corrects the baseline drift so that the trace remains on the recording screen. (From Mark JB: Atlas of Cardiovascular Monitoring. New York, Churchill Livingstone, 1998, Fig. 13-2.)

***srdeční akce: 49/minutu,  
EKG: AV blokáda III***



# O<sub>2</sub> v těle

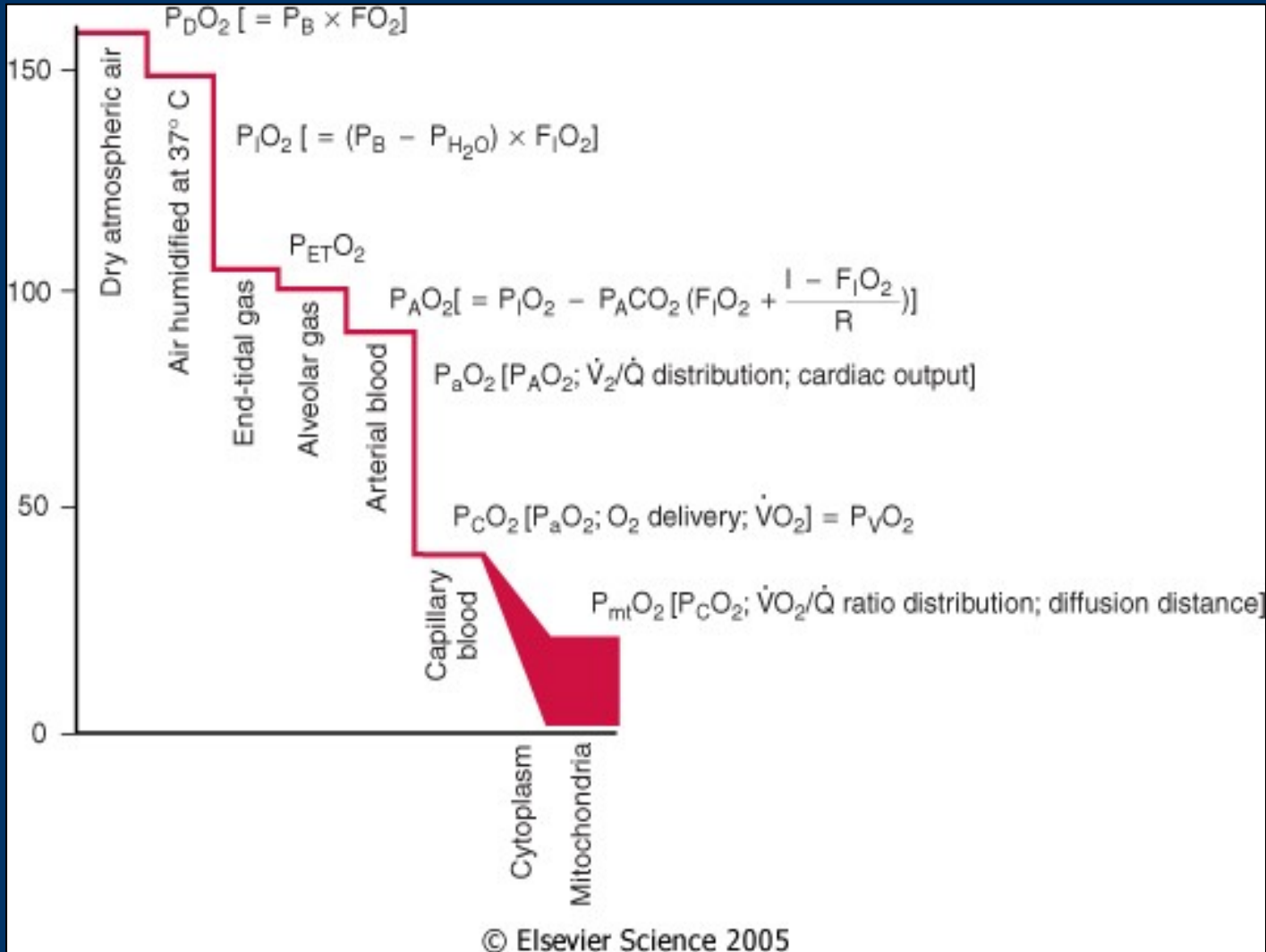

Figure 36-1 Oxygen transport cascade. A schematic view of the steps in oxygen transport from the atmosphere to the site of utilization in the mitochondrion is shown here. Approximate Po<sub>2</sub> values are shown for each step in the cascade, and factors determining those partial pressures are shown within the square brackets. There is a distribution of tissue Po<sub>2</sub> values depending on local capillary blood flow, tissue oxygen consumption, and diffusion distances. Mitochondrial Po<sub>2</sub> values are depicted as a range because reported levels vary widely. (Adapted from Nunn JF: Nunn's Applied Respiratory Physiology, 4th ed. Boston, Butterworth-Heinemann, 1993.)

# Oxygenace tkání

- monitorace O<sub>2</sub> ve vdechovaném plynu
- SpO<sub>2</sub> = saturace
- Arteriální krevní plyny = „Astrup“ - analýza krve
  - nízký srdeční výdej při dobré oxygenační fci plic

# *Saturace, SpO2 , „pulzák“*



systemová arteriální saturace hemoglobinu kyslíkem  
určená pomocí pletyzmografické pulzní oxymetrie

místa měření:

- prst
- ušní lalůček
- nosní křídlo
- ret

# 1000/s měření červenou, infrač. a „pozadí“ - světlo na sále

- Odlišit pulzující = arteriální
- nepulzující = ..... absorpci světla

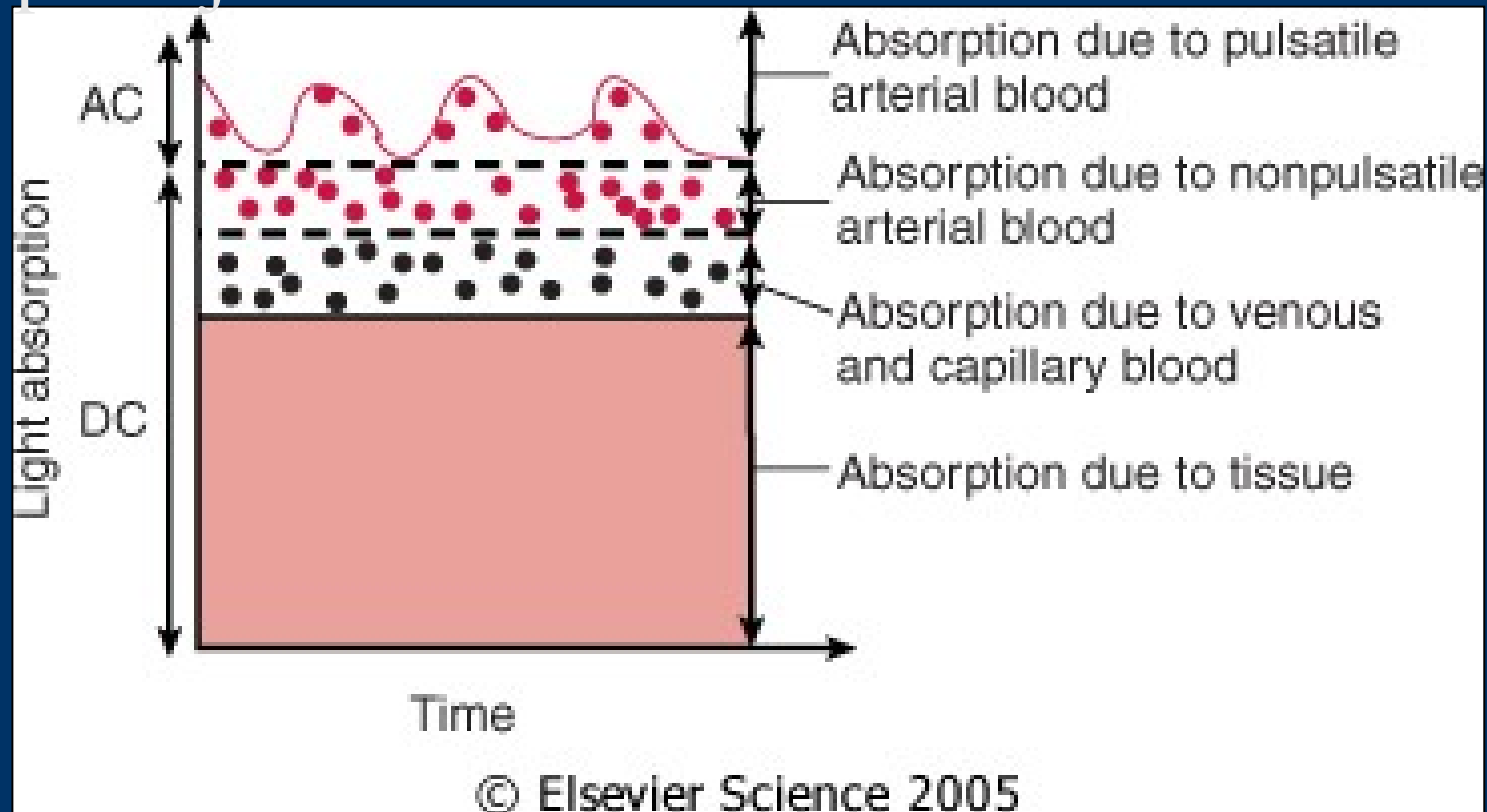

Figure 36-10 Principle of pulse oximetry. Light passing through tissue containing blood is absorbed by tissue and by arterial, capillary, and venous blood. Usually, only the arterial blood is pulsatile. Light absorption may therefore be split into a pulsatile component (AC) and a constant or nonpulsatile component (DC). Hemoglobin O<sub>2</sub> saturation may be obtained by application of Equation 19 in the text. (Data from Tremper KK, Barker SJ: Pulse oximetry. *Anesthesiology* 70:98, 1989.)



# 2 vlnové délky, 2 absorpce pro Hb a HbO<sub>2</sub>

$$S = \frac{AC_{660} / DC_{660}}{AC_{940} / DC_{940}} \quad \text{odpovídá } \% \text{ HBO}/(\text{HB}+\text{HBO})$$

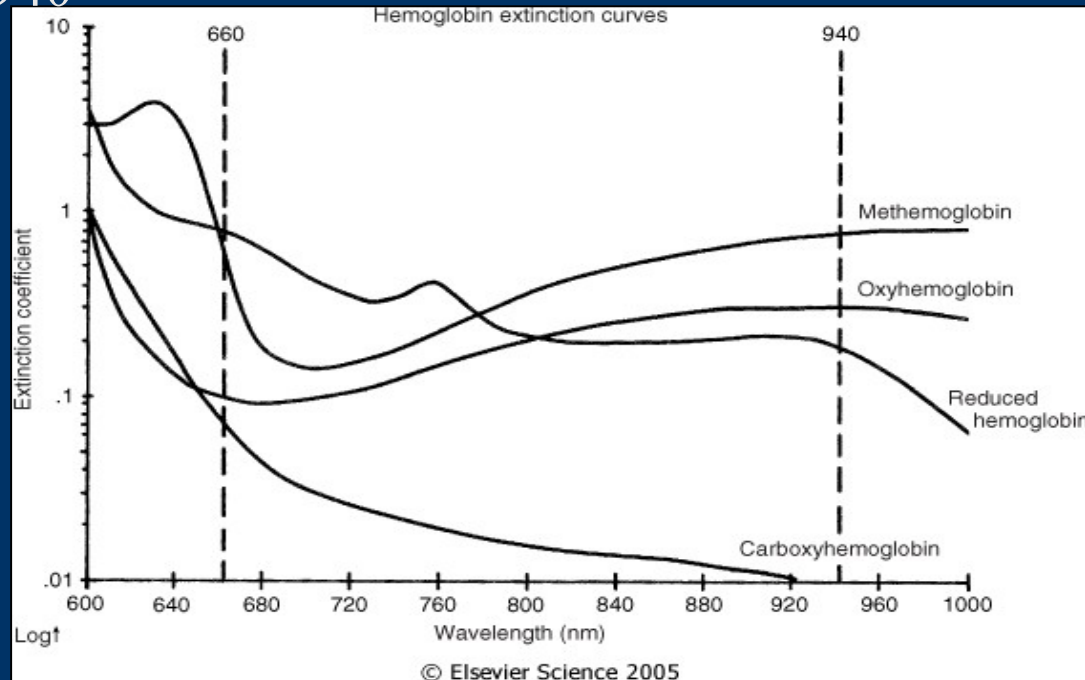

Figure 30-34 Hemoglobin extinction curves. Pulse oximetry uses the wavelengths of 660 and 940 nm because they are available in solid-state emitters (not all wavelengths are able to be emitted from diodes). Unfortunately, HbCO and HbO<sub>2</sub> absorb equally at 660 nm. Therefore, HbCO and HbO<sub>2</sub> both read as SaO<sub>2</sub> to a conventional pulse oximeter. In addition, Hbmet and reduced Hb share absorption at 660 nm and interfere with correct SaO<sub>2</sub> measurement. (Courtesy of Susan Manson, Biox/Ohmeda, Boulder, Colorado, 1986.)

# SpO2 – HbO2 - O2 ve tkáni

- od SpO2 90% níže klesá hodnota rychleji
- PaO2 klesá konstantně

nepřesnost 5%

nehraje pro život roli

!! pokles !!

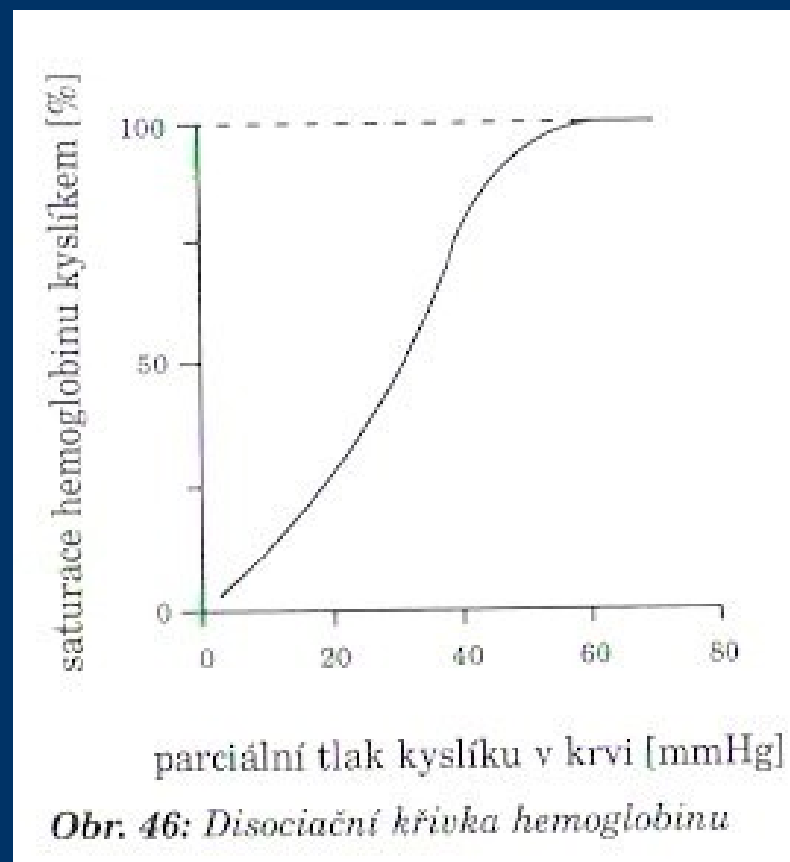

# Vliv chladu na SpO<sub>2</sub> – posun v čase

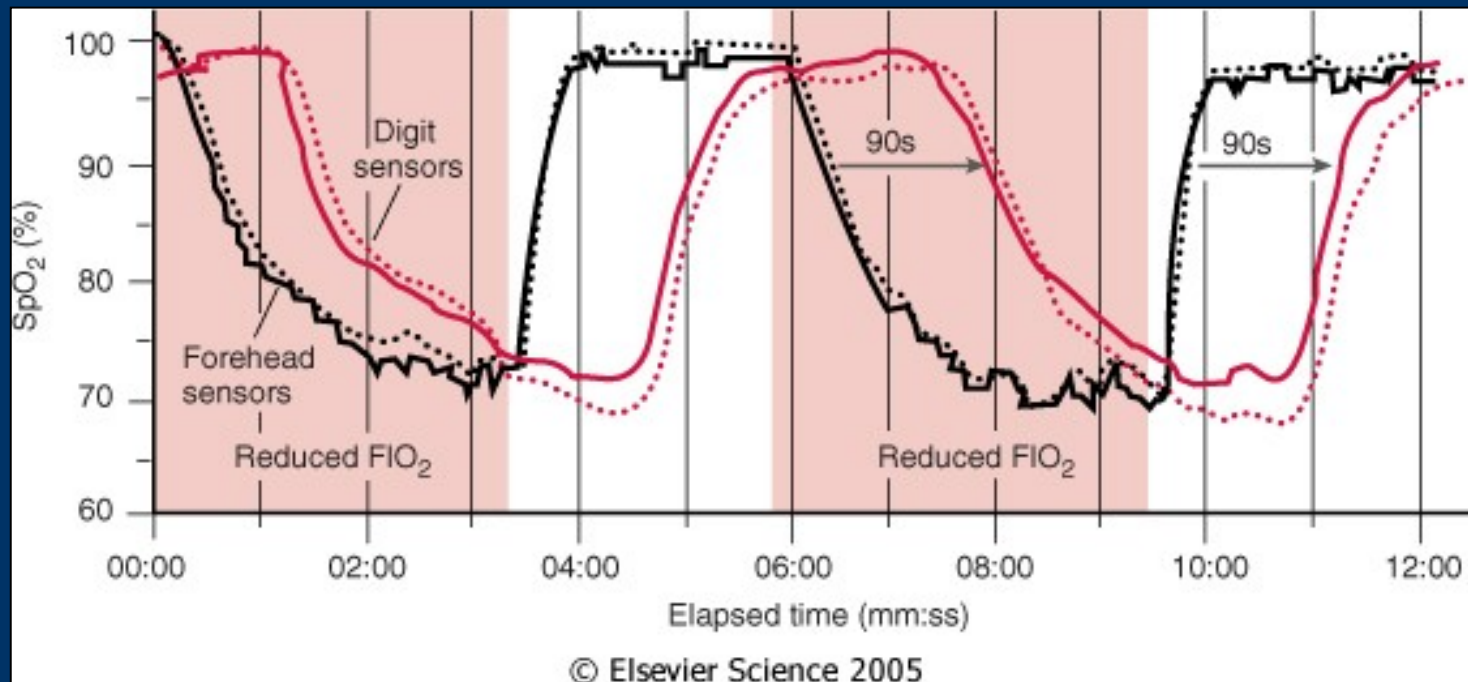
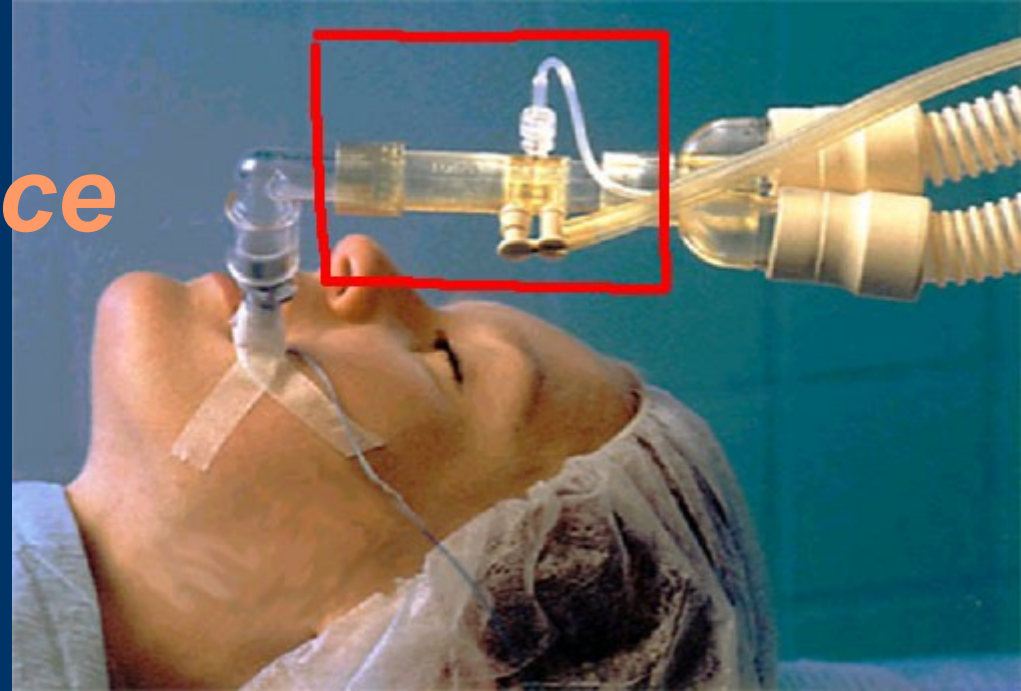

Figure 36-11 Effect of pulse oximeter probe replacement on delay from onset of hypoxemia to a drop in the measured SpO<sub>2</sub>. During cold-induced peripheral vasoconstriction in normal volunteers, the onset of hypoxemia was detected more quickly using an oximeter probe on the forehead compared with the finger. Other studies have shown a similar advantage for pulse oximeter probes placed on the ear. (From Bebout DE, Mannheimer PD, Wun C-C: Site-dependent differences in the time to detect changes in saturation during low perfusion. Crit Care Med 29:A115, 2002.)

# Monitorace ventilace

- P, V, flow;
- PV křivka
- Analýza plynů
  - O<sub>2</sub>,
  - EtCO<sub>2</sub> – kapnometrie, kapnograf
  - N<sub>2</sub>O, [%] volatilní anestetika



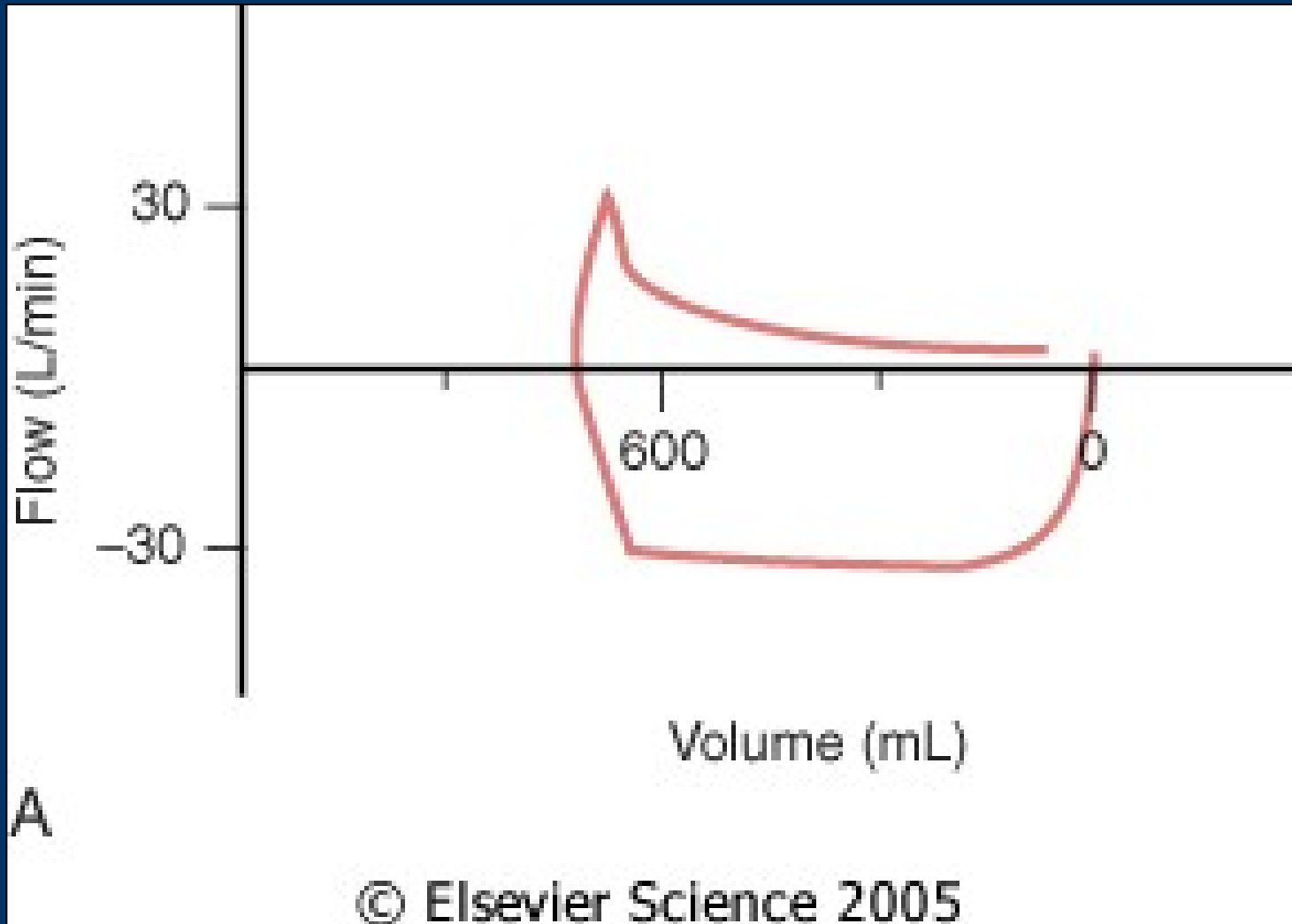

Figure 36-24 Flow (ordinate) versus volume (abscissa). A, Closed-chest positive-pressure ventilation under general anesthesia in a patient with severe airways obstruction and hyperinflation before surgery to reduce lung volume. The flow-volume curve shows inspiratory (negative) and expiratory (positive) flow on the ordinate, plotted clockwise from zero volume on the abscissa. Expiratory flow started with a sharp upward peak and then fell immediately to a low flow rate with convexity toward the volume axis, suggesting expiratory flow limitation. Expiratory flow rate was so low that inflation of the next positive-pressure breath was initiated before expiratory flow reached zero. Because expiratory flow continued up to this point, there must have been intrinsic positive end-expiratory pressure (PEEPi). B, A similar closed-check flow-volume curve after lung resection shows that the characteristic pattern of expiratory flow limitation has disappeared and that expiratory flow rate fell to zero before inflation started for the next breath (i.e., no suggestion of PEEPi). (Adapted from Dueck R: Assessment and monitoring of flow limitation and other parameters from flow/volume loops. *J Clin Monit Comput* 16:425, 2000.)

# PV křivka během kapnoperitonea

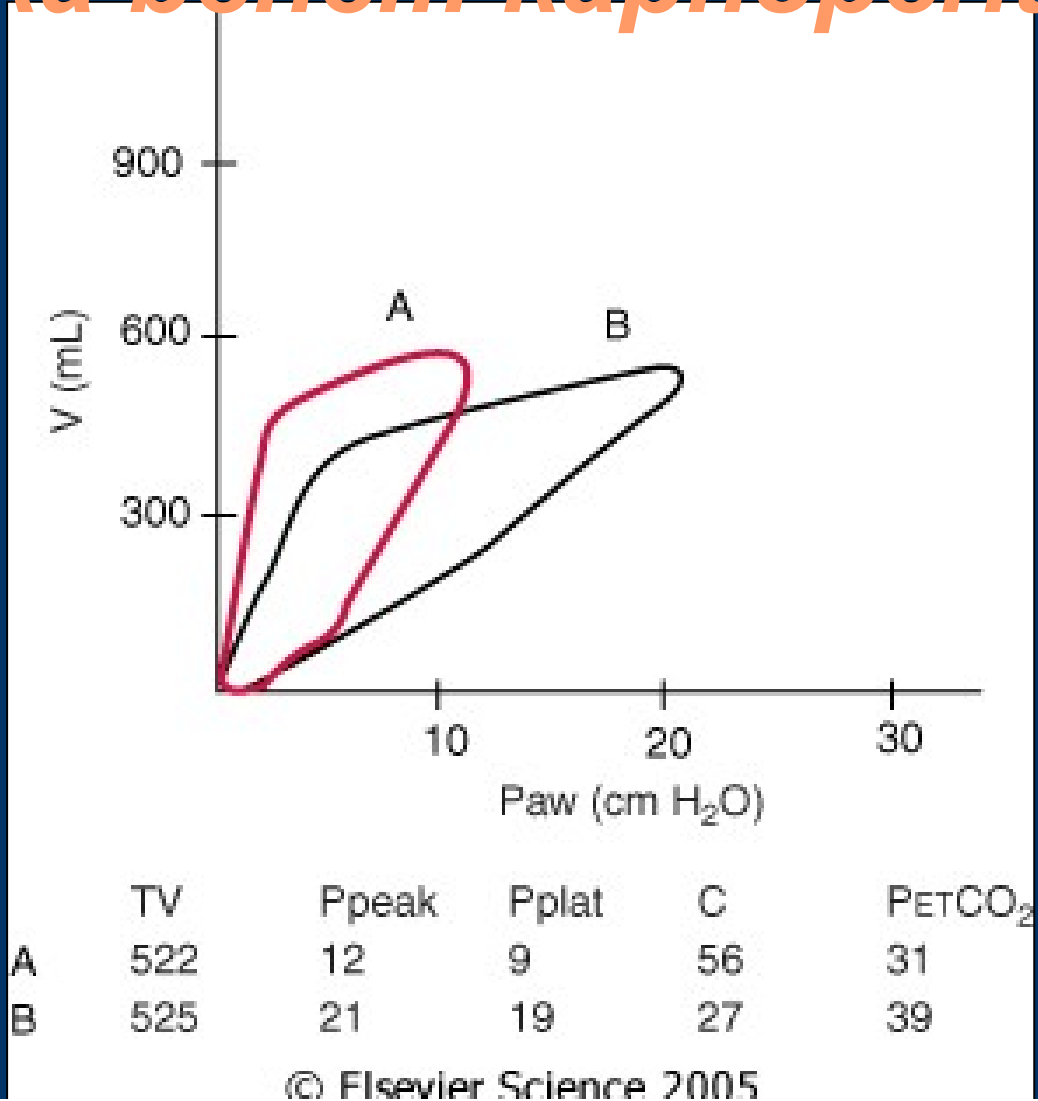

Figure 57-1 Change in total respiratory compliance during pneumoperitoneum for laparoscopic cholecystectomy. The intra-abdominal pressure was 14 mm Hg, and the head-up tilt was 10 degrees. The airway pressure (Paw) versus volume (V) curves and data were obtained from the screen of a Datex Ultima monitoring device. Curves are generated for before insufflation (A) and 30 minutes after insufflation (B). Values are given for tidal volume (TV, in mL); peak airway pressure (Ppeak, in cm H<sub>2</sub>O); plateau airway pressure (Pplat, in cm H<sub>2</sub>O); total respiratory compliance (C, in mL/cm H<sub>2</sub>O); and end-tidal carbon dioxide tension (PetCO<sub>2</sub>, in mm Hg).

# Monitorace dýchané směsi

Main-stream  
stream

jen CO<sub>2</sub>, méně přesné

1

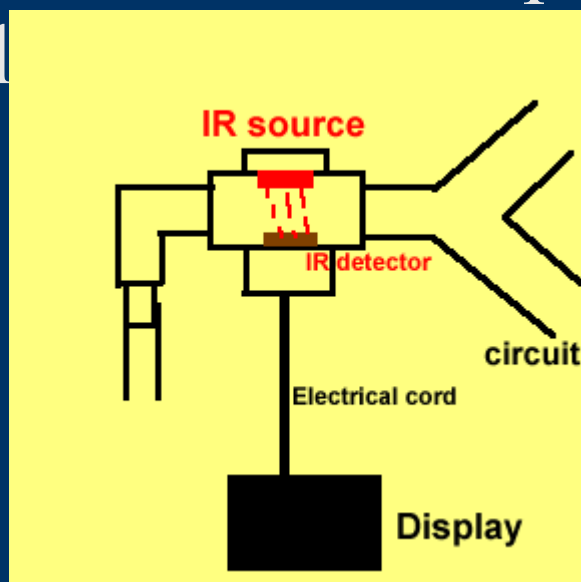

Side-

zpoždění

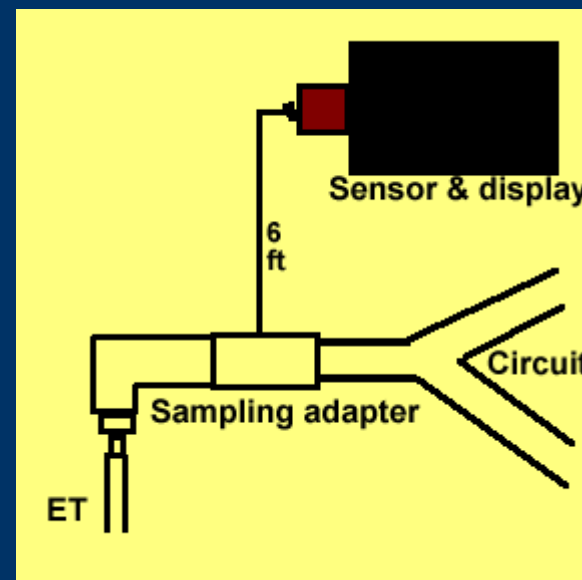

# *Monitorace dýchané směsi*

Main-stream  
stream



Side-

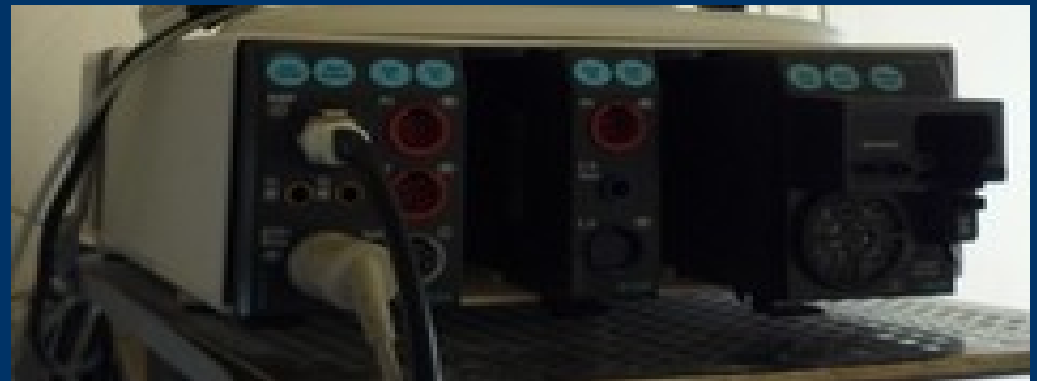



# O<sub>2</sub> je paramagnetický (side stream monitor)

Minimální f<sub>i</sub>O<sub>2</sub>: 21%  
 bezpečné 30%  
 běžně : do 60%  
 hypoxie, 100%  
 preoxygenace 100%

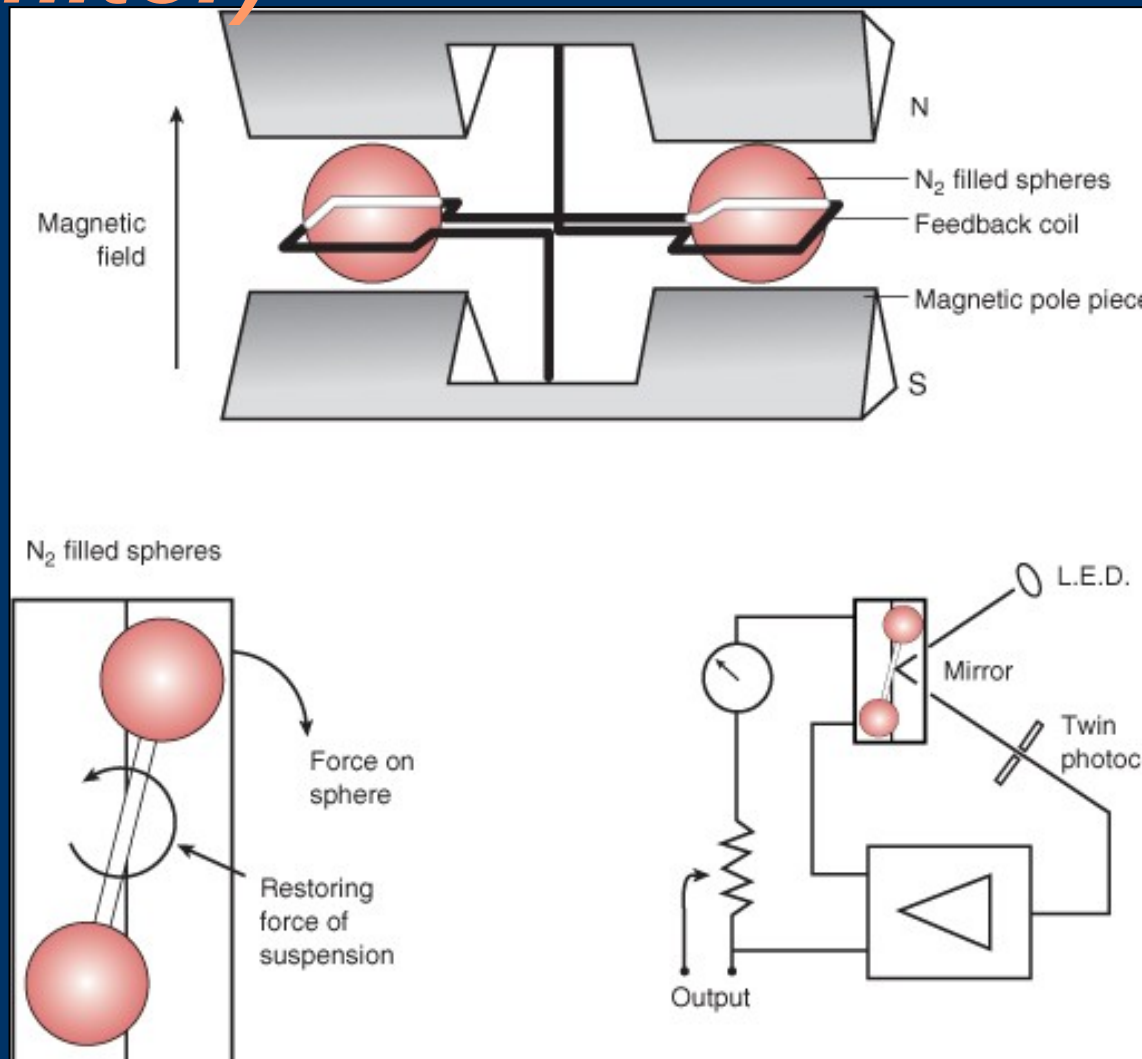
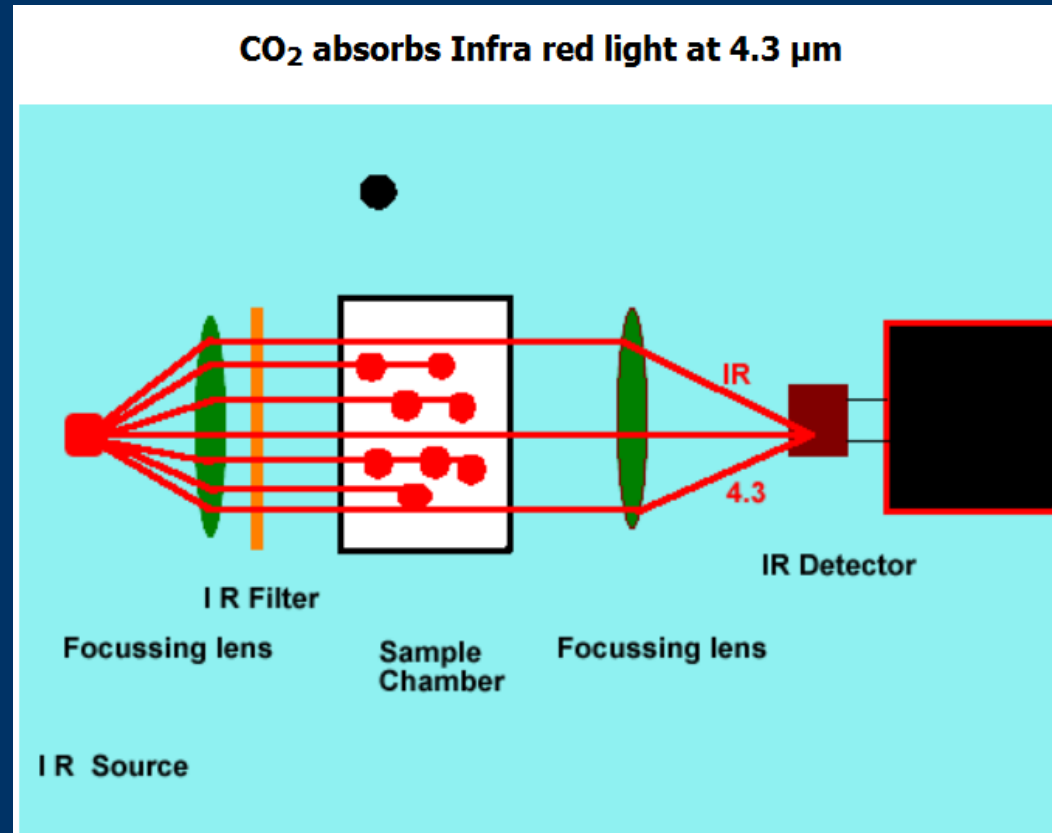

Figure 36-13 Paramagnetic oxygen analyzer. Two sealed spheres filled with nitrogen are suspended in a magnetic field. Nitrogen (N<sub>2</sub>) is slightly diamagnetic, and the resting position of the beam is such that the spheres are displaced away from the strongest portion of the field. If the surrounding gas contains oxygen, the spheres are pushed further out of the field by the relatively paramagnetic oxygen. The magnitude of the torque is related to the paramagnetism of the gas mixture and is proportional to the partial pressure of oxygen (P<sub>O<sub>2</sub></sub>). Movement of the dumbbell is detected by photocells, and a feedback current is applied to the coil encircling the spheres, returning the dumbbell to the zero position. The restoring current and output voltage are proportional to the P<sub>O<sub>2</sub></sub>. (Courtesy of Servomex Co., Norwood, MA.)

# Kapnometr, kapnograf



- Infra-red Spectrography – pohlcení záření  
<http://www.capnography.com/Physics/Physicsphysical.htm>

**CO<sub>2</sub> absorbs Infra red light at 4.3 μm**

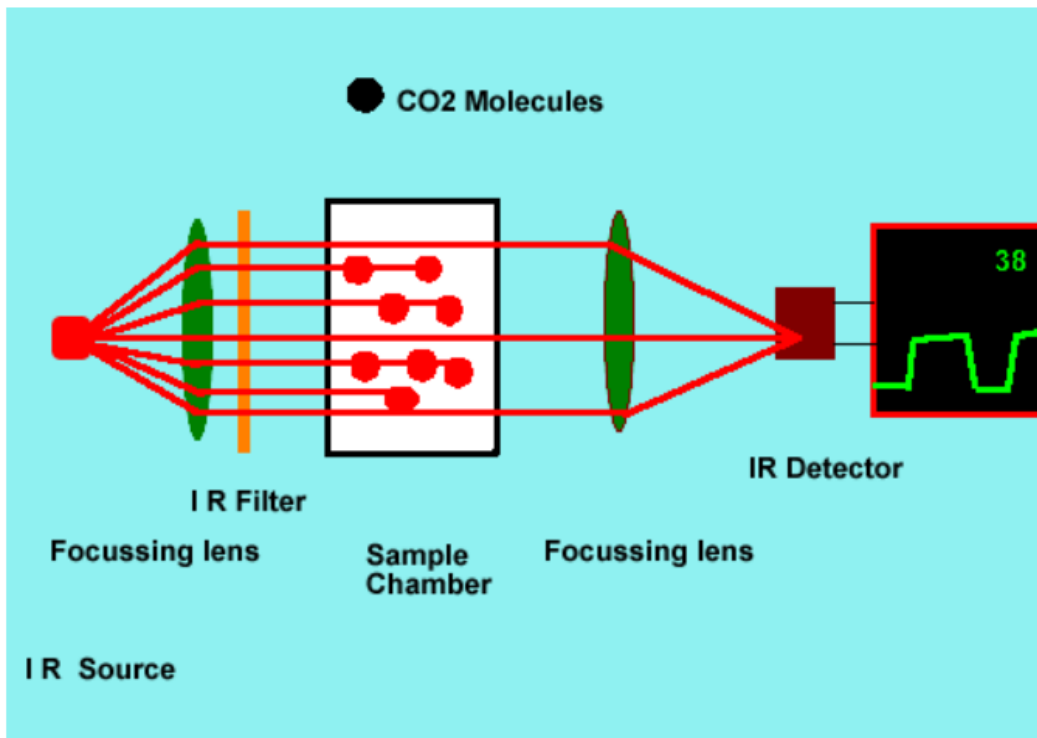

# CO<sub>2</sub> emituje IR záření

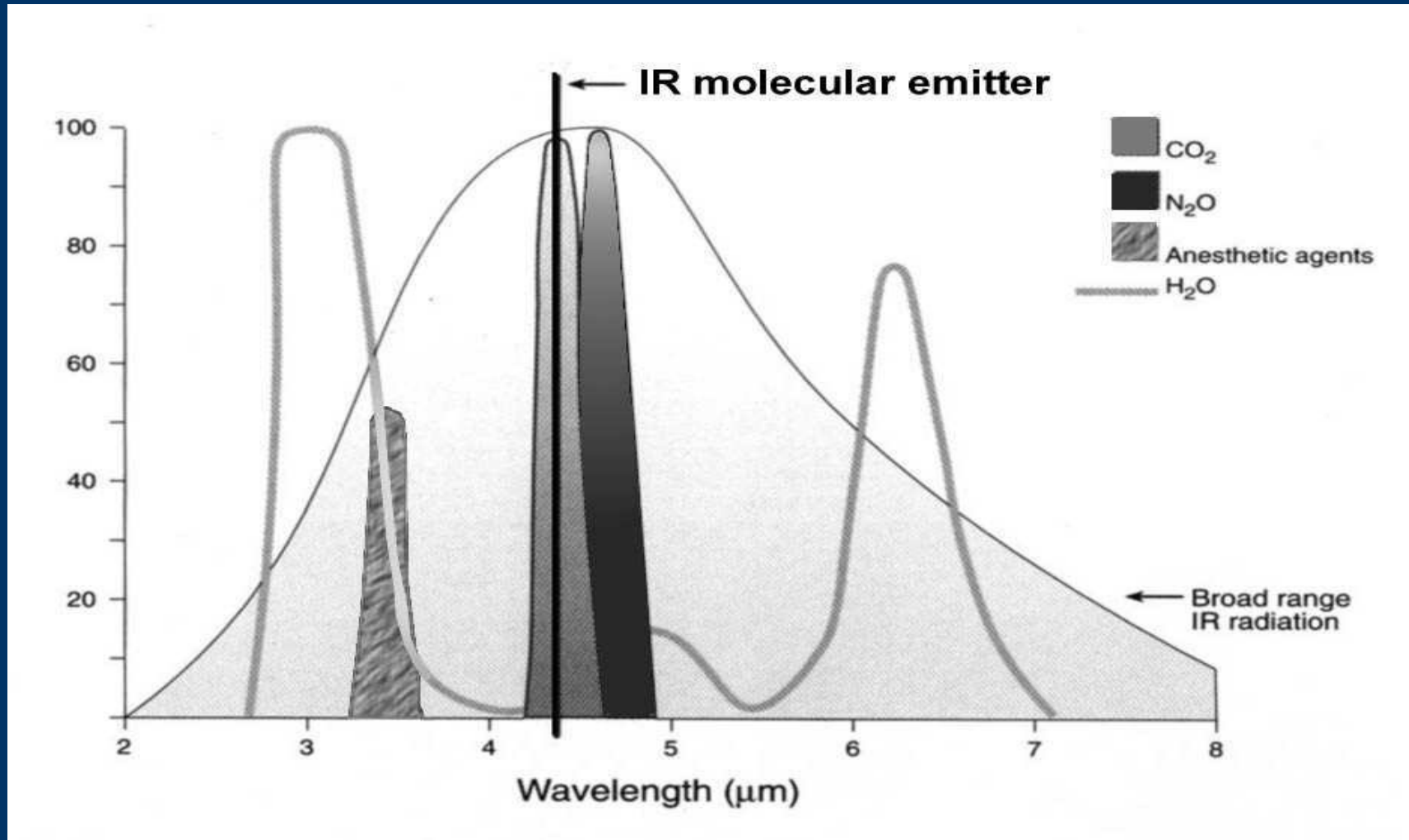

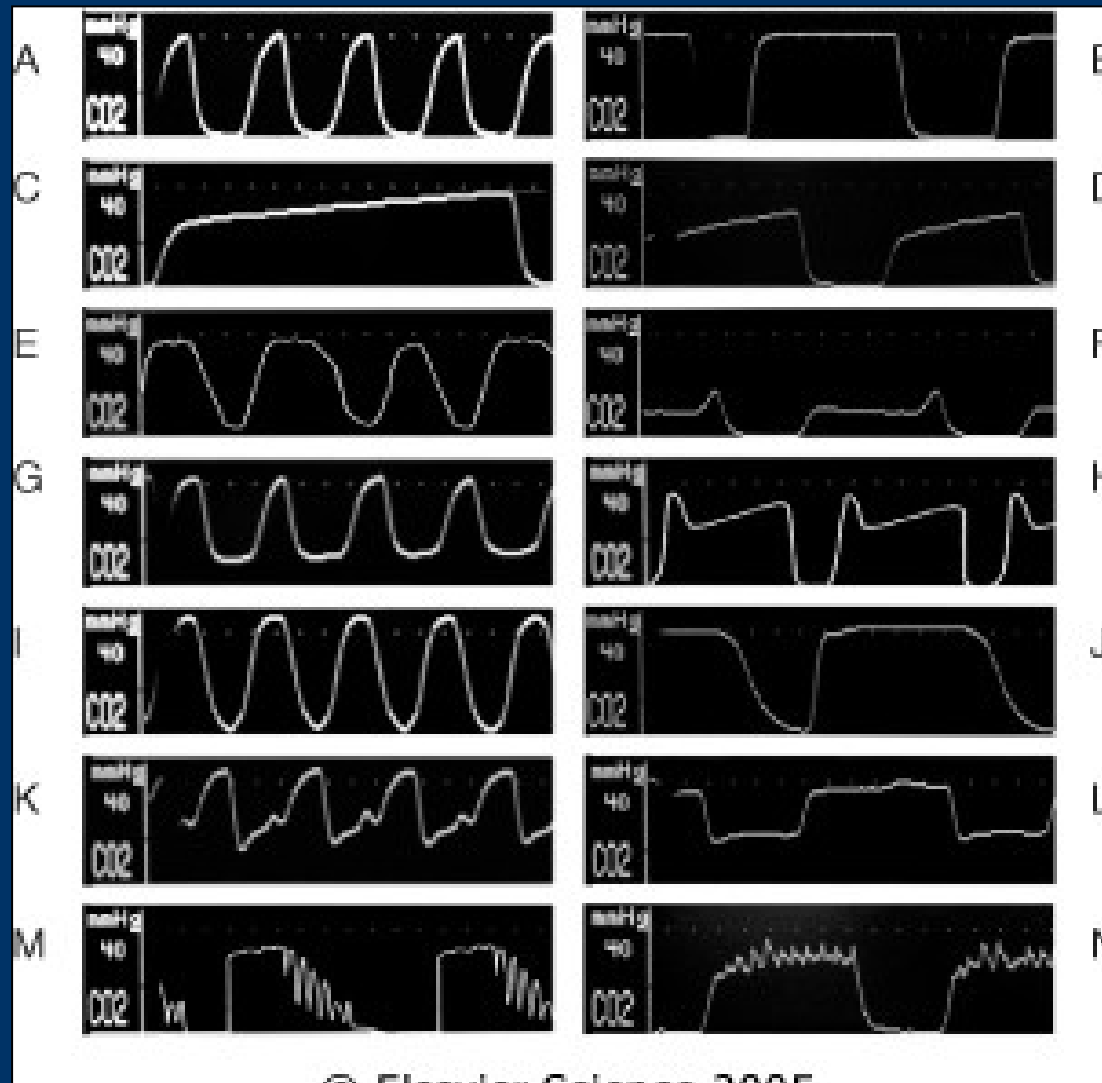
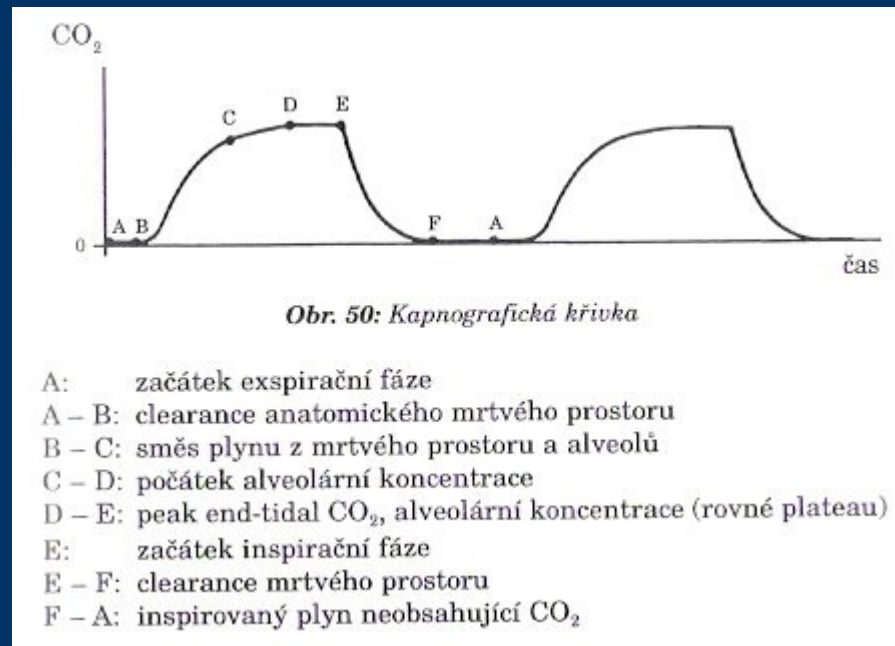
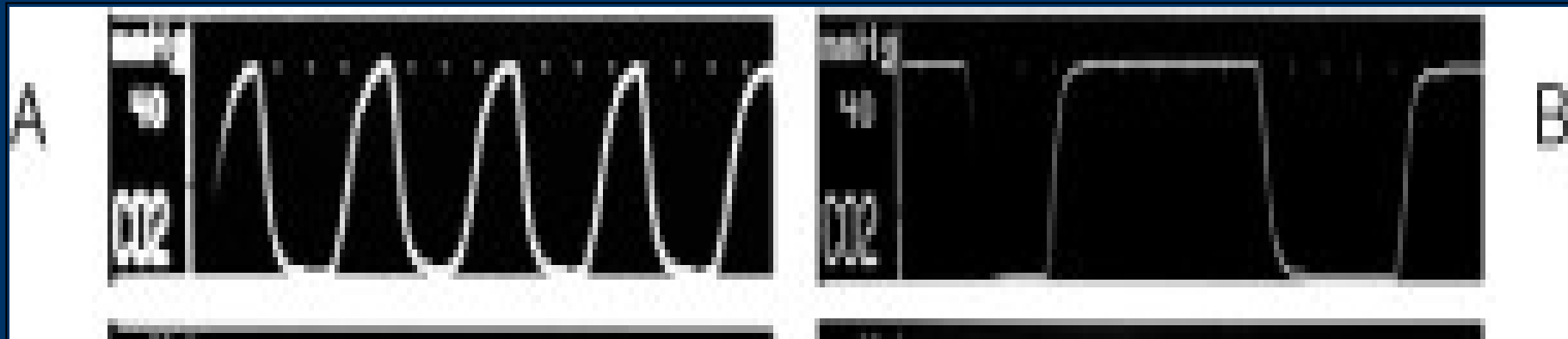

Figure 36-18 Examples of capnograph waves. A, Normal spontaneous breathing. B, Normal mechanical ventilation. C, Prolonged exhalation during spontaneous breathing. As CO<sub>2</sub> diffuses from the mixed venous blood into the alveoli, its concentration progressively rises (see Fig. 36-19). D, Increased slope of phase III in a mechanically ventilated patient with emphysema. E, Added dead space during spontaneous ventilation. F, Dual plateau (i.e. tails-up pattern) caused by a leak in the sample line.<sup>325</sup> The alveolar plateau is artifactually low because of dilution of exhaled gas with air leaking inward. During each mechanical breath, the leak is reduced because of higher pressure within the airway and tubing, explaining the rise in the CO<sub>2</sub> concentration at the end of the alveolar plateau. This pattern is not seen during spontaneous ventilation because the required increase in airway pressure is absent. G, Exhausted CO<sub>2</sub> absorbent produces an inhaled CO<sub>2</sub> concentration greater than zero. H, Double peak for a patient with a single lung transplant. The first peak represents CO<sub>2</sub> from the transplanted (normal) lung. CO<sub>2</sub> exhalation from the remaining (obstructed) lung is delayed, producing the second peak. I, Inspiratory valve stuck open during spontaneous breathing. Some backflow into the inspired limb of the circuit causes a rise in the level of inspired CO<sub>2</sub>. J, Inspiratory valve stuck open during mechanical ventilation. The "slurred" downslope during inspiration represents a small amount of inspired CO<sub>2</sub> in the inspired limb of the circuit. K and L, Expiratory valve stuck open during spontaneous breathing or mechanical ventilation. Inhalation of exhaled gas causes an increase in inspired CO<sub>2</sub>. M, Cardiogenic oscillations, when seen, usually occur with sidestream capnographs for spontaneously breathing patients at the end of each exhalation. Cardiac action causes to-and-fro movement of the interface between exhaled and fresh gas. The CO<sub>2</sub> concentration in gas entering the sampling line therefore alternates between high and low values. N, Electrical noise resulting from a malfunctioning component. The seemingly random nature of the signal perturbations (about three per second) implies a nonbiologic cause.

# Normální dýchání spont. řízené





Obr. 51a

- zakleMOVANá tracheální rourka
- závada na kapnografu

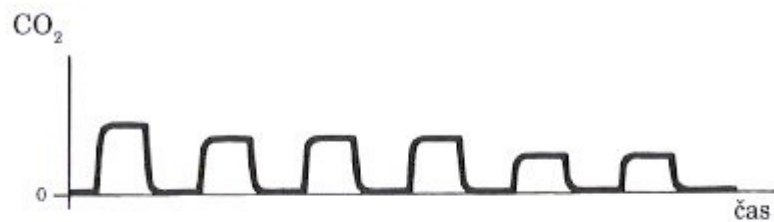

Obr. 51b

- částečná obstrukce ventilačního systému nebo únik v systému
- hyperventilace
- pokles metabolismu
- pokles tělesné teploty
- pokles plicní perfuze

c) Rychlý exponenciální pokles vydechované koncentrace  $\text{CO}_2$  (obr. 51c)

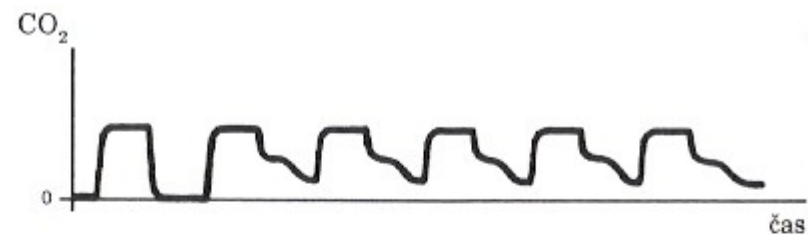

Obr. 51f

- saturovaný  $\text{CO}_2$  absorbér
- kondenzace vody v analyzátoru
- chyba kalibrace
- zpětné vdechování objemu mrtvého prostoru
- vadná expirační chlopeč

# obstrukce d.c.

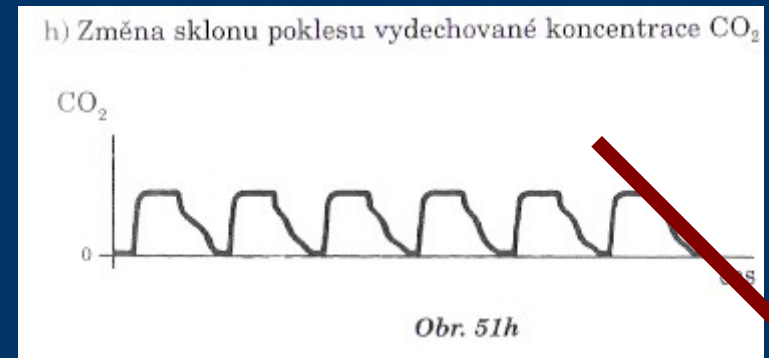
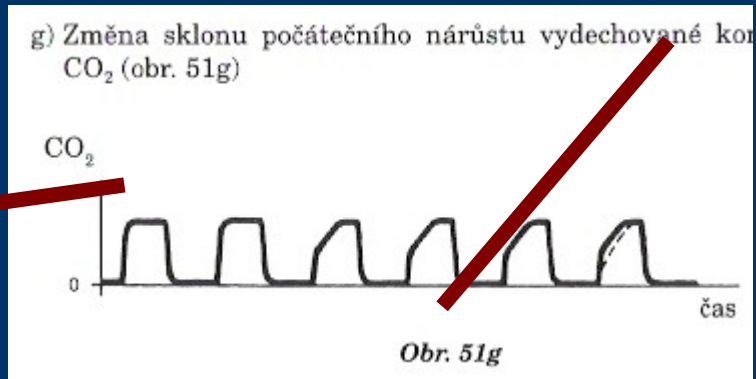

expirium

inspirium



zdravé plíce,  
alveoly  
vyprázdněny  
současně

Různá ventilace  
alveolů  
nejprve vyprázdněny  
dobře ventilované  
pak špatně ventilované

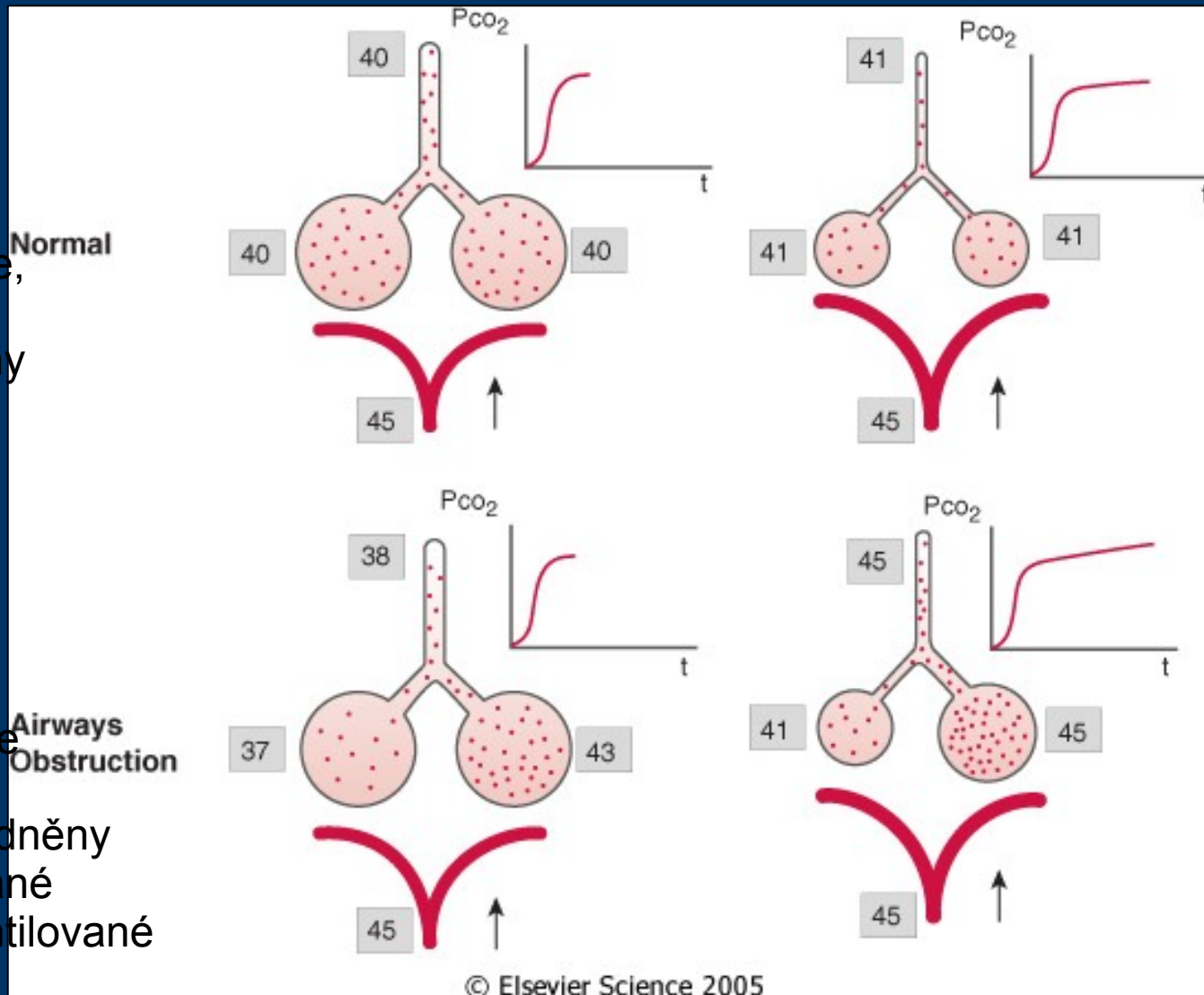

© Elsevier Science 2005

Figure 36-19 Mechanisms of airways obstruction producing an upsloping phase III capnogram. In a normal, healthy person (upper panel), there is a narrow range of  $\dot{V}_A/\dot{Q}$  ratios with values close to 1. Gas exchange units therefore have similar  $P_{CO_2}$  and tend to empty synchronously, and the expired  $P_{CO_2}$  remains relatively constant. During the course of exhalation, the alveolar  $P_{CO_2}$  slowly rises as  $CO_2$  continuously diffuses from the blood. This causes a slight increase in  $P_{CO_2}$  toward the end of expiration, and this increase can be pronounced if the exhalation is prolonged (see Fig. 36-18C). In a patient with diffuse airways obstruction (lower panel), the airway pathology is heterogeneous, with gas exchange units having a wide range of  $\dot{V}_A/\dot{Q}$  ratios. Well-ventilated gas exchange units, with gas containing a lower  $P_{CO_2}$ , empty first; poorly ventilated units, with a higher  $P_{CO_2}$ , empty last. In addition to the continuous rise in  $P_{CO_2}$  mentioned previously, there is a progressive increase caused by asynchronous exhalation.

# CO<sub>2</sub> při kapnoperitoneu

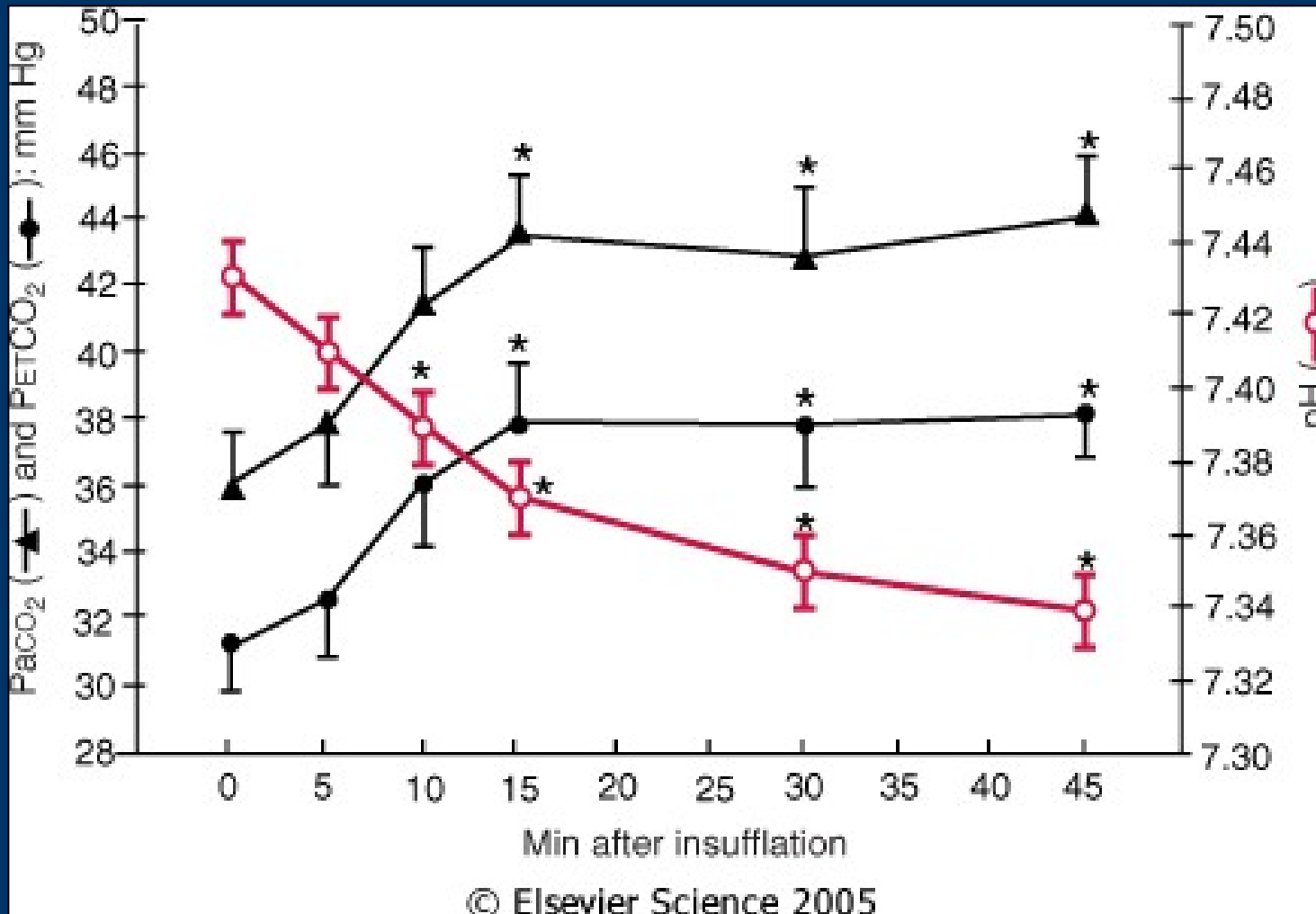

Figure 57-2 Ventilatory changes (pH, Paco<sub>2</sub>, and PetCO<sub>2</sub>) during CO<sub>2</sub> pneumoperitoneum for laparoscopic cholecystectomy. For 13 American Society of Anesthesiologists (ASA) class I and II patients, minute ventilation was kept constant at 100 mL/kg/min with a respiratory rate of 12 per minute during the study. Intra-abdominal pressure was 14 mm Hg. Data are given as the mean  $\pm$  SEM. \*, P < .05 compared with time 0.

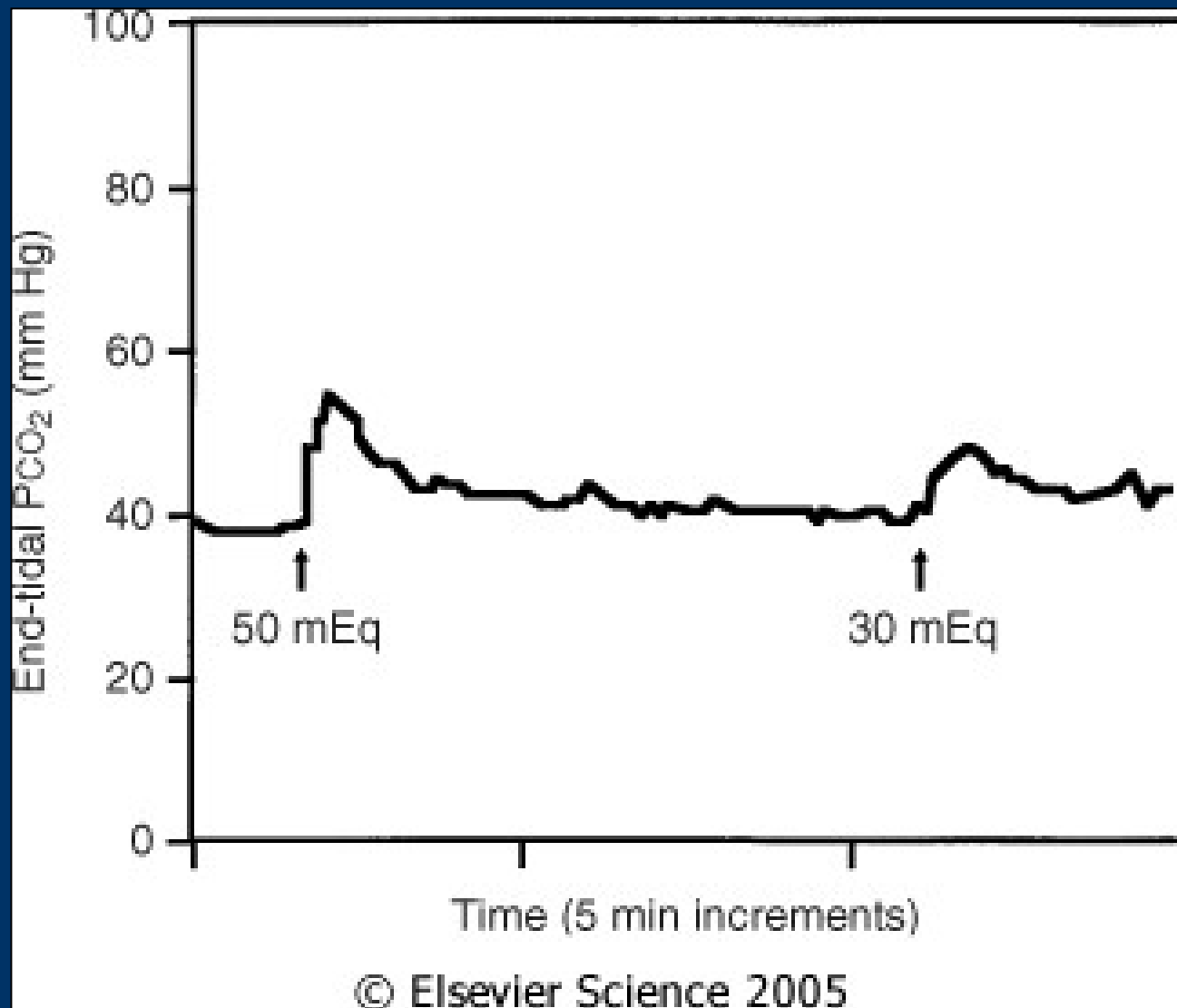

Figure 36-20 The effect of NaHCO<sub>3</sub> administration on end-tidal Pco<sub>2</sub>. A continuous tracing of end-tidal Pco<sub>2</sub> is shown as a function of time. Intravenous administration of 50 mEq followed by 30 mEq of NaHCO<sub>3</sub> results in an abrupt increase in expired CO<sub>2</sub> because of neutralization of bicarbonate by hydrogen ions.

# Kapnograf

Náhlý pokles na 0:

- zaklemovaná, zalomená trach.rourka
- porucha kapnografu

Postupný pokles:

- částečná obstrukce
- hyperventilace
- pokles metabolismu
- pokles perfuze plic

Nulové etCO<sub>2</sub>

- intubace do jícnu
- 
-

# *Monitorace tělesné teploty*

- u výkonů delších 60 minut
- aktivní ohřívání – podložkou, prouděním teplého vzduchu



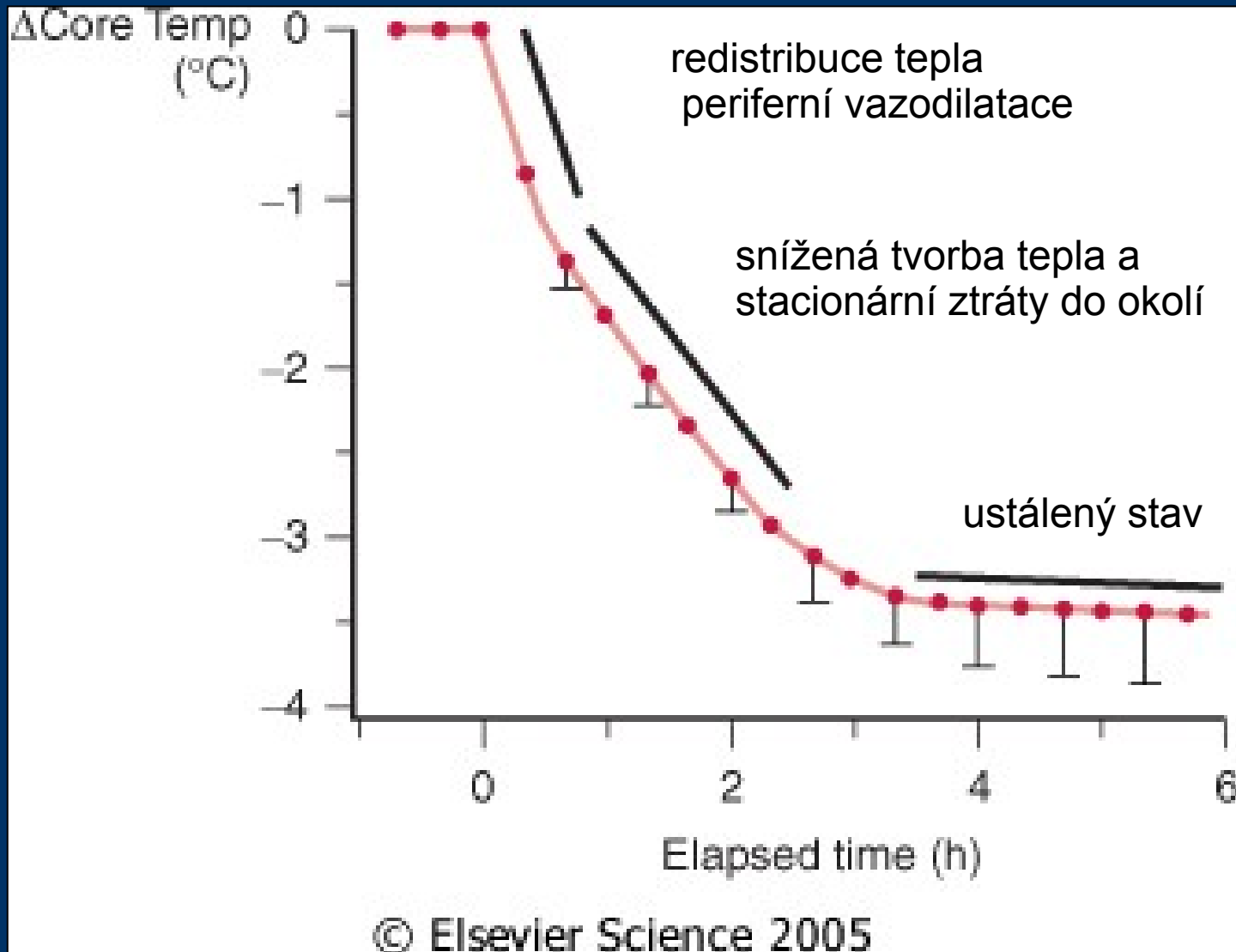
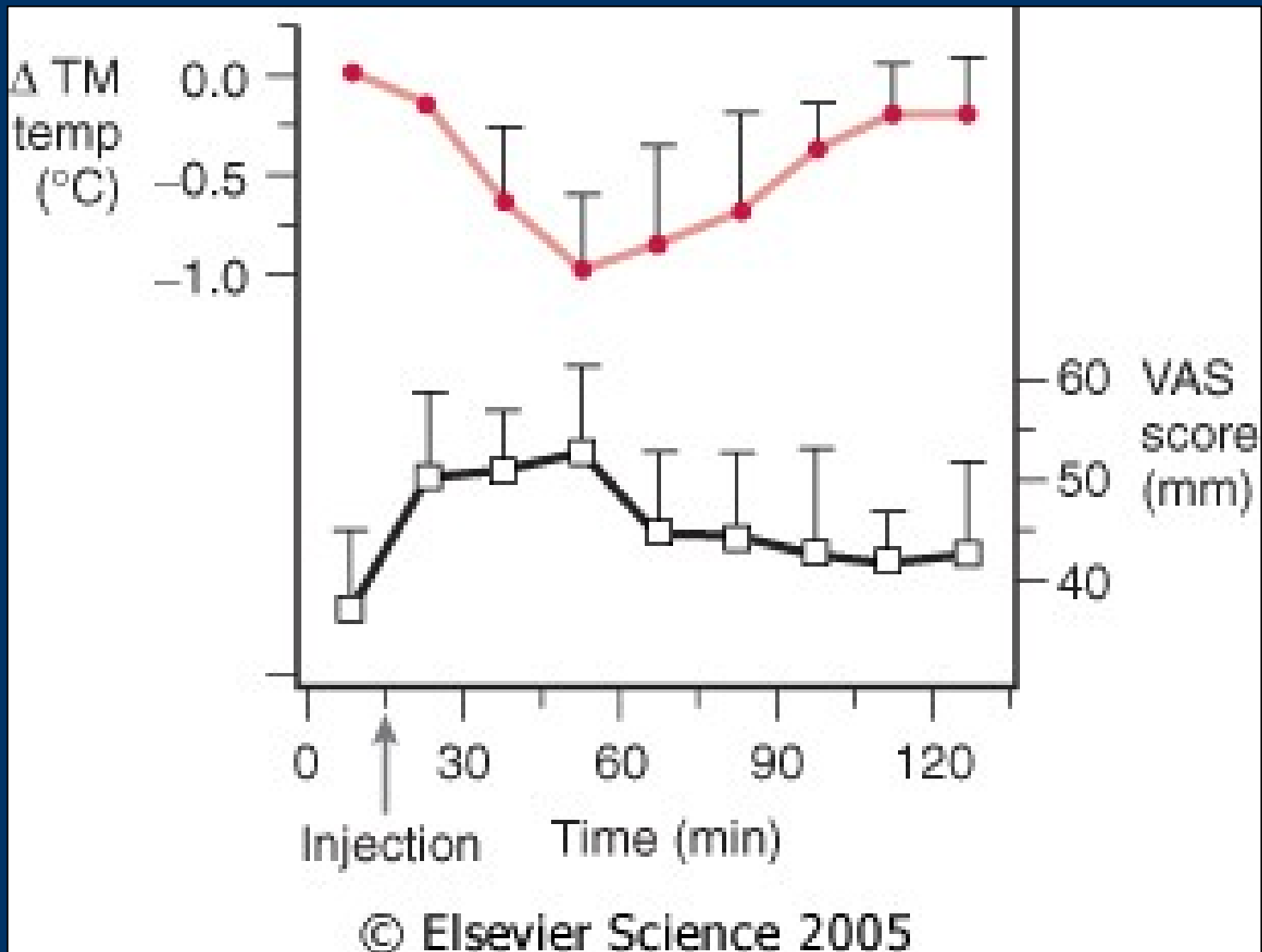

Figure 40-7 Hypothermia during general anesthesia develops with a characteristic pattern. An initial rapid decrease in core temperature results from a core-to-peripheral redistribution of body heat. This redistribution is followed by a slow, linear reduction in core temperature that results simply from heat loss exceeding heat production. Finally, core temperature stabilizes and subsequently remains virtually unchanged. This plateau phase may be a passive thermal steady state or might result when sufficient hypothermia triggers thermoregulatory vasoconstriction. Results are presented as means  $\pm$  SD.



15 minutes po EPI anestezii pokles teploty jádra, vzestup pocitu tepelné pohody (visual analog scale -VAS). Interestingly, however, maximal thermal comfort coincided with the minimum core temperature. Tympanálně měřená teplota. (Redrawn with modification from Sessler DI, Ponte J: Shivering during epidural anesthesia. *Anesthesiology* 72:816-821, 1990.)

# *Monitorace nervosvalové blokády*



- single-twitch
- train-of-four (TOF)
- tetanic, post-tetanic count (PTC)
- double-burst stimulation (DBS)



# TOF

- 4 stimuly á 0,5s (2Hz)

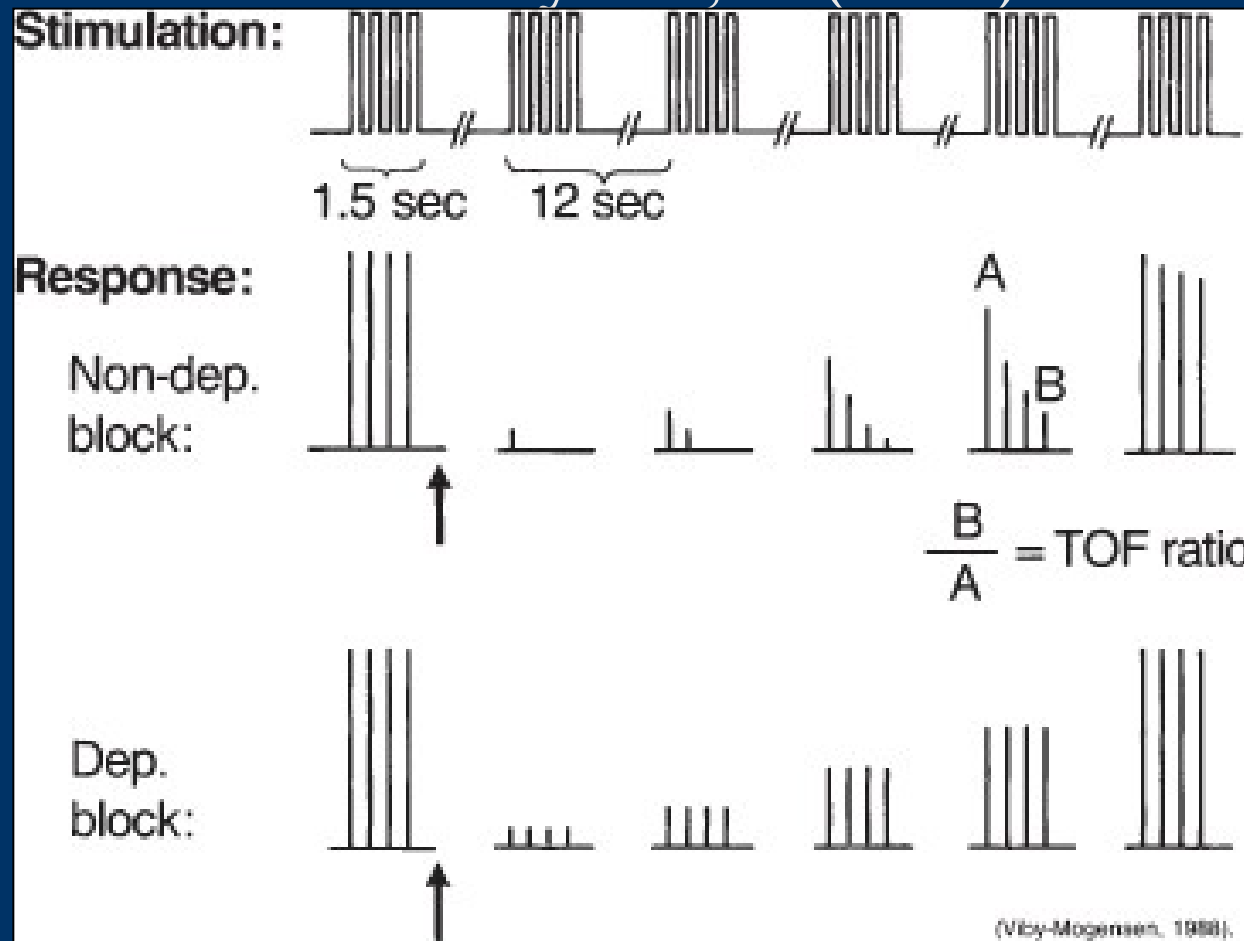

Figure 39-2 Pattern of electrical stimulation and evoked muscle responses to TOF nerve stimulation before and after injection of nondepolarizing (Non-dep) and depolarizing (Dep) neuromuscular blocking drugs (arrows).

# *Sledované parametry anest. přístroje*

- hmotnost palice
- tloušťka a počet polštářů



# *Sledované parametry anest. přístroje*



- tlaky v Centrálním rozvodu / tlak. lahvích
- funkce ventilátoru (vlnovec se vrací až nahoru)



# *Bdělost při CA*

- Bdělost je pooperační vzpomínka na události během celkové anestezie

- 0,1 – 0,2% operované populace (1:800)

- mimotělní oběh
- císařský řez
- trauma

reportují:

- pocit svalové relaxace, nemožnost pohybu
- konverzace
- strach, bolest, bezmoc

# Bispectral index monitoring to prevent awareness during anaesthesia: the B-Aware randomised controlled trial

*P S Myles, K Leslie, J McNeil, A Forbes, M T V Chan, for the B-Aware trial group\**

THE LANCET • Vol 363 • May 29, 2004 • www.thelancet.com

Whipple's procedure	Heard the anaesthetist say "the pressure is really low", and the surgeon respond "can you do something about it?". Recalls movement and pain within the abdomen. Tried to move, but was unable to (1=ND, 2=Y, 3=Y)
Laparotomy, ruptured hepatoma	Remembers going "half asleep", then hearing shouting ("...do things faster... because things are crashing..."). Felt anxious, dizzy, and breathless, and could not move. Some abdominal pain (1=ND, 2=Y, 3=D)
Anterior resection	Heard noises during surgery; tried to move but was unable (1=Y, 2=Y, 3=Y)

Until 30 days after enrolment, the number of patients who reported awareness under anaesthesia was significantly smaller in the BIS group than in the routine care group (2 [0·17%] *vs* 11 [0·91%]; OR 0·18; 95% adjusted CI 0·02–0·84;  $p=0\cdot022$ ); the absolute reduction in the risk of awareness was 0·74%. The number needed to treat (NNT) was 138 (95% CI 77–641). The benefit of

# Monitorace hloubky bezvědomí

- EEG – matematika → BIS .. číslo charakterizující bdělost 100 .. 0

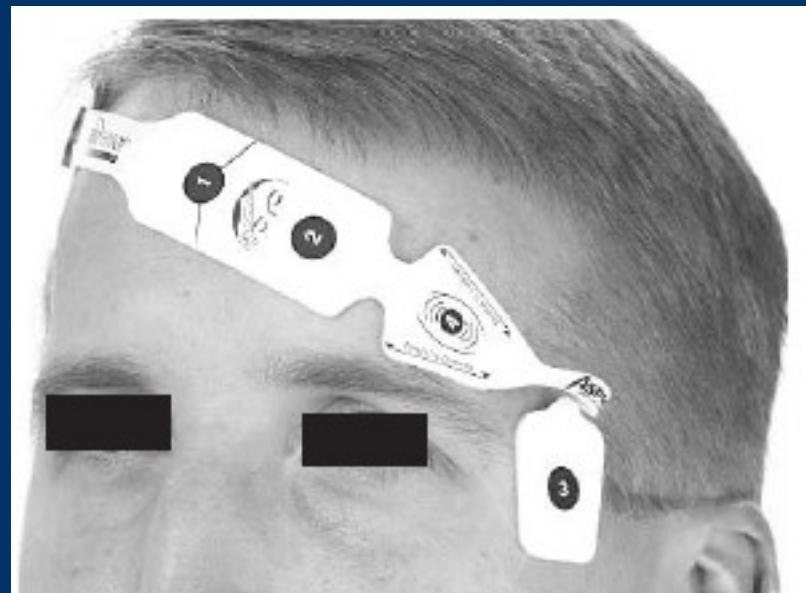

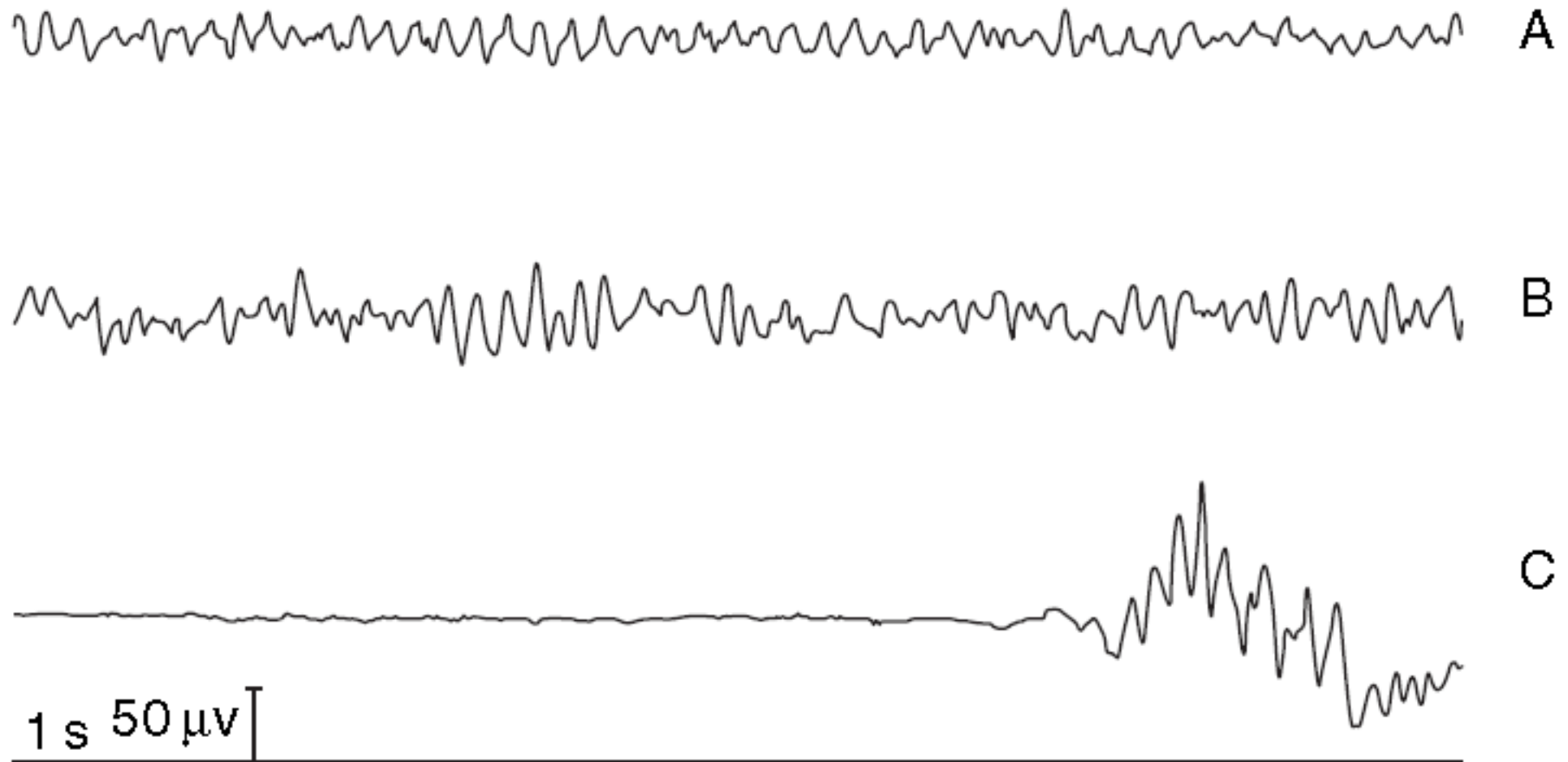

**Fig 5** Raw EEG waves. A, awake state; B,  $\beta$ -activation; C, burst suppression.