

DRUG DOSAGE FORMS

PharmDr. Ondřej Zendulka, Ph.D.

Drug dosage form

- final drug form ready for administration to patient
- modifies the general effect of the drug

Classification: based on consistence

- solid
- semi-solid
- liquid
- gaseous



- *based on routes of administration (internal/external-others)*
- *based on shape specificity (specific/nonspecific)*

Drug dosage form

1. suitable form of active substance (AS) for the administration
2. administration of a specified dose of AS
3. protection of AS against environmental influences (light, humidity)
4. protection of AS in human body (\downarrow pH in stomach)
5. adjustment of organoleptic properties (smell, taste)
6. influence of the PK properties:
 - release adjustment
 - targeted distribution of AS

DDF Classification

For systemic effect

1. generation: DDF without release control (konvenční LF)
2. generation : **controlled release** DDF (CR)
3. generation : targeted distribution DDF (drug delivery system)

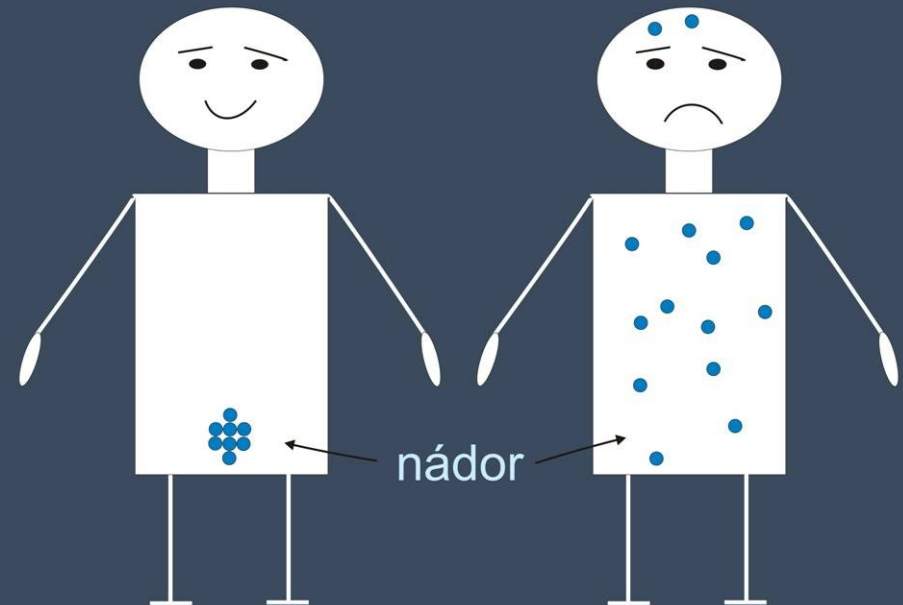
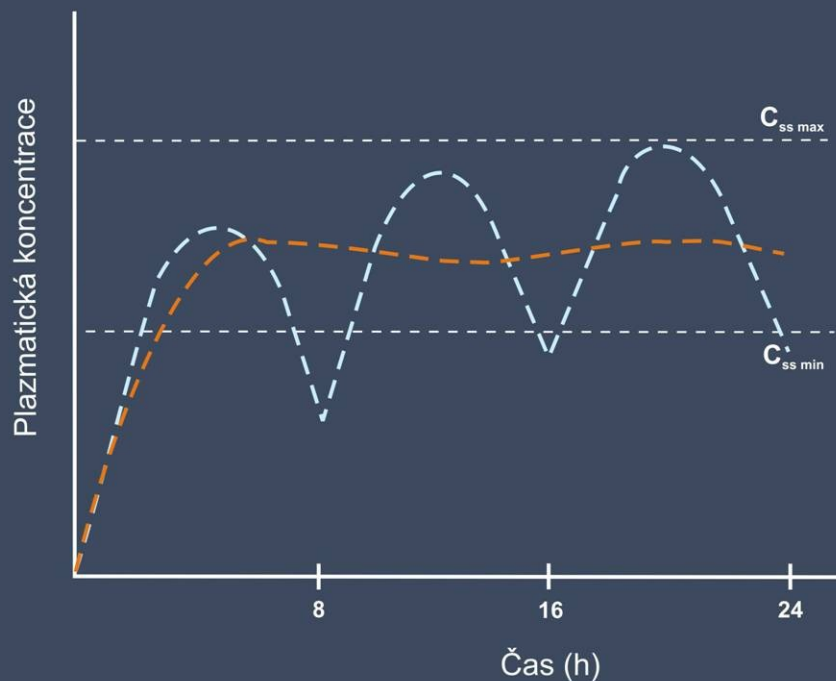



DRUG DOSAGE FORMS :
2. LIQUID DOSAGE FORMS

How much of boric acid will you need for 120g of 3% solution?

How much of glucose will contain 500g of isotonic infusion?

How much of codein is in one table spoon of the preparation consisting of 2,0g of codein and 98g of simple syrup?

Liquid dosage forms

- liquida cutanea
- pulveres adspersorii liquidi
- liquida peroralia
- tincturae
- otoguttae
- rhinoguttae
- oculoguttae
- iniectiones
- infusiones

Liquida cutanea

- for topical application
- local or systemic action
- solutions, emulsions, suspensions
- antimicrobial agents, stabilizers, emulsifier

Solvents: Aqua purificata/ Aqua pro
 iniectiione

Aqua conservans

Glycerolum 85%

Ethanolum 60%, 85%, 96%

Helianthi oleum raffinatum

Olivae oleum raffinatum

Arachidis oleum raffinatum

Liquida cutanea

Task: Prescribe 60g of 2 % salicylic spirit
(Alcohol 60%).

Principle:

1. Calculate the weight of salicylic acid
2. Write a prescription.

Rp.

Acidi salicylici	1.8
Ethanolii 60%	ad 60.0

M.f.sol.

D. ad vitr. fusc.

S. Salicylic spirit. 4-5x a day on affected area.

Task: Prescribe 30 ml of Sol. Jarisch (2%
H₃BO₃ a 4% Glycerol in H₂O)

Liquida cutanea

Pulveres adspersorii liquidi-liquid powders

- suspensions
- calming, cooling, antipruritic action
- solid base: (pulveres) 30-40%
 - - usually talc and ZnO
- liquid base: Glycerol 85%, Bentoniti magma, Ethanolum 60%

Liquida cutanea

Liquid powders:

Rp.

(Remedium cardinale)		X,X	} 30-40%
Zinci oxidi			
Talci	aa	X,X	
Ethanoli 60%		10%	
Glyceroli 85%		X,X	
Bentoniti magmatis	ad	X,X	

M.f.susp.

D.S. Liquid powder. Shake well before use.

Liquida cutanea

Task: Prescribe liquid antipruriginous powder with 0.5 % menthol.

1. asses the amount of preparation
2. count the amount of menthol (0.5%)
of solid base (30-40%)
of alcohol (10%)
3. write a prescription

Liquida peroralia

- for internal use
- local or systemic effect
- true and colloid solutions
- antimicrobial agents, stabilizers, emulsifiers, taste and smell modifiers

Classification: 1. peroral solutions,
emulsions, suspensions
2. peroral drops
syrupes
tinctures
aromatic waters

Liquida peroralia

- prescribed as undivided preparations
- divided into doses by patient before use
- easy administration (pediatrics)
- measure cups, spoons, drops

1 aqueous drop	0.05 g	1 dessert spoon	10.0 g
1 tea spoon	5.0 g	1 table spoon	15.0 g

Peroral drops

- exact volume of drug
- for highly efficient drugs
- usually DTS in 1 g of aqueous or 0,3g spirituous solution (20 drops)
- total amount: 10-25g

Liquida peroralia

Rp.

Remedii cardinalis X,X

Remedii adjuvantis X,X

Remedii constituentis ad X,X

M.f.sol.

D. ad vitr. gutt.

S. Y x a day X drops.

Principle:

1. decide how long and often will be medicine administered = number of doses
2. decide the number of drops for one dose = amount of medicine
4. calculate amounts of components required for whole preparation
5. write a prescription

Liquida peroralia

Ex.

Rp.

Atropini sulfatis monohydrici 0,02

Aquae purificatae ad 20,0

M.f.sol.

D. ad vitr. gutt.

S. 3 x a day 20 drops

Liquida peroralia

Task: Prescribe peroral antitussive drops with codein (DTS = 0,01-0,015), for 14 day long therapy with a 3 x day administration.

Rp.

Codeini phosphatis hemihydrici 0,675

Aquae purificatae ad 45,0

M.f.sol.

D. ad vitr. gutt.

S. 3 x day 20 drops.

Lic



Peroral solutio

- IPP doses in
- usually : 50-100g for tea spoon
• 150-250g for table spoon
- taste correction: sirupes 15-20 (simplex, althae, plantaginis)

Rp. Remedii cardinalis X,X
Remedii corrigentis X,X
Vehiculi ad X,X
M.f. sol. (D. ad vitrum fuscum)
D.S. Y x day table spoon.

Liquida peroralia

Principle:

1. decide how often and how long will be preparation administered
2. calculate the number of doses and amount of drug
3. asses the volume of one dose and total amount of preparation
4. decide if you will use rem. corrigens
5. write a prescription

Liquida peroralia

Task:

Prescribe 200g of aqueous 20% MgSO_4 solution. Salinic laxative.

Task:

Prescribe antiasthmatics with bronchodilatory component with ephedrine (DTS 0.02g), KI (DTS 0,3-0,5g) and aminophylline (DTS 0,25-0,5g). Use a taste adjusting compound spirit of anise seed.

Task:

Prescribe expectorant mixture with: ammonium chloride (0,3-0,6), plantain syrup, guajfenesin (0,15-0,3).

Aquae aromaticae

- saturated aqueous solutions of essential oils
- typical smell
- spasmolytic, carminative effect
- carminative = against meteorism and flatulence
- Official: Aqua carminativa
Aqua carminativa rubra

Rp. Aquae carminativae rubrae X,X
D.S. 3x day 1 table spoon after every meal.

Tincturae

 spirituous extracts administered in drops
(10-20)

 amounts 10-20g

Most common: Tinctura amara or Valerianae
tct.

Př. Prescribe tincture for stimulation of
apetite and digestion.

Rp. Tincturae amarae 10,0

D. ad vitrum guttatum.

S. 15 drops before every meal.

Otoguttae

- solutions, emulsions, suspensions
- suitable for administration into ear
- up to 20g
- adjusted into bottles- don't forget dropper!

Ex:

Rp. Remedii cardinalis	X,X
Remedii adjuvantis	X,X
Remedii constituentis	X,X
M.f.otoguttae.	
D. ad lagoenam. Adde guttatorium!	
S. Ear drops.	

Task: Prescribe ear drops for softening of earwax (cerumenolytic agent). Prescription will consist of glycerol and alcohol in the same amounts.

Rhinoguttae

- local or systemic effect
- isotonic, sterile
- 10-20g

Ex:

Rp. Remedii cardinalis	X,X
Remedii adjuvantis	X,X
Remedii constituentis	X,X
M.f.rhinoguttae	
D. ad vitrum guttatum.	
S. Nasal drops.	

Task: Prescribe borephedrine nasal drops.
Ephedrine 1% a boric acid 3%.

Occuloguttae

- local effect with a risk of systemic reaction
- isotonic, sterile (isoacid)
- up to 10 g

Prescription:

- M. f. oculoguttae.
- S. s. v.

Rp. Remedii cardinalis X,X
Remedii constituentis ad X,X
M.f.oculoguttae.
Da ad vitrum guttatum.

S. Eye drops. 1 drop into each eye 5 x a day. Sub signo veneni!

Occuloguttae

Task. Prescribe miotic eye drops with 2% of pilocarpine.

Infusiones

- similar requirements as in injections
- without antimicrobial agents
- volumes 100-400 ml (1000ml)

IPP:

- Ad lagoenam pro infusione.
- Suo nomin. Cum formula.
- some can be prescribed like officinal drugs (Glucosi infusio isotonica, Natrii chloridi infusio isotonica...)

Task: Prescribe three 400 ml bottles with sodium chloride infusion.

Task: Prescribe 500 ml of glucose infusion.



Gaseous DDF

Gaseous DDF

- Aerodispersiones
- Praeparata pharmaceutica in vasis cum pressu
- Spumae medicatae
- Inhalanda

Gaseous DDF

Aerodispersions

- molecular– from volatile solid and liquid drugs
 - particles $< 0,5 \mu\text{m}$
- colloid – dispersion of non-volatile substances in the air
 - particles $0,5 - 5 \mu\text{m}$
- macro dispersions - dispersion of non-volatile substances in the air
 - particles $> 5 \mu\text{m}$

A
E
R
O
S
O
L
S

Gaseous DDF

Aerodispersions

- *Liquida nasalia pro aerodispersione*
 - liquid nasal sprays
- *Praeparata auricularia pro aerodispersione*
 - ear sprays
- *Praeparata pro aerodispersione oromucosali*
 - oral sprays
- *Praeparata pro aerodispersione sublinguali*
 - sublingual sprays
- *Pulveres adspersorii pro aerodispersione*
 - sprayed dusting powders

Gaseous DDF

Preparations in the pressured bottles

- the pressure is induced by propellant (liquids with low boiling point)
- propane, n-butane, isobutane
 - aerosol
 - liquid/semi-solid stream
 - foam
- skin, mucosas, inhalation

Gaseous DDF

Medicated foams

- huge volume of gas dispersed in liquid
- local effect on skin and mucosae
 - Ex. Panthenol spray
- *Spumae rectales*
- *Spumae vaginales*
- *Spumae cutaneae*

Gaseous DDF

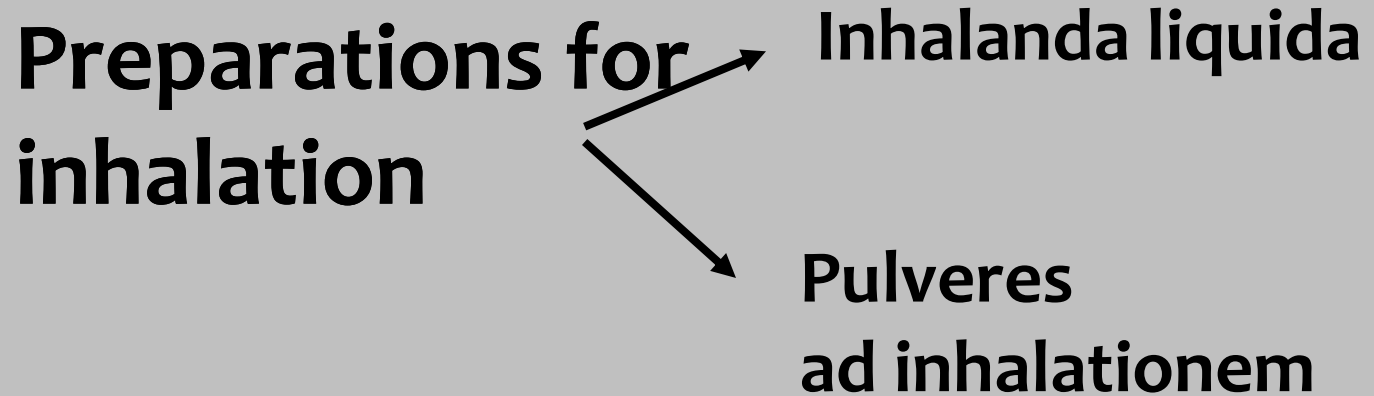

- special instruments necessary for administration

Gaseous DDF

- **MDI – metered dose inhaler**
 - propellants
 - the coordination between drug release and inhalation is essential (risk patient children and elders)
 - Easy-Breathe – drug release is activated by breathing in
- **DPI – dry powder inhaler**
 - Diskhaler, Diskus -Glaxo a Turbuhaler -Astra
 - drug is released from cartridge and inhaled
- **ultrasound or jet nebuliser**
 - enables higher impact of drug on the respiratory system and minimizes the contamination of oral cavity

Single-dose devices

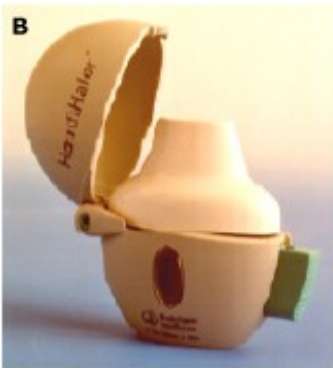

Multiple-dose devices



Push down on the canister
and breathe in slowly



Plynné lékové formy

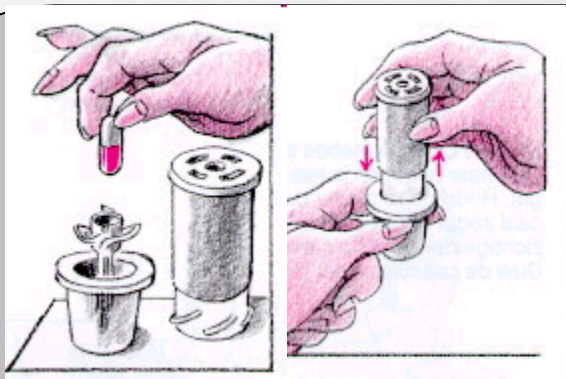

Inhalanda

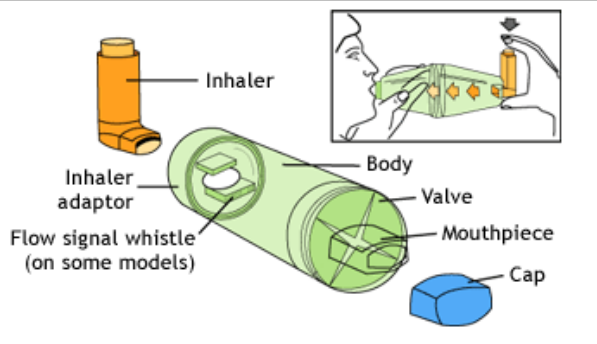
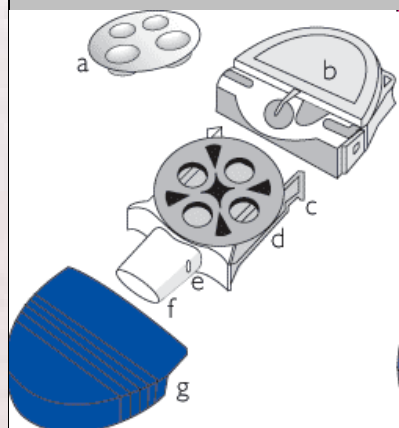

<http://www.mojnet.com/video-astma/99ae946898b4f1f31505>

<http://www.youtube.com/watch?v=zC7sL7Nqkal>

<http://www.youtube.com/watch?v=svG5S2wn4xQ&feature=related>