

Dental Unit

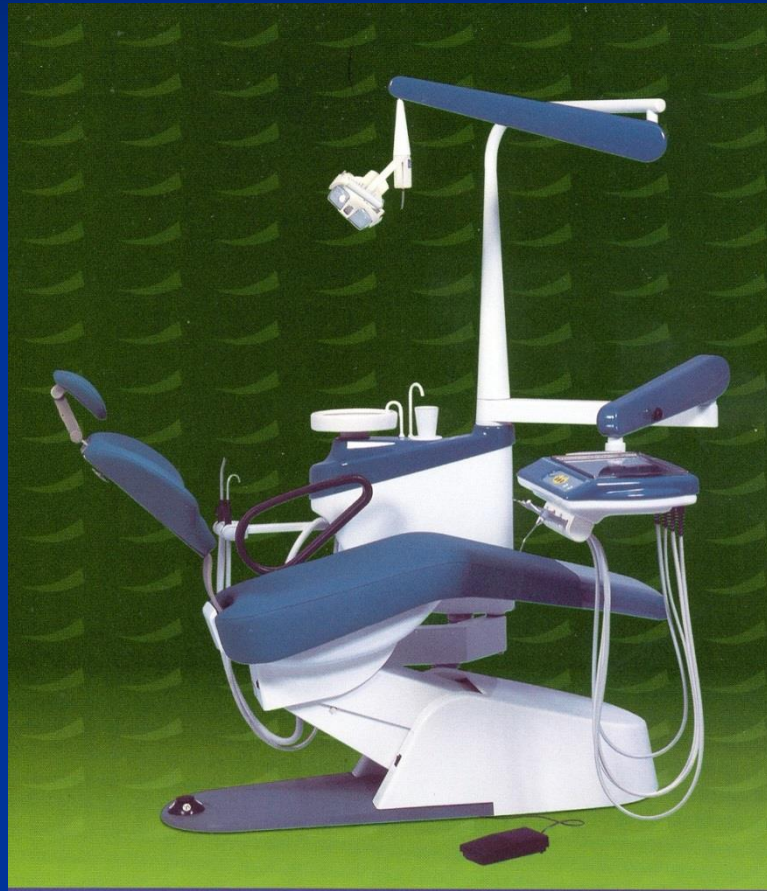



Spitting box
with amalgam
separator

Light

Driving system

Tray

Chair



Hoses - lower leading

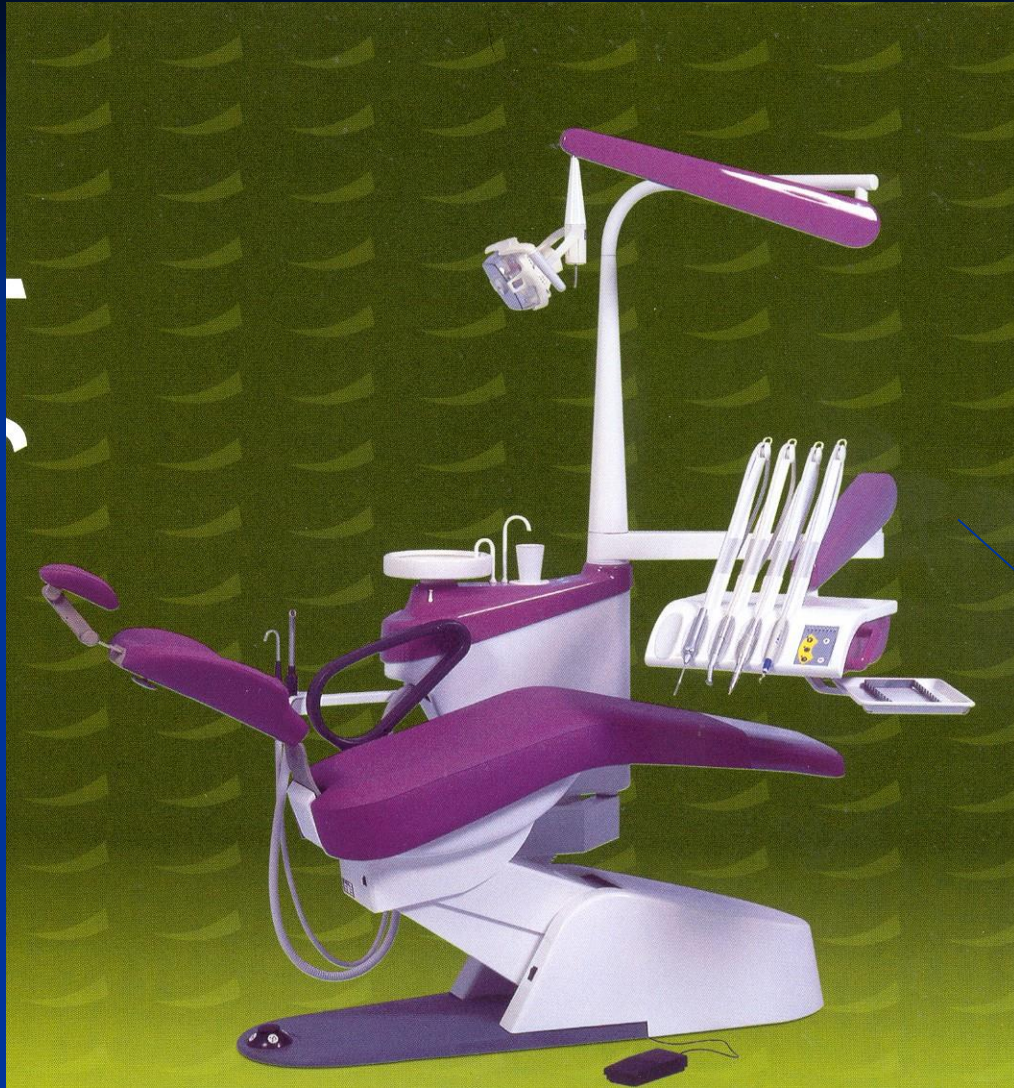

Hoses – upper leading

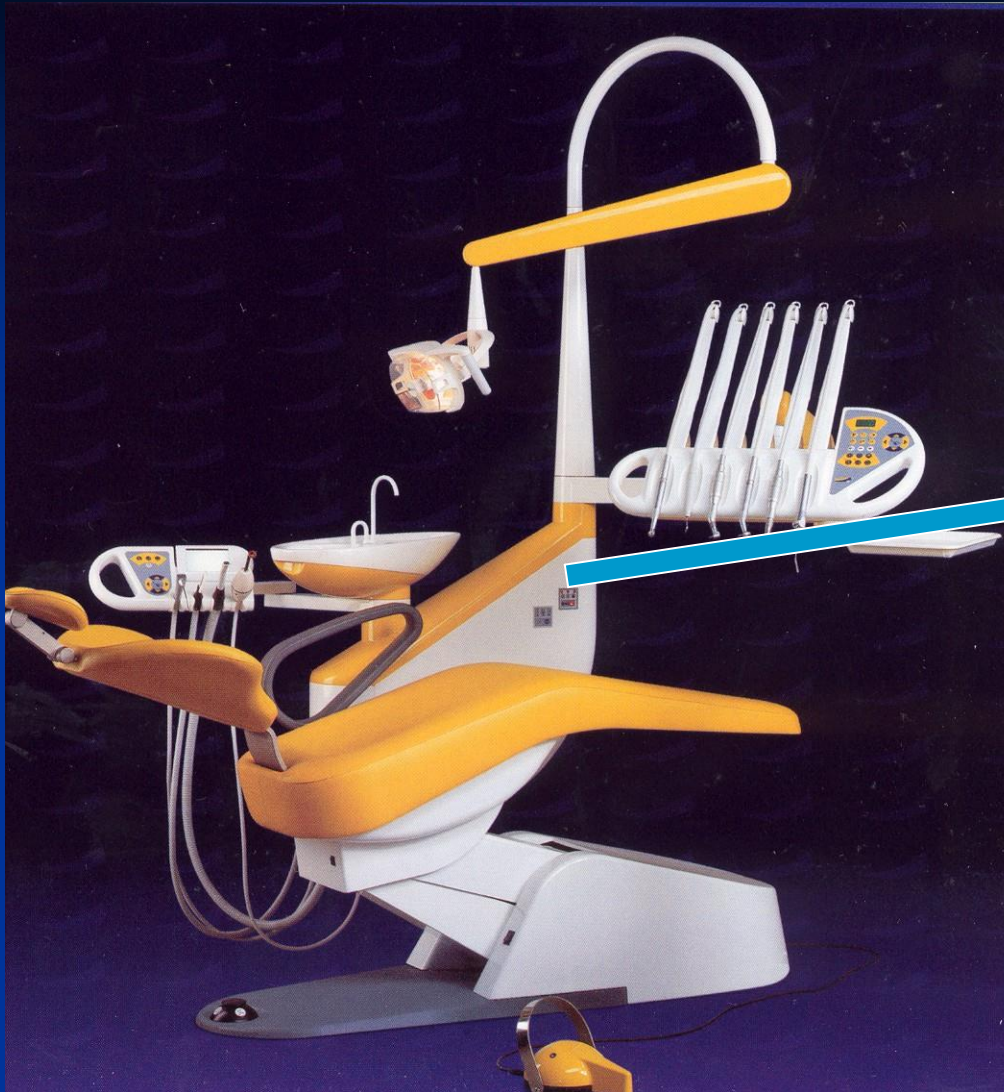

- Spitter block
- Suction
- Amalgam separator

Modules:

Motor

Turbine

Air/water gun (syringe)

Ultrasound

Polymerization unit

Instruments for preparation of cavities

Hand instruments for cutting

Two main materials:

Stainless steel (loses keen edge)

Carbon steel (corrode)

Excavator

Chisel- cleaver

Instruments for cavity preparation

Power driven instruments for cutting

- Rotary instruments

Comon design characteristics



Shank

- The part that fits into the handpiece
- Accepts the rotary motion from the
- handpiece
- Provides a bearing surface to control the
- alignment and concentricity of the
- instrument

Straight handpiece shank

- Simple cylinder
- held in the handpiece in a metal chuck

Latch angle handpiece shank

- Shorter length – access to posterior regions

Handpiece – contra angle, metal bur tube.

The end of the instrument fits into D-shaped socket at the bottom of the bur tube. The *instrument* retained by a retaining latch that slides into the groove found at the shank end of the instruments.

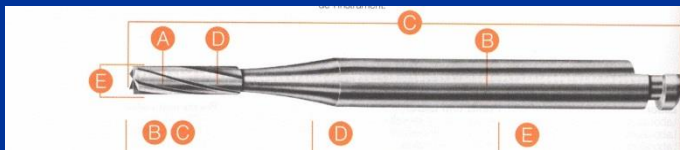

Low and medium speed

Friction grip handpiece shank

Smaller design, simple cylinder.

Held in the handpiece by friction in plastic or metal chuck.

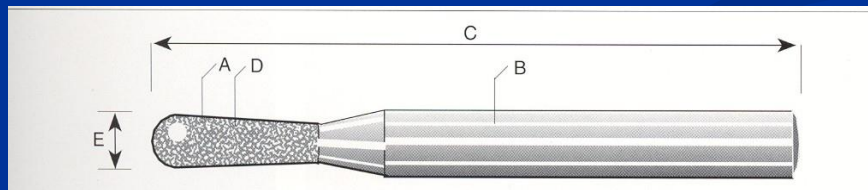

Neck design

Intermediate portion of an instrument that connects the head to the shank
Tapered, shorter or longer.

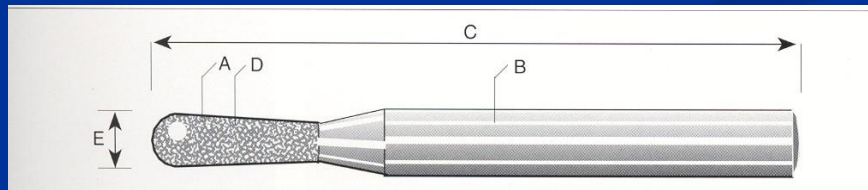

Head design

Burs – cut of steel or tungsten carbide

Diamond (diamond burs)– covered with the diamond bort

Head design

Burs classification system

Round

Inverted cone

Pear shaped

Straight fissure

Tapered fissure

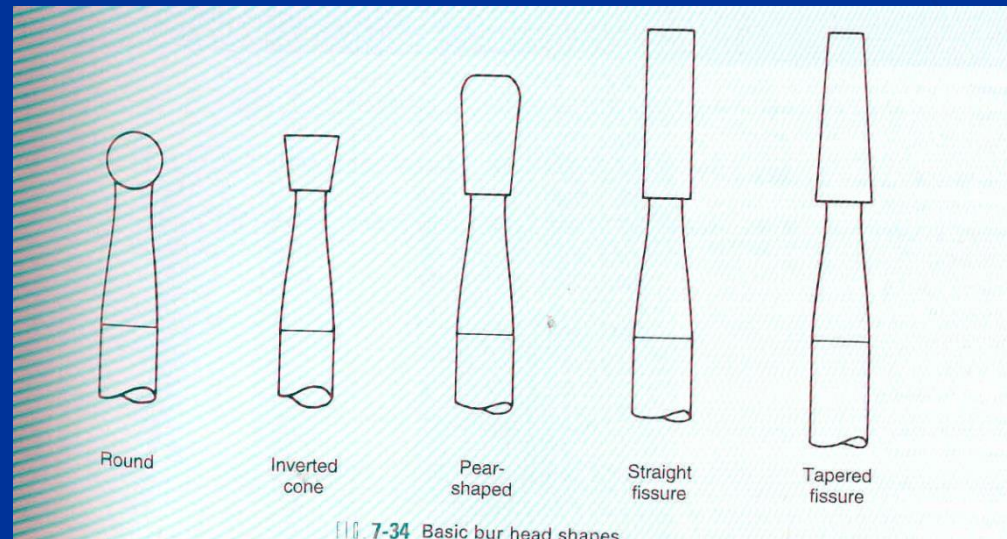

Bur blade design

- Rake face (towards the direction of cutting)
- Clearance face

Rake angle – slightly negative

Edge angle – appr 90°

Clearance angle

Clearance face rounded or two surfaces.

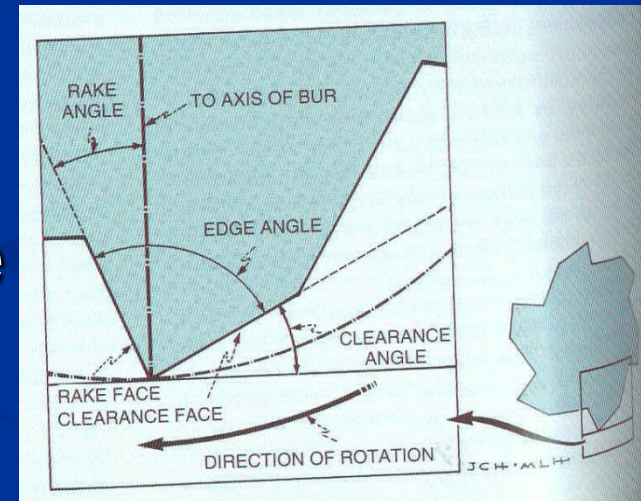

Head design

Diamond classification system

Round
Inverted cone
Pear shaped
Cylinder
Taper
Lens
Needle etc.

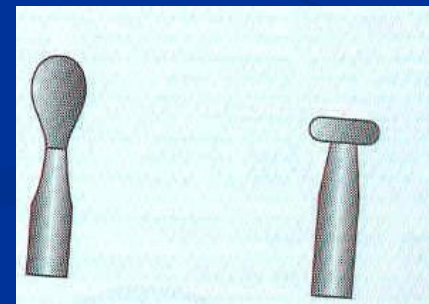
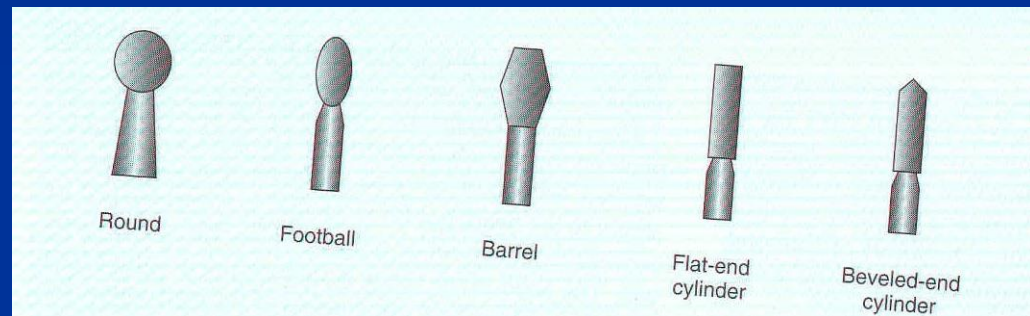

The bur for handpiece – slow rpm

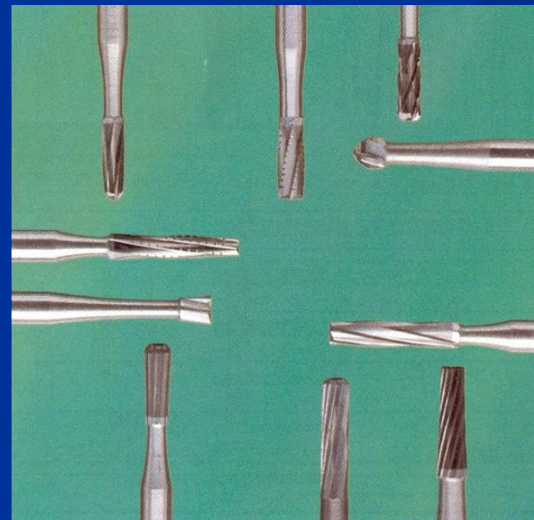
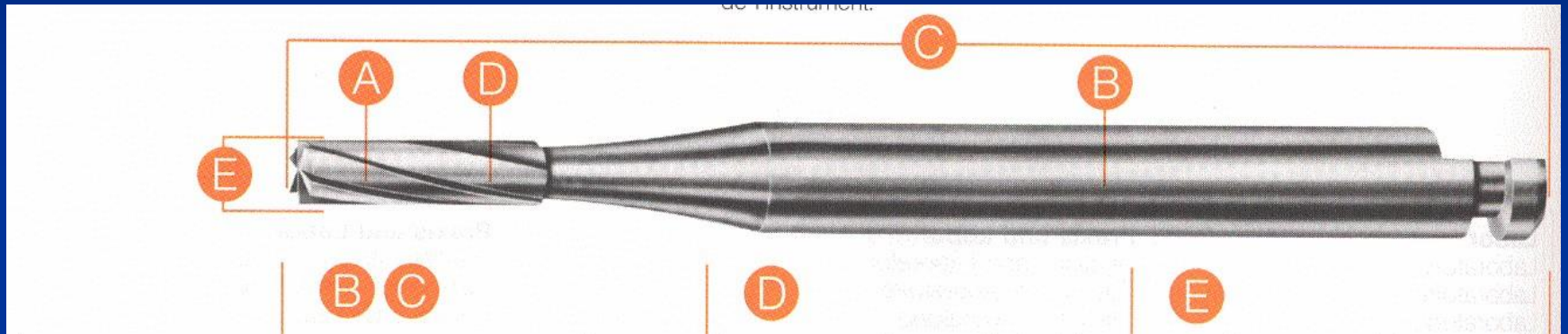

Diamond

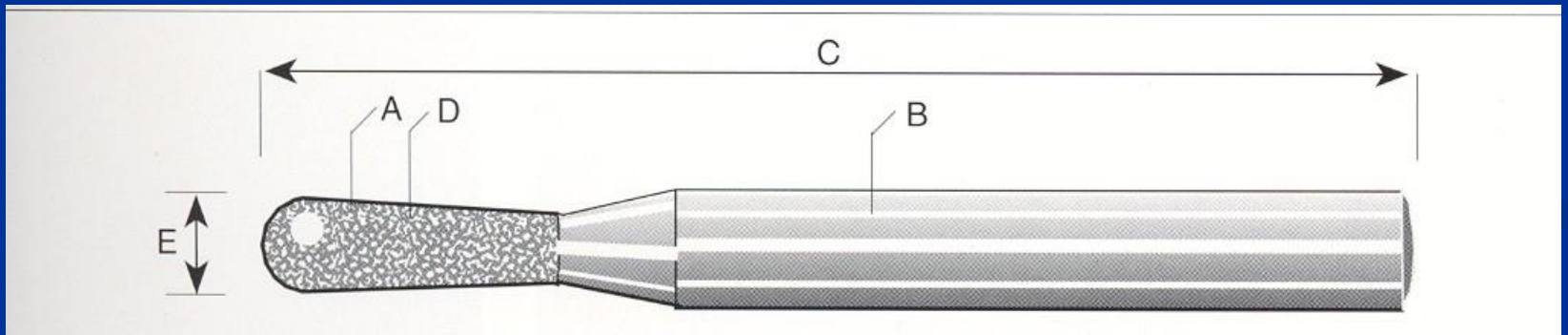

Diamond abrasive instruments

Diamond bort – small sharp particles in softer matrix. Cutting occurs at a large number of points.

Metal blank

Diamond powder

Metallic bonding material

Preparation speed

- Low (slow) speeds – below 12.000 rpm
- Medium or intermediate speeds 12.000 – 200.000 rpm
- High or ultrahigh speeds above 200.000 rpm



400.000 rpm



1 : 1 as far as 40.000 rpm

Red coded handpiece



1:4 až 1:5 as far as 160.000 – 200.000 rpm

Green coded handpiece



2,7:1

7,4:1

Motors and gears

Electromotors – maximum 40.000/min

Blue code – gear 1:1



Airmotors – maximum 20.000/min

Gearing to fast speed



1:5

Gearing to slow speed



2,7 :1 or 7,4 :1

Oscillation



Blue and green coded handpiece



Hanpieces combined



1:1

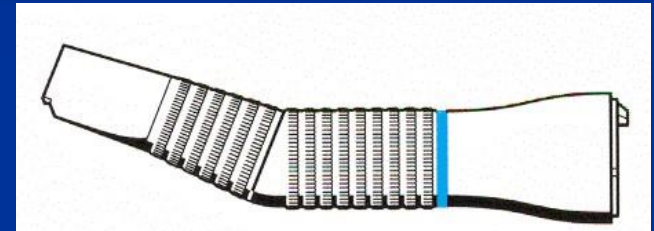
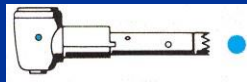

2:1

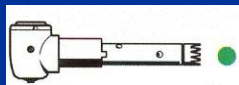

nerotuje

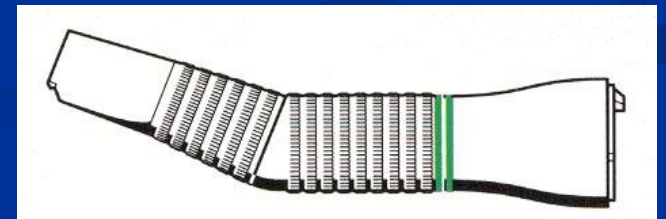
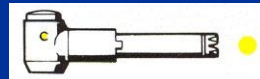

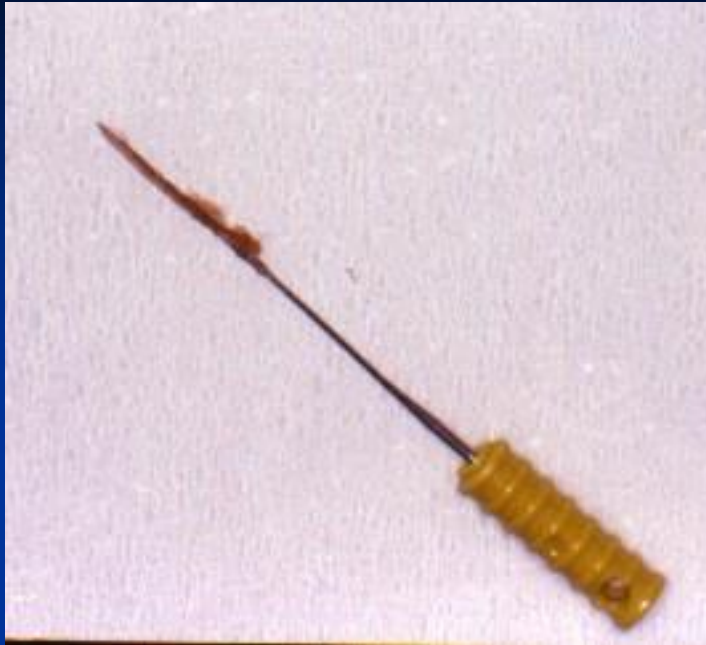

Odontoblasts Predentin Dentin

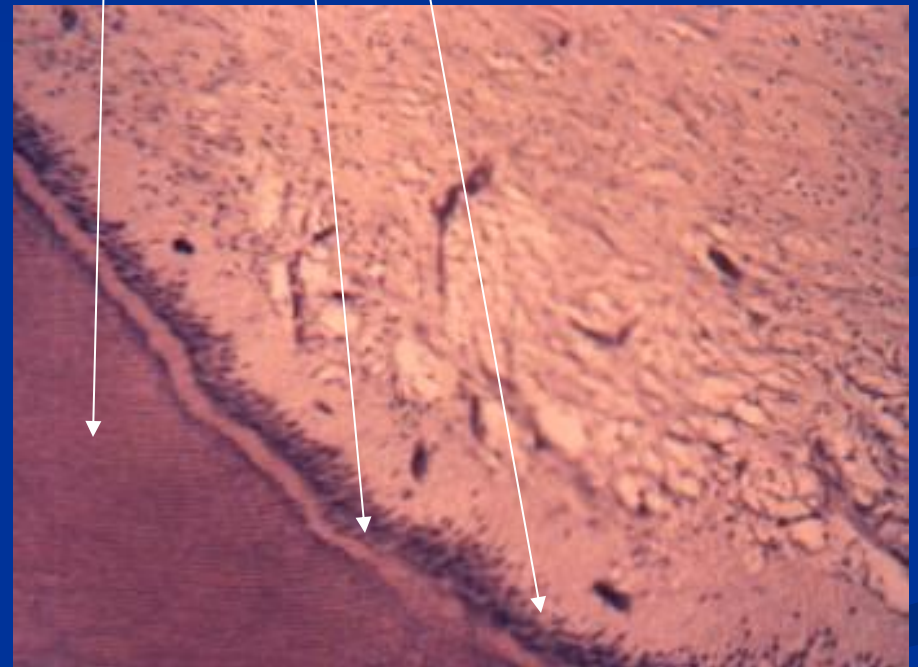
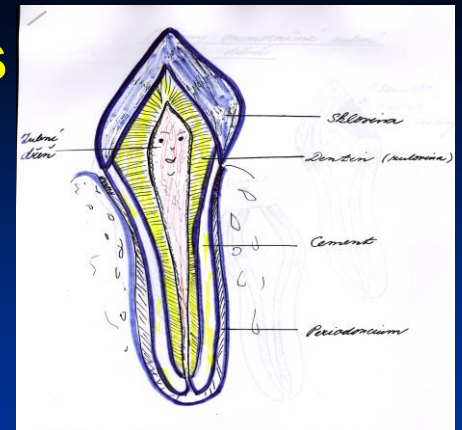

Dental pulp

Preparation trauma

- High temperature – heat
- Pressure
- Vibrations

Preparation trauma

- High temperature – heat:

Water cooling (spray)

Interrupt preparation

Without cooling: only low speed.

Protection of dentin wound

- Preparation in dentin - dentin wound.
- Treatment of the dentin wound:

Base

Subbase (indirect pulp capping)

Adhesive systems (etching, priming, bonding)

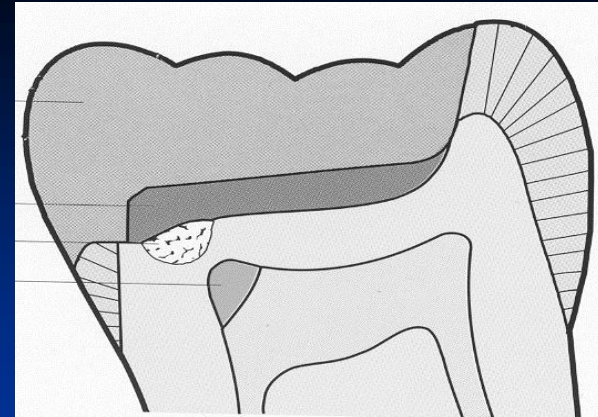
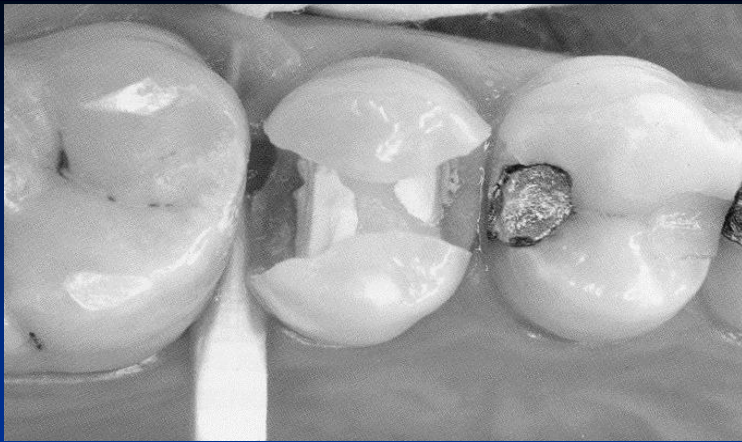

Indirect pulp capping

Deep caries

Probably changes in dental pulp

Infection inside

Calcium hydroxide influences the pulp
through dentin

Inflammation is healing

New dentin is produced

Class I.

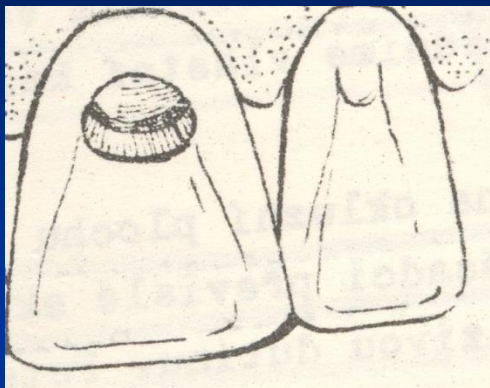

All pit and fissure restorations.

They are assigned in to three groups.

R. on occlusal surface of premolars and molars

R. in foramina coeca – usually on occlusal two thirds of the facial and lingual surfaces of molars.

R.on lingual surface of maxillary incisors.

Contraindications

- Aesthetically prominent areas of posterior teeth
- Small moderate classes I. that can be well isolated

Materials: Amalgam, composite.

Amalgam:

Pertinent material qualities and properties

Strength

Longevity

Ease of use

Clinically proven success

Indications

- Moderate to large restorations
- Restorations that are not in highly aesthetics areas
- Restorations that have heavy occlusal contacts
- Restorations that cannot be well isolated
- Restorations that extend onto the root surface
- Foundations
- Abutment teeth for removable partial dentures
- Temporary or caries control restorations.

Clinical technique

- From the occlusal surface using the fissure bur (or diamond burs, see below).

Outline

- Ideal outline includes all occlusal pits and fissures. If crista transversa or obliqua are not affected, it is recommended not to prepare them.

Resistance principles

- Keep the facial and lingual margin extensions as minimal as possible between the central groove and the cusp tips.
- Extending the outline to include fissures, thereby placing the margins on relatively smooth sound tooth structure.
- Minimally extending into the marginal ridge without removing dentinal support.
- Eliminating a weak wall of enamel by joining two outlines that come close together
- Enamel.
 - Never leave the enamel undermined
- All corners are round, the bottom smooth.

Retention principles

- Prepare the box – the bottom is in dentin
- Undercuts can be prepared, the proximal ridges must not be weakened!

Removal of carious, infected, dentin and remaining defective enamel.

- Spoon excavator or a slowly revolving ,
round carbid bur of appropriate size.

Finishing and polishing

- Fine grit diamond bur.

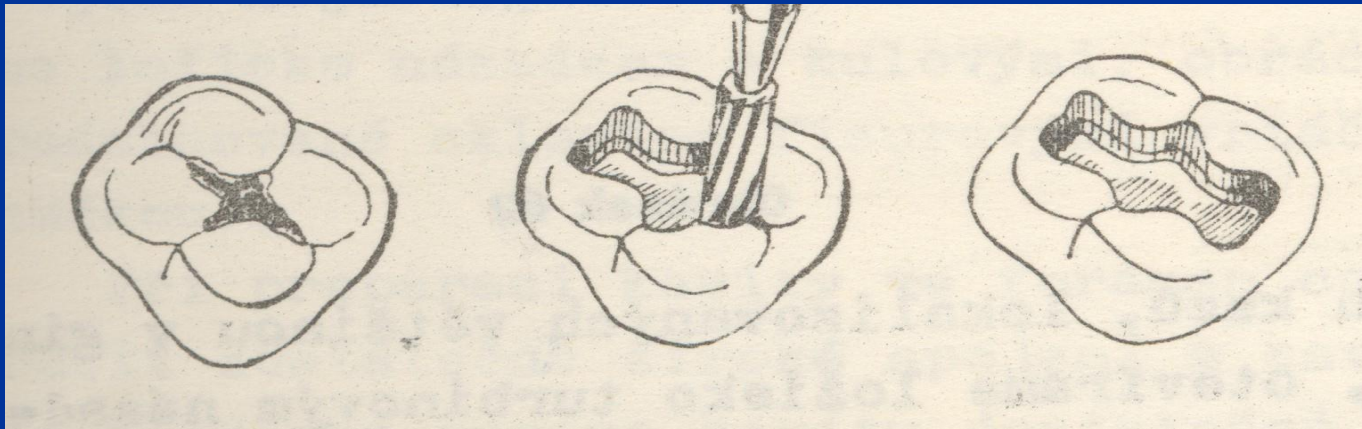
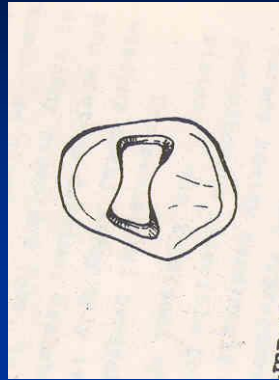

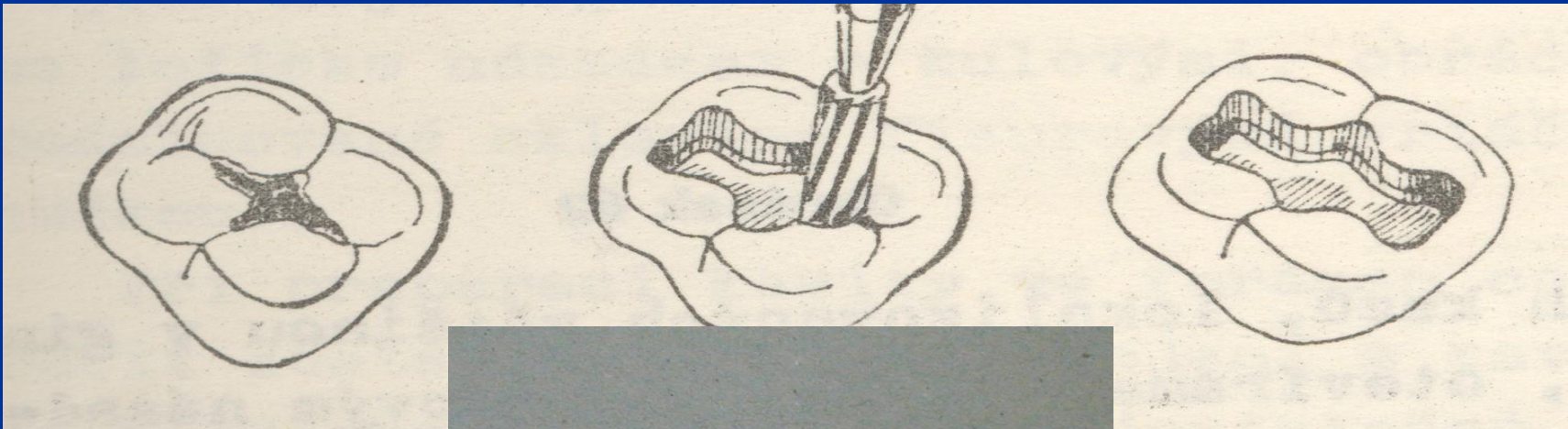
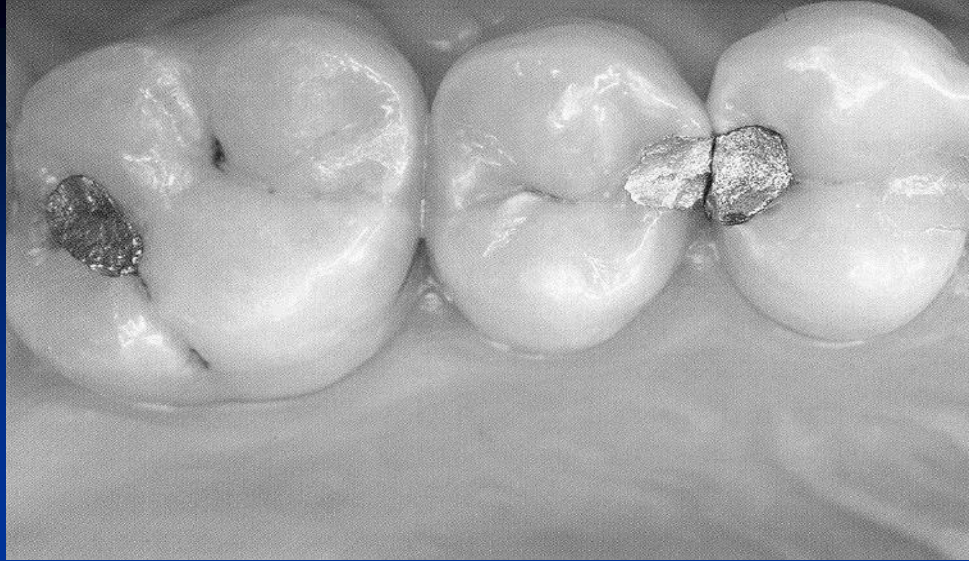

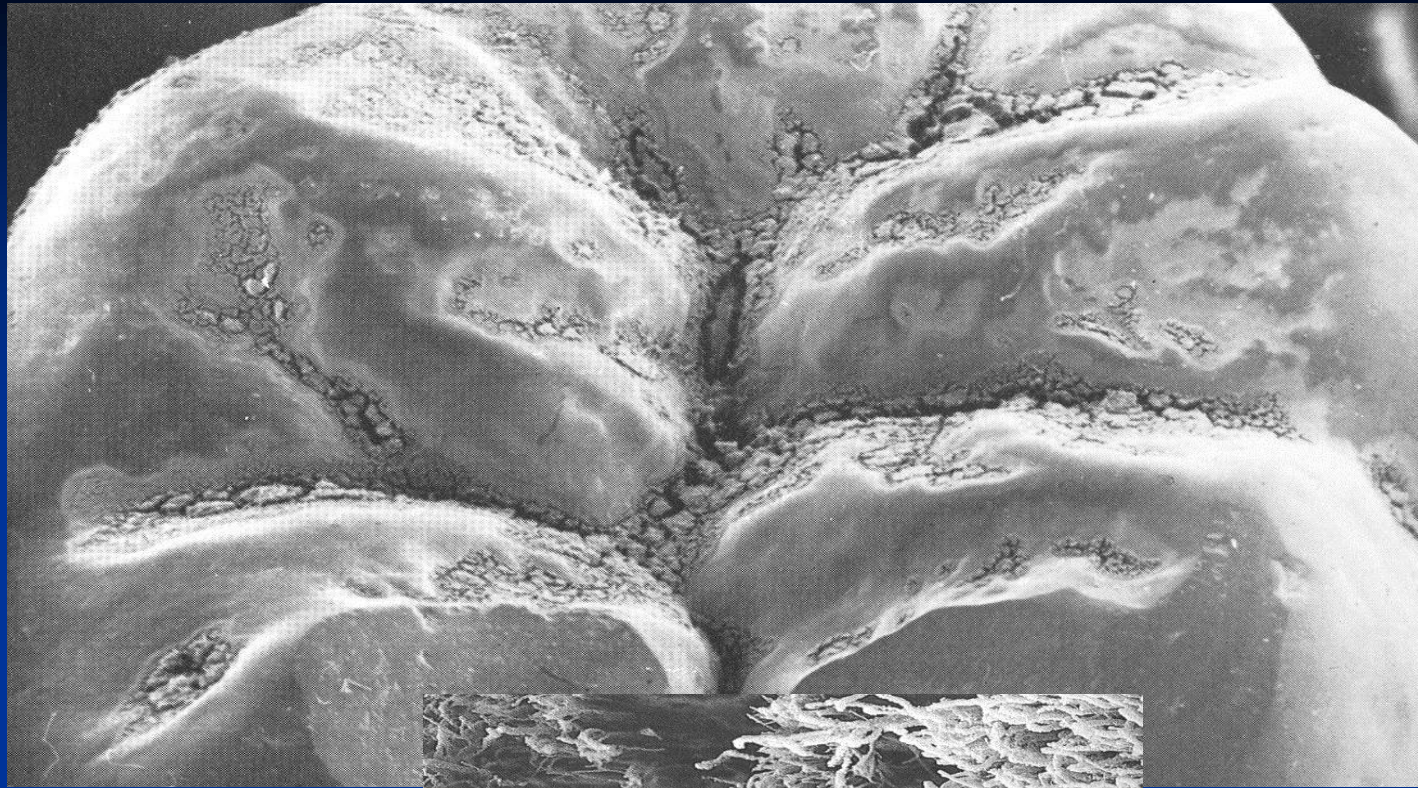

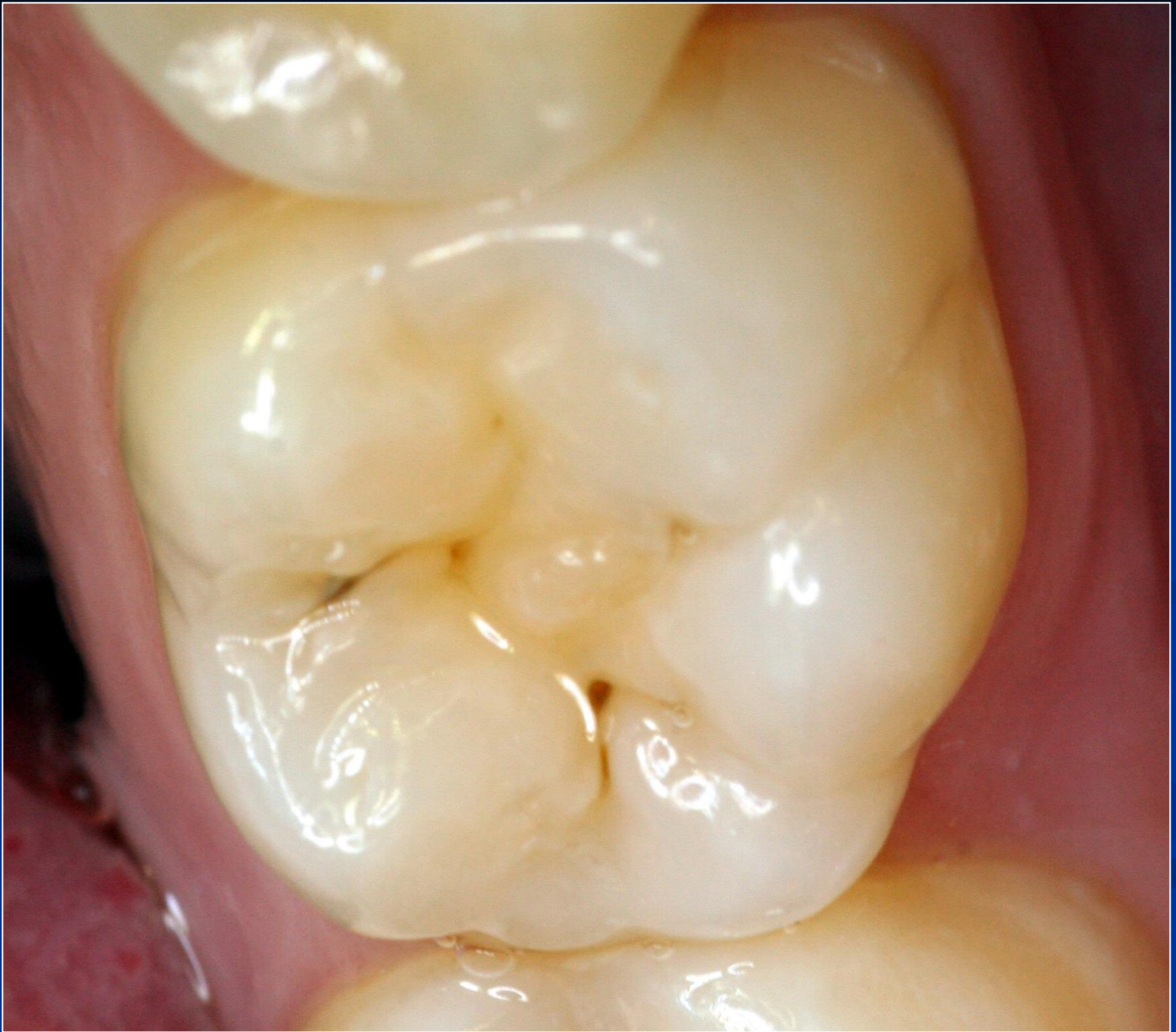



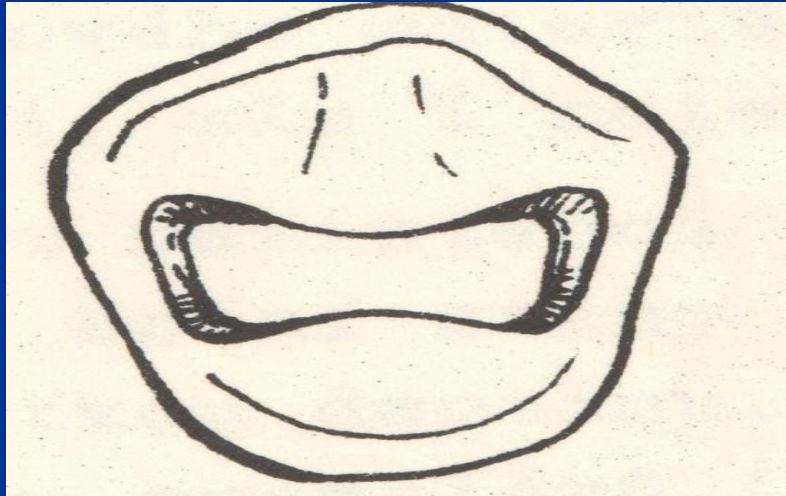
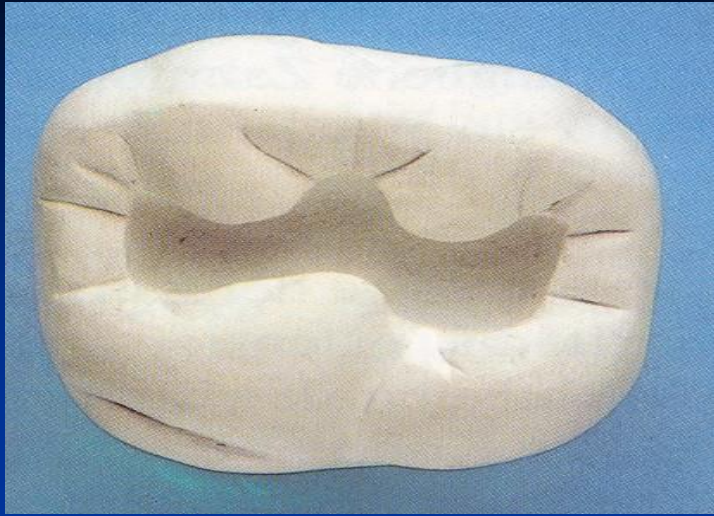

Box

- (1,5 – 2 mm

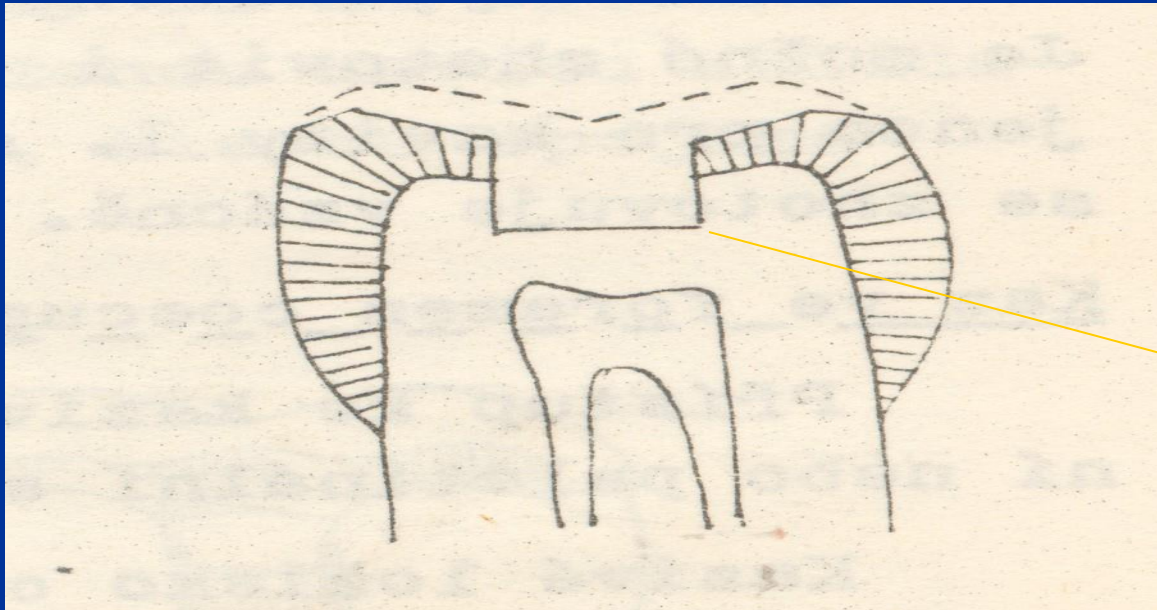

Mistake

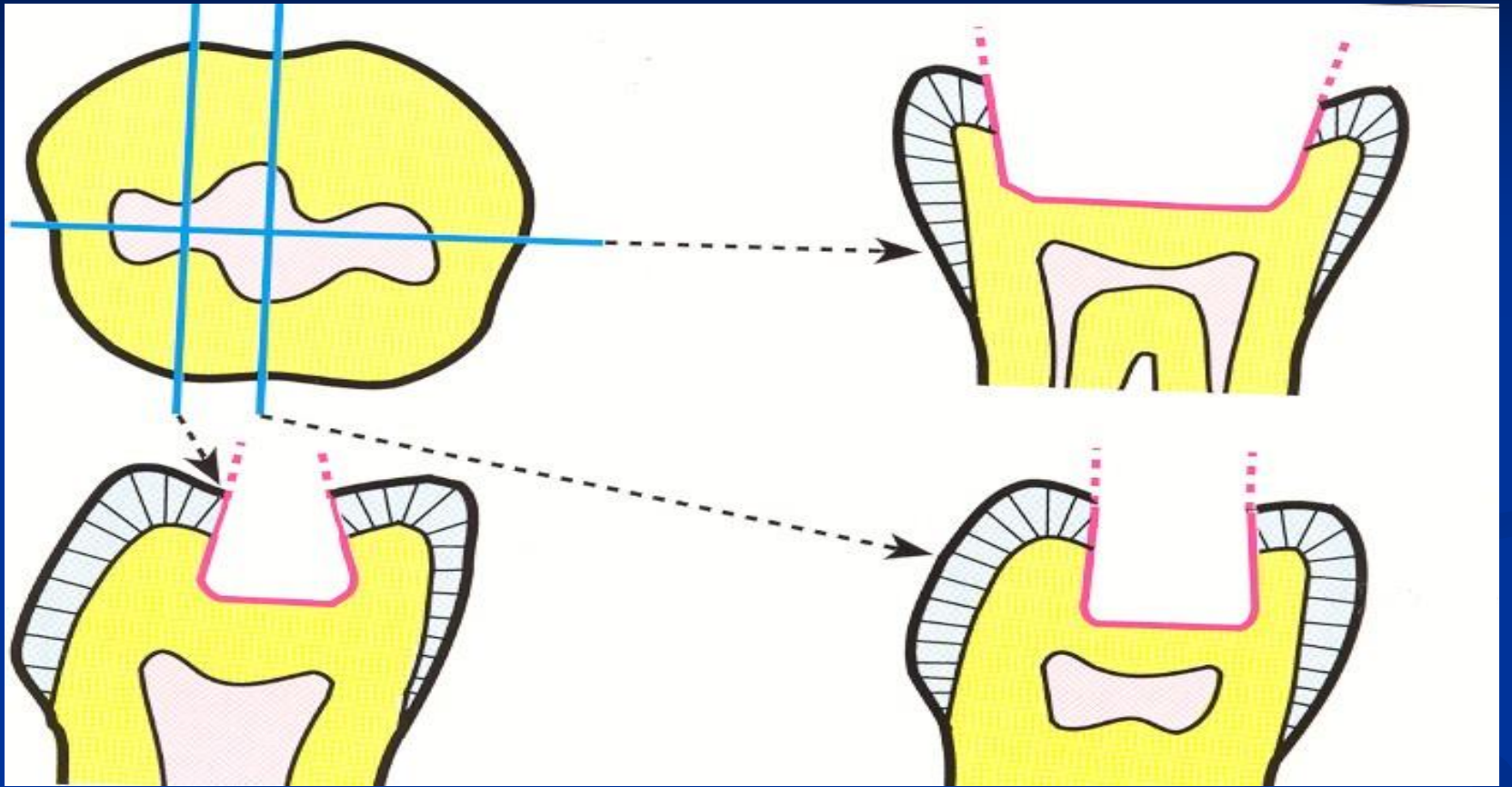

Resistance

- No undermined enamel, no close to the top of cusp than 1 mm

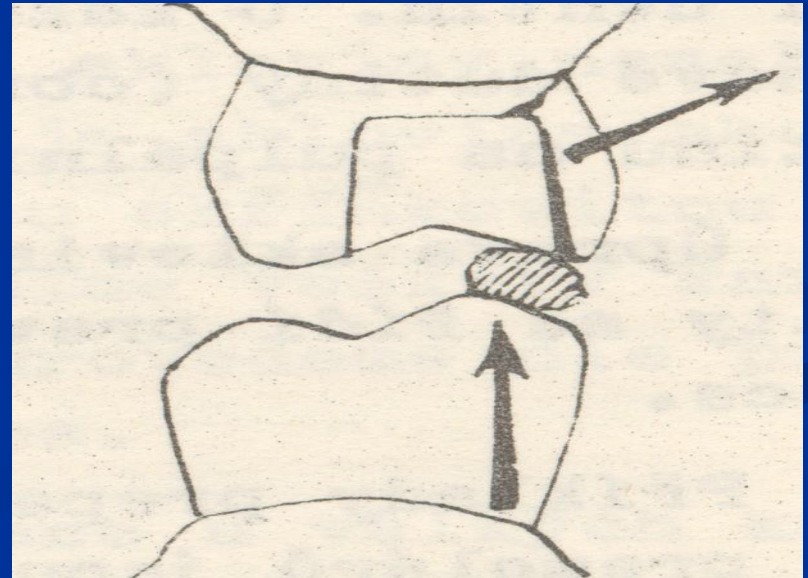

Excavation of carious dentin

- Ball (round) burs

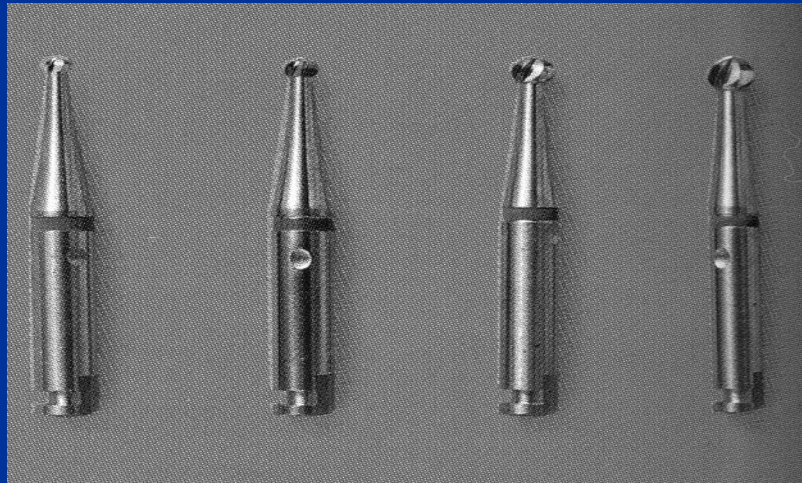

Low rpm – 3000/min

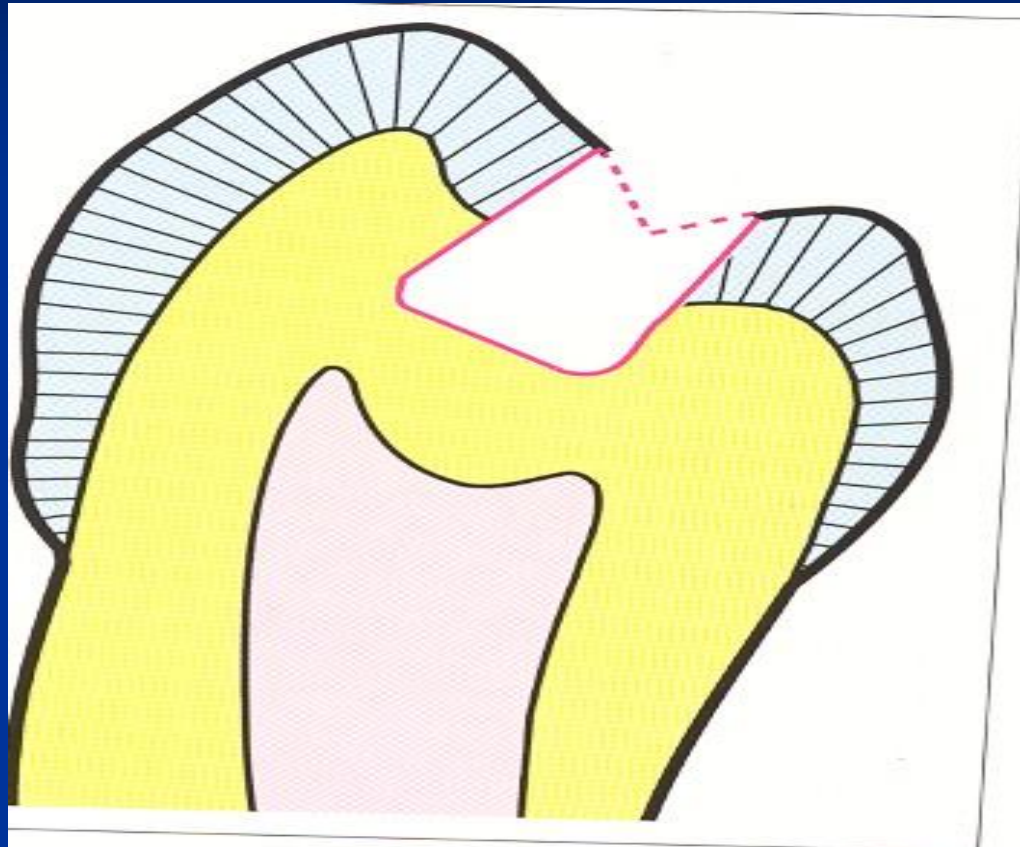

Finishing and polishing

Ohlazení - stěny nezešikmujeme!!!

Jemný diamantovaný brousek (s červeným označením) – otáčky okolo 20 000/min.



Final control

Kontrola zrakem v dobrém osvětlení,
vypláchnutí vodní sprayí a sušení.

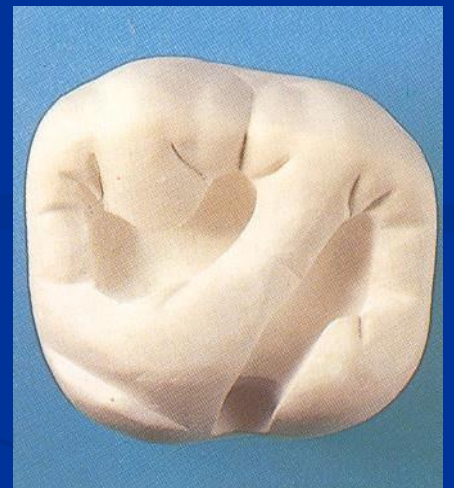
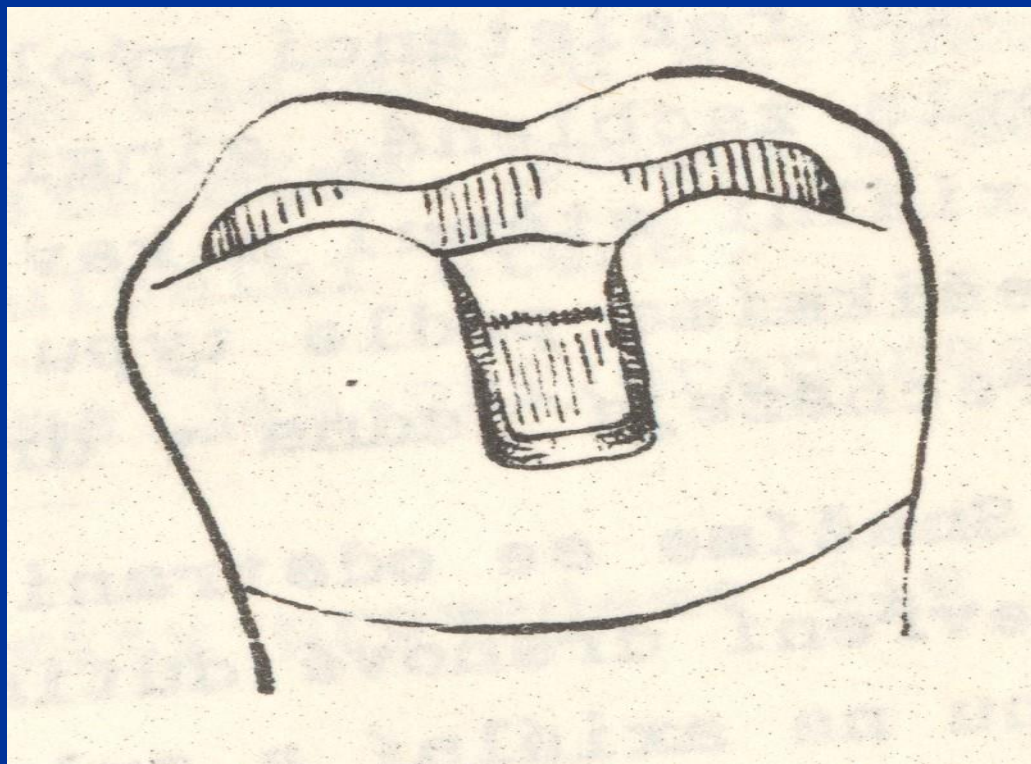
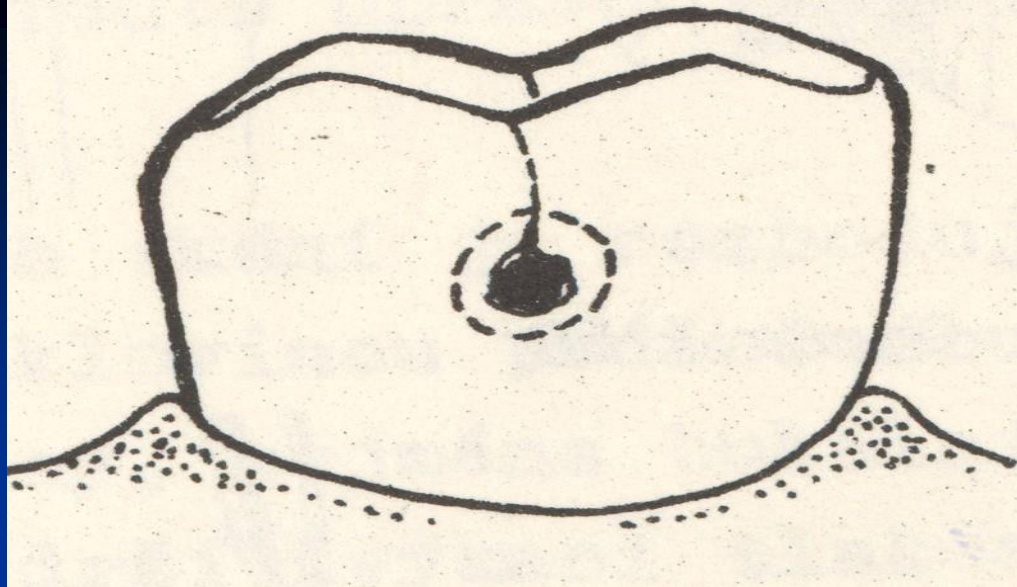

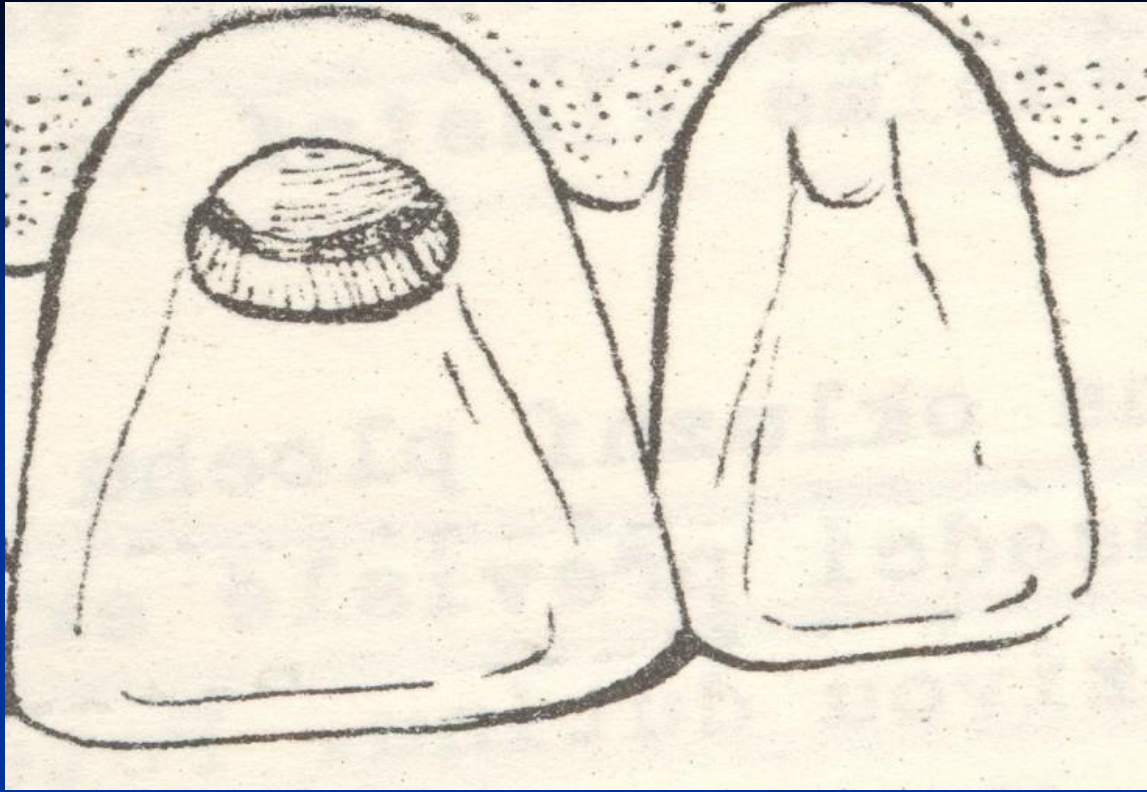

U kazů ve foramina coeca:
Preparace v rozsahu ložiska
Do dentinu
Lze podsekřiviny
Ohlazení okrajů

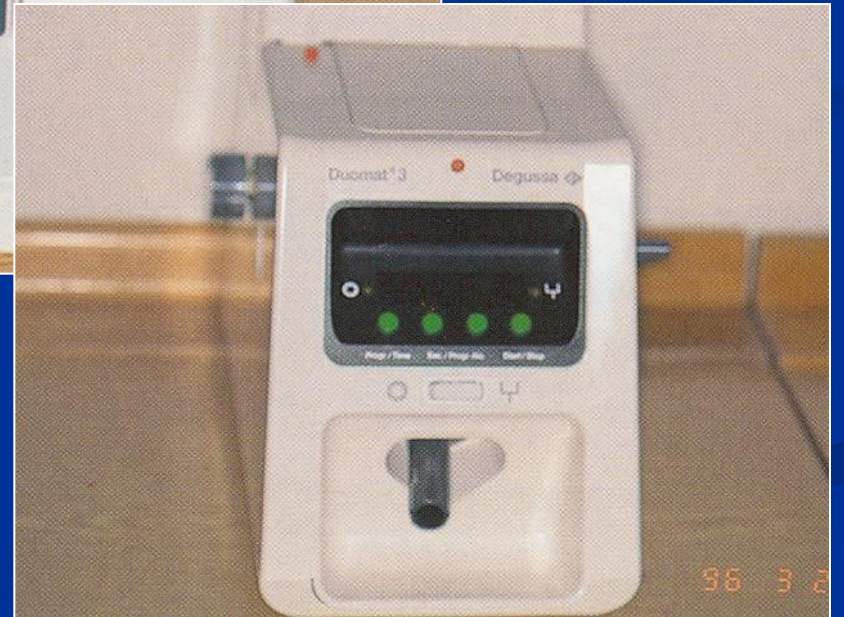

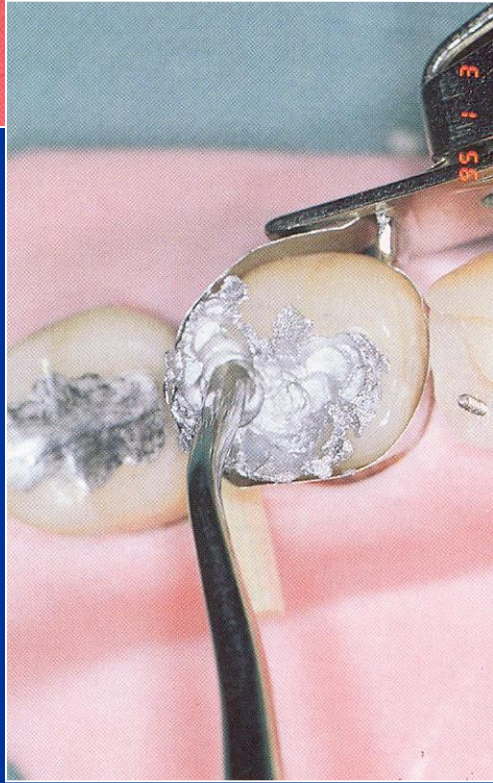
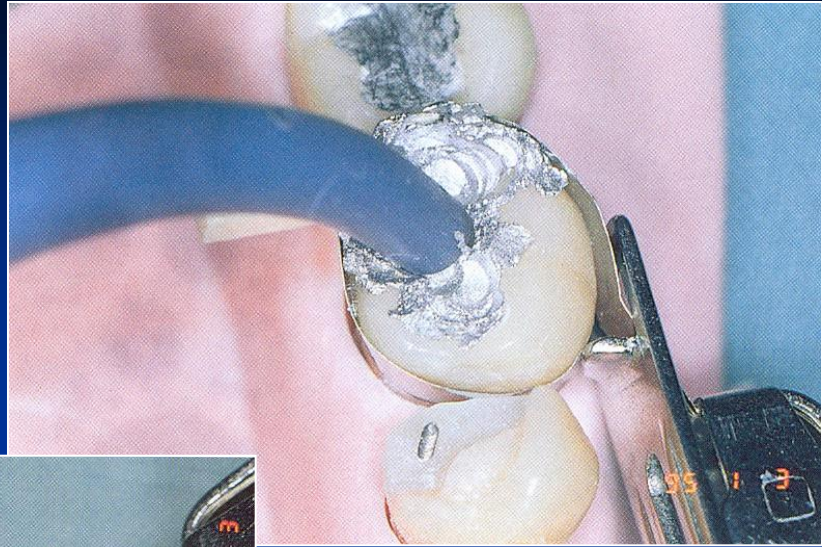
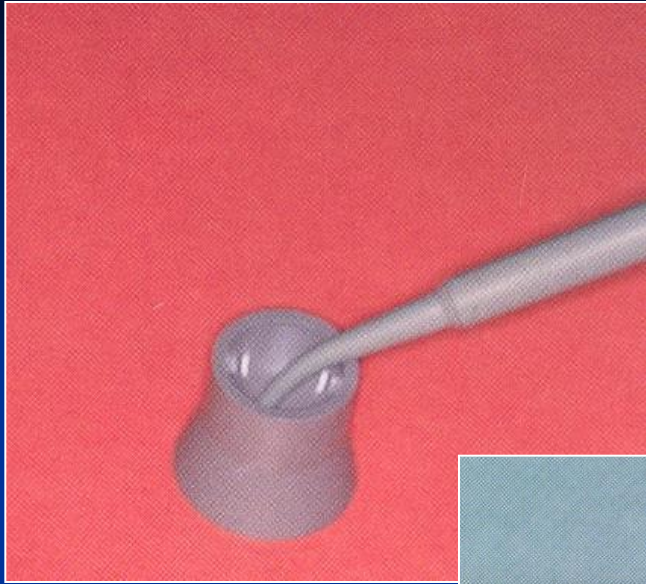

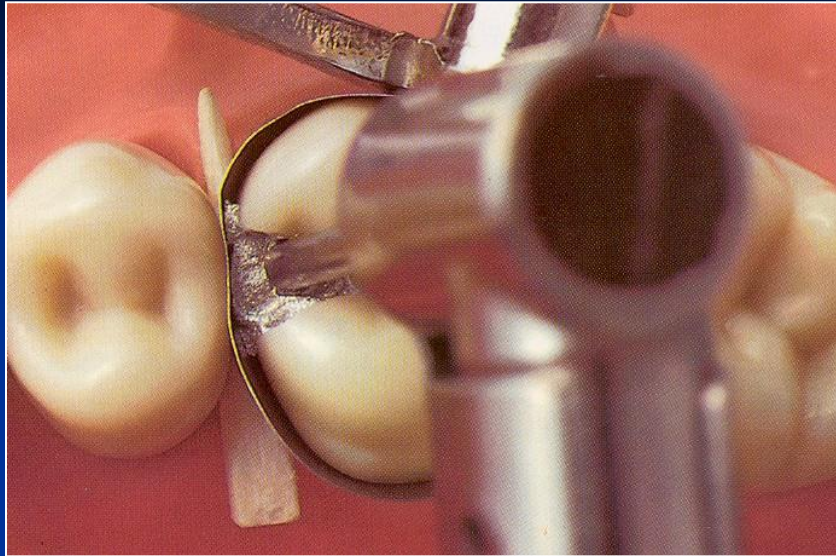



Instruments

- Preparation instruments
- Filling instruments
- Carvers
- Burnishers

Instruments

➤ Preparation instruments - power driven

Burs

Diamonds

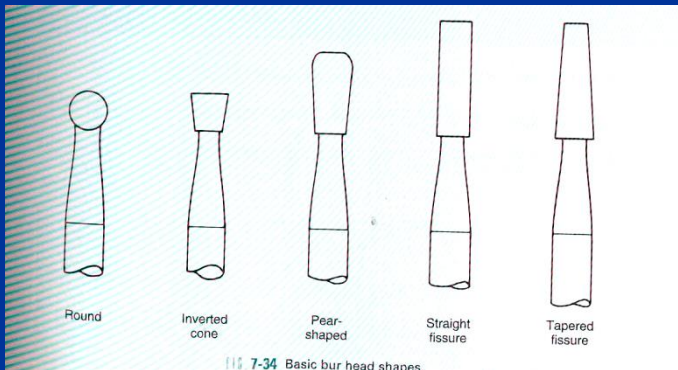

Instruments

➤ Preparation instruments - hand

Chisel



Excavator

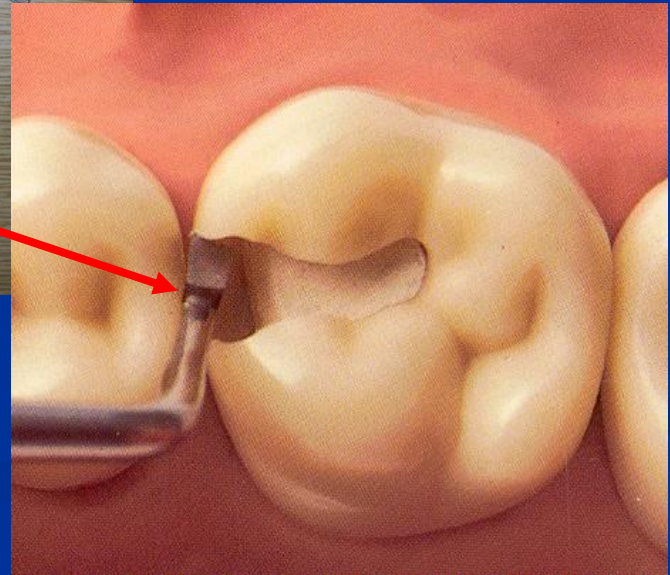
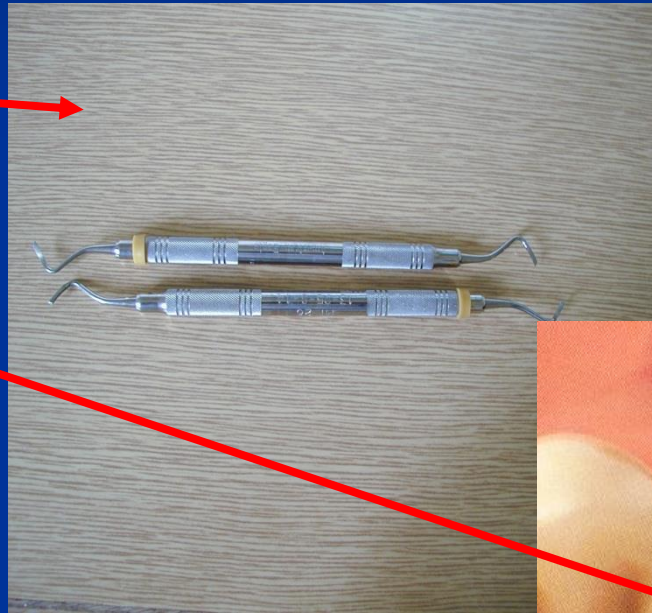

Amalgam gun

Crucible

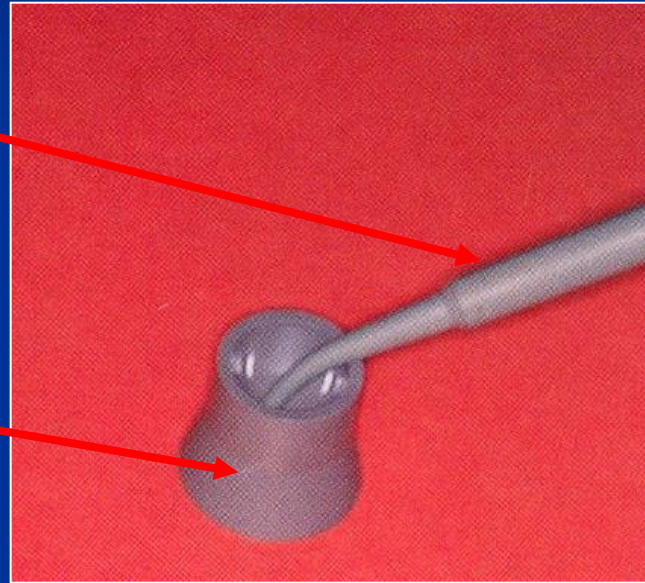

Amalgam carrier



Amalgam carrier



Instruments

- **Filling instruments condensers and spatulas**

Condensor - stamen

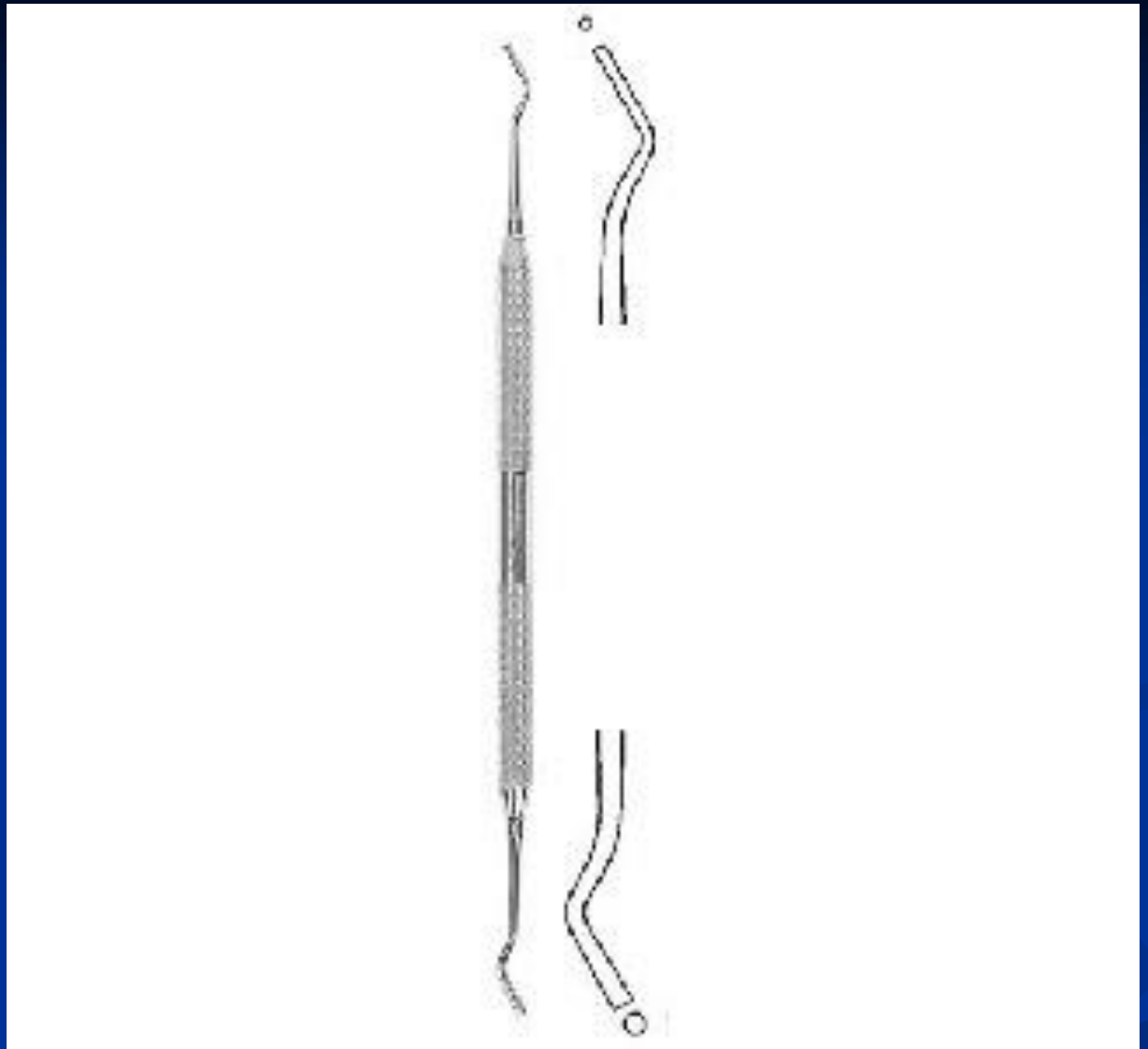

Condensor with straight front

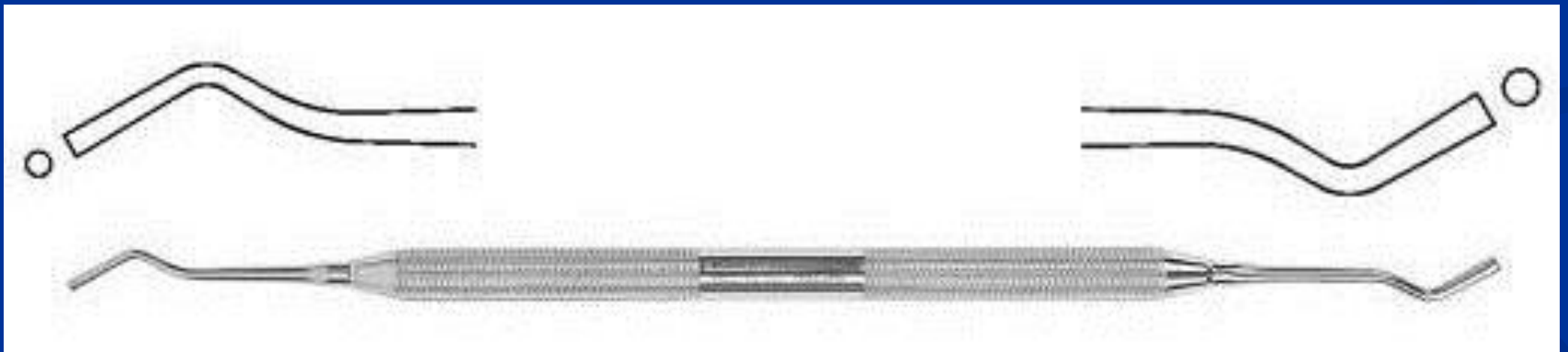

Condensor and burnisher - spatula combined



Power driven
condensor
- stamen

Special
handpiece

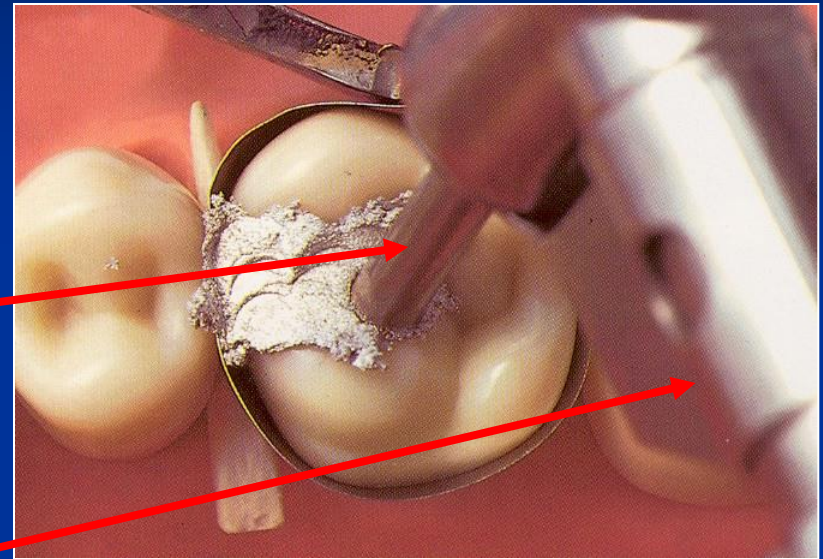

Burnisher - spatula

Angular- trough edge trough face

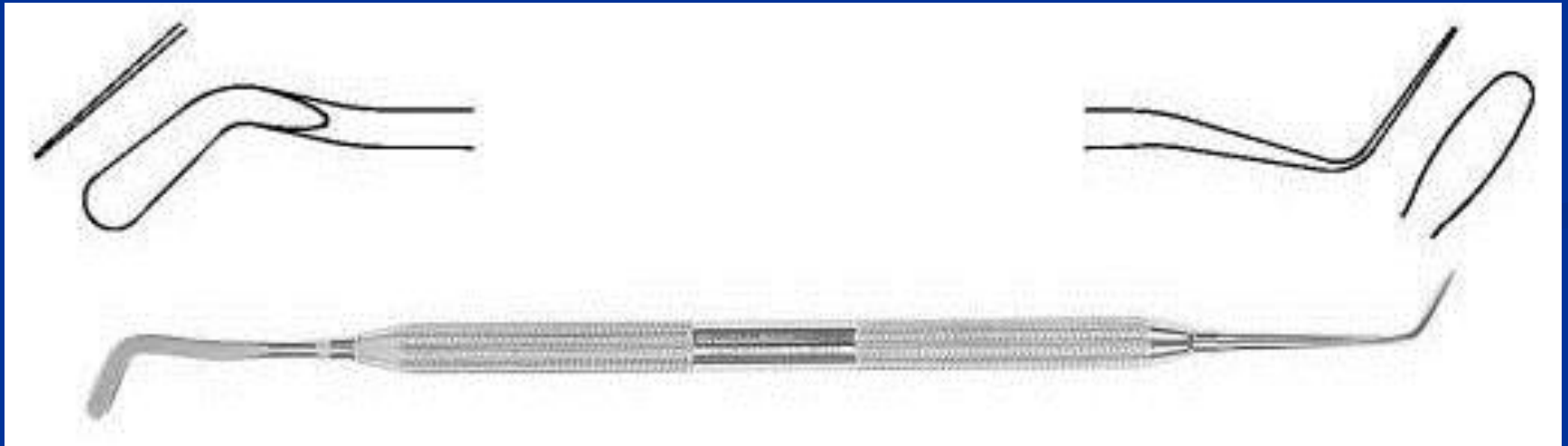

Burnisher – spatula, angular three face

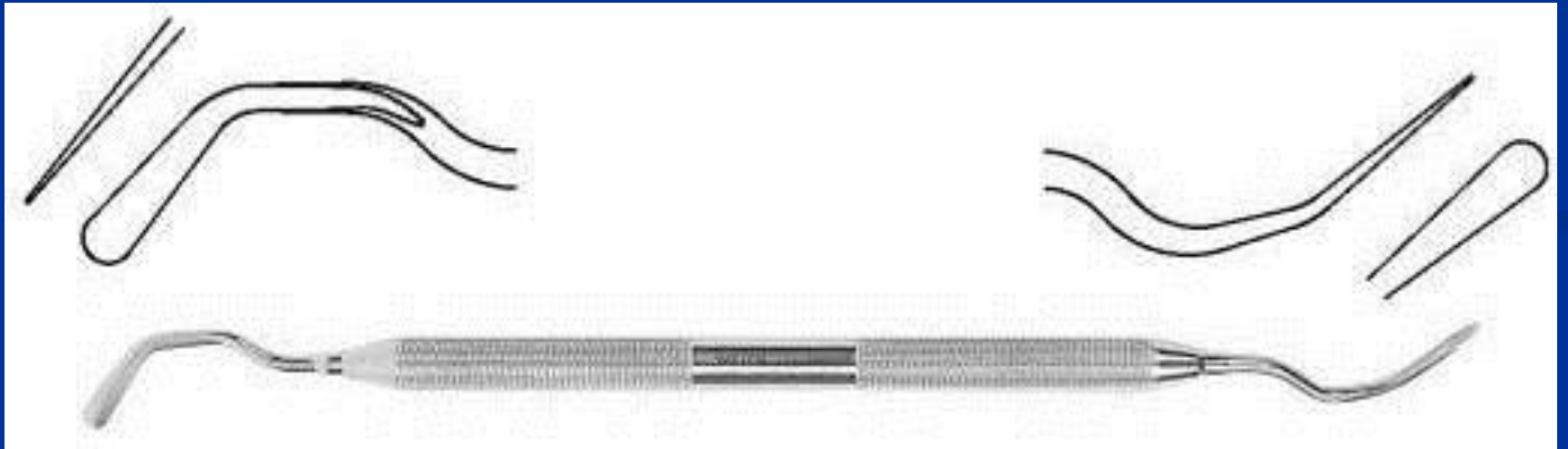

Instruments

- **Burnishers**

Ball condensor – used as a burnisher at most

