

Practical training in Histology and Embryology

Organization issues

- Beginning - **strictly on time**
- Change your shoes - you will not be allowed to enter the hall w/o indoor shoes
- Lockers – jackets, coats, bags etc.
- Cell phone – switched off or in silent mode
- Microscopic hall = **laboratory**
 - eating, drinking, smoking not allowed
 - smoking strictly forbidden anywhere in LF
 - students have to follow the instructions
 - academic misconducts or inappropriate behavior result in excluding from the lesson or course
- **Follow safety rules**
- **You have dedicated working place**
- **You are responsible for microscope, slide set, EM atlas**

- **Practical lesson**

- Introduction; the images free available through **MedAtlas**
- your individual work = study of the slides, schematic but precise drawing of tissue architecture, careful description. You make your own „study atlas“
- students come prepared for practices - schedules and syllables – pin-boards or dpt. webpage
- **your knowledge is verified during semester**
- **break – 10 minutes**

- **Attendance**

- 100% attendance
- substitution only in exceptional cases, after permissions from both the teacher of your group and the lesson where you plan to substitute
- sign in to the list
- make a protocol, let it check and signed by the lecturer

Registration of substitution:

Datum Date	Jméno Name	Ročník Year	Skupina Group	Č. praktika Nr. of practice	Č. místa Nr. of place	Vyučující - podpis Teacher- signature

- **Protocols**

- you have to make **paper protocols** (no tablets, laptops)
- A4 size, blank, without lines, **according to the template** (can be downloaded from www.med.muni.cz/histology - Education)
- (color)pencil handdrawings (**no pen**)
- **complete set of signed protocols** is required for getting the credits
- **the quality of the protocol** is approved by your teacher's signature at the end of practical lesson
- **incomplete or low-quality protocols cannot be approved** and you have to substitute the respective practical lesson

- Testing your knowledge

- every student is examined **4×** per semester
- testing the knowledge of **structures** of the **previous practical lesson**, including the **theory** (their English and Latin names, functions, development and biological context) **AND** the **theory** for the **current practical lesson**
- short written test with images or schemes, results: „Passed“ or „Not passed“
- all images and schemes are made public (MedAtlas, IS)
- you have to successfully pass all 4 **tests**
- if you fail in partial test, you can repeat it once per semester (**resit test**)
- failing in the partial tests result in the overall **Credit test** at the end of semester

Test 1	P	P	P	P	N
2	P	P	N → P (N)	N → P (N)	N
3	P	N → P (N)	P	N	N
4	P	P	N	N	N
	Credit given		Credit test	Semester must be repeated	

- **Credits**

- 100% attendance
- complete set of signed protocols from all lessons
- passed four tests

- **End of practical lesson:**

- the practice is closed by the lecturer
- you are allowed to leave your working place only after checking the microscope and slides
- if you leave before the check you may be responsible for any damages/losses recognized later

RECOMMENDED LITERATURE

- Čech, S. a D. Horký. **Přehled obecné histologie**. 1. vyd. Brno: Masarykova univerzita, 2005. 140 s. ISBN 8021038543.
- Horký, D. a S. Čech. **Mikroskopická anatomie**. 2. nezm. vyd. Brno: Masarykova univerzita, 2005. 353 s. ISBN 802103775X.
- Čech, S., D. Horký a M. Sedláčková. **Přehled embryologie člověka**. 1. vyd. Brno: Masarykova univerzita, 2011. 187 s. ISBN 978-80-210-5414-1.
- Mescher, A.L. **Junqueira's basic histology :text and atlas**. 13th ed. New York: McGraw-Hill Medical, 2013. xi, 544. ISBN 9781259072321.
- Moore, K.L., T.V.N. Persaud a M.G. Torchia. **The developing human :clinically oriented embryology**. 9th ed. Philadelphia, PA: Saunders/Elsevier, 2013. xix, 540. ISBN 9781437720020.
- Vacek, Z. **Embryologie :učebnice pro studenty lékařství a oborů všeobecná sestra a porodní aistentka**. 1. vyd. Praha: Grada, 2006. 255 s. ISBN 9788024712673.
- Sadler, T.W. **Langmanova lékařská embryologie**. 1. české vyd. Praha: Grada, 2011. xviii, 414. ISBN 9788024726403.
- Kapeller, K. a V. Pospíšilová. **Embryológia človeka: učebnica pre lekárske fakulty**. Martin: Osveta, 2001. 370 s. ISBN 80-8063-072-0.
- Lüllmann-Rauch, R. **Histologie**. Translated by Radomír Čihák. 1. české vyd. Praha: Grada, 2012. xx, 556. ISBN 9788024737294.
- Ovalle, W.K., P.C. Nahirney a F.H. Netter. **Netter's essential histology**. 2nd ed. Philadelphia, PA: Elsevier/Saunders, 2013. xv, 517. ISBN 9781455706310.
- Young, B. **Wheater's functional histology :a text and colour atlas**. 5th ed. [Oxford]: Churchill Livingstone, 2006. x, 437. ISBN 044306850X.
- Sadler, T.W. a J. Langman. **Langman's medical embryology**. Illustrated by Jill Leland. 11th ed. Baltimore, Md.: Lippincott William & Wilkins, 2010. ix, 385. ISBN 9781605476568.
- Lowe, J.S. a P.G. Anderson. **Stevens and Lowe 's Human Histology**. 4th. : Elsevier, 2015. ISBN 978-0-7234-3502-0.

+

**Lectures
Protocols**

MedAtlas verze 2.1

Písmo Obraz Nápvěda

Obecná histologie

Mikroskopická anatomie

Histologická praktika

- ▶ Text
- ▼ Atlas
 - ▶ 6.2 Atlas EM snímků
 - ▶ 6.4 Morfologie a vývoj I
 - ▶ 6.5 Embryologie I
 - ▶ 6.6 Embryologie II
 - ▶ 6.11 Kardiovaskulární
 - ▶ 6.12 Lymfatický systém
 - ▶ 6.13 Dýchací systém
 - ▶ 6.14 Trávicí systém
 - ▼ 6.15 Močový systém
 - Ren - přehled
 - Ren - corpusculum
 - Ren - cortex
 - Ren - medulla
 - Ren - vazivo
 - Calyx renalis
 - Ureter - přehled
 - Ureter - vazivo
 - Vesica urinialis - tur
 - Urethra feminina - 1
 - Urethra masculina
 - Urethra masculina
 - ▶ 6.16 Pohlavní systém
 - ▶ 6.17 Endokrinní žlázy
 - ▶ 6.18 Nervový systém
 - ▶ 6.19 Smyslové orgány

Atlas - Obr. 6-15-9: U

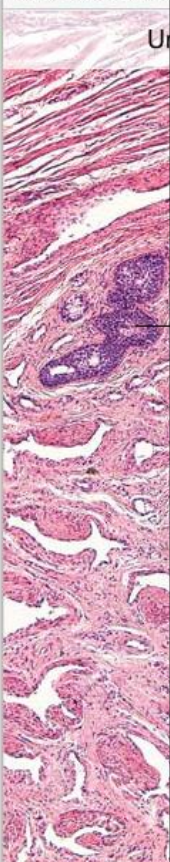

INTERAKTIVNÍ EMBRYOLOGICKÝ ATLAS ČLOVĚKA

Ústav histologie a embryologie – Lékařská fakulta
MUDr. Jana Důmková

Úvod

Poděkování

Atlas

OlyVIA

Zajímavé odkazy

8 – Vývoj endokrinních žláz

8-3 Zárodek člověka (8. týden) – vývoj štítné žlázy a příštítných žláz, příčný řez krční krajinou, HE, zvětšení 50x

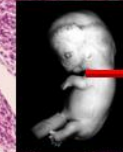
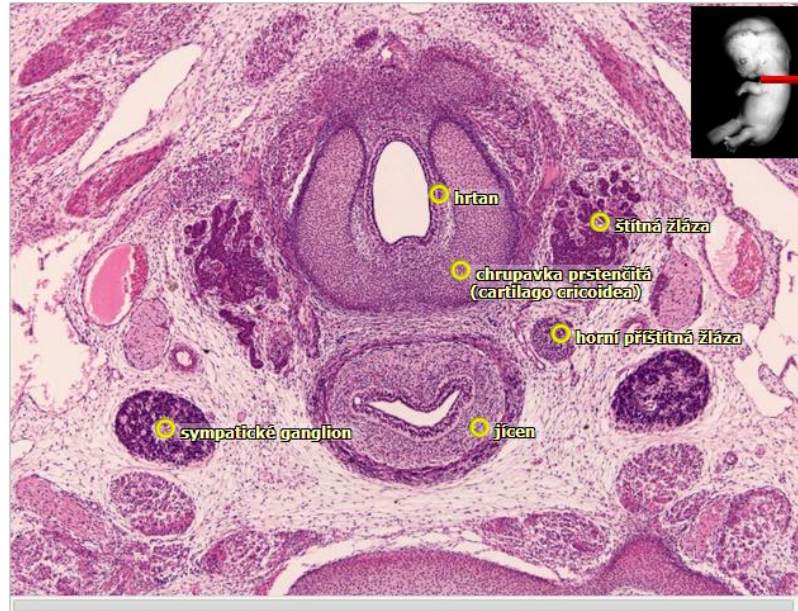

hrtan

štítná žláza

chrupavka prstencitá (cartilago cricoidea)

horní příštítná žláza

sympatické ganglion

jícen

- Na celou obrazovku
- Skrýt popisky
- Vyzkoušejte se

Epitel základů štítné žlázy vytváří zpočátku solidní neluminizované trámce, které se ukládají v dolní části chrupavky štítné. Z nich se později vytvářejí folikuly typické stavby. Dorzálně se ke štítné žláze připojují drobná příštítná tělíška.

- Timetable
- Master's degree program
- Bachelor's degree program
- Multimedia, textbooks**

<http://www.>



HISTOLOGY

- structure and ultrastructure of normal cells and tissues,
 - **cytology and general histology**
 - **special histology** = microscopic anatomy of individual organs
-
- relevance: oncology, surgery, hematology, pathology, forensic,...

EMBRYOLOGY

– prenatal (intra uterine) development

- **General embryology** (until 2nd month – EMBRYO)

gametogenesis and early embryonic development

- **Special embryology** (since 3rd month to birth – FETUS)

organogenesis

- **Teratology** – defects in organ development, malformations, anomalies; prenatal screening – ultrasonography, amniocentesis, genetic and karyotype screening

- Relevance: gynecology and obstetrics, pediatrics, assisted reproduction

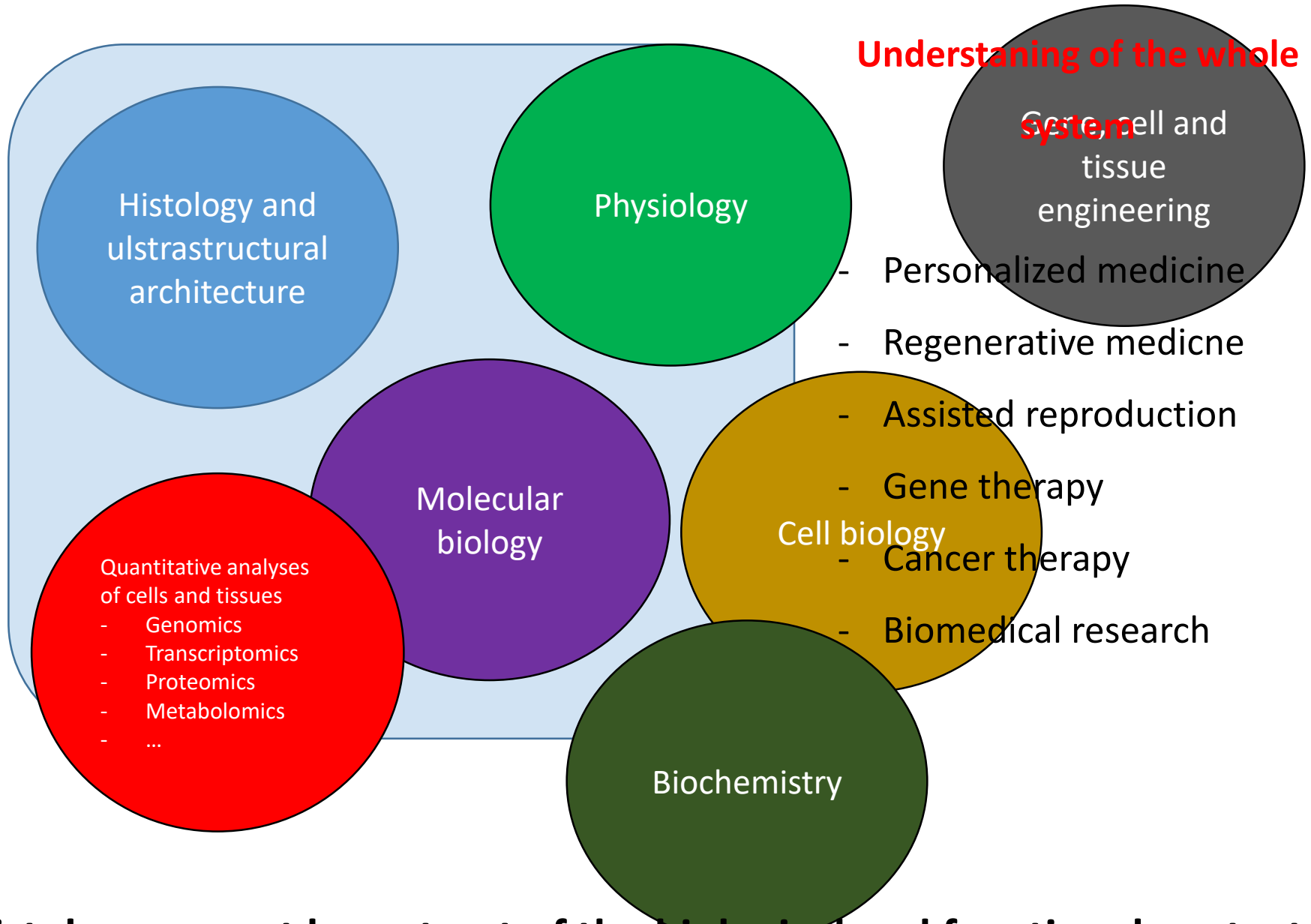

Histology cannot be put out of the biological and functional context

Histology

- Resolution of naked eye – 0,1 - 0,2 mm
- Resolution of light microscopy – 0,2 μm
- Resolution of electron microscopy – 1-2 nm

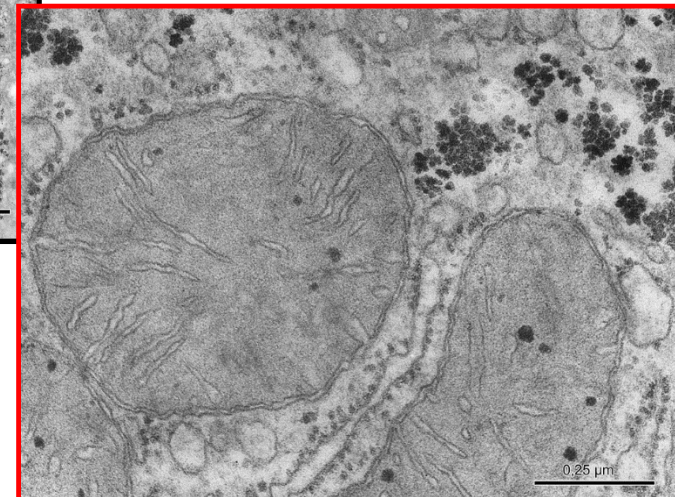
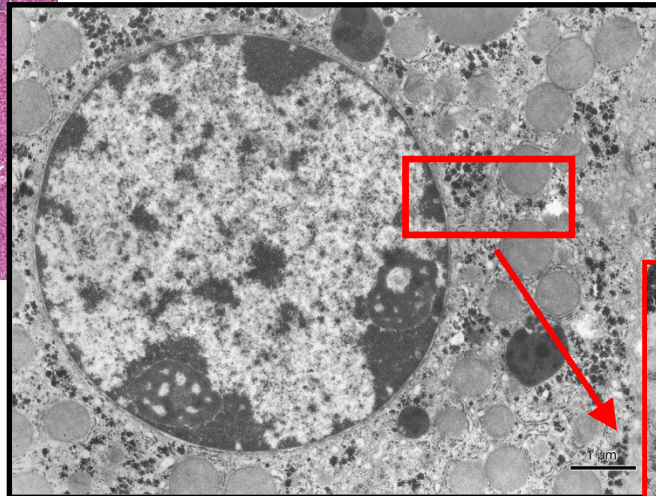
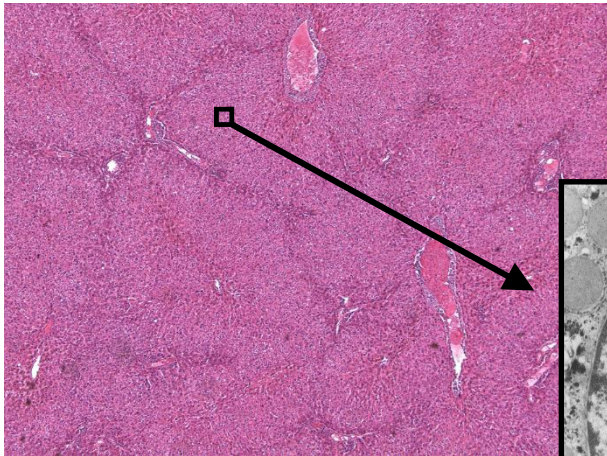

Tissue processing for the light microscopy (LM)

(making of permanent preparations – slides)

- **SAMPLING** (obtaining of material – cells, tissue pieces)
- **FIXATION** of samples (tissue blocks)
- **RINSING** (washing) of samples
- **EMBEDDING** of samples - embedded blocks into **PARAFFIN**
- **CUTTING** of blocks - sections
- **AFFIXING** of sections
- **STAINING** of sections
- **MOUNTING** of sections

SAMPLING

- A small piece of organ (tissue) is sampled and quickly put into the fixative medium.
- Biopsy during surgical dissection of organs in living organism
 - = excision
 - = puncture (liver or kidney parenchyma, bone marrow)
 - = curettage (uterine endometrium, adenoid vegetation)
- Necropsy from dead individual (sections); in experiments laboratory animals are used and tissue have to be sampled as soon as possible after the break of blood circulation
- The specimens shouldn't be more than **5 – 10 mm³** thick and fixation should follow immediately.

FIXATION

- Definition: denaturation and stabilization of cell proteins with minimum artifacts
- The reason of fixation: freshly removed tissues are chemically unstable – dry, shrink, undergo hypoxia, autolysis and bacteriological changes
- To stop or prevent these changes and preserve the structure tissue samples have to be fixed. During the fixation, all tissue proteins are converted into inactive denaturated (stable) form.
- 3 main requirements on fixatives:
 - good preservation of structure
 - quick penetration into tissue block
 - no negative effects on tissue staining

- Fixatives: solutions of different chemicals
 - **organic fixatives** – ALDEHYDES – formaldehyde (*most frequently used for LM*)
 - glutaraldehyde (*used for EM*)
 - ALCOHOLS – 96 – 100 % (absolute) ethylalcohol
 - ORGANIC ACIDS – glacial acetic acid, picric acid, trichloroacetic acid
 - **inorganic fixatives** – INORGANIC ACIDS – chromic acid, osmium tetroxide (OsO₄)
 - SALTS OF HEAVY METALS – mercuric chloride HgCl₂
 - **compound fixatives** – mixtures (two or more chemical components to offset undesirable effects of individual (simple) fixatives.
 - FLEMMING's fluid – with OsO₄
 - ZENKER's and HELLY's fluid, SUSA fluid – with HgCl₂
 - BOUIN's fluid – with picric acid
 - CARNOY's fluid – with alcohol

Fixation is carried out at the room temperature, the time varies between **12 – 24 hours**, specimen must be overlaid by 20 – 50 times fixative volume:

Ratio of tissue block volume to fixative volume 1 cm³ : 20 – 50 cm³

RINSING and EMBEDDING

- All samples should be washed to remove the excess of fixative; the choice of rinsing medium is determined by type of fixative: running tap-water or 70-80% ethanol
- Relevance of embedding: tissues and organs are brittle and unequal in density, they must be hardened before cutting

Embedding media

- water soluble – gelatine, celodal, water soluble waxes
- anhydrous – paraffin, celoidin

EMBEDDING into PARAFFIN

- dehydration – to remove water from fixed samples by ascending series of ethanol is used (50%, 70%, 90%, 96%. each step - 2 – 6 hours
- clearing – the ethanol must be replaced with organic solvantant that dissolves paraffin – benzene or xylene
- infiltration – melted paraffin wax (56°C) is used; 3 x 6 hours.
- casting (blocking out) – moulds (plastic, paper or metal chambers) are used for embedding.
 - The moulds are filled with melted paraffin, tissue samples are then placed inside and immediately immersed in cold water to cool paraffin quickly down.
 - These paraffin blocks are ready for trimming



Leica TP 1020

Automated device for tissue dehydration

Paper chambers



- metal

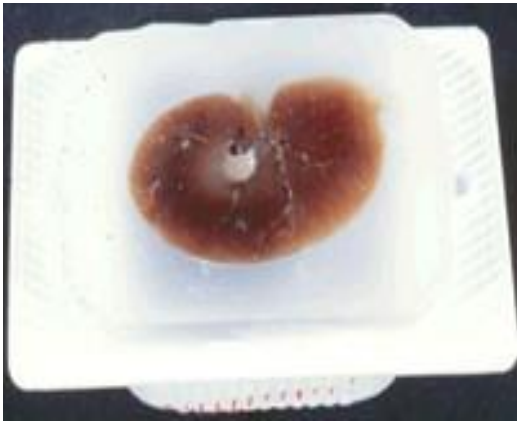

CUTTING

- Microtome – a machine with automatic regulation of section thickness: 5 – 10 μm is optimum.

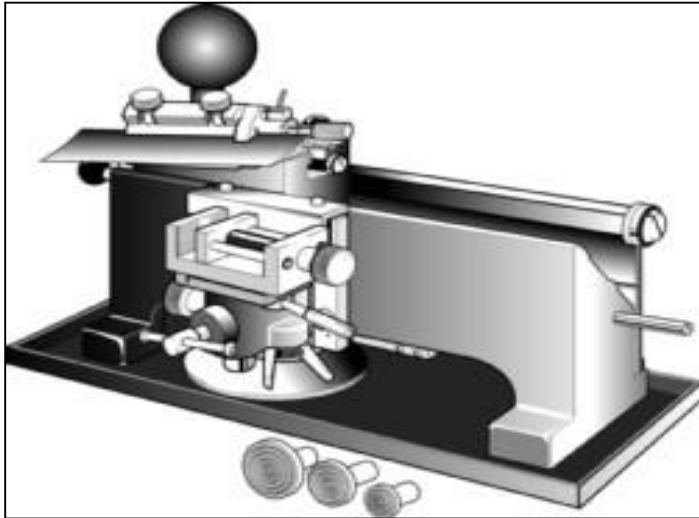

sliding microtome – block is fixed in holder, knife or razor moves horizontally

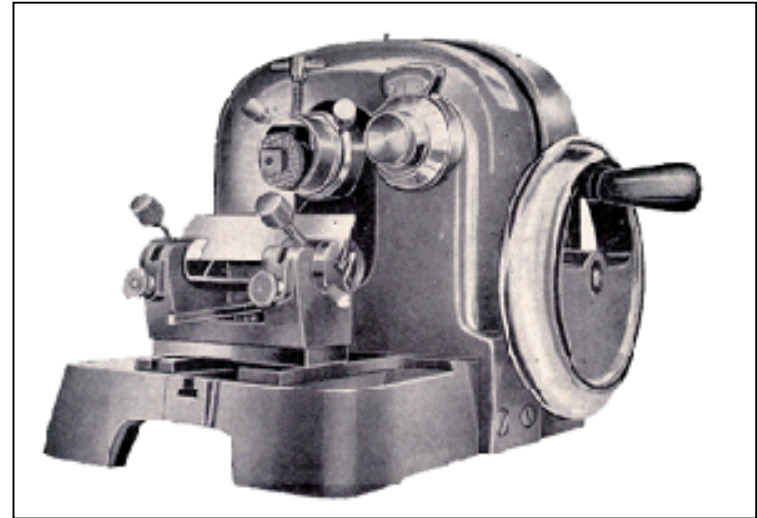

rotary microtome – knife is fixed, block holder moves vertically

Sliding microtome

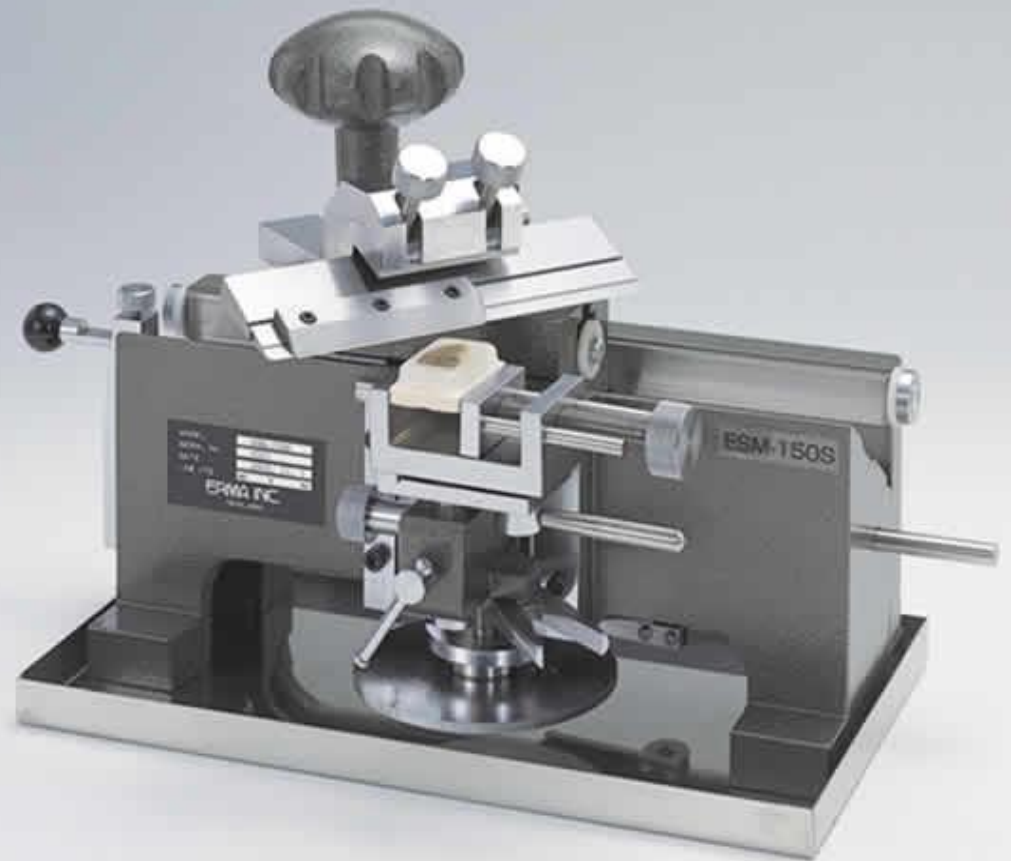

Rotary microtome



Freezing microtome (**cryostat**)
= rotary microtome housed in freezing box
(- 60° C)

Cutting of frozen tissue without the embedding

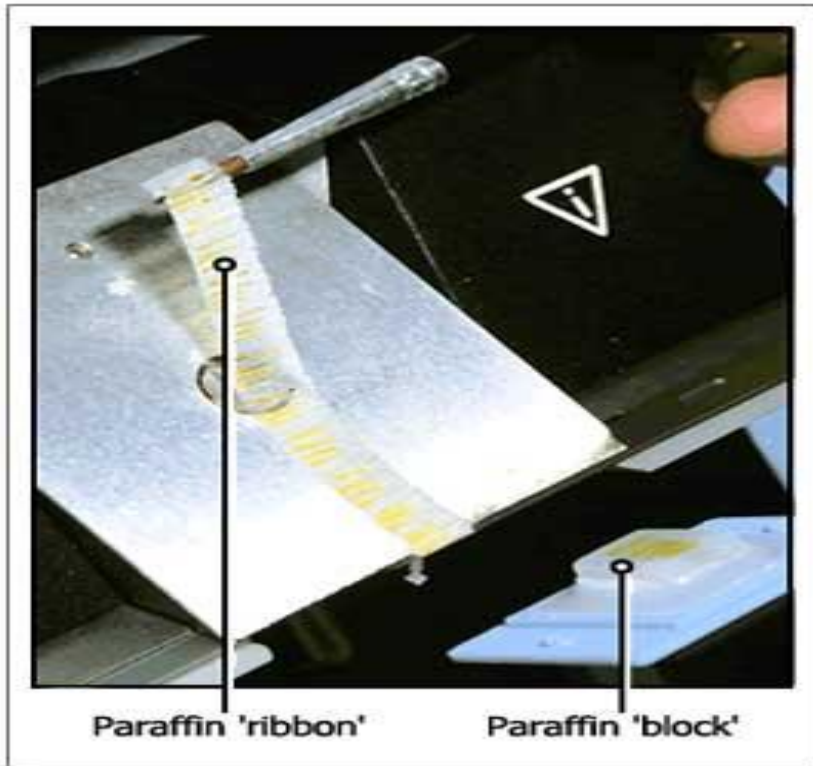

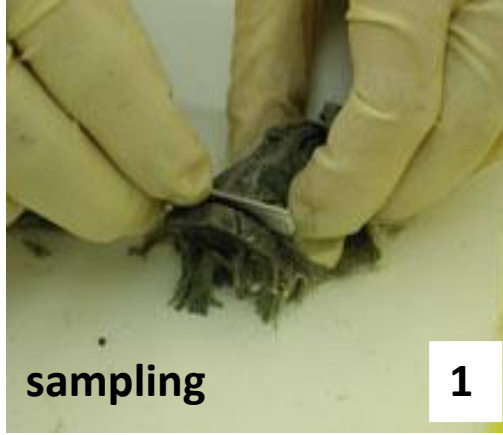

sampling

1

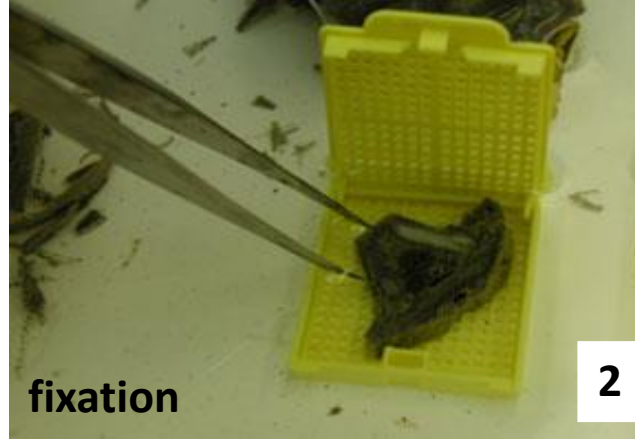

fixation

2

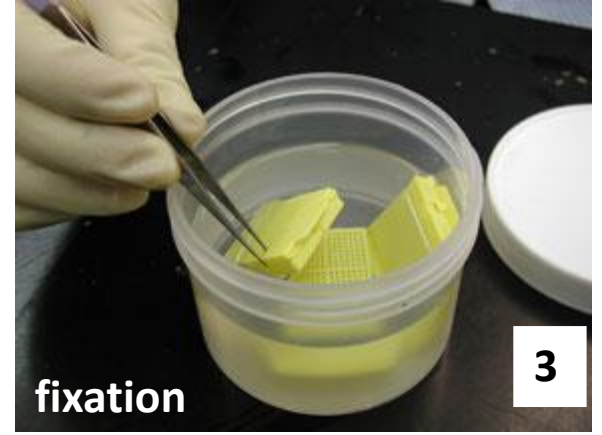

fixation

3



paraffin embedding

4

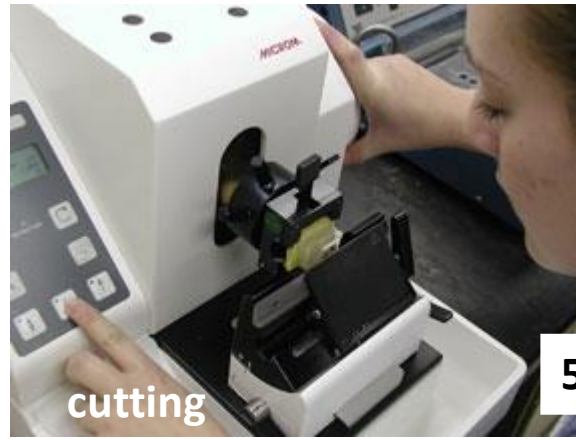

cutting

5

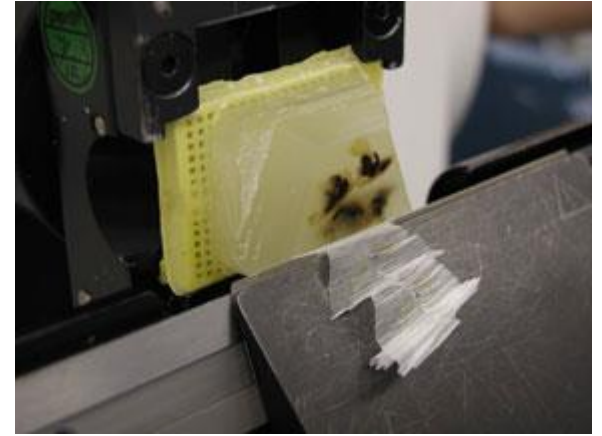

section affixing

6

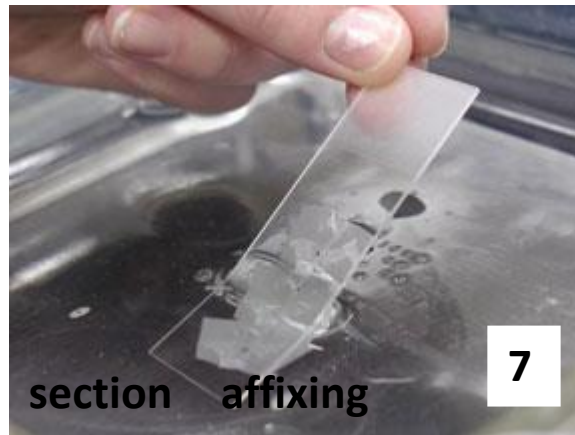

section affixing

7

MICROM

5

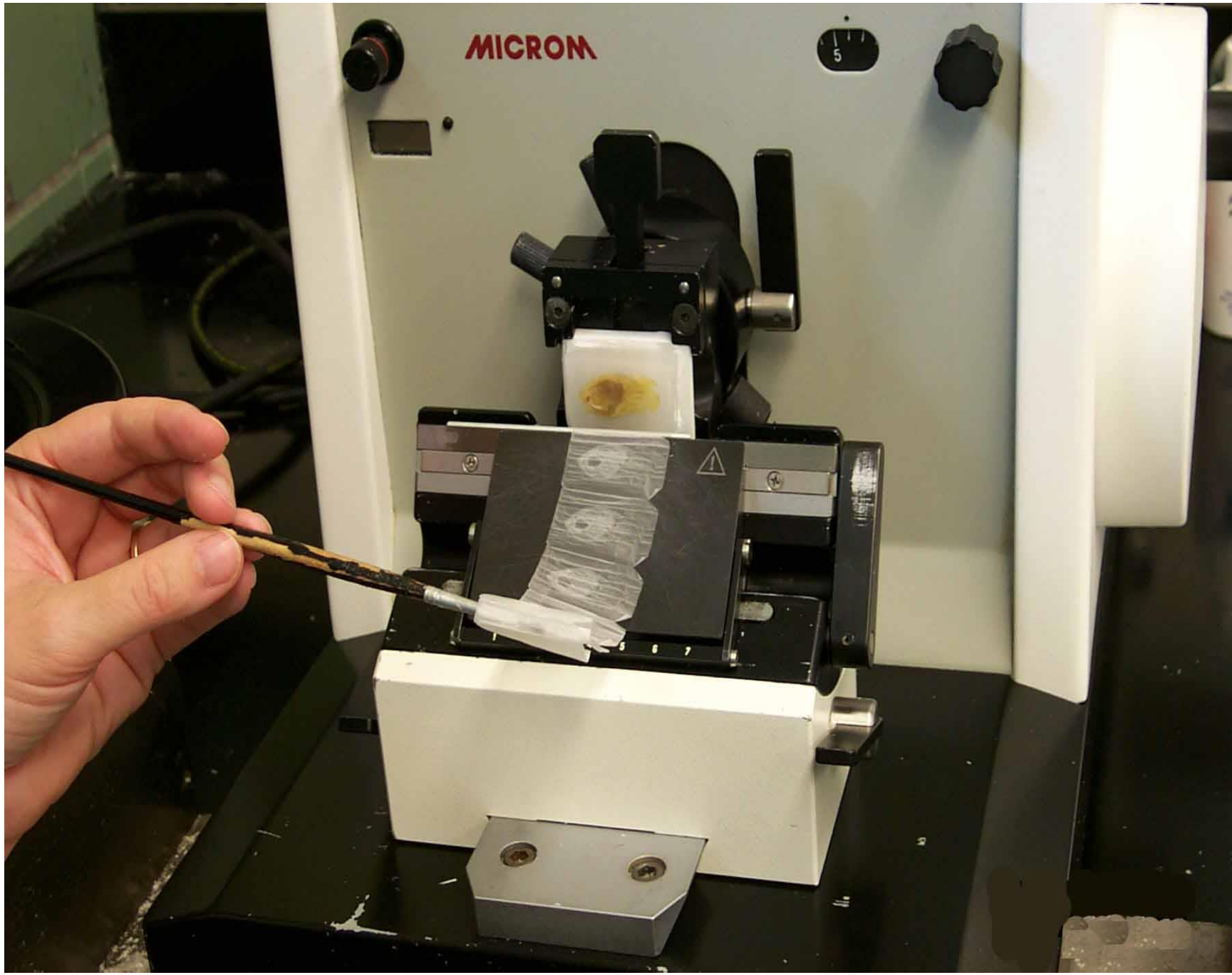

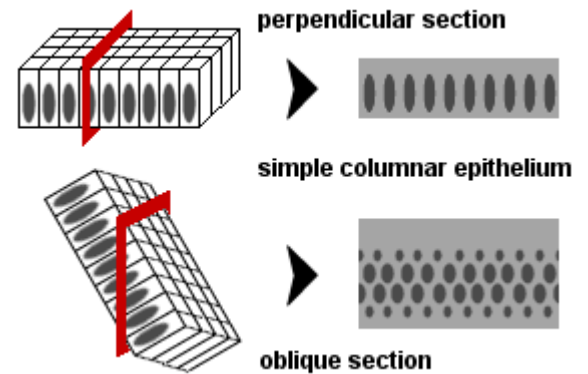
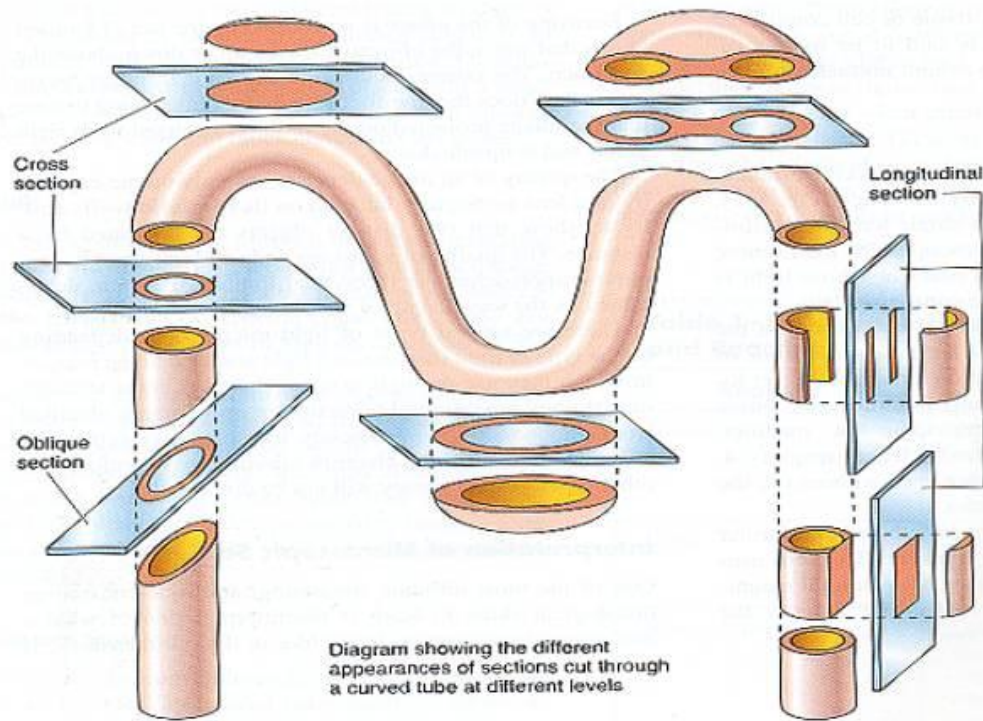

AFFIXING

- Mixture of glycerin and egg albumin or gelatin
- Section are transferred from microtome razor or knife on the level of warm water (45° C), where they are stretched; then they are put on slides coated with adhesive mixture; excess of water is drained and slides are put in incubator (thermostat, 37° C) over night to affixing of sections.



Stretching of sections on warm water



Stretching on a warm plate



STAINING

- different cell or tissue structures are not apparent without staining.
- cellular structures exhibit different affinity to staining dyes

alkaline dyes (basic or nuclear) – react with anionic groups of cell and tissue components

basophilia – basophilic structures in the cell

acid dyes (cytoplasmic) – react with cationic groups

acidophilia – acidophilic structures in the cell

neutrophilia – no reaction

Staining methods:

routine – HE, AZAN

(demonstrate all components of tissue)

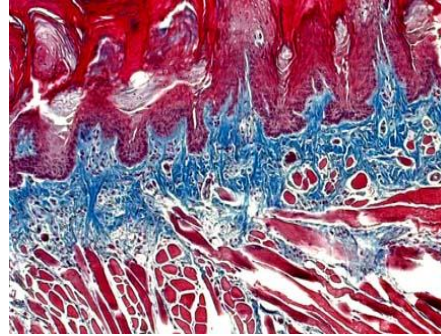
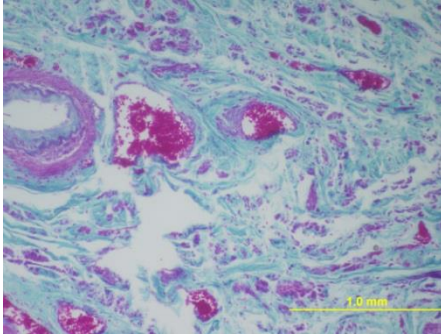

HE – the most frequent used method

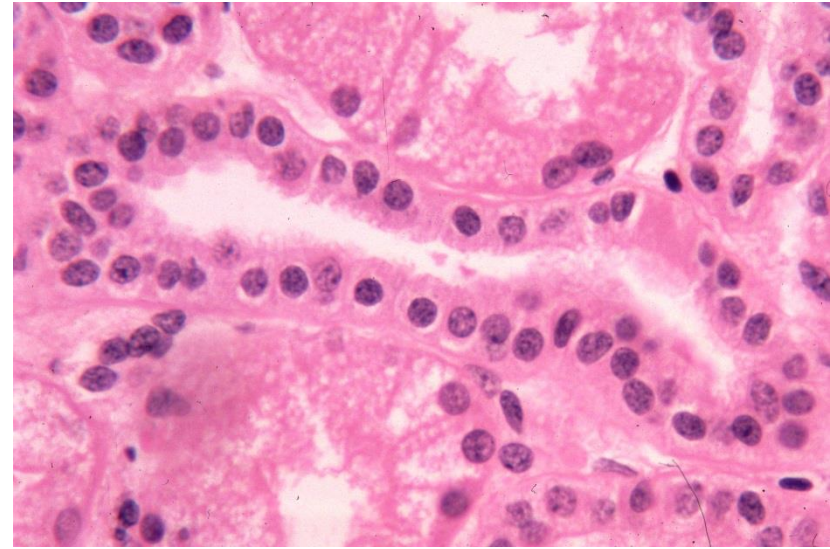

special

visualizes only special structures

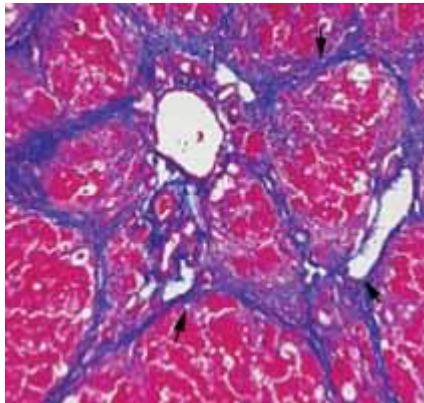

*Lipid droplets
detected by oil red*

impregnation

by silver salt for detection
of nerve or reticular fibers

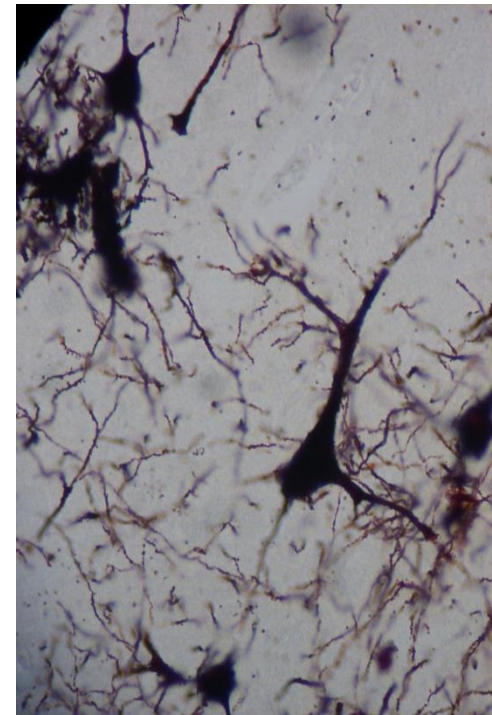

ROUTINE STAINING with HEMATOXYLINE – EOSIN (HE)

Hematoxyline – basic (nuclear) dye

Eosin – acid (cytoplasmic) dye



- Staining procedure:
- paraffin must be removed (dissolved) by xylene
- sections are rehydrated in descending series of ethanol (100% →96% →80%)
- staining with hematoxyline
- differentiation in acid ethanol and water (excess of dye is removed)
- staining with eosin
- rinsing in water (excess of dye is removed)
- dehydration in graded ethanol series (80% →96% →100%)
- clearing in xylene

HEMATOXYLINE – EOSIN (HE)

Deparaffination

Rehydration

Washing

Staining

Differentiation

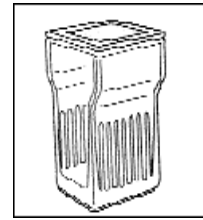
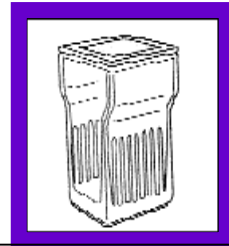
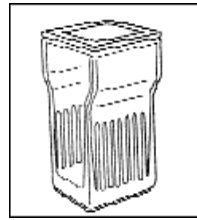
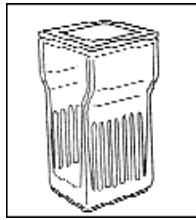
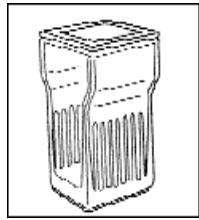
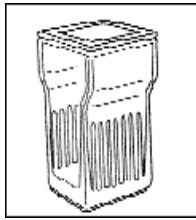
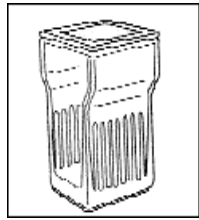

Xylen I

Xylen II

100%
ethanol

96%
ethanol

H₂O

hematoxyline

acid
ethanol

Clearing

Dehydration

Washing

Staining

Washing

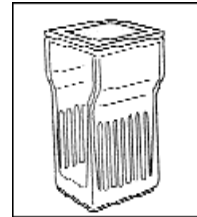
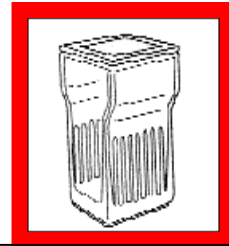
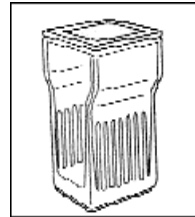
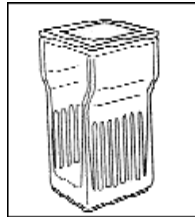
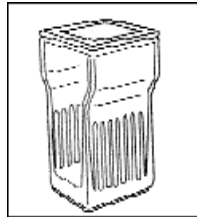
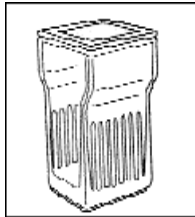
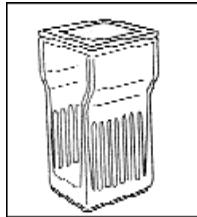

Xylen IV

xylen III

100%
ethanol

96%
ethanol

H₂O

eosin

H₂O

Staining results:

- **HE** = *Hematoxyline – Eosin*
nuclei – bright clear blue or dark violet
cytoplasm and collagen fibers – pink
erythrocytes, muscle tissue – red

- **HES** = *Hematoxyline – Eosin – Safron*
connective tissue – yellow

- **AZAN** = *AZocarmin – ANiline blue – orange G*
nuclei – red
erythrocytes – orange
muscle – red
collagen fibers – blue

Staining tools:



cuvette

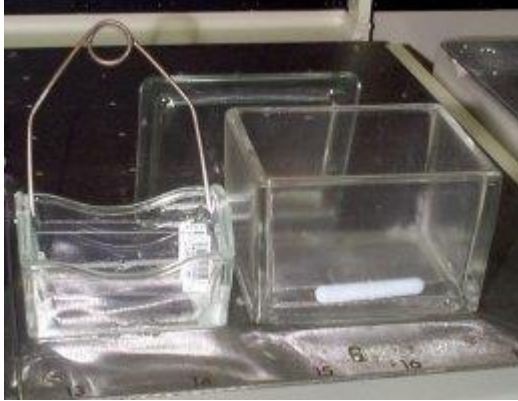
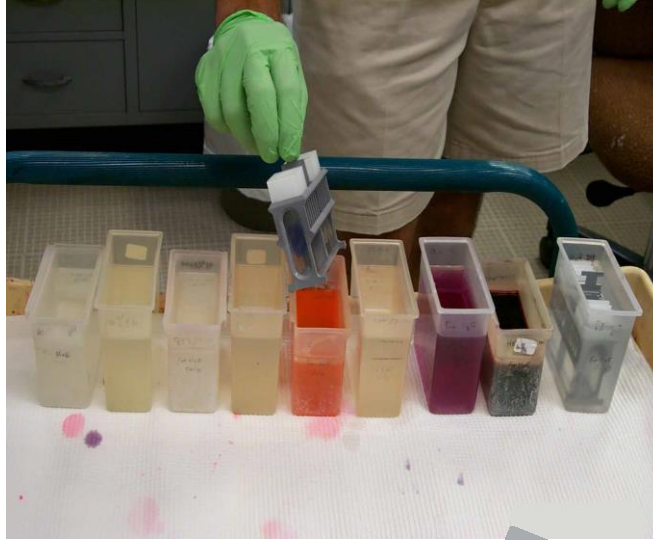

flask

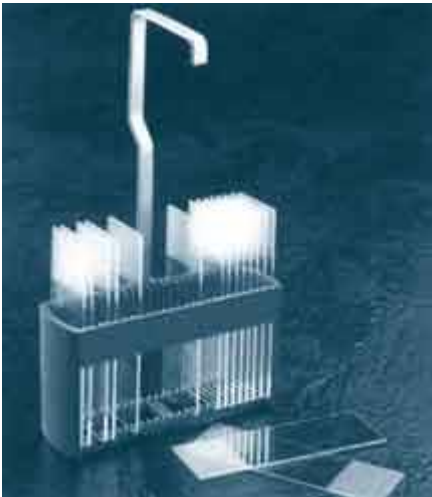

slides holder
(basket)

Automatic slide stainer



staining set of boxes with media



MOUNTING

- Finally, preparates are closed with coverslip (coverglass) to form a permanent preparate. Small amount of mounting medium must be placed between stained section and the coverslip.

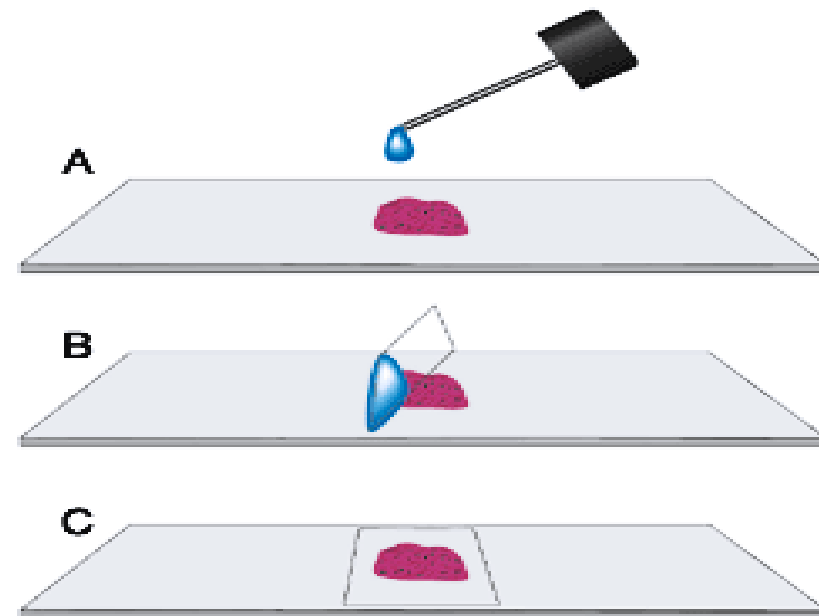
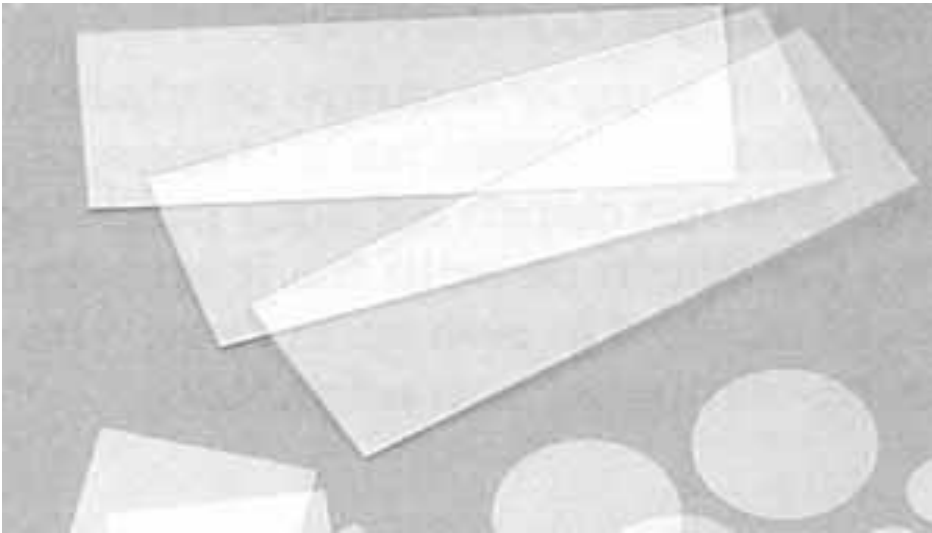

- Mounting media:** soluble in xylene – **canada balsam**
soluble in water – glycerin-gelatine, arabic gum



Permanent histological slides for study in the light microscope

Hematoxyline and eosin (HE)

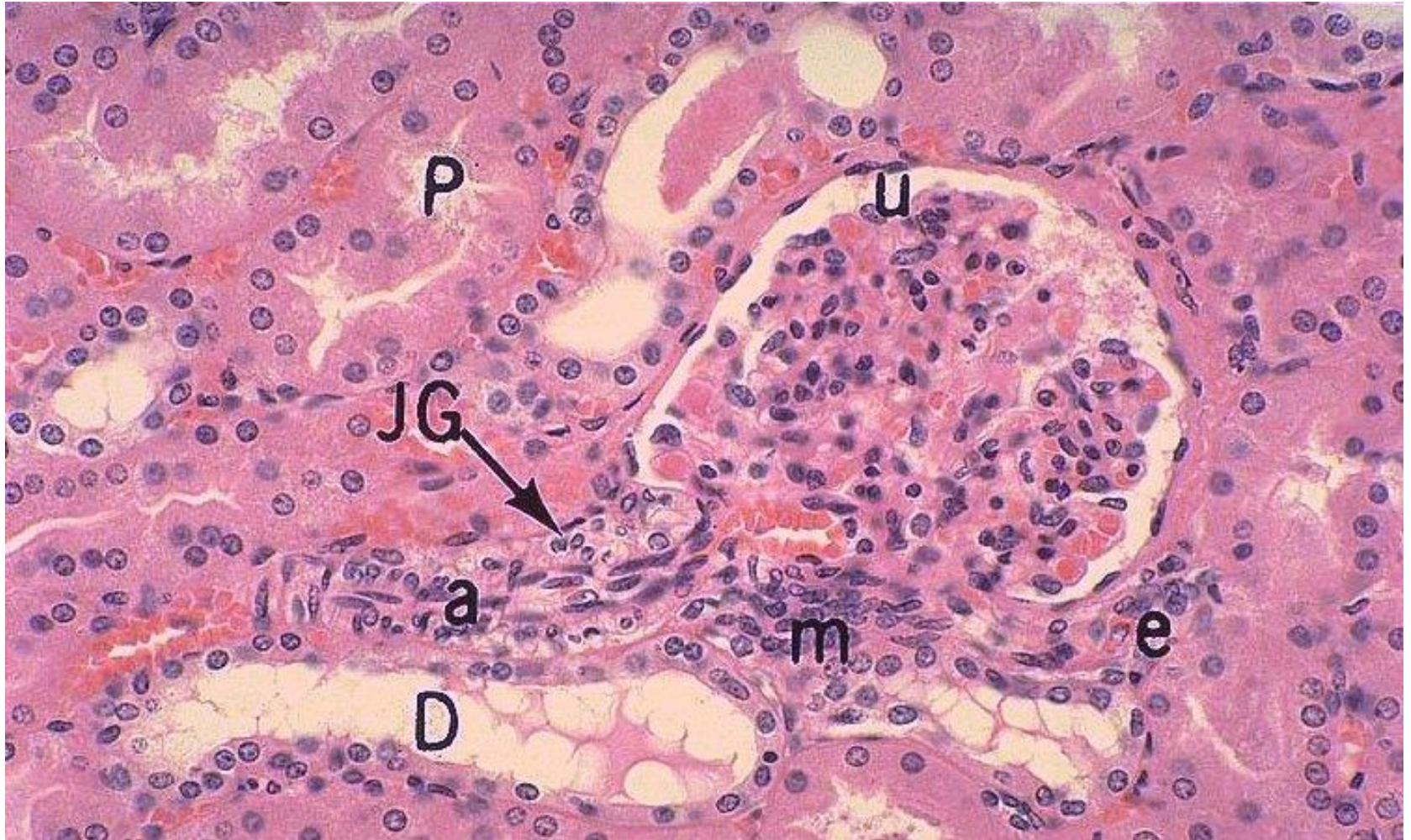

Hematoxyline and eosin (HE)

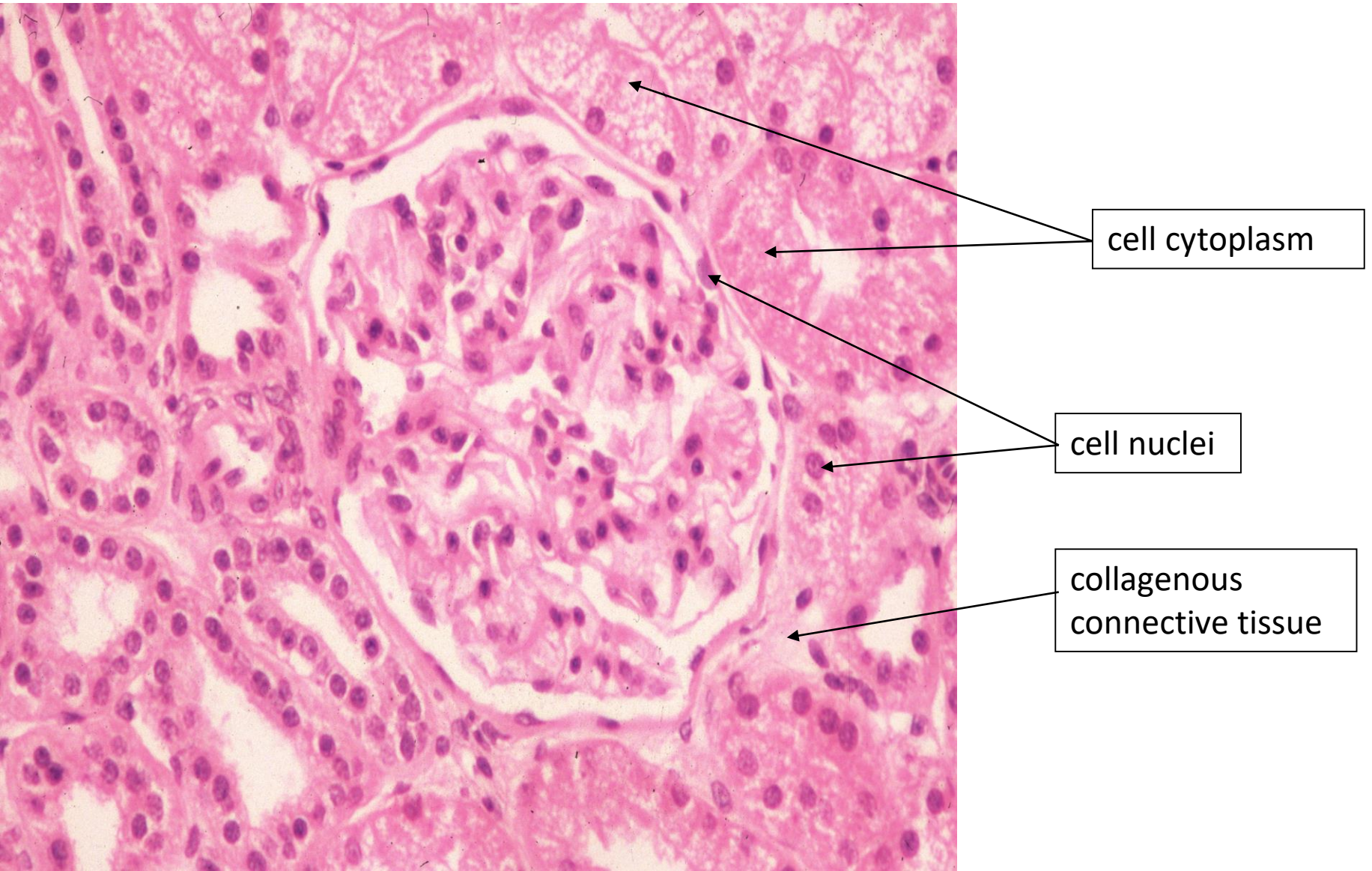

Hematoxyline and eosin (HE)

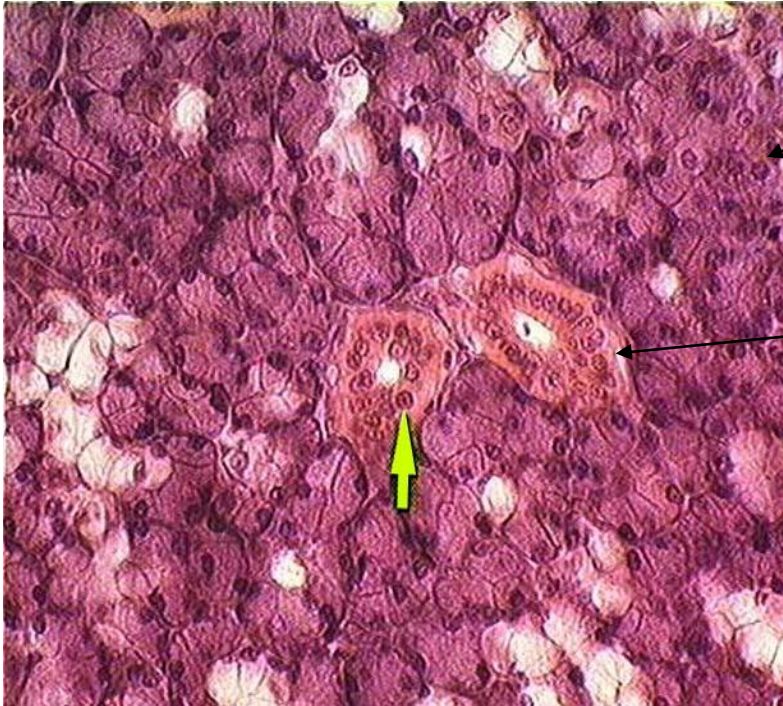

basophilic cytoplasm
of glandular cells
(contains ribosomes
with RNA)

acidophilic cytoplasm
of epithelial cells

Hematoxyline, eosin and saffron (HES)

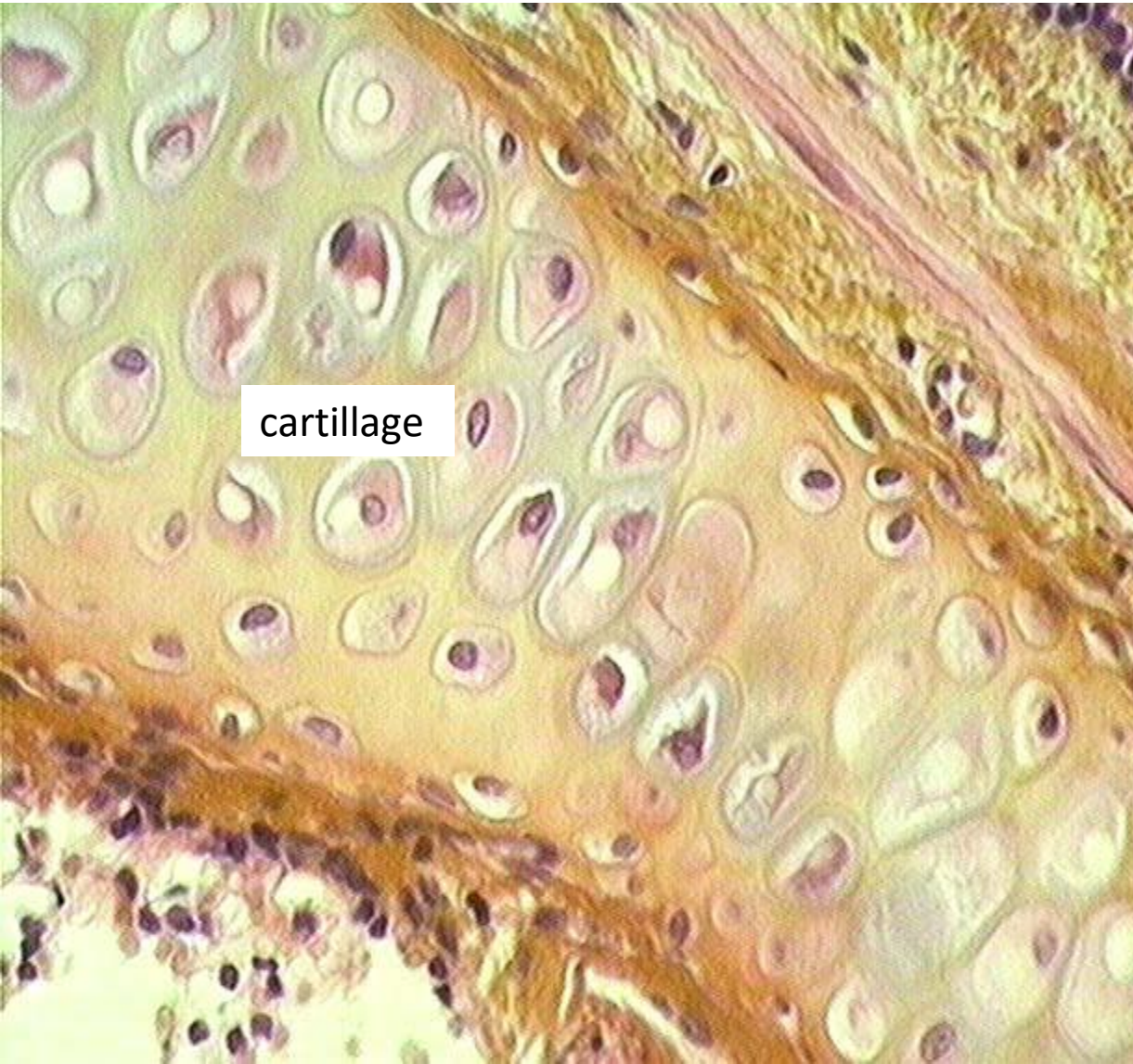

cartilage

Collagenous fibers
of connective tissue
are yellow after staining
with saffron

Azocarmine and aniline blue (AZAN)

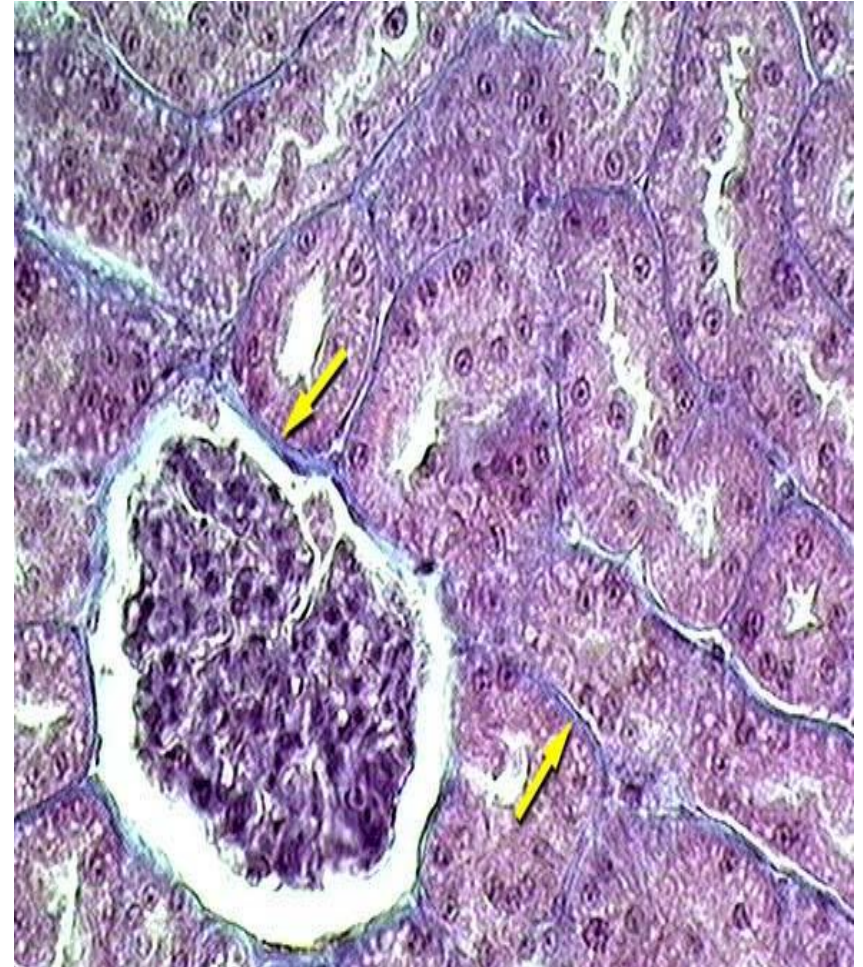
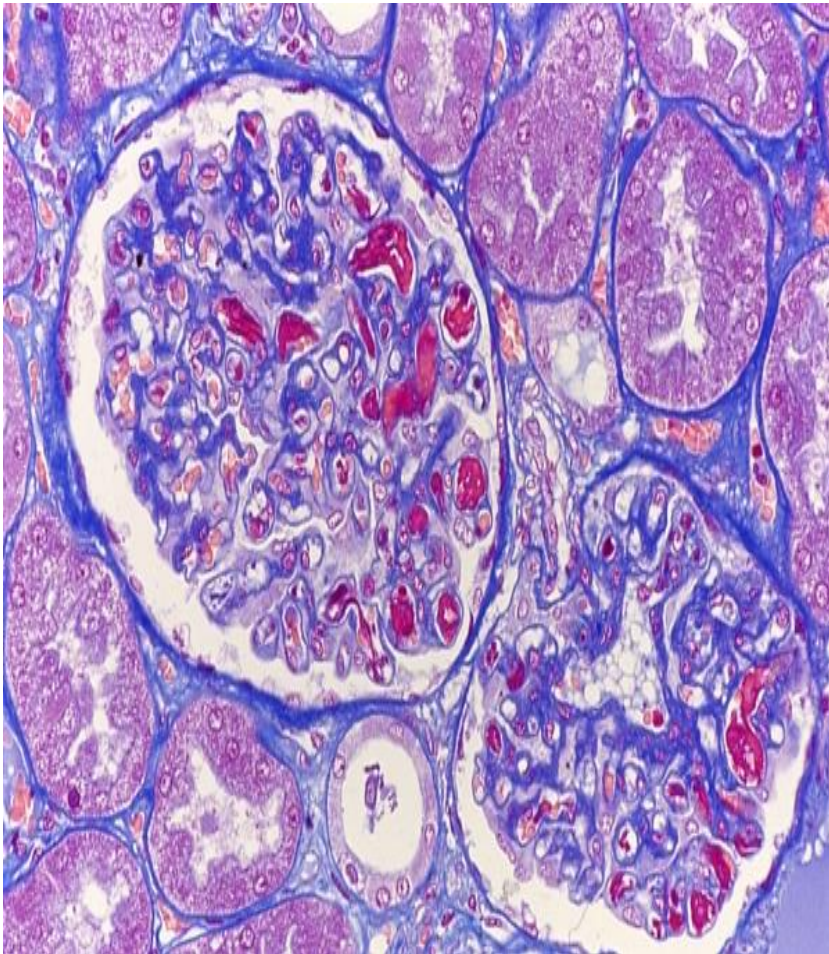

Kidney – collagen connective tissue

Impregnation of tissue with silver



Lien - reticular fibers

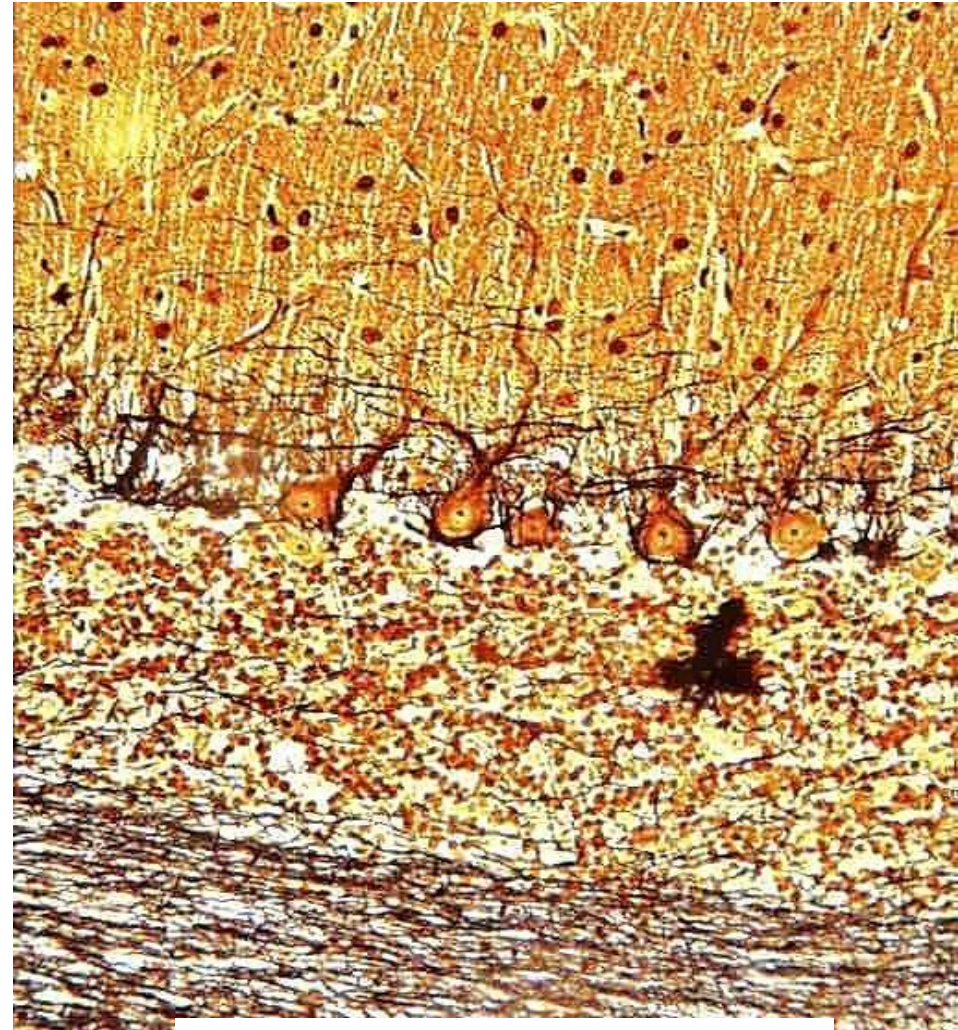

Cerebellum – nerve fibers

Iron hematoxyline

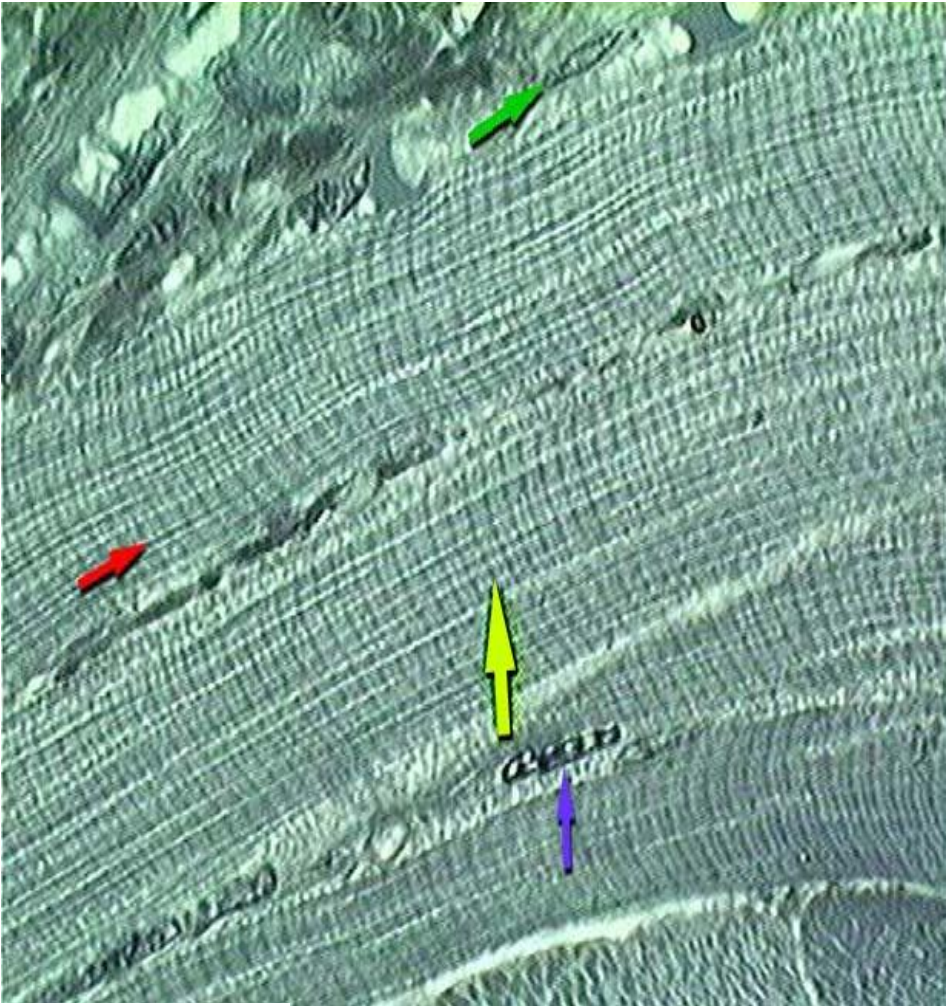

Skeletal muscle cells (fibers)

Green trichrome

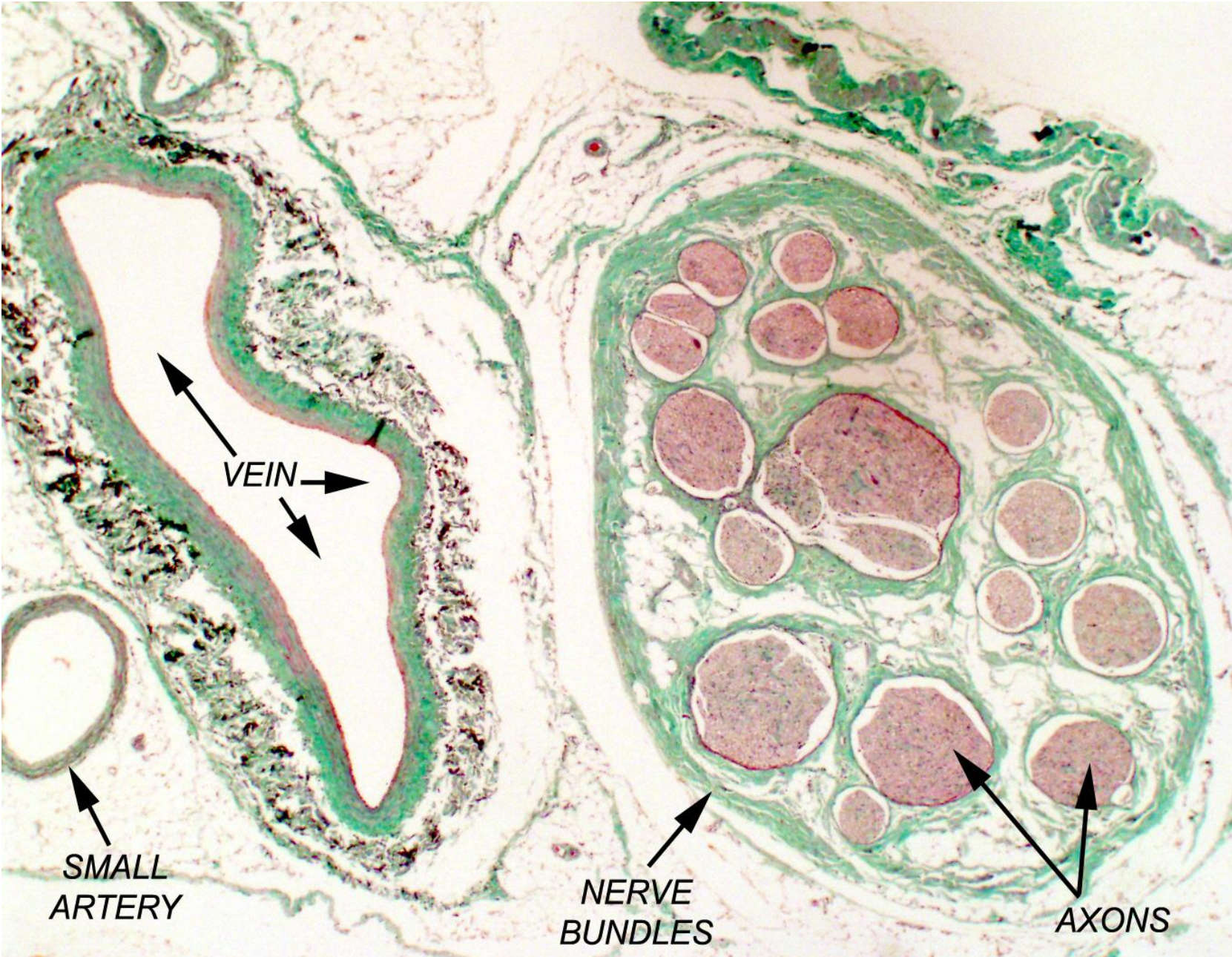

Histochemistry and Immunohistochemistry

- Relevance:

various chemical compounds detected „in situ“ (proteins, AA, NA, saccharides, lipids, enzymes, pigments, inorganic substances – Fe, Ca, Zn)

Various epitopes detected by immunotechniques

Enzyme conjugated with secondary Ab - visualization

Secondary Ab specific against primary Ab

Primary Ab specific against epitope of the particular antigen

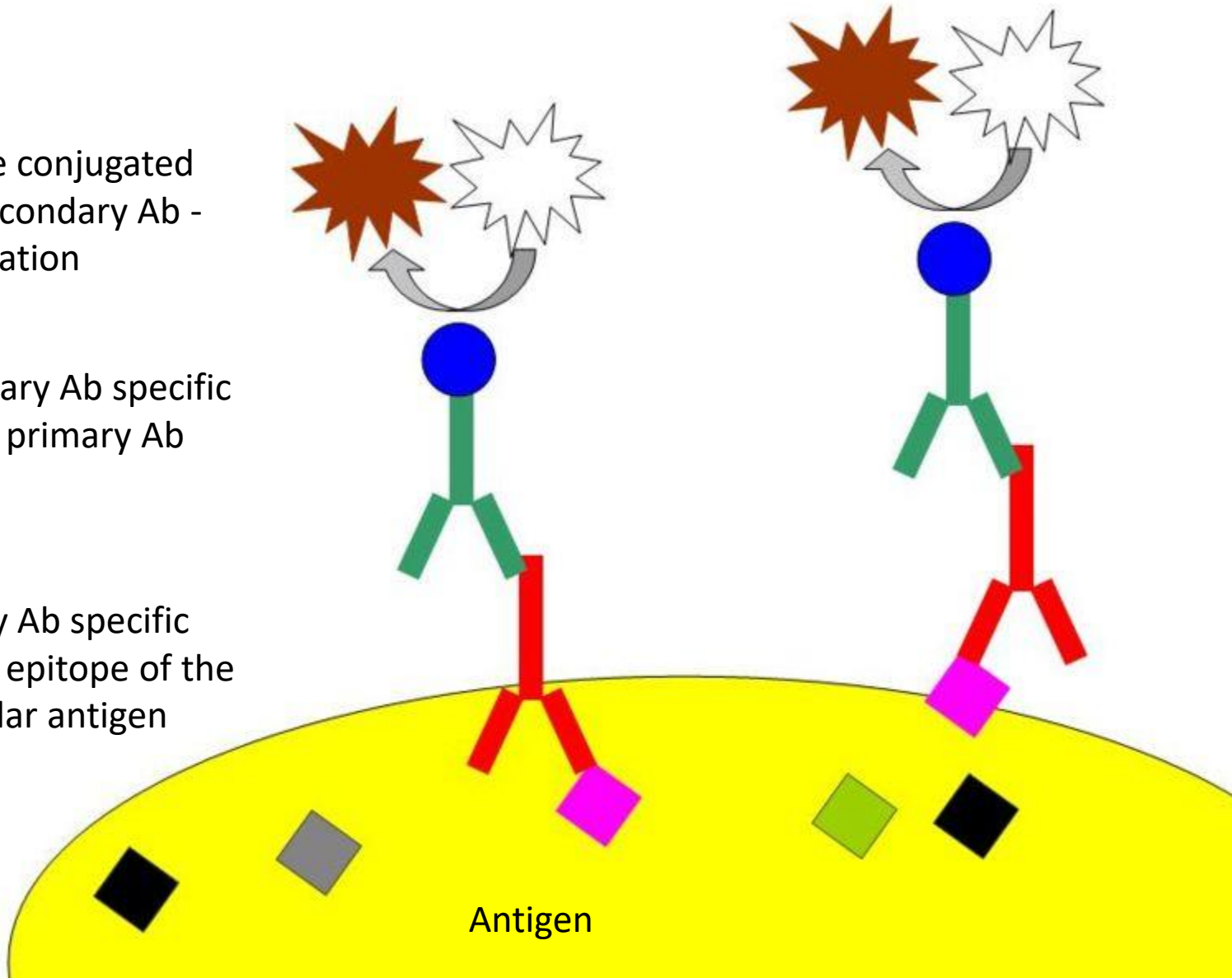

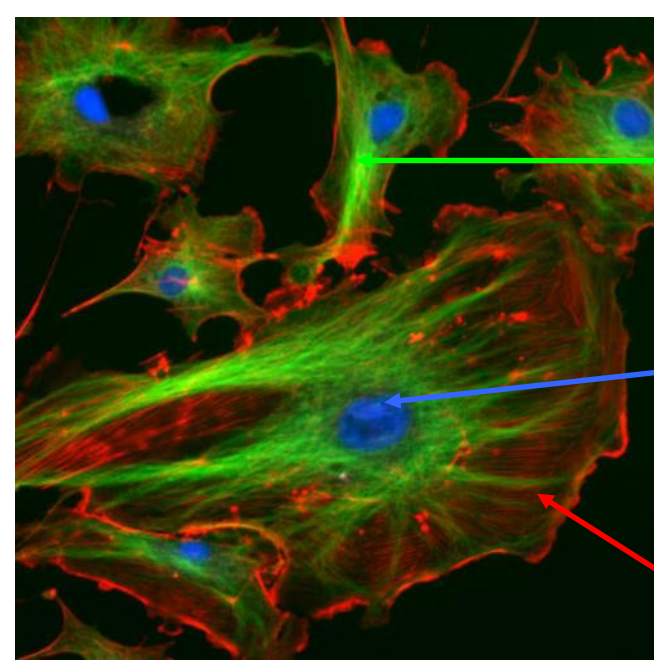

Actin (cytoskeleton)

DAPI (nucleus)

Microtubules (cytoskeleton)

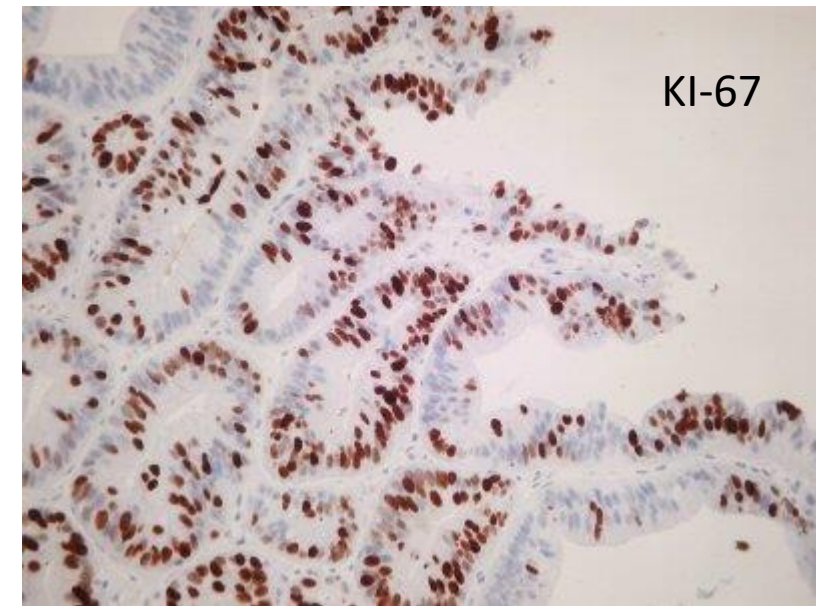
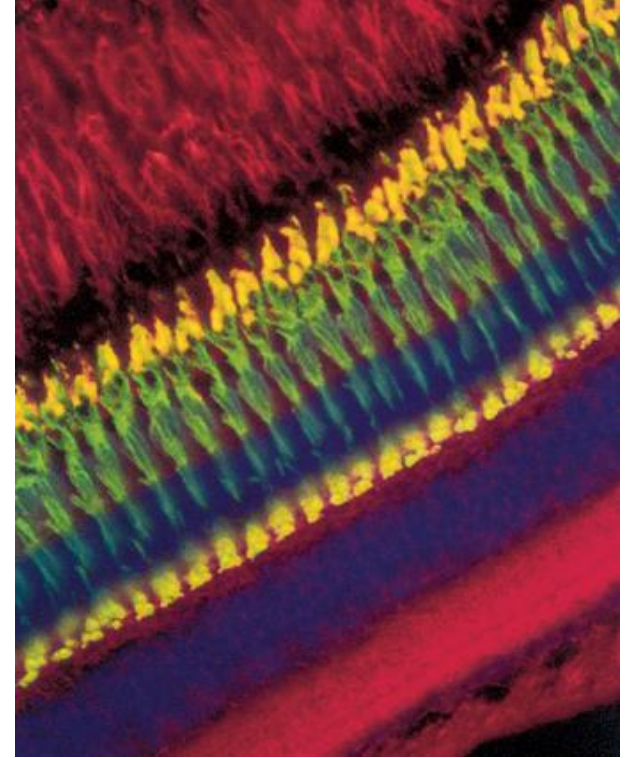

KI-67

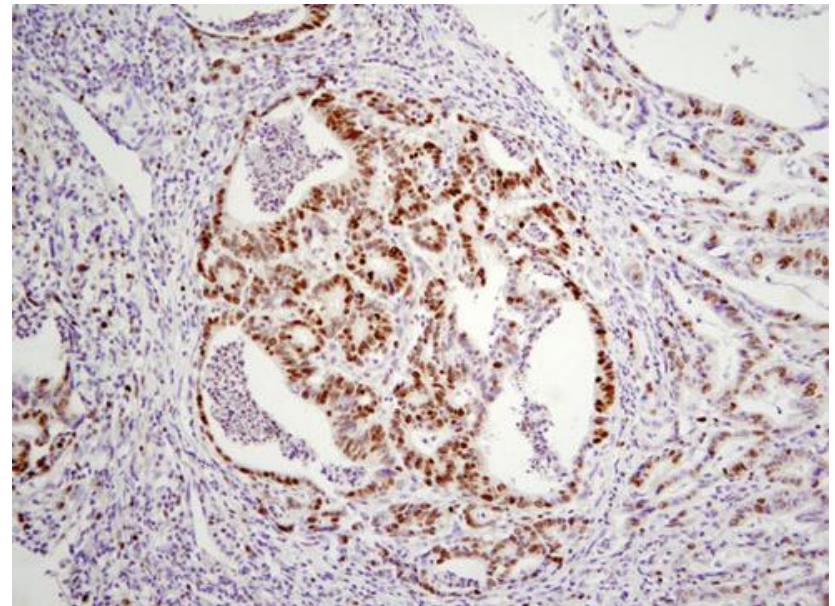

Tissue processing for the EM

- pH of all solutions (media) must be buffered on **7.2 – 7.4**
Cacodylate or phosphate buffer is frequently used.
- absolutely dustfree environment
- solutions (media) have to be precise (artifacts)

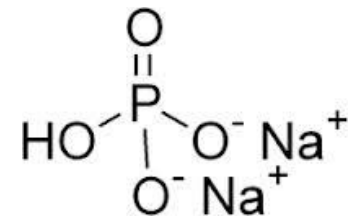
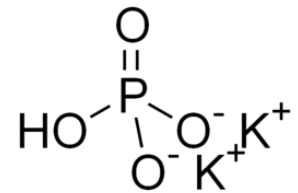
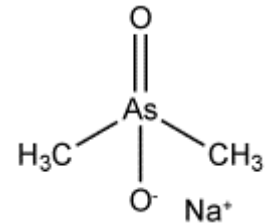

Tissue processing for the EM

- **SAMPLING** – immediately after arresting of blood circulation, tissue block sized no more than **1mm³**
- **FIXATION** – **glutaraldehyde** (binds amine groups) + **OsO₄** (binds lipids) are used as double fixation
- **RINSING** – distilled water
- **DEHYDRATION** - ethanol
- **EMBEDDING** – gelatin capsule or plastic forms are filled with some medium (which can be polymerized from liquid to solid form) and pieces of fixed tissue are placed into this medium. Epoxyd resins (Epon, Durcupan, Araldite) are usually used as in water insoluble media.
- **CUTTING** – ultrathin sections (in ultramicrotomes)
- **CONTRASTING** ≈ staining

Embedding tools:



gelatin (1) or plastic (2) capsules

capsule holder (3)

embedding plates
(4, 5)

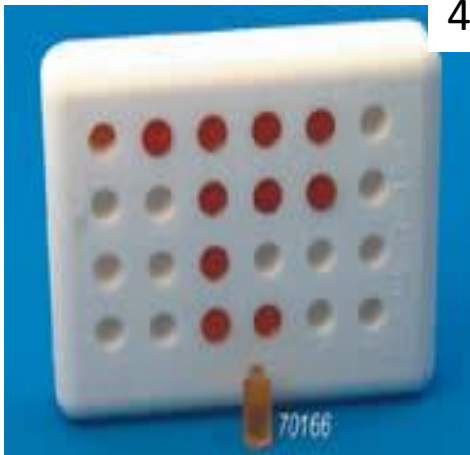

Embedded blocks
prepared for cutting



Trimming the Specimen Block

By trimming, using ultramicrotome, an excess of hard medium is removed and pyramide with minimal cut surface (0.1 mm²) is prepared.

Minimum of tissue (black) is in the top of pyramid

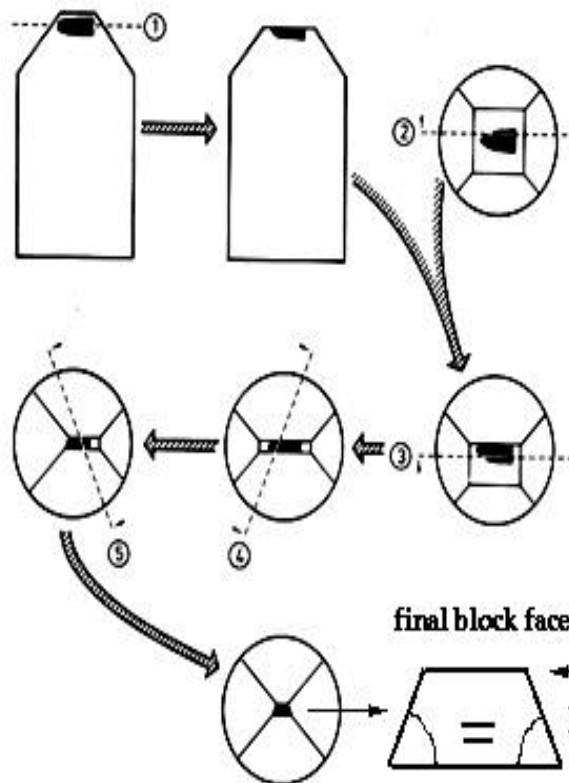
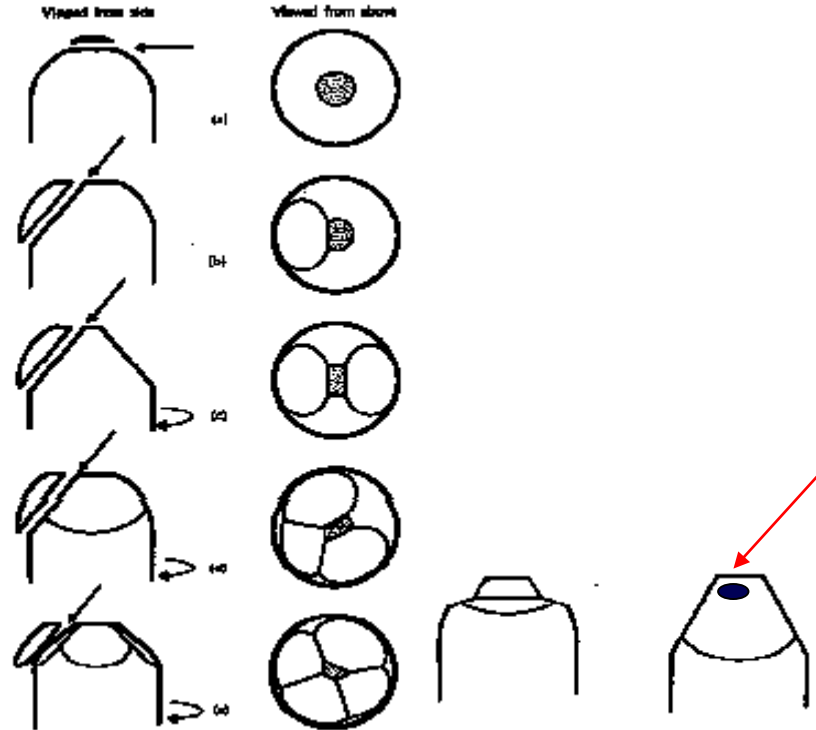

Pyramid Side Profile



Too Steep-Trans Am Building
(not rigid-vibrations)



Too Flat-Pyramid of the Sun
(section size changes rapidly)



Just Right-Egyptian Pyramid
with top cut off



Cutting

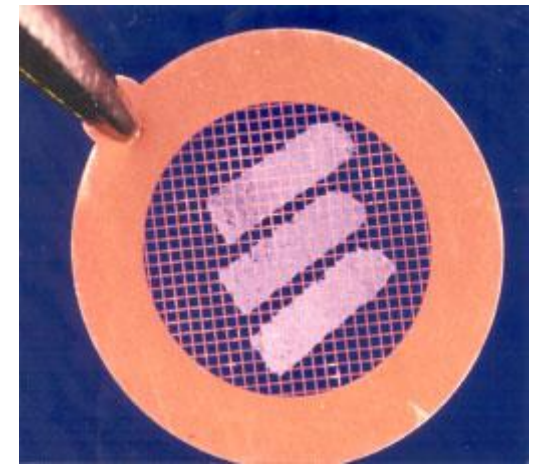
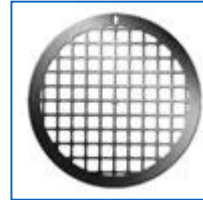
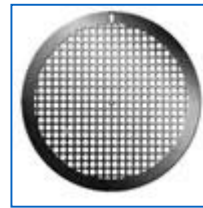
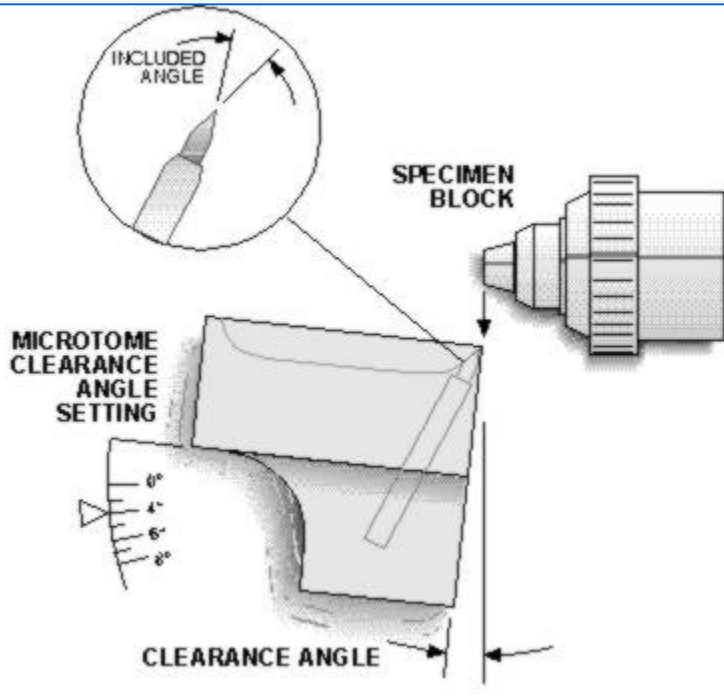

Grid Types and Mesh Sizes

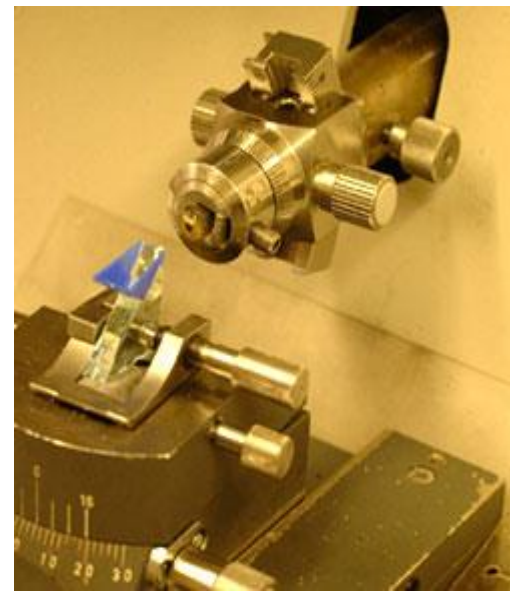
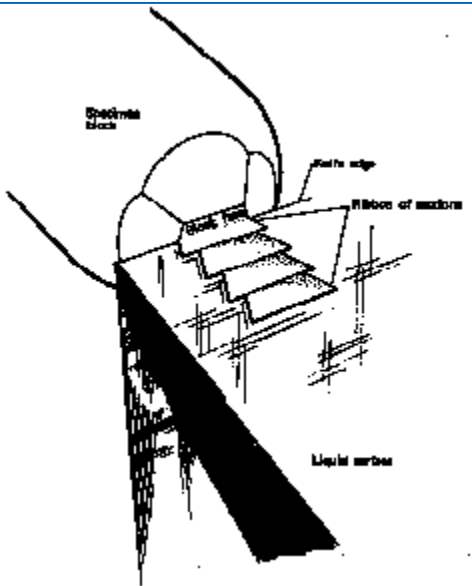
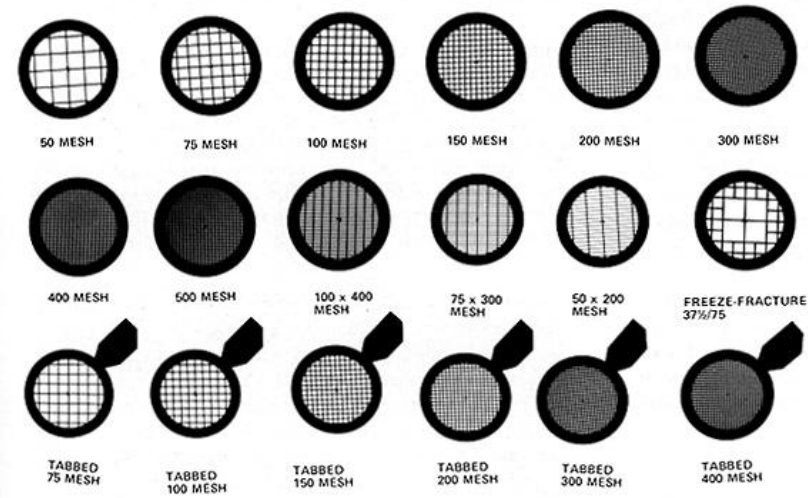

Cutting

Ultrathin sections (70 – 100 nm) -
ultramicrotomes.

Glass or diamond (b) knives with water
reservoir are used

Sections slide flow on water in small
container attached to the knife

Supporting grids



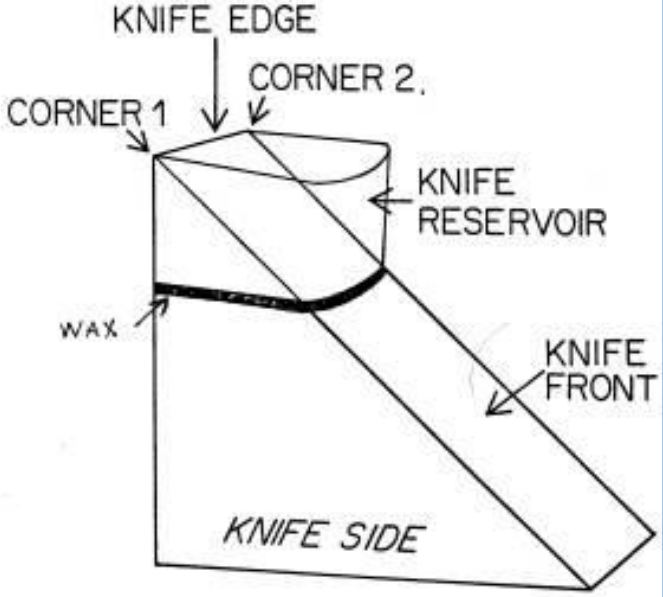

Ultramicrotom knives:

glass

diamond

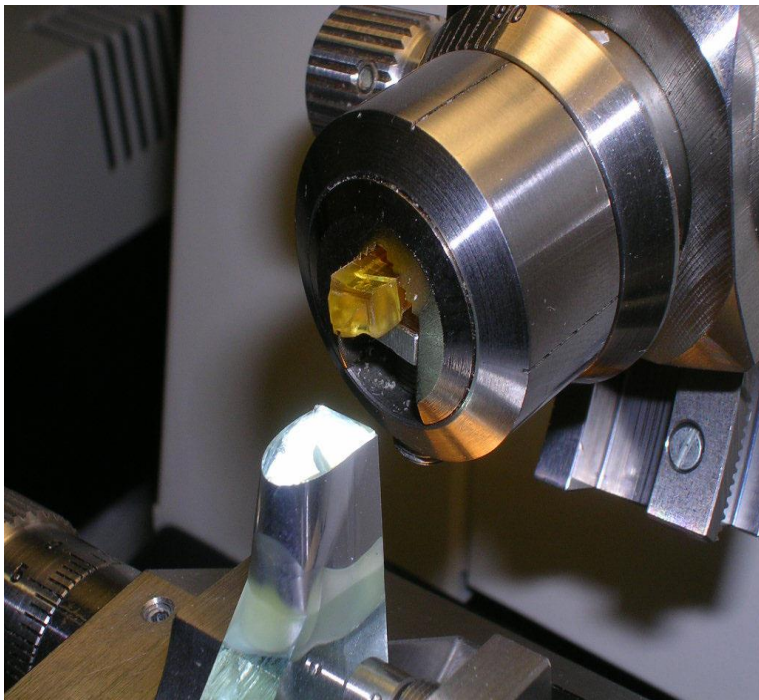

CONTRASTING (=STAINING)

- principle of differentiation of structures – different dispersion of beam of electrons depending on atomic weight of elements,
„electron dyes“ are thus mixtures of heavy metals:
uranylacetate or lead citrate

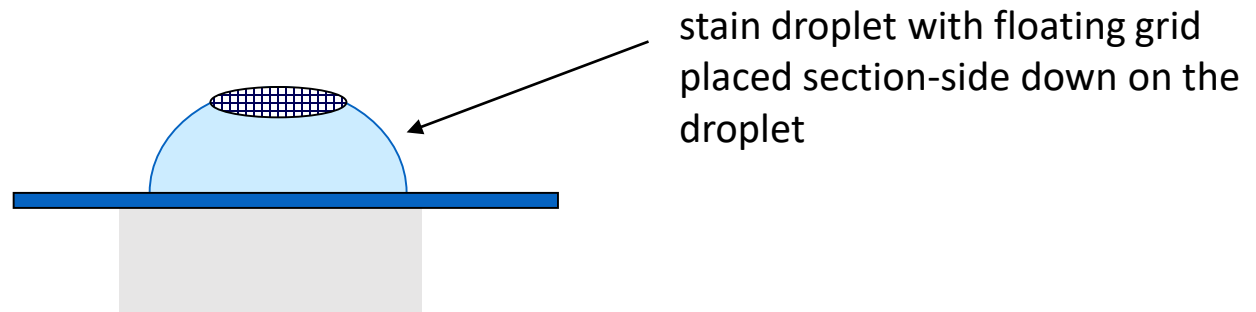

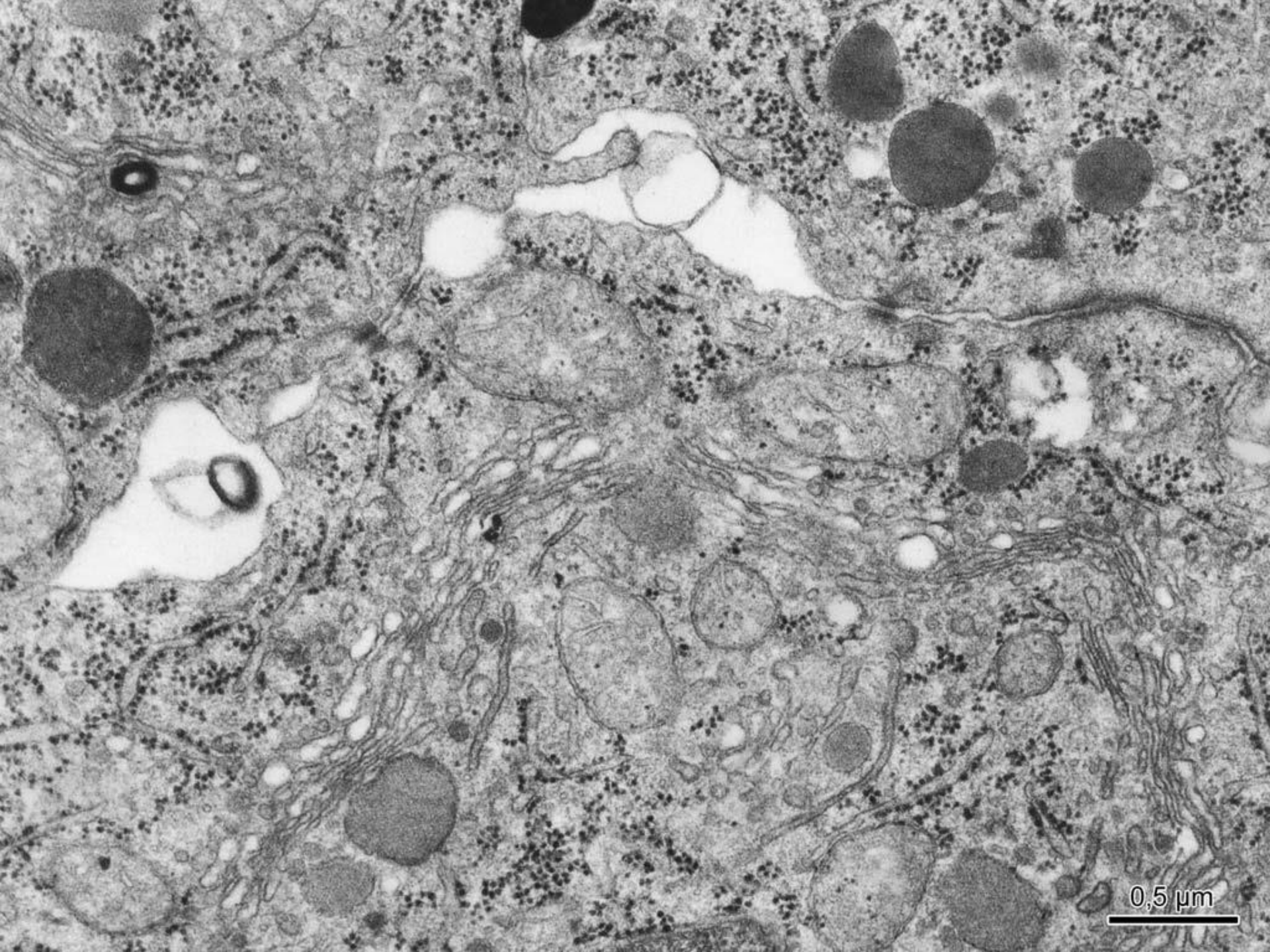

0,5 μm

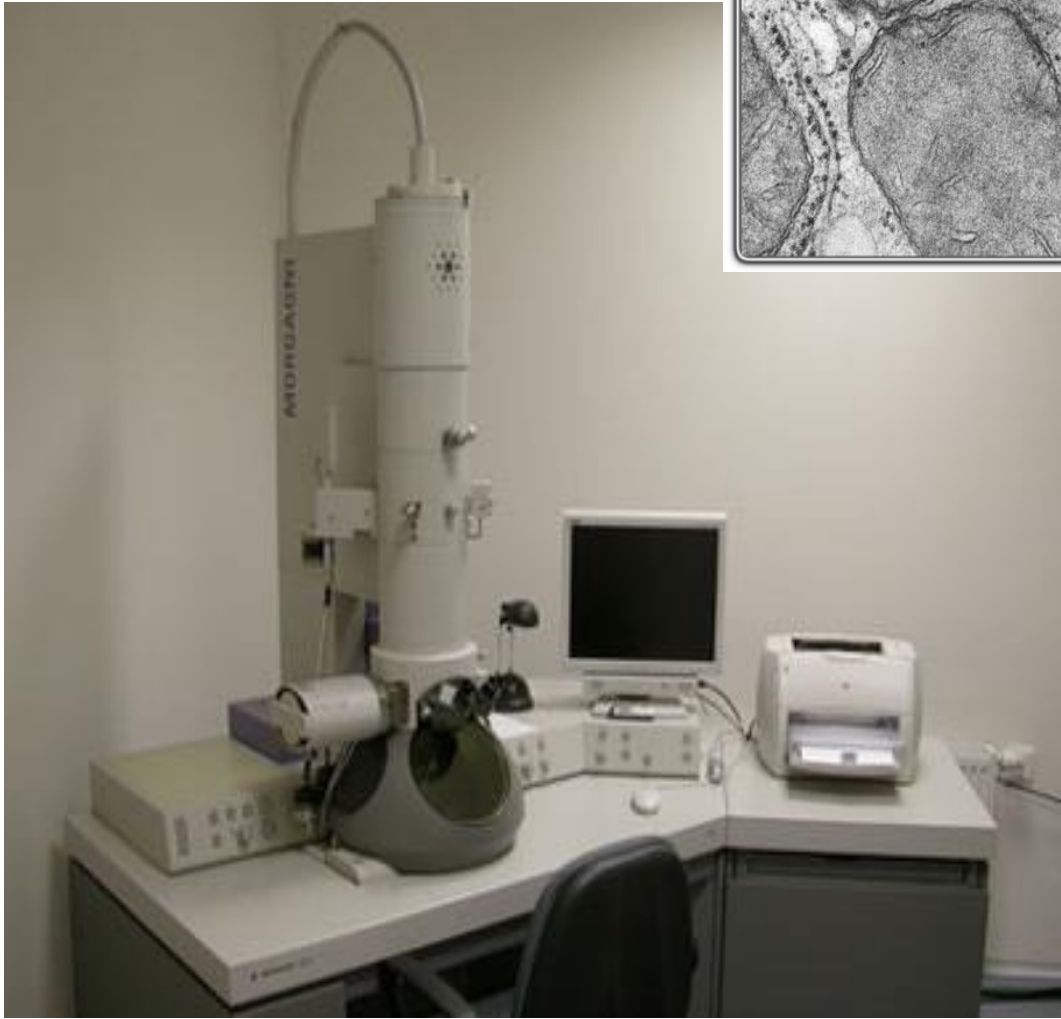
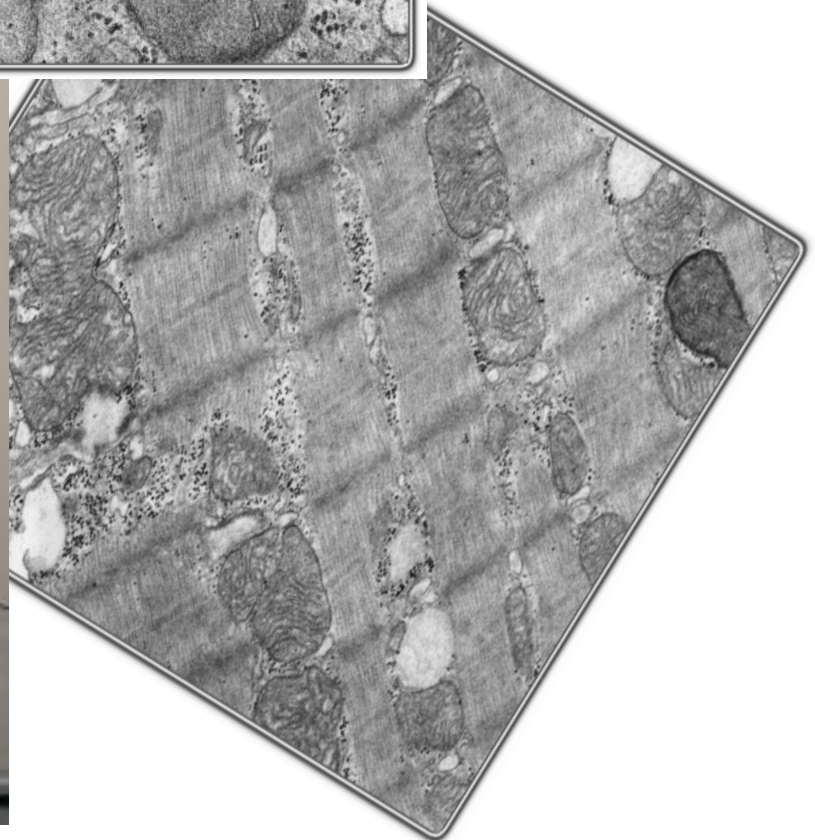
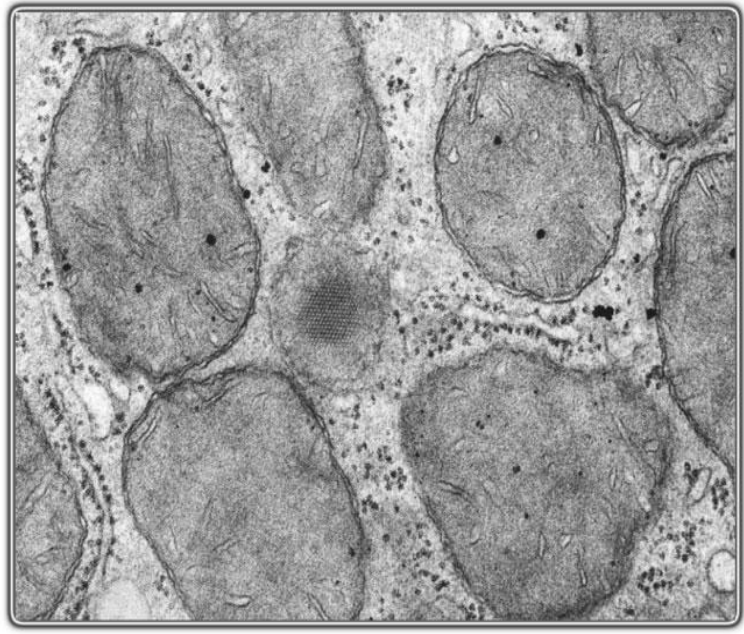

Differences between LM and EM		
	LM	EM
Sampling	< 1 cm ³ minutes	< 1 mm ³ seconds
Fixation	formaldehyde 12 – 24 hours	glutaraldehyde 1 – 3 hours
Embedding	paraffin	epoxid resins (Durcupan)
Cutting Thickness of sections	microtome 5 – 10 μm	Ultramicrotomes 50 – 100 nm
Staining (LM) contrasting (EM)	dyes (<i>hematoxyline – eosin</i>)	heavy metals (<i>uranylacetate, lead citrate</i>)
Mounting (only LM)		---
Result	histological slide (preparete)	photograph of ultrathin section

Visit us at:

<http://www.med.muni.cz/histology>



DEPARTMENT OF HISTOLOGY AND EMBRYOLOGY
FACULTY OF MEDICINE - MASARYK UNIVERSITY

Home Research Grants Education Publication People Instrumentation Contact



Thank you for attention