

CENTRAL REPRESENTATION OF THE TOUCH

Primary somatosensory (somesthetic) cortex (S1)

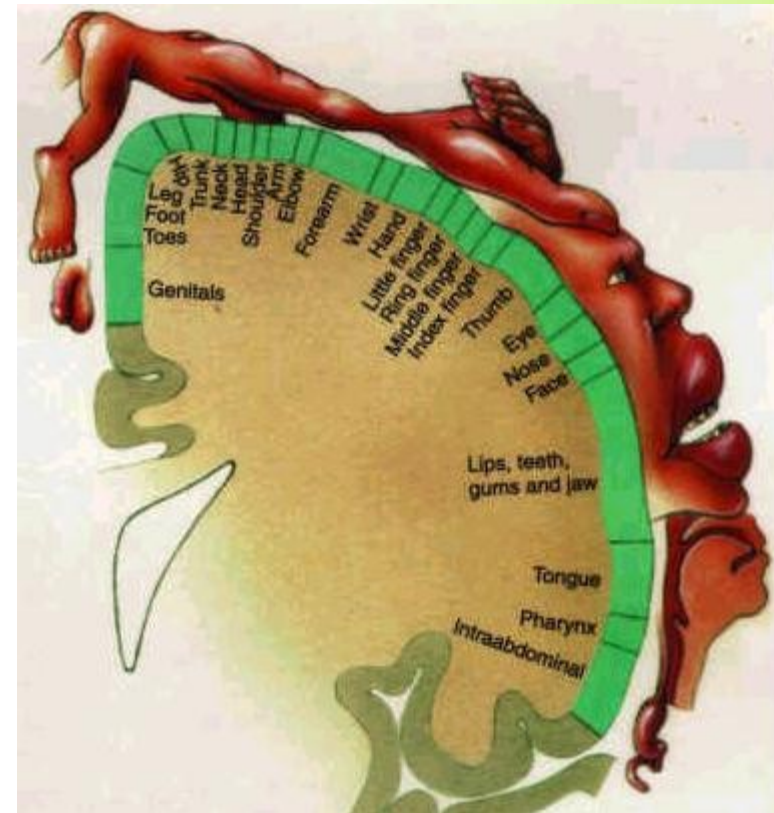

Somatosensory cortex - a. 3,1,2

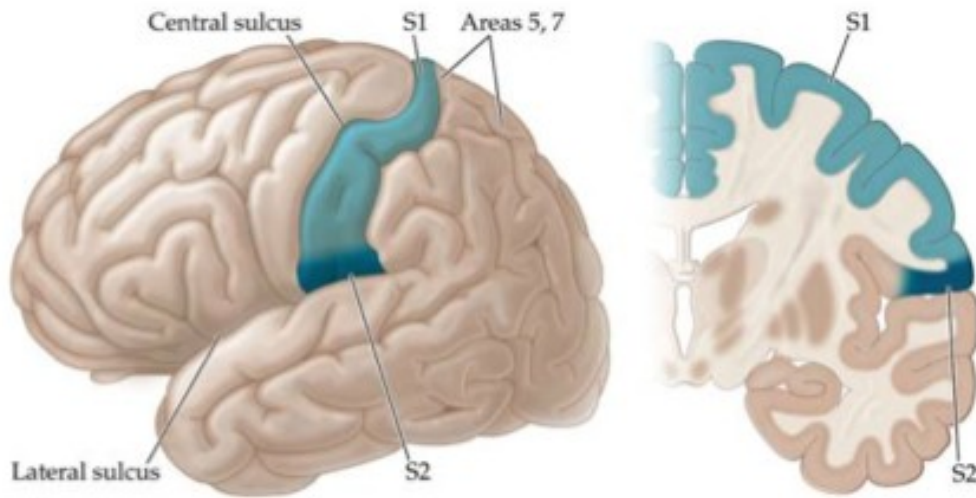
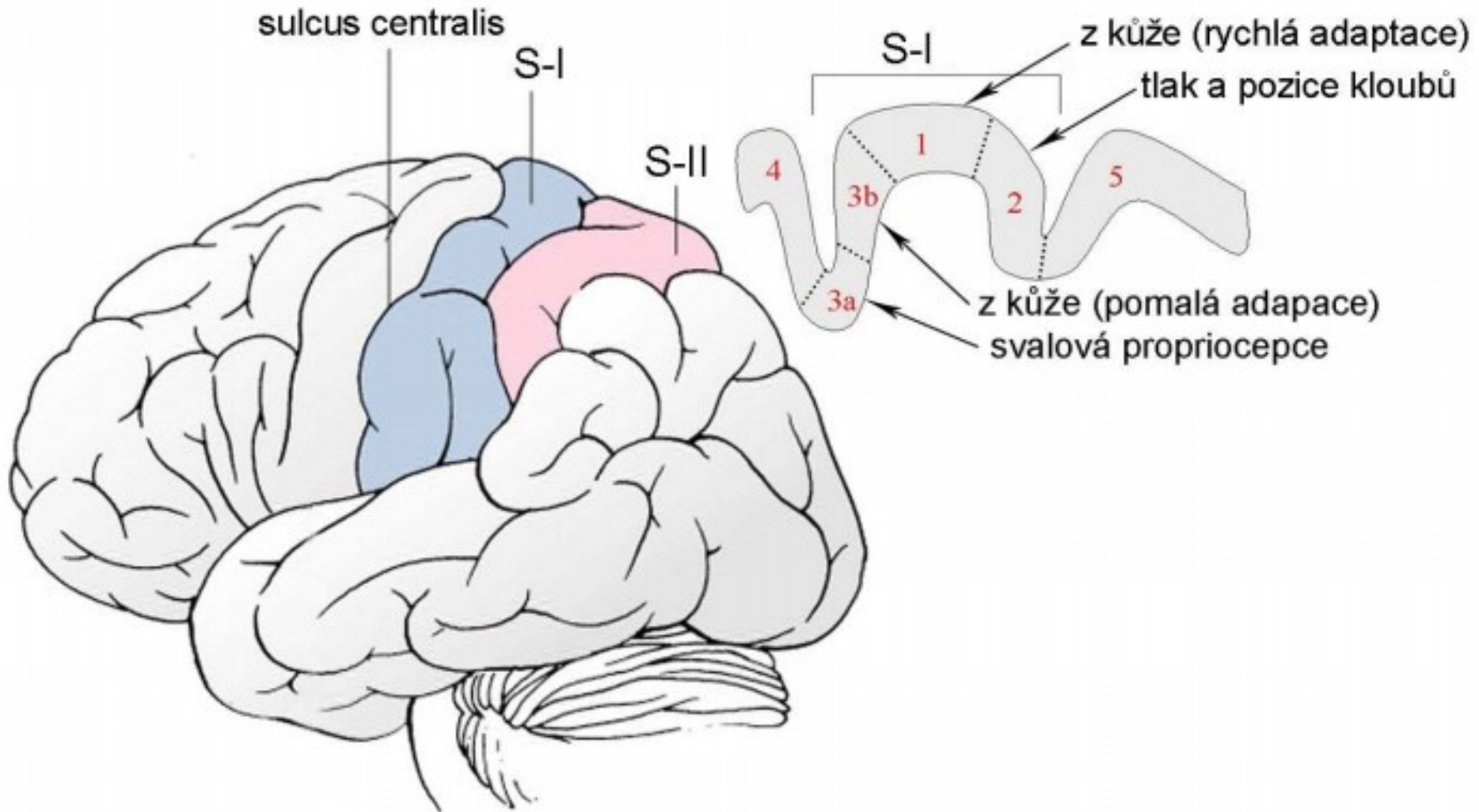

Somatic sensory association area

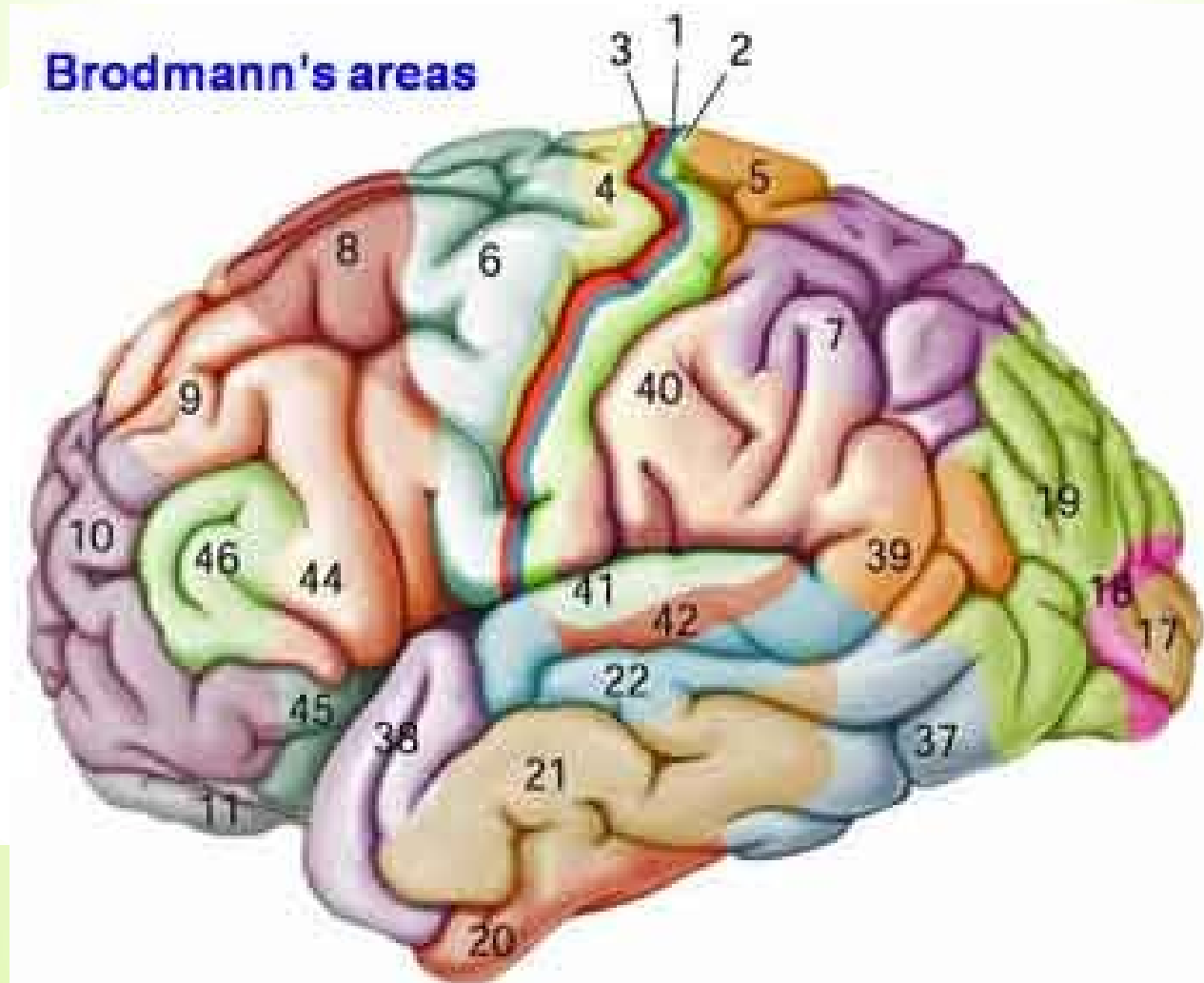

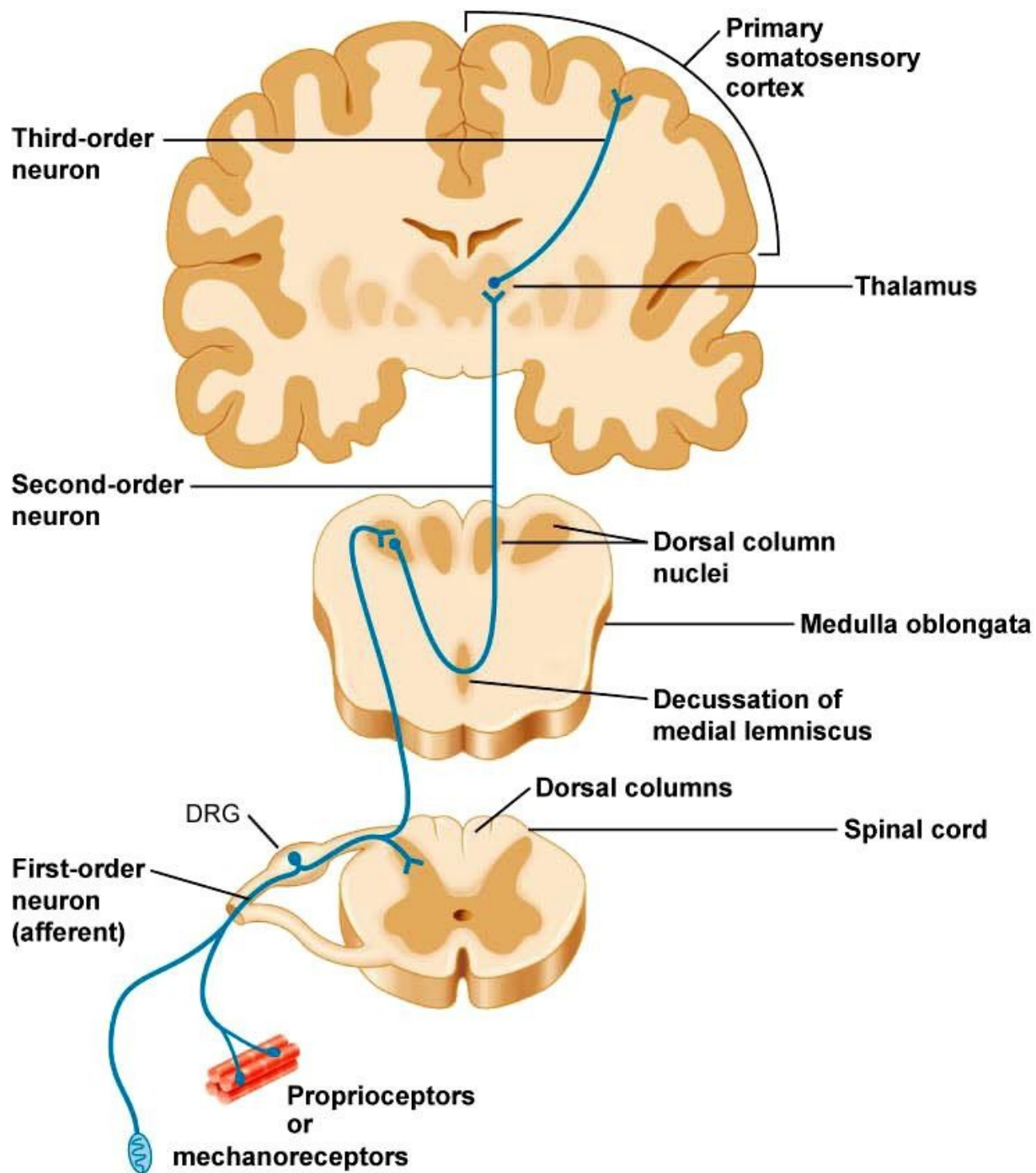

Secondary somatic sensory area (SII)

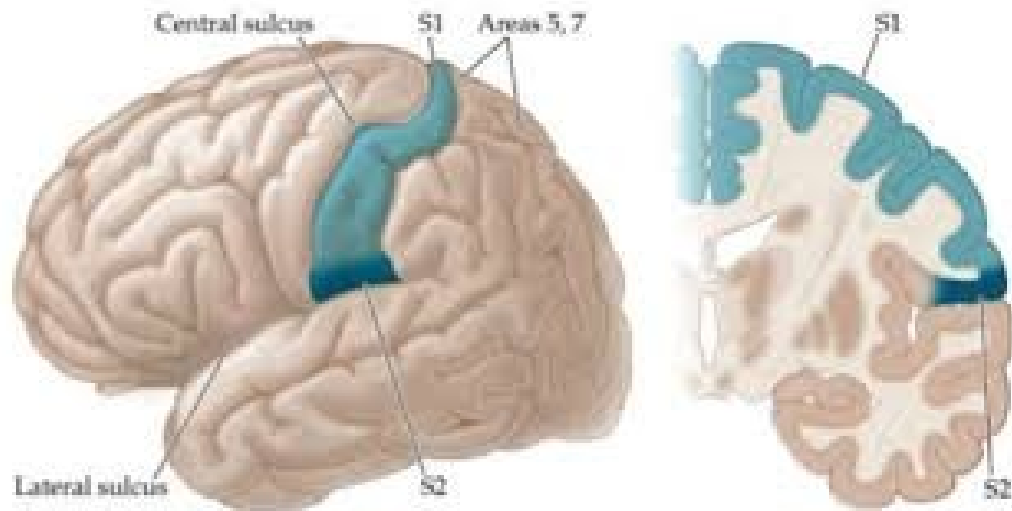

PAIN

Z-SCORE

5.6



2.3

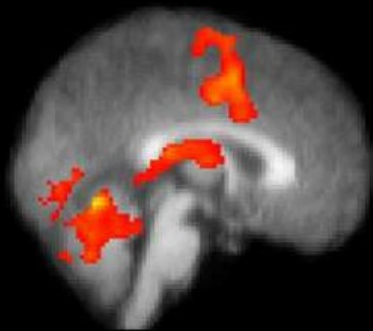

ACC
Thalamus
Cerebellum

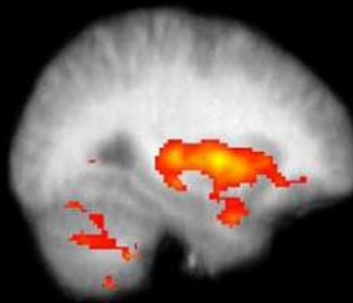

DLPFC
IPL/SPL
Insula

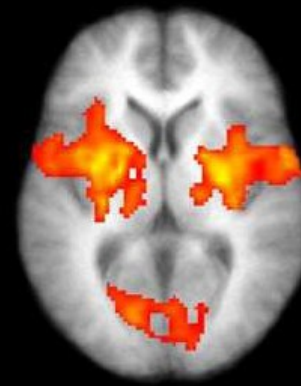

Insula
Caudate
Thalamus
GP/PT

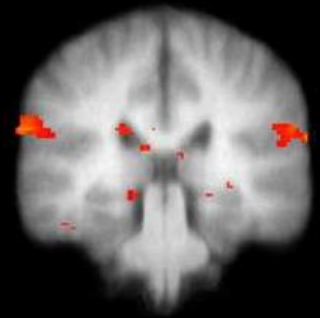

SII
M1

PAIN

PAIN

- ❑ pain is a protective modality
- ❑ International Association for the Study of Pain (IASP):
„Pain is an unpleasant sensory and emotional experience associated with actual or potential tissue damage, or described in terms of such damage“.
- ❑ pain threshold: individual and social influences

Nociceptors/nocisensors

- ❑ nocer - to injure or to hurt in Latin
- ❑ are activated by noxious mechanical, thermal or chemical stimuli
- ❑ detect signals from damaged tissue or the threat of damage
- ❑ free nerve endings found in the skin, muscles, joints, bones and viscera

Nociceptors

- ❑ nociceptors of A δ fibres (5-40 meters/sec)
 - A δ mechanical nociceptors
 - A δ thermal nociceptors
- ❑ nociceptors of C fibres (0.5-2.0 meters/sec)
 - C polymodal nociceptors - react to thermal, mechanical and chemical stimuli
- ❑ silent nociceptors (MIA = mechanically insensitive afferents)
 - responsive after inflammation and tissue injury

Factors that activate nociceptors

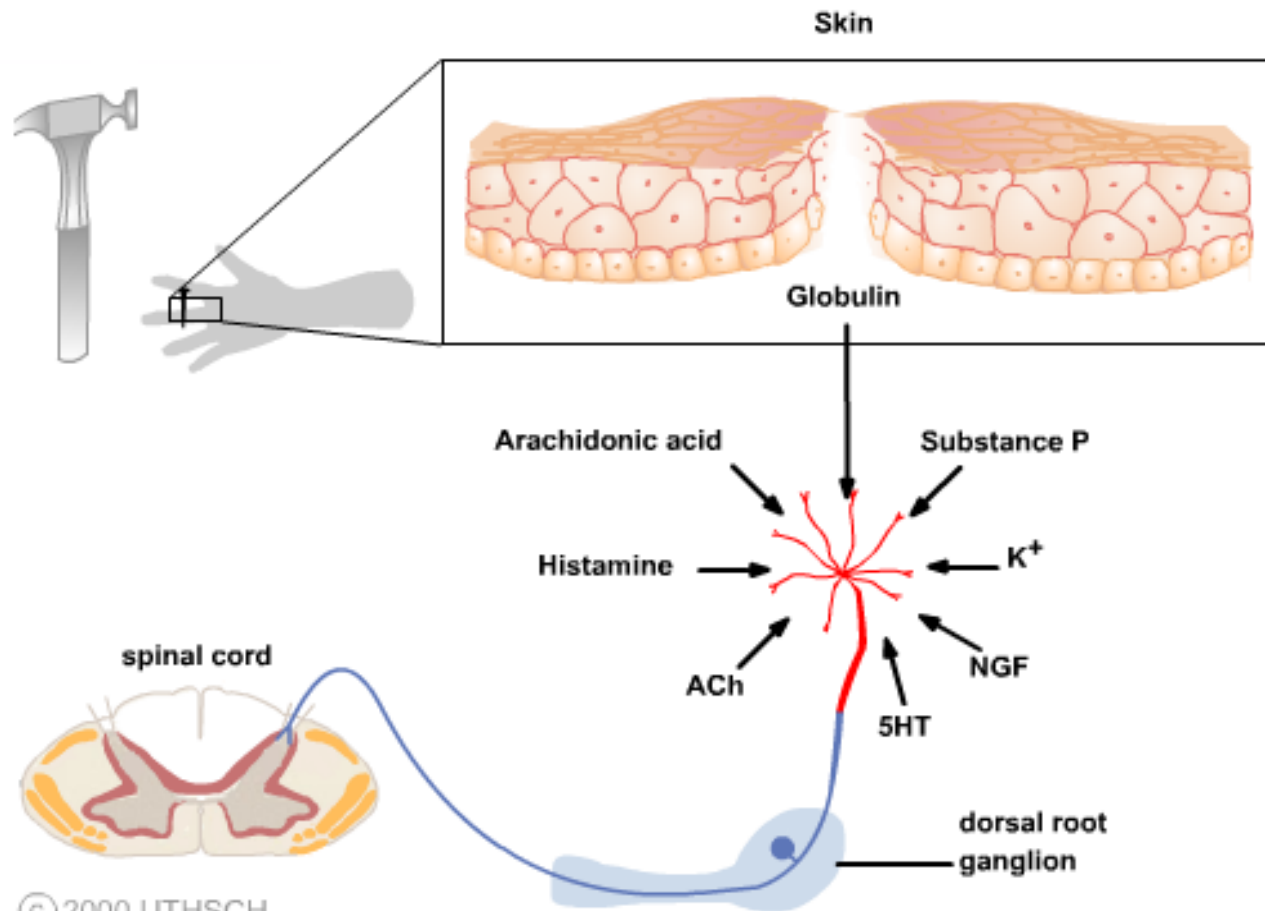

- ❑ **Peripheral sensitization**
- ❑ **Central sensitization** = activity- or use-dependent neuronal plasticity in the spinal cord
 - **hyperalgesia** - exaggerated or prolonged response to noxious inputs
 - **allodynia** - pain induced by normally innocuous inputs

Nociceptive afferents

- ❑ A δ fibres - thin myelinated fibres
 - sharp, localized pain
- ❑ C non-myelinated fibres
 - dull, non-localized pain

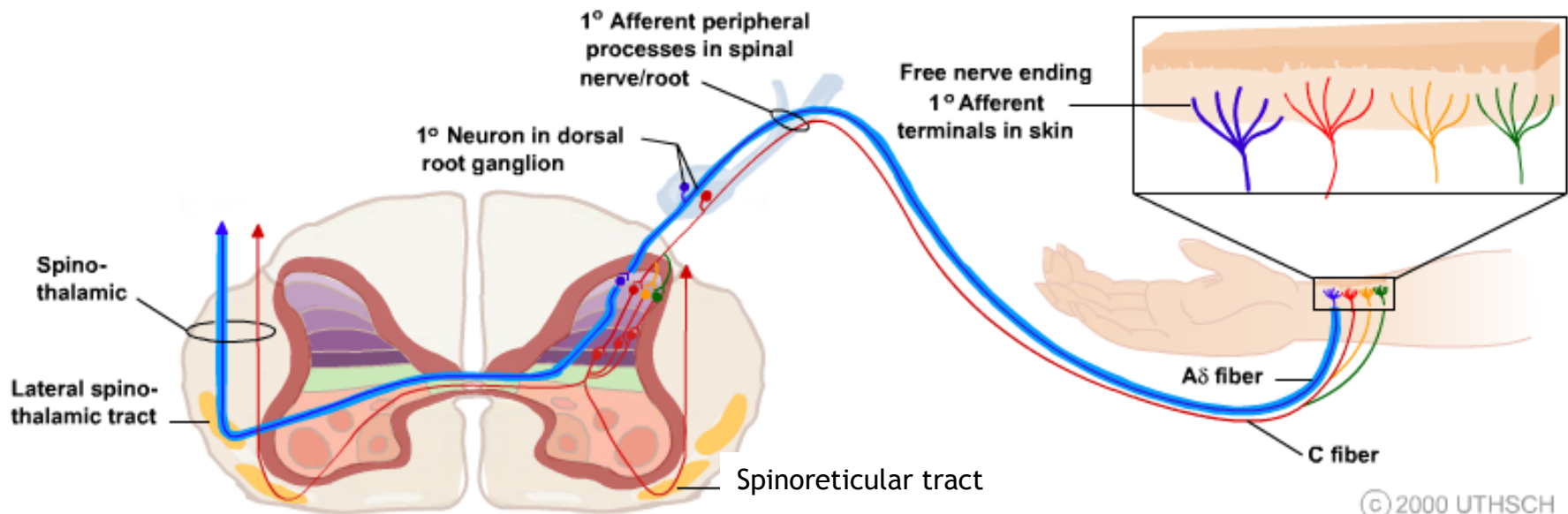
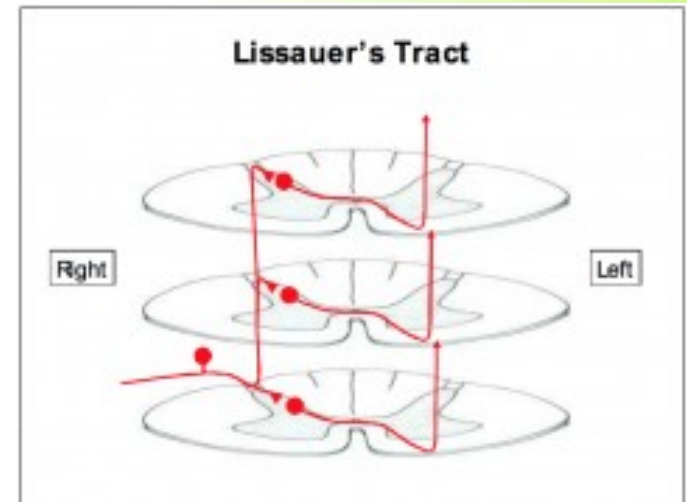

Pain pathways from trunk and limbs

PALEOSPINOThALAMIC PATHWAY

- ❑ tr. spino-reticulo-thalamicus
 - diffuse, non-localized pain
 - autonomic and reflexive responses to pain stimuli
 - emotional and affective reactions to pain
 - intralaminar nuclei of the thalamus
 - postcentral gyrus, insula and cingulate gyrus

NEOSPINOThALAMIC PATHWAY

- ❑ tr. spino-thalamicus lat.
 - sharp, localized pain
 - ventral posterolateral (VPL) and posterior nucleus of the thalamus
 - postcentral gyrus

Cortex

Thalamus

Spinal cord

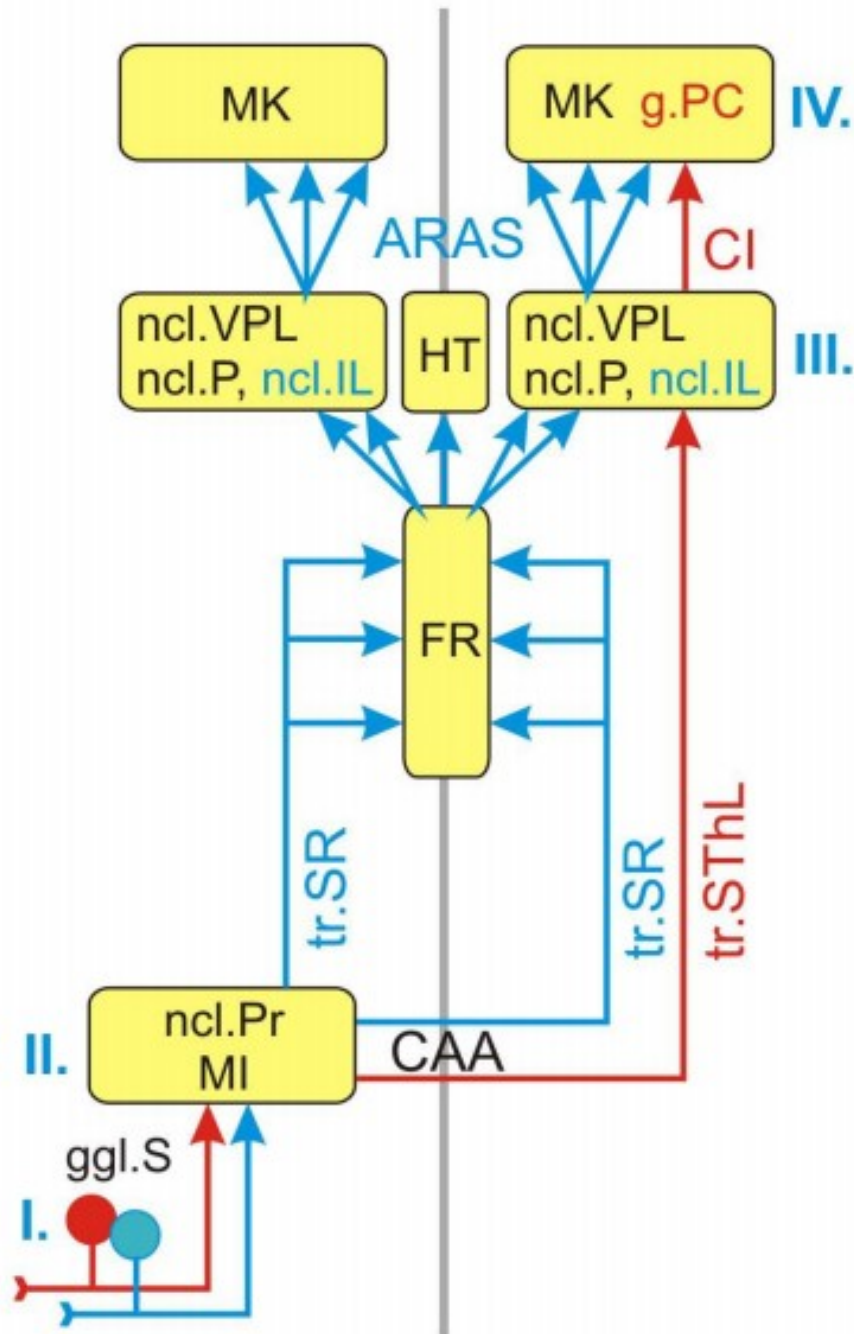

Paleospinothalamic pathway

Neospinothalamic pathway

Pain pathways from head

TRACTUS TRIGEMINO-RETICULO- THALAMICUS

- ❑ diffuse, non-localized pain

TRACTUS TRIGEMINO- THALAMICUS ANTERIOR

- ❑ sharp, localized pain

Cortex

Thalamus

Medulla

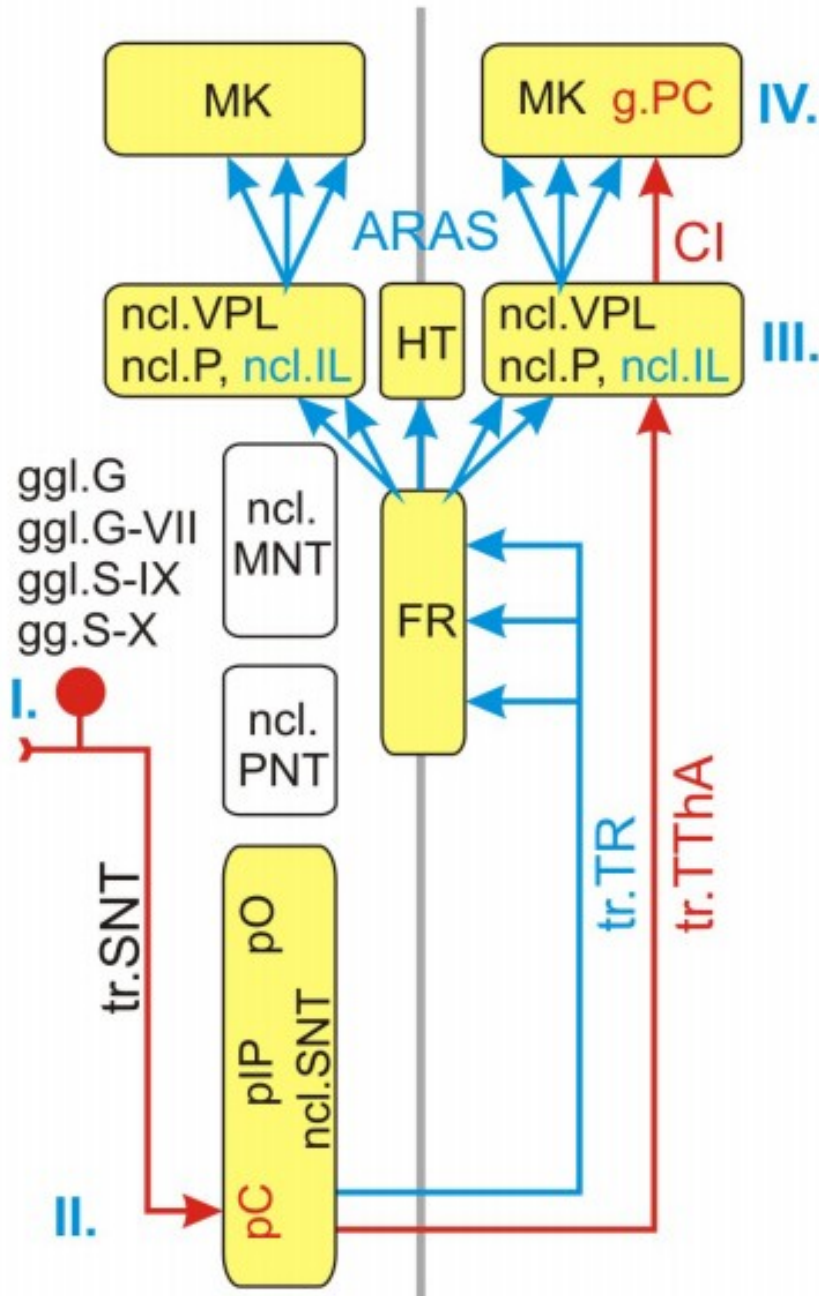

The phylogenetically old, **paleospinothalamic and trigemino-reticulothalamic**, pathways through the RF are concerned with the arousal and affective (emotional) aspects of somatic sensory stimuli.

In contrast, the direct, **neospinothalamic and anterior trigeminothalamic**, pathways are analytic, encoding information about modality, intensity, and location.

Referred pain

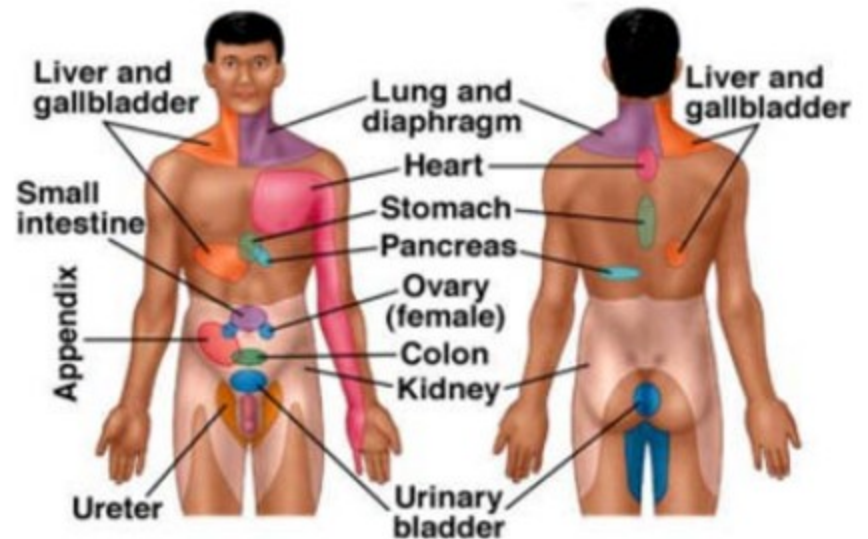
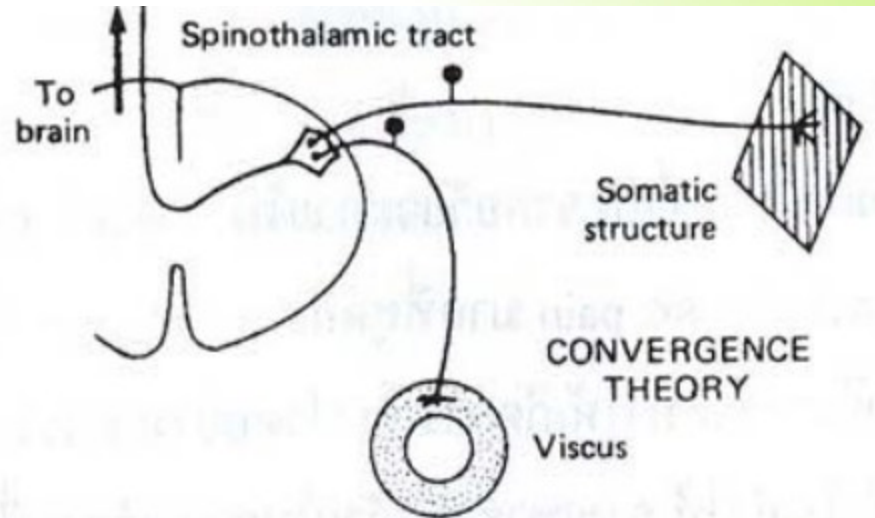
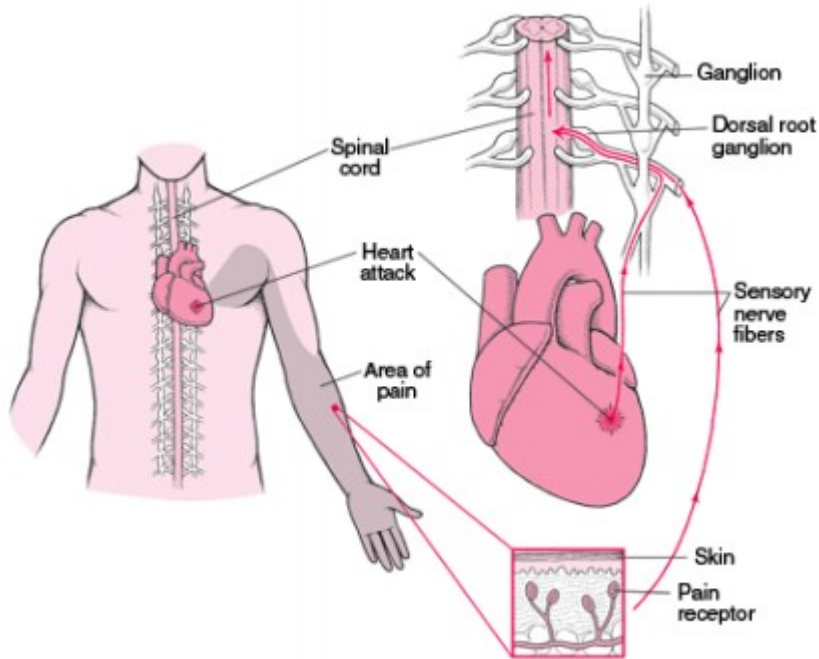

MODULATING SYSTEMS OF NOCICEPTIVE PATHWAYS

- ❑ level of modulation of nociceptive pathways
 - spinal cord (“gate control theory”)
 - RF of brain stem
 - periaquaeductal gray matter (PAG)

“Gate control theory”

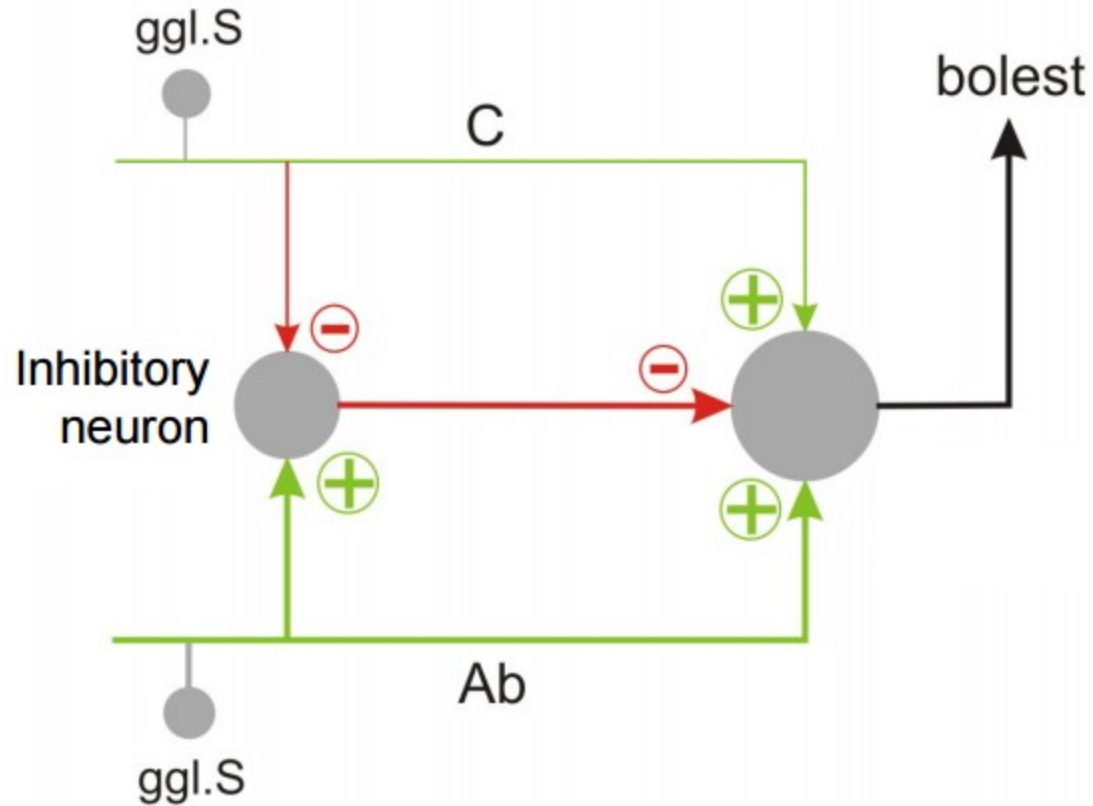

Central Pain Modulation



Inputs from hypothalamus,
amygdala, and cortex

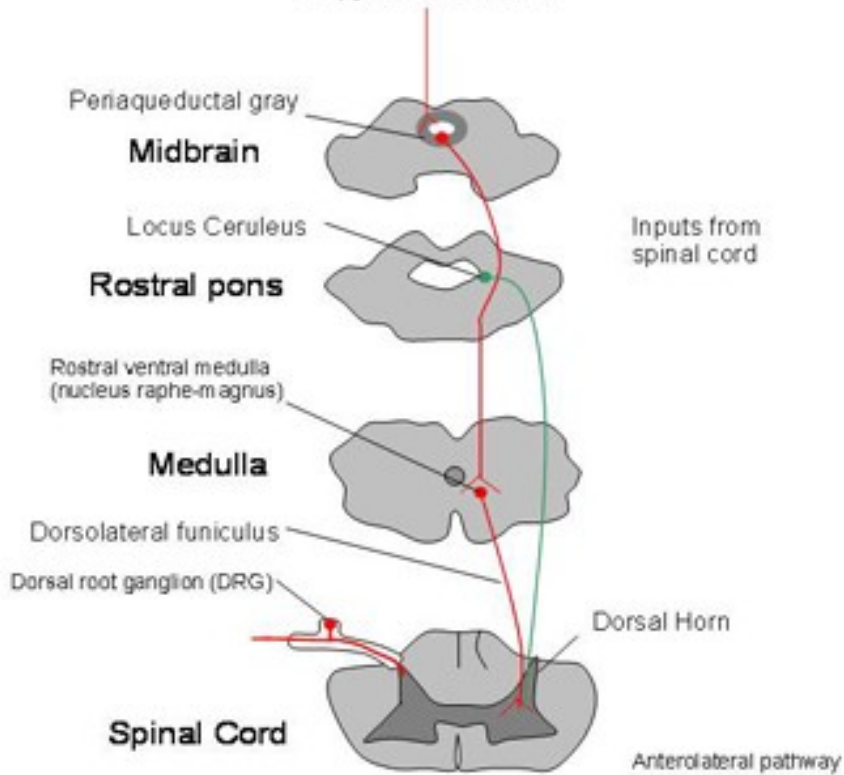

Stress-induced analgesia

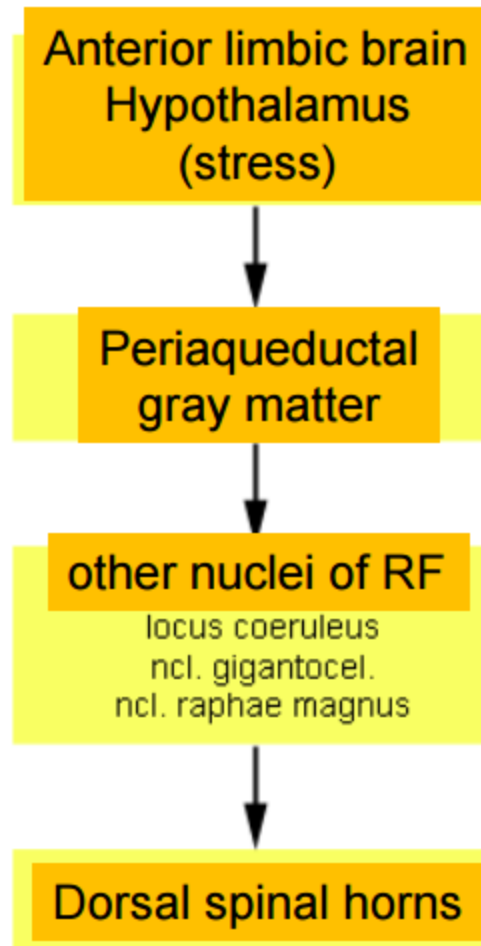

SOMATOMOTOR PATHWAYS

Some necessary components of proper motor control

- Volition
- Coordination of signals to many muscle groups
- Proprioception
- Postural adjustments
- Sensory feedback
- Compensation for the physical characteristics of the body and muscles
- Unconscious processing
- Adaptability

Levels of movement regulation

- spinal cord
 - brain stem
 - cortex
-

- cerebellum
- basal ganglia

Lower motor neurons - spinal cord

- α motoneurons
- γ motoneurons

- **Somatotopic organization**

- medial column - axial muscles
- lateral column - limb muscles
- anteriorly - extensors
- posteriorly - flexors

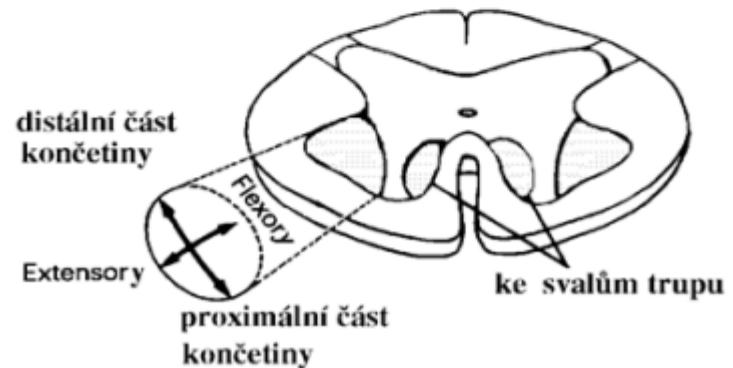
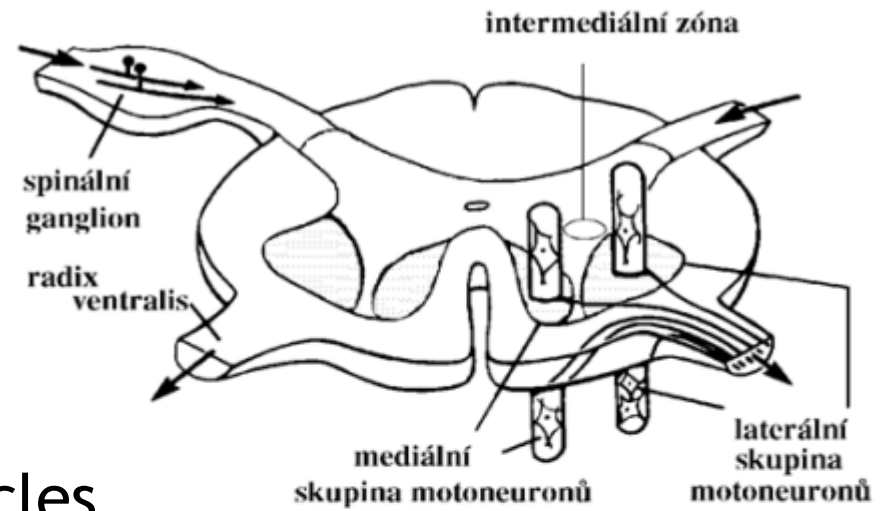

- ❑ **Motor neurons** have highly branched, elaborate dendritic trees, enabling them to integrate the inputs from large numbers of other neurons and to calculate proper outputs.
- ❑ The combination of an individual motor neuron and all of the muscle fibers that it innervates is called a **motor unit**.

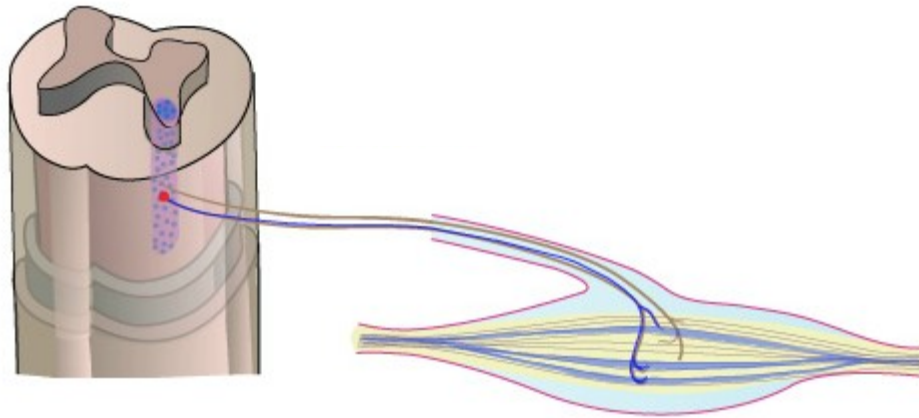

□ size of motor unit

- small motor unit - 1 motoneuron innervates several muscle fibers (extraocular muscles, muscles of hand)
- large motor unit - 1 motoneuron innervates 500 - 1000 muscle fibers (back muscles)

Lower motor neurons - brain stem

- ❑ Somatomotor nuclei
CN III, IV, VI, XII
- ❑ Branchiomotor nuclei
CN V, VII, IX, X, XI

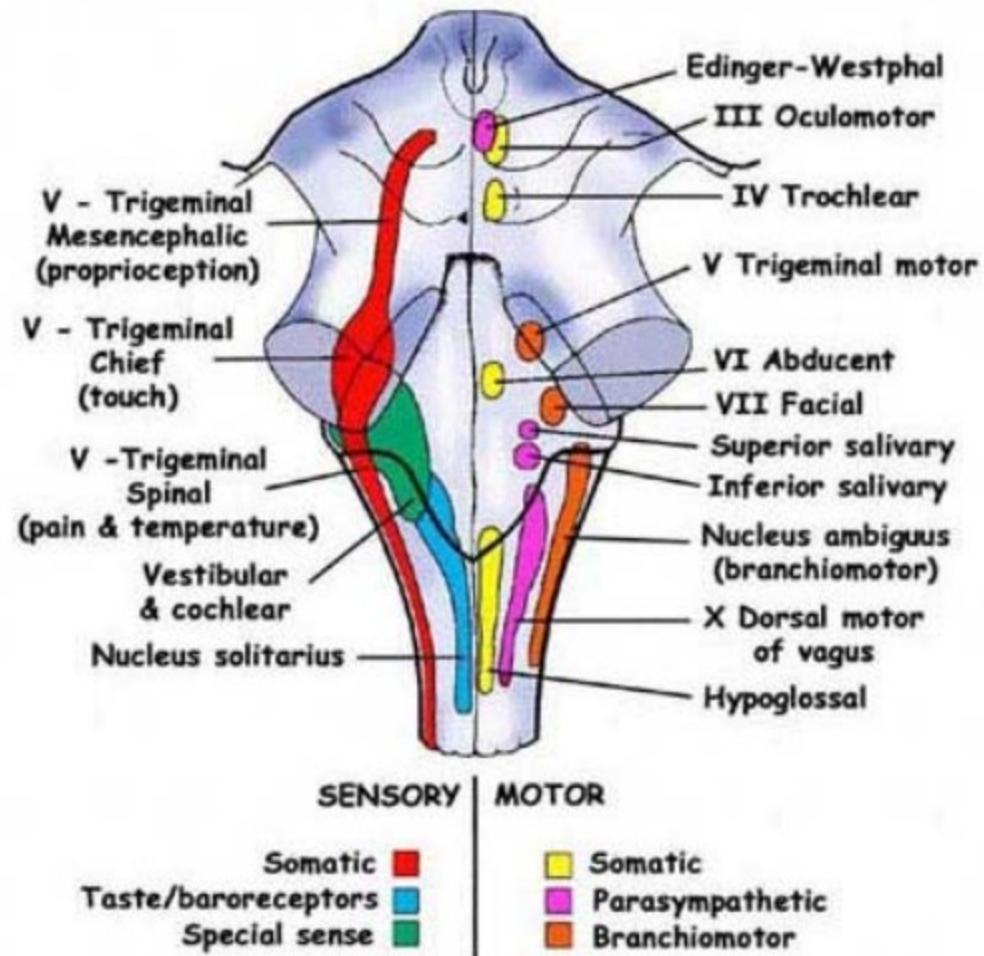

Supraspinal system of movement control

- ❑ Medial system
 - bilateral
 - terminates on the interneurons or the medial column of lower motor neurons
 - controls maintenance of balance and postural movements

- ❑ Lateral system
 - mostly cross the midline and descend contralaterally
 - terminates on the interneurons or the lateral column of lower motor neurons
 - controls fine manipulative movements of the hand and fingers

- ❑ The “third” motor system
 - aminergic pathways of the brain stem

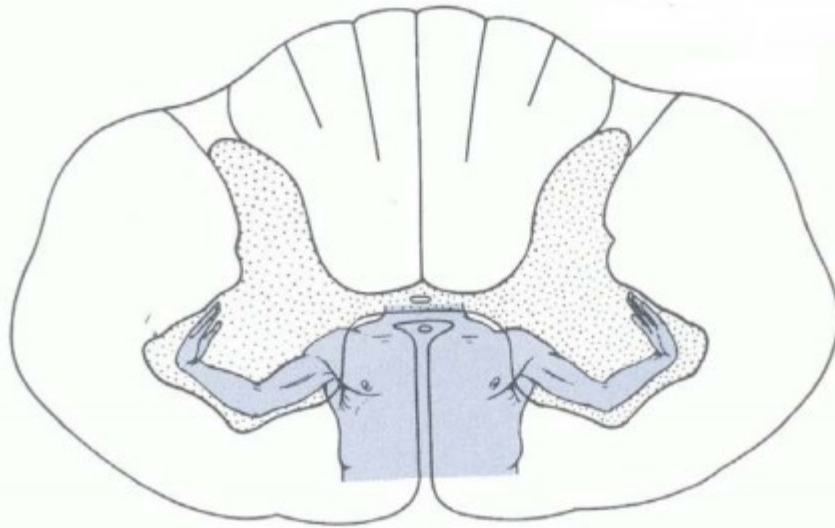
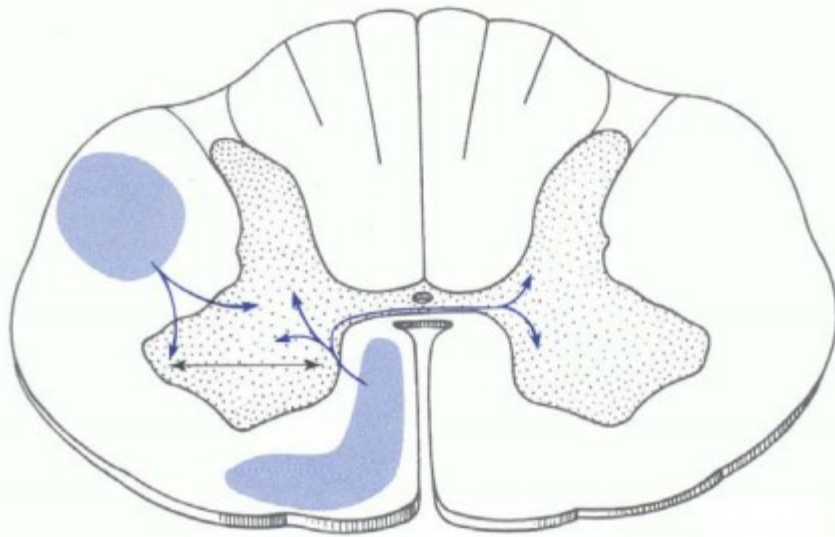

Medial system

- ❑ Subcortical pathways
 - **Medial and lateral vestibulospinal tracts** - control of balance and postural movements
 - **Tectospinal tract** (sup. colliculus) - coordination of movements of the head and eyes during watching
 - **Medial (pontine) and lateral (medullary) reticulospinal tracts** - control of postural movements

- ❑ Cortical pathways
 - **Anterior corticospinal tract** - bilateral, medial column of lower motor neurons

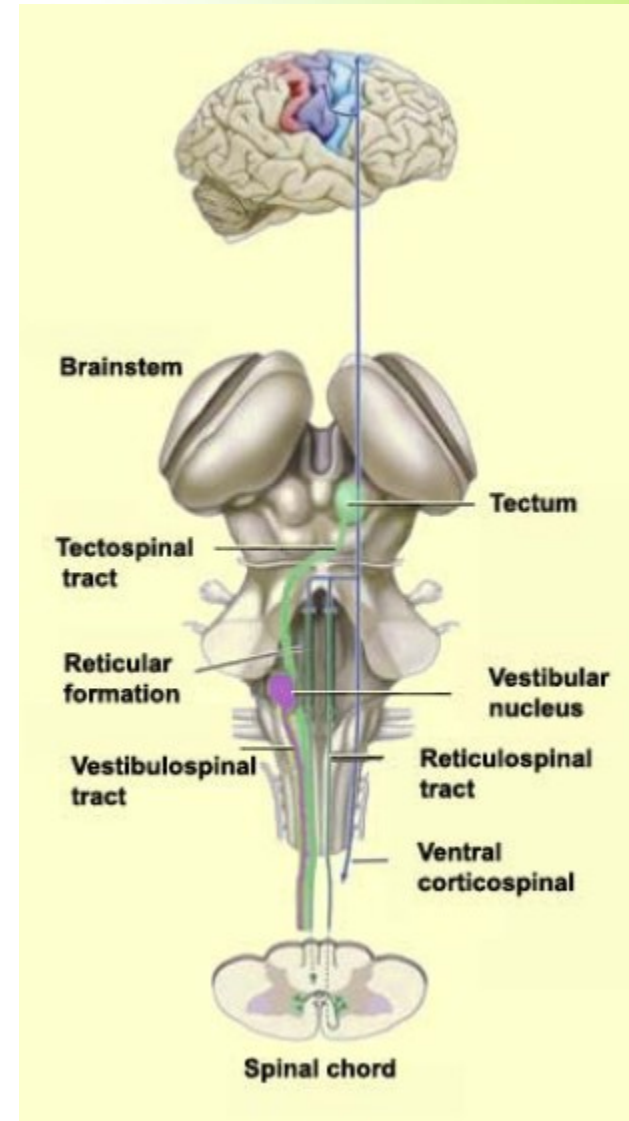

Lateral system

- ❑ Subcortical pathways
 - **Rubrospinal tract**
 - contralaterally descends to the lateral column
- ❑ Cortical pathways
 - **Lateral corticospinal tract**

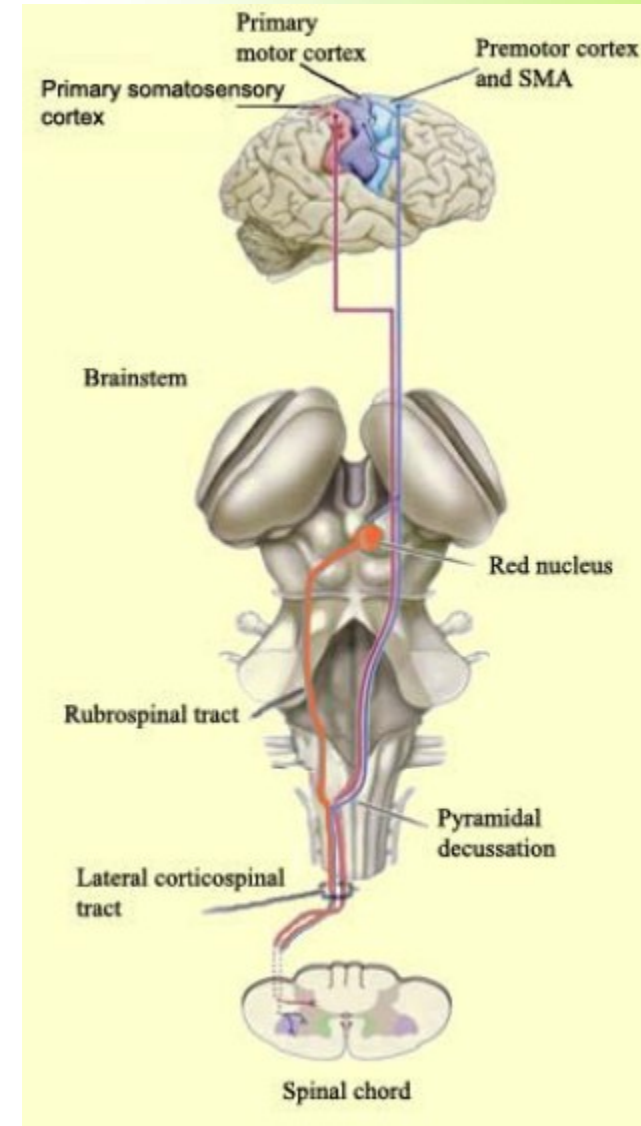

Corticospinal and corticonuclear tracts

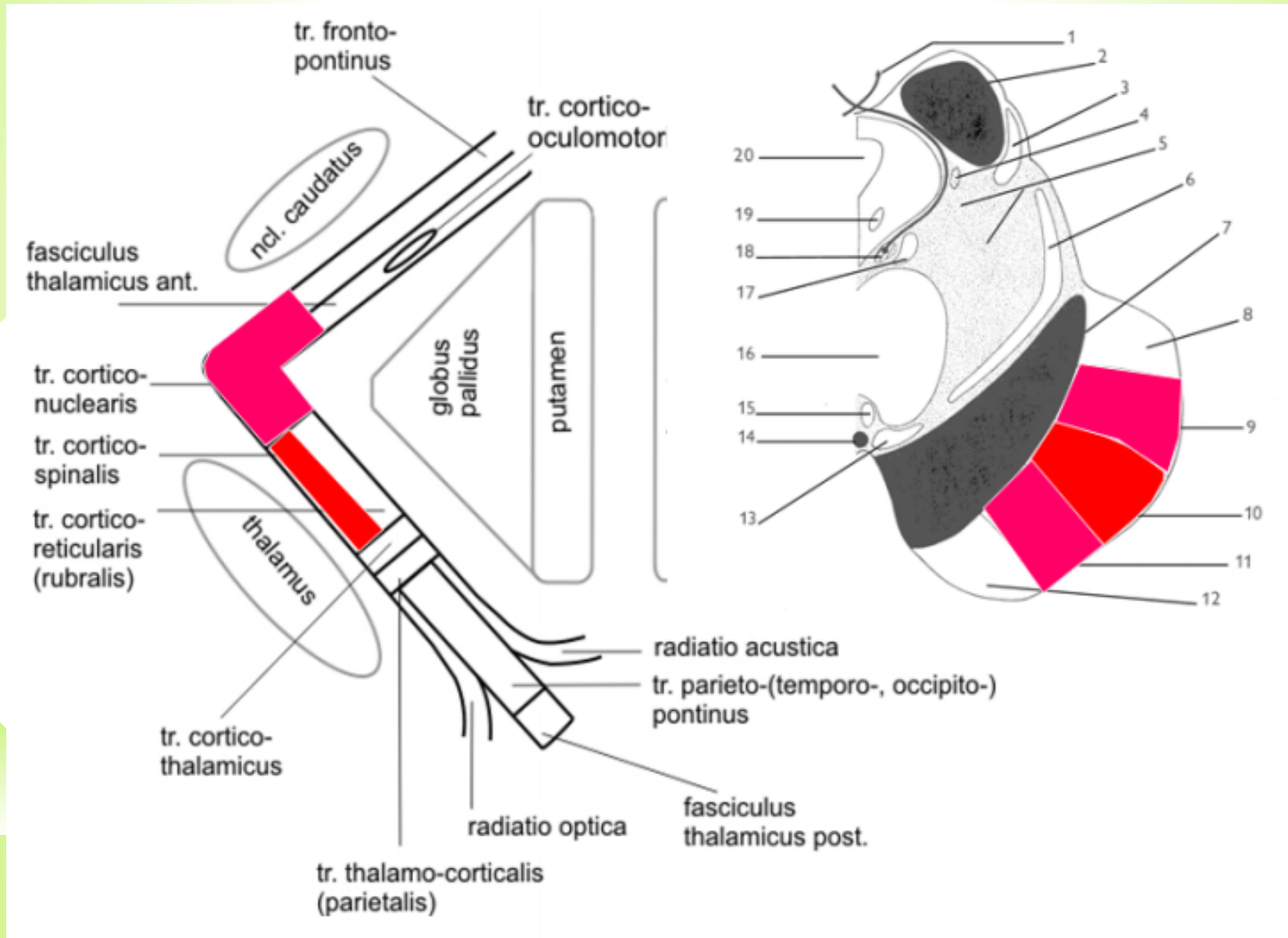

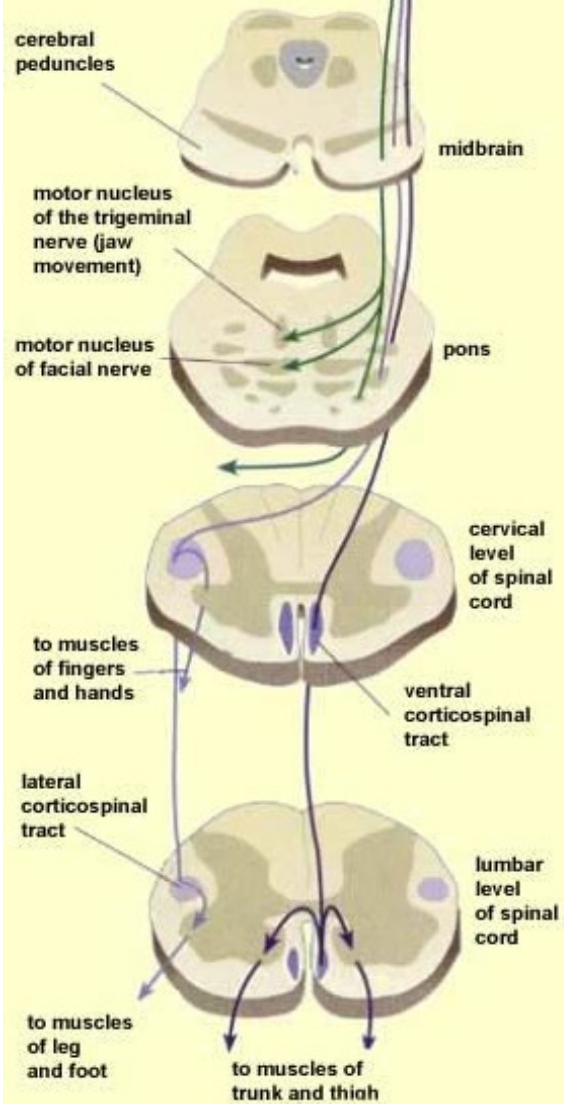
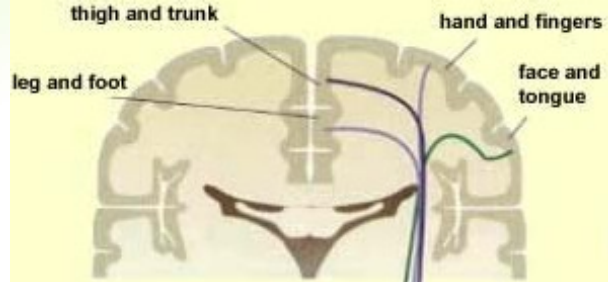

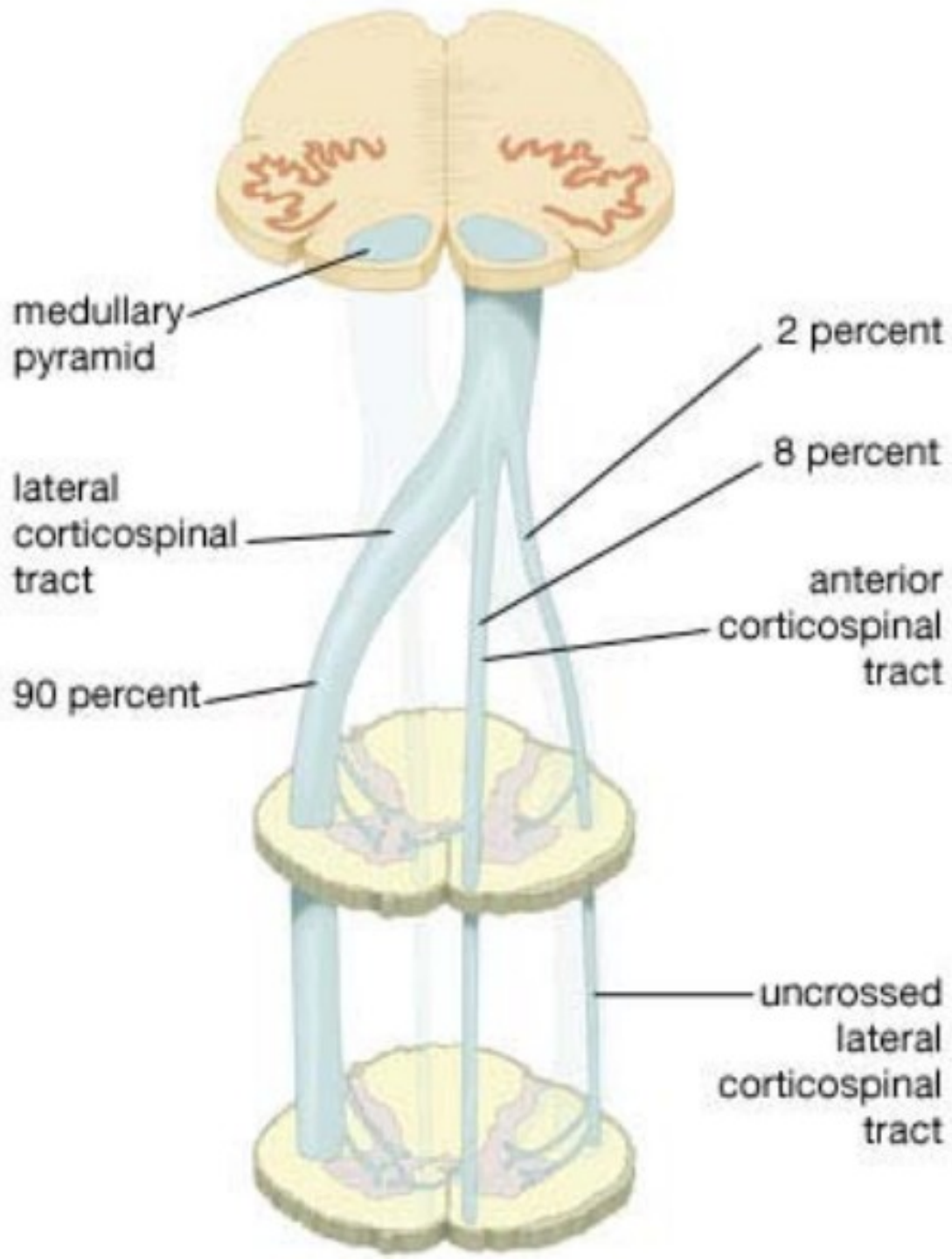

The third system

- ❑ the oldest one
- ❑ nuclei of RF - **raphespinal** and **coeruleospinal tracts**
- ❑ control of involuntary emotional movements

Motor cortex

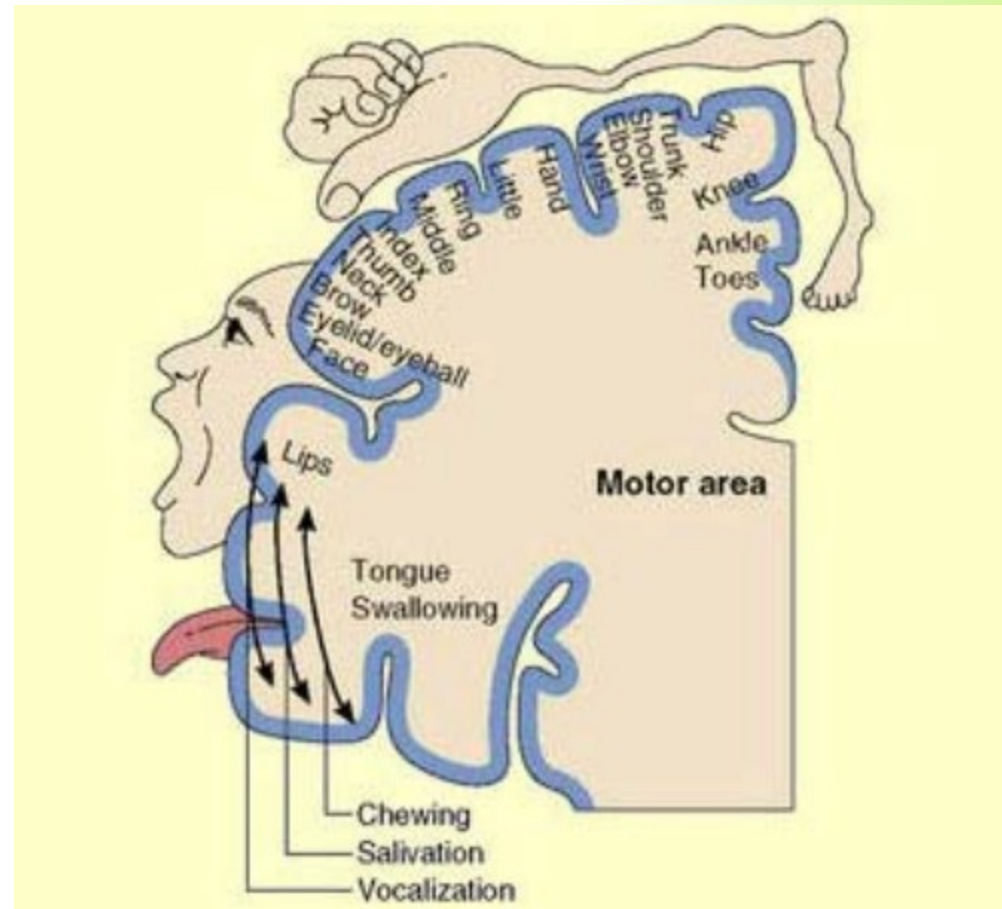
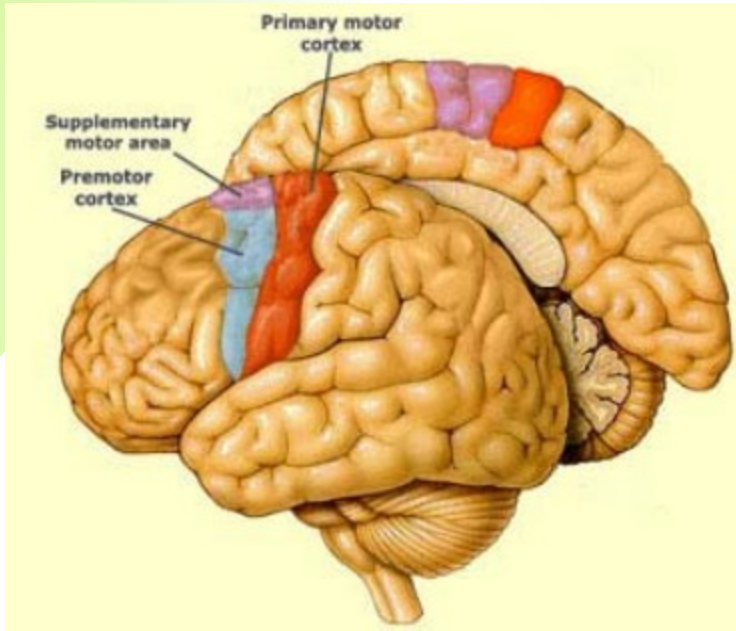

Planning of movements

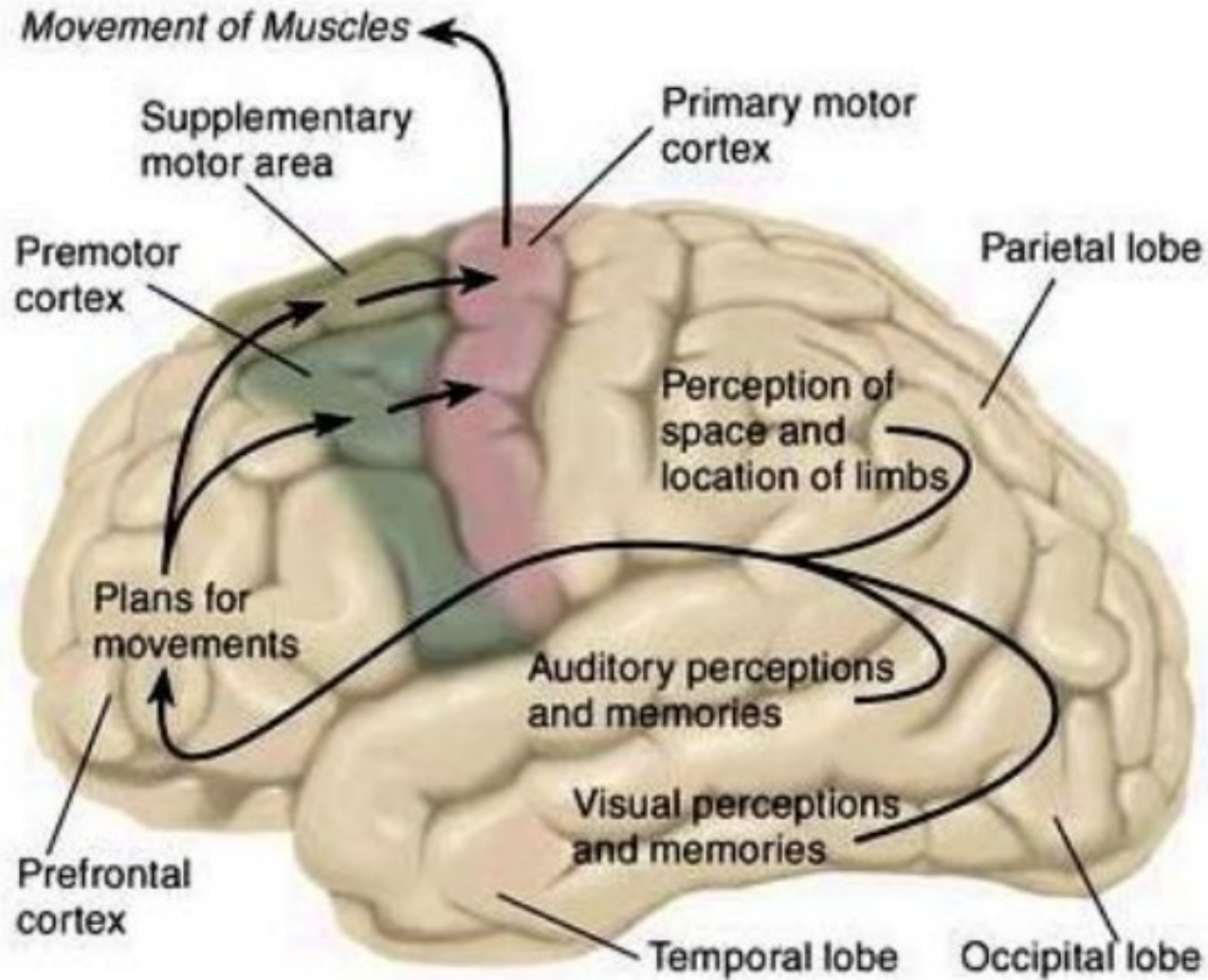

Illustrations were copied from:

**Neuroscience Online, the Open-Access Neuroscience
Electronic Textbook**

Department of Neurobiology and Anatomy
University of Texas Medical School at Houston