

# Prosthetic III.

Fixed dentures

# Fixed dentures

- Restore the form (and function)
- Cemented on (in the ) prepared teeth
- Can not be removed

# Fixed dentures

Inlays /onlays

Crowns

Bridges

# Inlay

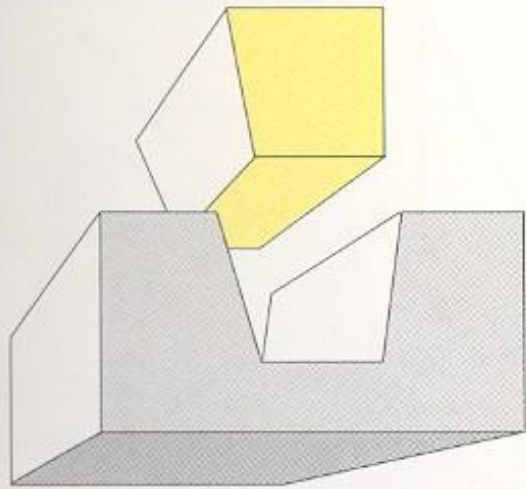

# Onlay

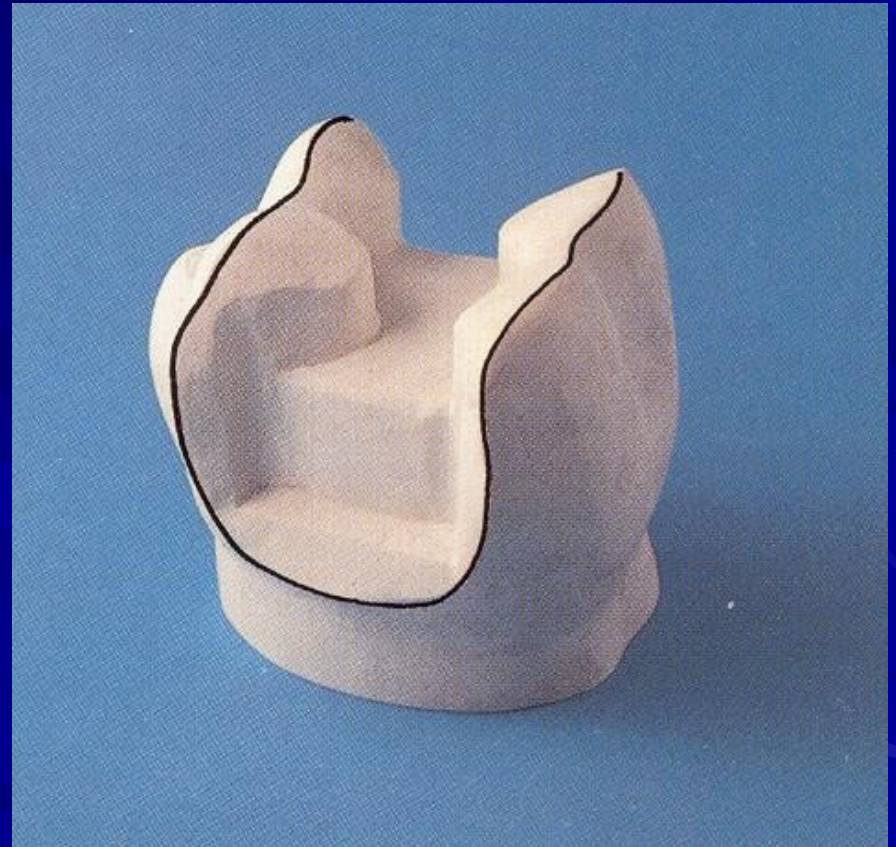
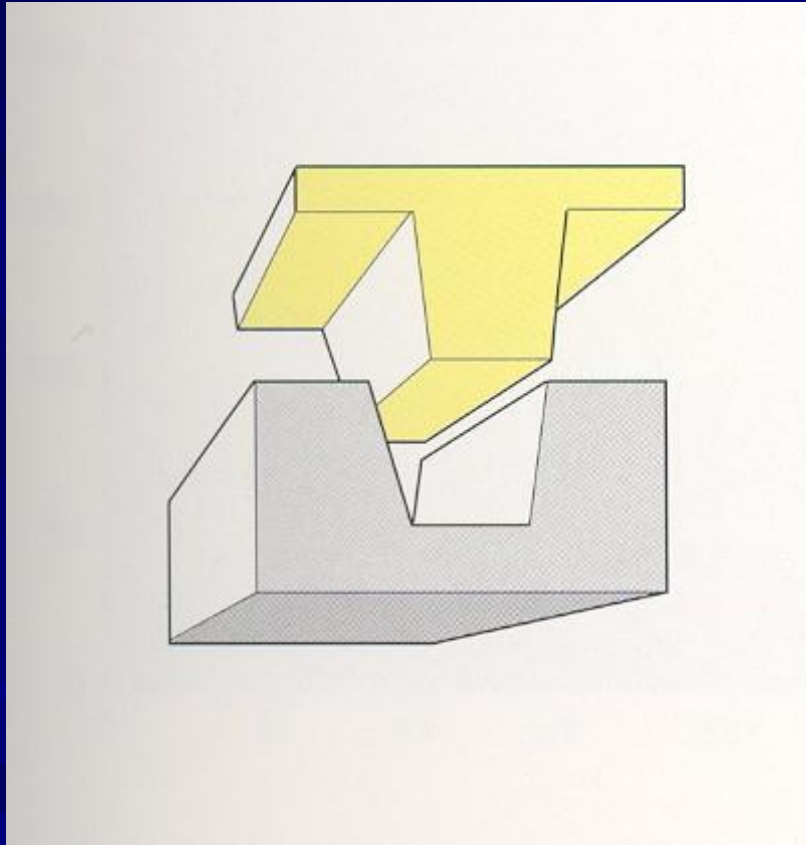

# Overlay

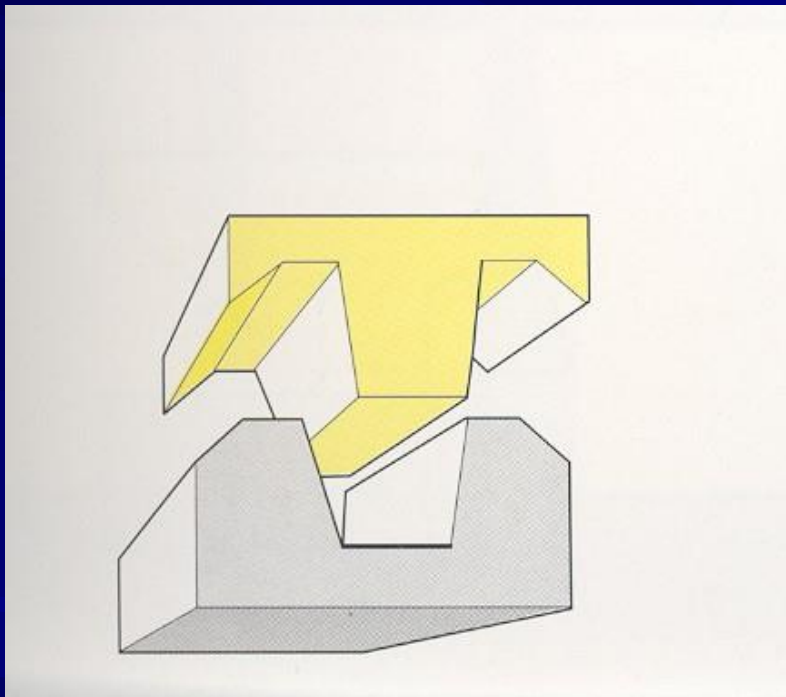

# Partial crown

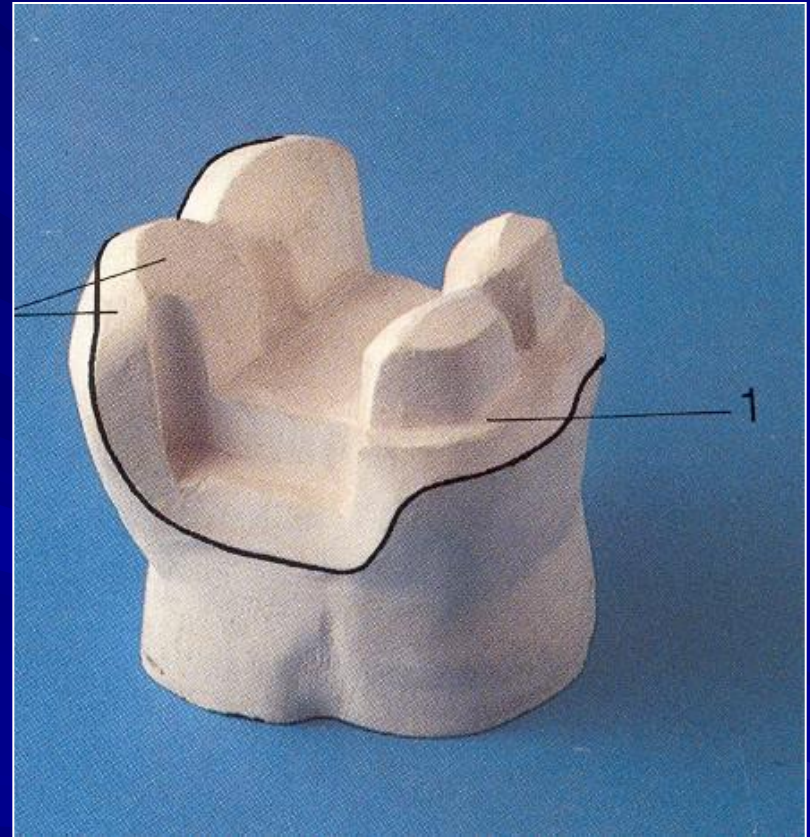
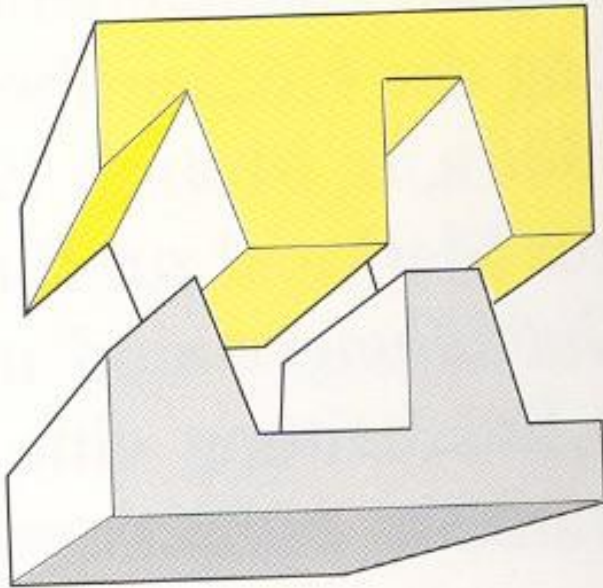

# Crown

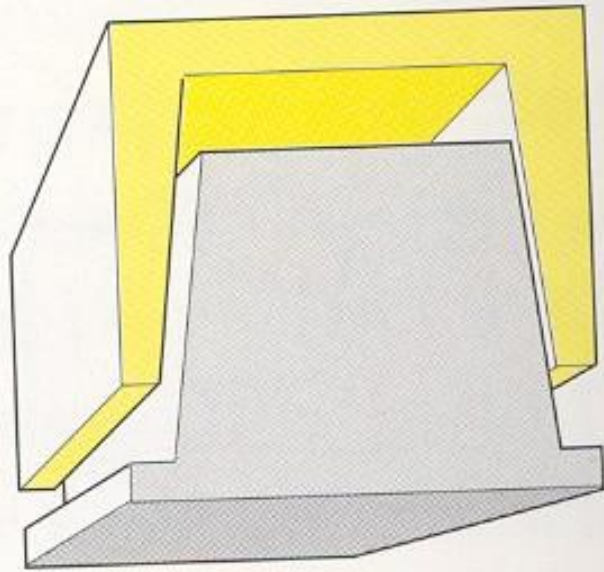



# Root canal inlay

Root canal filling

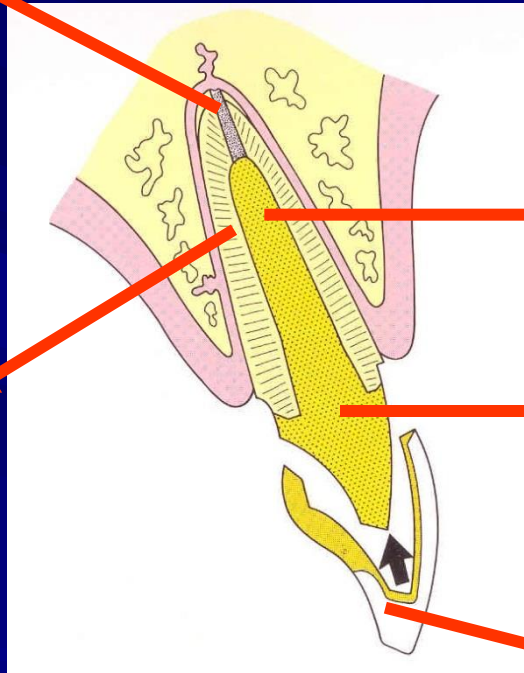

Root

Root post

Stump, snag

Crown

# Fixed bridge

- Replacement one or more teeth

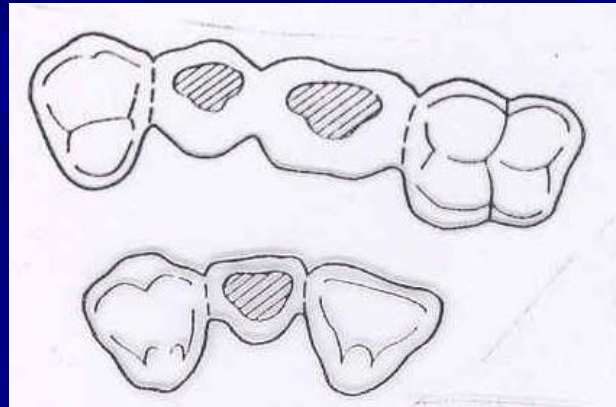

# Crowns

Restore the shape of a damaged tooth

Most frequently

- Replace the lost part of a tooth (caries, fracture)
- Protect before damage
- Anchoring of a bridge

# Indications

1. Badly broken down tooth (previously restored, secondary caries, loss of vitality)
2. Fracture (large)
3. Tooth wear- erosion (chemical)
  - attrition (mechanical)
  - abrasion (pathological)
  - diseases of the hard dental tissues
4. Changes in position of teeth

# Types of crowns

## Full crowns

One material (metal alloy, resin, ceramics)

*resin and ceramics - jacket crowns*

## Facet crowns

Combination of materials

Metal alloy –resin

Metal alloy – ceramics

Partially / full covered

# Crown

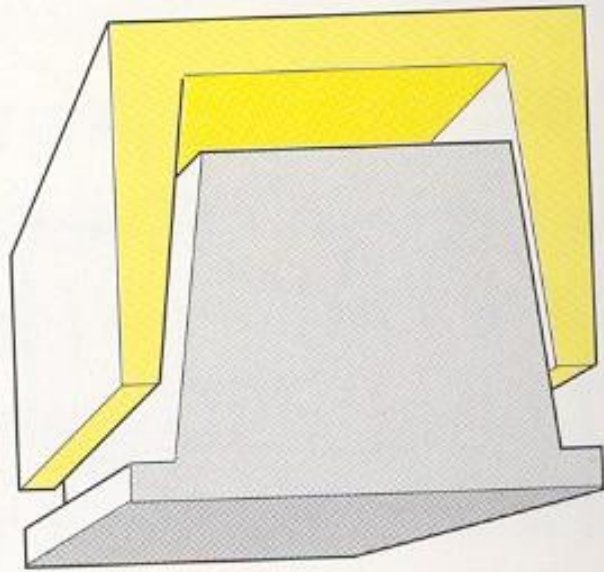

# Retention of rigid fillings

Whitstand capability against axial forces:

*Geometry of the preparation*

*(facilitating shape)*

*Quality of the luting material*

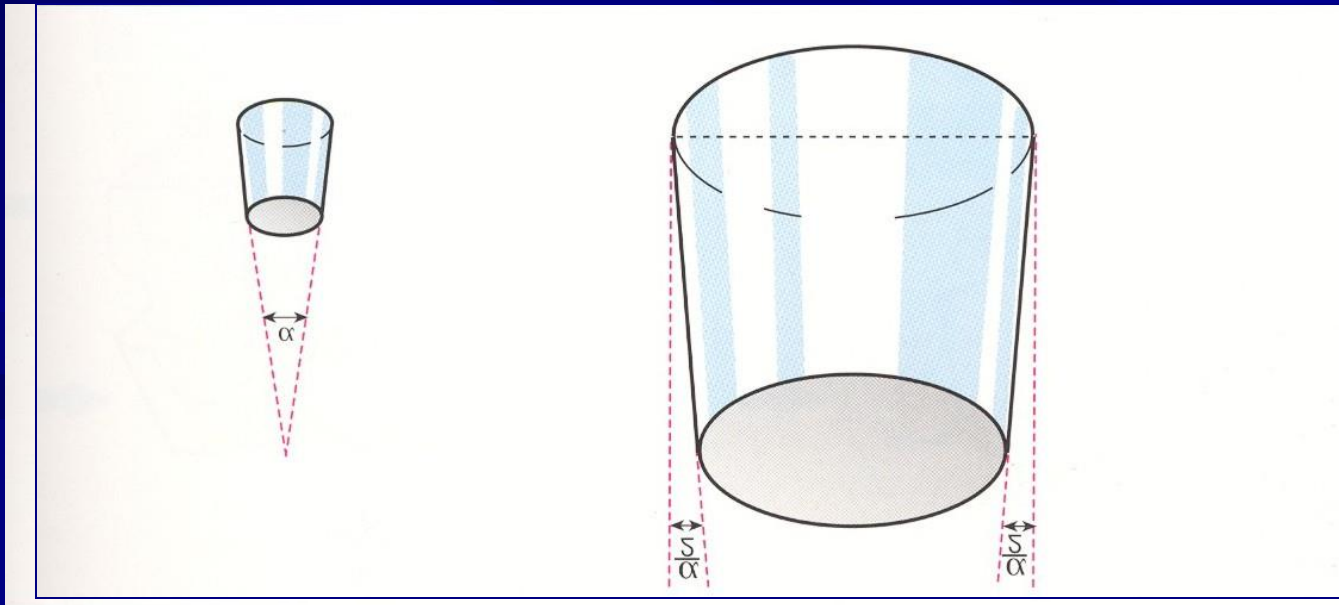

Retention g/mm<sup>2</sup>

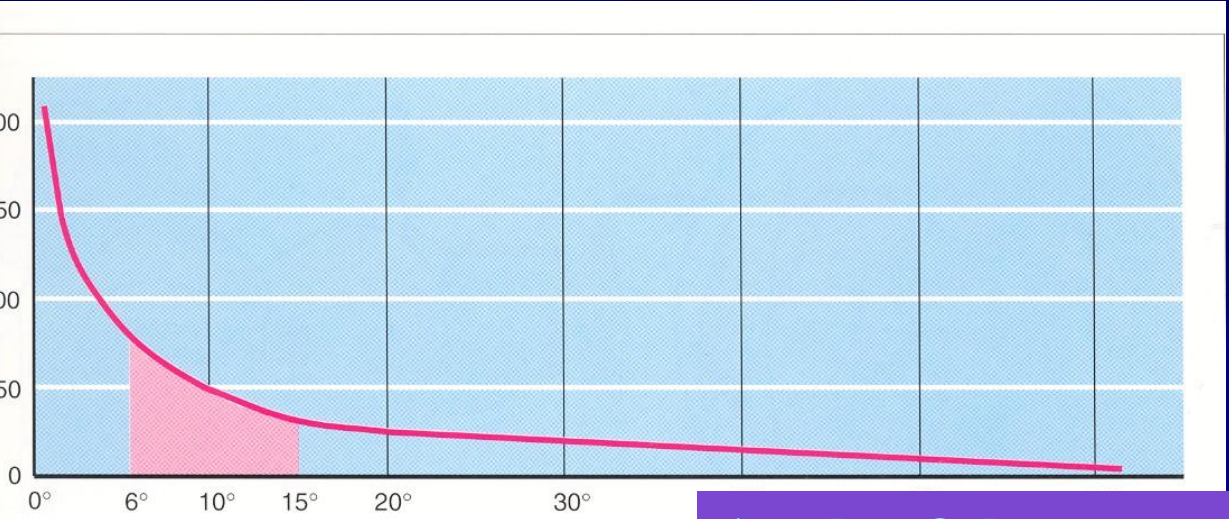

Angle of the convergence

Outer or inner conus

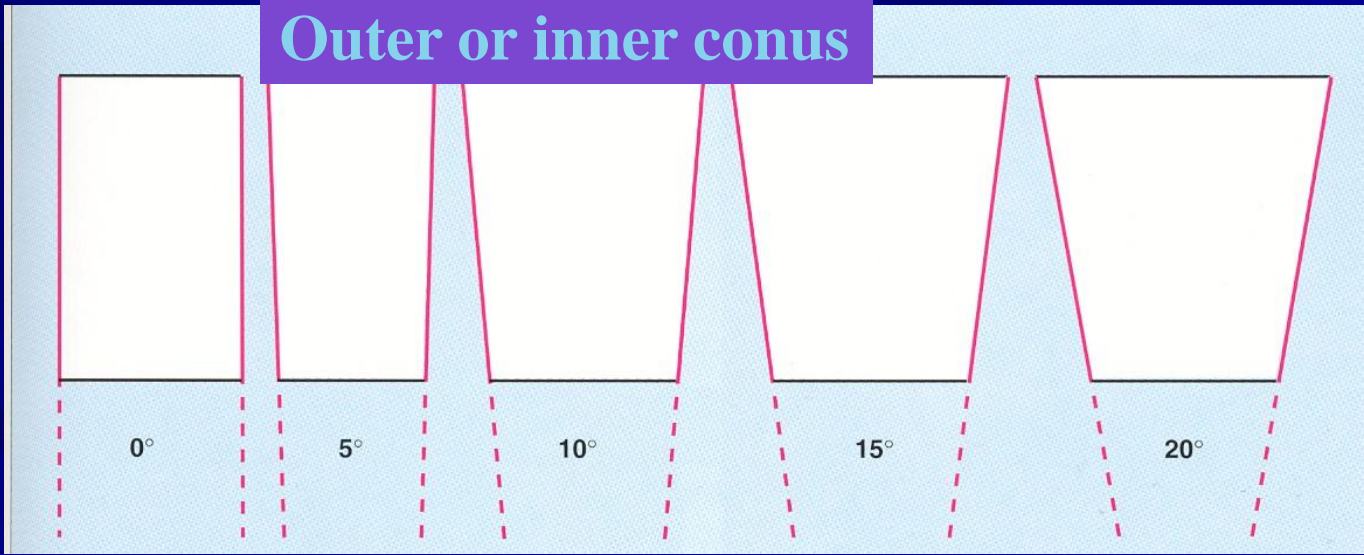



# Retaining areal

- Surface of contact

*Rigid filling*

*Inlay or crown (internal, outer, combined)*

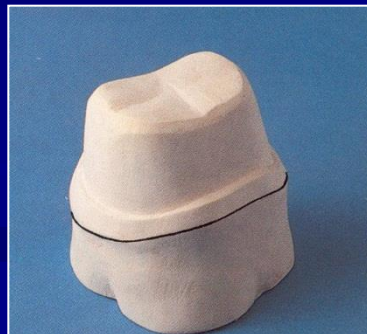

# Full crown

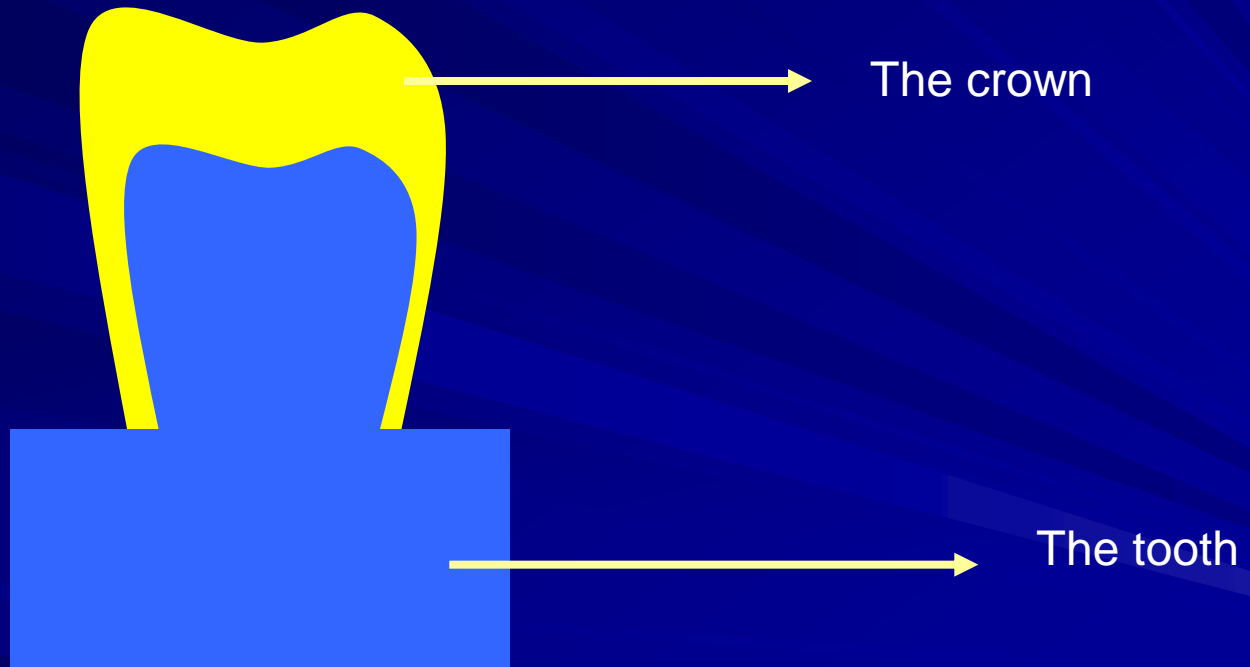

# Full crown



Posterior teeth

# Facet crown

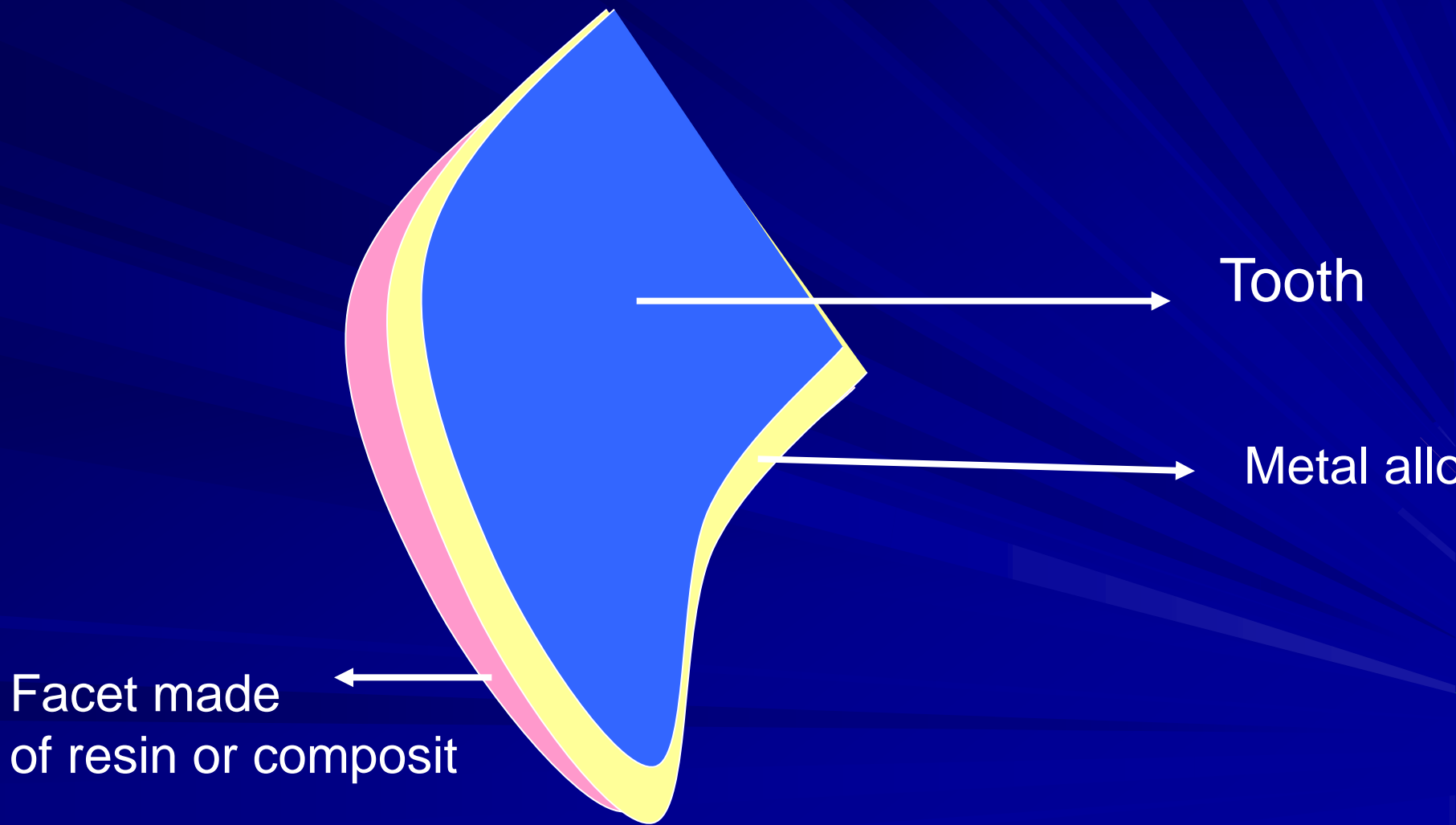

# Facet crown

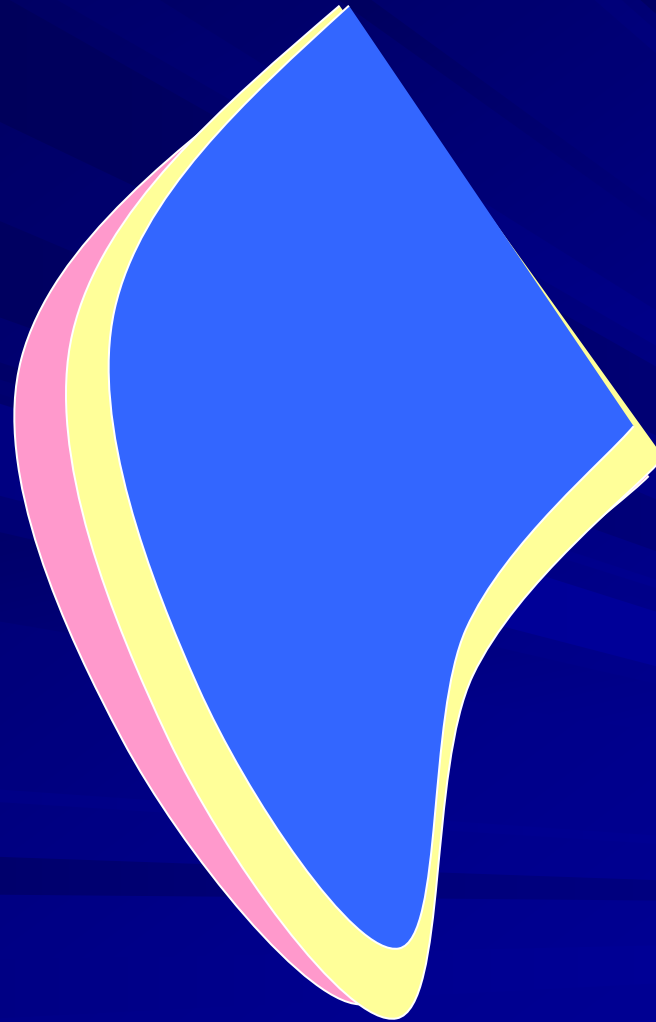

Anterior teeth

# Facet made of ceramics

## Metalceramic

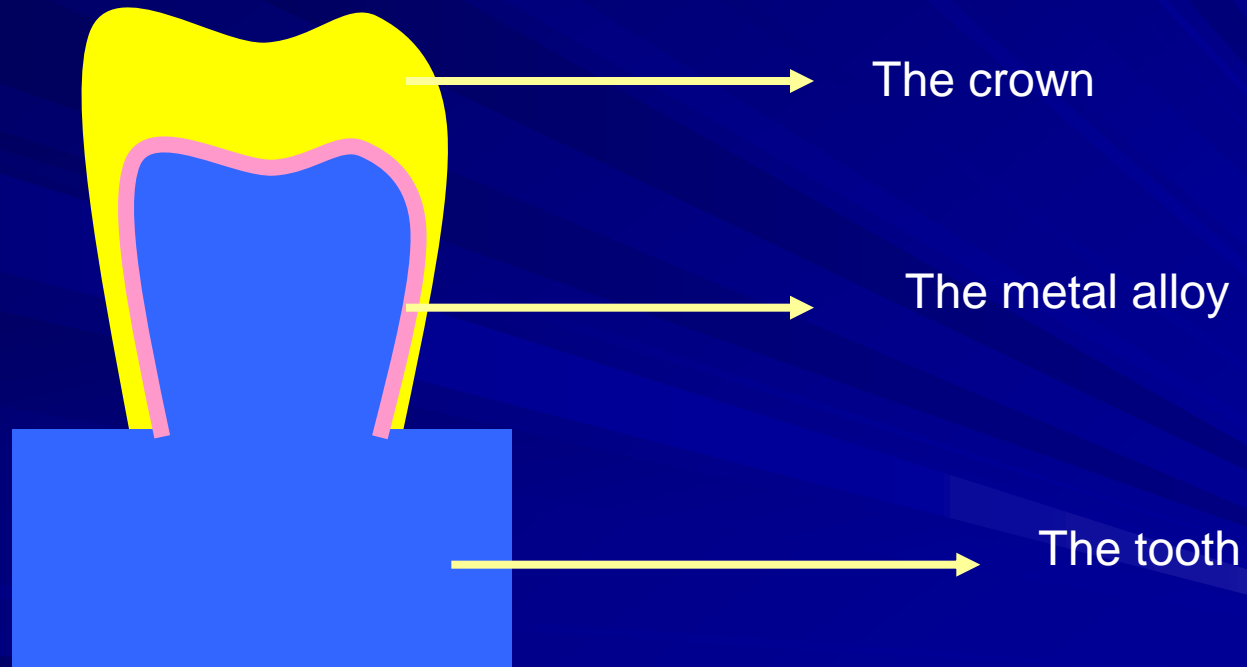

# Metalceramic

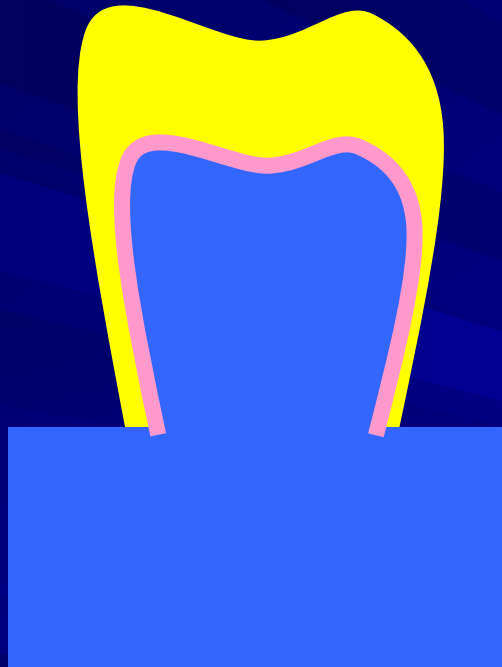

Posterior teeth  
Anterior teeth

# Jacket crown

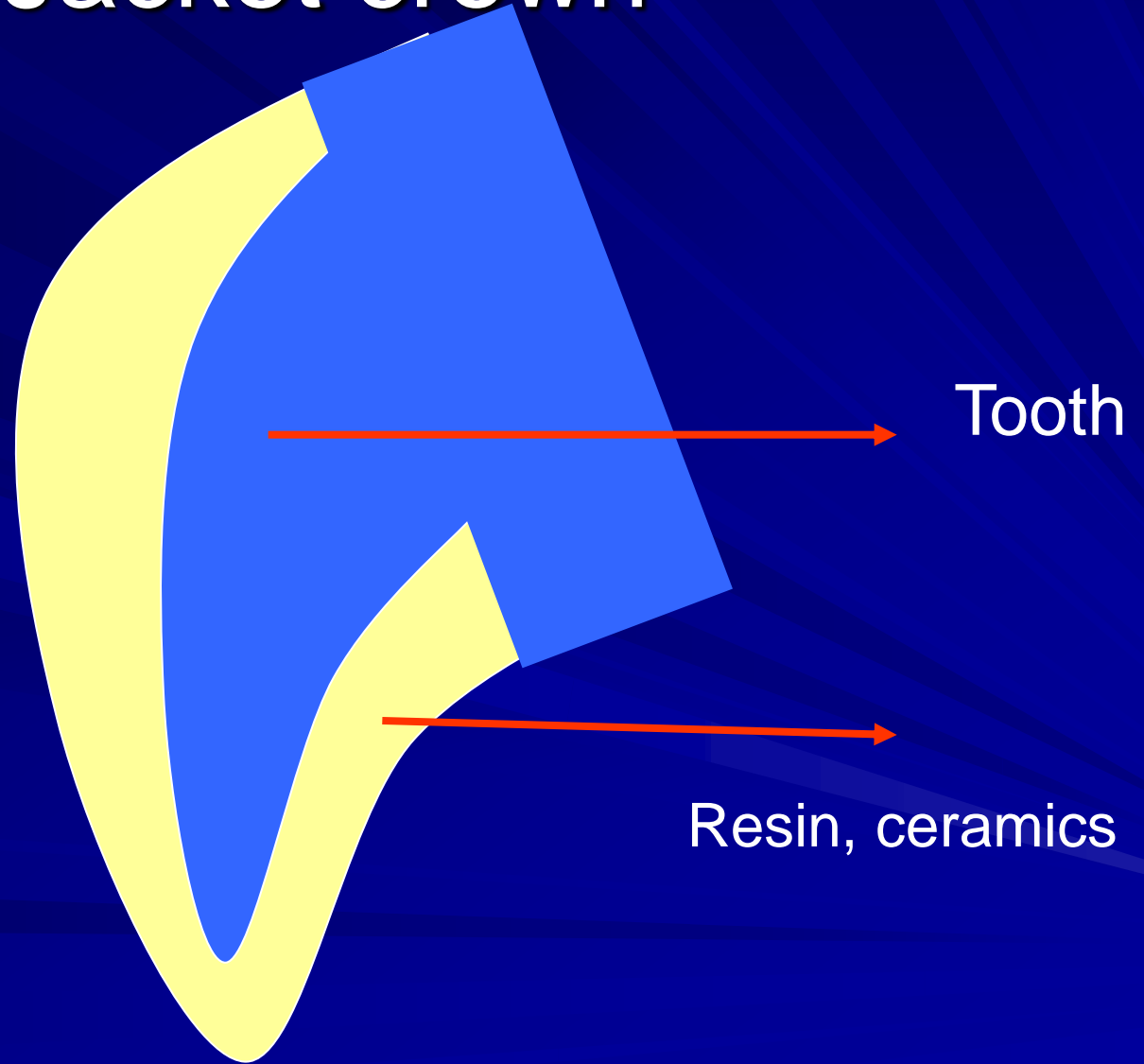



# Crown

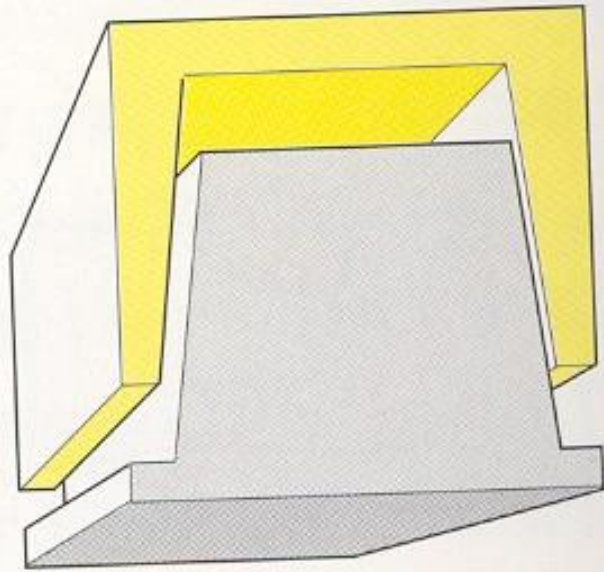

# Retention of rigid fillings

Whitstand capability against axial forces:

*Geometry of the preparation*

*(facilitating shape)*

*Quality of the luting material*

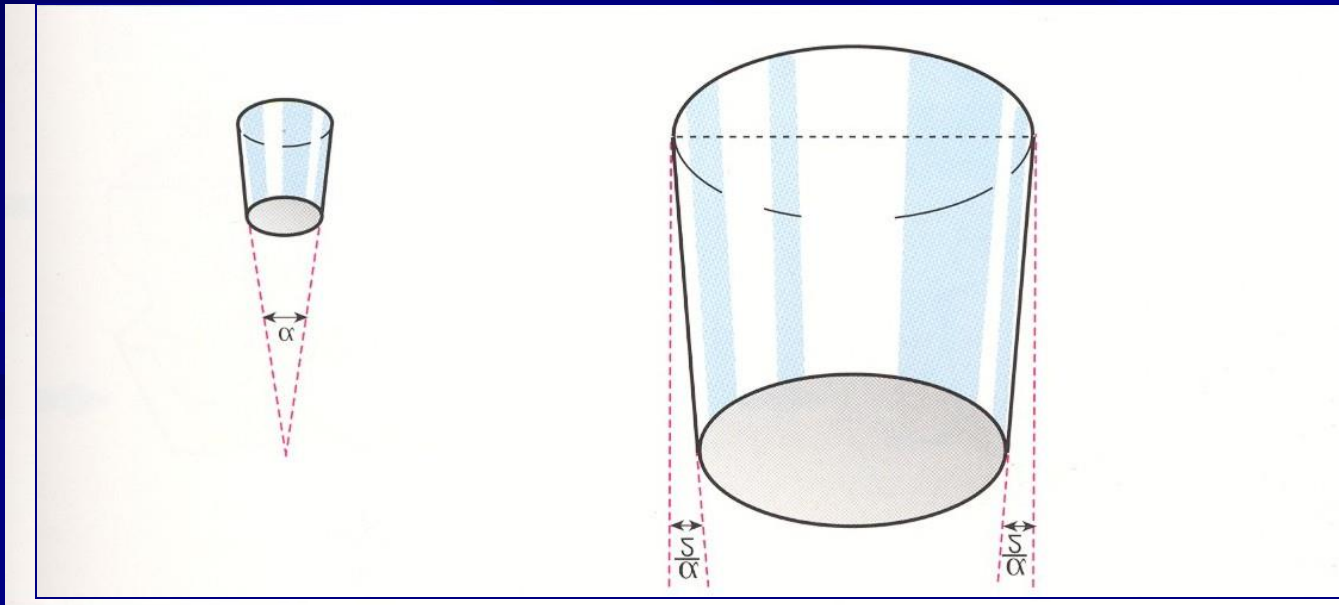

Retention g/mm<sup>2</sup>

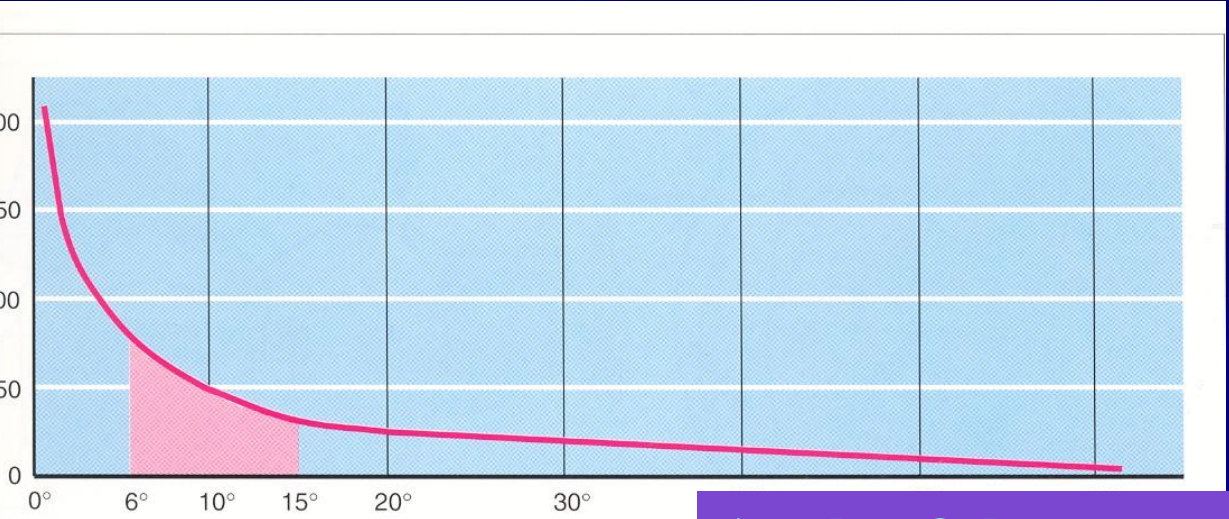

Angle of the convergence

Outer or inner conus

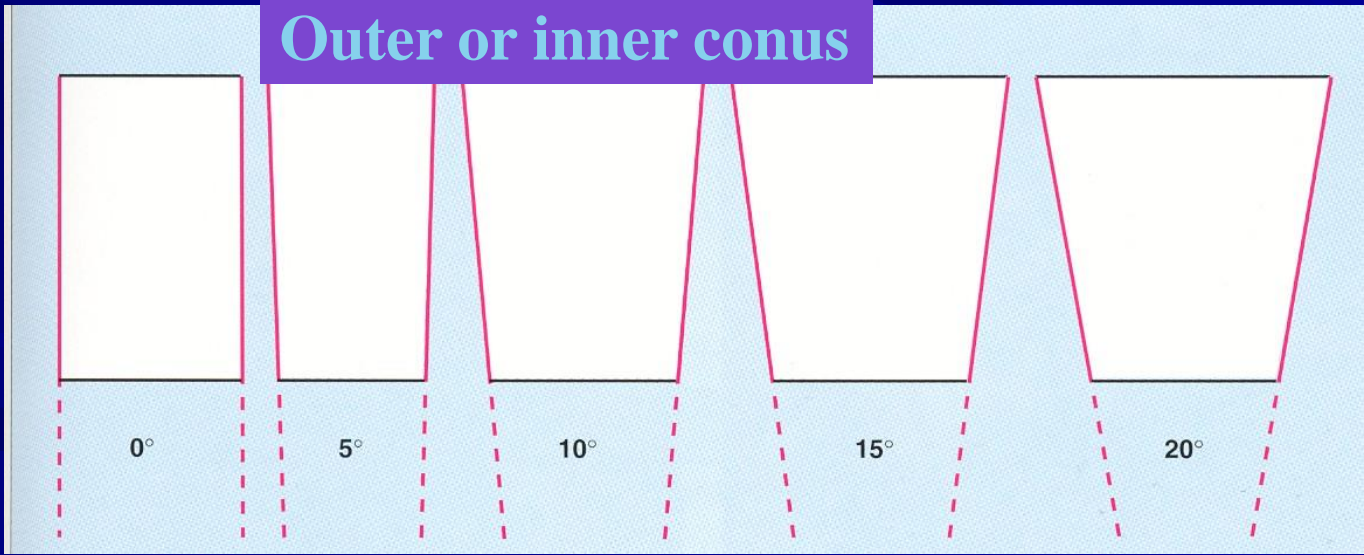

# Retaining areal

- Surface of contact

*Rigid filling*

*Inlay or crown (internal, outer, combined)*

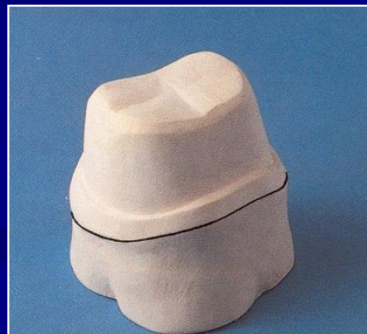

# Basic rules for the crown preparation

- Reduction of the hard dental tissues – space for the artificial material (restore the form as well as the function – strong enough)
- Conical form ( $5^{\circ}$  -  $7^{\circ}$  optimal, max  $15^{\circ}$ ), no undercuts!!!! No sharpe edges!!!

# Basic rules for the crown preparation

- Cervical border – shoulder must be clear, it can. The location is:
  - Supragingival
  - Subgingival
  - Gingival

# Full metal crown

- Occlusal reduction: 1,5 mm, following the anatomical form
- Reduction vestibular and oral – 0,5 mm (max 1 mm)
- Shoulderless

# Combined crown – facet crown

- Metal construction + facet (made of acrylic or composit)
- Incisal or occlusal reduction 1,5 mm
- Vestibular reduction 1,5 mm
- Oral reduction 0,5 mm
- Round shoulder (vestib appr. 1 – 1,5 mm, oral 0,5 – 1 mm)



# Combined crown - metalceramic

- Occlusal (incisal reduction) – 2 mm
- Vestibular and oral reduction and other  
1,5 mm
- Round shoulder

# Jacket crown – ceramic, composit, acrylic

- Occlusal (incisal reduction) – 2 mm
- Vestibular and oral reduction and other 1,5 mm
- Sharp rectangle shoulder

# Replacement of missing teeth

Bridges

Fixed

Removable

Implants

# Bridges

- Abutments (crowns on abutment teeth)
- Pontic

Various size:

3 members bridges, 4 members bridges, 5 members... etc

The member: abutment or pontic.

# Bridges

■ Abutments are

Full metal crown

Facet crown

Metalceramic crown

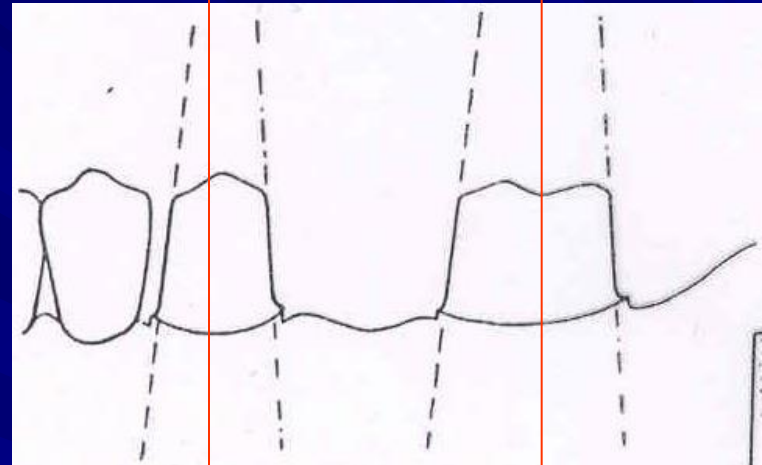

The axis must be parallel

# Bridges

## ■ Pontic

Full metal

Facet

Metalceramic

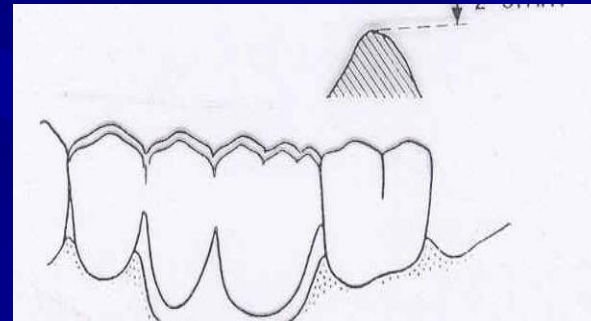
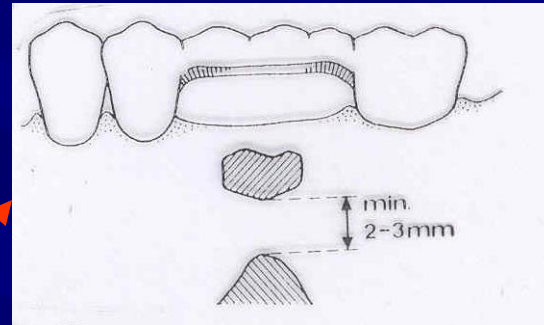

Self cleaning bridge (sanitary bridge)

Contact pontic

Reduction - the area that is in contact with gingiva  $\frac{1}{3}$  of the occlusal size.  
Occlusal reduction depends on the magnitude from 10 – 30% reduction.

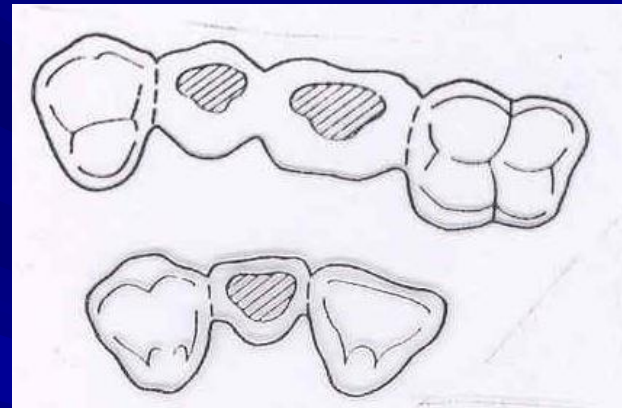
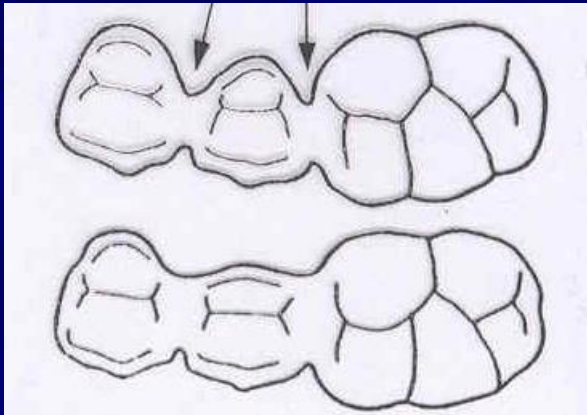

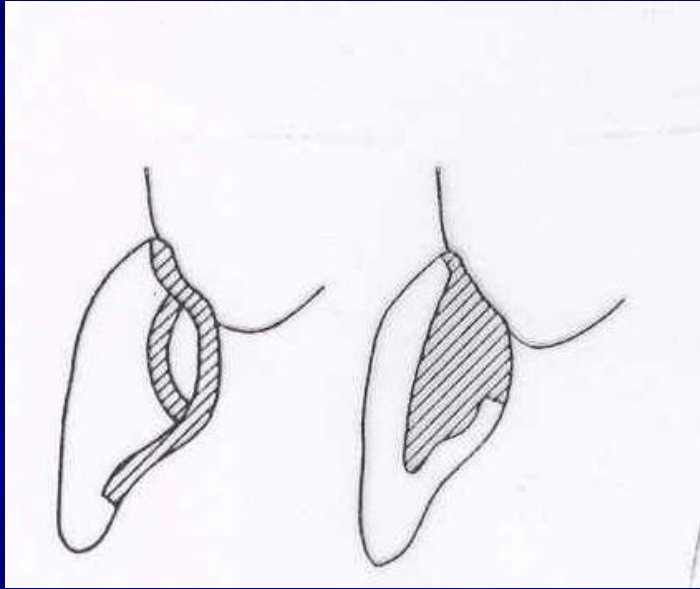
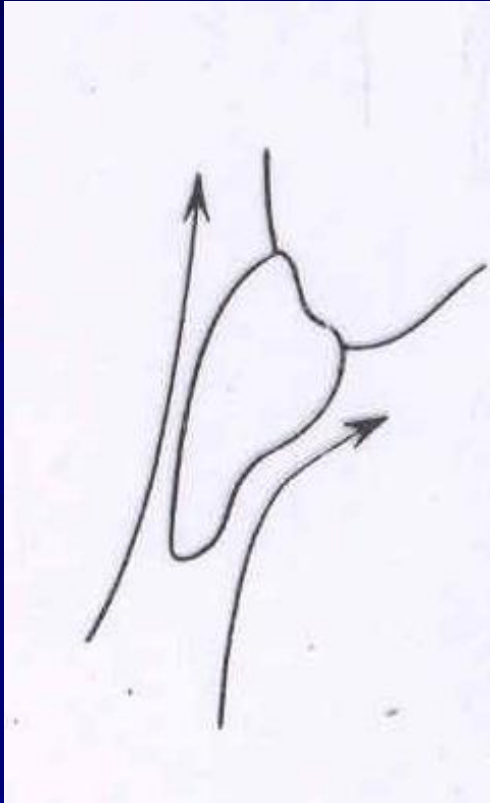



# Preparation

- Preparation grooves
- Occlusal reduction
- Vestibular reduction
- Oral reduction
- Proximal reduction
- Finishing and polishing

# Preparation

- The long axis of each abutment tooth must be parallel.

If not the cementation would not be possible.

# Manufacturing procedure

## 1.st phase in dental office

- Taking impression – elastomers
- Antagonal impression )alginate
- Occlusal impresion – bite registration (intermaxillary relationship)
- Provisional treatment

# Manufacturing procedure

## 1.st phase in dental lab

- Plaster model– the dental arch is made of ultrahard gypsum, the base of a stone.
- The model is divided after application of guide pins
- The antagonal model of stone
- Mounting to the articulator (simulator)

# Manufacturing procedure 1.st phase in dental lab

- The wax pattern of the metal framework is manufactured
- Casted (the method of lost wax)
- Adapted on the model

# Manufacturing procedure 2.nd phase in dental office

- The framework is tried out
- The colour of veneering material is chosen

# Manufacturing procedure 2.nd phase in dental lab

The veneering material is applied on the framework and polymerized or burnt (ceramics).

# Manufacturing procedure 3.rd phase in dental office

- The denture is tried out
- Cemented
- (zinkoxidphosphate cement, glasionomer or composite)



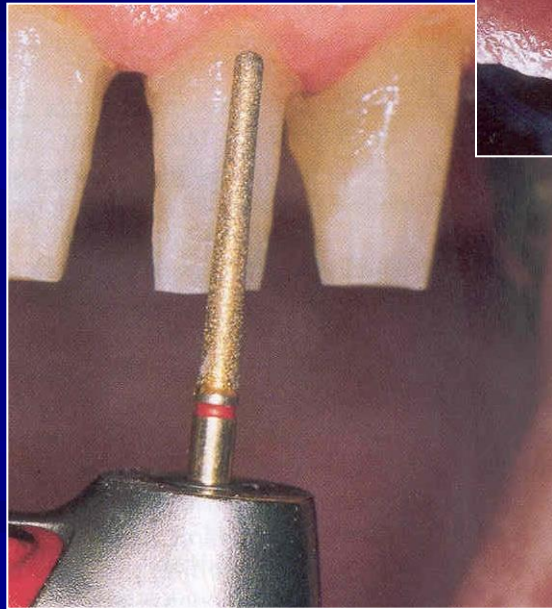
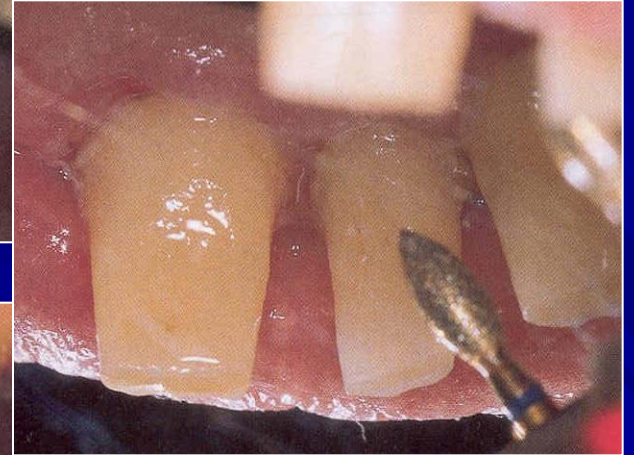
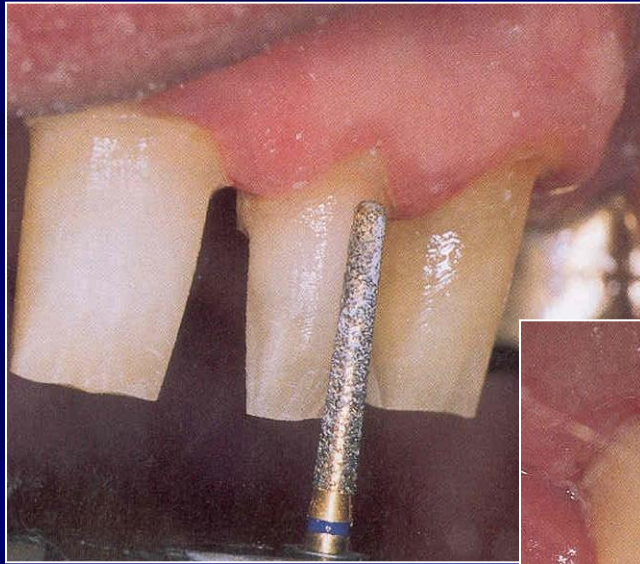

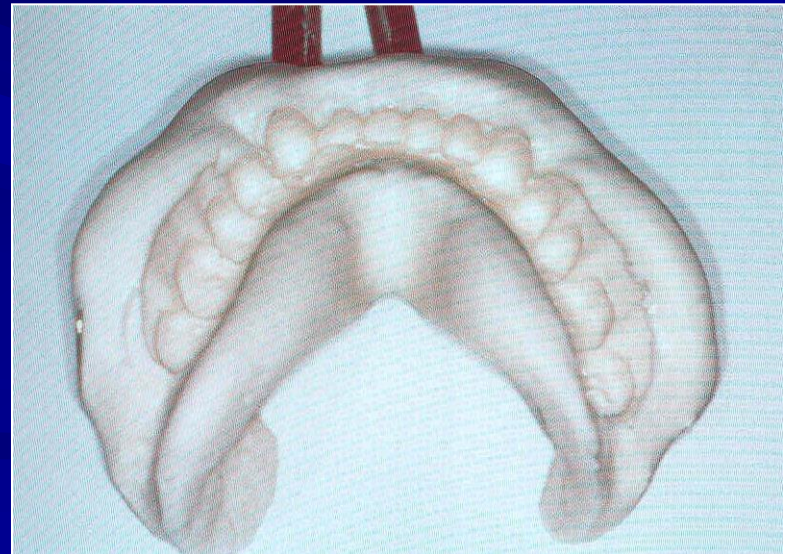
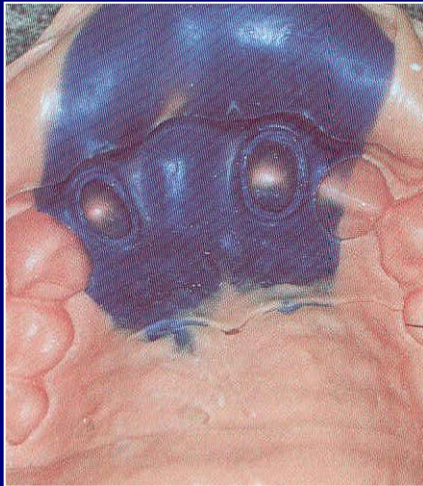

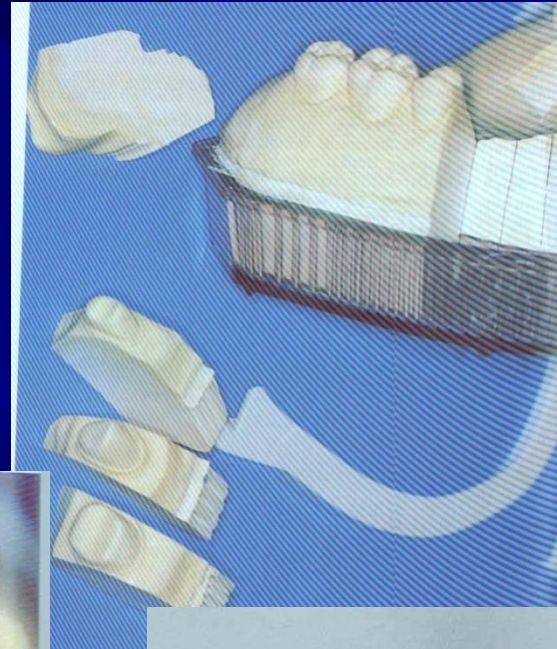
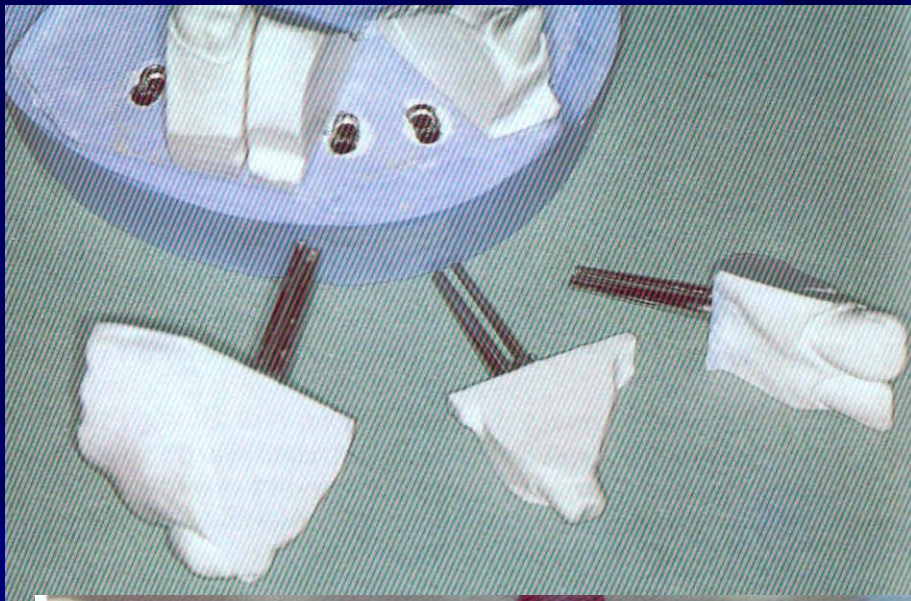

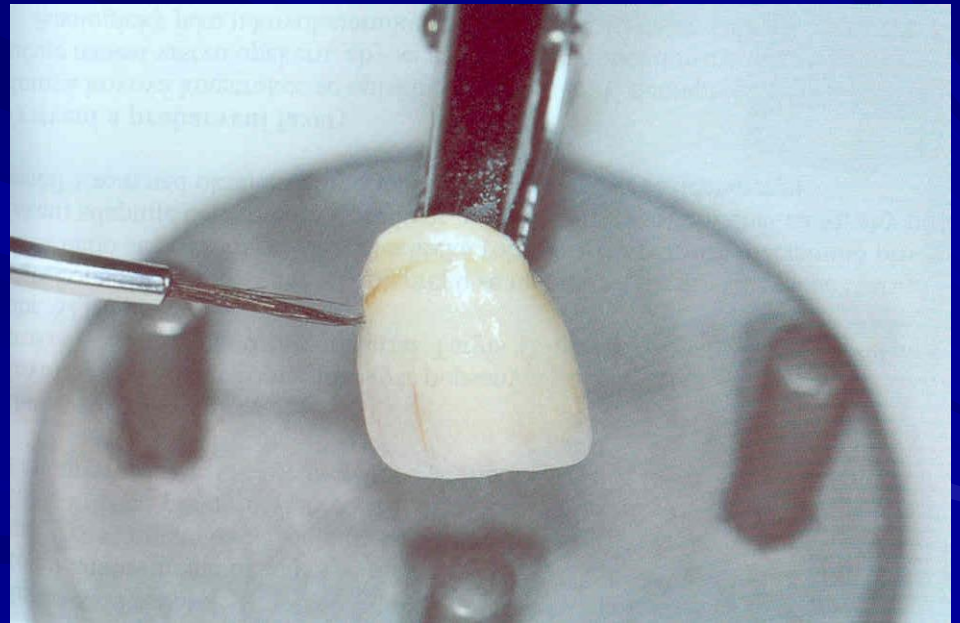
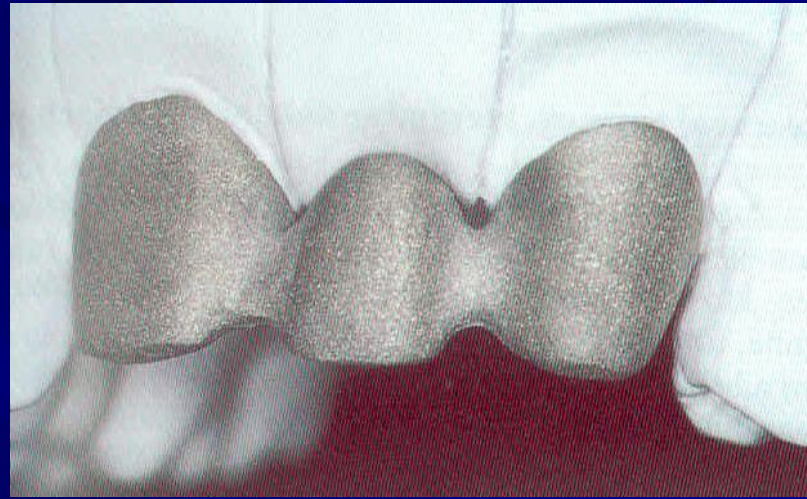

# Temporary prosthetic treatment

- Protection of prepared teeth – dentin wound
- Keeps the abutment teeth in their position
- Other reasons
  - Correction of the intermaxillary relations
  - Aesthetics
  - Disorders of TMJ

# Material

- Acrylic resin – dental lab
- Special resins for direct fabrication in oral cavity

# Sequence of operations

## I.st phase in dental office

- Taking the impression using the alginate impression material ( both dental arches)
- Intermaxillary relations - wax

# I.st phase in dental lab

- Pouring the impressions
- Plaster /mix of plaster and stone
- Modelling of the temporary of the wax (pink modelling wax)
- Putting of the wax pattern into the flask
- Replacement the wax with resin dough
- Polymerization



# II.nd phase in dental office

- Cementation using the temporary cement

# Direct fabrication of the temporary crown or bridge

- Impression before the preparation
- Preparation
- Mixing of the special resin
- Filling of the impression
- Application on prepared teeth – the temporary is being formed
- Finishing and polishing
- Cementation using the temporary cement