

Introduction to Psychiatry

Tomáš Kašpárek

Contents

- Background – synthesis of biological sciences and the humanities
- Norm
- Etiology of mental disorders
 - > Biological models
 - > Psychological models
 - > Interaction of biological factors and the environment
- Pathophysiology of mental disorders

Biology and the humanities

Norm

- Personal
 - > Subjective ego-dystonic experience
 - > Significant change in habitual experience and behaviour
 - Does not need to be realised – loss of Insight
- Cultural
 - > Conformist and non-conformist behaviour
 - Usual behaviour and experiencing corresponding to the culture and individual's position within it
 - Non-conformity is not, by definition, a sign of psychopathology
- Typical clinical pictures = overt signs of mental illness
 - > Hallucinations, catatonia...
- Always search for the reason of behaviour: “Why”?

Etiology of mental disorders

- ◉ Heredity and genetic factors
- ◉ Effects of the environment
- ◉ The diathesis-stress model
 - > vulnerability-specific provoking factor

The stress hypothesis

- Weiner (1950s)
 - > stress = non-specific factors leading to a stress response
→ **disease**
 - opposes the original specificity theory (specific intrapsychic conflict leads to a specific disease)
- Selye: psychosocial stressors have the same impact on an organism as biological stressors
- Life events (LE) theory
 - > table of LEs with corresponding scores (death of a close person 100, divorce 73, marriage 50...)
 - final score of 350/year = a high risk of ment. psychosom. illness
- Stages of stress
 - > alarm: preparation for fight/flight
 - > resistance: the organism prepares for survival under unfavourable conditions
 - > exhaustion: collapse of regulatory mechanisms
- The importance of coping = strategies to cope with stressors and stress!

Levels of abstraction, psychopathology and imaging

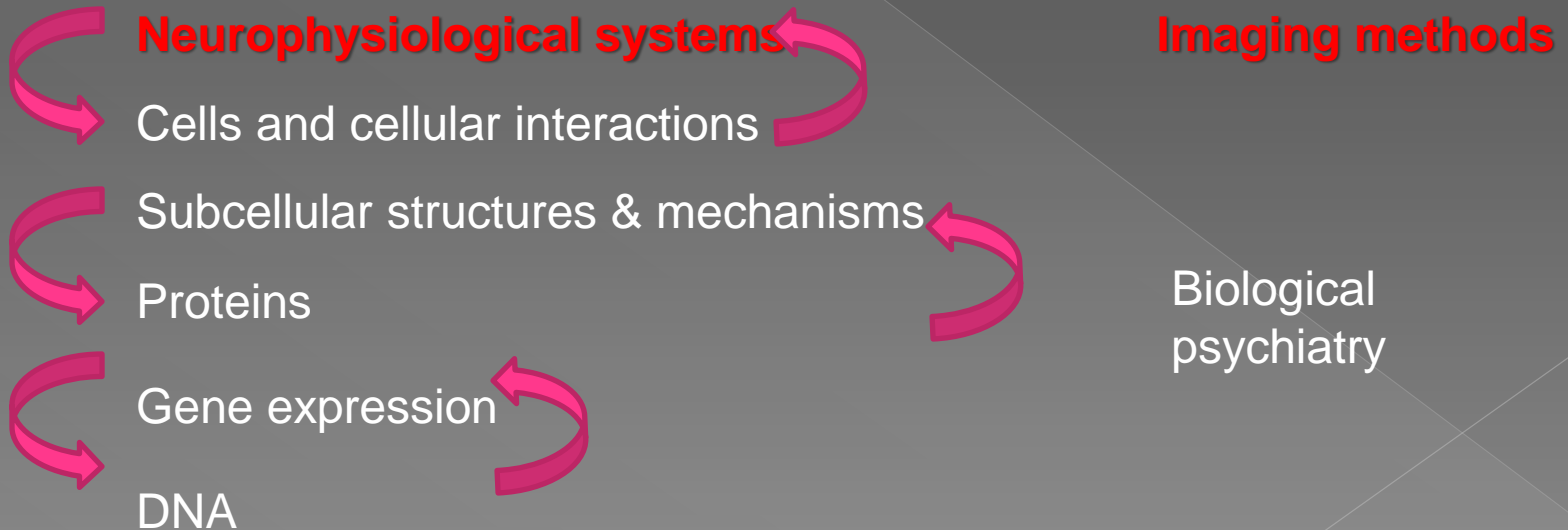
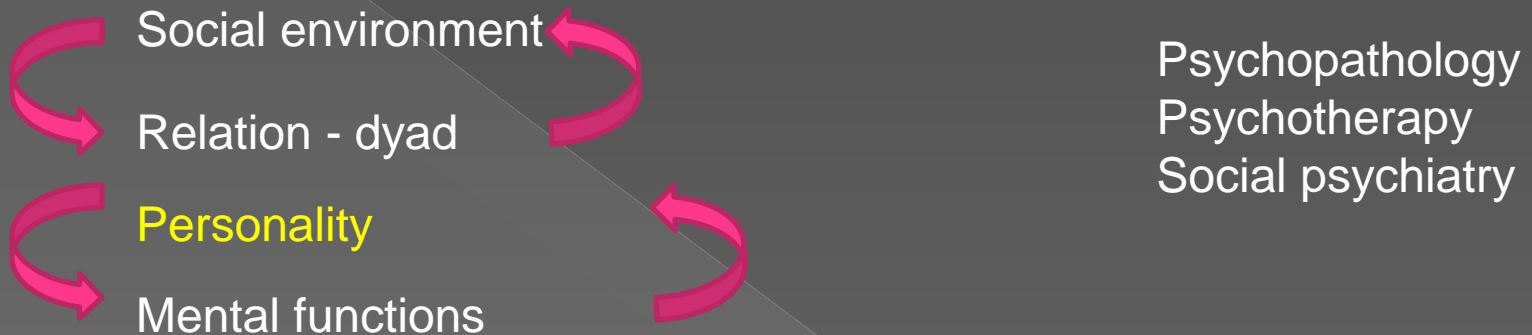

Biopsychosocial model

- End of 20th century
- Systems theory (G. Bateson, L. von Bertalanffy)
 - > each phenomenon constitutes a system composed of subsystems, and is itself a subsystem of higher-level phenomena
 - > change in a subsystem leads to changes in the other levels
 - > causality is often non-linear, circular: the result of adaptation acts on the cause which changes and leads to further changes to the system
 - > genes – neurons – neuronal networks – neurophysiological systems – CNS – psyche – dyad (pair) – family – social environment
- In psychosomatics appl. by Engel, Lipowski: BIOPSYCHOSOCIAL model

Pathogenetic models

Pathogenetic mechanisms of SCH

- ◎ Neurodevelopmental disorder
 - > the two-hit hypothesis
 - > impairment of late neurodevelopmental processes
 - plasticity, synaptic pruning
- ◎ Neurodegeneration
 - > Progression of morphological changes in some patients
 - > Effect of antipsychotics – positive/negative?

Pathophysiology of mental disorders

- Biological models
- Psychological models
- Interaction of biological and psychological models

Biological models

- Example of the development of the view on the etiopathogenesis of schizophrenia

Neuropathology of schizophrenia

▼ End of the 19th century

- Schizophrenia is the manifestation of a specific brain pathology (like dementia)
- Disillusion - Schizophrenia as a graveyard for neuropathologists
 - the reported findings are not systematically associated with schizophrenia – sign of comorbidity

▼ Schizophrenia = a functional disorder

▼ i.e., imbalance in transmitter systems

Dopamine in schizophrenia

- The dopamine theory
 - > Since the 1960s the dominant theory of schizophrenia
 - > **D2R** blockade is the main mechanism of action of antipsychotics (APs)
 - Crucial work – **chlorpromazine enhances the turnover of catecholamines** (DA, NA): Carlsson 1963
 - There is a **relation between binding to DA-R** and the clinically used dose of **different APs**: Seeman 1976
 - > **DA-mimetics** aggravate/induce **psychosis**
 - > Assumption of **DA hyperfunction** in SCH
 - **Direct evidence missing for a long time!**

1. CT and the neurobiology of schizophrenia

- In 1976, the first CT study in schizophrenia (Johnston et al.)
 - > **ventriculomegaly** found in chronic patients
 - > replicated in a group of patients not treated with APs
- = **schizophrenia is not only a functional disorder!**
- = neuropathology of a disease that is not an artifact of Th!
- = revived interest in the neuropathology of mental diseases

Neuropathology II – since 1990

▼ Key features

- absence of gliosis = this is not a toxic, neurodegenerative process
 - types of neurodegeneration not inducing gliosis?
 - recently, evidence of reduced function of oligodendrocytes, astroglia (trophic function, MTBL Glu, myelination...)
- no numerical atrophy of neurons (cortex)

Cortical (DLPFC) neuropathology

- ▼ Cortical thickness reduction
 - primarily IInd, IIIrd layer
 - not based on the decrease in neurons!
 - reflection of increased PN density
 - reduced size of cell bodies
 - reduction in the size of the dendritic tree, “neuropile”
- ▼ Changes in GABA-ergic cells (PV, CCK)
 - no numerical atrophy
 - reduction in Ca-binding proteins thanks to which they are detected = more IC Ca = higher excitability
 - perhaps adaptation to the reduction in postsynaptic GABA-R at PN axon initial segments (cartridges, $\alpha 2$ -subunit)

Causes of neuropile reduction

- Reduction of afferentation = pre-synaptic changes
- Postsynaptic changes
 - e.g. R disorders with inadequate formation of synapses and loss of connection - spines
- Inability of PNs to support the dendritic tree
 - disorders of the cytoskeleton, metabolism...
- Toxic influences, glucocorticoids ~ stress
- Inactivity/activity = abundance of stimuli
- Disorders of “dendritic apoptosis”
 - mechanism of neuroplasticity, formation of memory = reconstruction of dendrites and synapses
 - may be the basis for the progression of morphol. changes (MRI)

Dysfunction of cortical microcircuits

- PV-GABA interneurony innervate several neighbouring PNs
 - coordination, “synchronization” of activity
 - function critical for the work of PNs in the gamma range, their manifestation: EEG gamma oscillation (= defective in schizophrenia)
 - CCK cells connected with theta frequency (relation to working memory – increases with increased task difficulty)
- Dendritic spines of PNs of IInd, IIIrd layer = the target of excitatory cortico-cortical and thalamo-cortical connections
 - Glutamate! – reduction of spines ~ reduction of Glu-R, Glu transmission
- PNs send collaterals to GABA bb.
 - impairments of Glu-transmission ~ dysfunction of GABA bb.
- = difficult to determine what is the cause and what is compensation: schizophrenia is a manifestation of a disorder of cortical microcircuits that can occur due to a change of any component of the circuit

Cortical microcircuit dysfunction

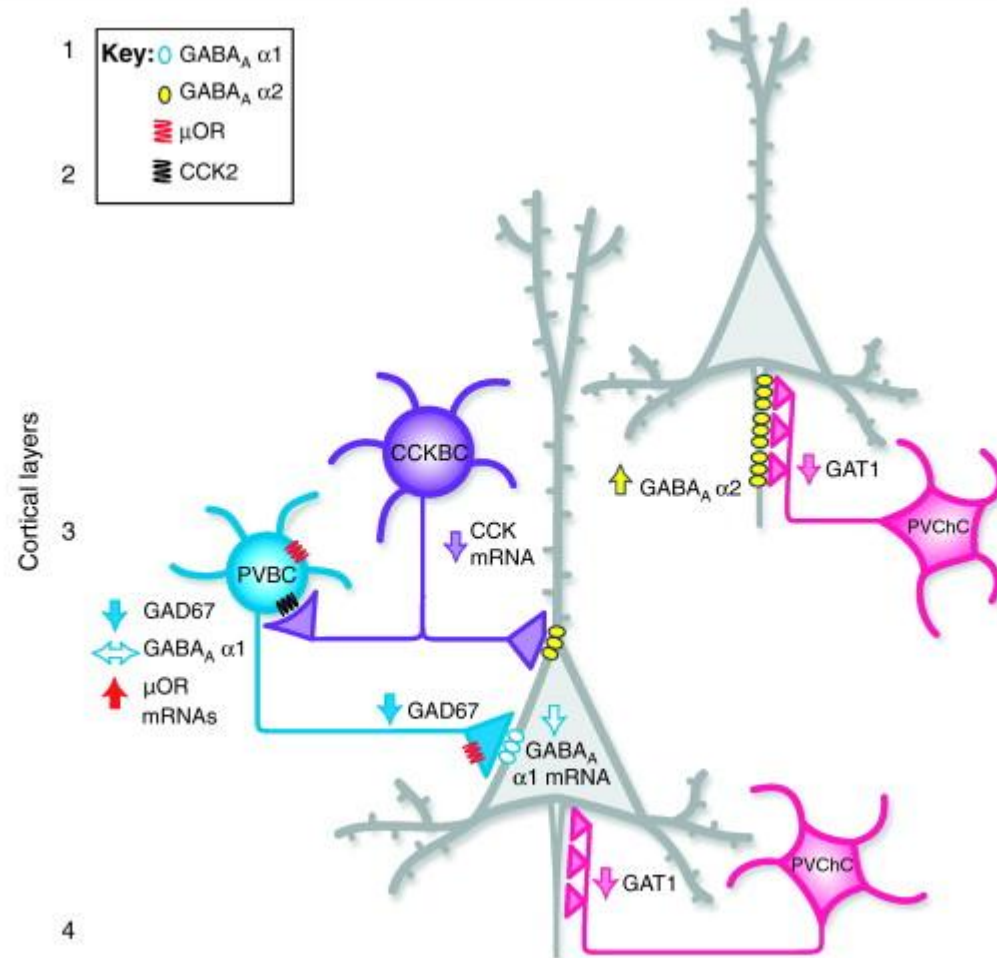

Cortical grey matter reduction

- Variable picture
- Most consistent in
 - > PF cortex
 - > STG
 - > Hippocampus
- Individual studies, however, find changes in the entire brain

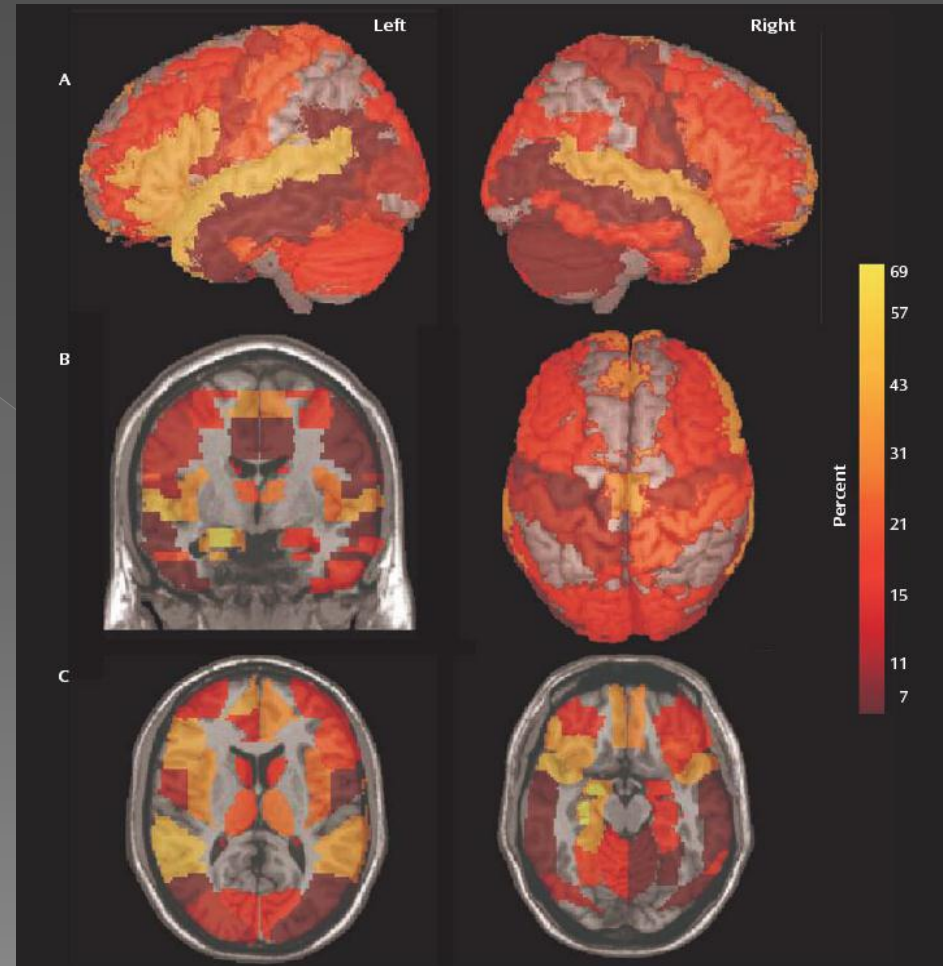

Changes in white matter integrity

Integrity of WM tracts

- Impairment of integrity of white matter tracts
 - > Hemispheric connections:
 - the corpus callosum
 - > Cortico-cortical connections
 - the fornix
 - the cingulum
 - f. uncinatus
 - f. arcuatus
 - f. longit. sup., inf.
 - f. O-F inf.
 - > Cortico-subcortical connections
 - the anterior limb of the internal capsule, anterior thalamic radiation

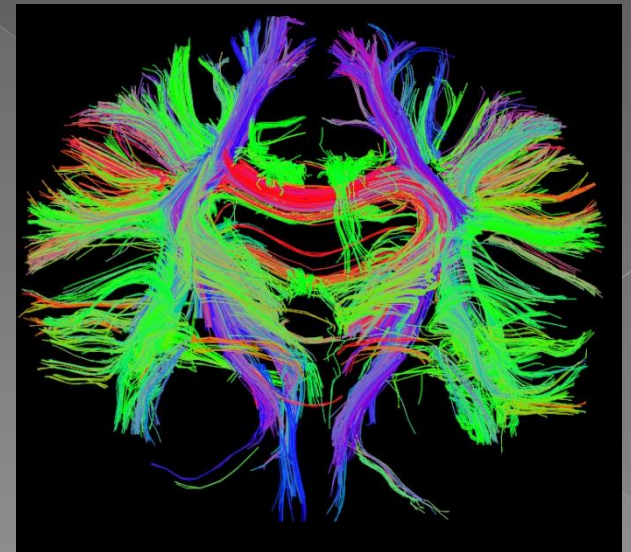
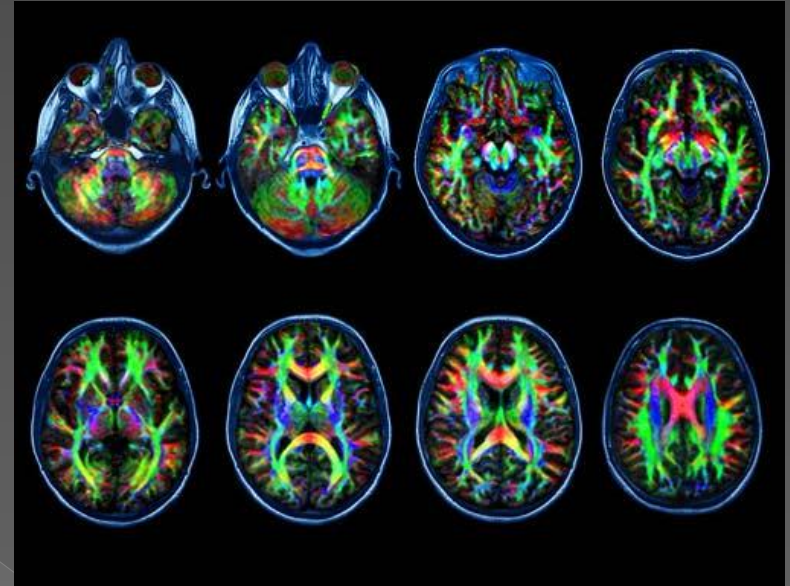

Tractography of SCP and CST in SCH

- SCP = the main efferent tract of CRBL
- Cognitive dysmetria?
- Abnormal SCP integrity only in patients with impaired movement sequencing

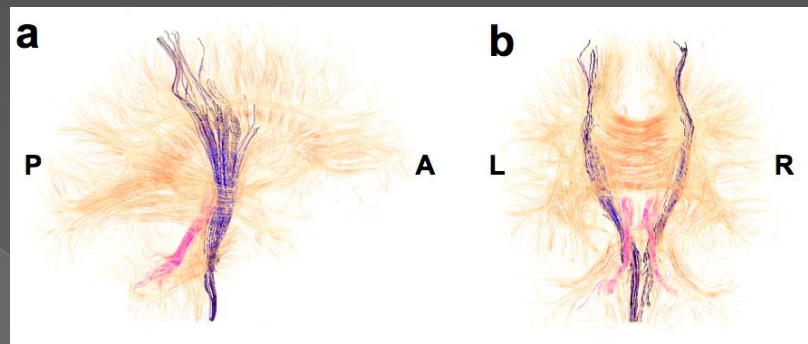
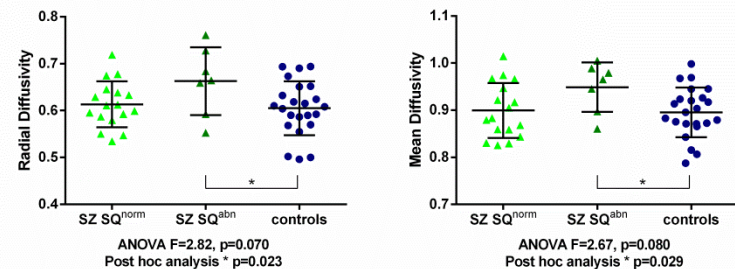

Fig.5 Effect of movement sequencing abnormalities-SCP left hemisphere



Global organization - connectome

- “Small-world” features maintained, i.e., physiological organization of the brain
- Less frequent interconnection of the individual CNS network nodes
 - > mainly medF, P, O, L-T
- Up to 20% reduction in network effectiveness (path length inversion)

Zalesky et al., 2011

- Loosening of the relation (spatial correlation of networks) between anatomical and functional organization

Skudlarski et al., Biol Psychiatry in press

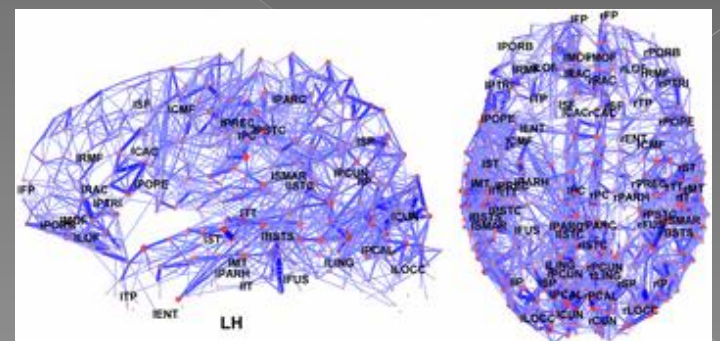
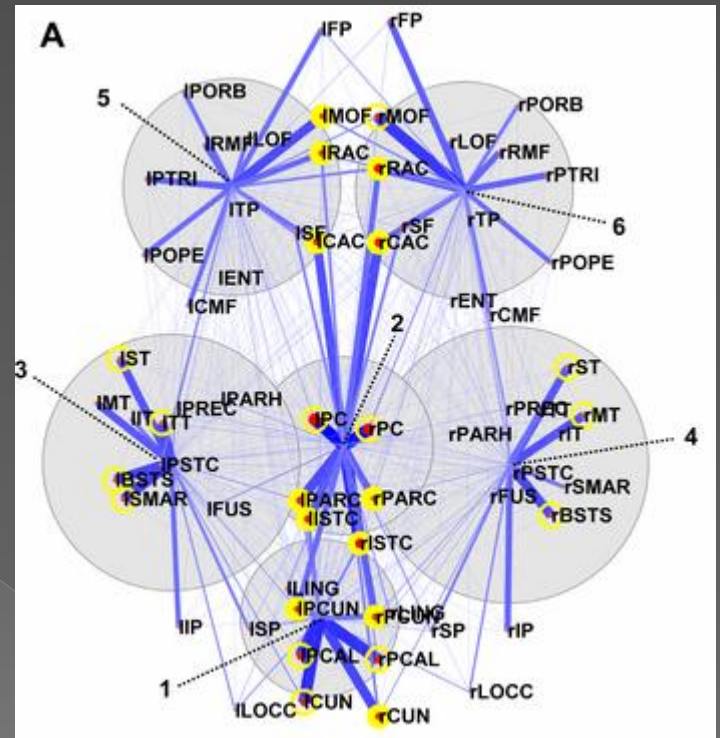

Functional consequences of neuropathology

Abnormal integration

- functional and effective connectivity
 - > similarity of the signal in different areas = cooperation
 - > impaired in schizophrenia – insufficient cooperation of CNS functional networks
 - F-T: disconnection (Friston and Frith 1995)
 - C-T-CRBL-C: cognitive dysmetria (Andreasen et al., 1998)
- EEG gamma range
 - > EEG fast oscillations (30-80 Hz)
 - > Integration of segregated representations of the whole: gestalt
 - > Abnormalities in schizophrenia
 - increase in acute psychosis
 - Reduction in negative symptoms (review Kašpárek and Riečanský 2009)

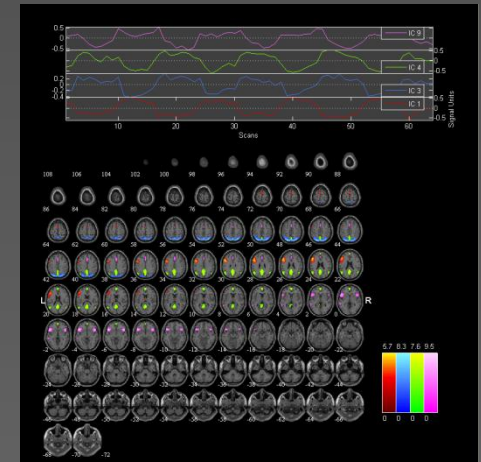

Kaspárek et al., HBM 2013

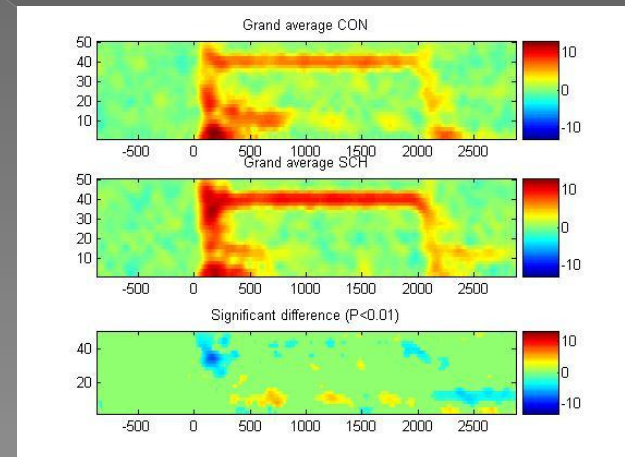

Riečanský et al., SHRES 2010

Abnormal coordination

- Corollary discharge: a copy of the motor plan that will be implemented is sent to the sensory cortex (“efference copy”) in order for the ensuing perception pattern to be recognized as one resulting from a self-generated action
 - > we are not able to tickle ourselves...
- Absence of the “efference copy” in the sensory cortex = perception of exogenous origin
- Schizophrenia: impairment
 - > inner voice = hallucinations

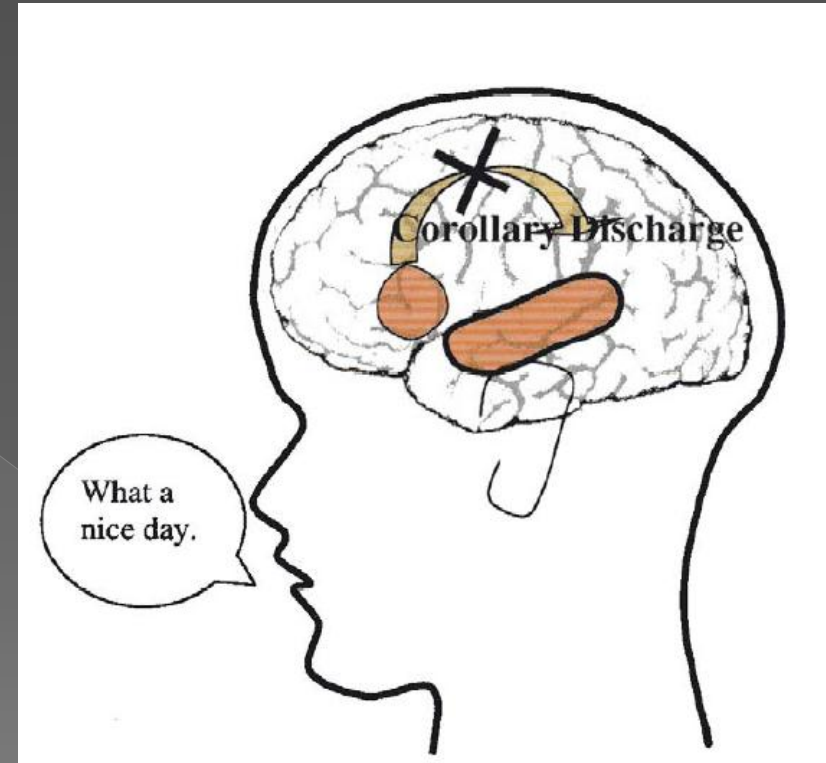

Abnormal autonomy

- Auditory hallucinations associated with the activation of T-P and F cortex
 - > hyperexcitation in case of insufficient regulatory mechanisms?
 - > activation during inner speech and dysfunctional corollary discharge?

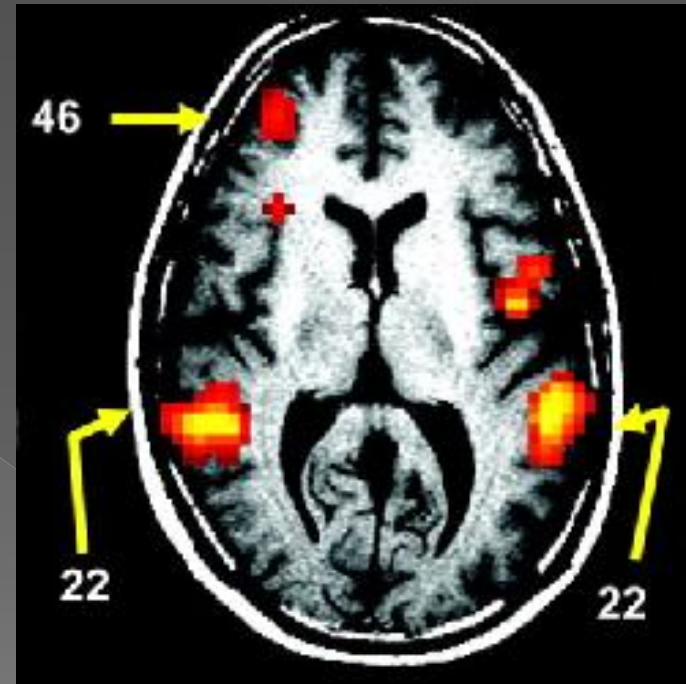

Hoffman et al., 2007

Abnormal regulation

Dysregulation of the dopamine
system in schizophrenia

The DA system as imaged by PET – the striatum

- Postsynaptic characteristics
 - > Increased D2R density (12%), i.e., **incr. D2R**
 - > No changes in D1R density
- Pre-synaptic characteristics
 - > Increased DOPA accumulation – **incr. DA synth.**
 - > No changes in DAT, i.e. the number of pre-synaptic terminals
 - Changes in DA transmission are due to a **functional disorder**, not by a higher number of DA inputs
- **Increase in DA activity** (v.s. phasic)
 - Higher D2R availability after DA depletion, i.e., a higher number of D2Rs occupied by dopamine
- **Increased DA response to amphetamine**

Basal DA pathology in SCH

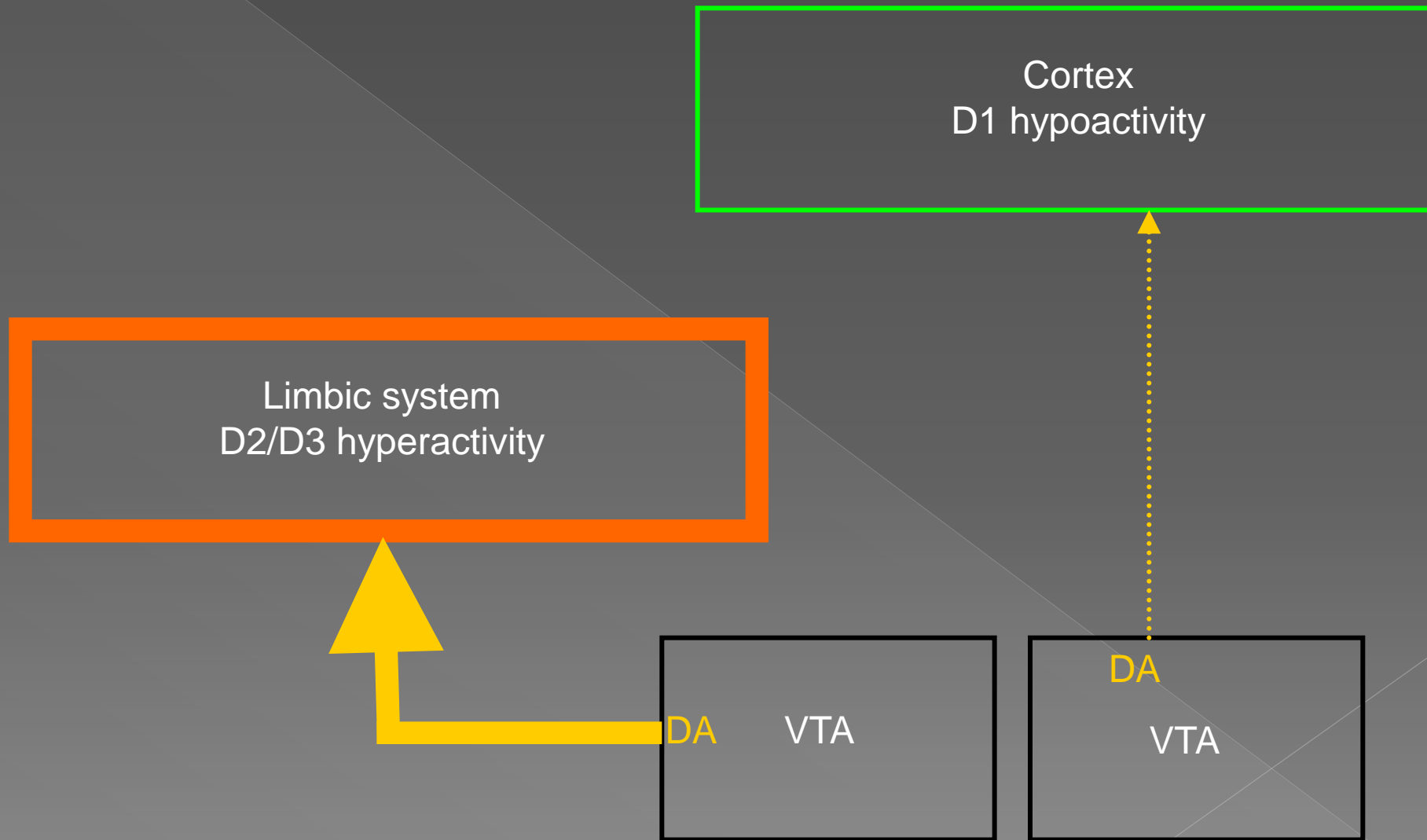

DA system regulation

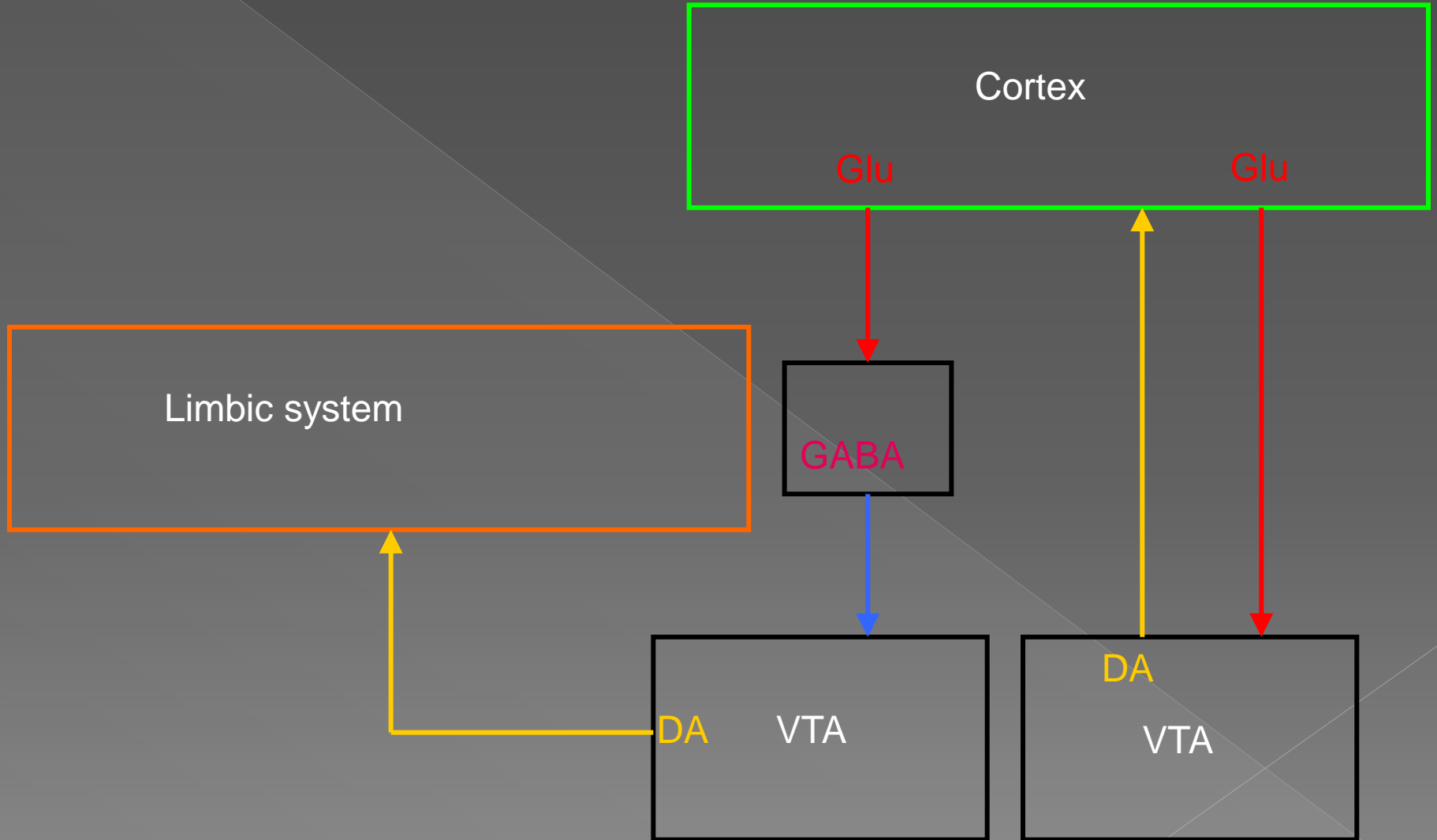

SCH – DA system dysregulation

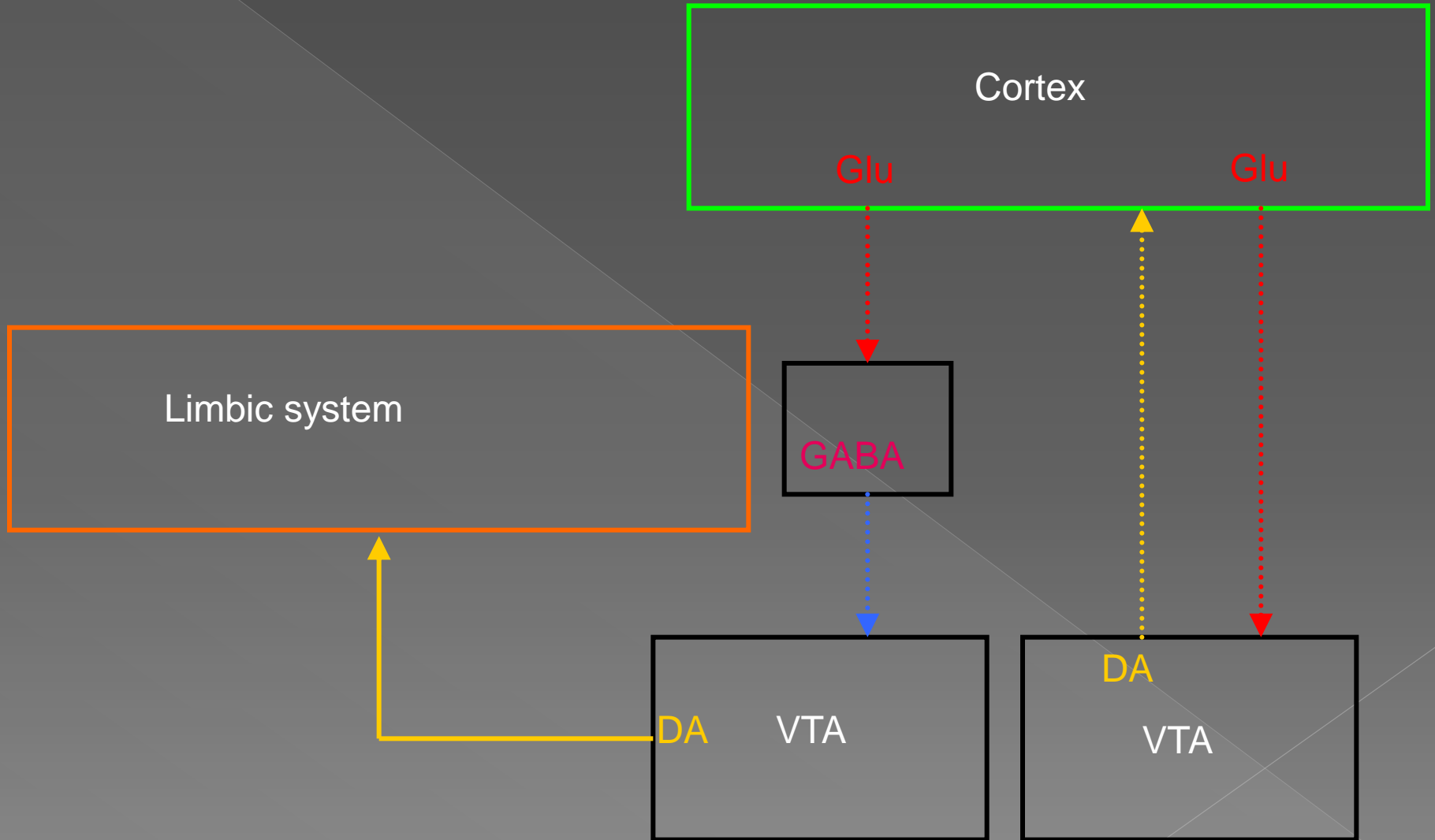

Why does psychosis develop?

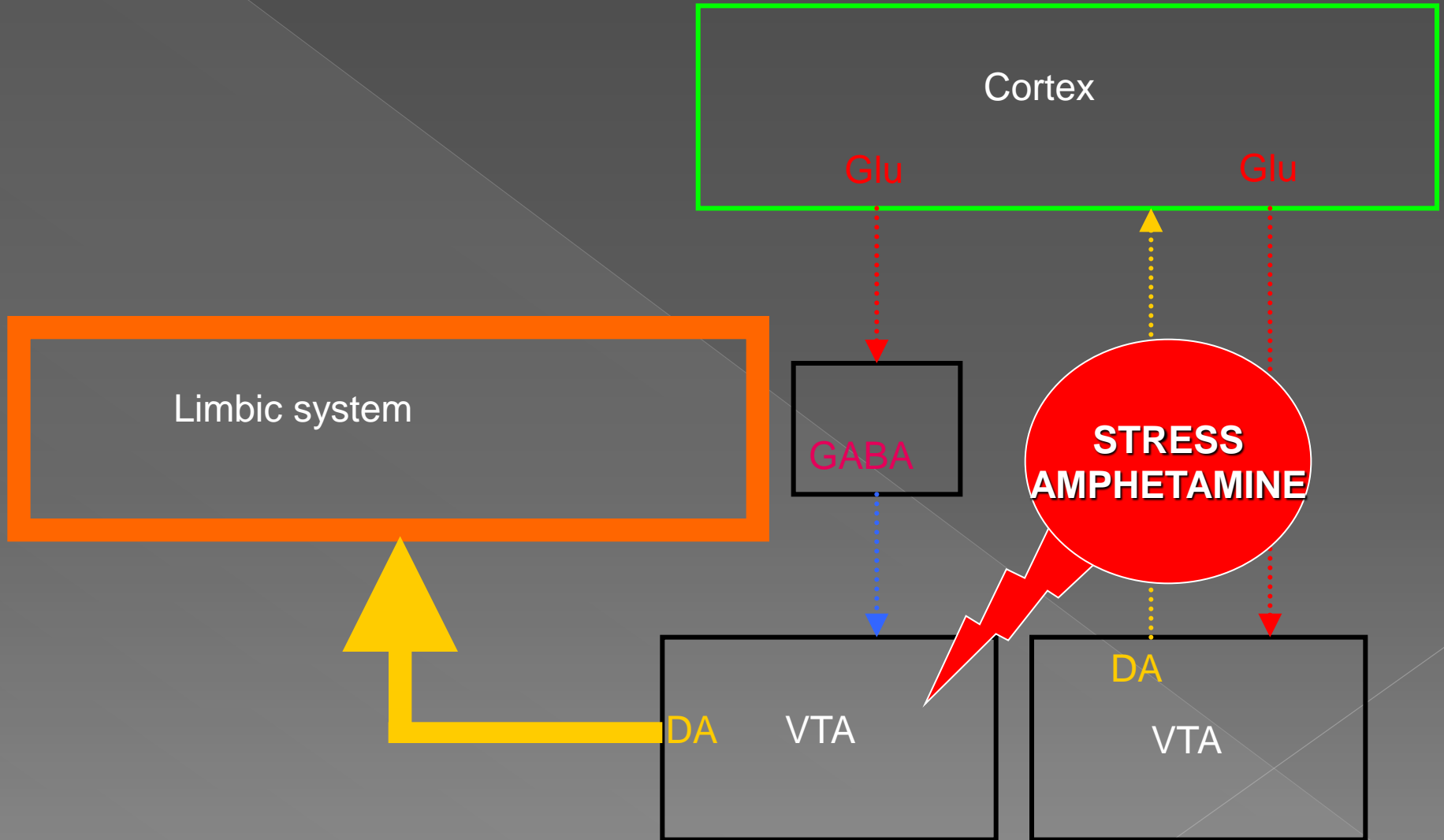

Mesolimbic DA hyperactivity = psychosis

- ◉ Mesolimbic DA system signalizes the importance (saliance) of a stimulus
 - > i.e., which perceptions, thoughts... are important and which of them are not; **which ones deserve attention** (“attribution of salience“)
- ◉ Dysregulation in SCH – **inadequate attribution of importance** to neutral stimuli
 - > Delusions = explanation of abnormal significance
 - > Hallucinations = abnormal meaning of inner representations, i.e., substitution for external perceptions

D2R blockade = an antipsychotic?

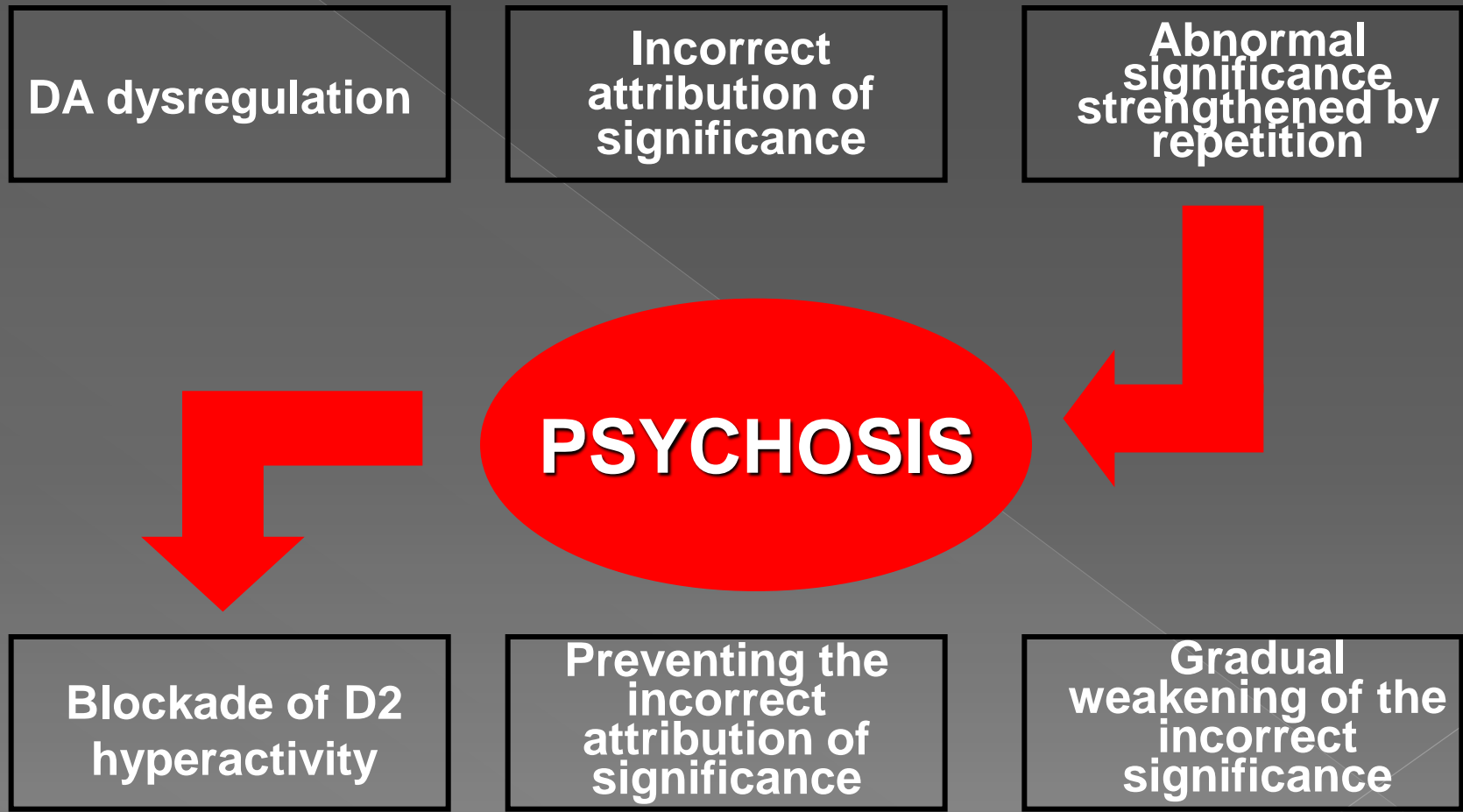

Hysteria



- “Woman under Hysteria”, D.M. Bourneville and P. Régnaud 1876-1880 (source: Wikipedia)



- Charcot demonstrating hypnosis on a “hysterical” female patient (Blanche) during a seminar at the Salpêtrière Hospital (source Wikipedia)

Psychological models

- Dissociation theory (Janet)
 - > in traumatic situations, predisposed individuals experience a narrowing of their attention
 - some sensory channels beyond attention, processed as “non-conscious”
 - sensory loss in dissociative disorders
 - inability to process certain memories which are then interpreted as perceptions
- Conversion (Breuer and Freud)
 - > Unbearable negative affect of a traumatic situation/memory suppressed
 - does not enter consciousness and manifests only as a physical symptom
- Somatization (originally in psychoanalysis – similarity to conversion)
 - > Lipowski: tendency to experience mental discomfort through somatic symptoms
 - increased attention to physical feelings
 - somatosensory amplification (intensified perception of bodily sensations)
 - attribution of common feelings to illness
 - fear of disease
 - catastrophic expectations
 - > causes
 - illness of parents, mainly father
 - cruel treatment, abuse, neglect
 - bad relationship with parents/between parents
 - theory of attachment (Bowlby): insecure and anxious attachment to the mother
- Alexithymia

Hysteria – conversion – psychogenic disorder

● Hysteria

- > chameleon, proteus...
- > variable (time, symptom pattern) expression of motor, sensory, cognitive or emotional symptoms
 - deficiencies and hyperfunctions / qualitative changes
- > uncontrollable, involuntary symptoms
- > associated with emotional distress/discomfort
 - here and now/ then and there
- > communicational significance
 - the image of illness and its cultural significance – indirect communication of distress, attraction of attention...

● Mechanism?

- > automatic processes
- > a neurophysiological mechanism which generates symptoms?
 - temporary oedema of cortical regions involved in motor activity control (Charcot)
 - active inhibition???
- > hint from neuroimaging – a case report (Kanaan et al., 2007)

Kanaan et al., 2007

Imaging repressed memories

- 37-year-old female patient with conversion paralysis
- premature birth with normal development
- brought up in a dysfunctional family and from the age of 4 in several children's homes, reports sexual abuse
- problem behaviour in adolescence, self-mutilation, TS
- numerous unqualified jobs
- a sibling of hers had epilepsy
- admitted a month after her daughter's TS and her boyfriend's announcement that he was leaving
 - > "while we talked, something clicked in my head" and she collapsed, did not communicate for several minutes
 - > she woke up with right-sided paresis and anaesthesia
 - negative neurological + imaging examination

Assessment of life events and fMRI

- LEDS structured interview – identification of significant life events and quantification of their severity
 - > signif. events: TS of the patient's daughter, break-up
 - > “pathogenetic event” (clinical significance, relation to development, potential for secondary gain...) – break-up
 - in contrast, subjective assessment not too significant: repression of emotions
- fMRI paradigm
 - > sentences/comments concerning 2 severe events and 1 non-severe life event; untrue statements: forces the patient to recall details of the event
 - > contrasts
 - severe x non-severe event
 - TS of the daughter x break-up of the relationship

Findings

- memory of the break-up vs. TS and a neutral event
 - > higher activation of
 - the amygdala – emotional activation
 - the anterior cingulum (BA 32) – automatic regulation of emotions
 - inferior frontal gyrus (BA46) – cognitive area
 - premotor areas – preparation of the motor plan
 - > higher deactivation of
 - the left motor cortex (BA4) – area corresponding to motor deficit
- The neurophysiological correlate of clinically evident repression of emotions
 - > in contrast to insuff. subj. experiencing of the breakup, high emotional activation and at the same time reduced activity is apparent in the motor cortex in the area responsible for innervation of the region with the deficit
 - > mechanism - ???

Neurobiology and therapeutic goals

Obsessive-compulsive disorder (OCD) and deep brain stimulation (DBS)

Interconnection of psychopathology, pathophysiology
and the targeting of modern therapeutic approaches

Function of the brain in OCD

- PET – FDG uptake at rest (review Menzies et al., 2008)
 - > **Increased** in **OFC, AC, NcCaud, Thal** (but also pre-motor, sensorimotor cortex, PostCing, DLPFC, the insula, PC, OC, CRBL)
- BUT meta-analysis of fMRI studies (Menzies et al., 2008)
 - > **Hyperfunction of** **OFC** (BA 10, 47), **AC** (BA 32), the motor area (BA6), PostCing (BA 30), PreCun (BA7), OC, **NcCaud, Thal**
 - > Hypofunction of **OFC** (BA 47), **AC** (BA 32), Ins, PFC (BA44), NcCaud, Putamen, HIP, CRBL

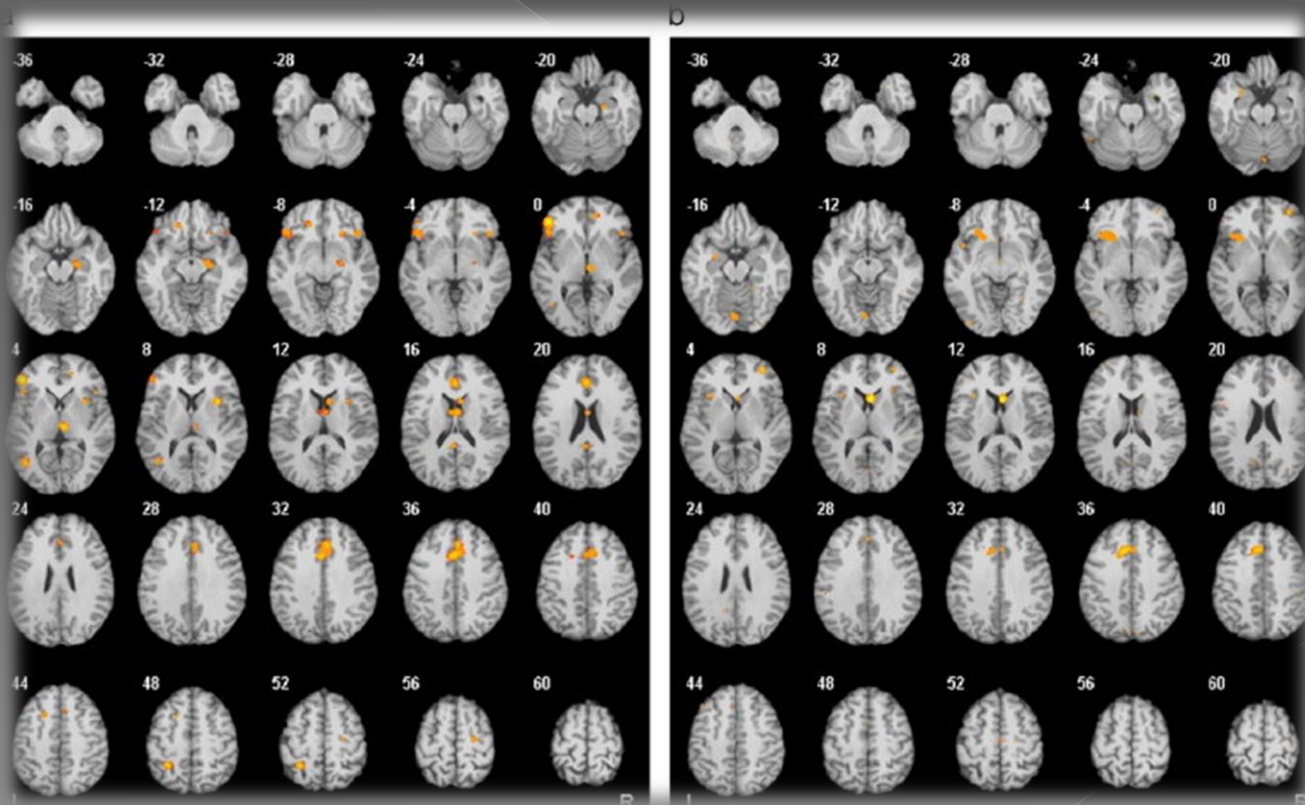

Neural circuits and OCD

FST tract

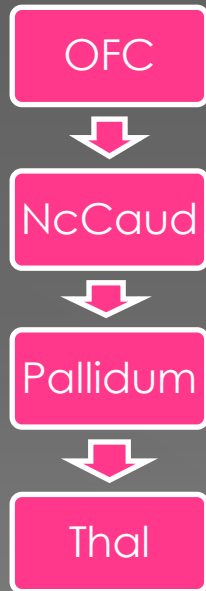

Cortico-Thal. tract

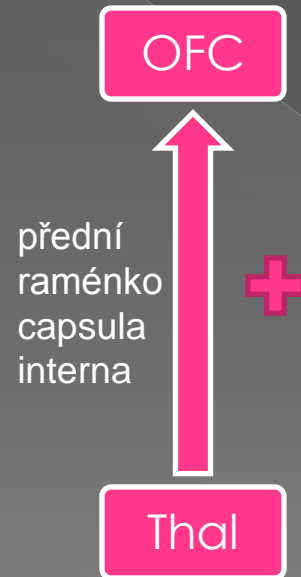

Limbic inputs

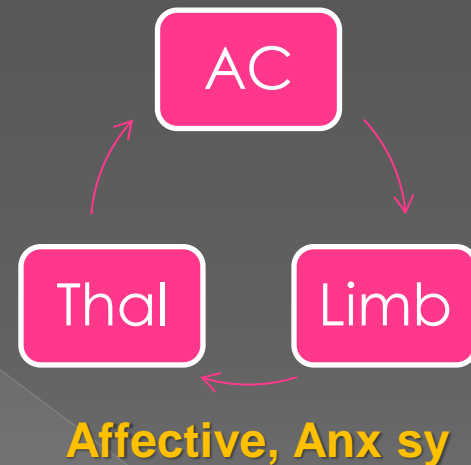

Cognitive circuits (DLPFC, PC...)

Motor circuits

Hyperfunction of OFC = OC sy

- Hyperfn of CT tract
- Hypofn of FST tract

Functional implication

- **OFC hyperactivity**
 - > the OFC encodes the representations of **values** (positive, negative; representations as well as operations)
- cognitive styles (“evaluation”)
 - > inflated perception of **responsibility**
 - > overestimation of **danger**
- Treatment (SSRI, BT) = **decrease in ↑ in the OFC, AC, NcCaud, Thal** (Swedo et al., 1992; Schwartz et al., 1996)
- = **goals of NCH and DBS** in patients resistant to treatment
 - > cingulotomy (anterior)
 - > capsulotomy (anterior limb)
 - > subcaudate tractotomy
 - > limbic leucotomy (cingulotomy + subcaud. tractotomy)
 - > **DBS OCD** = chron. stimulation of ant. limb of int. capsule
 - ca 60% of patients resistant to conventional treatment respond to DBS! (Greenberg et al., 2008)

Interaction of biology and psychology

- Depressive disorder
 - > Early traumatization – sensitivity of HPA axis – sensitivity to subthreshold stress – relapse affective phase

Integrated etiologic model of depression
and anxiety: nature vs. nurture
Stress – diathesis model

Genetic predisposition

- ◉ study of twins – strong support for the involvement of heredity in the etiology of depression
- ◉ non-Mendelian heredity
 - > polygenic heredity
 - > strong impact of the environment

Trauma in early development 1

- CAN, early loss of a parent predispose to the development of depression in adulthood
- animal studies – early separation from the parent animal leads to behavioural disorders in adulthood, equivalent of depressive behaviour

Trauma in early development 2

- CRF changes – supersensitive condition
 - > rats: early trauma leads to a persist. multiplication of CRF neurons with HPA axis hyperactivity (Ladd 1996)
 - > women with the history of CAN both with and without current depression
 - greater ACTH response to stress
 - higher cortisol during stress only in women with depression

Trauma in early development 3

- Changes in the hippocampus related to stress
 - > neurotoxicity – neuronal atrophy
 - > reduced neurogenesis
- Changes in the NA system
 - > locus coeruleus hyperactivity
- Direct connection of the CRF and NA regions with bilateral influence

Stress-diathesis model of D and ANX

- Traumas in childhood (critical developmental phase)
 - > loss of a close person (separation trauma)
 - > physical and mental abuse, neglect
 - > lack of safe family background



- Persisting change in the control of stress reaction
 - > increase in HPA axis activity (hypersensitivity)
 - excessive CRF secretion, relation to changes of glucocorticoid receptors in the hippocampus
 - > sensitivity to stress
 - > impact on neurogenesis and plasticity
 - > changes in the activity of neurotransmitters
 - > development of D, ANX

Genetic Predisposition ↔ Early Adverse Life Events

Vulnerable Phenotype

- HPA axis/CRF system hyperactivity
- NE system hyperactivity
- Impaired neurogenesis in HC
- Neurotoxicity in HC



Vulnerability to Stress
and Life Events

Trauma or
Daily Life
Events in
adulthood

Biological Alterations

Behavioral and Emotional Changes

Interaction of psychology and biology

- Post-traumatic stress disorder
 - > Excessive stress – chron. glucocorticoids – atrophization of regions involved in the representation and control of emotions (hippocampus, mPFC) – affective and cognitive disorders

Functional changes - PTSD

- ◉ AMG hyperactivity
 - > insufficient control of HIP, AntC
 - > correlation with anxious, affective symptoms
- ◉ Increased resting functional connectivity between AMG and INS
 - > excessive arousal even in the absence of the endangering stimulus?
 - > incomplete processing and representation of emotions?
 - impairment of INS activity during anticipation of emotional situations
- ◉ Emotional flattening
 - > dmPFC reduction and decreased experiencing of positive emotions when exposed to emotionally significant texts
 - deficiency of conscious, reflective processing of emotions

Thank you!