

(I.) Red blood cell count. Estimation of haemoglobin concentration. Calculated parameters of red blood cells
(II.) Estimation of blood group by slide method

Physiology I – practicals

Red Blood Cell (RBC) – erythrocyte

- Anucleated cell, the most abundant blood cell
- Shape:
 - Biconcave disc
 - surface increased by 30%
 - spectrin
 - deformation inside the capillaries
- Functions:
 - Transport of oxygen (haemoglobin)
 - Role in acidobasic balance and CO₂ transport
- Size:
 - Normocyte: 7.5 μm
 - Microcyte: ≤ 7 μm
 - Macrocyte: ≥ 9 μm
 - Megalocyte: ≥ 20 μm

Reticulocyte

- Immature RBC
- In peripheral blood: $1\% \pm 0.5\%$ of RBC
 - reticulocytosis: increased ratio of reticulocytes in peripheral blood
- No nucleus, but residues of membrane organelles in cytoplasm (substantia granulo-filamentosa)
- Within 48 hrs. maturation to RBC

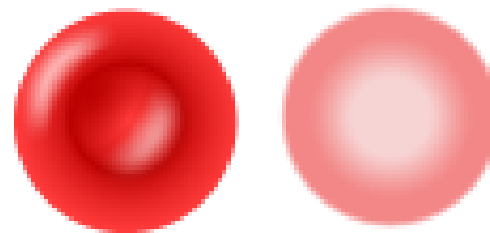
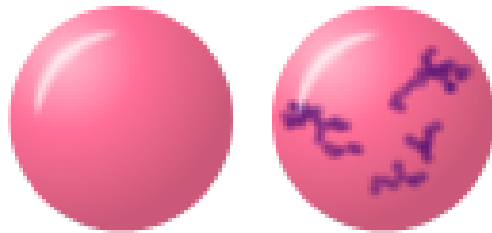

Alteration of shape: poicylocytosis

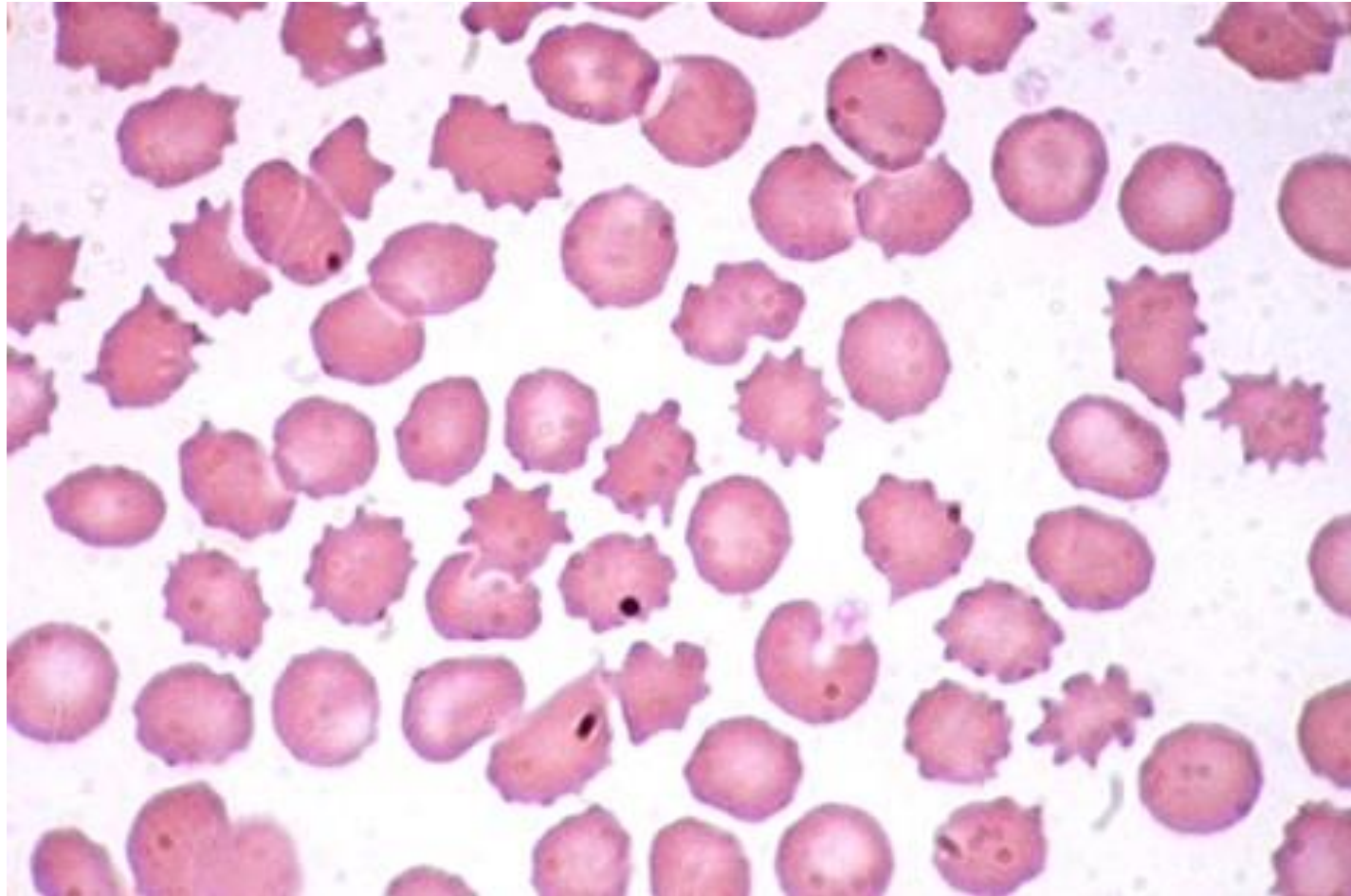

Anisocytosis: varying size of RBCs

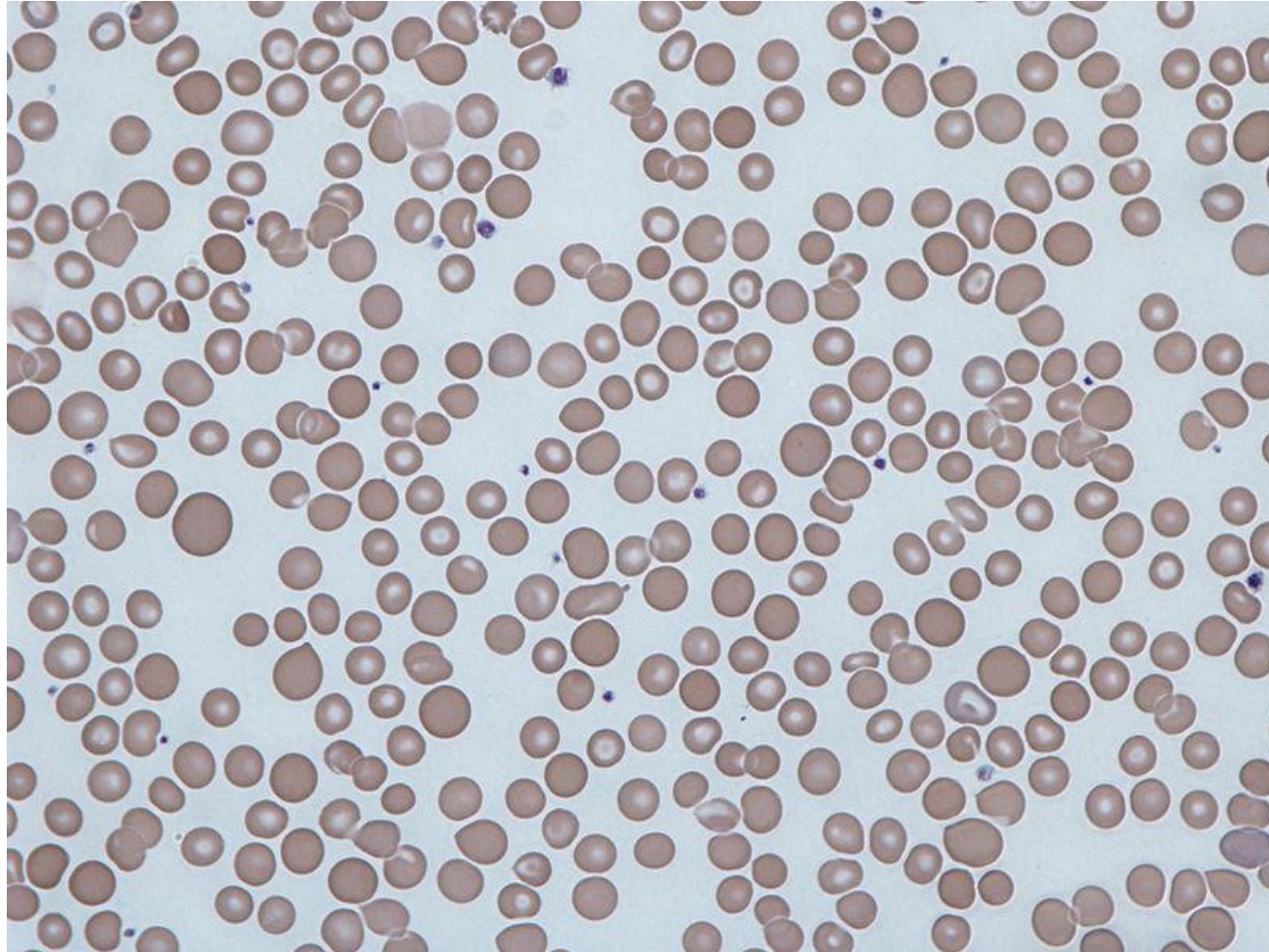

RBC count

- Number of RBC
 - Men: $4.3-5.3 * 10^{12} / l$
 - Women: $3.8-4.8 * 10^{12} / l$
 - Newborns: $4.4-7.0 * 10^{12} / l$
- Intersexual differences:
 - Men: testosterone (male sex hormone) stimulates releasing of erythropoetin
 - Women in fertile period: relative erythrocytopenia due to menstruation

Alterations of RBC count

- polyglobulia – increased number of RBCs
- erythrocytopaenia – decreased number of RBCs

Estimation of RBC count

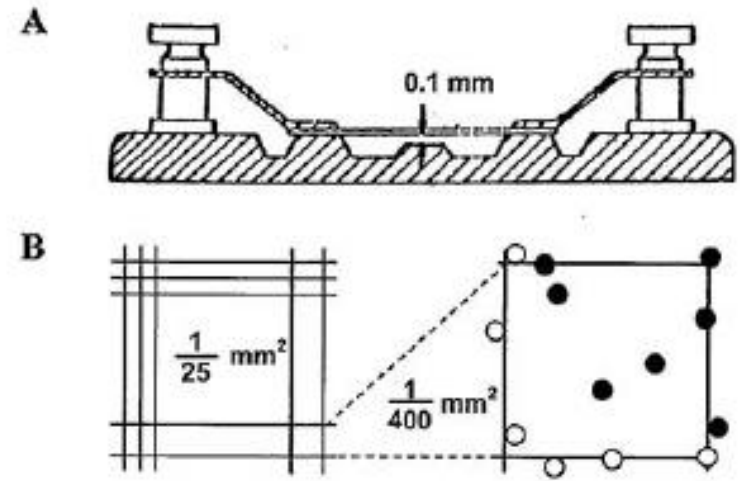

- Automatic methods
- Classical method: Bürker's chamber + Hayem's solution

Haematocrit

- Volume percentage of blood cells in blood sample (erythrocyte volume fraction)
- Centrifugation of **anti-coagulated** blood
 - Plasma
 - Buffy coat
 - RBC
- Hct (hematocrit)
 - Men: 42-52%
 - Women: 37-47%

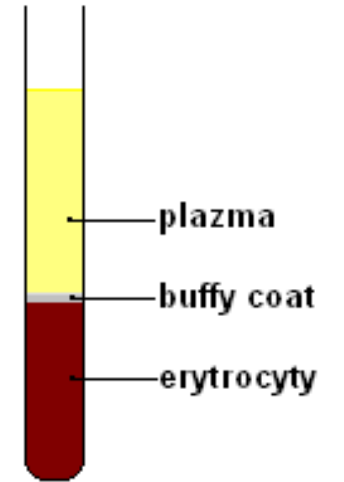

Hemoglobin

- Hemoglobin concentration (HGB)
 - Men: 140-180 g/l
 - Women: 120-160 g/l
 - Newborns: 160-240 g/l

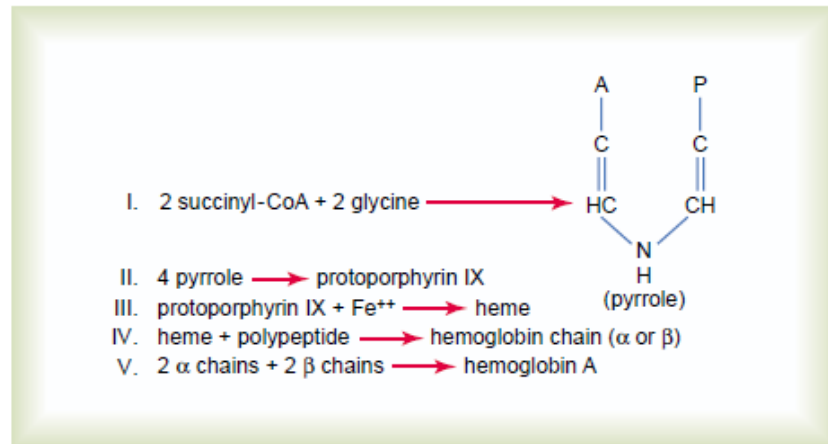

Figure 32-5

Formation of hemoglobin.

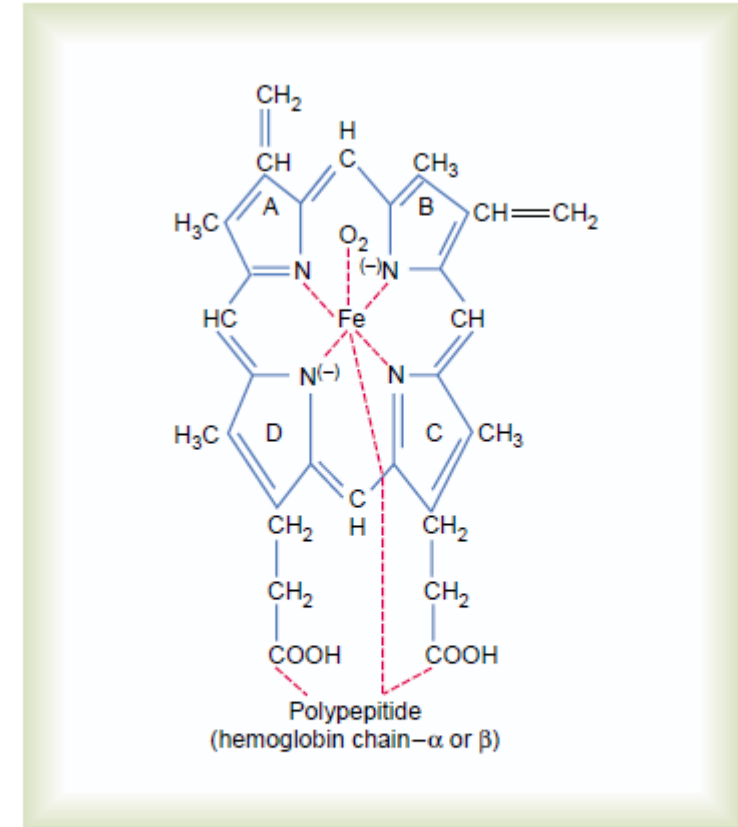

Figure 32-6

Basic structure of the hemoglobin molecule, showing one of the four heme chains that bind together to form the hemoglobin molecule.

Estimation of HGB

- Spectrophotometric method:
 - lysis of RBC by transforming solution + stabilisation of haemoglobin (Hb-cyanide)
 - Measurement of light absorption

Haemoglobin - derivatives

- **Oxyhaemoglobin** – haemoglobin + O₂
- **Carboxyhaemoglobin** – haemoglobin + CO
- **Carbaminohaemoglobin** – haemoglobin + CO₂
- **Methemoglobin** = haemoglobin with oxidized Fe (Fe³⁺)

Calculated parameters of RBCs

- Average volume of RBC (**MCV**, mean corpuscular volume)
 - $MCV = HCT/RBC$ (hematocrit/ red blood count) = 80-95 fl
- Average weight of Hb in RBC (**MCH**, mean corpuscular hemoglobin)
 - $MCH = HGB/RBC$ (haemoglobin/ red blood count) = 28-32 pg
- Average concentration of Hb in RBC (**MCHC**, mean corpuscular hemoglobin concentration)
 - $MCHC = HGB/HCT$ (hemoglobin/ hematokrit) = 310-360 g/l
- Red cell distribution width (**RDW**) = 11,5-14,5%
 - Variation of RBCs size
 - \uparrow RDW – anisocytosis

Calculated parameters of RBCs

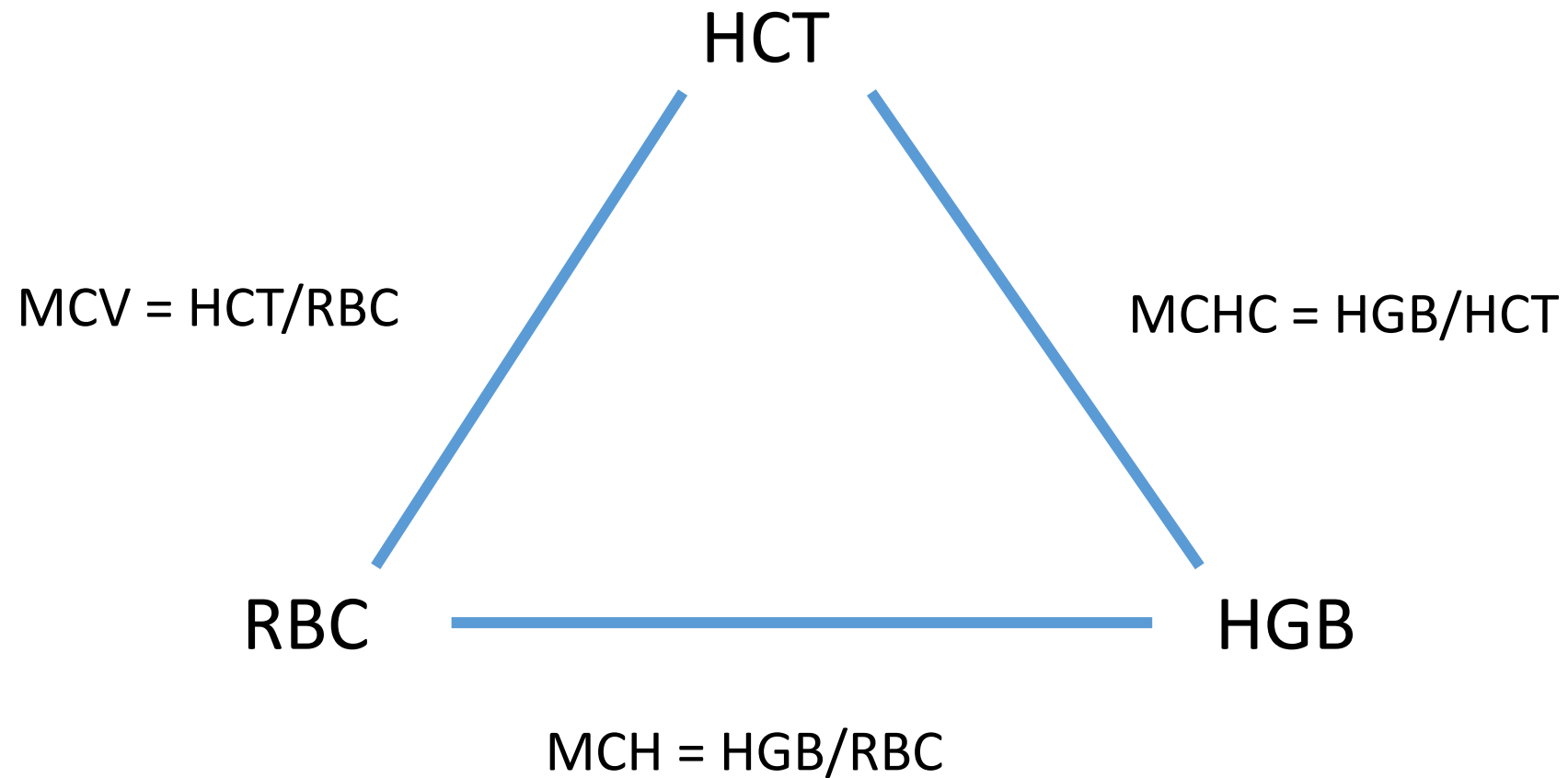

Anaemia

- **Decreased concentration of Hb** in blood
- Symptoms
 - Pale mucose membrane
 - Fatigue
 - Tachycardia
 - Dyspnoe

Sideropenic anaemia

- Deficiency of Fe^{2+} → decreased production of RBCs → hypoxia stimulates releasing of erythropoietin → increased production of RBCs with lack of Hb
- **Microcytic hypochromic anaemia**

Pernicious anaemia

- Deficiency of B₁₂ or folic acid
- **Macrocytic, hyperchromic anaemia**

Krevní skupiny







- Ery na svém povrchu nesou různé antigeny, podle kterých je dělíme do krevních skupin. Tyto krevní znaky se dědí a jsou neměnné během celého života
- Např. systémy: ABO, Rh, MNs (průkaz otcovství), Kell, Lewis

ABO systém

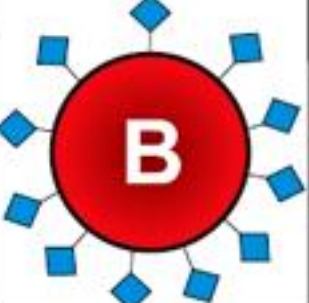
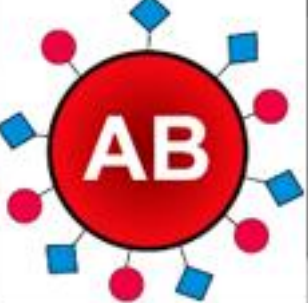
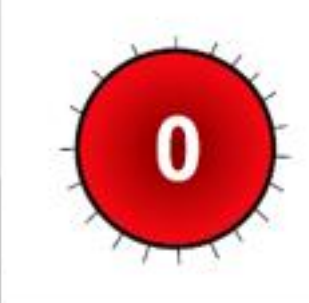
- Aglutinogeny – glykoproteiny:
 - 0 – pouze struktura H, alela ii, 33%
 - A – na strukturu H navázaný N-acetylgalaktosamin, alely AA, Ai, 45%
 - B – na strukturu H navázaná galaktóza, alely BB, Bi, 16%
 - AB – nese antigeny A + B, alela AB, 6%
 - Nevyskytují se jen na erytrocytech.

- Aglutininy – protilátky IgM:
 - 0 – anti-A + anti-B
 - A – anti-B
 - B – anti-A
 - AB – nemá
 - Jejich tvorba je zahájena po příjmu potravy a probíhá po celý život. Nemohou procházet placentární bariérou (kde je přenašeč pouze pro IgG).

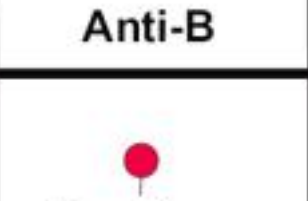
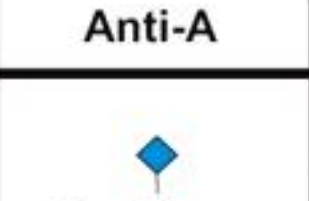
ABO systém

	SKUPINA A	SKUPINA B	SKUPINA AB	SKUPINA 0
erytrocyty				
protilátky	 Anti-B	 Anti-A	žádné	 Anti-A Anti-B
antigeny	 A antigen	 B antigen	 A a B antigeny	žádné

ABO systém: dědičnost

- Alely: A, B, i
- A a B se dědí kodominantně, projeví se obě alely
- alela i je vůči nim recesivní

Určení krevních skupin sklíčkovou metodou

- Sklíčková metoda – na podložní sklíčko kápneme krev a standardní séra skupiny A, B a 0. Dle aglutinace určíme krevní skupinu.

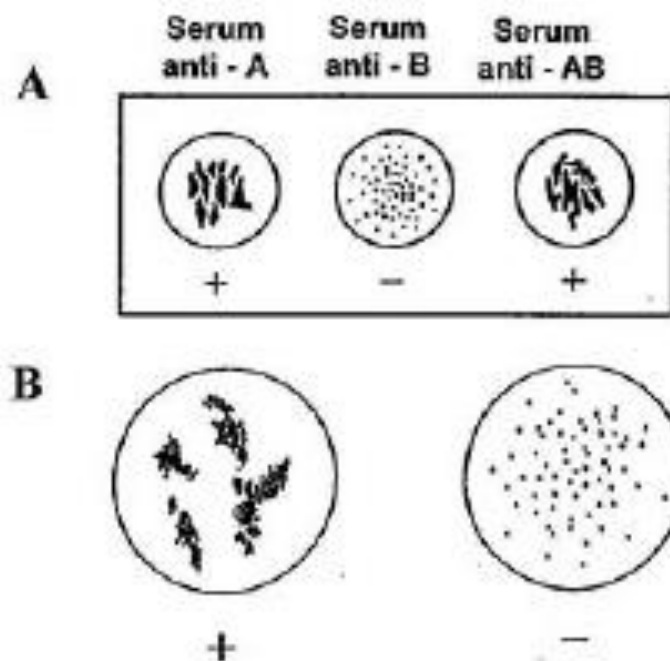

Rh faktor

- Objeven u opice Makak rhesus
- Antigeny C,c,D,d,E,e
 - Je-li přítomno D → Rh⁺, dominantní
 - Rh⁻ jsou recesivní homozygoti
- Protilátky IgG se tvoří až po setkání a antigenem D
 - Procházejí placentou
 - Možnost imunizace:
 - Transfuze inkompatibilní krve
 - Delivery (miscarrige, abortion) Rh⁺ child Rh⁻ mother, u dalšího těhotenství může nastat **fetální erythroblastóza** – dochází k prostupu anti-Rh protilátek placentou a k hemolýze fetálních erythroblastů → hydrops fetalis
 - Prevence: podání anti-Rh séra matce do 2 hodin po porodu

Zdroje obrázků

- Slide 3 - <https://en.wikipedia.org/wiki/Reticulocyte> [cited 30.8.2015]
- Slide 4 - <http://medicaltreasure.com/poikilocytosis/> [cited 30.8.2015]
- Slide 5 - <https://commons.wikimedia.org/wiki/File:Anisocytosis.jpg> [cited 30.8.2015]
- Slide 7, 21 – Praktická cvičení z fyziologie, Masarykova univerzita 2011
- Slide 8 - <http://www.wikiskripta.eu/index.php/Hematokrit> [cited 30.8.2015]
- Slide 9 – Ganong's Review of medical physiology, Ganong, Mc Grow hill, 2010
- Slide 19 - [http://www.wikiskripta.eu/index.php/Soubor:Krevni skupiny.png](http://www.wikiskripta.eu/index.php/Soubor:Krevni_skupiny.png) [cited 30.8.2015]