

Anesthesia Machine, Monitoring

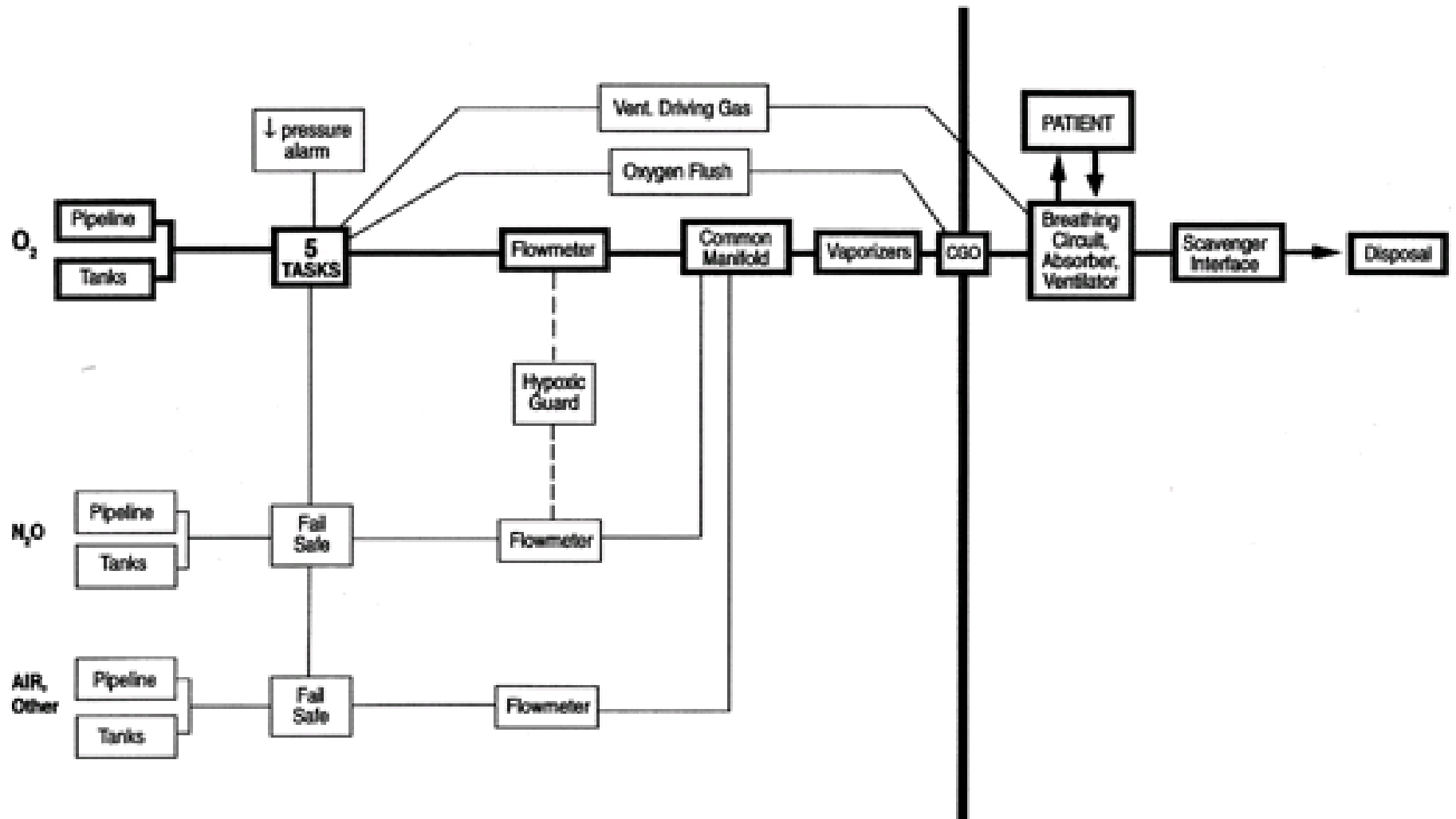

L.Dadák
ARK FNUSA & LF MU

02



Gas – ISO norm

O₂ - white

- fractionally distill liquefied air into its various components, (N₂ distilling as a vapor, oxygen O₂ is left as a liquid.

Stored as compressed gas.

N₂O - blue

- pressure 5 MPa

Air white/gray

CO₂ - gray

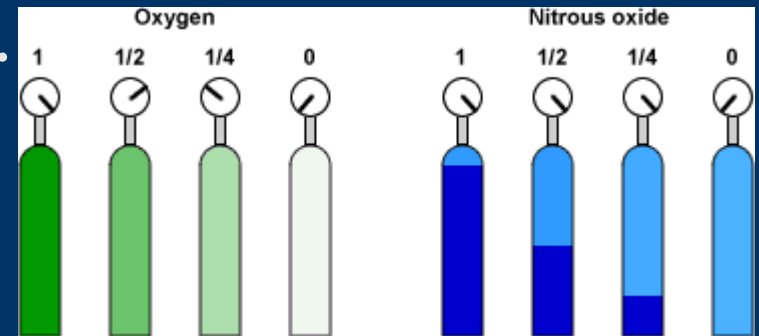

gas

liquid + gas

N₂O

Nitrous oxide production

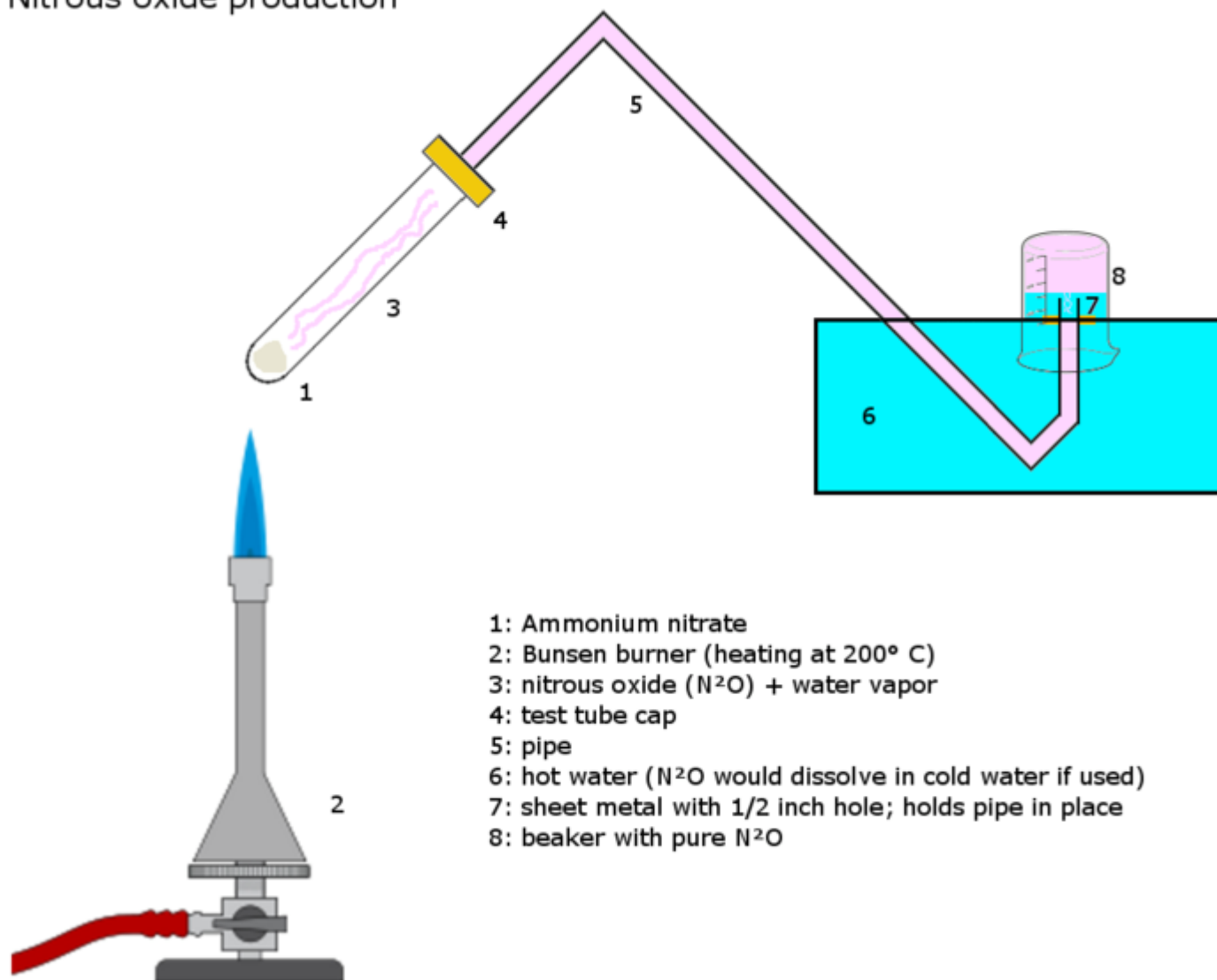

Anesthesia Machine

is able to ventilate the patient by defined mixture of gasses

Parts:

- 1.High pressure system
 - 2.Low pressure system
 - 3.Breathing circuit – in/expiratory part
 - 4.Ventilation systems (manual and mechanical)
 - 5.Scavenging system
-
-

Parts of anesth. machine

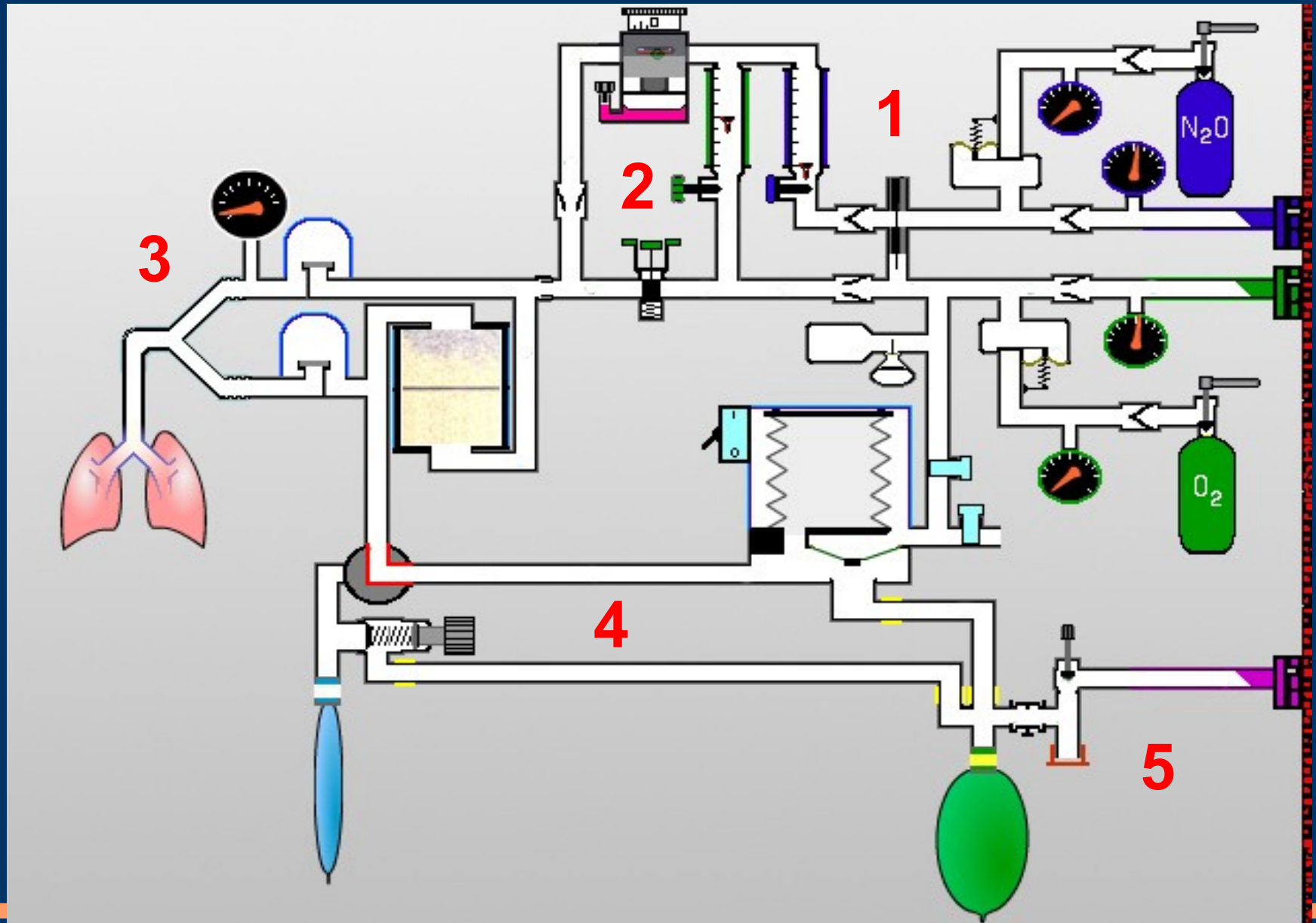

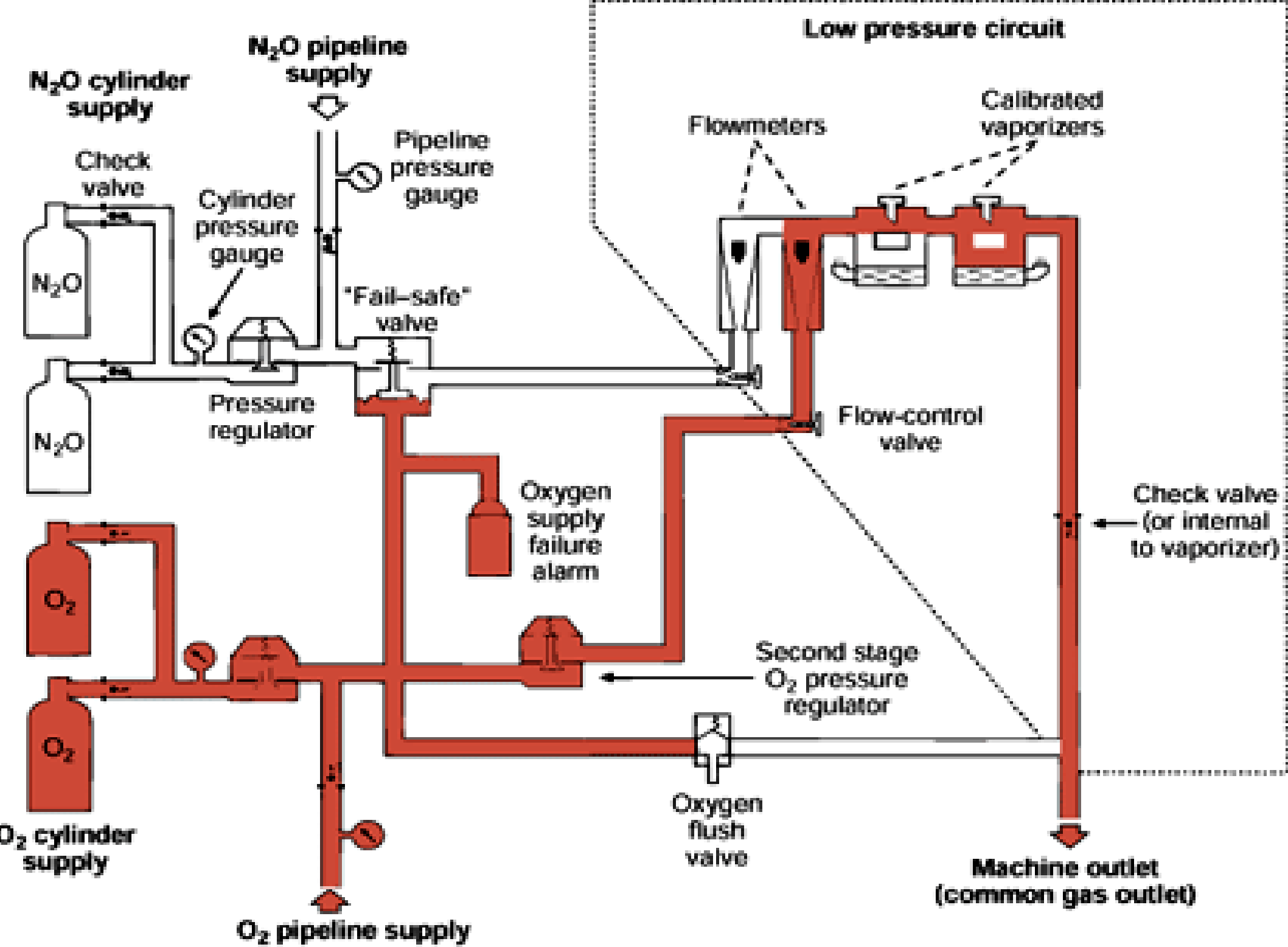

High pressure system

Compressed gas

- Cylinder Supply
- Pipeline Supply
- Oxygen Supply Pressure Failure Safety
 $pO_2 > pN_2O$
- Pressures regulator

- manometr

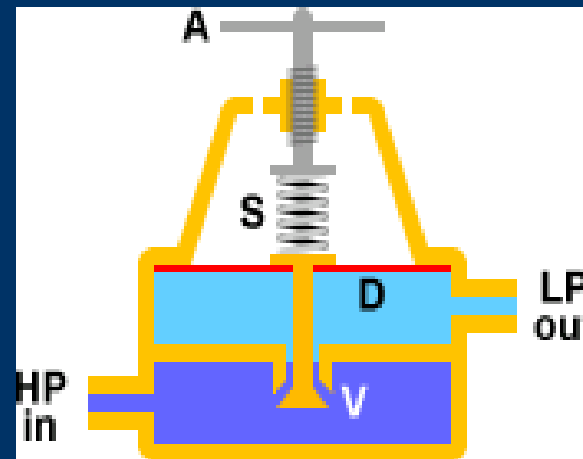

Low pressure system

- flowmeter O₂, AIR, N₂O
- Oxygen flush valve = Bypass,
- Vaporizer
- APL valve

to deliver appropriate concentration, flow

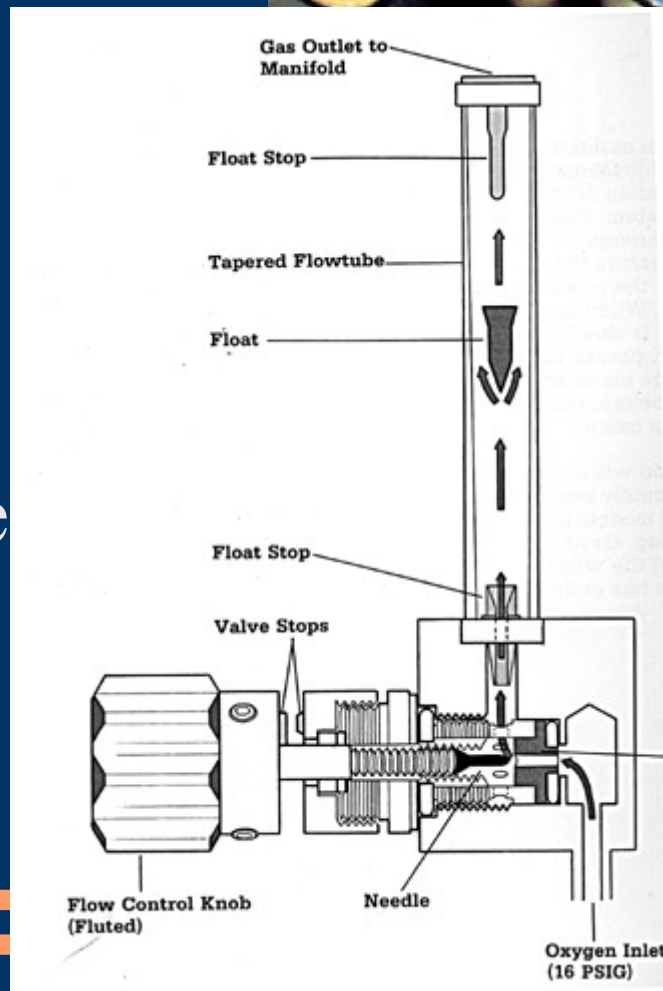
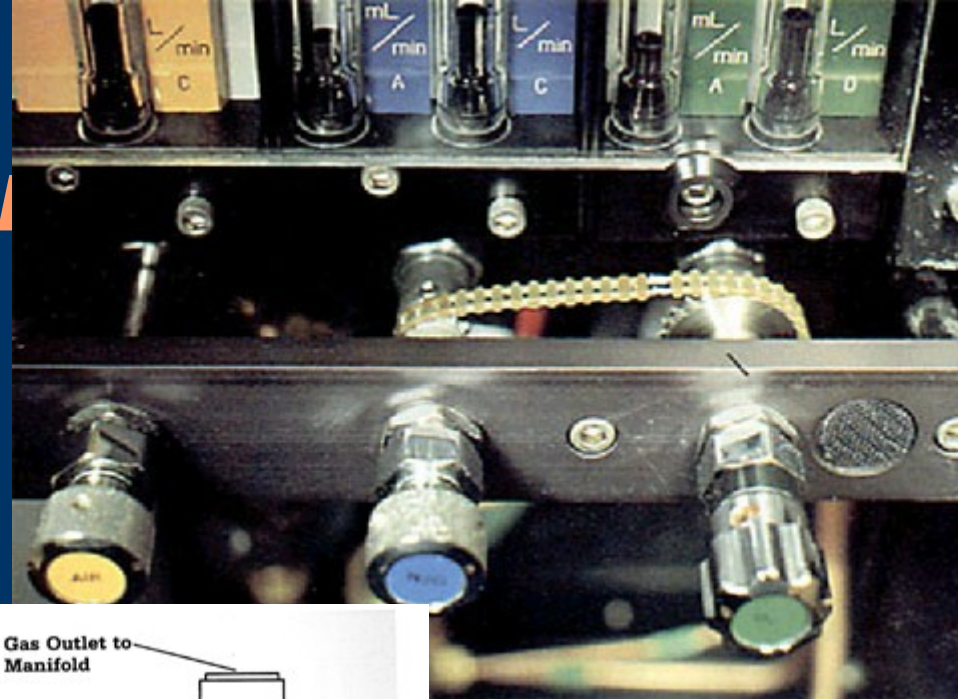

Flow of Anest. gasses

- old machines 2..4 l/min
- low flow > 1 l/min
- minimal flow $> 0,5$ l/min
- closed system .. amount of metabolized O₂

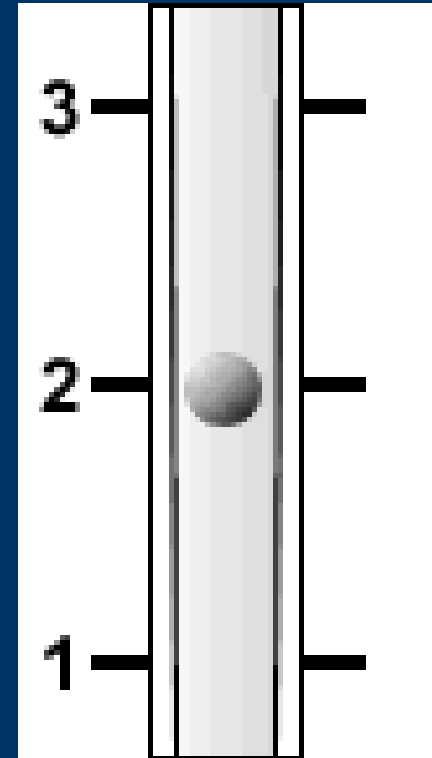

Vaporizer – easy model

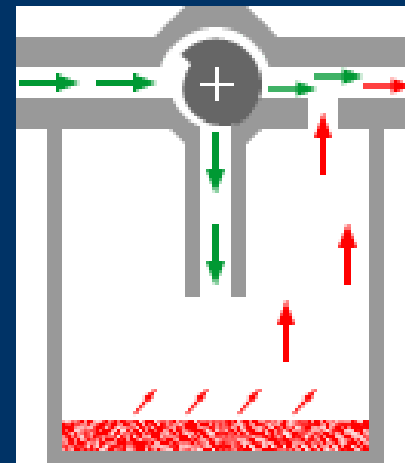

Vaporizers

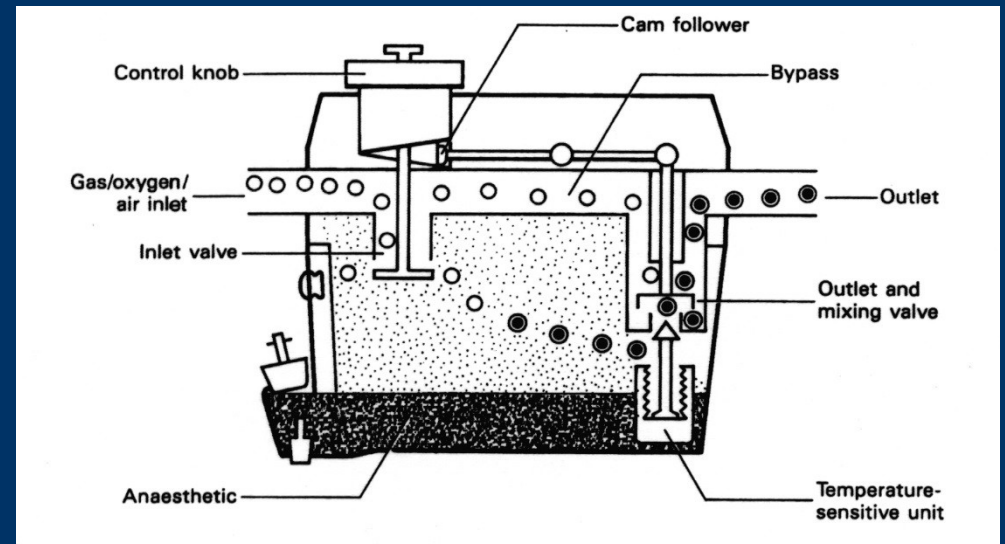
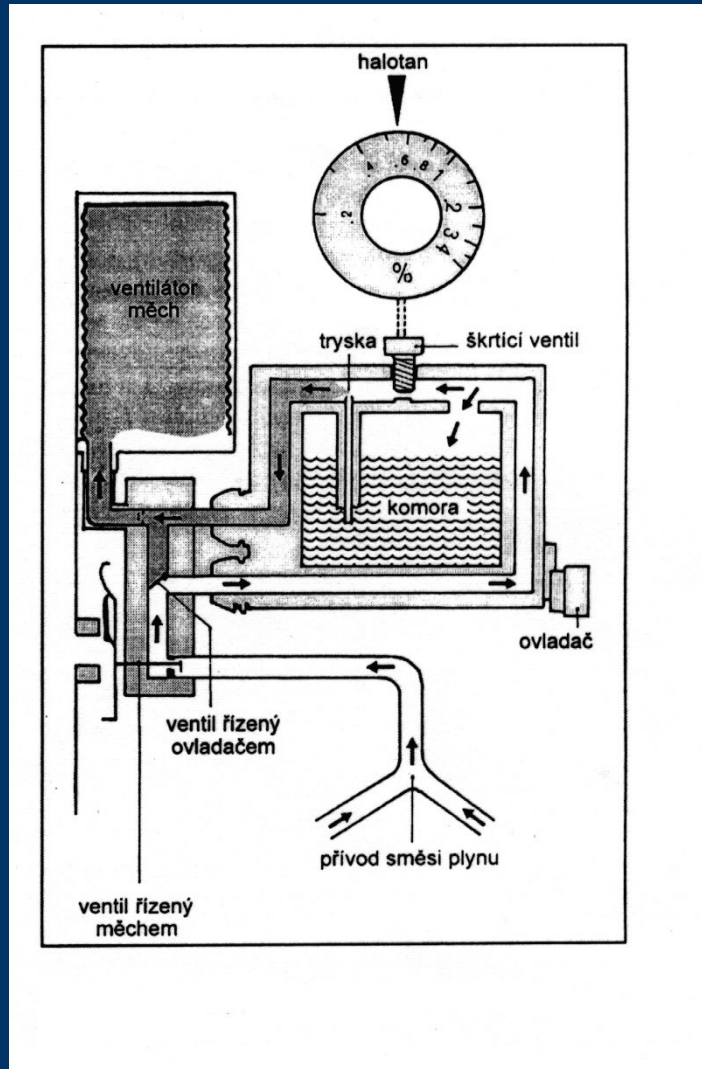
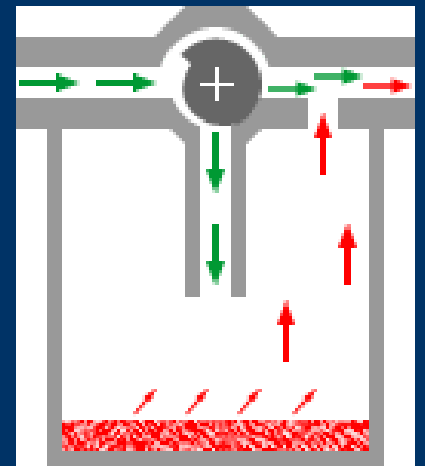

Totally different one ... Desfluran

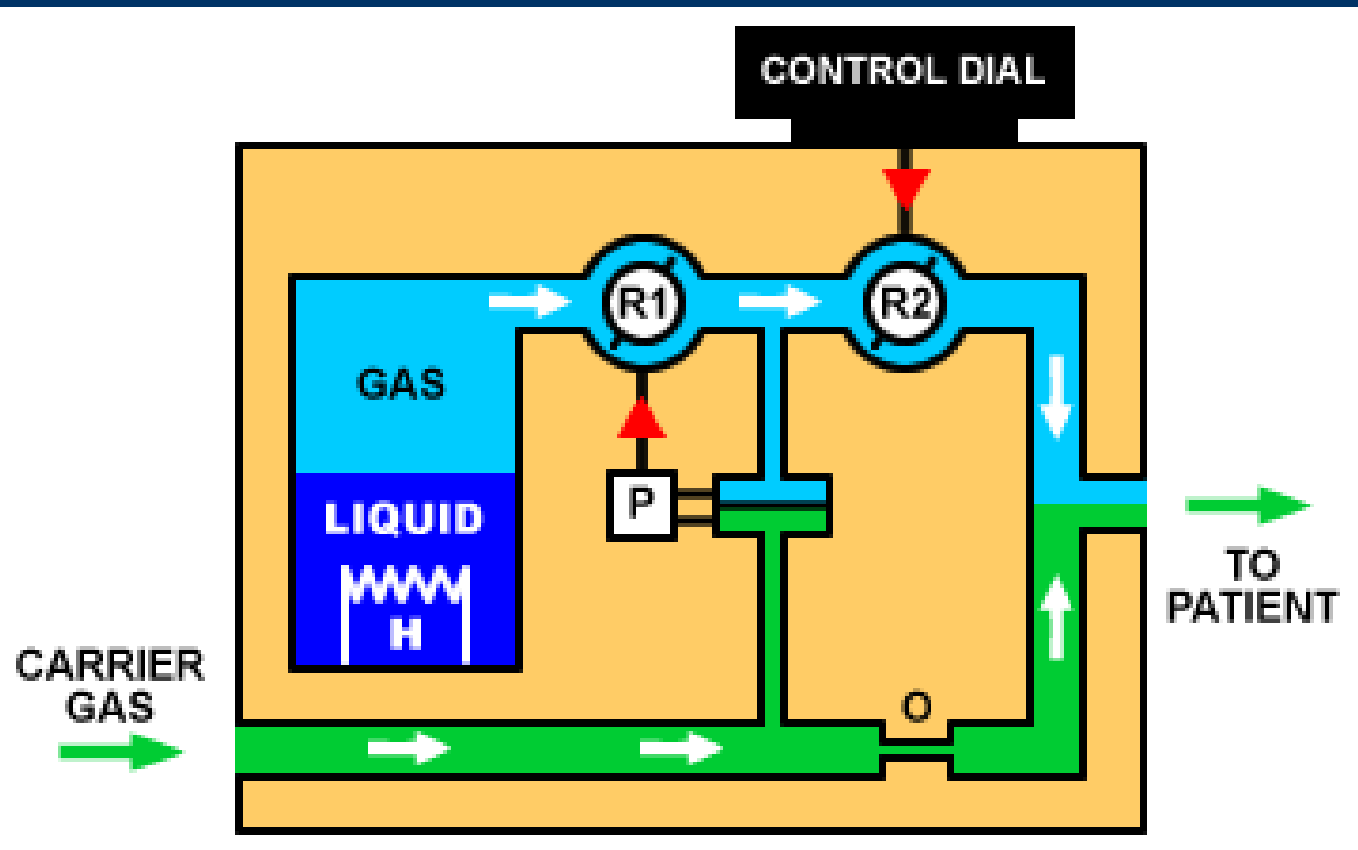

Breathing Circuit

- inspiratory valve
- manometr
- Y connector
- expiratory valve
- volumetr
- CO2 absorber
- tubes
- APL valve

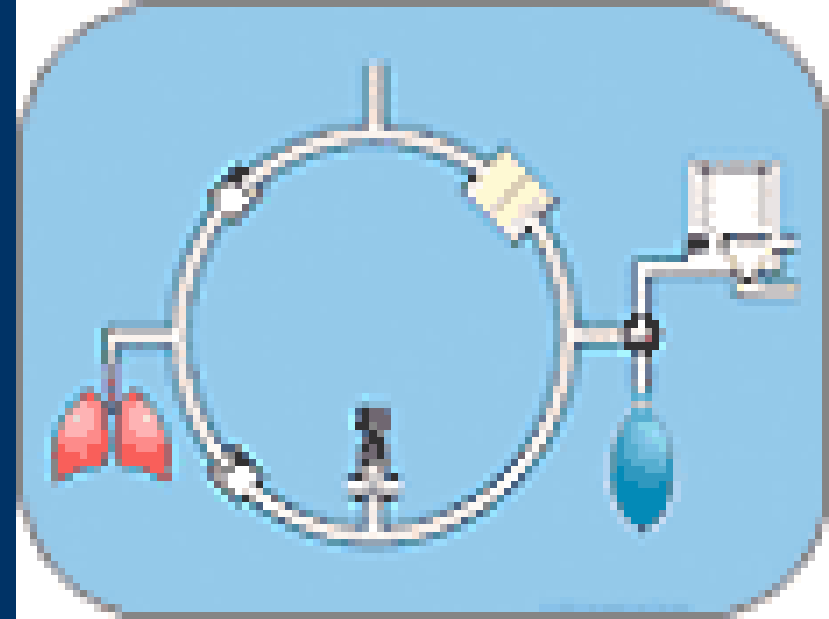

to rebreath expired gas without CO2 – low flow

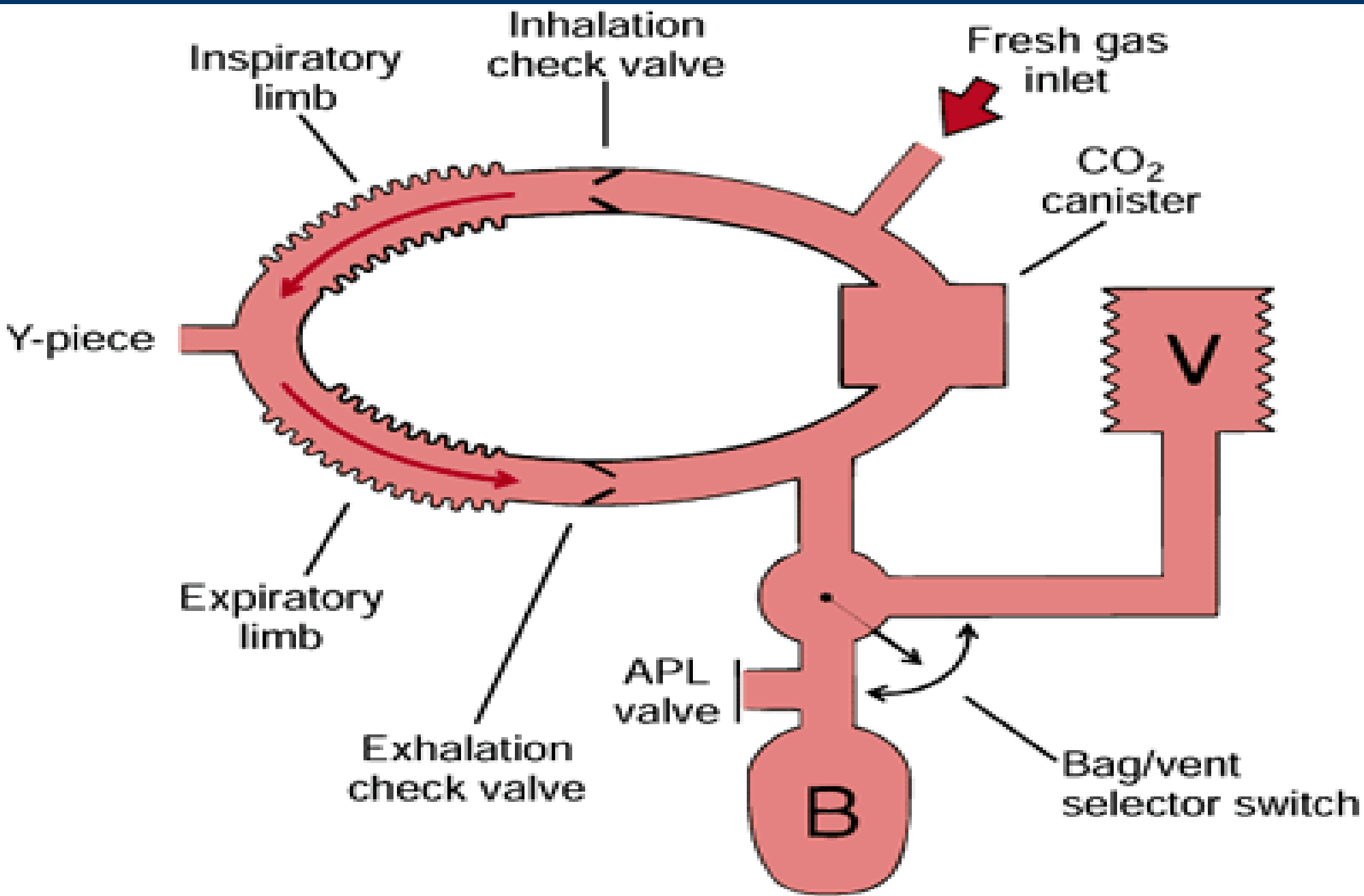

inspiratory + exp. valve

1 direction

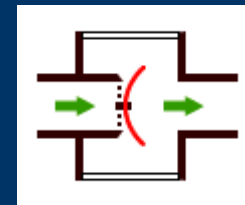
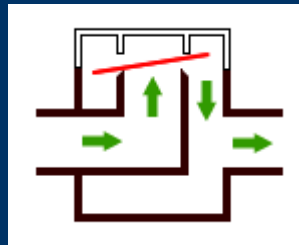

manometr



Y connector, filter, tubing



ISO

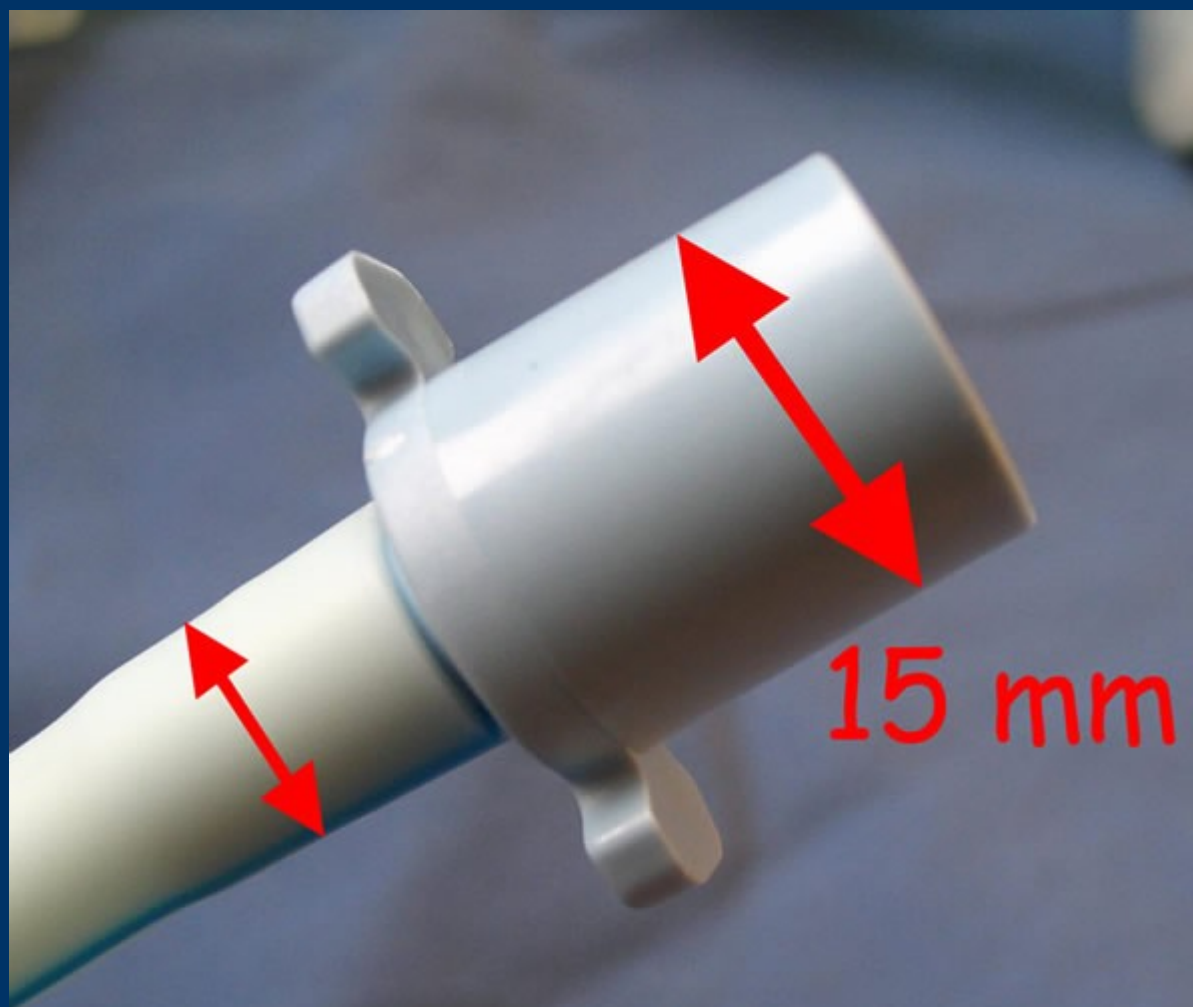

CO₂ absorber



Neutralizační reakce:

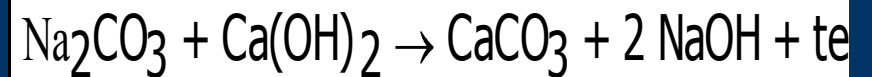
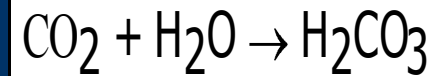

kapacita: (teoreticky 26l) reálně 15-20l CO₂/100 g

tubing

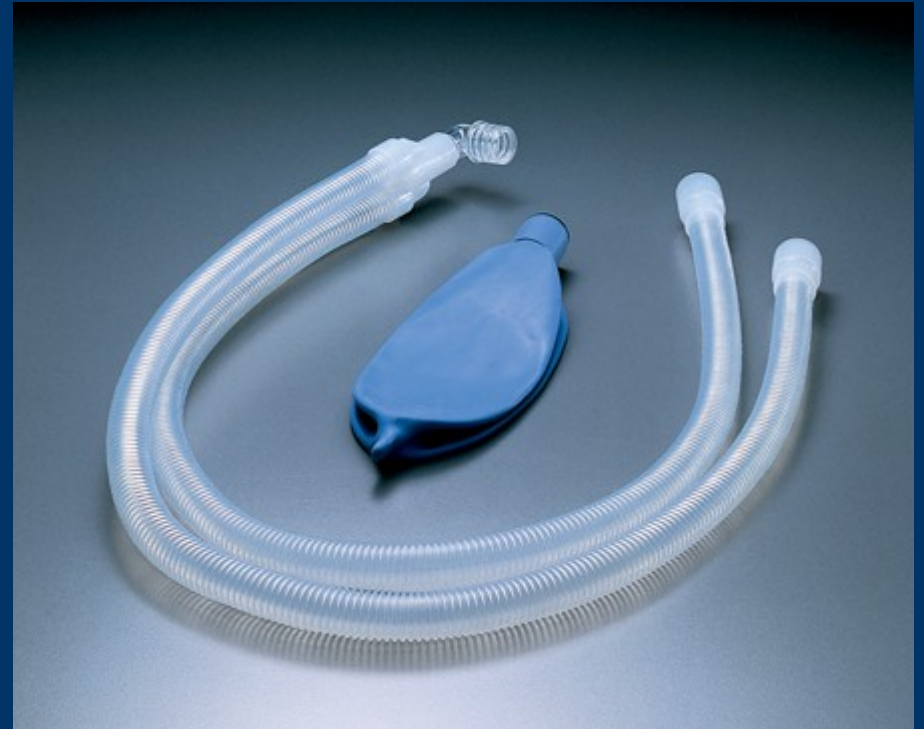

Adjustable Pressure Limiting valve

- (APL, "pop-off" valve)
 - is located at a position such that it is in pneumatic connection with the breathing circuit only during manual ventilation
 - limits the amount of pressure buildup that can occur during manual ventilation. When the user adjusts the APL valve to trap more gas inside the breathing circuit, a spring inside the APL valve is compressed according to how much the user turns the APL valve. The degree of spring compression exerts a proportional force on a sealing diaphragm in the APL valve. The pressure inside the breathing circuit must generate a force that exceeds the spring compression force for the APL valve to open. As pressure continues to build from the combination of fresh gas flow and manual compression of the breathing bag, the opening pressure of the APL valve will be exceeded and excess gas will be vented to the scavenging system.
-
-

APL



Breathing Circuit

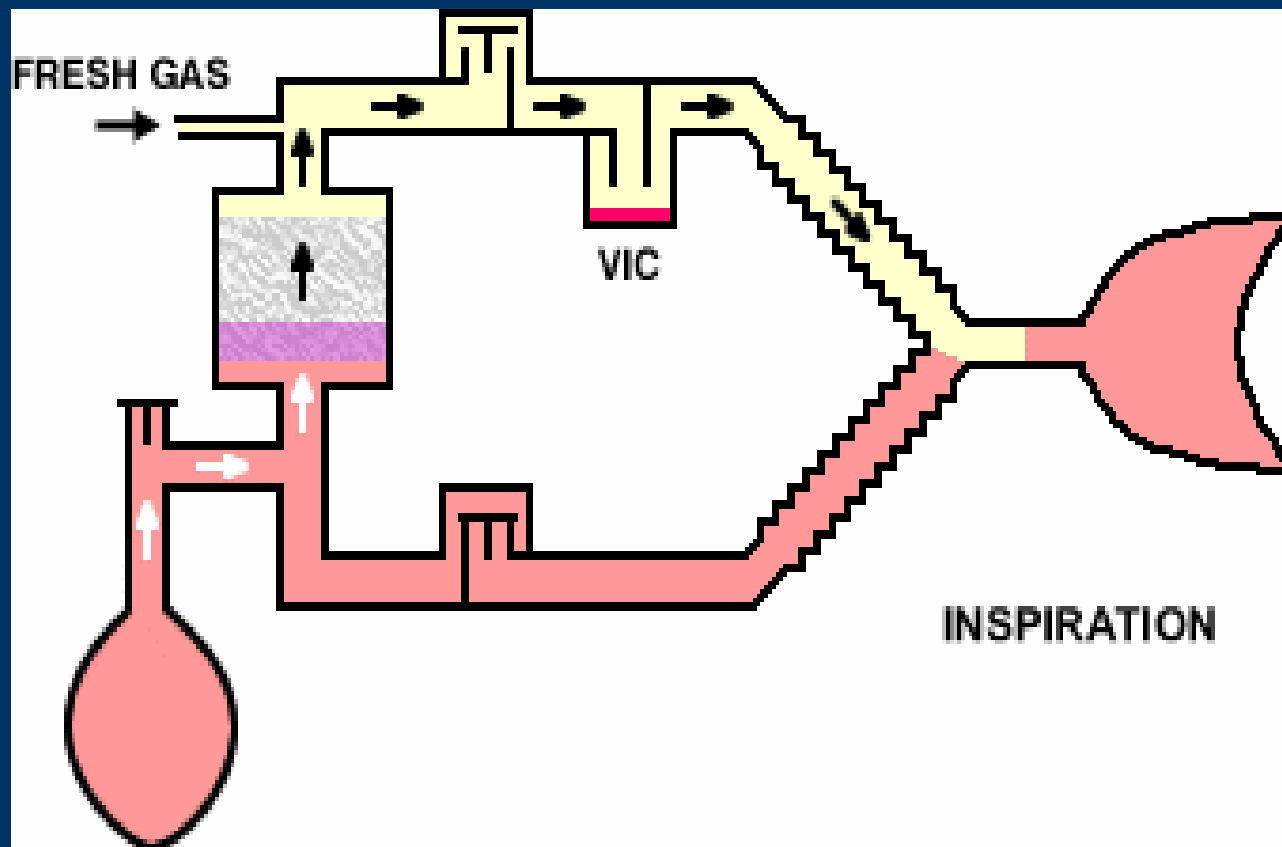

Manometr

- Pressure in tr.tube/TS kanyla
< 20 cm H₂O

- Pressure in LM
< 40 cm H₂O



Ventilation system

- ventilator (bellow, chamber)
(Volum Controlled Ventilation, (PCV)
Vt 6 ml/kg, f according EtCO₂, PEEP 5
- manually - bag

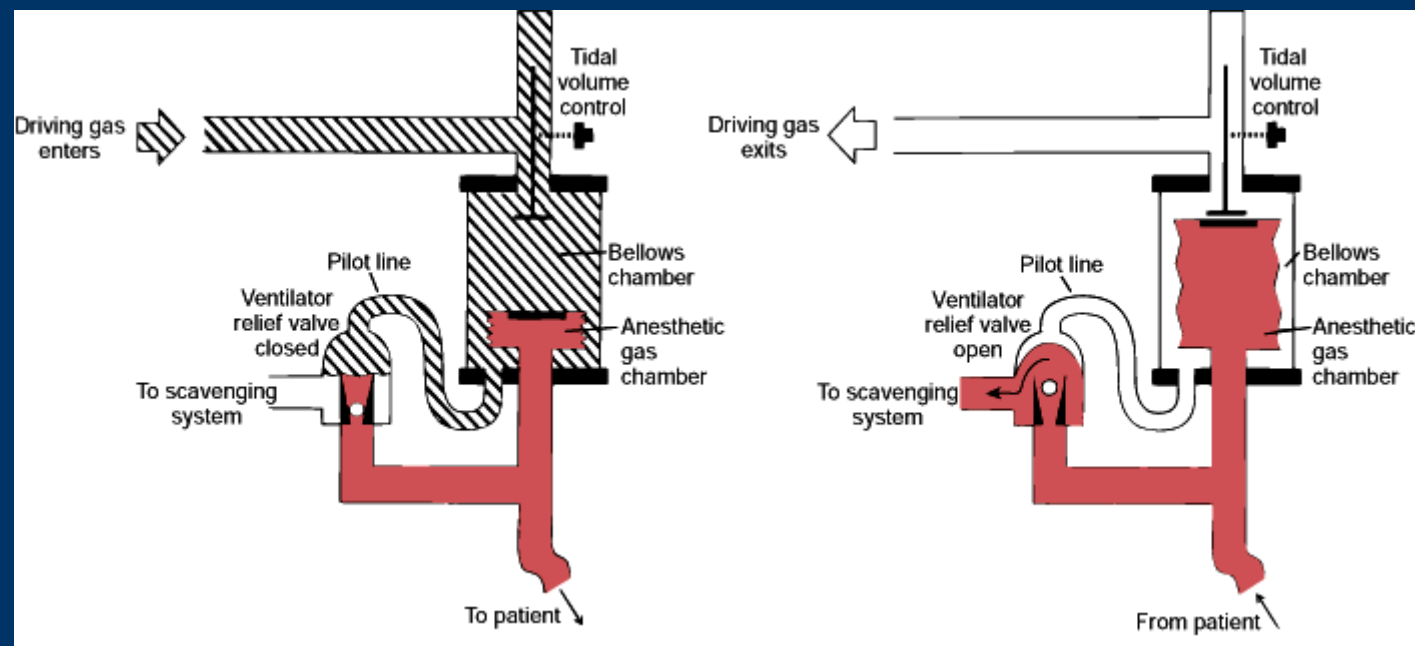

Ventilation system

- power source
 - gas
 - electricity
 - both
- Drive Mechanism, Circuit design
 - double-circuit ventilator (patient and drive gas)



Bellow



Scavenging system

- Keep clean OR atmosphere

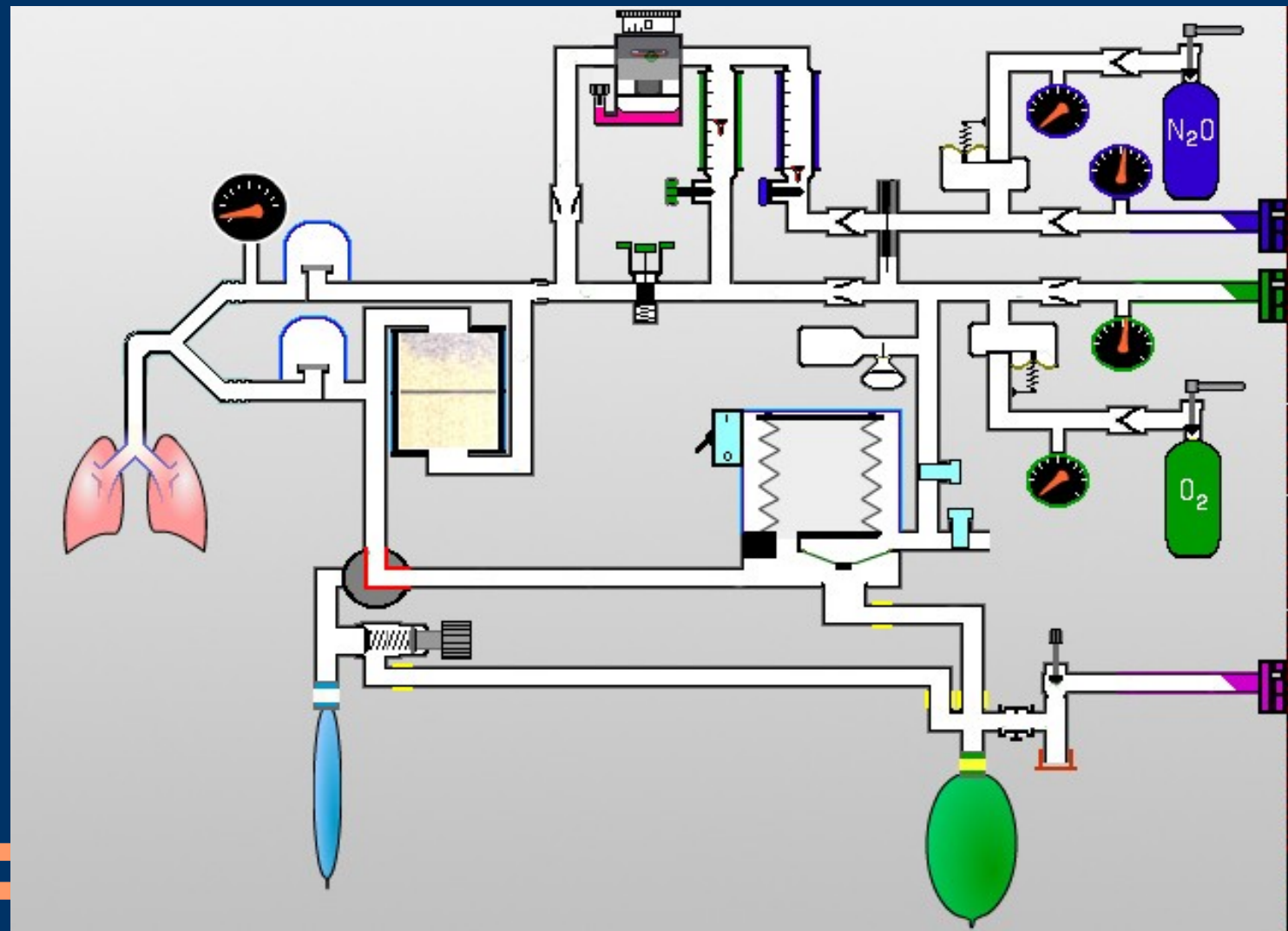

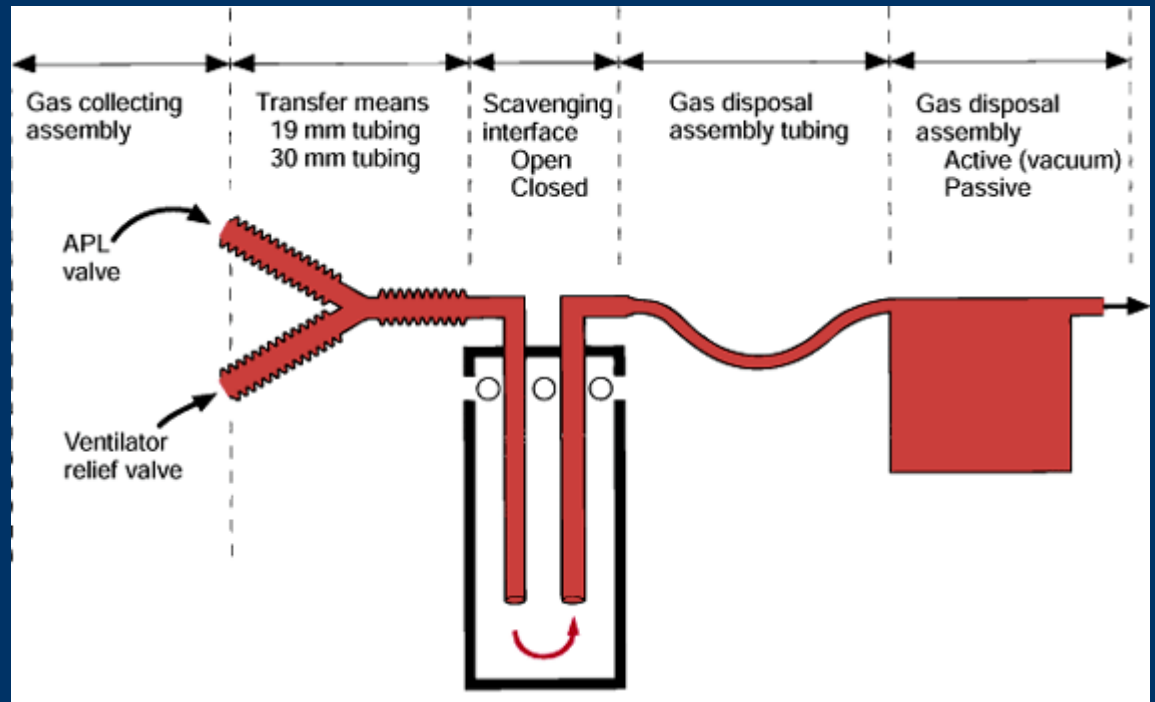

SAL

23:29



ECG

96 /min

Arrh. analys: Severe



%

98

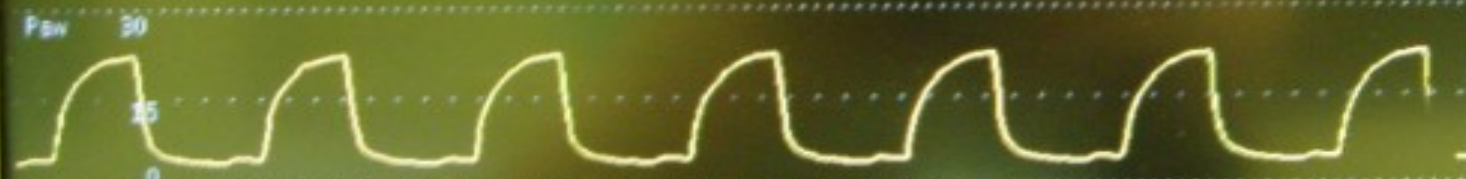

cmH2O
Ppeak
Pplat

Adult
22 PEEPtot **5**
21

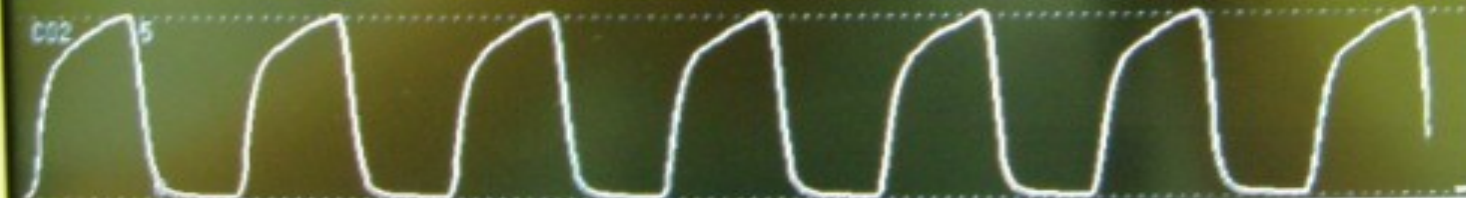

kPa
ET

5.1 FI **0.0**
RR **13** /min

NIBP		
mmHg	Sys	Dia
122/71		
Mean	184	0 5 min

T1	
°C	---
T1	---

Gases			
%	O2 Δ	N2O	Iso
ET	58	29	0.25
FI	59	37	0.40

MAC			
%	N2O	Iso	MAC
ET	29	0.25	0.5
FI	37	0.40	

Monitoring system

monere, "to warn"
systematic control

Patient monitoring has been a key aspect of anesthesiology since its beginnings as a medical specialty.



Optical illusions

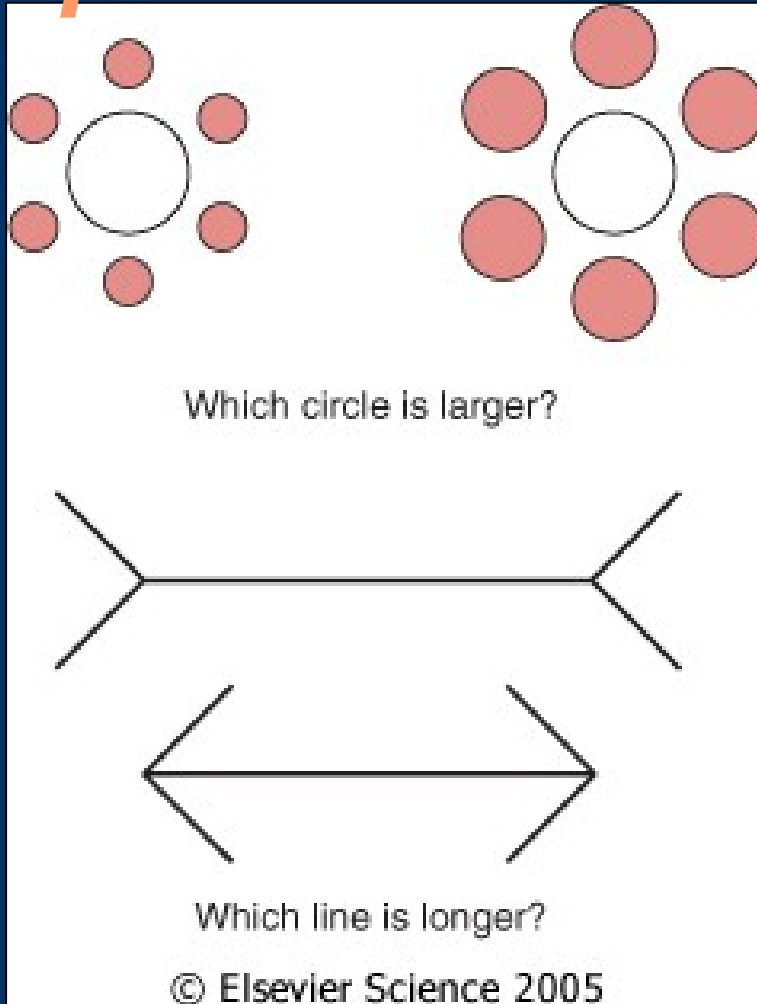

... it is not possible without eye

Figure 30-1 Optical illusions. We perceive the circles to be different sizes because we infer the size by relative dimensions. The closeness of the smaller circles makes the inner circle appear smaller, and vice versa. The lines appear to be different sizes because we use straight-line perspective to estimate size and distance. This illusion reportedly does not work in cultures where straight lines are not used. Therefore, our internal perceptions lead us to err in estimating size and length. In the same way, the internal programming of our monitors can lead us to misinterpret results.

Monitoring

1) Presence of anesth. / nurse

- Airway + Breathing
 - patent A.
 - quality of B., auscultation
- Circulation
 - quality, f, CRT, color of skin
- depth of A.
 - pupils, sweating, movement

Goal: prevent problem

>>>> *Alarm* <<<<

< ?? What should I do ?? >

- notice
- interpret
- reaction = change something
 - alarm off?
 - change limits of alarm?



Auscultator

- + available
- ventilatory problem
(bronchospasm, laryngospasm - LM)
- SpO₂, EtCO₂ a ECG detect problem easier than continual auscultation.

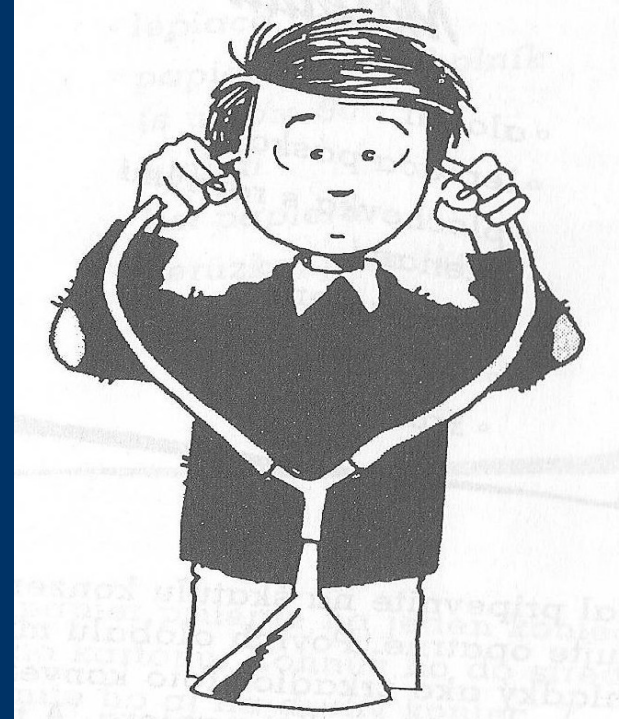

Basic monitoring in case of Fail of Anest.
Machine

ECG

- Heart Frequency
- rhythm
- extrasystols
- ST
- ischemia

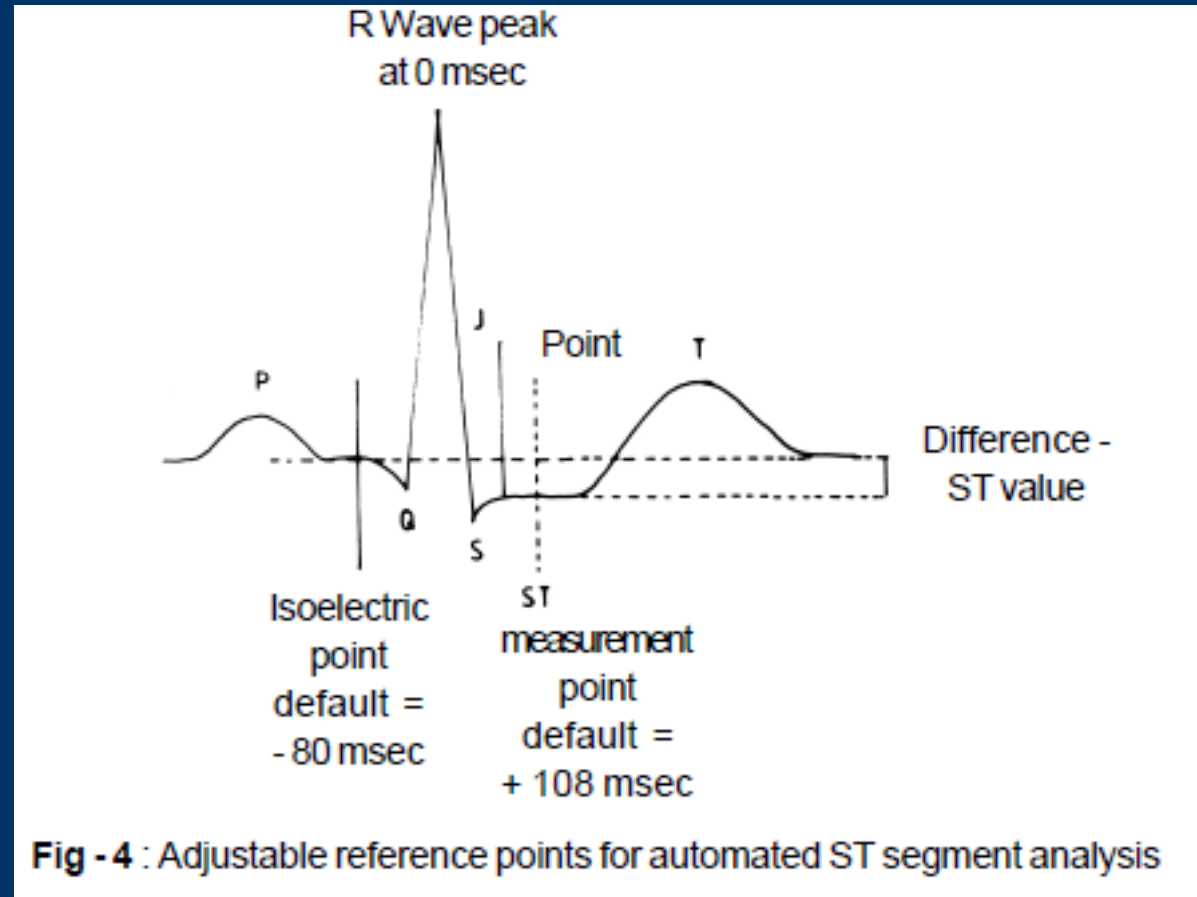

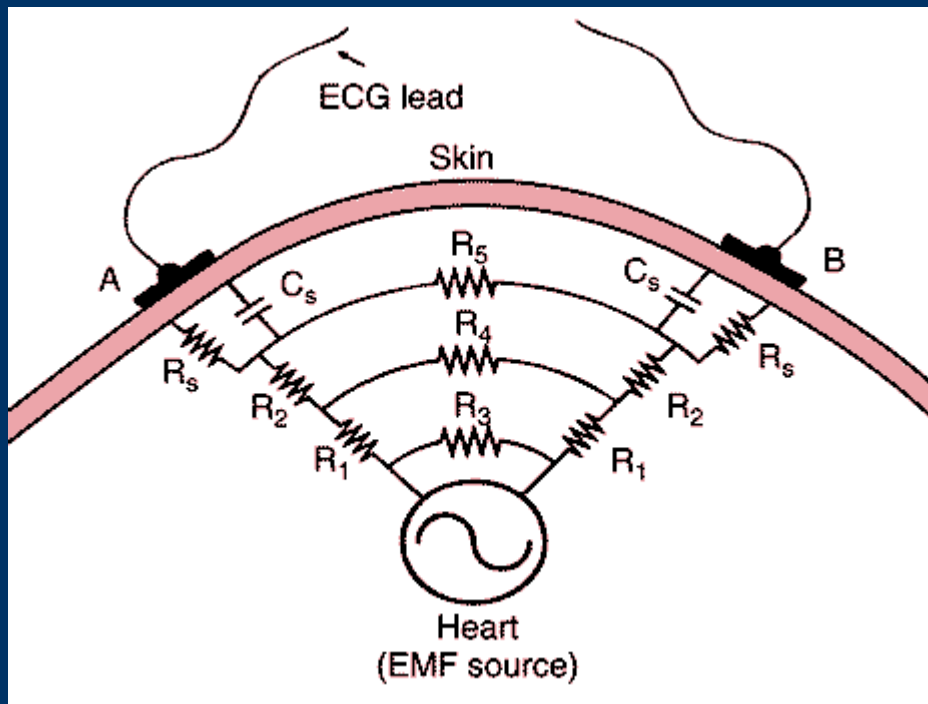
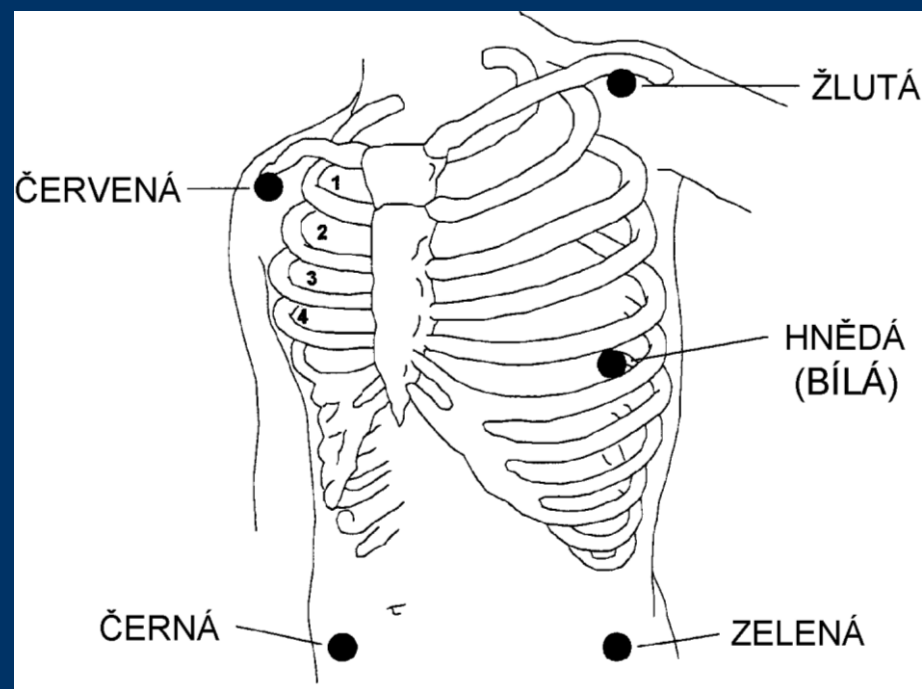
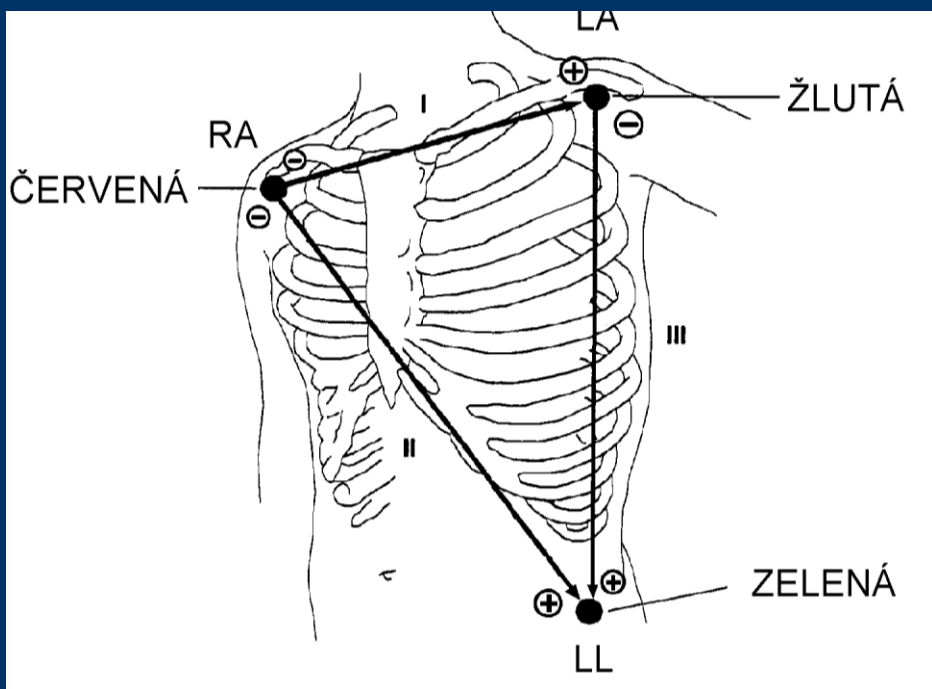
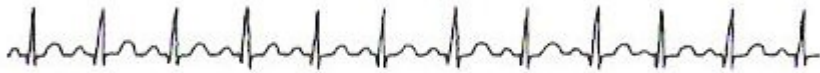

FIGURE 28–30 Why the ECG is so small. Multiple resistances and capacitances in the body decrease the potential and distort the waveform before the EMF reaches the surface.

Positioning of electrodes



sinus rythm



Obr. 2a: Sinusová tachykardie



Obr. 2b: Sinusová bradykardie

SVT: (no P, QRS narrow, regular)



Obr. 2c: Supraventrikulární tachykardie



Fibrillation of Atrii

irregular , QRS narrow



Obr. 2d: Fibrilace síní - jemnovlnná



Obr. 2e: Fibrilace síní - hrubovlnná



Obr. 2f: Flutter síní

Ventricular rhythm



Obr. 2g: Komorová tachykardie



Obr. 2h: Repetitivní komorová tachykardie



Obr. 2j: Preterminální stahy



Obr. 2k: Terminální stahy

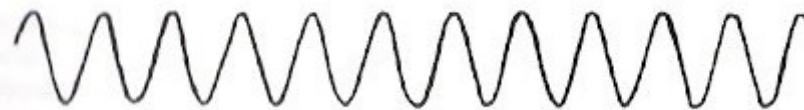

Obr. 2l: Flutter komor, příp. rychlá komorová paroxyzmální tachykardie

Stimulation

spike, komplex



Obr. 2m: Elektrostimulace „fixed rate“

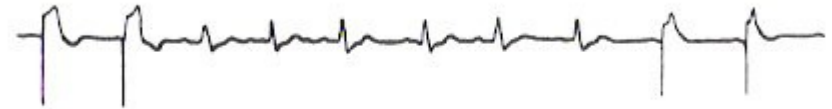

Obr. 2n: Elektrostimulace „on demand“

ECG ... Heart frequency

- 45/min or 150/min or ??

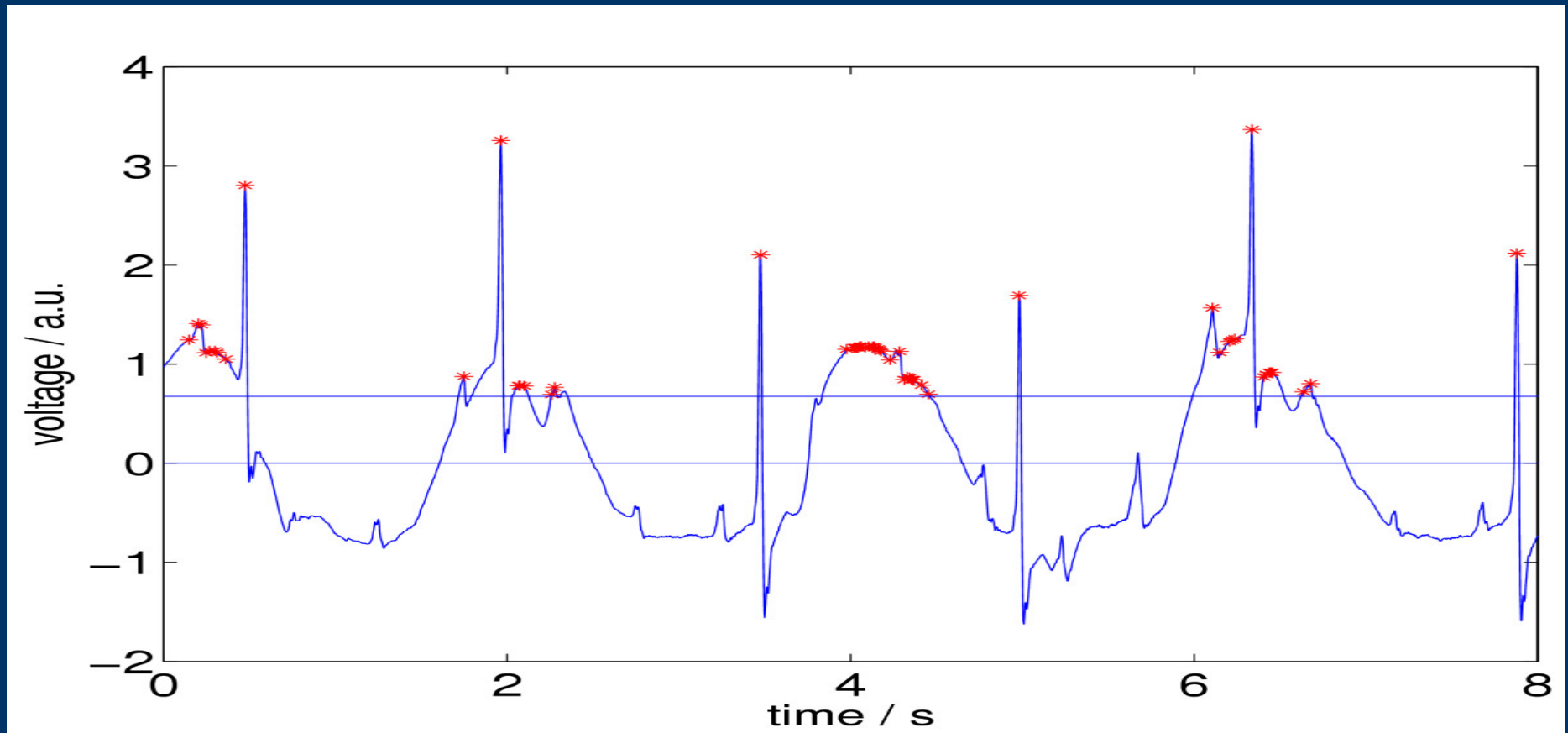

ECG – complication of monitoring

- electric interference ()
- 50Hz cross ECG cabel
- cabel as anntena (loop)
- no signal 10s after defibrilation

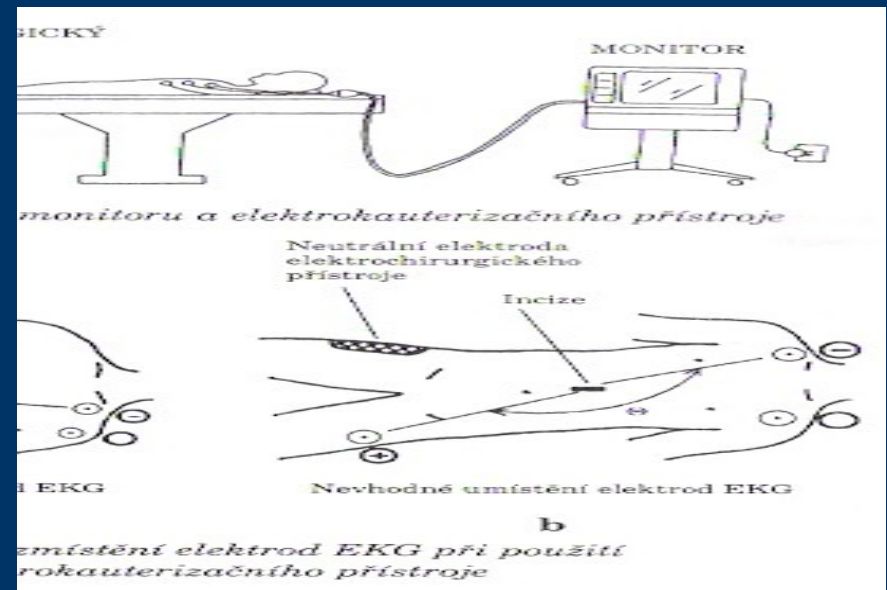

NIBP – effect of cuff size

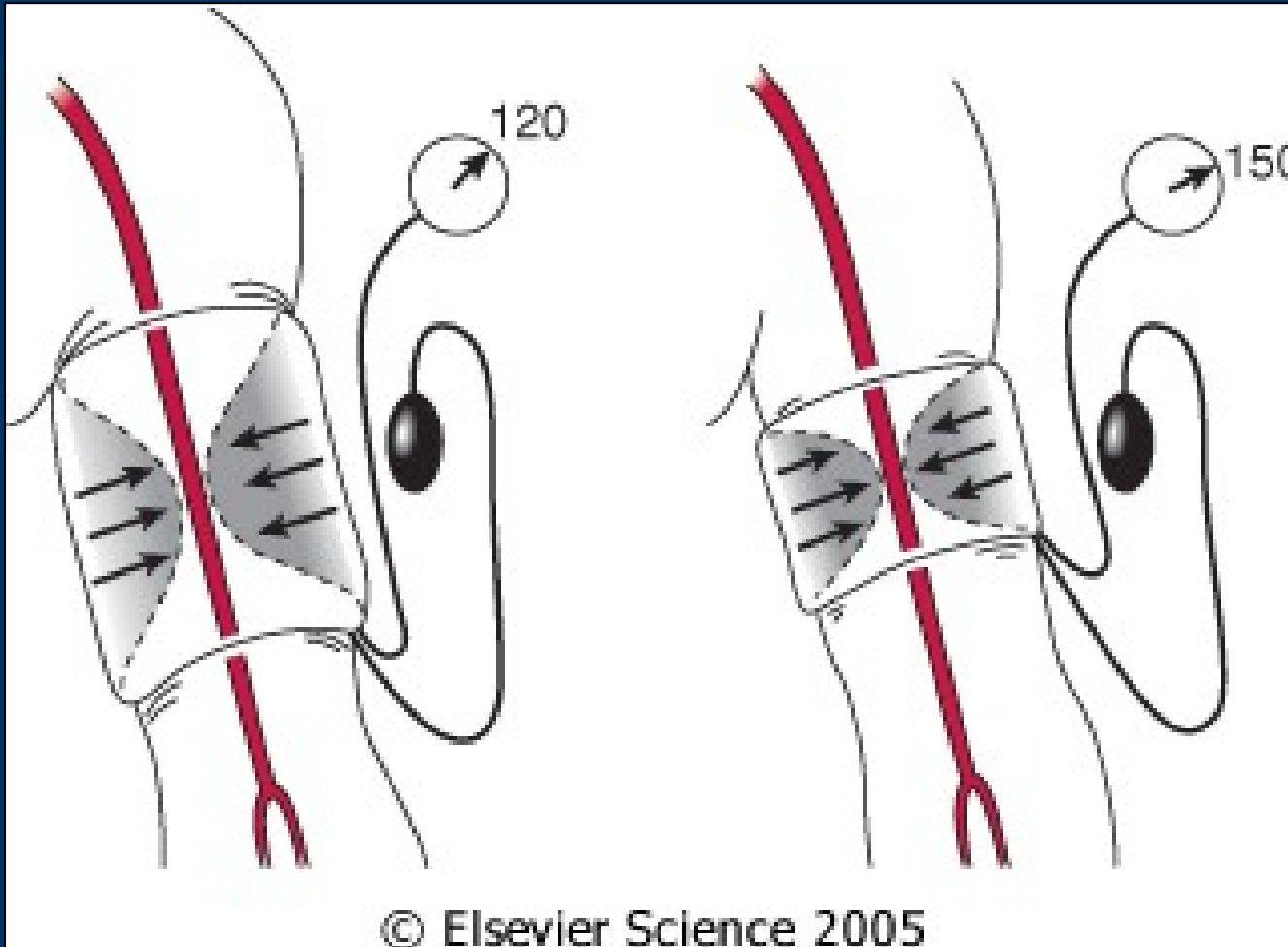

Figure 32-2 Effect of cuff size on manual blood pressure measurement. An inappropriately small blood pressure cuff yields erroneously high values for blood pressure because the pressure within the cuff is incompletely transmitted to the underlying artery.

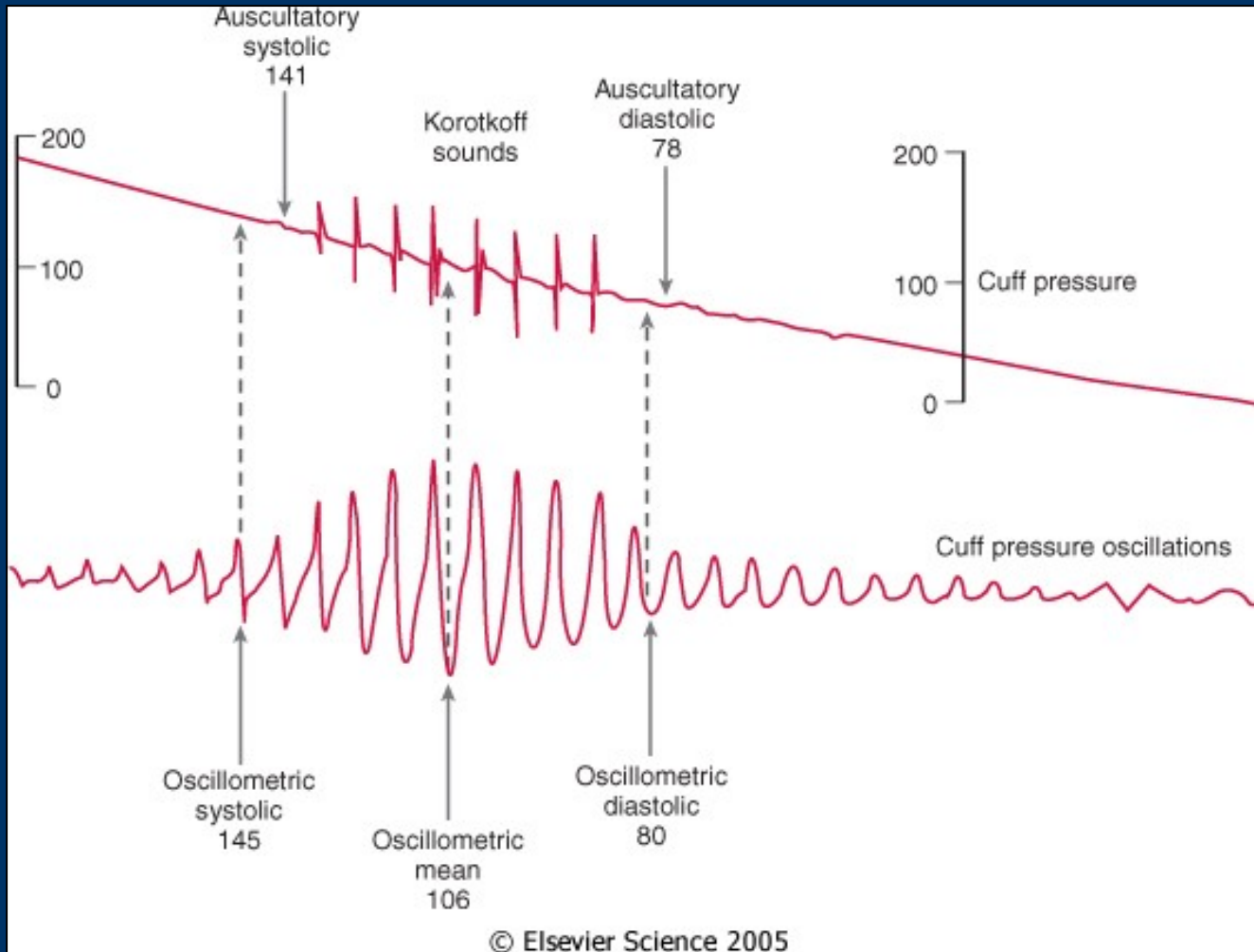

Figure 32-3 Comparison of blood pressure measurements by Korotkoff sounds and oscillometry. Oscillometric systolic blood pressure is recorded at the point where cuff pressure oscillations begin to increase, mean pressure corresponds to the point of maximal oscillations, and diastolic pressure is measured when the oscillations become attenuated. Note the correspondence between these measurements and the Korotkoff sounds that determine auscultatory systolic and diastolic pressure. (Redrawn from Geddes LA: Cardiovascular Devices and Their Applications. New York John Wiley, 1984, Fig 34-2. Reprinted by permission of John Wiley & Sons, Inc.)

NIBP

Complications :

- Pain
 - Petechie
 - Edema of extremity
 - Venous stasis, thrombophlebitis
 - Peripheral neuropathy
 - Compartment syndrome
- Uneasy measurement
 - movements
 - transport
 - bradycardia $< 40/\text{min}$
 - obesity
 - shock - vasoconstriction
-
-

IBP, Canylation of artery

- real-time, beat to beat
- rapid changes - drugs / mechanic
- repeated blood samples [BGasses]
- failure of NIBP
- additional information from puls curve
 - Pulse Pressure Variation



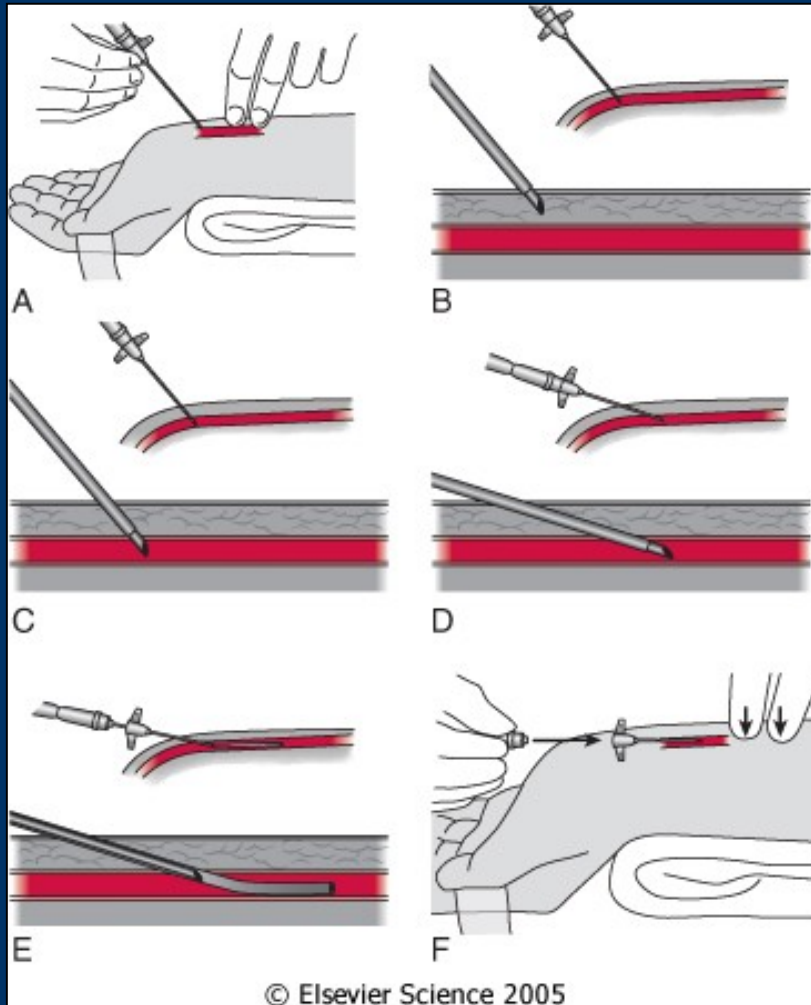
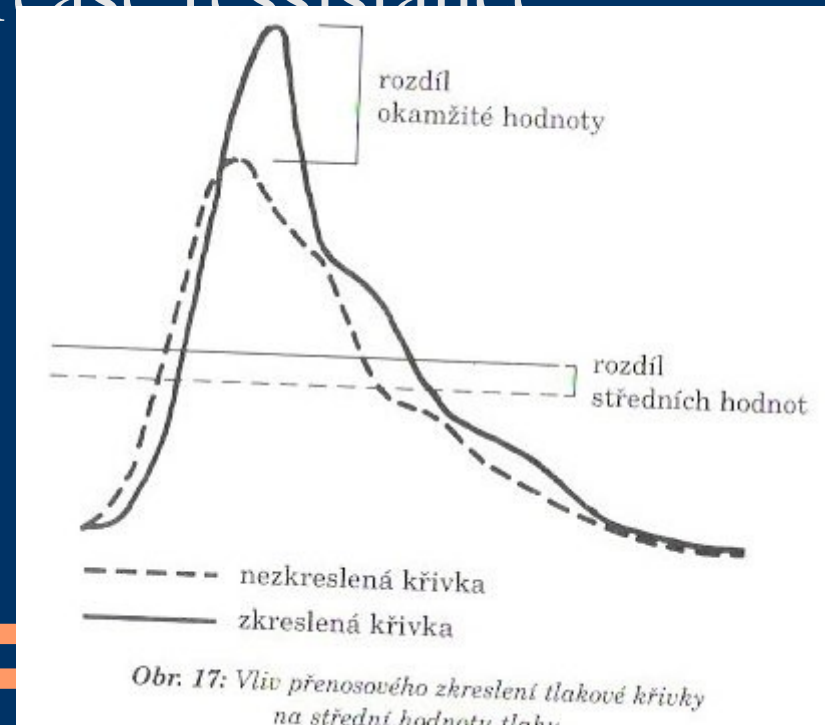
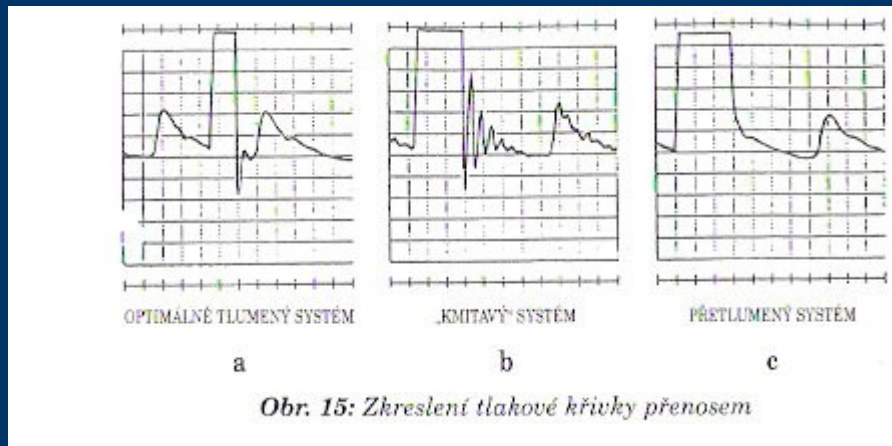

Figure 32-4 Percutaneous radial artery cannulation. A, The wrist is positioned and the artery identified by palpation. B, The catheter-over-needle assembly is introduced through the skin and advanced toward the artery. C, Entry of the needle tip into the artery is identified by the flash of arterial blood in the needle hub reservoir. D, The needle-catheter assembly is advanced at a lower angle to ensure entry of the catheter tip into the vessel. E, If blood flow continues into the needle reservoir, the catheter is advanced gently over the needle into the artery. F, The catheter is attached to pressure monitoring tubing while maintaining proximal occlusive pressure on the artery.

Invasive Pressure

a. radialis / a. femoralis / a. brachialis
arterie – hose – cell – infusion (cont. flush of
cannyla ml/h)

- fluid is not compressible X air
- cloat of blood / cranking increase resistance



!!Alarm!! Low BP

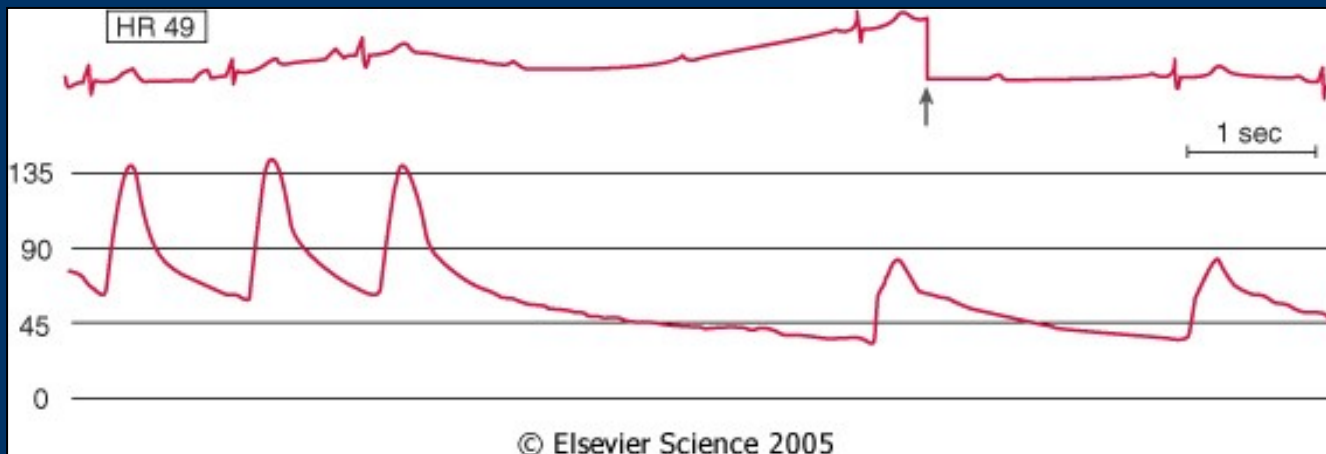
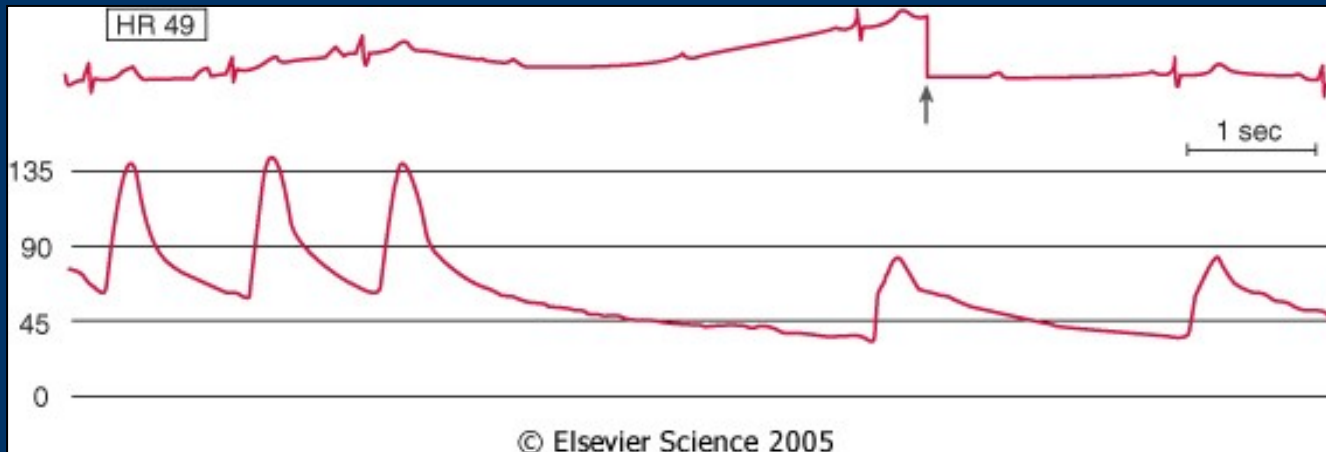

Figure 32-1 Digital heart rate (HR) displays may fail to warn of dangerous bradyarrhythmias. Direct observation of the electrocardiogram (ECG) and the arterial blood pressure traces reveals complete heart block and a 4-second period of asystole, whereas the digital display reports an HR of 49 beats/min. Note that the ECG filter (arrow) corrects the baseline drift so that the trace remains on the recording screen. (From Mark JB: Atlas of Cardiovascular Monitoring. New York, Churchill Livingstone, 1998, Fig. 13-2.)

***HR: 49/min,
ECG: AV blok III***



O₂ in the body

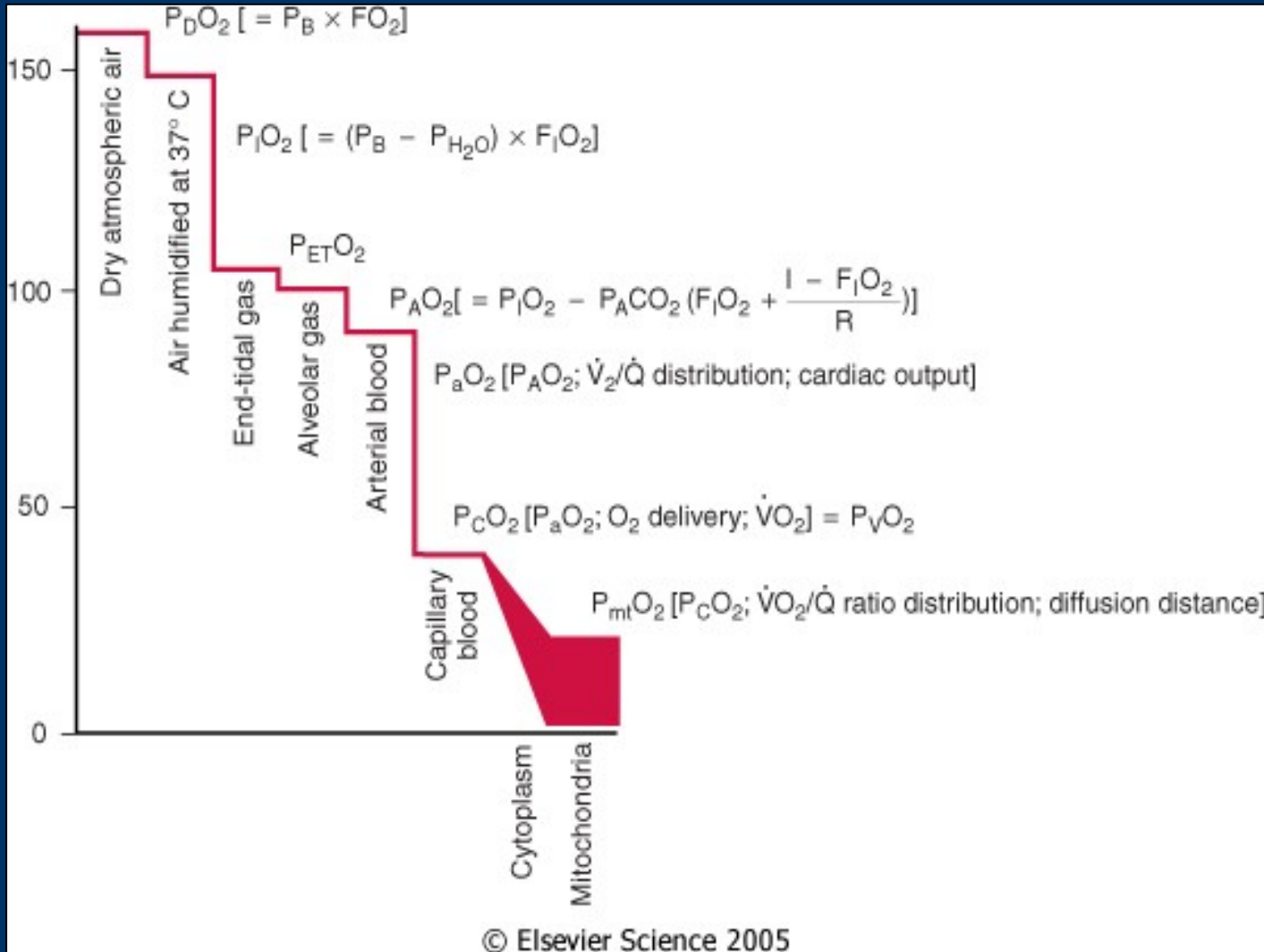

Figure 36-1 Oxygen transport cascade. A schematic view of the steps in oxygen transport from the atmosphere to the site of utilization in the mitochondrion is shown here. Approximate Po₂ values are shown for each step in the cascade, and factors determining those partial pressures are shown within the square brackets. There is a distribution of tissue Po₂ values depending on local capillary blood flow, tissue oxygen consumption, and diffusion distances. Mitochondrial Po₂ values are depicted as a range because reported levels vary widely. (Adapted from Nunn JF: Nunn's Applied Respiratory Physiology, 4th ed. Boston, Butterworth-Heinemann, 1993.)

Oxygenation of tissues

- monitoring of inspired O₂
- SpO₂
- Arterial blood gasses
 - low cardiac output and good oxygenation function of lung

Saturation, SpO₂



A pulse oximeter is a particularly convenient noninvasive measurement instrument. Typically it has a pair of small light-emitting diodes (LEDs) facing a photodiode through a translucent part of the patient's body, usually a fingertip or an earlobe. One LED is red, with wavelength of 660 nm, and the other is infrared, 905, 910, or 940 nm. Absorption at these wavelengths differs significantly between oxyhemoglobin and its deoxygenated form; therefore, the oxy/deoxyhemoglobin ratio can be calculated from the ratio of the absorption of the red and infrared light. The absorbance of oxyhemoglobin and deoxyhemoglobin is the same (isosbestic point) for the wavelengths of 590 and 805 nm; earlier oximeters used these wavelengths for correction for hemoglobin concentration.

Principle of pulse oximetry

- 1000 absorption of light of different wave length

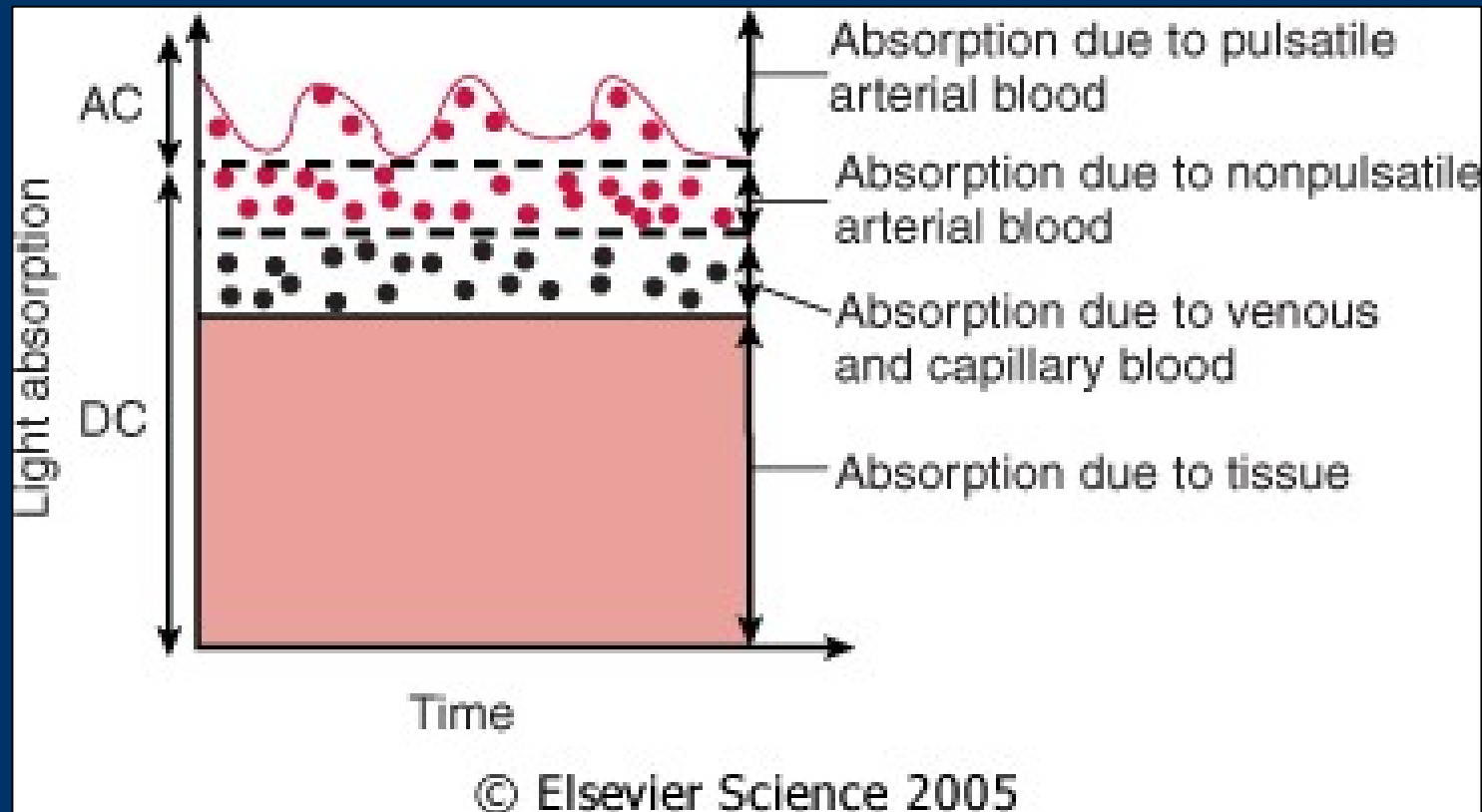

Figure 36-10 Principle of pulse oximetry. Light passing through tissue containing blood is absorbed by tissue and by arterial, capillary, and venous blood. Usually, only the arterial blood is pulsatile. Light absorption may therefore be split into a pulsatile component (AC) and a constant or nonpulsatile component (DC). Hemoglobin O₂ saturation may be obtained by application of Equation 19 in the text. (Data from Tremper KK, Barker SJ: Pulse oximetry. *Anesthesiology* 70:98, 1989.)

2 vlnové délky, 2 absorpce pro Hb a HbO₂

$$S = \frac{AC_{660} / DC_{660}}{AC_{940} / DC_{940}} \quad \text{aprox. } \% \text{ HBO}/(\text{HB}+\text{HBO})$$

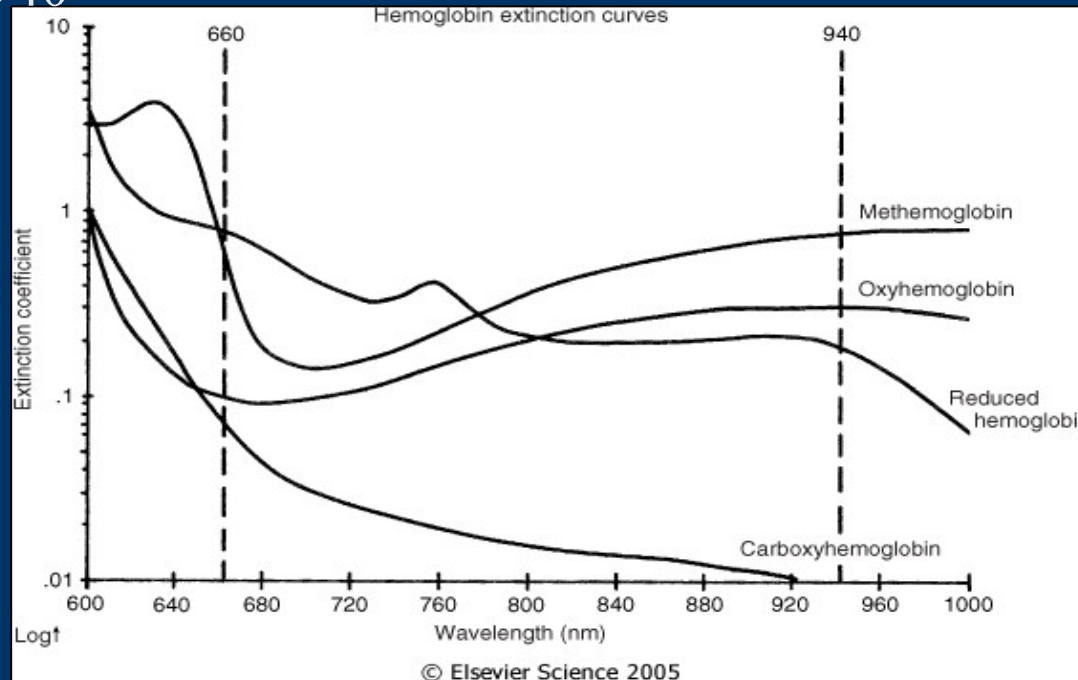

Figure 30-34 Hemoglobin extinction curves. Pulse oximetry uses the wavelengths of 660 and 940 nm because they are available in solid-state emitters (not all wavelengths are able to be emitted from diodes). Unfortunately, HbCO and HbO₂ absorb equally at 660 nm. Therefore, HbCO and HbO₂ both read as SaO₂ to a conventional pulse oximeter. In addition, Hbmet and reduced Hb share absorption at 660 nm and interfere with correct SaO₂ measurement. (Courtesy of Susan Manson, Biox/Ohmeda, Boulder, Colorado, 1986.)

SpO2 – HbO2 - O2 ve tkáni

- oxygenation, not ventilation,
- inaccuracy 5%

Falsely low readings:

- hypoperfusion
- incorrect sensor application;
- highly calloused skin
- movement (such as shivering)

Falsely high:

- carbon monoxide poisoning

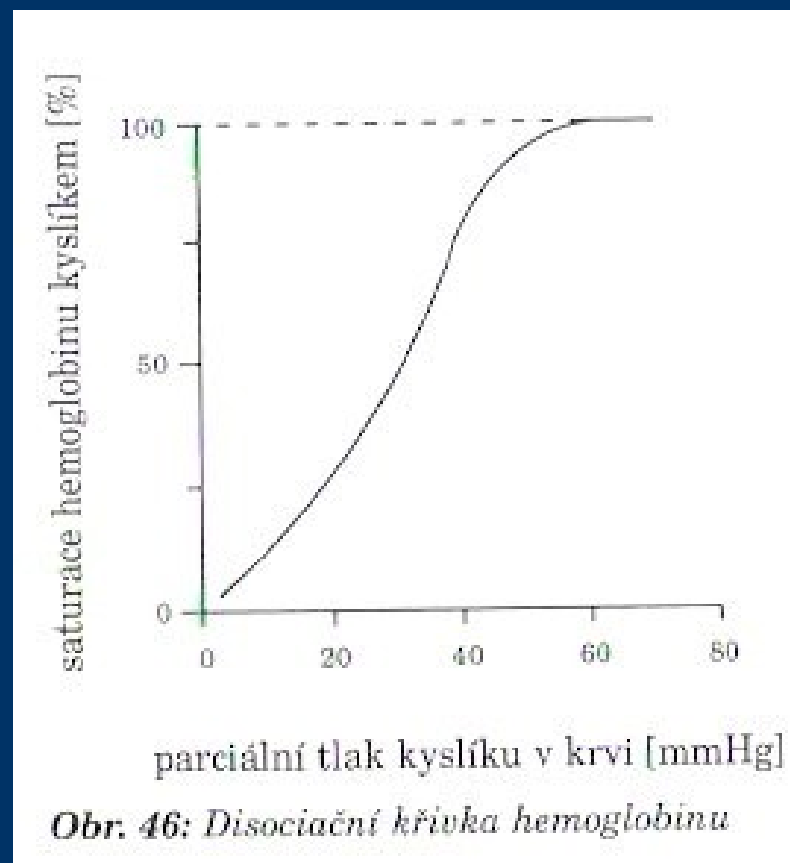

SpO₂ and low temperature

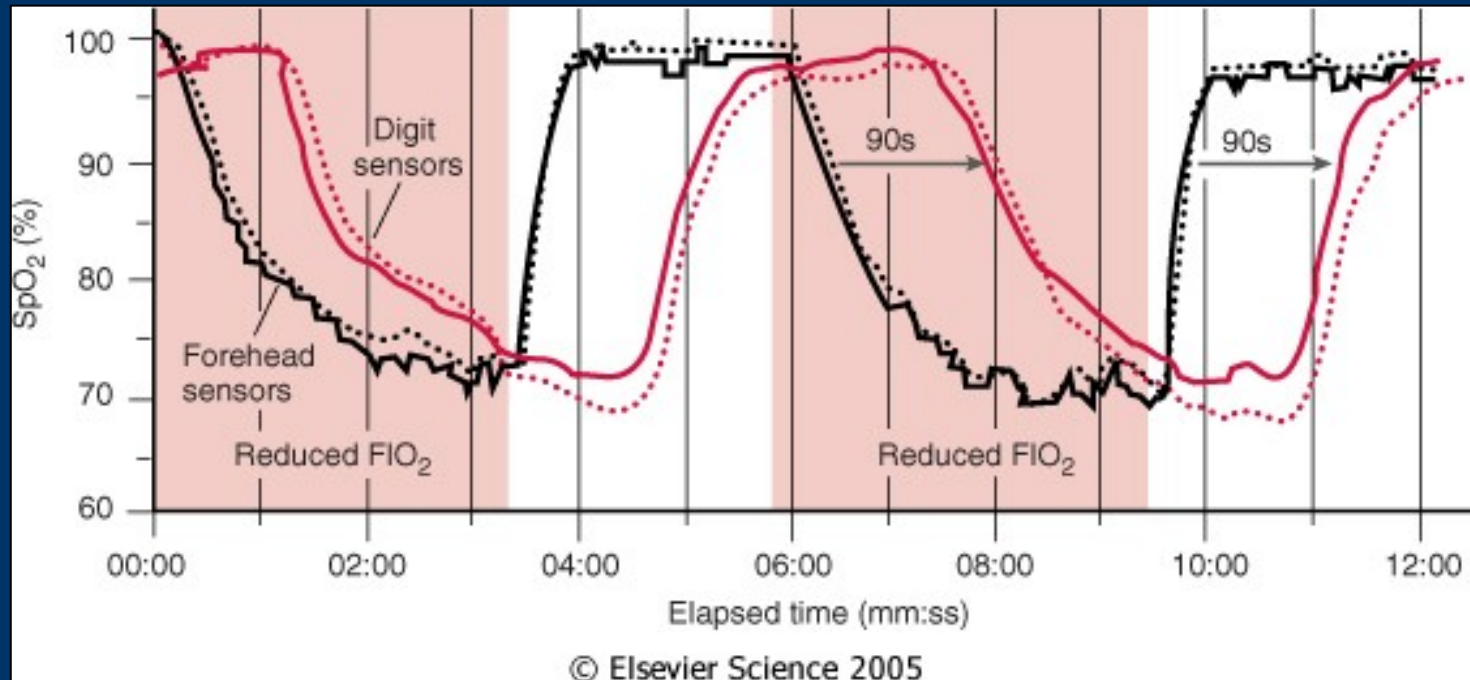
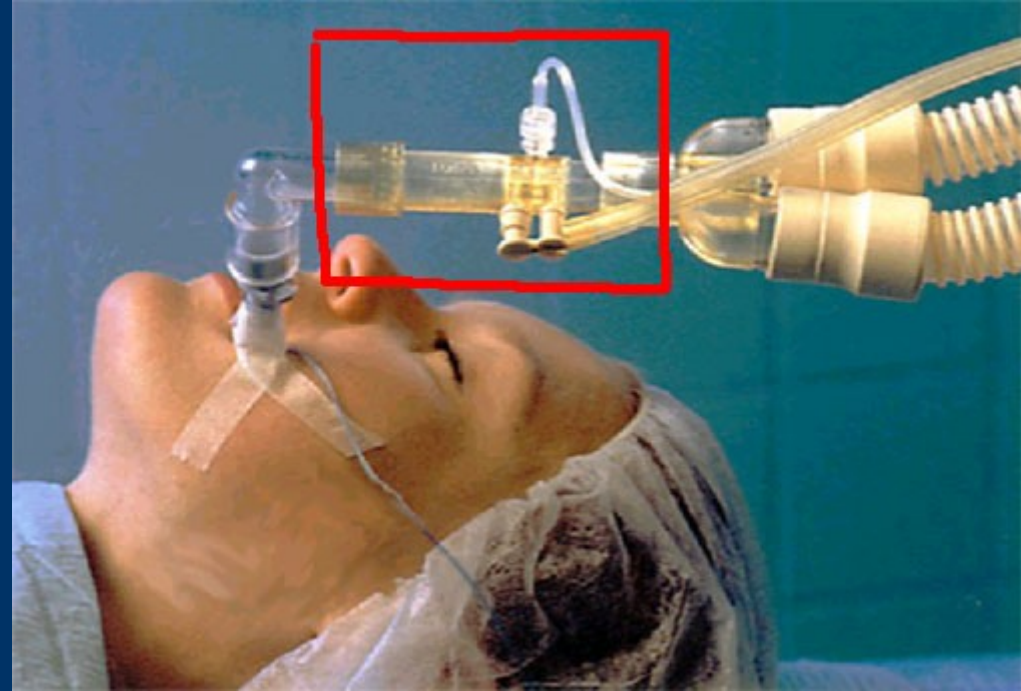

Figure 36-11 Effect of pulse oximeter probe replacement on delay from onset of hypoxemia to a drop in the measured SpO₂. During cold-induced peripheral vasoconstriction in normal volunteers, the onset of hypoxemia was detected more quickly using an oximeter probe on the forehead compared with the finger. Other studies have shown a similar advantage for pulse oximeter probes placed on the ear. (From Bebout DE, Mannheimer PD, Wun C-C: Site-dependent differences in the time to detect changes in saturation during low perfusion. Crit Care Med 29:A115, 2002.)

Ventilation

- P, V, flow;
- PV curve
- Gas Analysis
 - O₂,
 - EtCO₂ – capnometry
 - N₂O, [%] volatile anesthetics



Flow

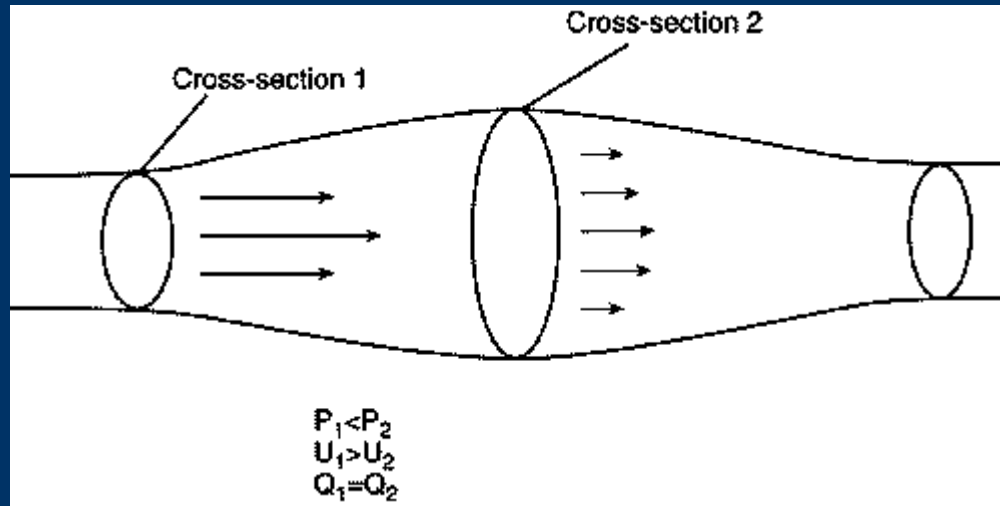

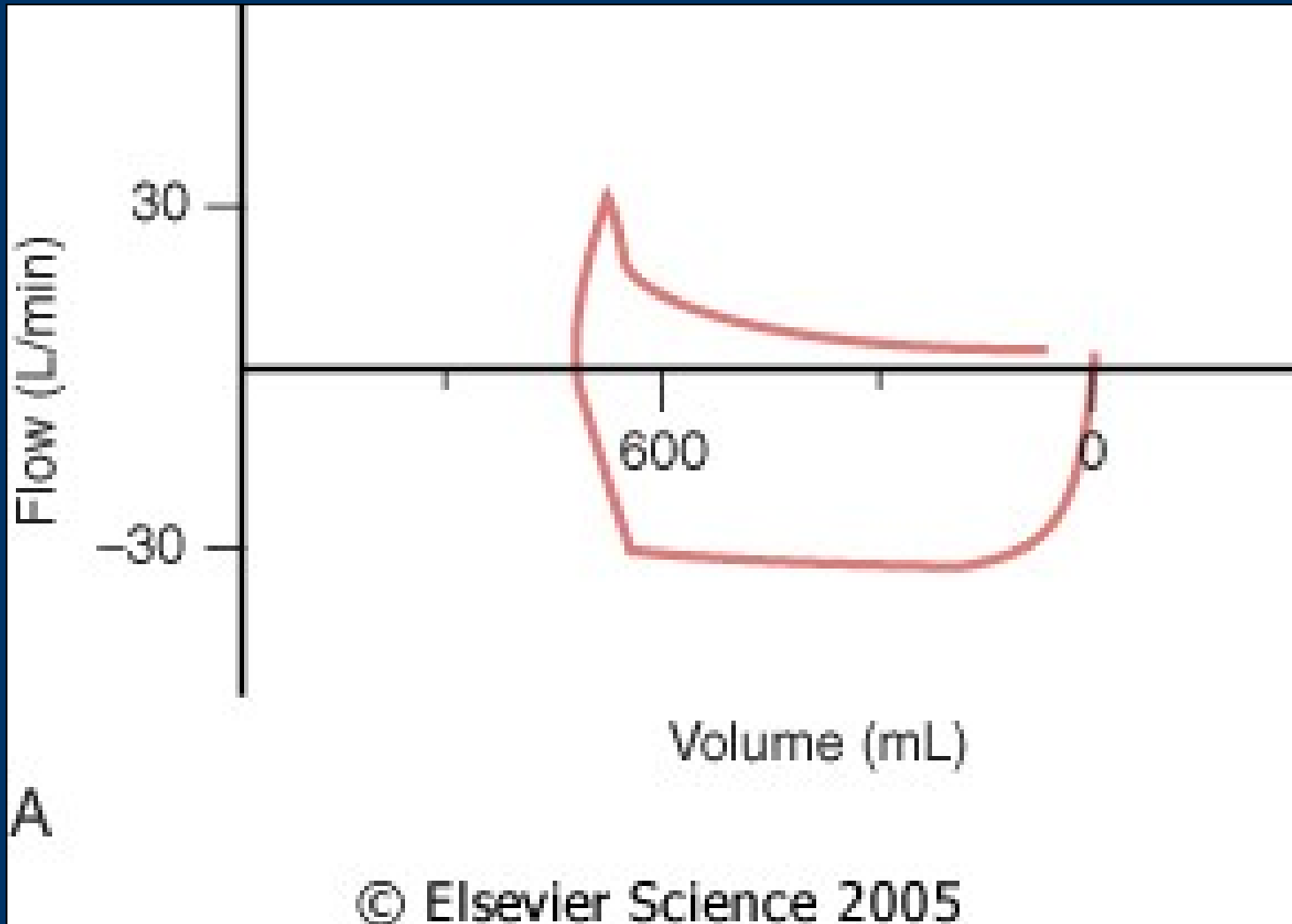

Figure 36-24 Flow (ordinate) versus volume (abscissa). A, Closed-chest positive-pressure ventilation under general anesthesia in a patient with severe airways obstruction and hyperinflation before surgery to reduce lung volume. The flow-volume curve shows inspiratory (negative) and expiratory (positive) flow on the ordinate, plotted clockwise from zero volume on the abscissa. Expiratory flow started with a sharp upward peak and then fell immediately to a low flow rate with convexity toward the volume axis, suggesting expiratory flow limitation. Expiratory flow rate was so low that inflation of the next positive-pressure breath was initiated before expiratory flow reached zero. Because expiratory flow continued up to this point, there must have been intrinsic positive end-expiratory pressure (PEEPi). B, A similar closed-check flow-volume curve after lung resection shows that the characteristic pattern of expiratory flow limitation has disappeared and that expiratory flow rate fell to zero before inflation started for the next breath (i.e., no suggestion of PEEPi). (Adapted from Dueck R: Assessment and monitoring of flow limitation and other parameters from flow/volume loops. *J Clin Monit Comput* 16:425, 2000.)

PV curve during capnoperitoneum

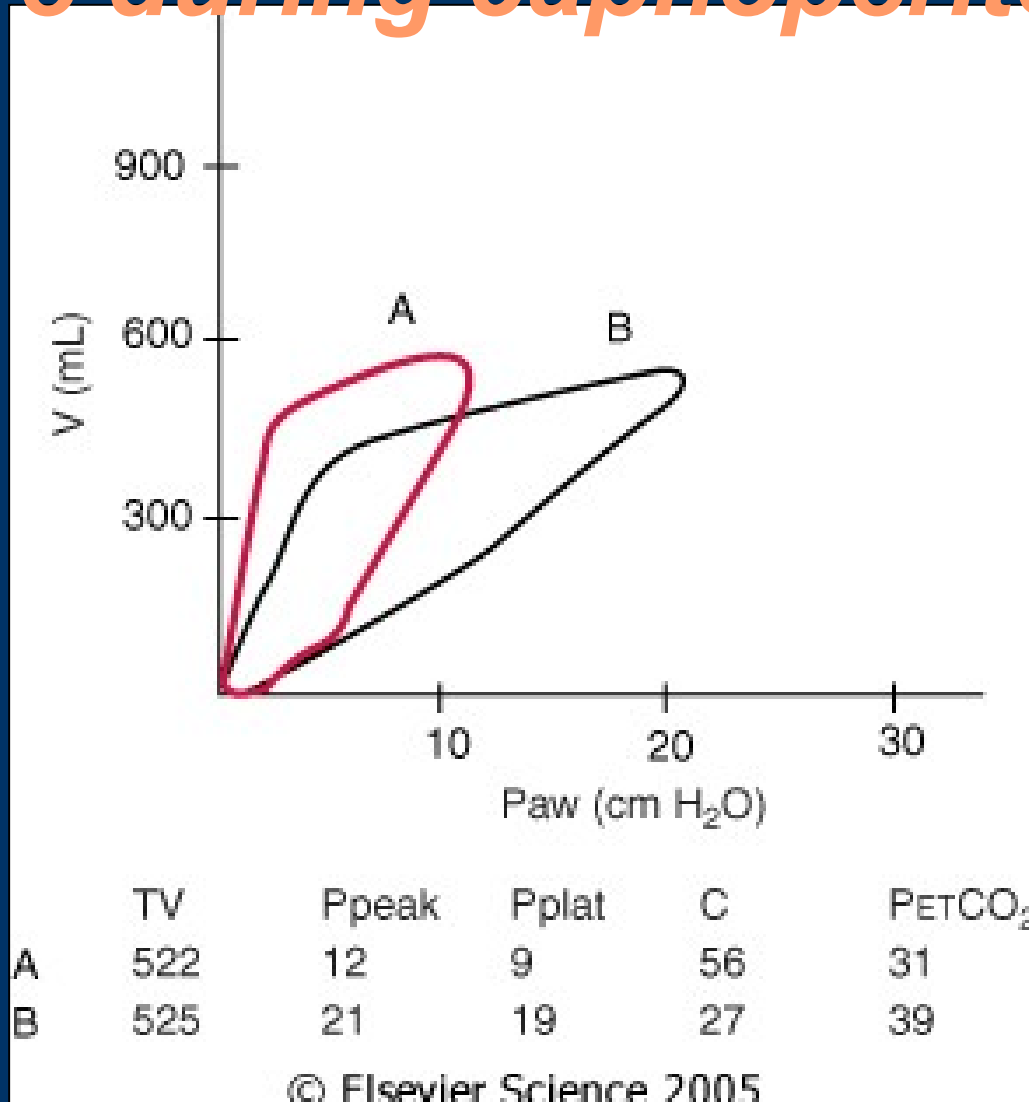
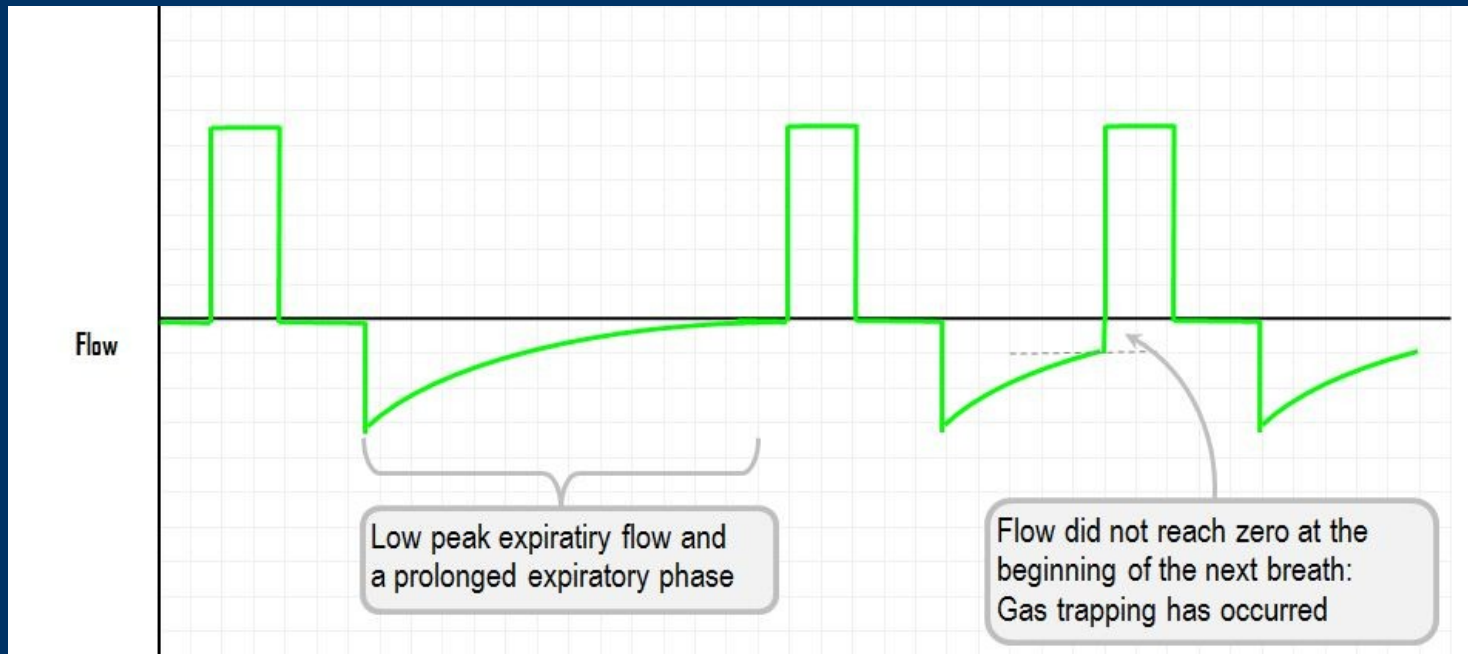
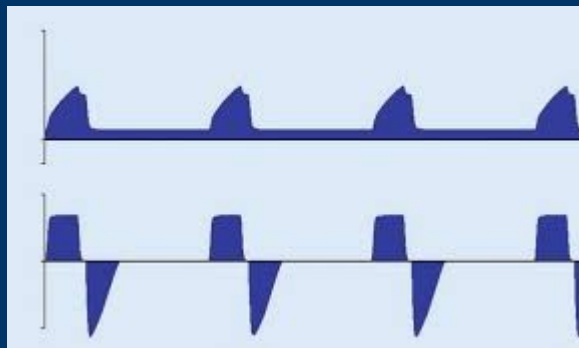

Figure 57-1 Change in total respiratory compliance during pneumoperitoneum for laparoscopic cholecystectomy. The intra-abdominal pressure was 14 mm Hg, and the head-up tilt was 10 degrees. The airway pressure (Paw) versus volume (V) curves and data were obtained from the screen of a Datex Ultima monitoring device. Curves are generated for before insufflation (A) and 30 minutes after insufflation (B). Values are given for tidal volume (TV, in mL); peak airway pressure (P_{peak}, in cm H₂O); plateau airway pressure (P_{plat}, in cm H₂O); total respiratory compliance (C, in mL/cm H₂O); and end-tidal carbon dioxide tension (P_{ET}CO₂, in mm Hg).

Flow in time



Pressure



Flow



Gas analyzers

Main-stream
stream

only CO₂, méně přesné

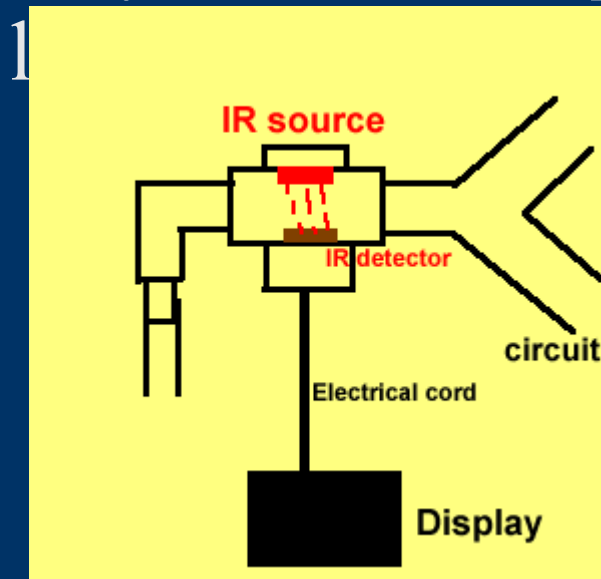

Side-

zpoždění

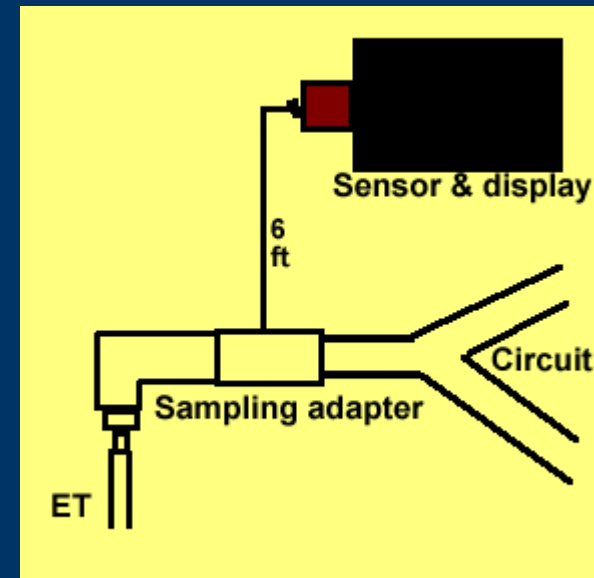

Monitoring of gas

Main-stream



Side-stream



O₂ paramagnetic gas (side stream monitor)

Minimal f_iO_2 : 21%
 safe 30%
 usually : up to 60%
 in case of hypoxia: 100%
 preoxygenation: 100%

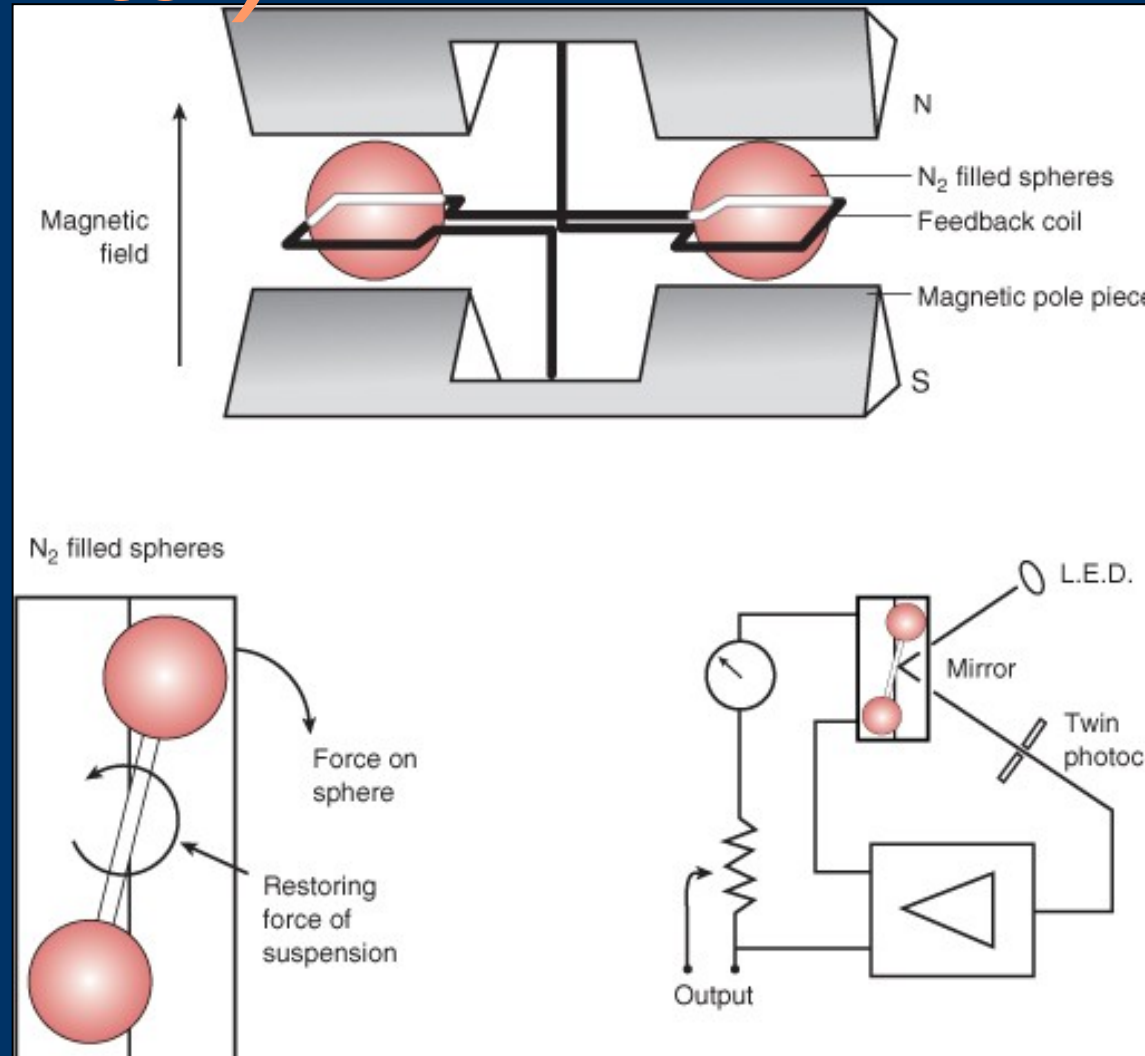
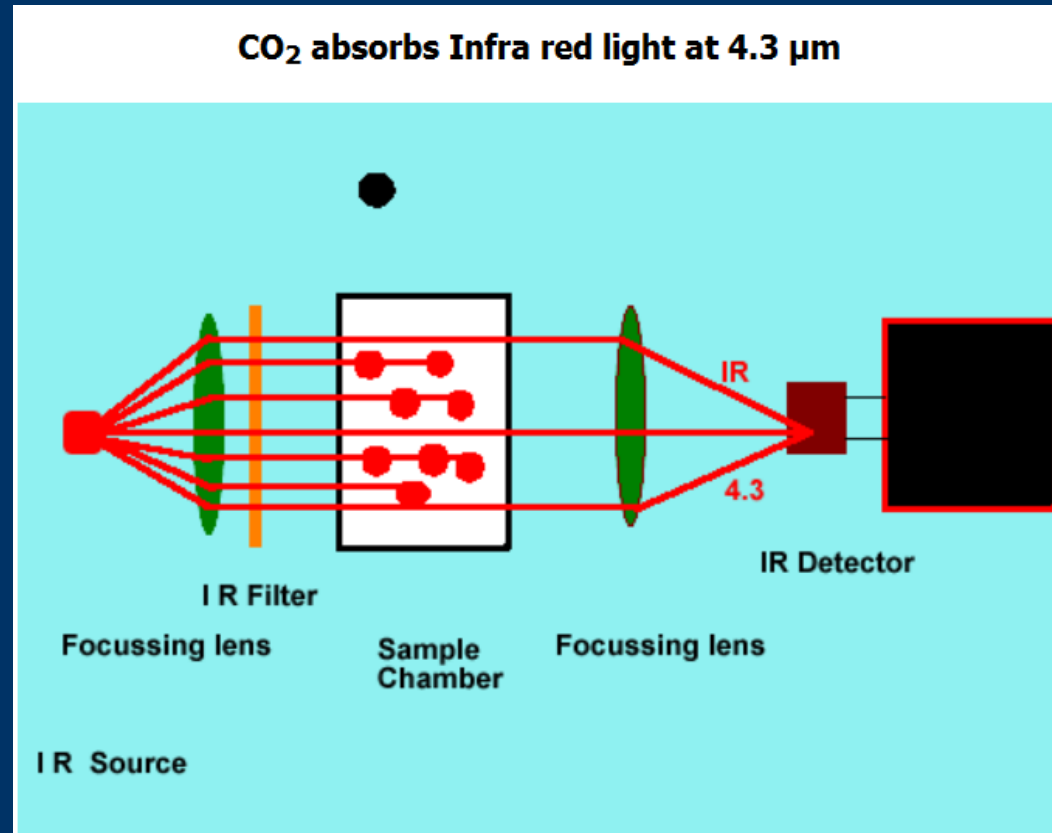

Figure 36-13 Paramagnetic oxygen analyzer. Two sealed spheres filled with nitrogen are suspended in a magnetic field. Nitrogen (N₂) is slightly diamagnetic, and the resting position of the beam is such that the spheres are displaced away from the strongest portion of the field. If the surrounding gas contains oxygen, the spheres are pushed further out of the field by the relatively paramagnetic oxygen. The magnitude of the torque is related to the paramagnetism of the gas mixture and is proportional to the partial pressure of oxygen (P_{O₂}). Movement of the dumbbell is detected by photocells, and a feedback current is applied to the coil encircling the spheres, returning the dumbbell to the zero position. The restoring current and output voltage are proportional to the P_{O₂}. (Courtesy of Servomex Co., Norwood, MA.)

Capnometr, Capnograph



- Infra-red Spectrography

<http://www.capnography.com/Physics/Physicsphysical.htm>

CO₂ absorbs Infra red light at 4.3 μm

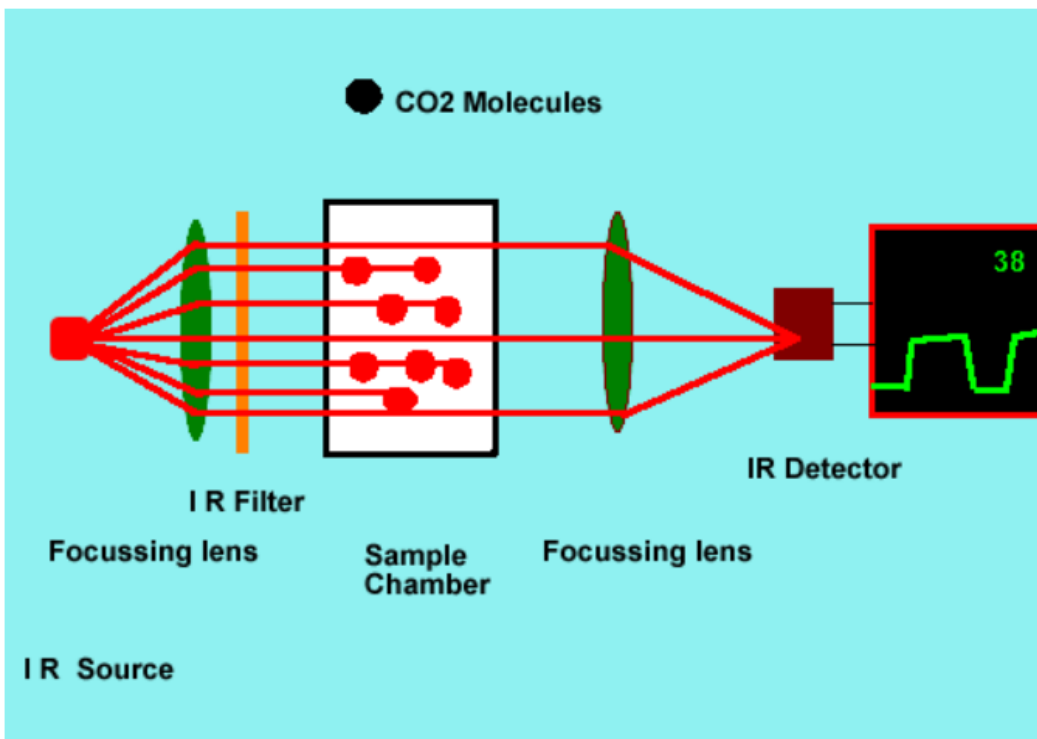

CO₂ emits IR radiation

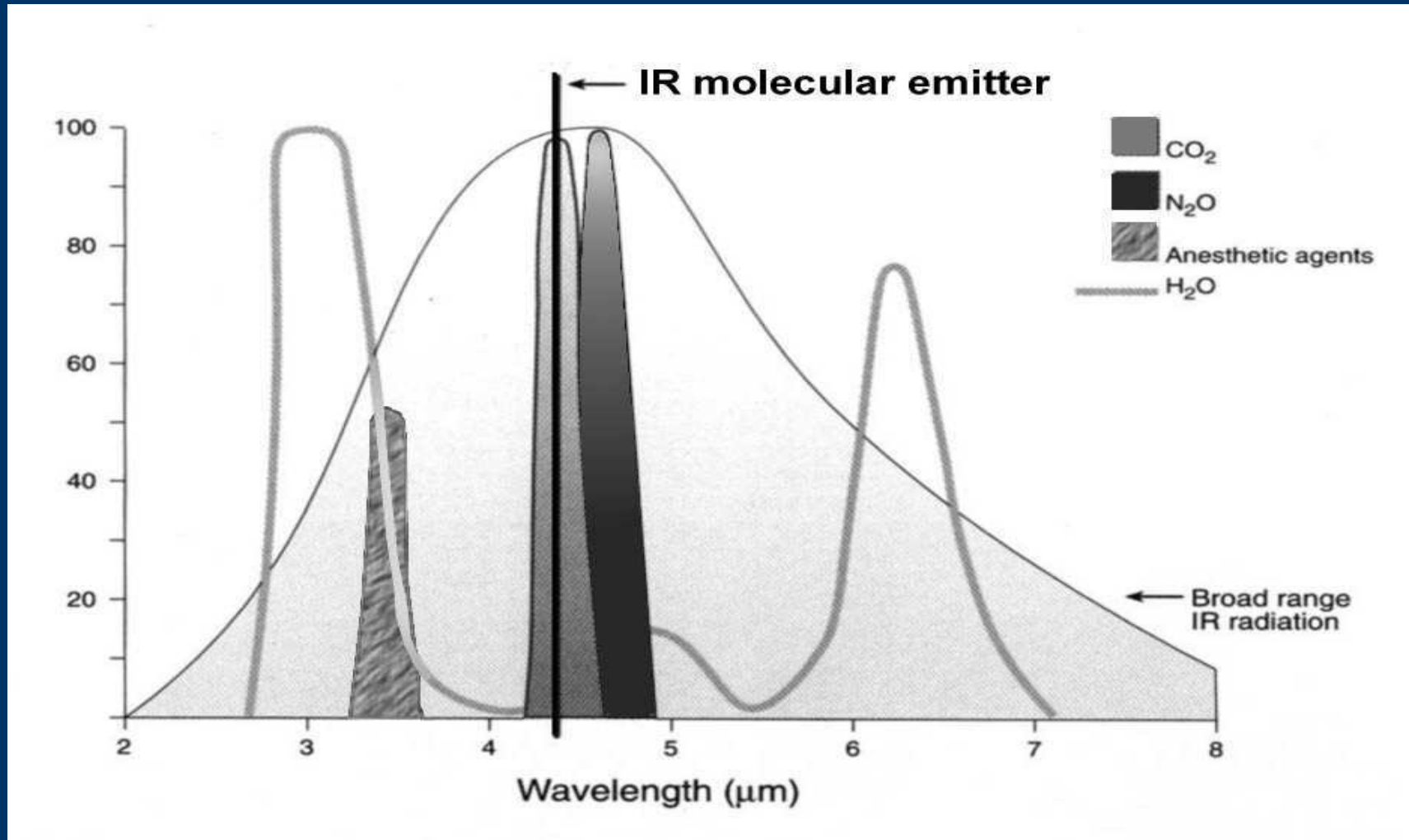

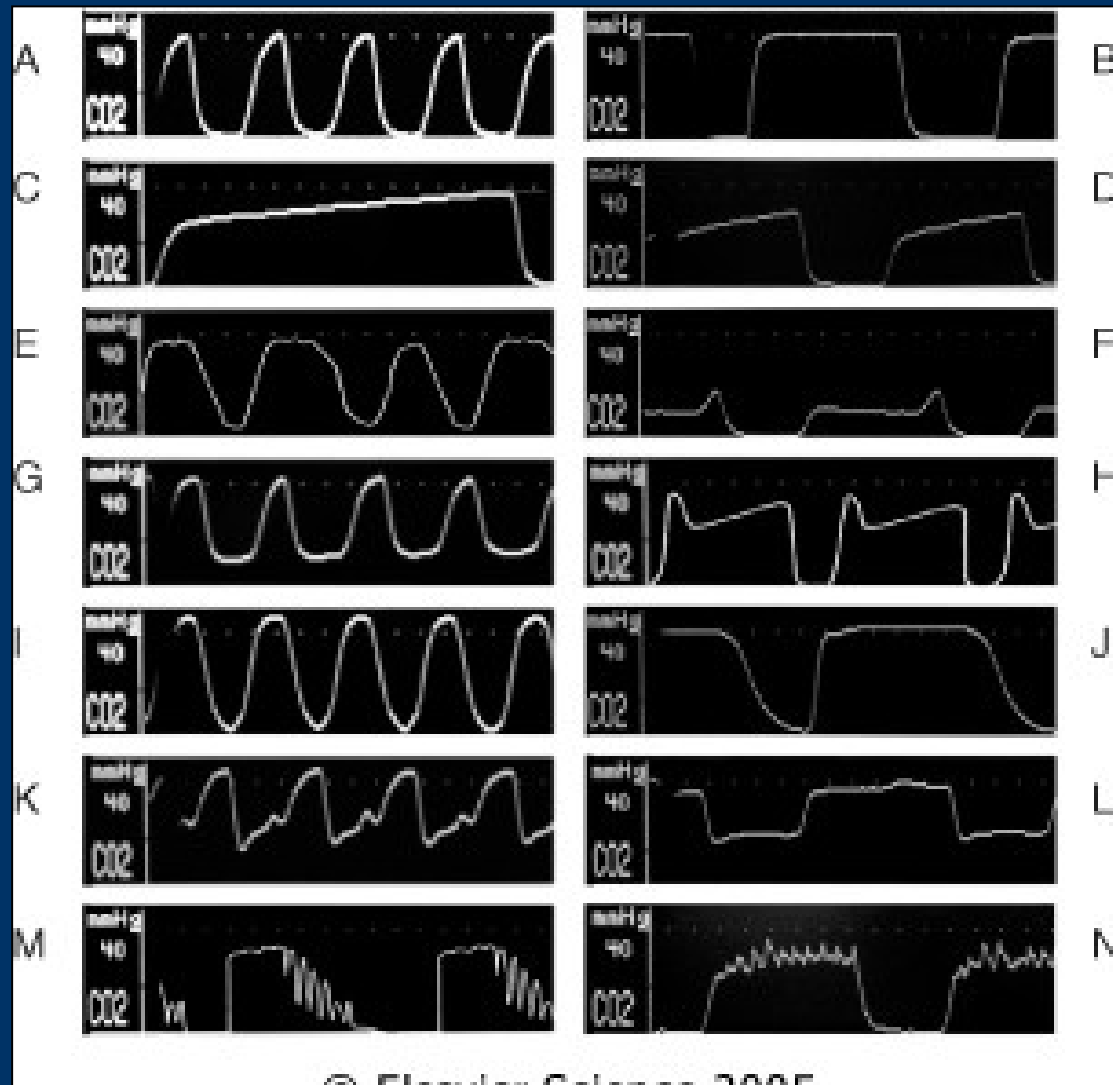
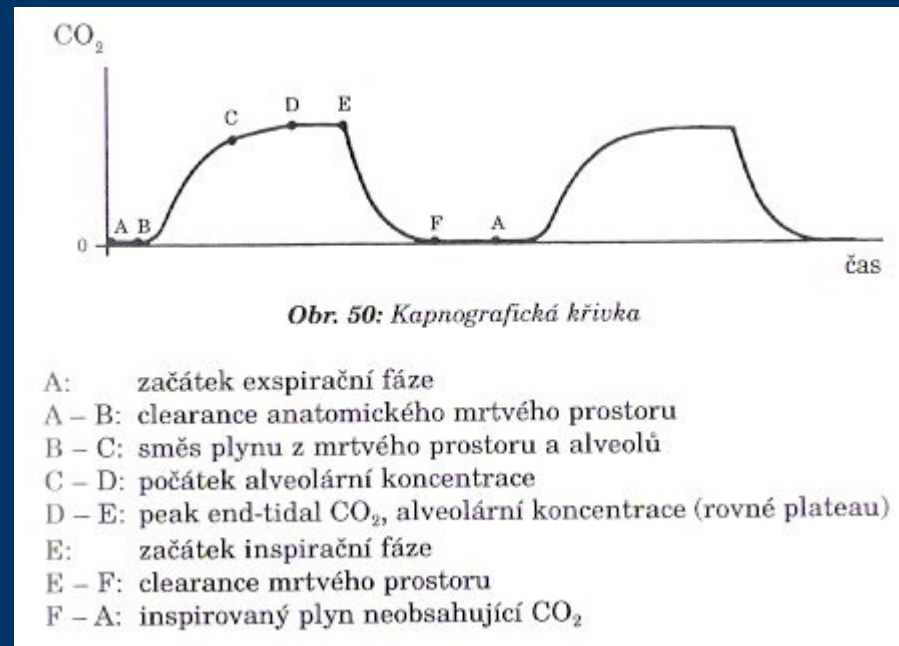

Figure 36-18 Examples of capnograph waves.

Figure 36-18 Examples of capnograph waves. A, Normal spontaneous breathing. B, Normal mechanical ventilation. C, Prolonged exhalation during spontaneous breathing. As CO₂ diffuses from the mixed venous blood into the alveoli, its concentration progressively rises (see Fig. 36-19). D, Increased slope of phase III in a mechanically ventilated patient with emphysema. E, Added dead space during spontaneous ventilation. F, Dual plateau (i.e. tails-up pattern) caused by a leak in the sample line.³²⁵ The alveolar plateau is artifactually low because of dilution of exhaled gas with air leaking inward. During each mechanical breath, the leak is reduced because of higher pressure within the airway and tubing, explaining the rise in the CO₂ concentration at the end of the alveolar plateau. This pattern is not seen during spontaneous ventilation because the required increase in airway pressure is absent. G, Exhausted CO₂ absorbent produces an inhaled CO₂ concentration greater than zero. H, Double peak for a patient with a single lung transplant. The first peak represents CO₂ from the transplanted (normal) lung. CO₂ exhalation from the remaining (obstructed) lung is delayed, producing the second peak. I, Inspiratory valve stuck open during spontaneous breathing. Some backflow into the inspired limb of the circuit causes a rise in the level of inspired CO₂. J, Inspiratory valve stuck open during mechanical ventilation. The "slurred" downslope during inspiration represents a small amount of inspired CO₂ in the inspired limb of the circuit. K and L, Expiratory valve stuck open during spontaneous breathing or mechanical ventilation. Inhalation of exhaled gas causes an increase in inspired CO₂. M, Cardiogenic oscillations, when seen, usually occur with sidestream capnographs for spontaneously breathing patients at the end of each exhalation. Cardiac action causes to-and-fro movement of the interface between exhaled and fresh gas. The CO₂ concentration in gas entering the sampling line therefore alternates between high and low values. N, Electrical noise resulting from a malfunctioning component. The seemingly random nature of the signal perturbations (about three per second) implies a nonbiologic cause.

Normal ventilation spont.

mandatory





Obr. 51a

- zakleMOVaná tracheální rourka
- závada na kapnografu



Obr. 51b

- částečná obstrukce ventilačního systému nebo únik v systému
- hyperventilace
- pokles metabolismu
- pokles tělesné teploty
- pokles plicní perfuze

c) Rychlý exponenciální pokles vydechované koncentrace CO_2 (obr. 51c)



Obr. 51f

- saturovaný CO_2 absorbér
- kondenzace vody v analyzátoru
- chyba kalibrace
- zpětné vdechování objemu mrtvého prostoru
- vadná expirační chlopeč

obstruction of airway

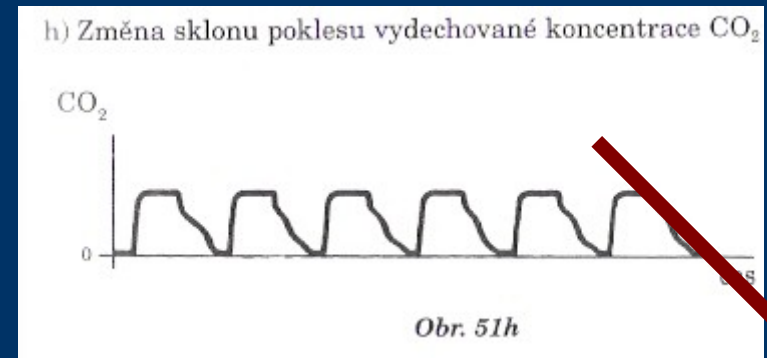
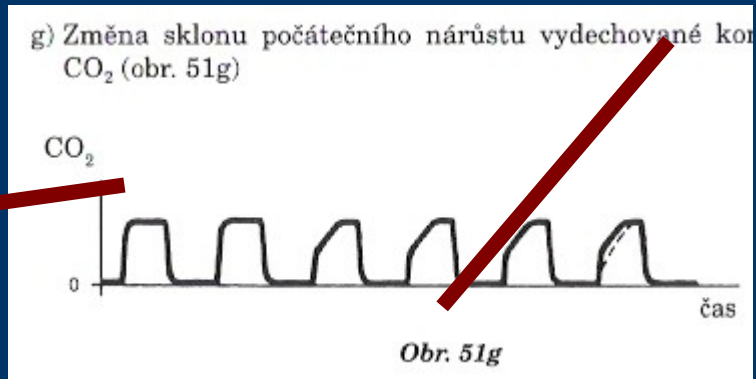

expirium

inspirium

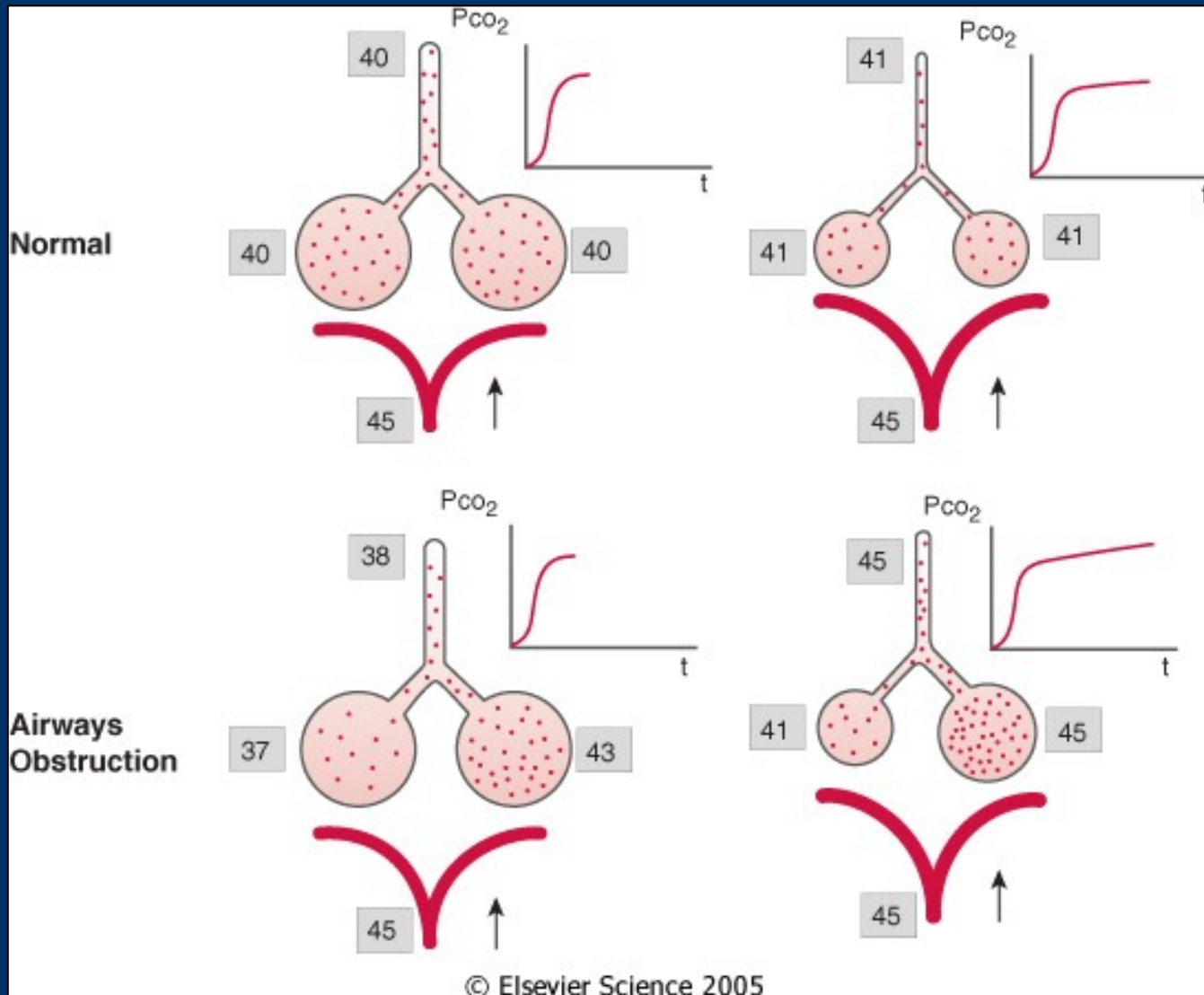

Figure 36-19 Mechanisms of airways obstruction producing an upsloping phase III capnogram. In a normal, healthy person (upper panel), there is a narrow range of $[\dot{V}_a]/[\dot{Q}]$ ratios with values close to 1. Gas exchange units therefore have similar P_{CO_2} and tend to empty synchronously, and the expired P_{CO_2} remains relatively constant. During the course of exhalation, the alveolar P_{CO_2} slowly rises as CO_2 continuously diffuses from the blood. This causes a slight increase in P_{CO_2} toward the end of expiration, and this increase can be pronounced if the exhalation is prolonged (see Fig. 36-18C). In a patient with diffuse airways obstruction (lower panel), the airway pathology is heterogeneous, with gas exchange units having a wide range of $[\dot{V}_a]/[\dot{Q}]$ ratios. Well-ventilated gas exchange units, with gas containing a lower P_{CO_2} , empty first; poorly ventilated units, with a higher P_{CO_2} , empty last. In addition to the continuous rise in P_{CO_2} mentioned previously, there is a progressive increase caused by asynchronous exhalation.

CO₂ during Capnoperitoneum

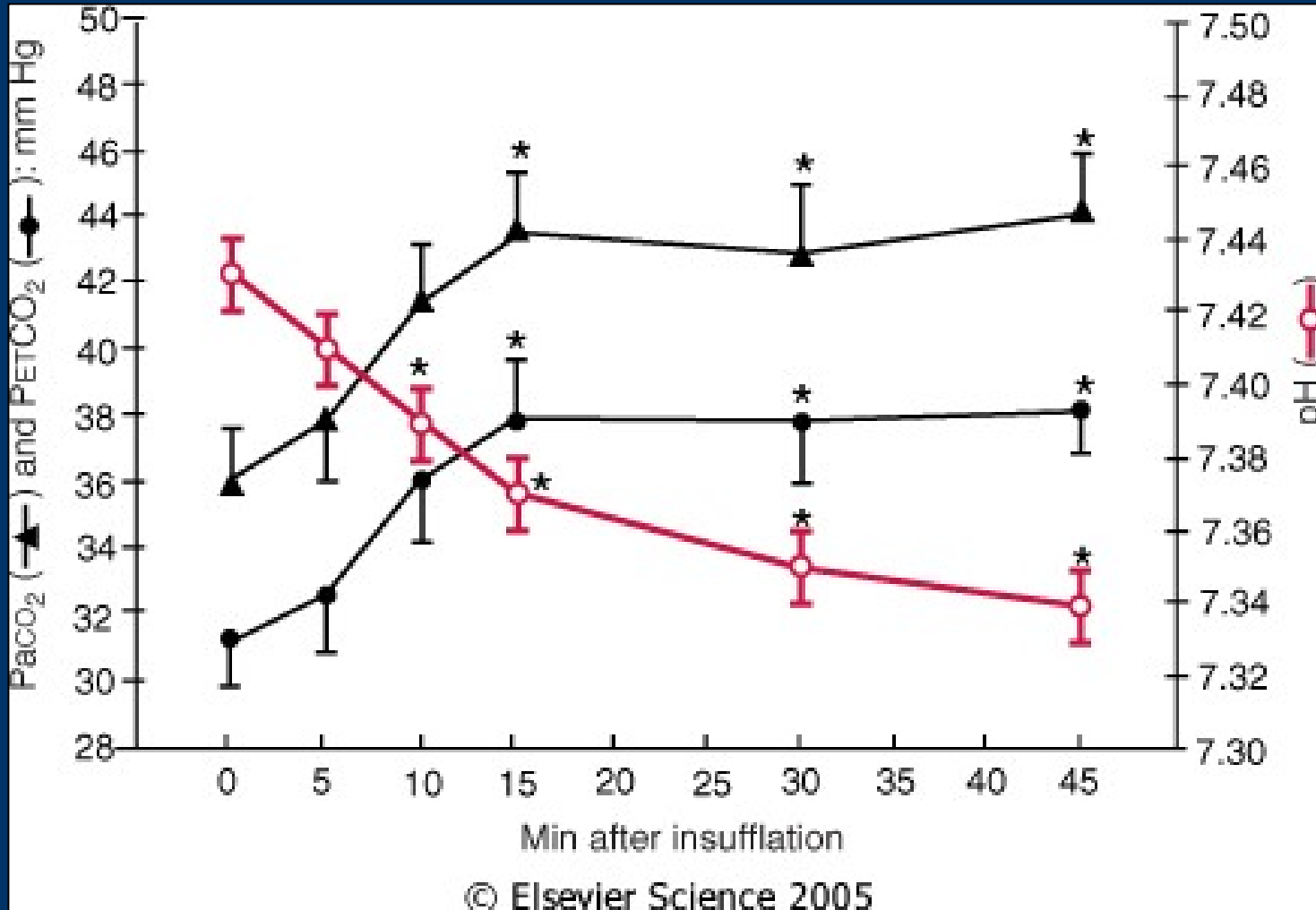

Figure 57-2 Ventilatory changes (pH, PaCO₂, and PetCO₂) during CO₂ pneumoperitoneum for laparoscopic cholecystectomy. For 13 American Society of Anesthesiologists (ASA) class I and II patients, minute ventilation was kept constant at 100 mL/kg/min with a respiratory rate of 12 per minute during the study. Intra-abdominal pressure was 14 mm Hg. Data are given as the mean \pm SEM. *, P < .05 compared with time 0.

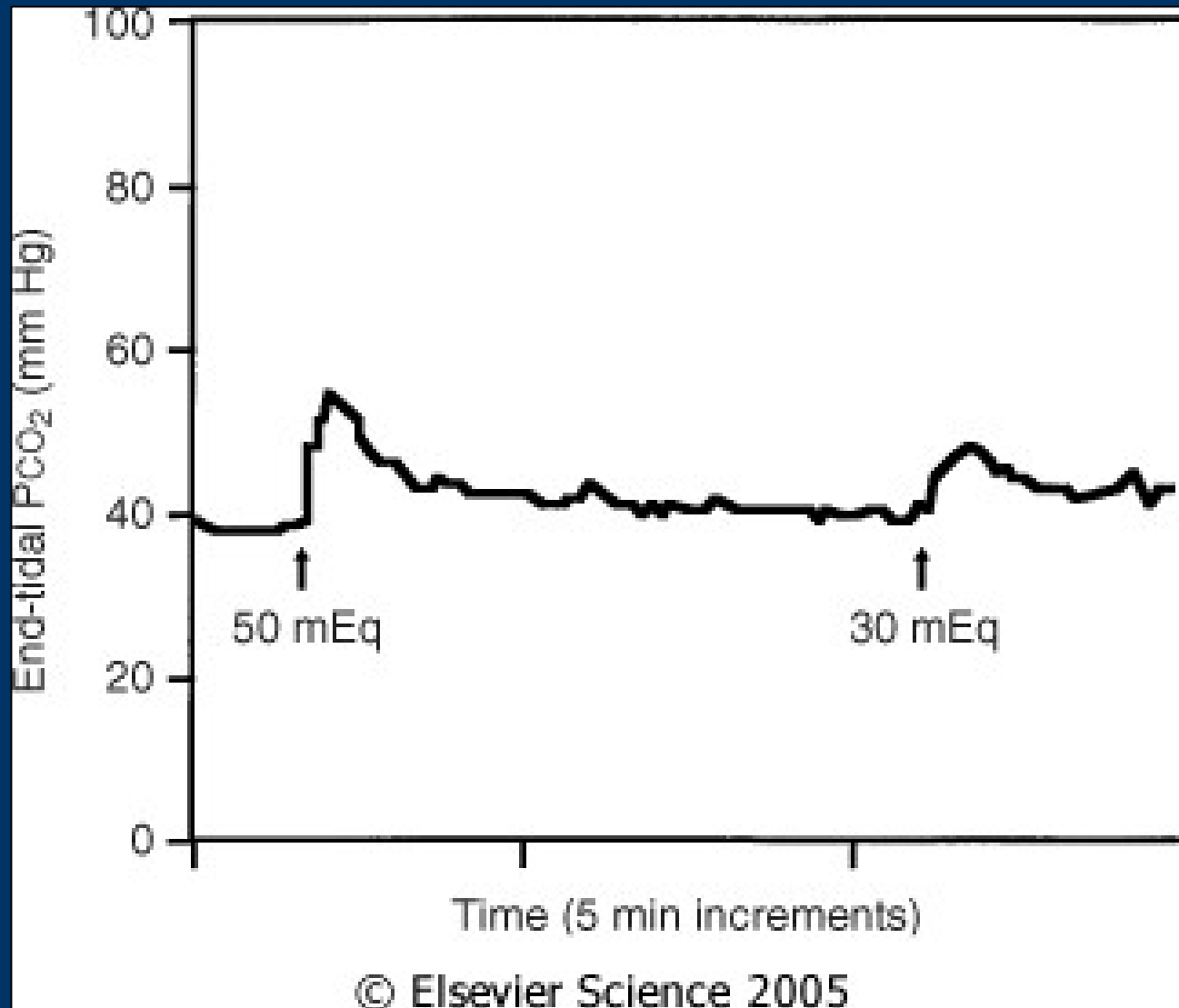

Figure 36-20 The effect of NaHCO₃ administration on end-tidal Pco₂. A continuous tracing of end-tidal Pco₂ is shown as a function of time. Intravenous administration of 50 mEq followed by 30 mEq of NaHCO₃ results in an abrupt increase in expired CO₂ because of neutralization of bicarbonate by hydrogen ions.

Capnograph

Sudden fall to 0:

- no ventilation - obstruction
- error

gradual decrease:

- partial obstruction
- hyperventilation
- decrease of metabolism
- decrease of perfusion of the lung

0 etCO₂

- intubation to oesophagus
-
-

Body temperature

- > 60 minut in anesthesia
- children
- aktive warming – bed, warm air

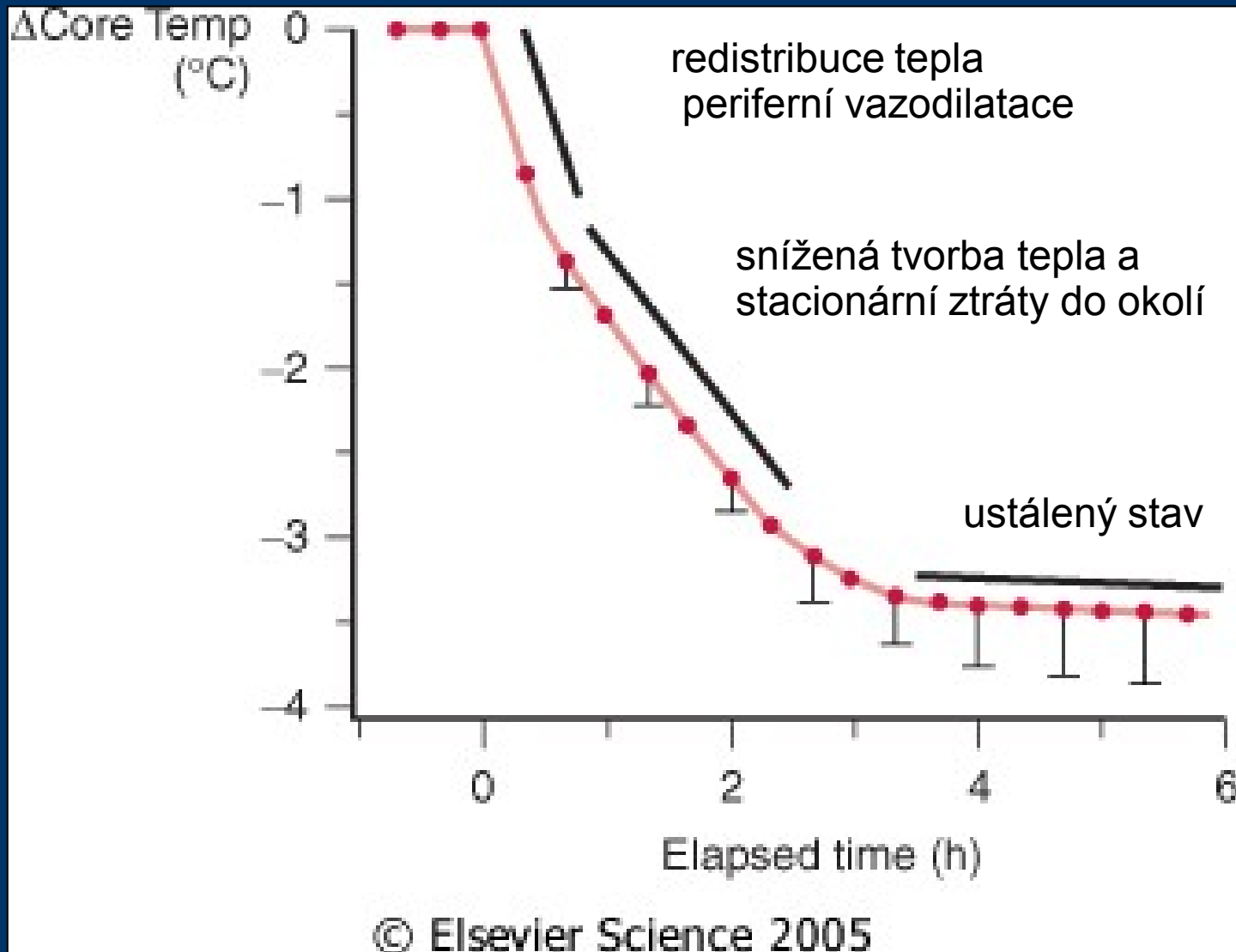
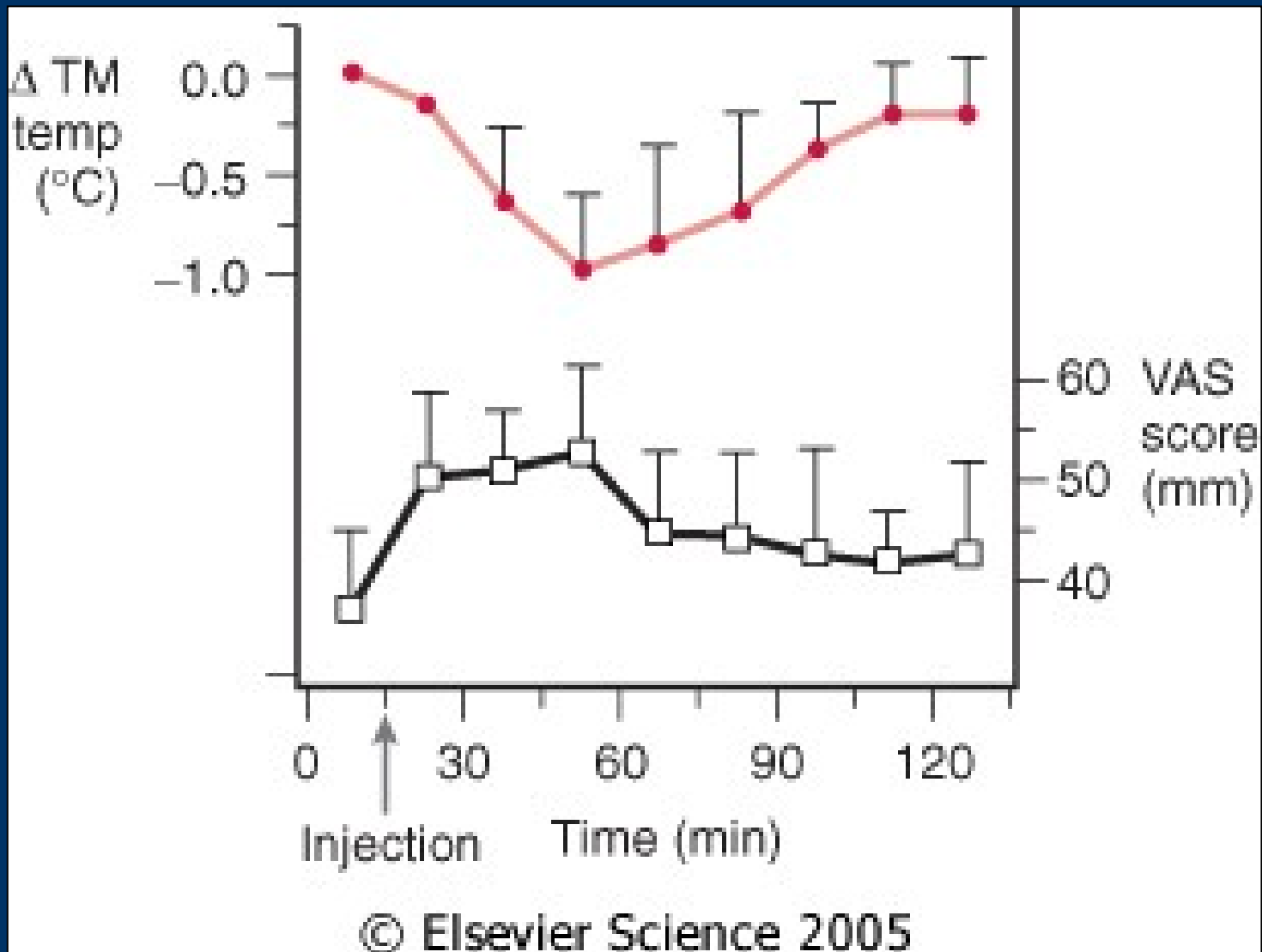

Figure 40-7 Hypothermia during general anesthesia develops with a characteristic pattern. An initial rapid decrease in core temperature results from a core-to-peripheral redistribution of body heat. This redistribution is followed by a slow, linear reduction in core temperature that results simply from heat loss exceeding heat production. Finally, core temperature stabilizes and subsequently remains virtually unchanged. This plateau phase may be a passive thermal steady state or might result when sufficient hypothermia triggers thermoregulatory vasoconstriction. Results are presented as means \pm SD.



15 minutes po EPI anestezii pokles teploty jádra, vzestup pocitu tepelné pohody (visual analog scale -VAS). Interestingly, however, maximal thermal comfort coincided with the minimum core temperature. Tympanálně měřená teplota. (Redrawn with modification from Sessler DI, Ponte J: Shivering during epidural anesthesia. *Anesthesiology* 72:816-821, 1990.)

Monitoring of muscle block



- single-twitch
- train-of-four (TOF)
- tetanic, post-tetanic count (PTC)
- double-burst stimulation (DBS)



Single-twitch

- 1 Hz .. 0,1 Hz, continually

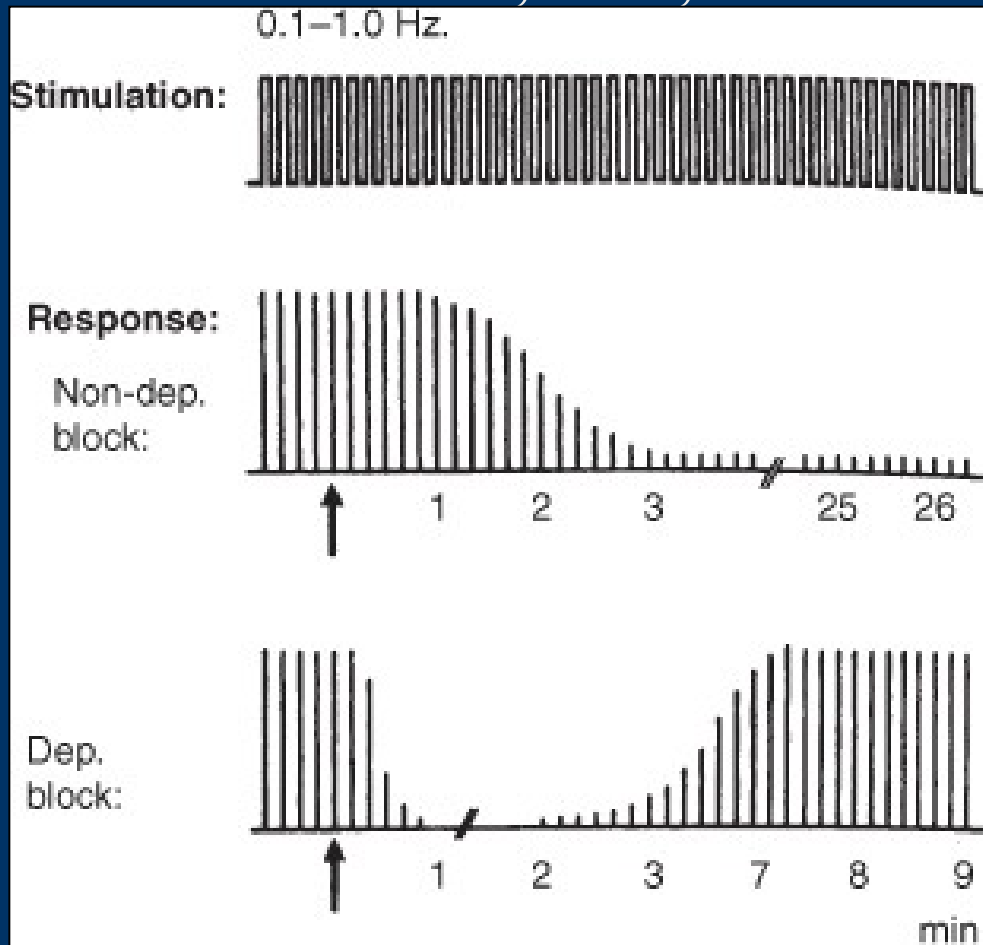

Figure 39-1 Pattern of electrical stimulation and evoked muscle responses to single-twitch nerve stimulation (at frequencies of 0.1 to 1.0 Hz) after injection of nondepolarizing (Non-dep) and depolarizing (Dep) neuromuscular blocking drugs (arrows). Note that except for the difference in time factors, no differences in the strength of the evoked responses exist between the two types of block.

TOF

- 4 stimul á 0,5s (2Hz)

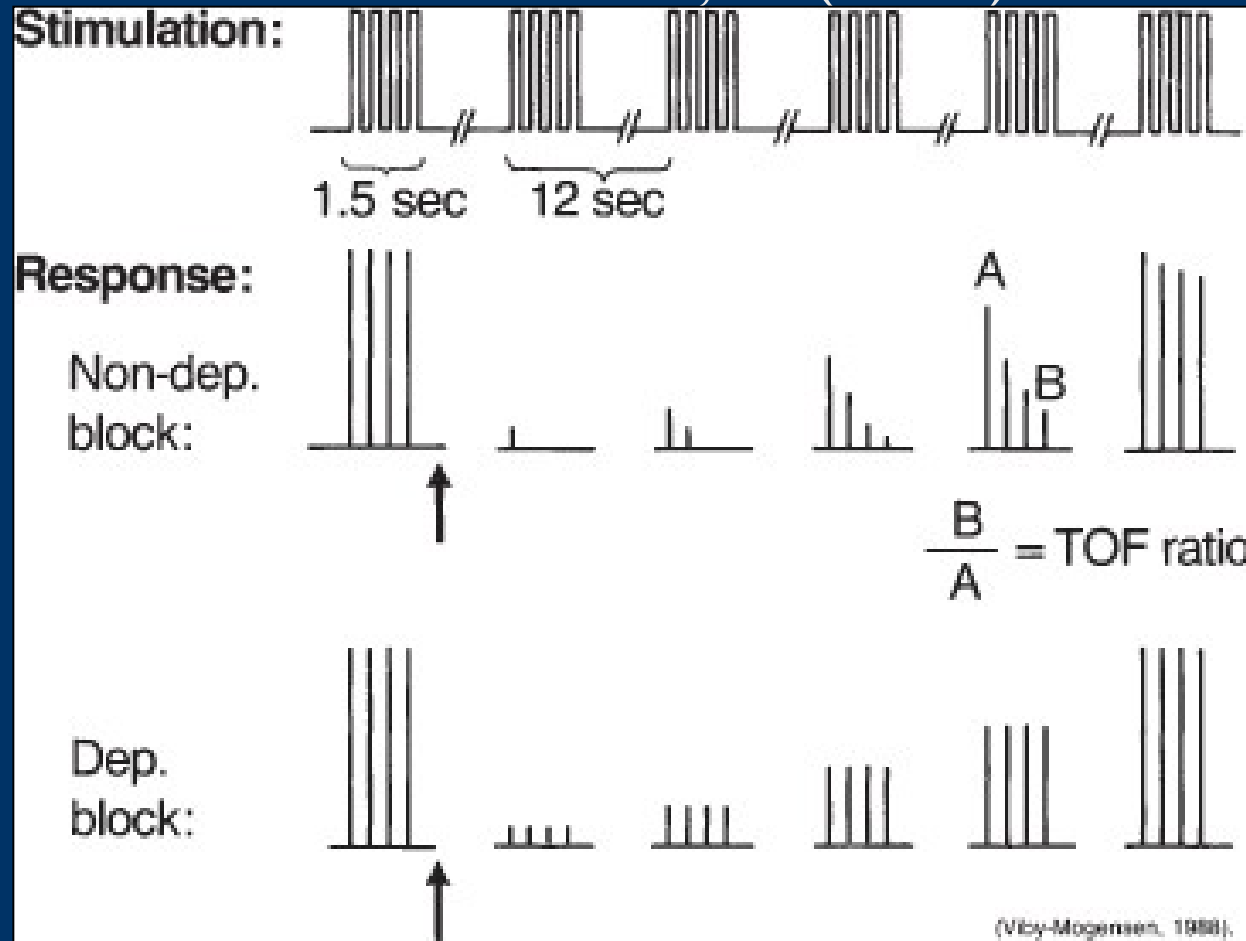
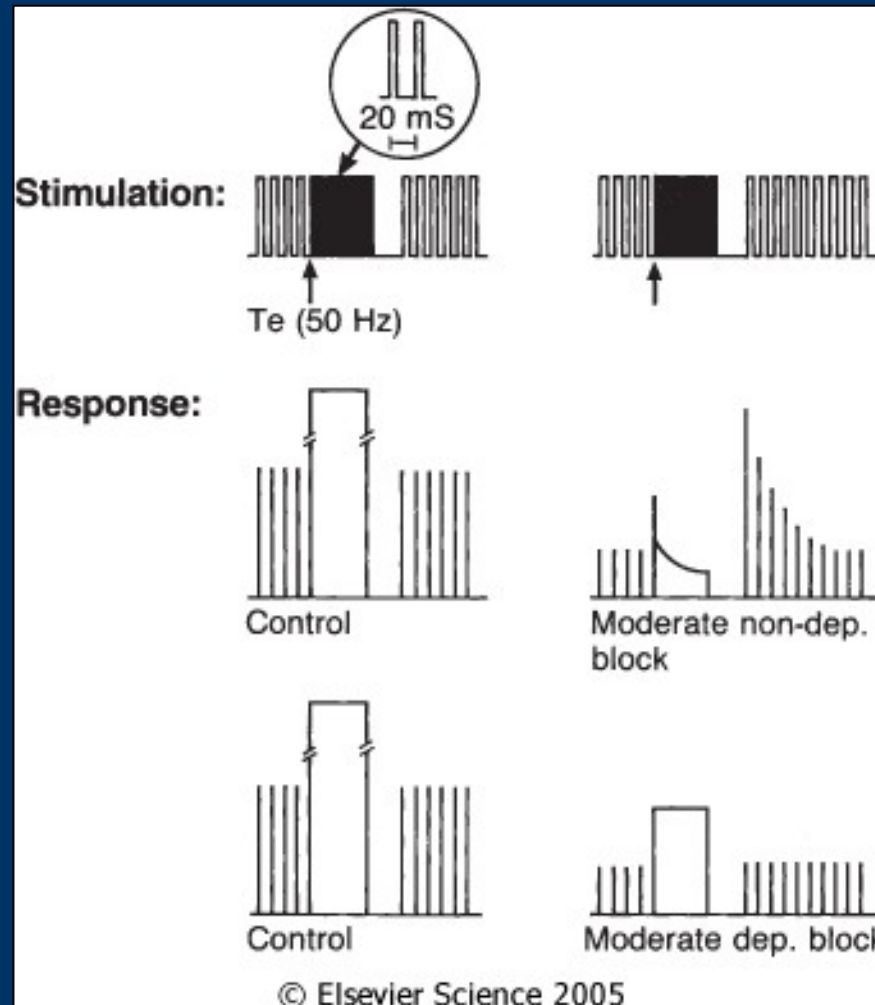

Figure 39-2 Pattern of electrical stimulation and evoked muscle responses to TOF nerve stimulation before and after injection of nondepolarizing (Non-dep) and depolarizing (Dep) neuromuscular blocking drugs (arrows).

Tetanic stimulation

- painfull;
- 50Hz na 5s





Posttetanická facilitace

Figure 39-3 Pattern of stimulation and evoked muscle responses to tetanic (50-Hz) nerve stimulation for 5 seconds (Te) and post-tetanic stimulation (1.0-Hz) twitch. Stimulation was applied before injection of neuromuscular blocking drugs and during moderate nondepolarizing and depolarizing blocks. Note fade in the response to tetanic stimulation, plus post-tetanic facilitation of transmission during nondepolarizing blockade. During depolarizing blockade, the tetanic response is well sustained and no post-tetanic facilitation of transmission occurs.

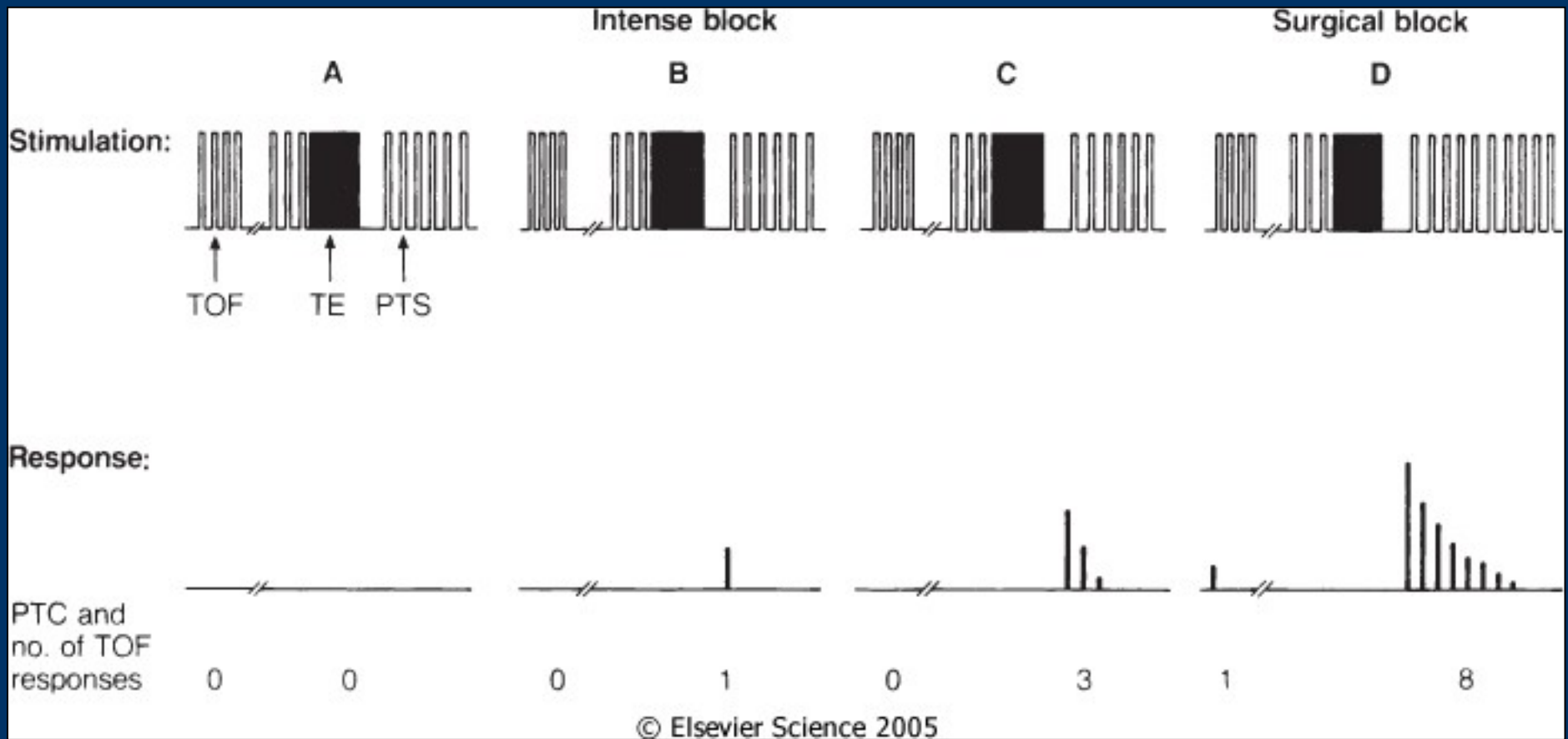

Figure 39-4 Pattern of electrical stimulation and evoked muscle responses to TOF nerve stimulation, 50-Hz tetanic nerve stimulation for 5 seconds (TE), and 1.0-Hz post-tetanic twitch stimulation (PTS) during four different levels of nondepolarizing neuromuscular blockade. During very intense blockade of the peripheral muscles (A), no response to any of the forms of stimulation occurs. During less pronounced blockade (B and C), there is still no response to stimulation, but post-tetanic facilitation of transmission is present. During surgical block (D), the first response to TOF appears and post-tetanic facilitation increases further. The post-tetanic count (see text) is 1 during intense block (B), 3 during less intense block (C), and 8 during surgical block (D).

Double-burst stimulation

- 2 short sequences of 50-Hz tetanic stimulation, separated by 750 ms pause
 - nonrelaxed muscle – 2 equal contractions
 - partially relaxed m. – 2nd contr. is weaker
-
-

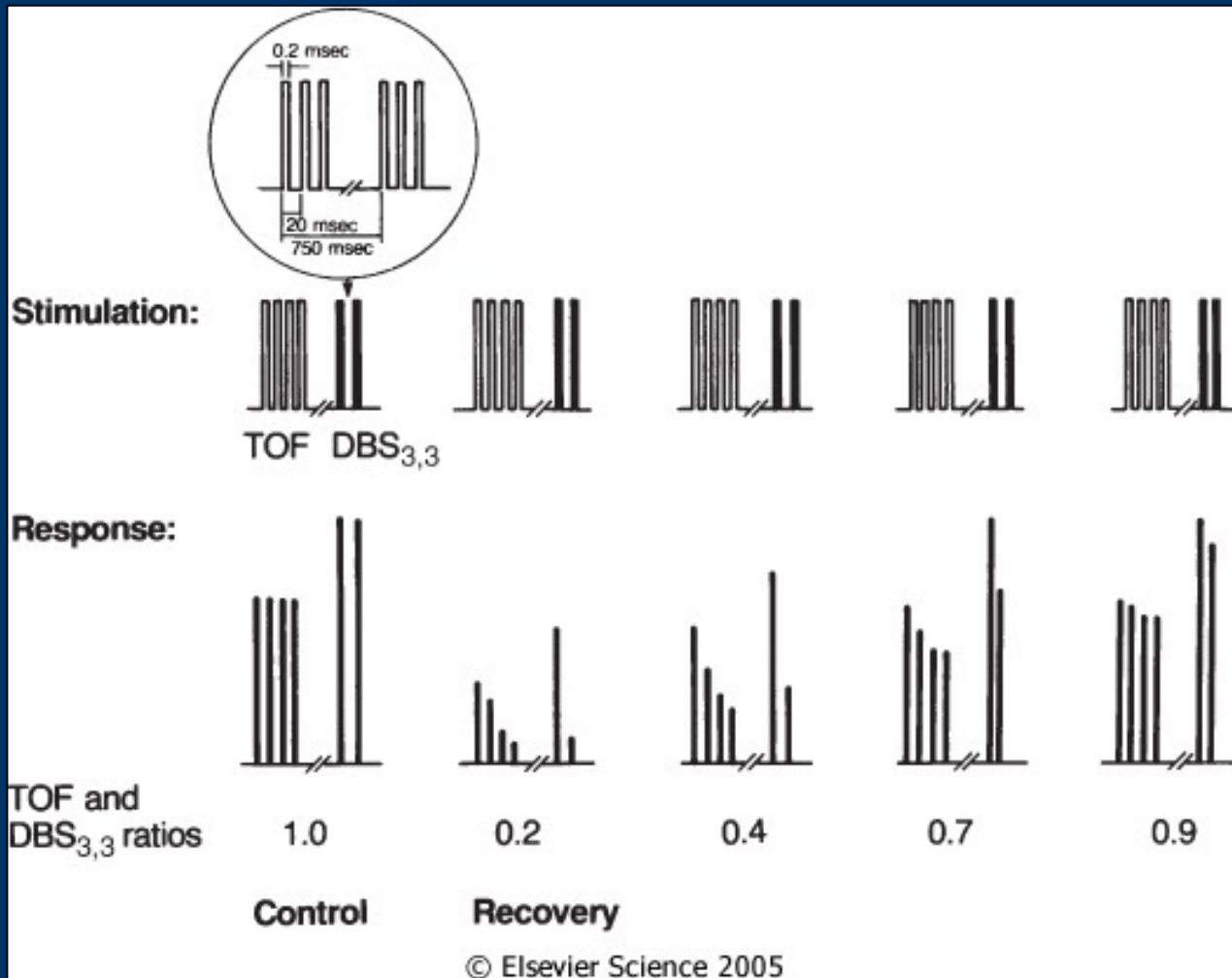

Figure 39-7 Pattern of electrical stimulation and evoked muscle responses to TOF nerve stimulation and double-burst nerve stimulation (i.e., three impulses in each of two tetanic bursts, DBS_{3,3}) before injection of muscle relaxants (control) and during recovery from nondepolarizing neuromuscular blockade. TOF ratio is the amplitude of the fourth response to TOF divided by the amplitude of the first response. DBS_{3,3} ratio is the amplitude of the second response to DBS_{3,3} divided by the amplitude of the first response. (See text for further explanation.)

Everything else

- pressure in pipelines
- ventilation (bellows is going up with „click“)



Awarrenes during GA

- to remember moments of GA
- 0,1 – 0,2% population (1:800)
 - Extracorporal circulation
 - Caesarean operation
 - trauma

report:

- filling of weakness, unable to move
 - conversation
 - anxiety, pain, powerlessness
-
-

Bispectral index monitoring to prevent awareness during anaesthesia: the B-Aware randomised controlled trial

*P S Myles, K Leslie, J McNeil, A Forbes, M T V Chan, for the B-Aware trial group**

THE LANCET • Vol 363 • May 29, 2004 • www.thelancet.com

Whipple's procedure	Heard the anaesthetist say "the pressure is really low", and the surgeon respond "can you do something about it?". Recalls movement and pain within the abdomen. Tried to move, but was unable to (1=ND, 2=Y, 3=Y)
Laparotomy, ruptured hepatoma	Remembers going "half asleep", then hearing shouting ("...do things faster... because things are crashing..."). Felt anxious, dizzy, and breathless, and could not move. Some abdominal pain (1=ND, 2=Y, 3=D)
Anterior resection	Heard noises during surgery; tried to move but was unable (1=Y, 2=Y, 3=Y)

Until 30 days after enrolment, the number of patients who reported awareness under anaesthesia was significantly smaller in the BIS group than in the routine care group (2 [0·17%] *vs* 11 [0·91%]; OR 0·18; 95% adjusted CI 0·02–0·84; $p=0\cdot022$); the absolute reduction in the risk of awareness was 0·74%. The number needed to treat (NNT) was 138 (95% CI 77–641). The benefit of

Monitorace hloubky bezvědomí

- EEG – mathematics → BIS .. Level of awareness 100 .. 0

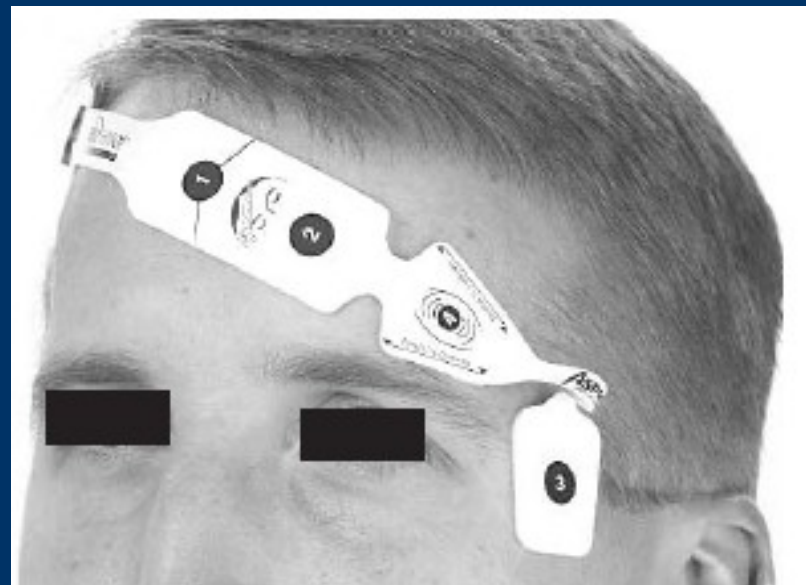

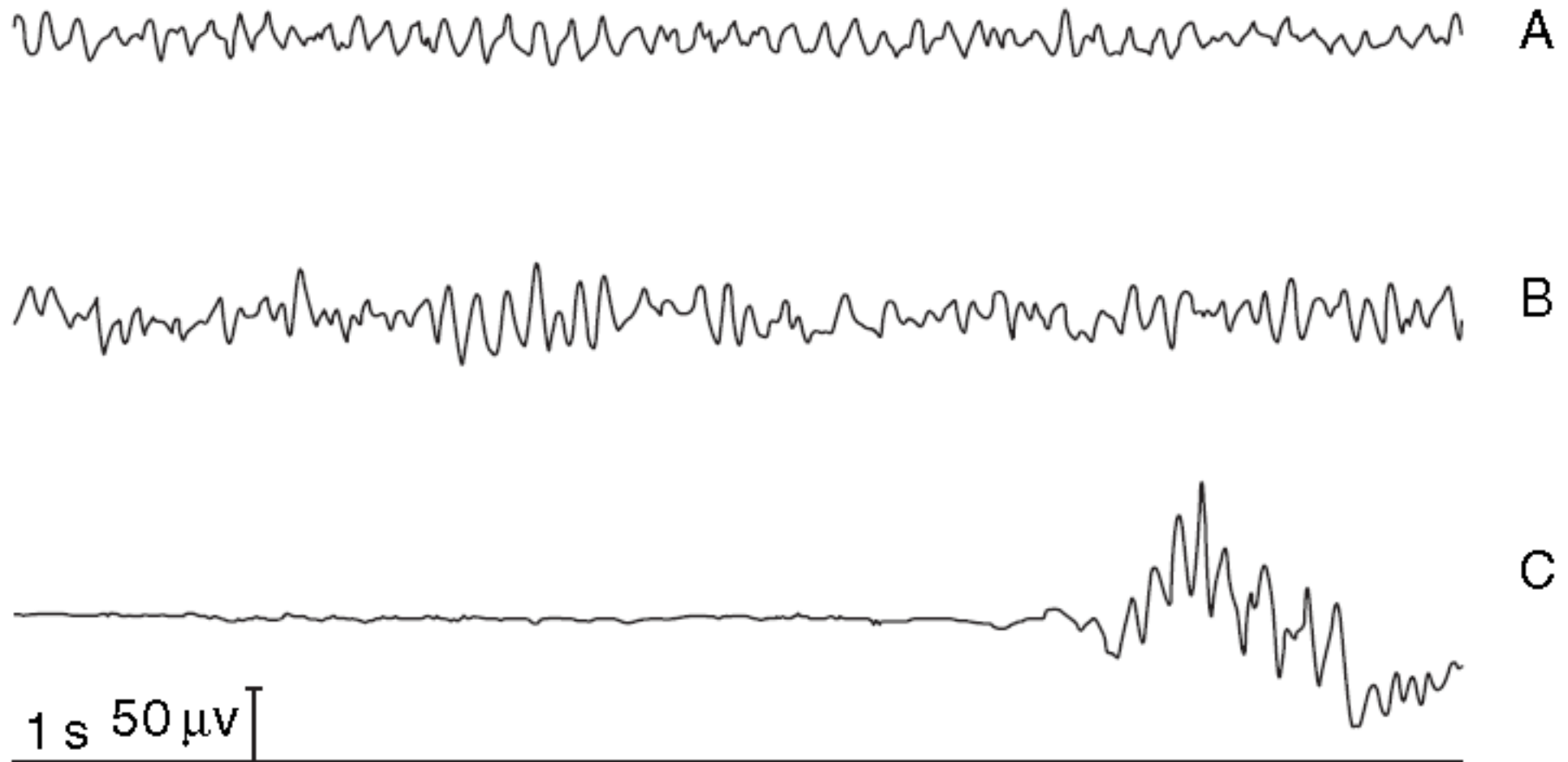

Fig 5 Raw EEG waves. A, awake state; B, β -activation; C, burst suppression.

Next? ... farmakology

