

Immunoglobulins – structure and function

Production of immunoglobulins

Genetic determination of immunoglobulin production

Clonal selection theory

Antigen and epitope

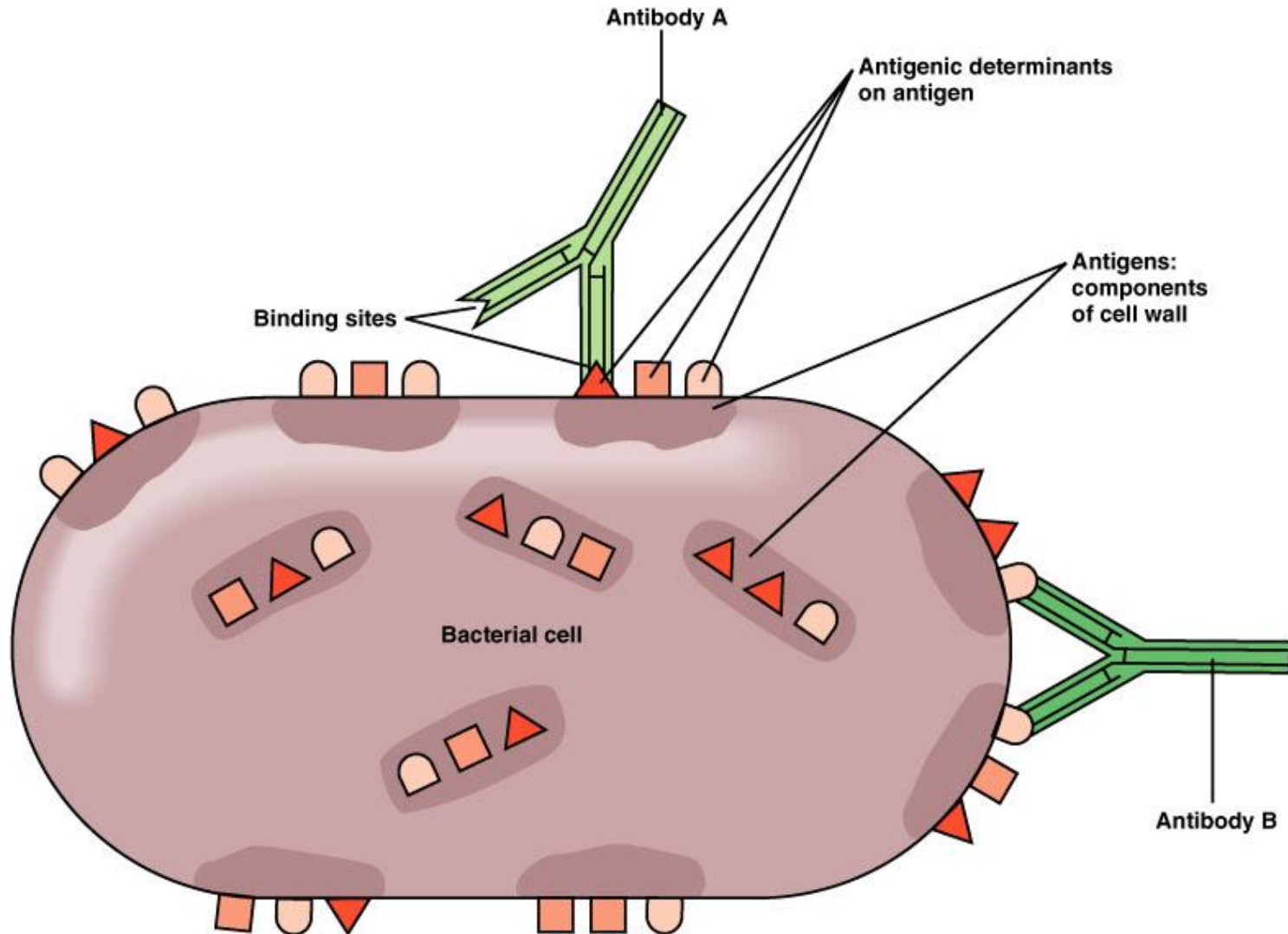

Distribution of the major human immunoglobulins

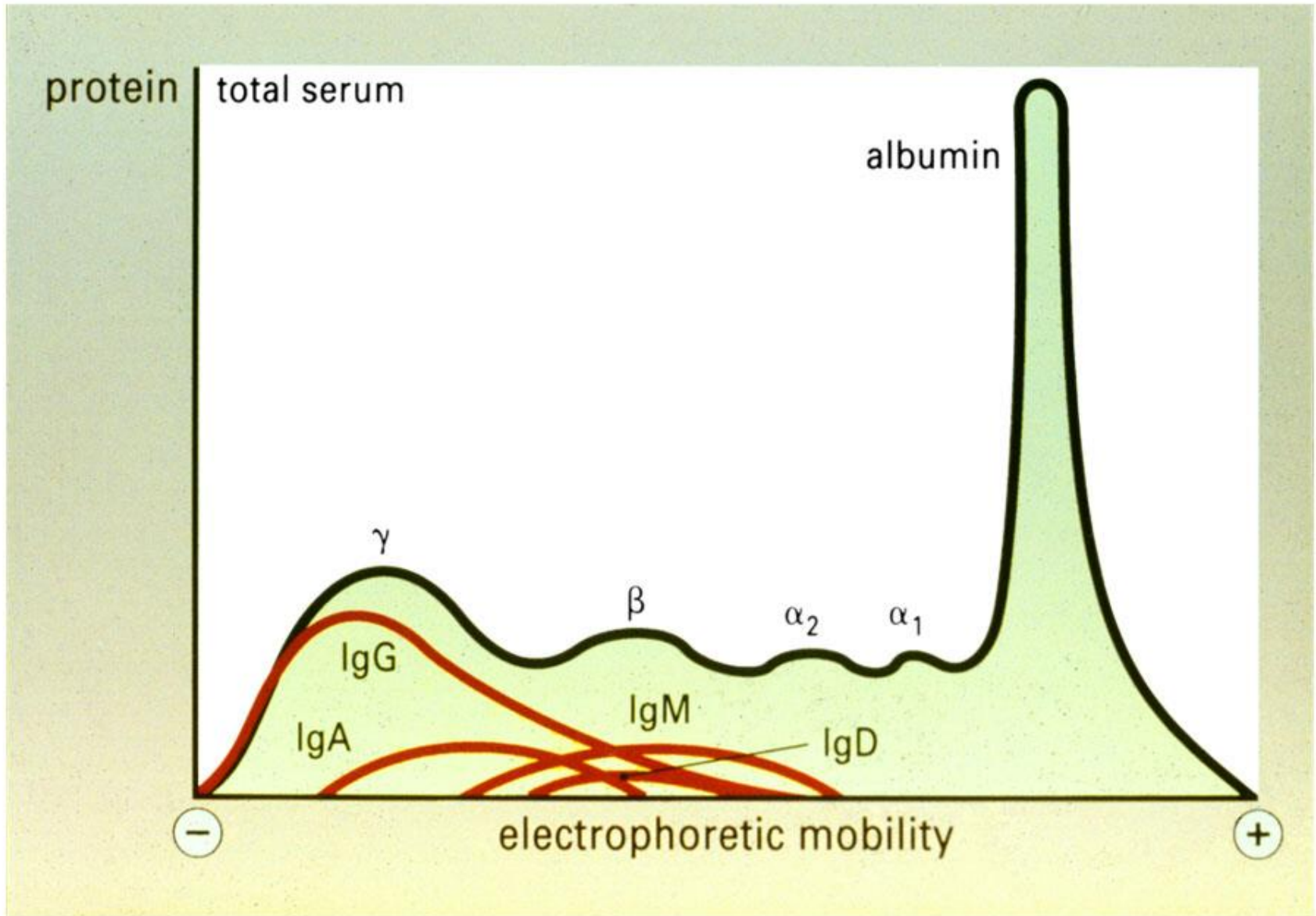

The basic chain structure of immunoglobulins

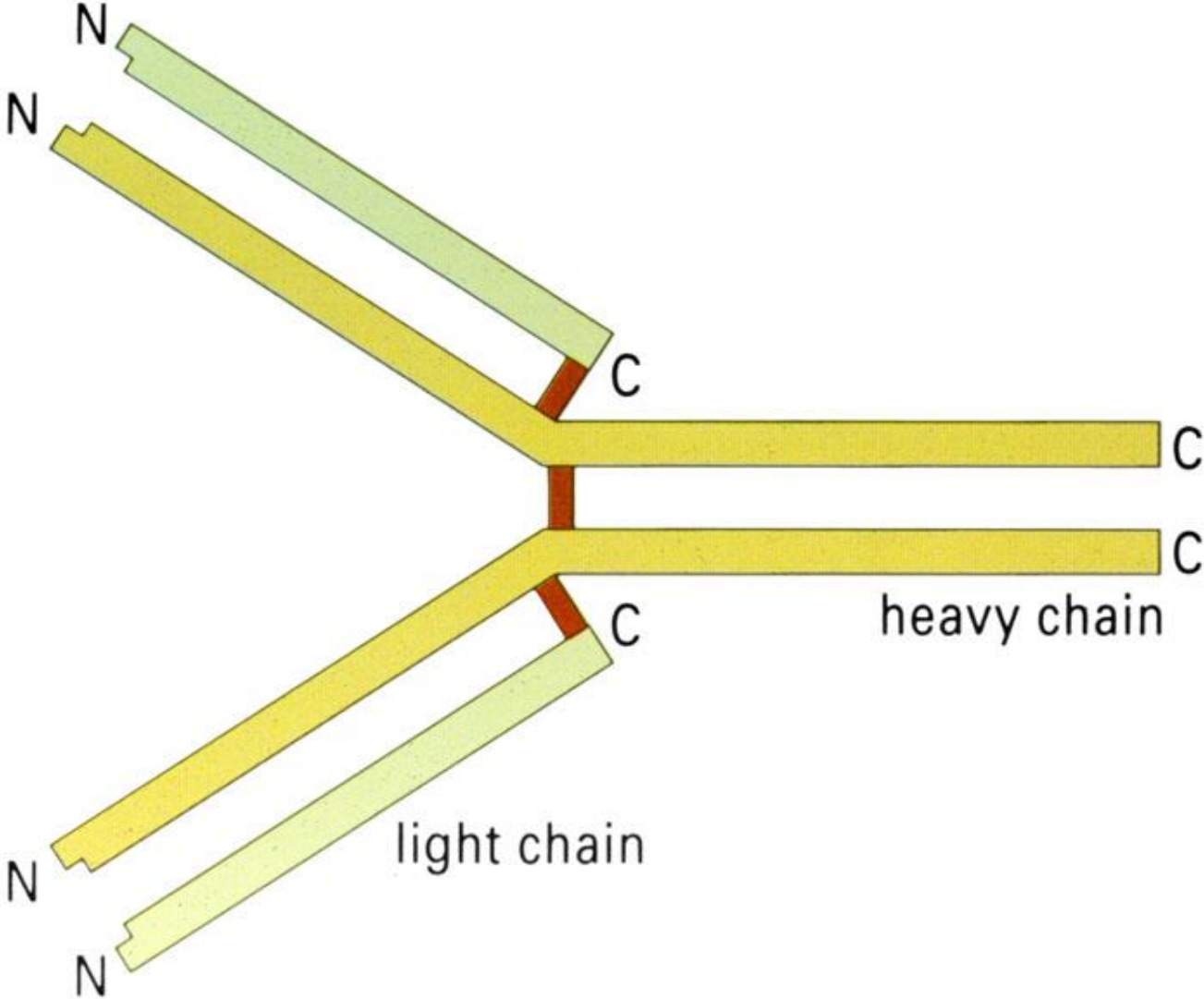

The basic structure of IgG1

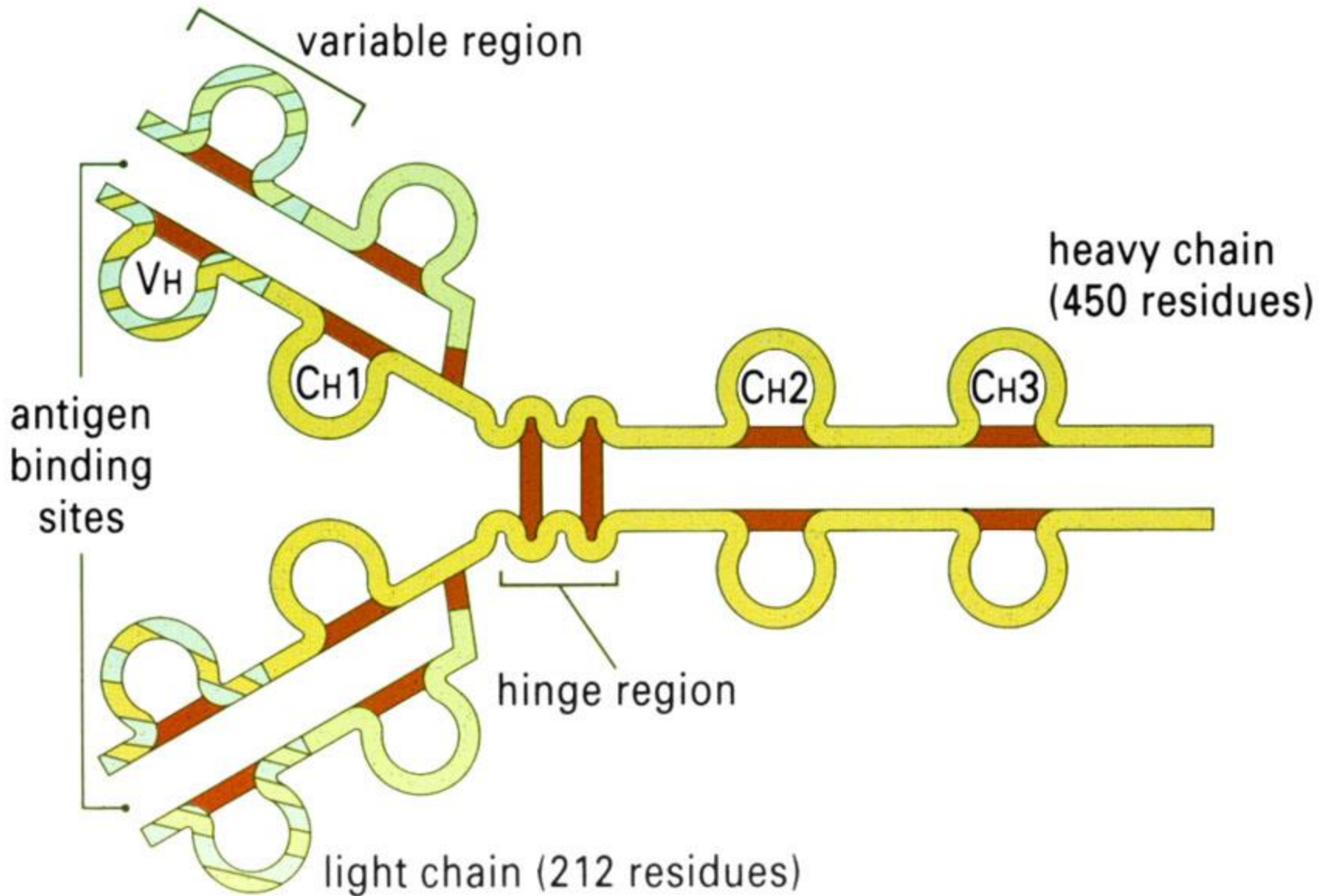

Enzymic cleavage of human IgG1

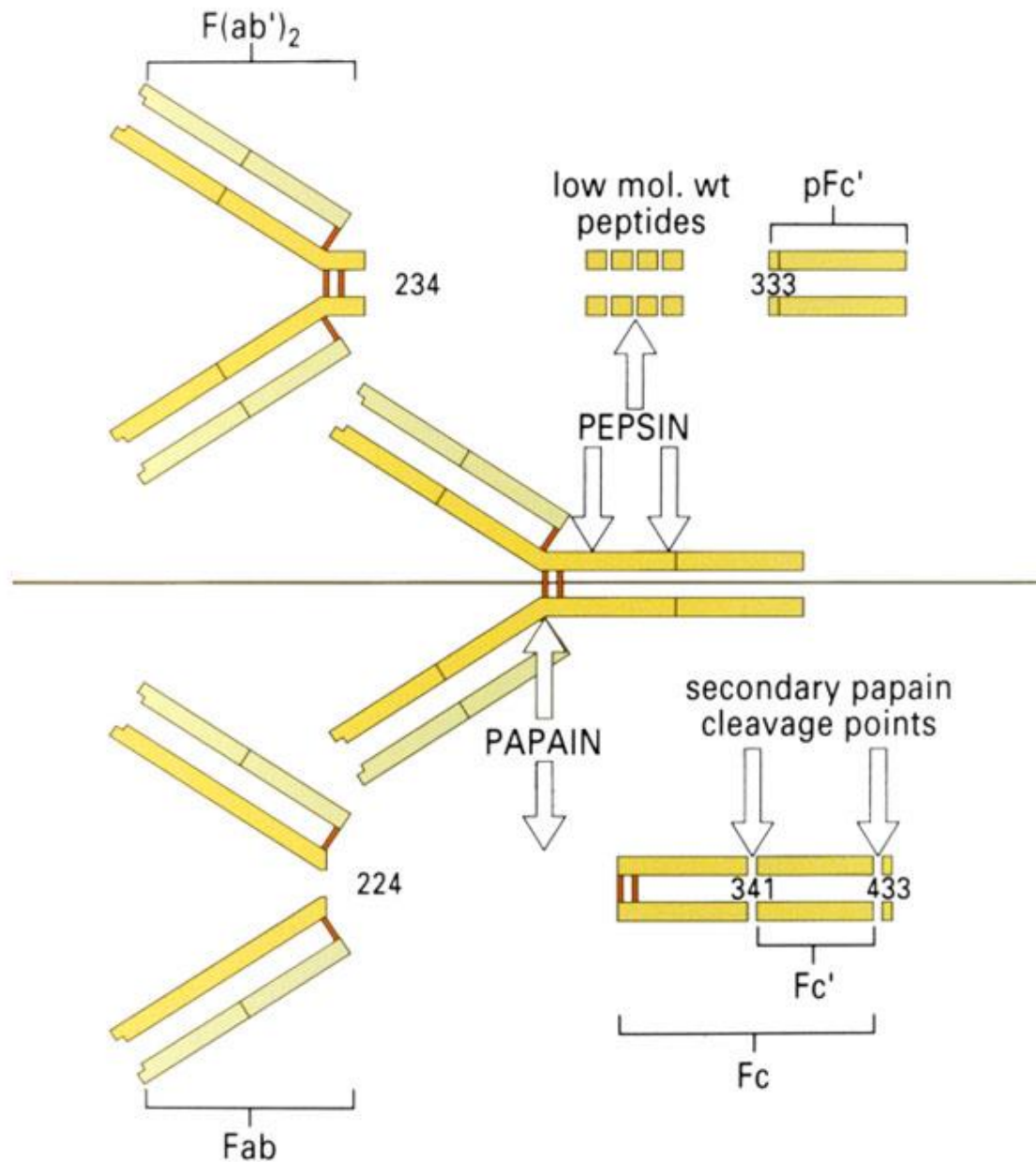

Molecule of IgG

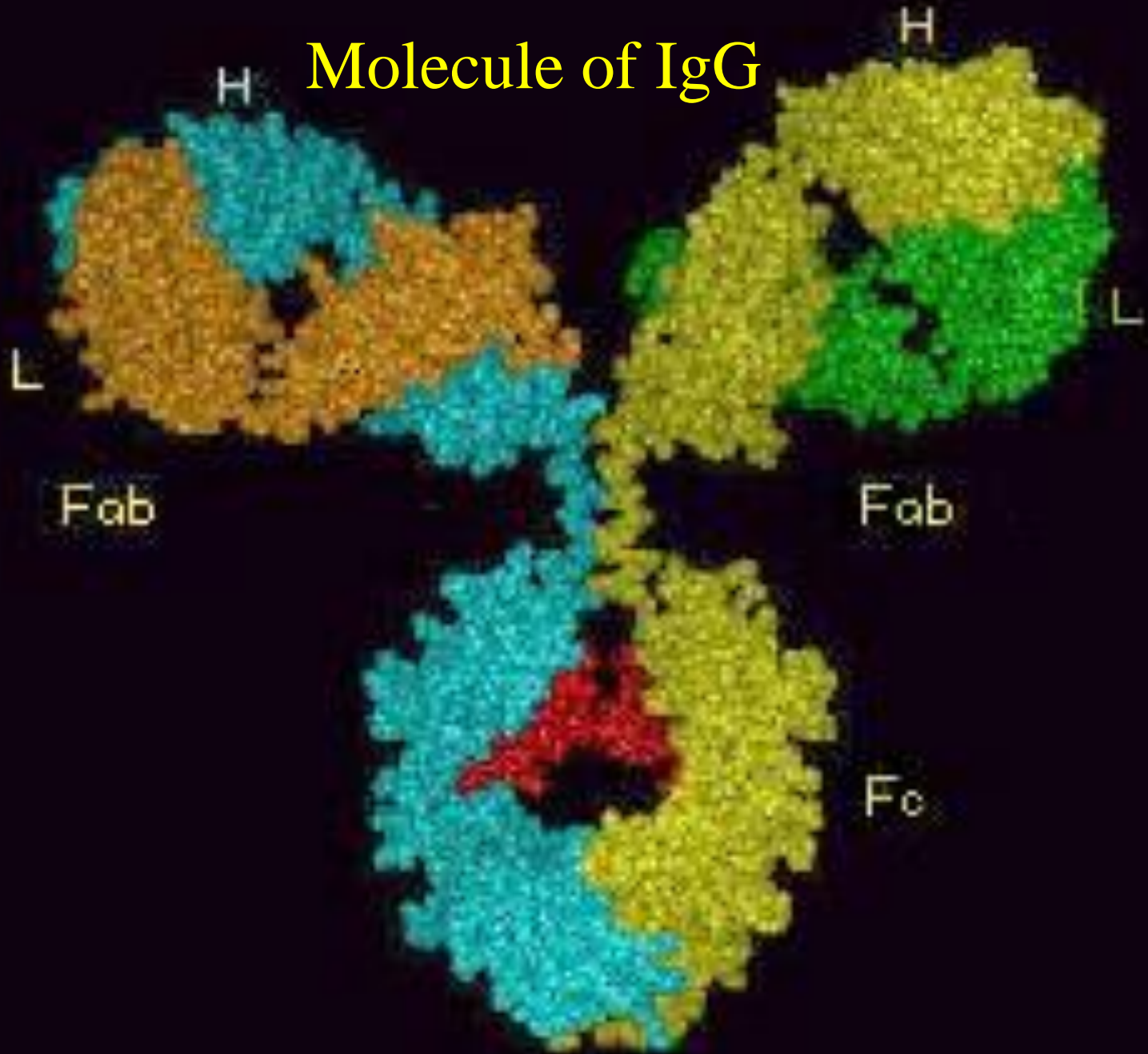

Hypervariable region of immunoglobulin molecule binds epitope of the antigen

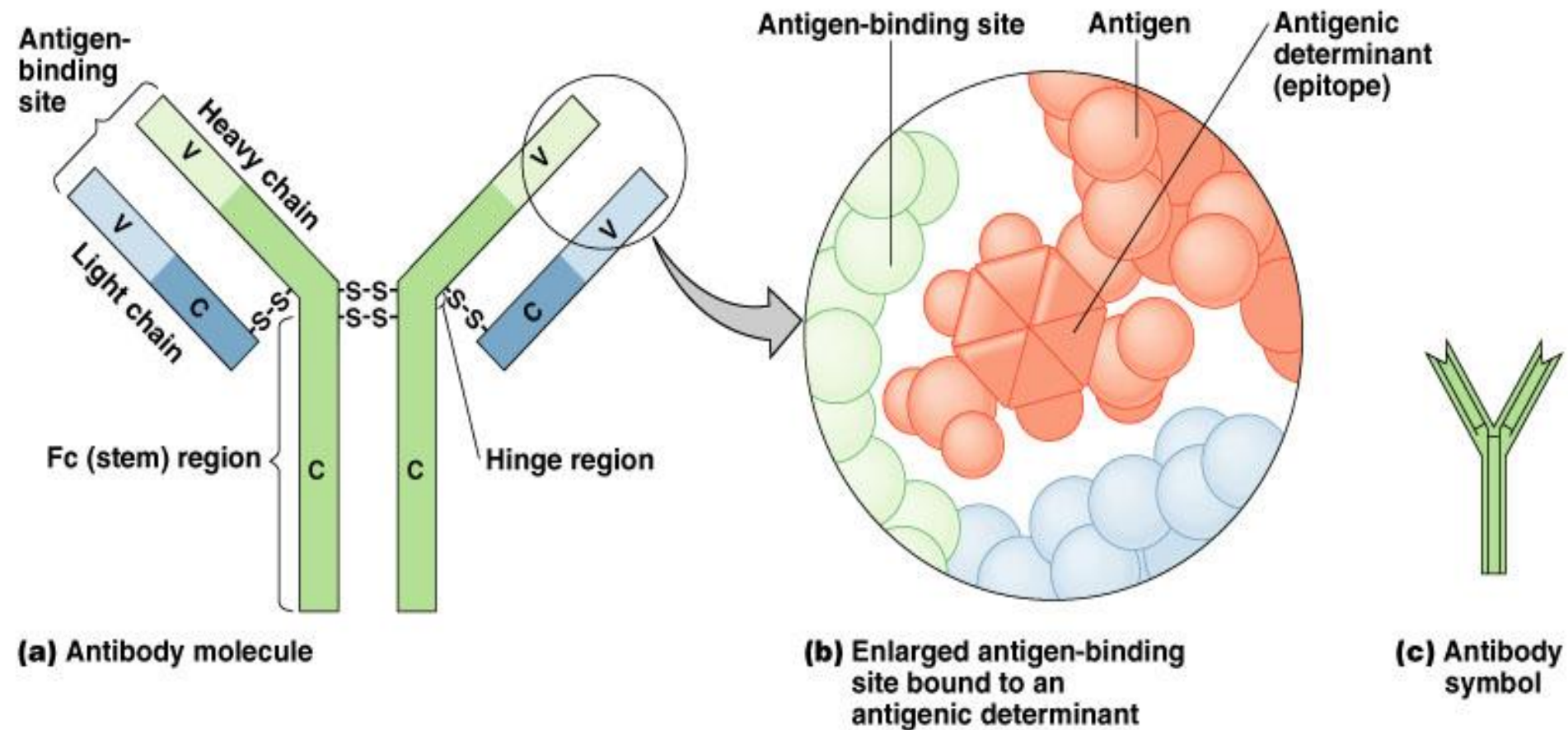

Variable region of immunoglobulin molecule

Figure 2.7

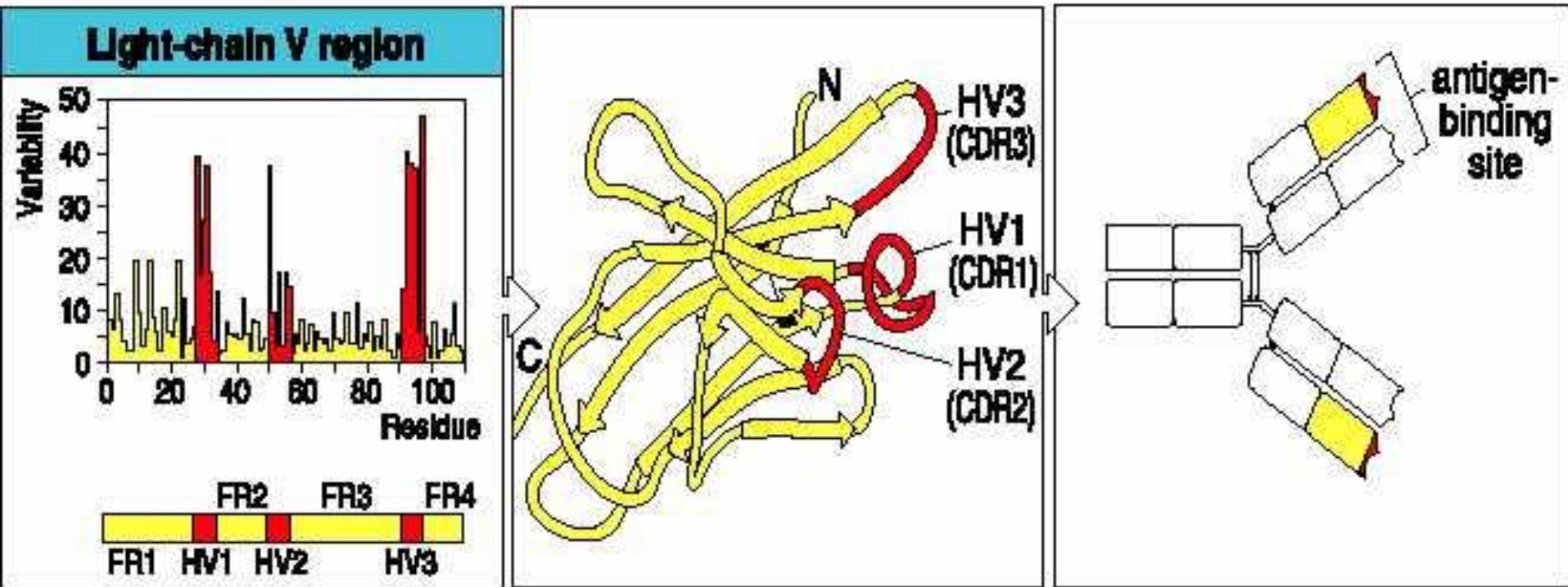

The antibody combining site

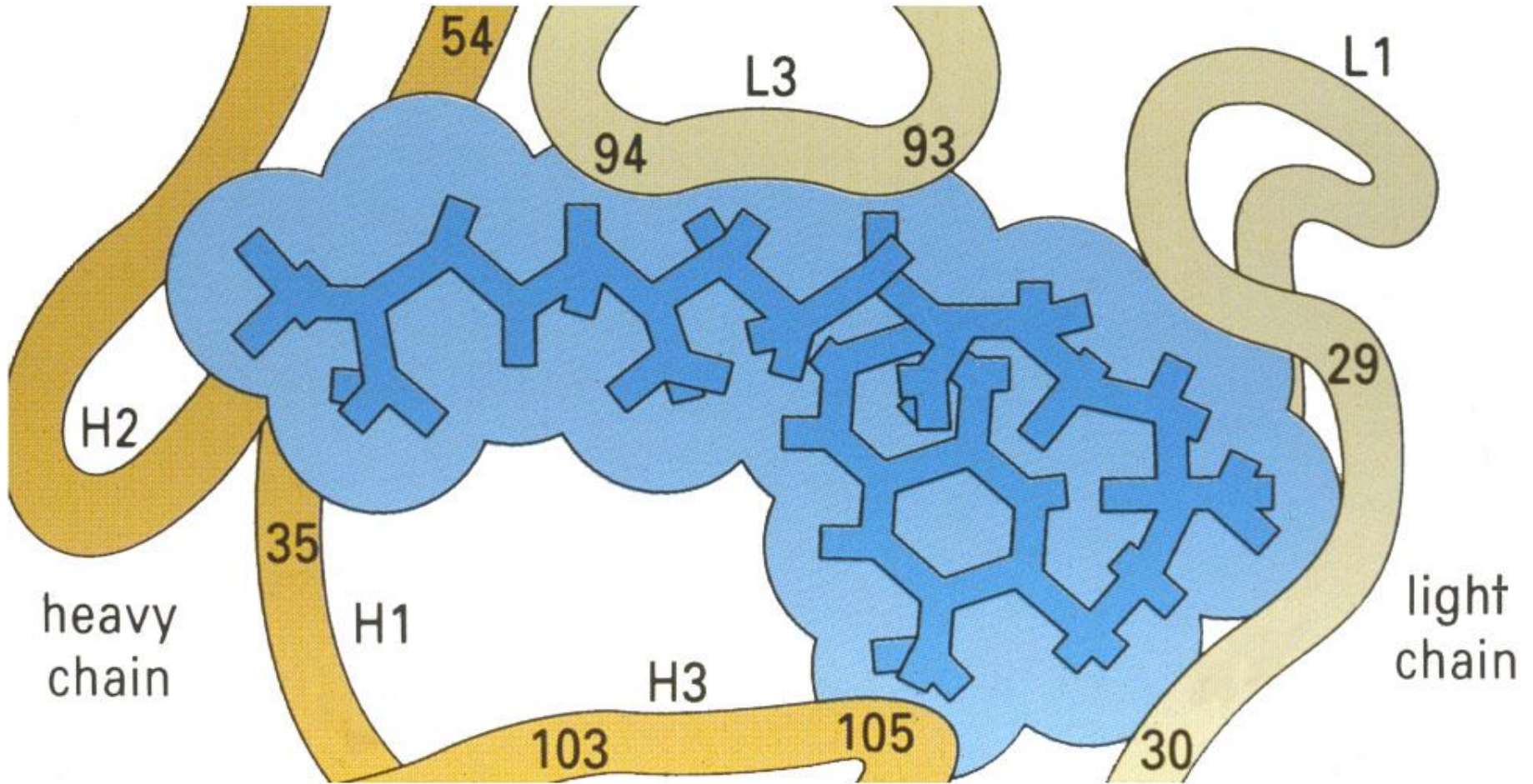

Clonal selection theory

F.M. Burnet, 1957

- During (mainly fetal) development immunocompetent cells of the immune system develop. Each cell is characterized by its own antigen specific receptor. Each cell reacts only with one concrete specific antigen.
- After exposure to autoantigen during fetal life autoreactive clones are eliminated („forbidden clones“).
- If a concrete cell recognizes its specific antigen, it is stimulated, proliferates and forms a clone = clonal selection.
- After repeated divisions the cell becomes a terminally differentiated cell, that does not proliferate and after some time dies.
- The cells of the clone that do not differentiate into the terminal stage become a memory cells which will quickly react after the second exposure to the antigen.

Clonal selection theory

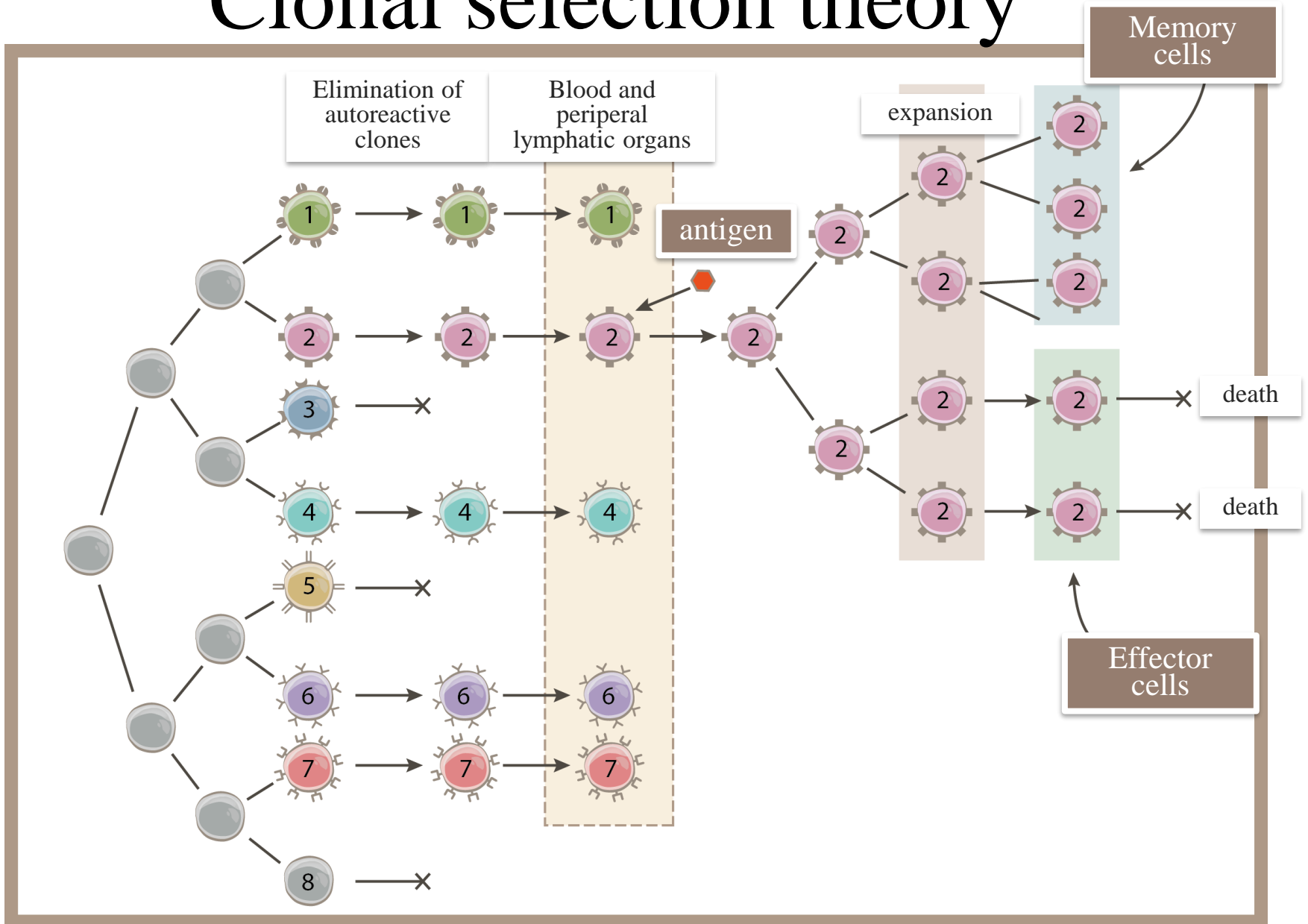

VDJ Recombination

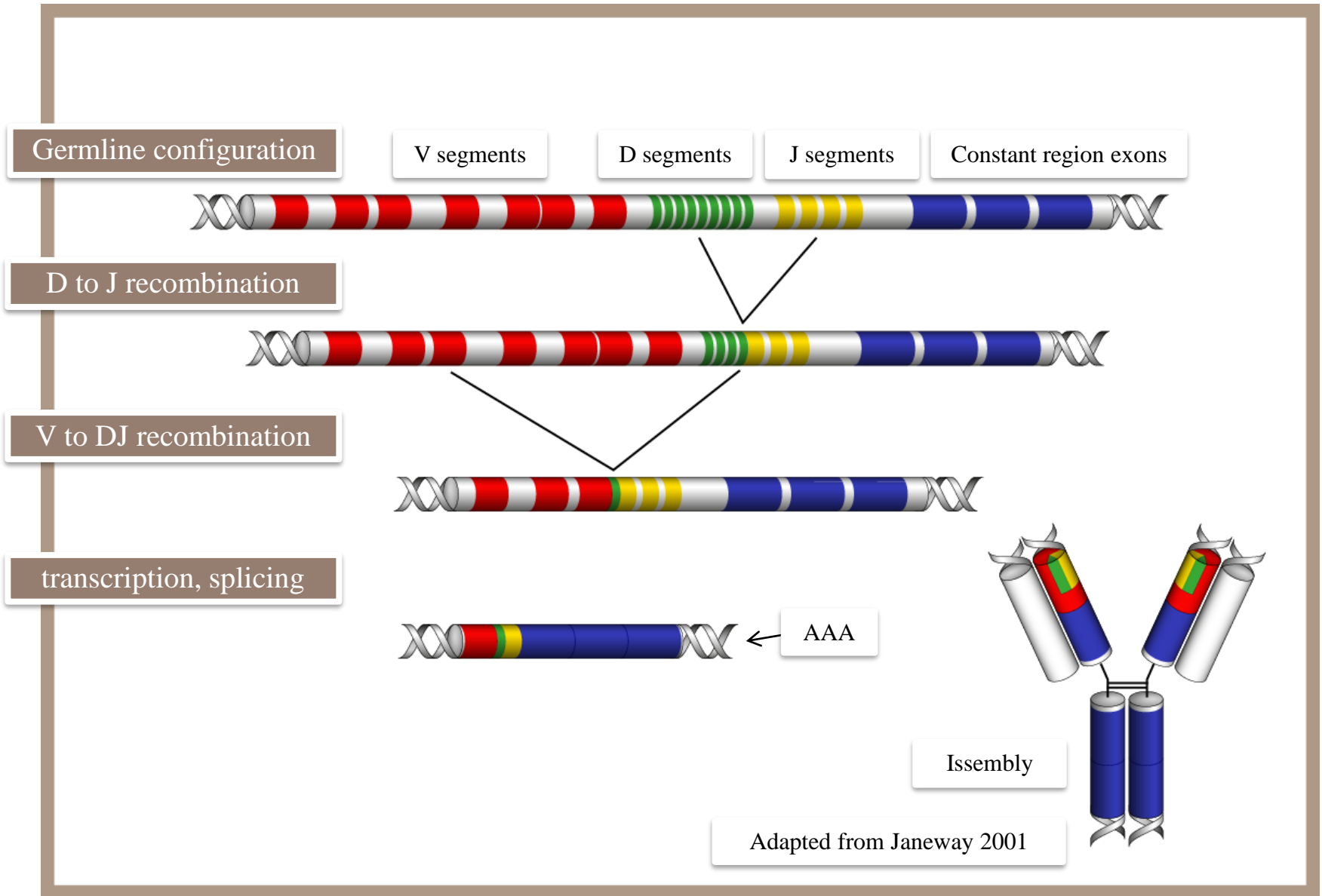

VDJ genes for BCR, and TCR

	Immunoglobulin		T cell receptor	
	Heavy chain	κ	α	β
Number of V gene segments	45	35	45	50
Number of diversity (D) gene segments	23	0	0	2
Number of joining (J) gene segments	6	5	~50	12
Mechanism				
Combinatorial diversity:				
Number of possible V-(D)-J combinations	Ig: $\sim 10^6$		TCR: $\sim 3 \times 10^6$	
Junctional diversity:				
Total potential repertoire with junctional diversity	Ig: $\sim 10^{11}$		TCR: $\sim 10^{16}$	
© Elsevier Ltd. Abbas & Lichtman: Basic Immunology 2E www.studentconsult.com				

Somatic hypermutations

- The process occurs in activated B-lymphocytes, takes place in germinal centers of secondary lymphoid organs.
- Key enzyme is AID (activation-induced deaminase).
- Mutation frequency is approx. 10^6 times higher than in other parts of human genome.
- Antigen presentation by lymphoid dendritic cells to B-cells leads to selection of clones with higher affinity – the process is called affinity maturation.

Isotype switching

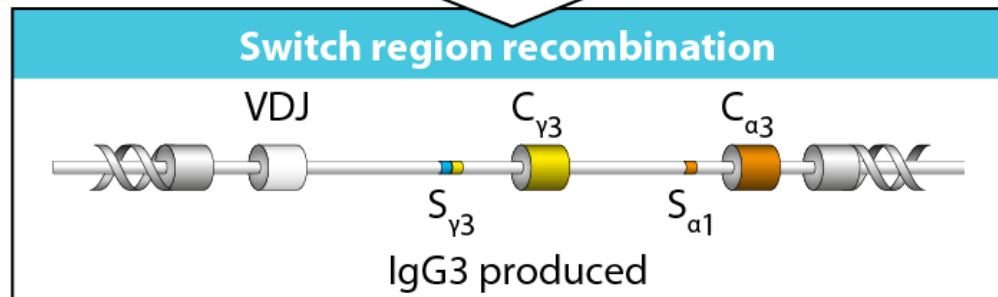
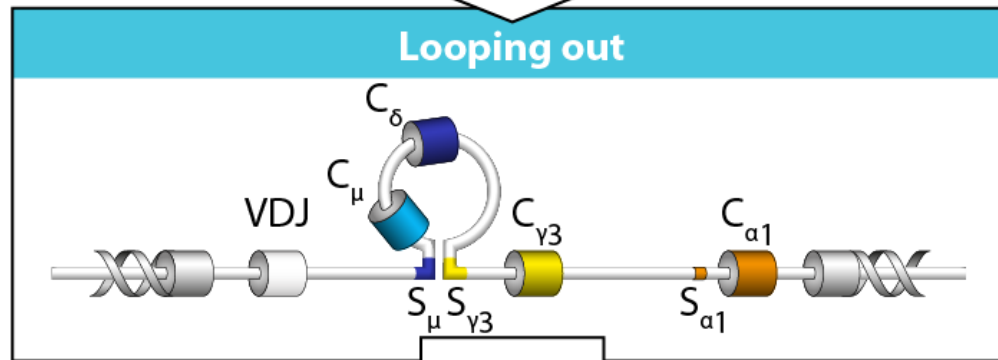
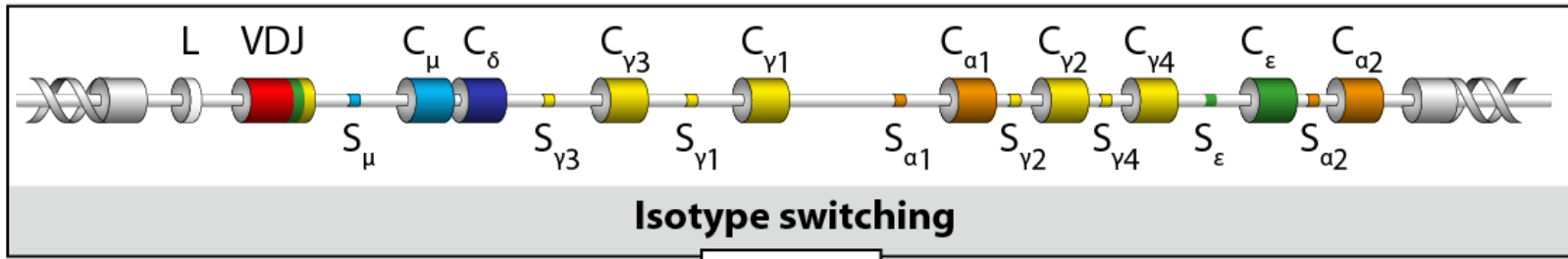

Isotype switching

Figure 2.26

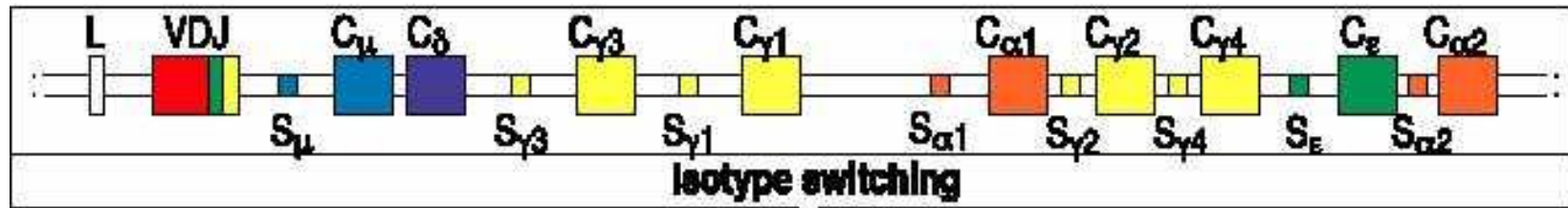

Isotype switching

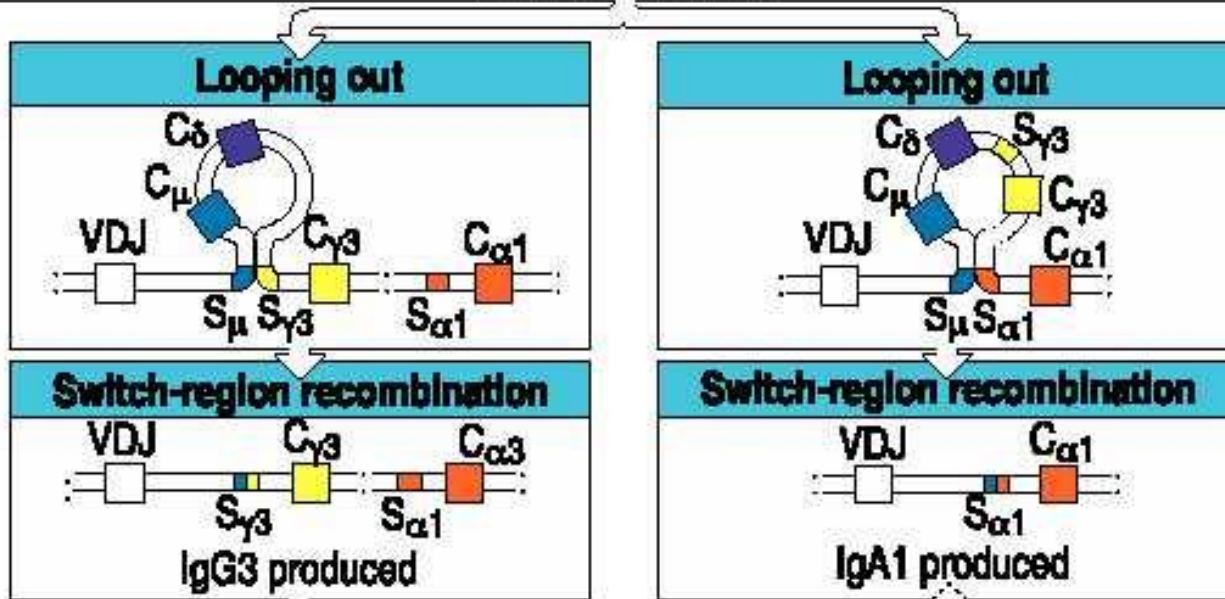

A further switch occurs

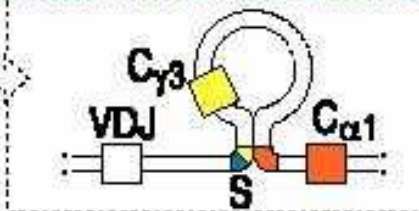

Activation and differentiation of B-lymphocytes (clonal selection theory in B-lymphocyte development)

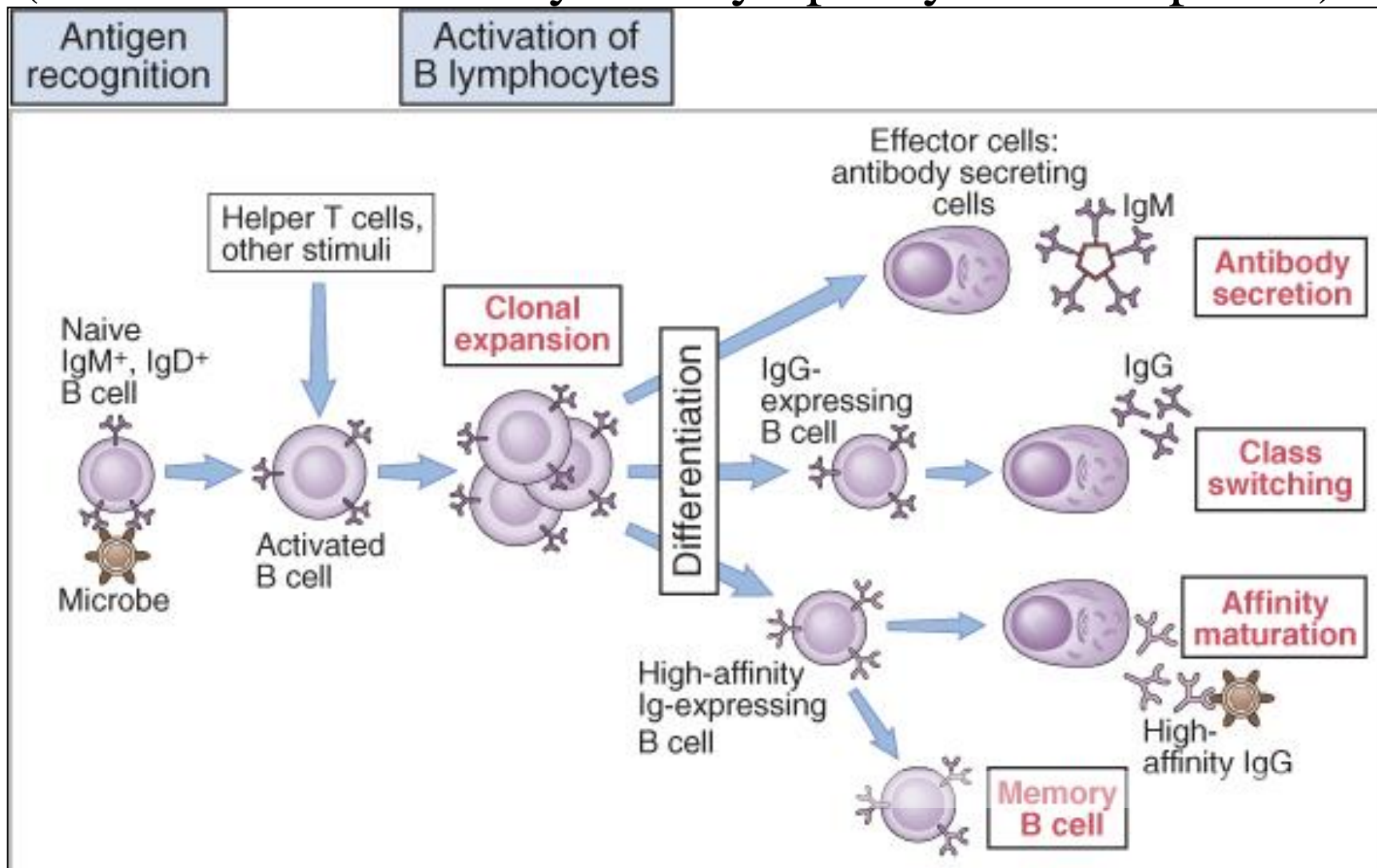

Primary phase of the antibody response

- Naive or opsonised antigen captured by follicular dendritic cells.
- Primary stimulation of B-cells in lymphoid follicles.
- The antigen also stimulates T cells (after adequate presentation) in T-cell zones. T-cells migrate toward the lymphoid follicles.
- Newly formed plasma cells produce mainly IgM(mainly in bone marrow).

Secondary phase of the antibody response

- Occurs in newly formed germinal centers of lymphoid follicles
- Th lymphocytes stimulate B-lymphocytes to somatic hypermutations and isotype switching.
- This leads to selection of B- cells producing high-affinity antibodies (affinity maturation).
- Majority of B-cells producing low-affinity antibodies die.

Development of B-cells in the bone marrow

- **Stem cells:** no B-cell surface markers, no rearrangement of Ig genes
- **Pro-B lymphocyte** – rearrangement of heavy chain , expression of several B-cell surface markers (e.g. CD19).
- **Pre-B-lymphocytes** VDJ has of heavy chain has been completed, μ chain can be detected in cytoplasm. Pre-B receptor – composed of μ chain and surrogate chains V-preB and $\lambda 5$ is expressed on the surface of the cell. Signal transduction through this receptor is essential for B- cell development.
- **Imature B-cell** – light chain rearrangement (V-J) completed B-cell receptor is composed of monomeric IgM
- **Mature B-lymphocyte has** IgM and IgD B-cell receptors

Development of B-cells in the bone marrow

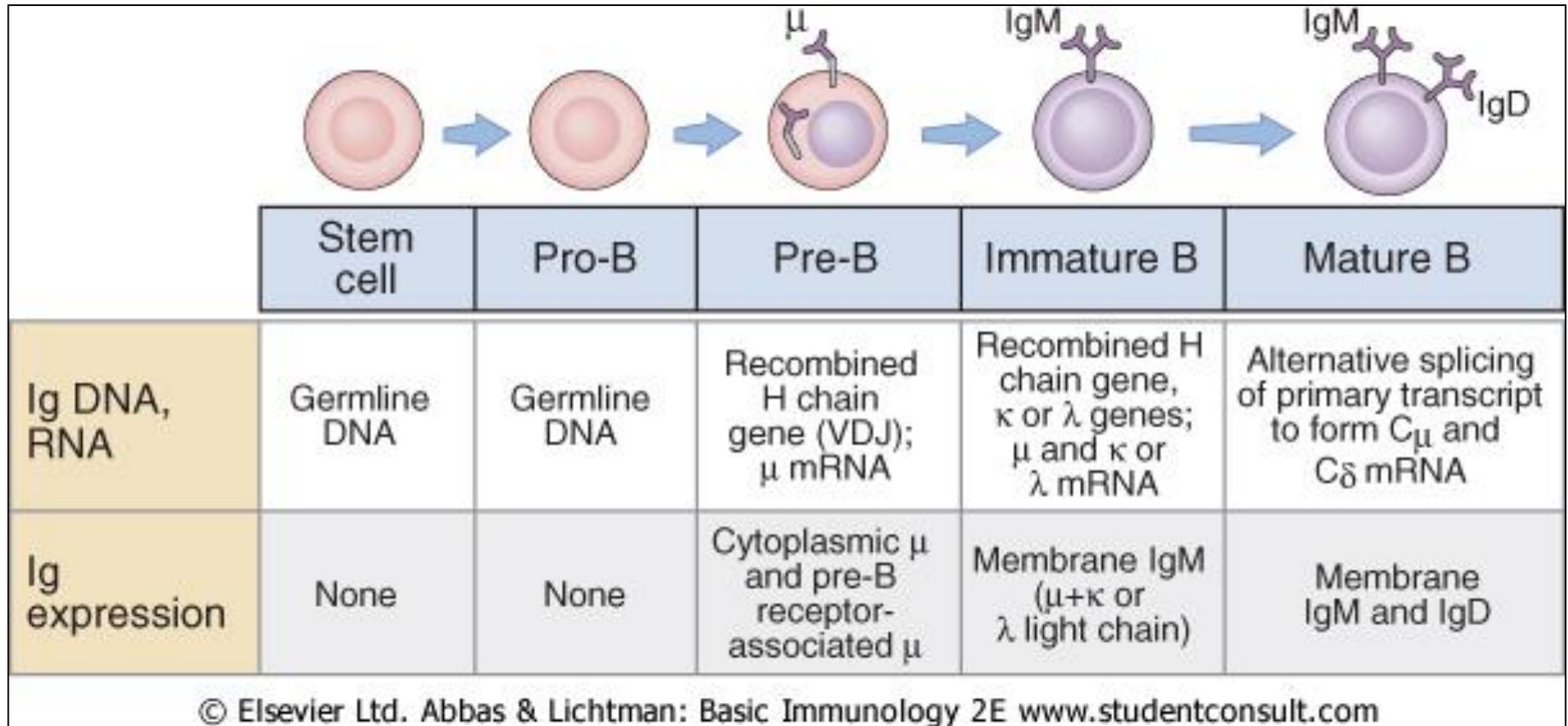

Heavy chain **B-cell receptor**

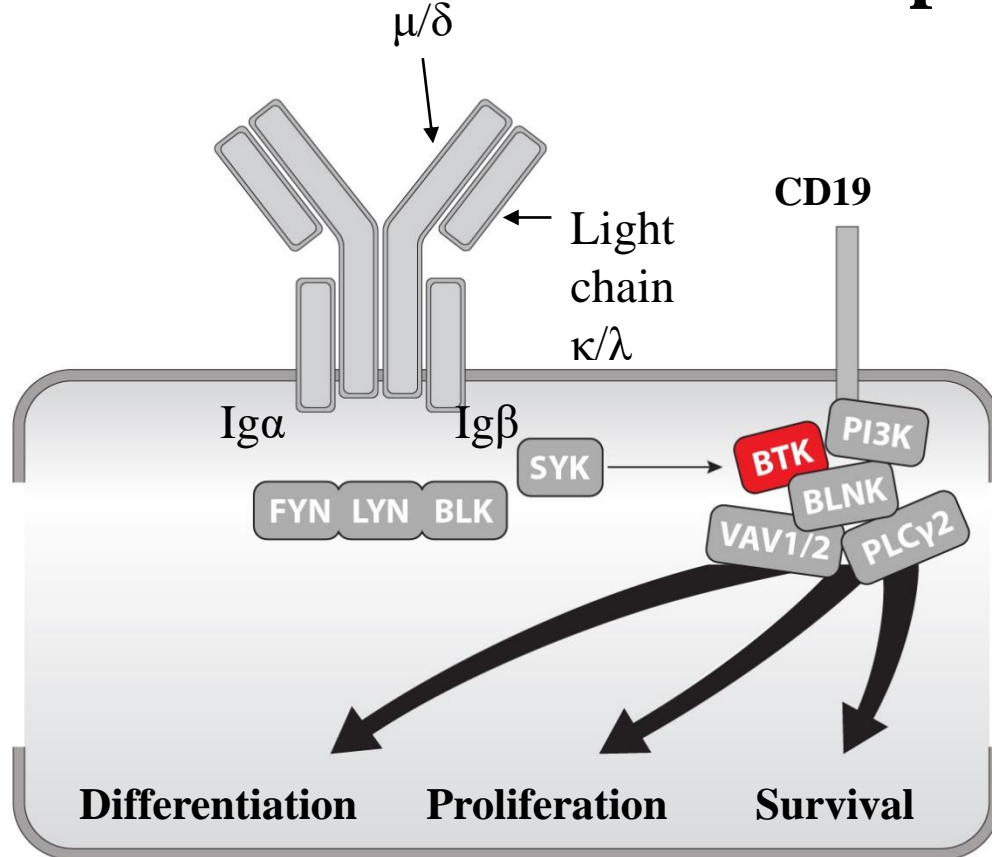

Pre B-cell receptor

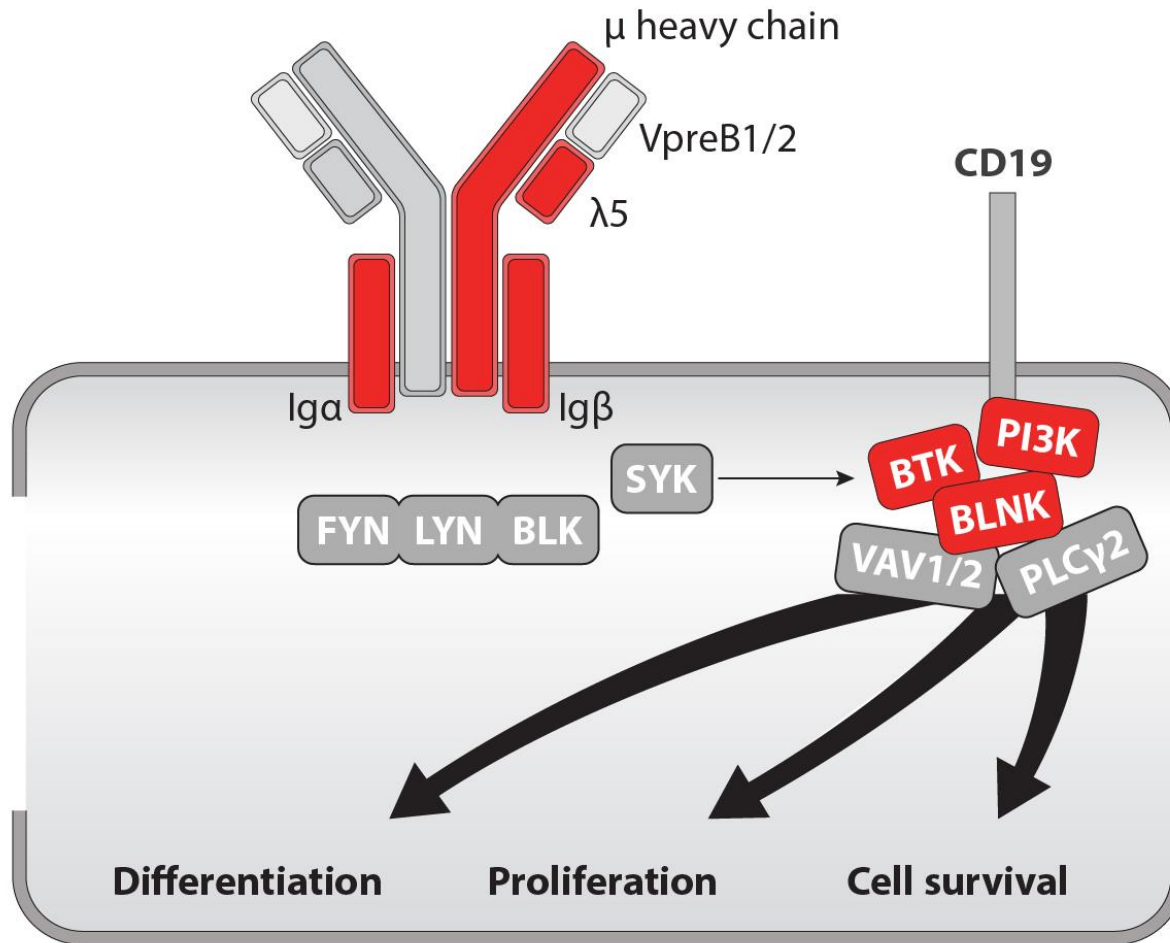

Bruton's tyrosine kinase (BTK)

- BTK binds phosphatidylinositoltriphosphate (3,4,5)-(PIP₃).
- Activates phospholipase C, leading to hydrolysis of phosphatidylinositol (PIP₂) into inositoltriphosphate (IP₃) and diacylglycerol(DAG).
- This is key process in activation, differentiation and development of B-cells.
- Mutations of BTK lead to X-linked (Bruton's) agammaglobulinemia.
- BTK blockers (e.g. ibrutinib) are used for the treatment of B- cell malignancies.

Antibody variants

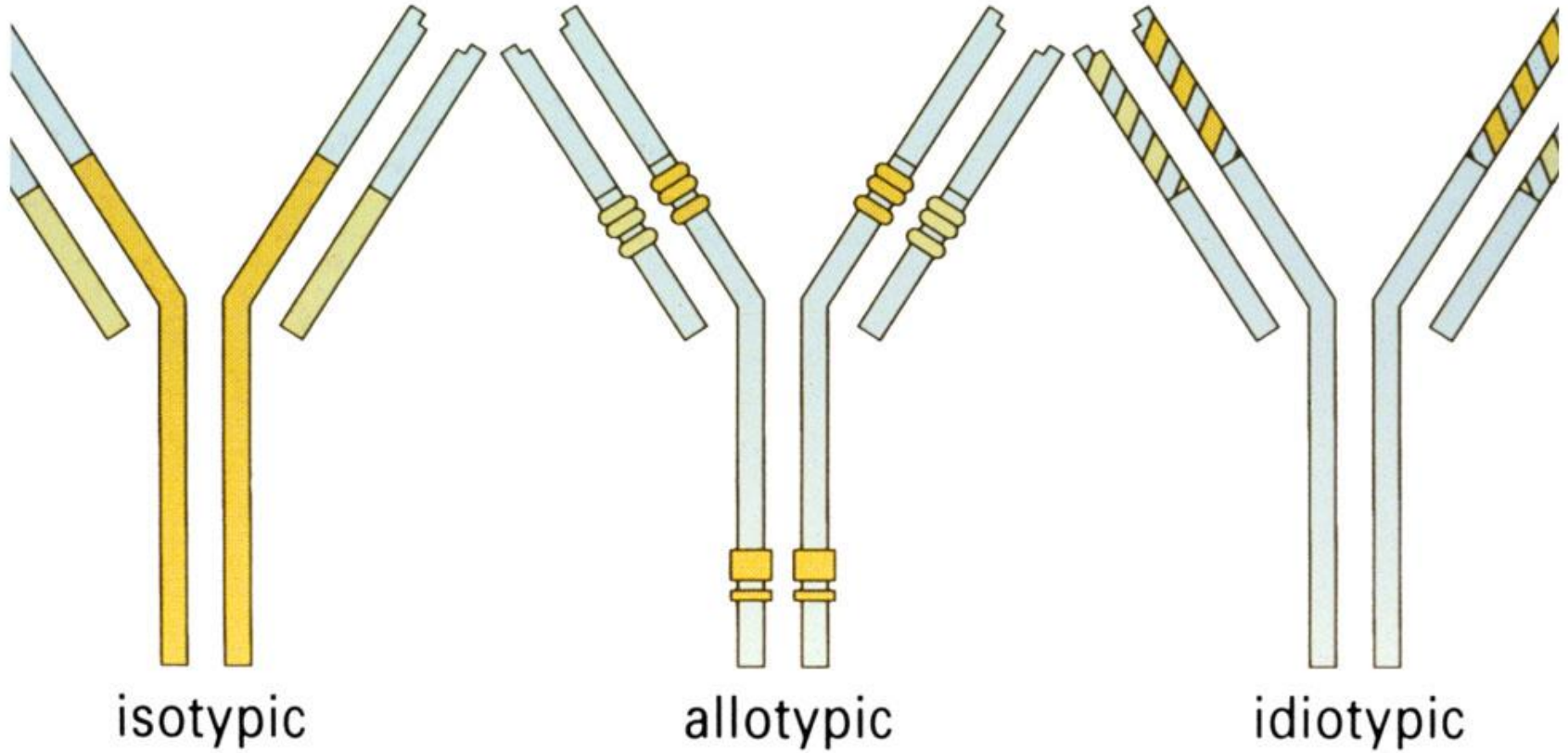

isotypic

allotypic

idiotypic

Isotype

- The class or subclass of an immunoglobulin.
- Antigenic determinants are on constant part of immunoglobulin molecule.

Idiotypic

- An antigenic determinant on the variable region of a specific antibody.

Interaction idiotypic-antiidiotypic

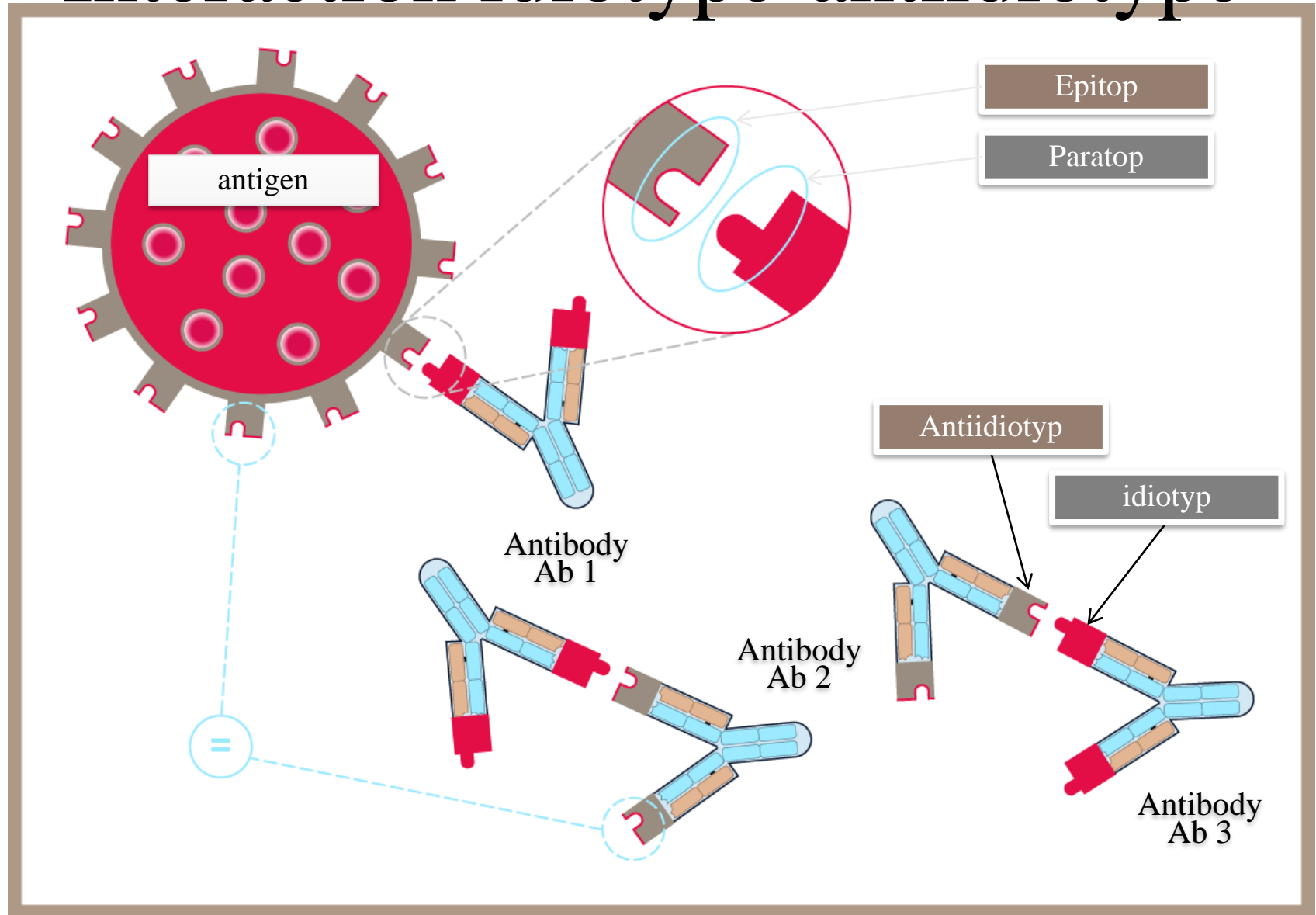

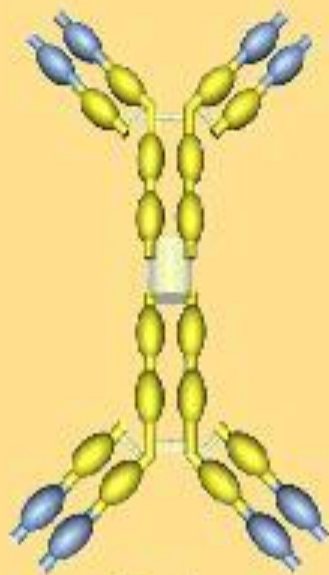

IgA

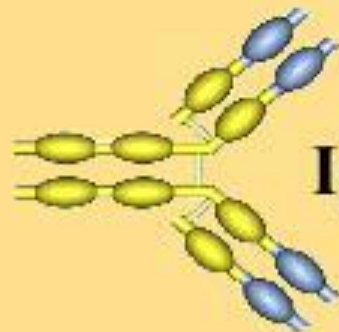

IgD

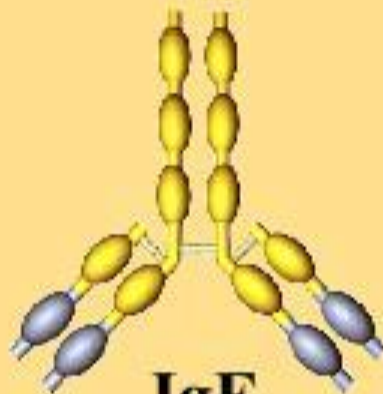

IgE

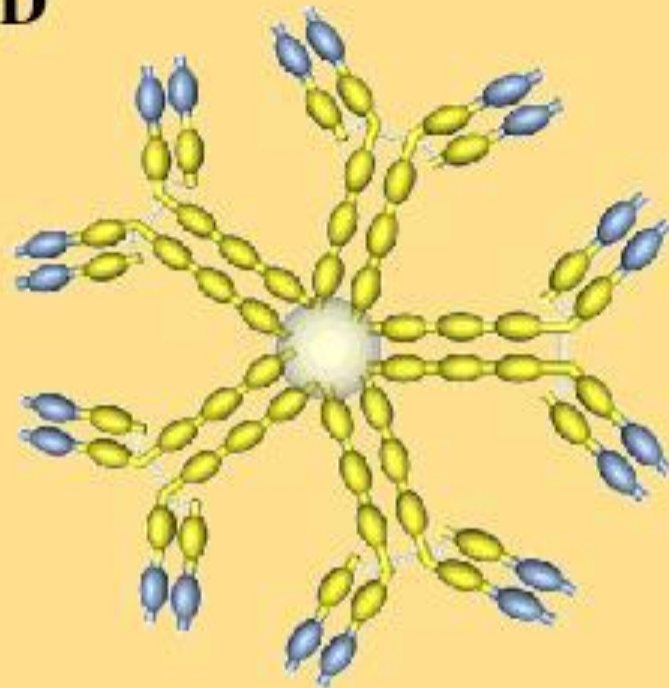



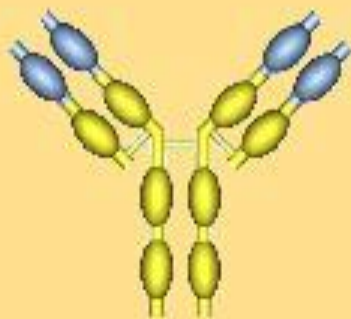

IgM

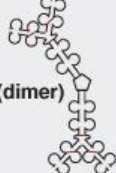

IgG

Characteristics of immunoglobulin classes

Isotype of antibody	Subtypes	H chain	Serum concentr. (mg/mL)	Serum half-life (days)	Secreted form	Functions
IgA	IgA1,2	α (1 or 2)	3.5	6	Monomer, dimer, trimer  IgA (dimer)	Mucosal immunity, neonatal passive immunity
IgD	None	δ	Trace	3	None	Naive B cell antigen receptor
IgE	None	ϵ	0.05	2	Monomer  IgE	Mast cell activation (immediate hypersensitivity)
IgG	IgG1-4	γ (1,2,3 or 4)	13.5	23	Monomer  IgG1	Opsonization, complement activation, antibody-dependent cell-mediated cytotoxicity, neonatal immunity, feedback inhibition of B cells
IgM	None	μ	1.5	5	Pentamer  IgM	Naive B cell antigen receptor, complement activation

© Elsevier Ltd. Abbas & Lichtman: Basic Immunology 2E www.studentconsult.com

IgG

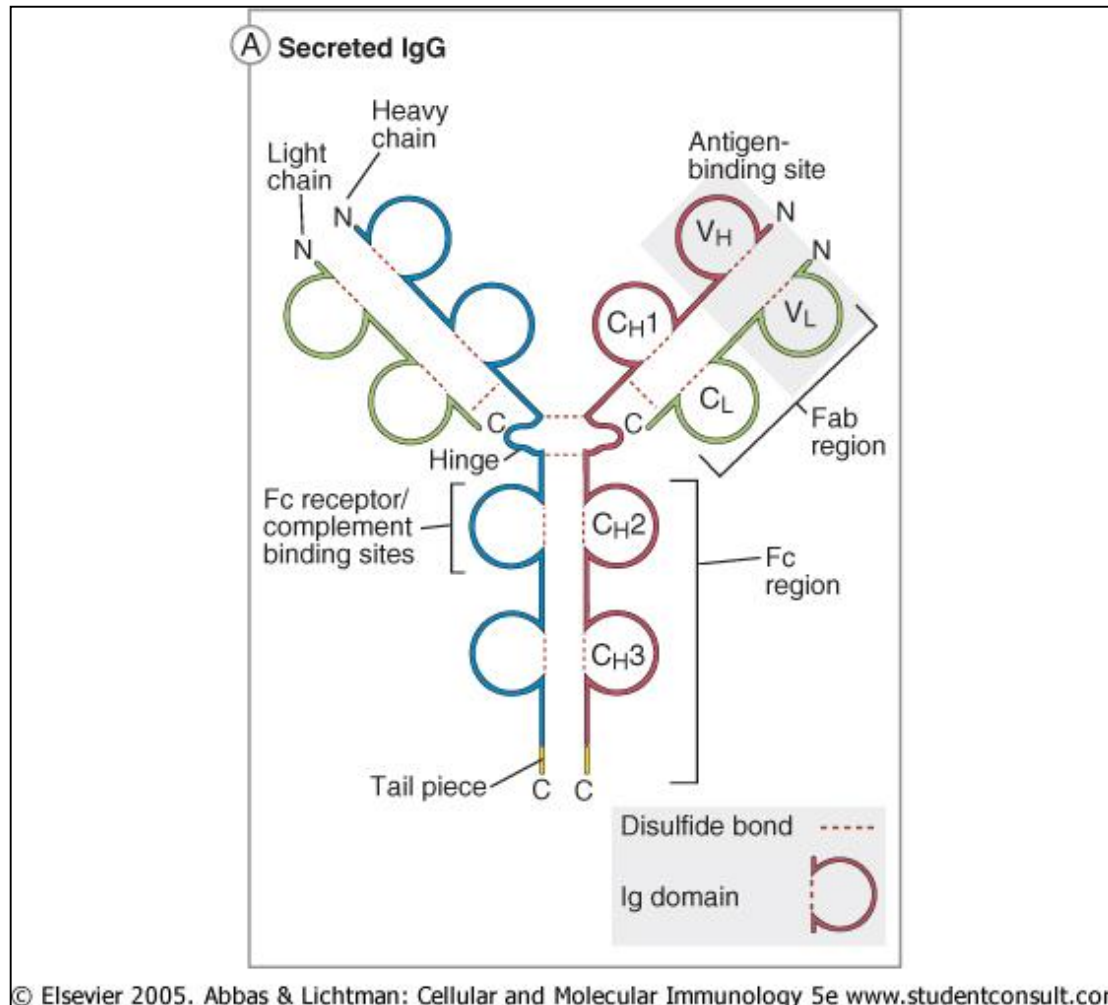

Structure of human IgM

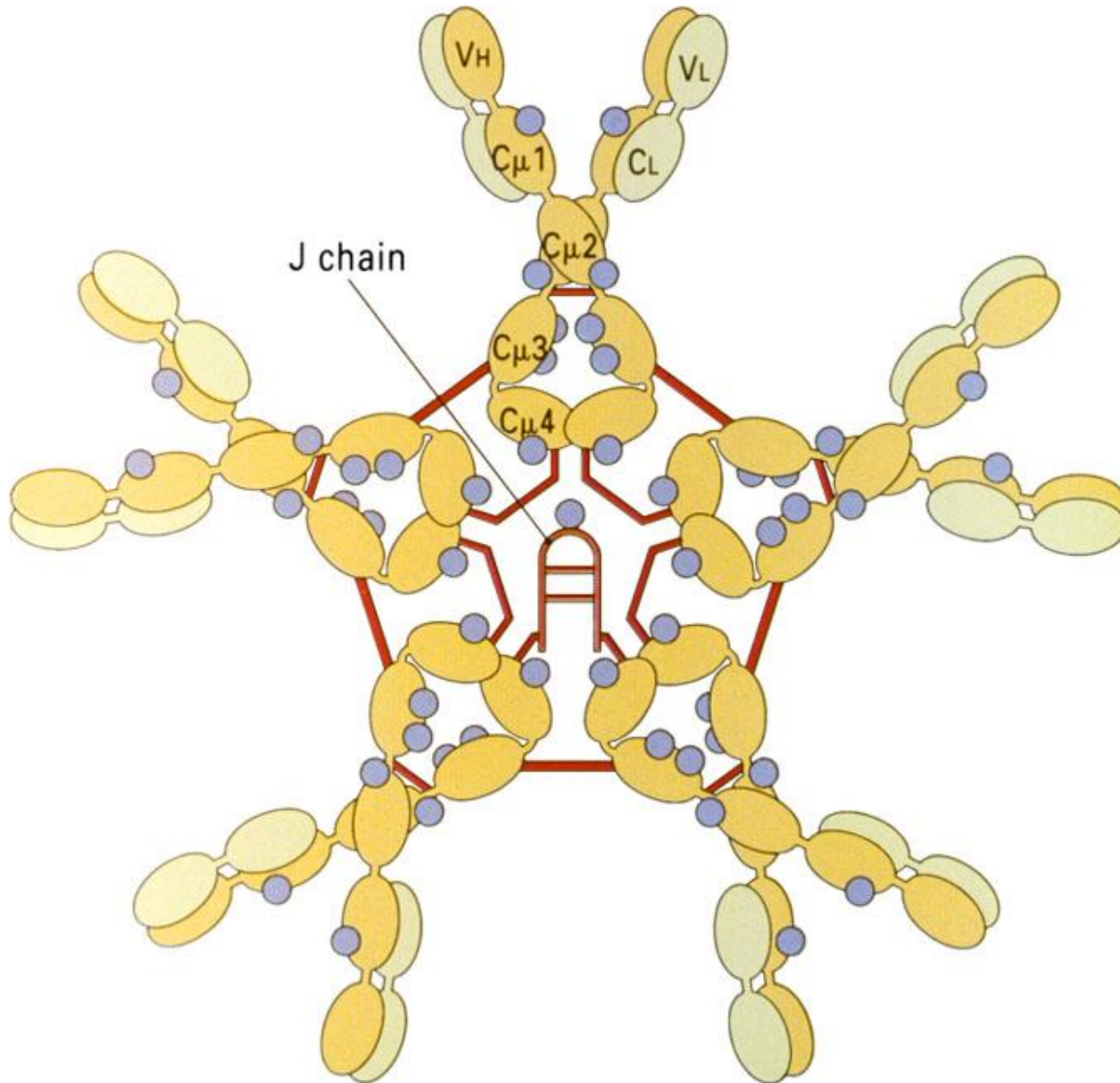

Antibody response after primary and secondary antigen exposure

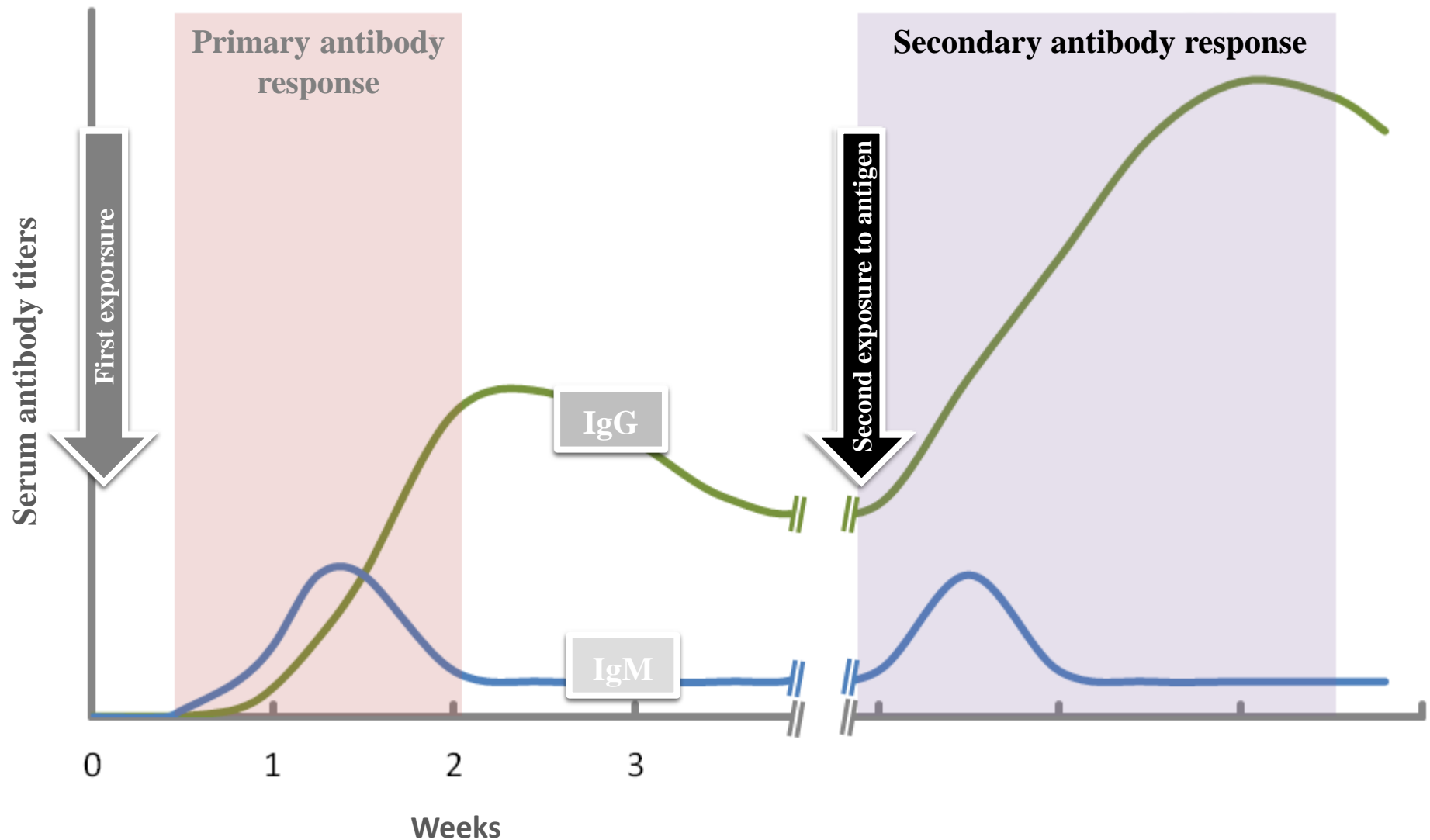

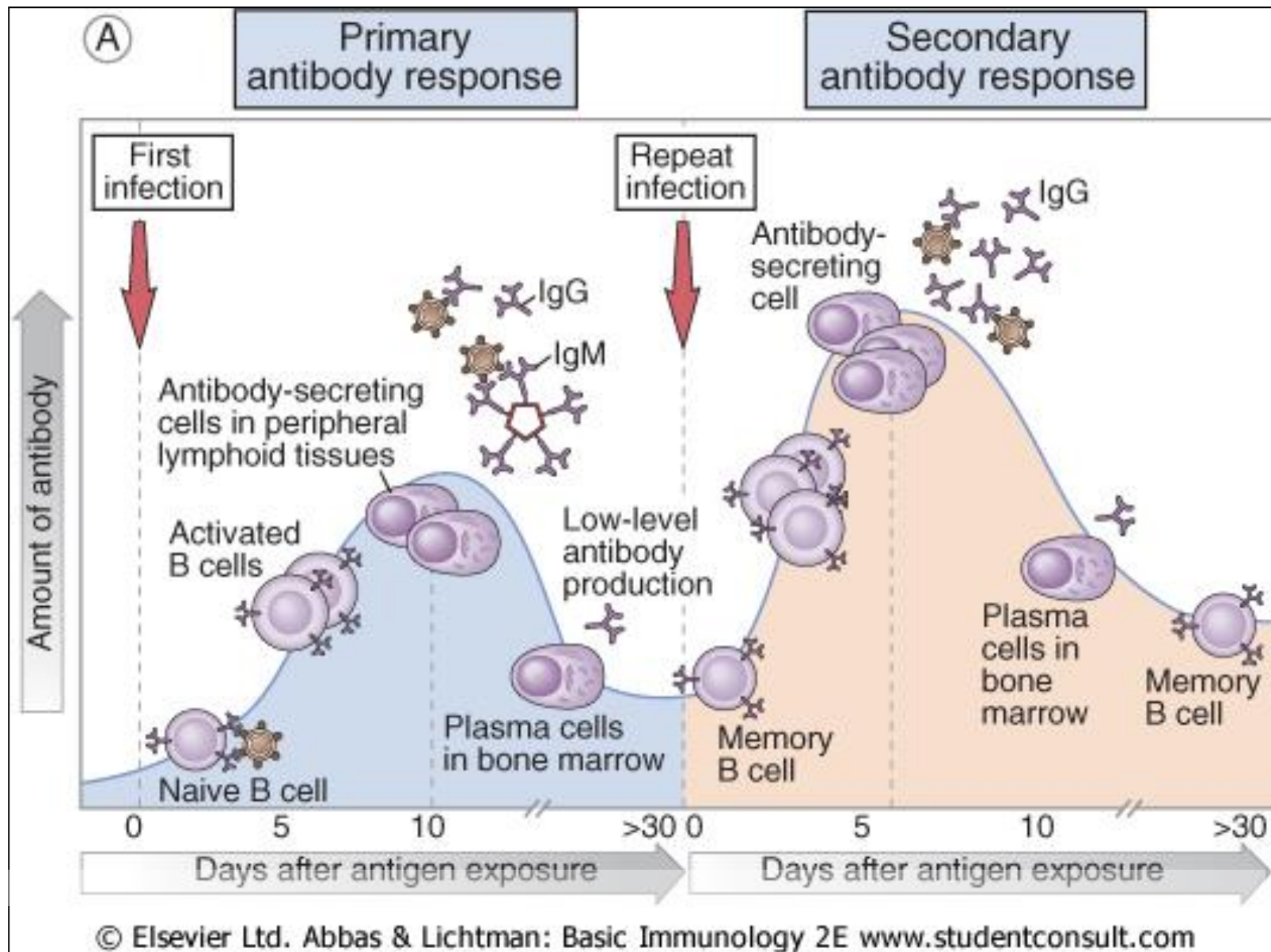

IgM on B-cell membrane

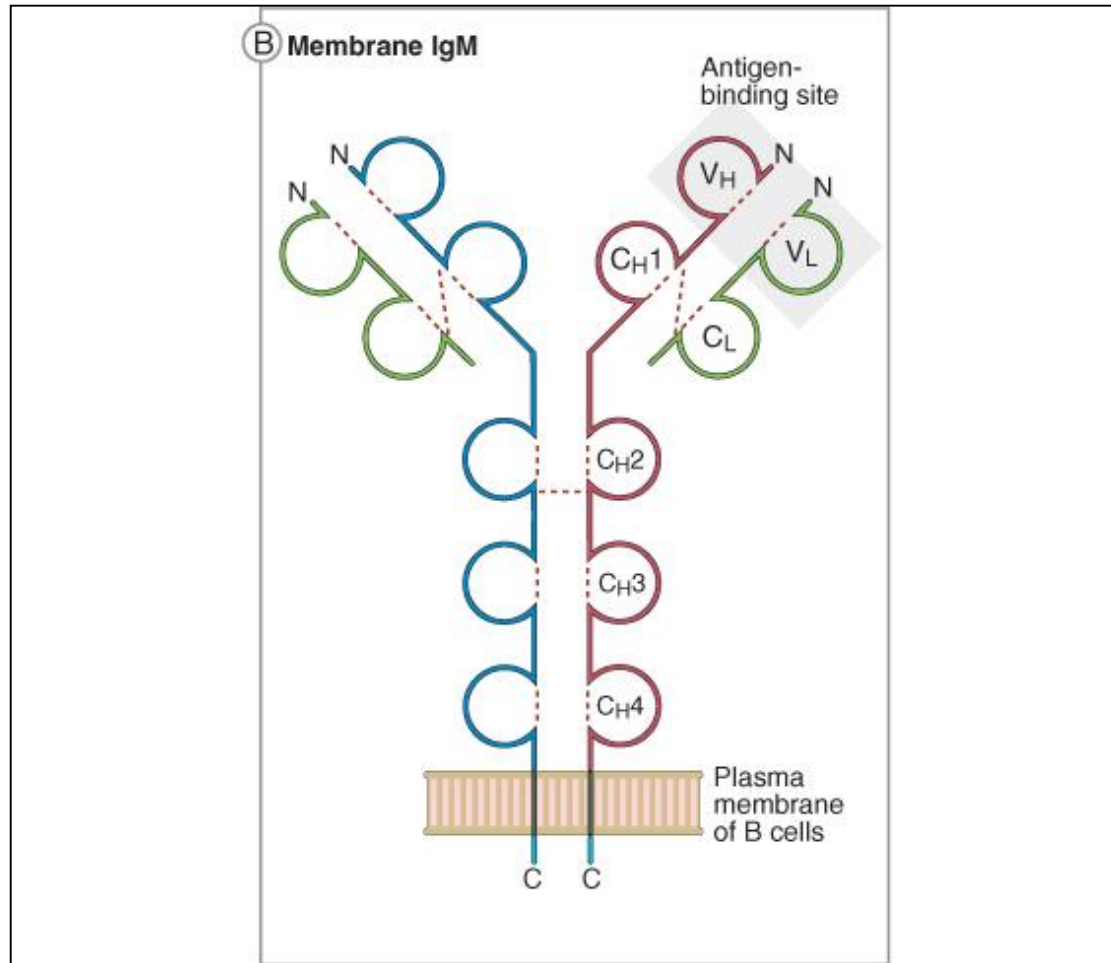

Expression of surface immunoglobulins on B-cells

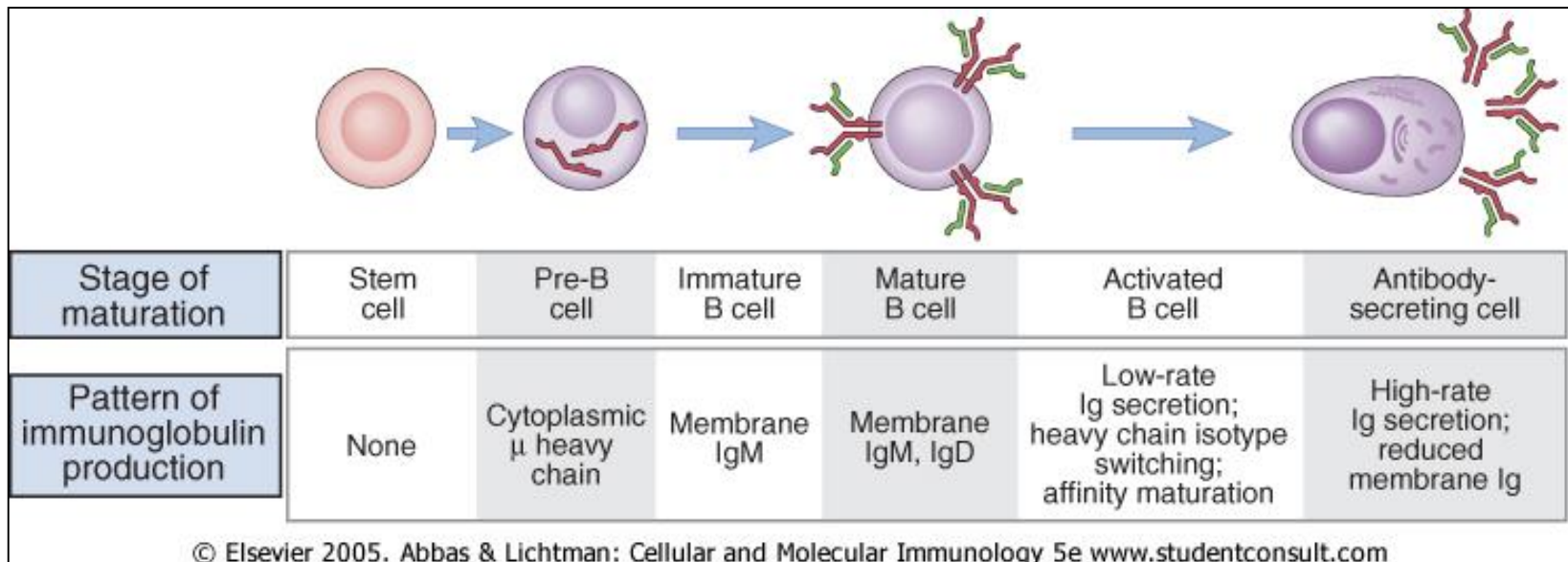
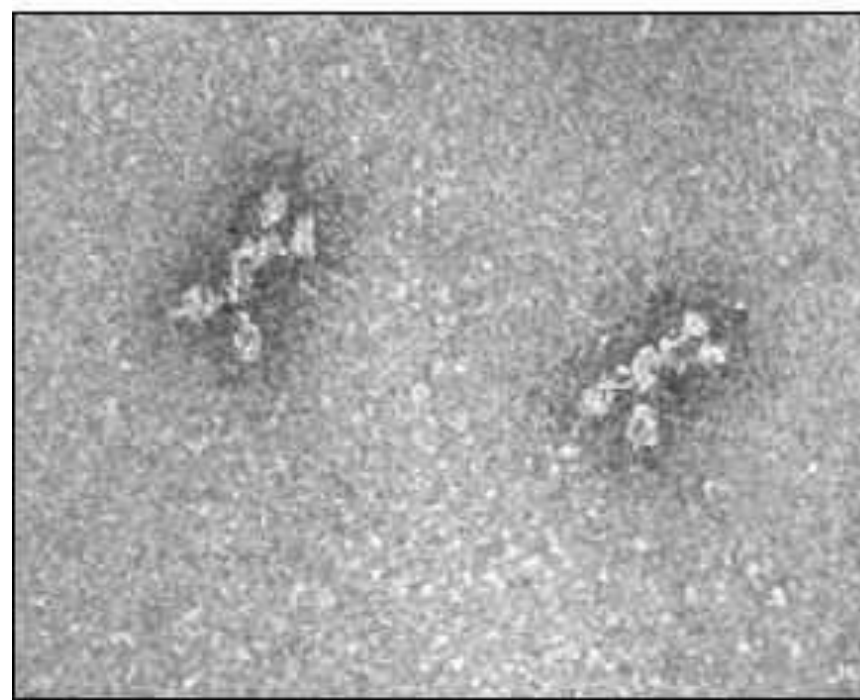
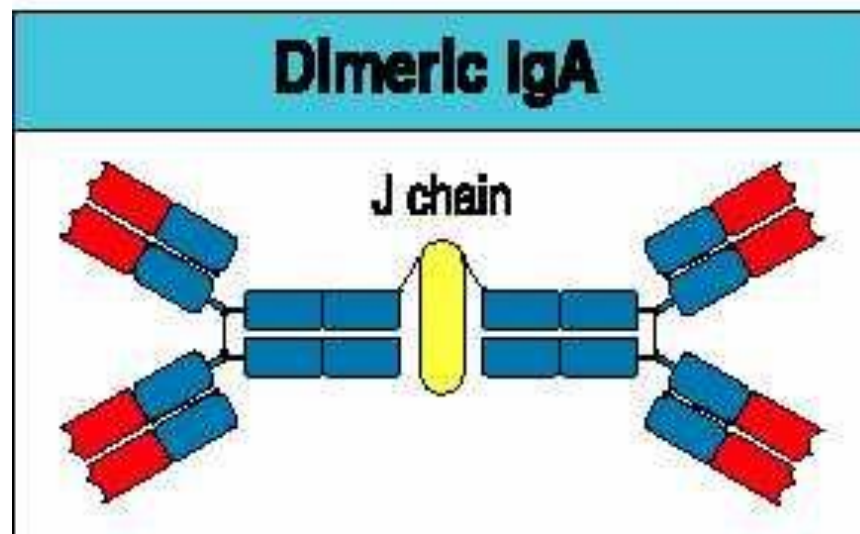
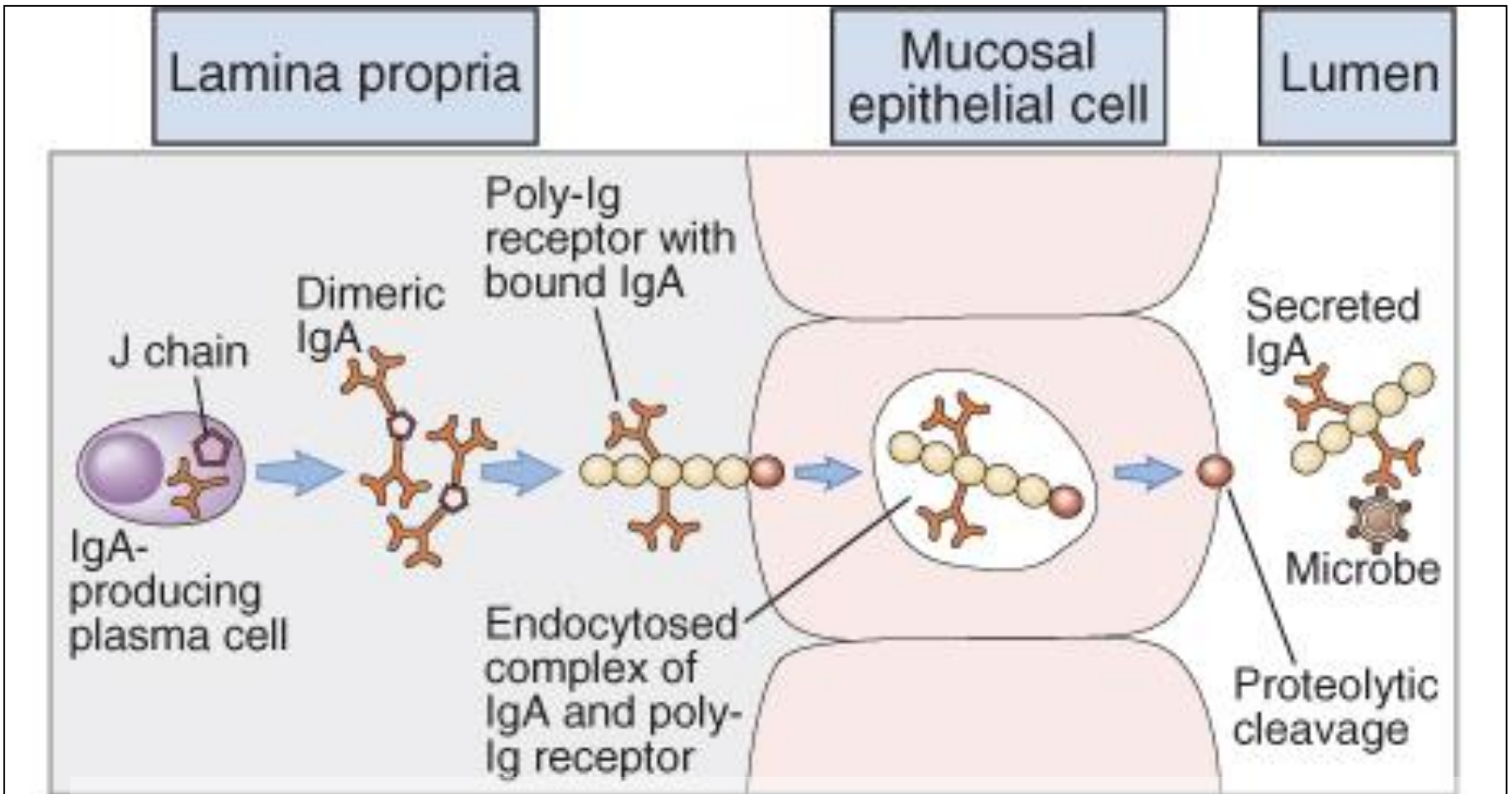

Figure 2.29



Formation of Secretory IgA



- **Affinity:** The strength of the binding between a single site of an antibody (one variable region) and an epitope.
- **Avidity:** The overall strength of interaction between antibody and antigen. The avidity depends on affinity and the valency of interactions.

Antibody affinity

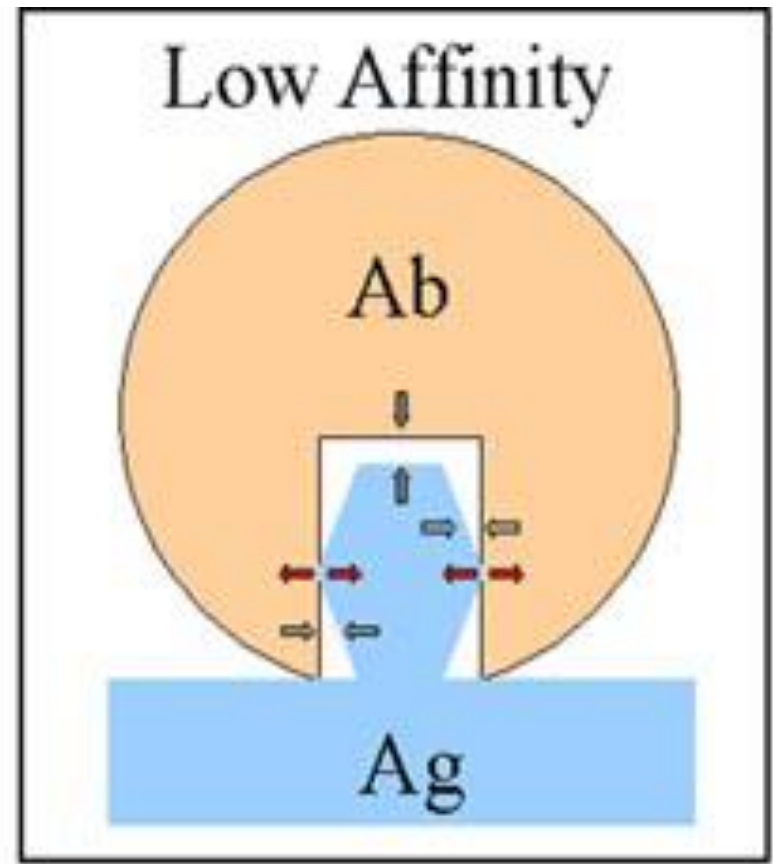
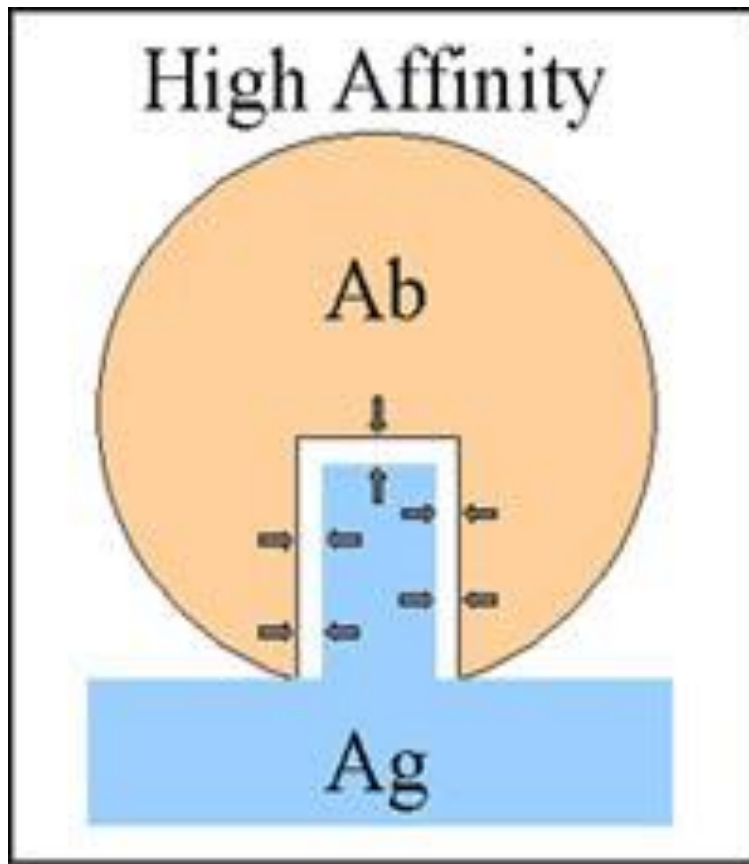

Affinity and avidity

IgA

IgG

IgM

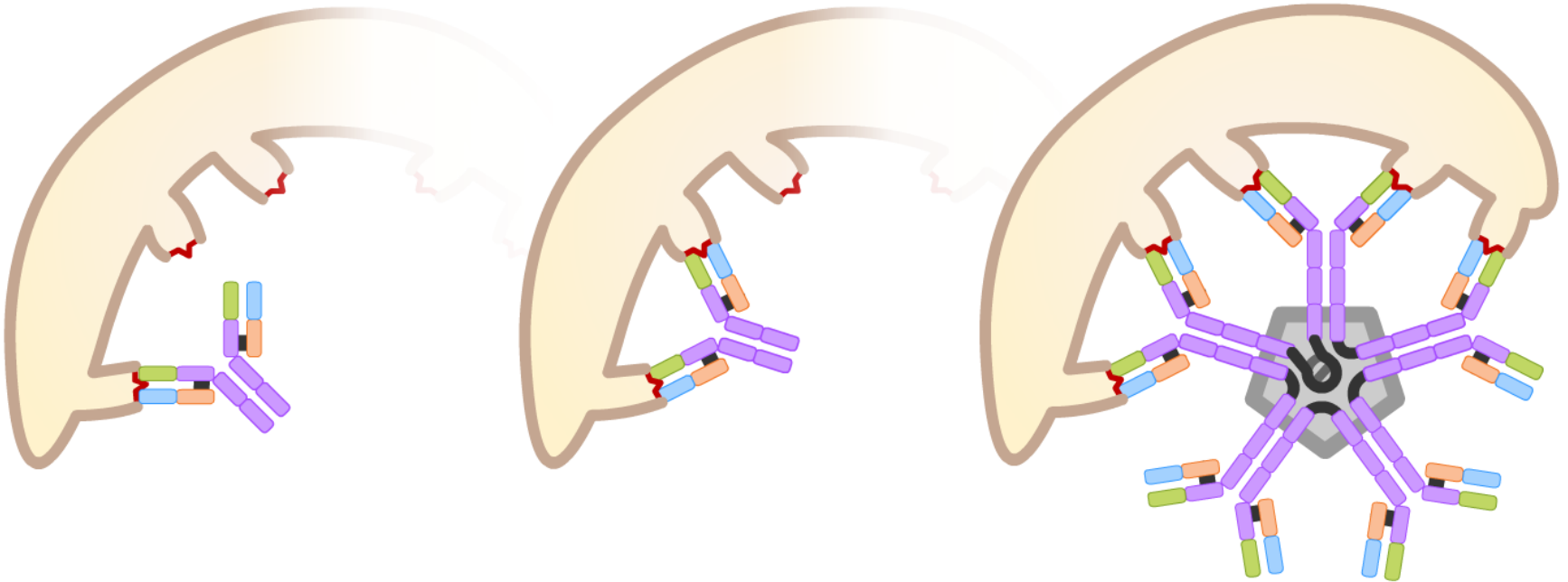

Biological functions of immunoglobulin molecules

- Activation of complement system (IgG, IgM)
- Opsonization (particularly IgG)
- Neutralization of antigens (IgG, IgA, IgM)
- Adherence interference (IgA, IgG)
- Antibody dependent cellular cytotoxicity (ADCC)
- Agglutination, precipitation (IgG, IgM)
- Mast cells degranulation (IgE)
- Transport through placenta (IgG)
- Immunoregulation (mainly IgG)

B Antibody isotype	Isotype specific effector functions
IgG	Neutralization of microbes and toxins Opsonization of antigens for phagocytosis by macrophages and neutrophils Activation of the classical pathway of complement Antibody-dependent cellular cytotoxicity mediated by NK cells Neonatal immunity: transfer of maternal antibody across placenta and gut Feedback inhibition of B cell activation
IgM	Activation of the classical pathway of complement
IgA	Mucosal immunity: secretion of IgA into lumens of gastrointestinal and respiratory tracts, neutralization of microbes and toxins
IgE	Antibody-dependent cellular cytotoxicity mediated by eosinophils Mast cell degranulation (immediate hypersensitivity reactions)

© Elsevier Ltd. Abbas & Lichtman: Basic Immunology 2E www.studentconsult.com

Antibody dependent cellular cytotoxicity (ADCC)

