

PHYSIOLOGY OF REPRODUCTION

Life is a dynamic system with focused behavior, with

autoreproduction, *characterized by flow of substrates,*

energy and information.

Reproduction in mammals (humans)

- 1) Sexual reproduction
- 2) Selection of partners
- 3) Internal fertilization
- 4) Viviparity
- 5) Eggs, resp. embryos – smaller, less, slow development, placenta
- 6) Low number of offspring, intensive parental care

Pregnancy (days)	
Mouse	20
Rat	23
Rabbit	31
Dog	63
Cat	65
Lion	107
Pig	114
Sheep	149
Human	260 - 275
Cow	285
Rorqual	360
Elephant (Indian)	609

High investment, low-volume reproduction strategy !

Reproduction in humans – gender comparison

- 1) Both male and female are born immature (physically and sexually)
 - 2) Differentiation of reproduction organs during prenatal period
 - 3) Hypothalamus – adenohipophysis – gonads in both gender, the same signals (hormones)
-
- 4) Different production of sex hormones during prenatal and perinatal periods
 - 5) Reproduction period (puberty - menopause) significantly differs
 - 6) Character of hormonal changes significantly differs – cyclic vs. non-cyclic

- Meiosis occurs only in germ cells and gives rise to male and female **GAMETES**
- Fertilization of an oocyte by an X- or Y-bearing sperm establishes the zygote's **GENOTYPIC SEX**
- Genotypic sex determines differentiation of the indifferent gonad into either an **OVARY** or a **TESTIS**
- The testis-determining gene is located on the Y chromosome (testis-determining factor, sex-determining region Y)
- Genotypic sex determines the **GONADAL SEX**, which in turn determines **PHENOTYPIC SEX** (fully established at puberty)
- Phenotypic differentiation is modified by endocrine and paracrine signals (testosterone, DHT, AMH)

SEX DIFFERENTIATION

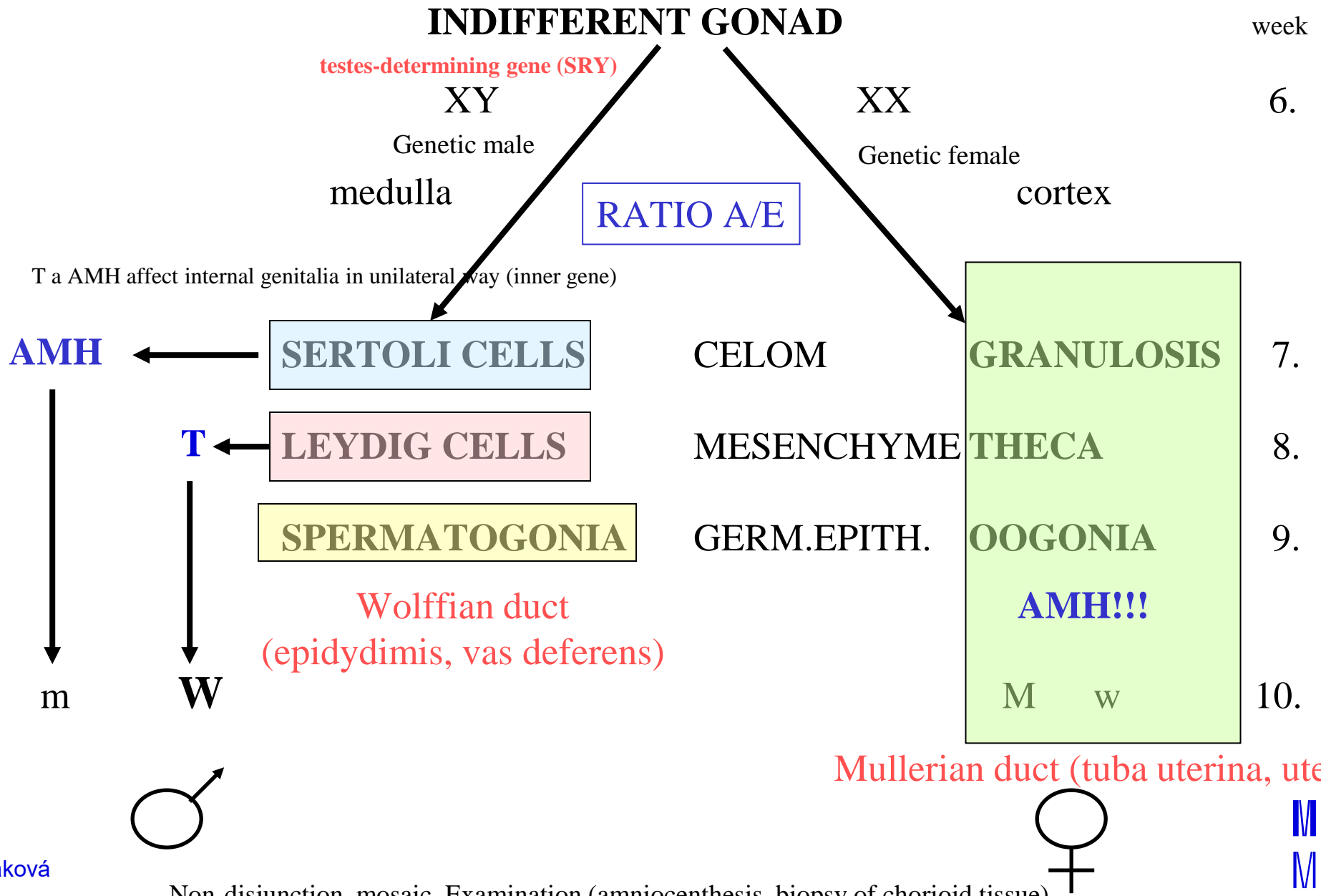

AMH (MIH, MIF, MIS, MRF) – ANTIMÜLLERIAN HORMONE

1940, TGF- β , receptor with internal TK activity

Source: Sertoli cells (5th prenatal week) or embryonal ovary (36th prenatal week)

In adult women – granulosa cells of small follicles (NO in antral – under influence of FSH - and atretic follicles)

Role in men:

- Regression of müllerian duct
- Marker of central hypogonadism

TUMOUR MARKER

Role in women:

- Lower plasmatic levels (by one order), till menopause
- Estimation of ovarian reserve (AMH level corresponds to pool of pre-antral follicles)
- Marker of ovarian functions loss (premature menopause)
- Diagnosing of polycystic ovaria syndrome

CRITICAL DEVELOPMENTAL PERIODS

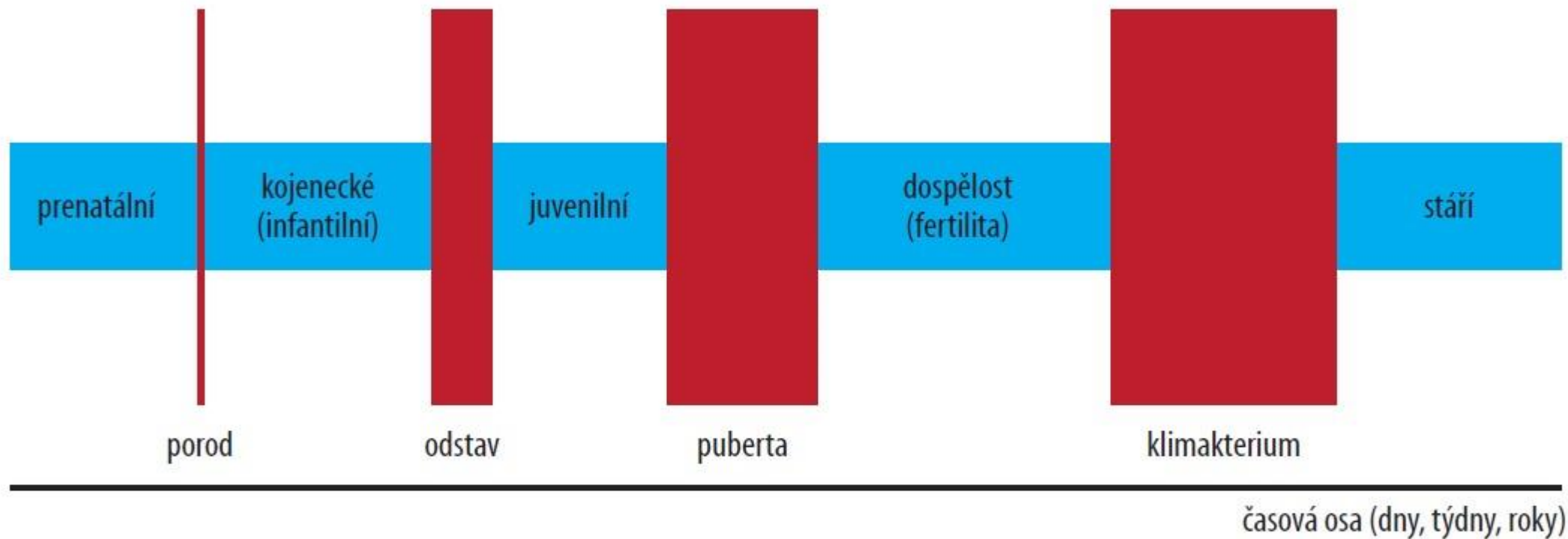

Obr. 2.1 *Kritické vývojové periody a kritické skoky*

Vybrané kapitoly z fyziologie, GRADA, 2022

CRITICAL DEVELOPMENTAL PERIODS

Critical body mass (critical amount of **adipose tissue/nutritional state**)

Puberty *Adrenarche*

- *Pubarche*
- *Gonadarche*
- *Spermarche*

- *Telarche*
- *Pubarche*
- *Menarche*

Pubertas praecox (central – gonadoliberin-dependent)
Pseudopubertas praecox (peripheral - gonadoliberin-independent)

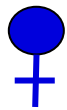

Late puberty

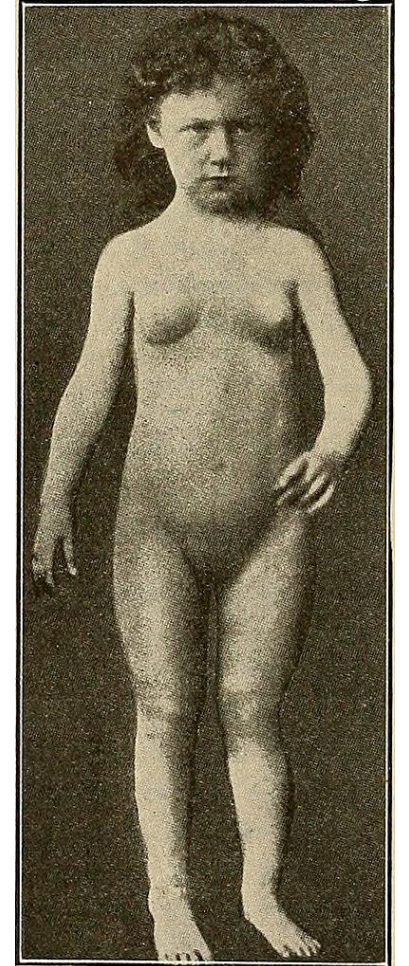

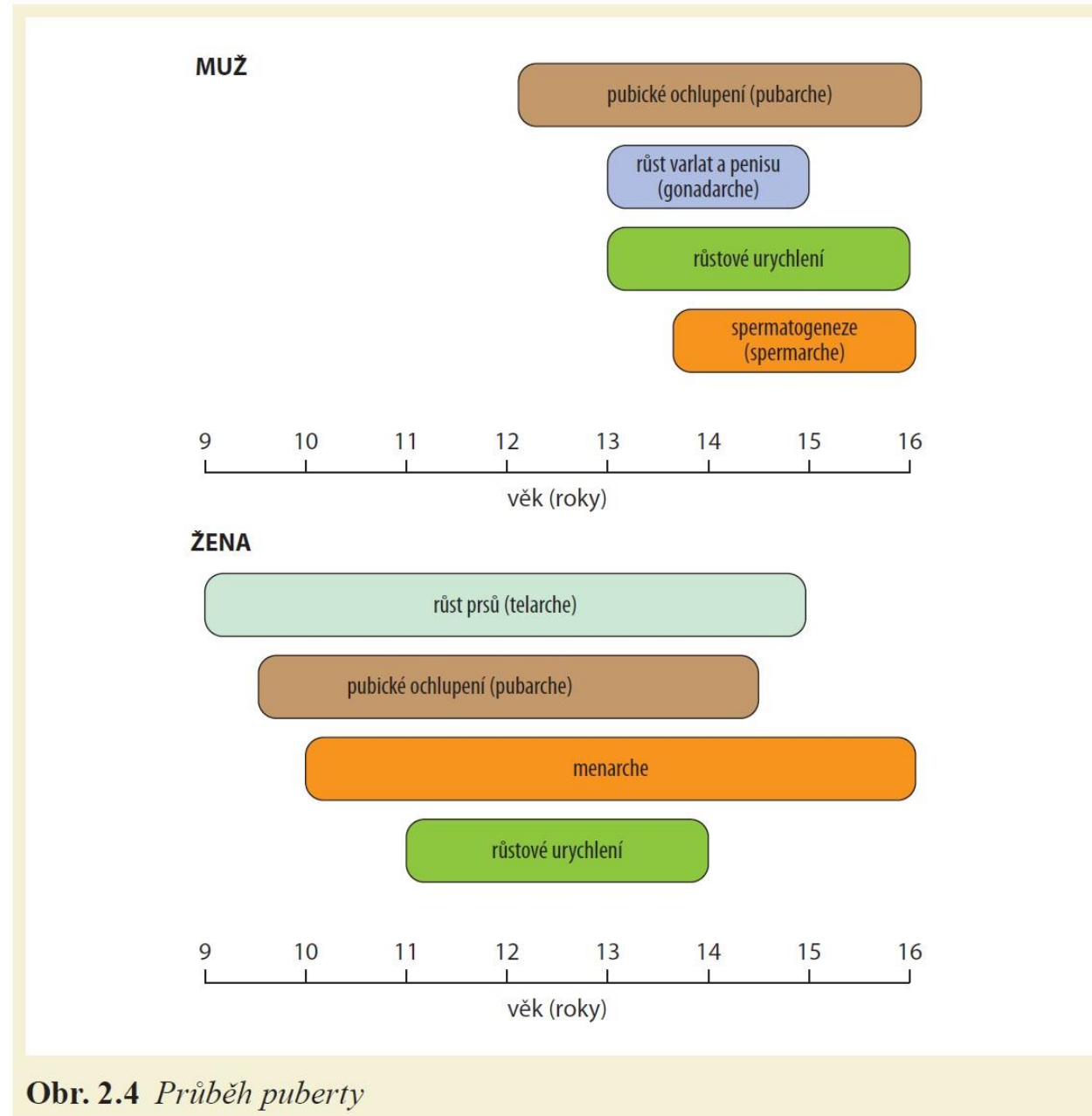

Obr. 2.4 Průběh puberty

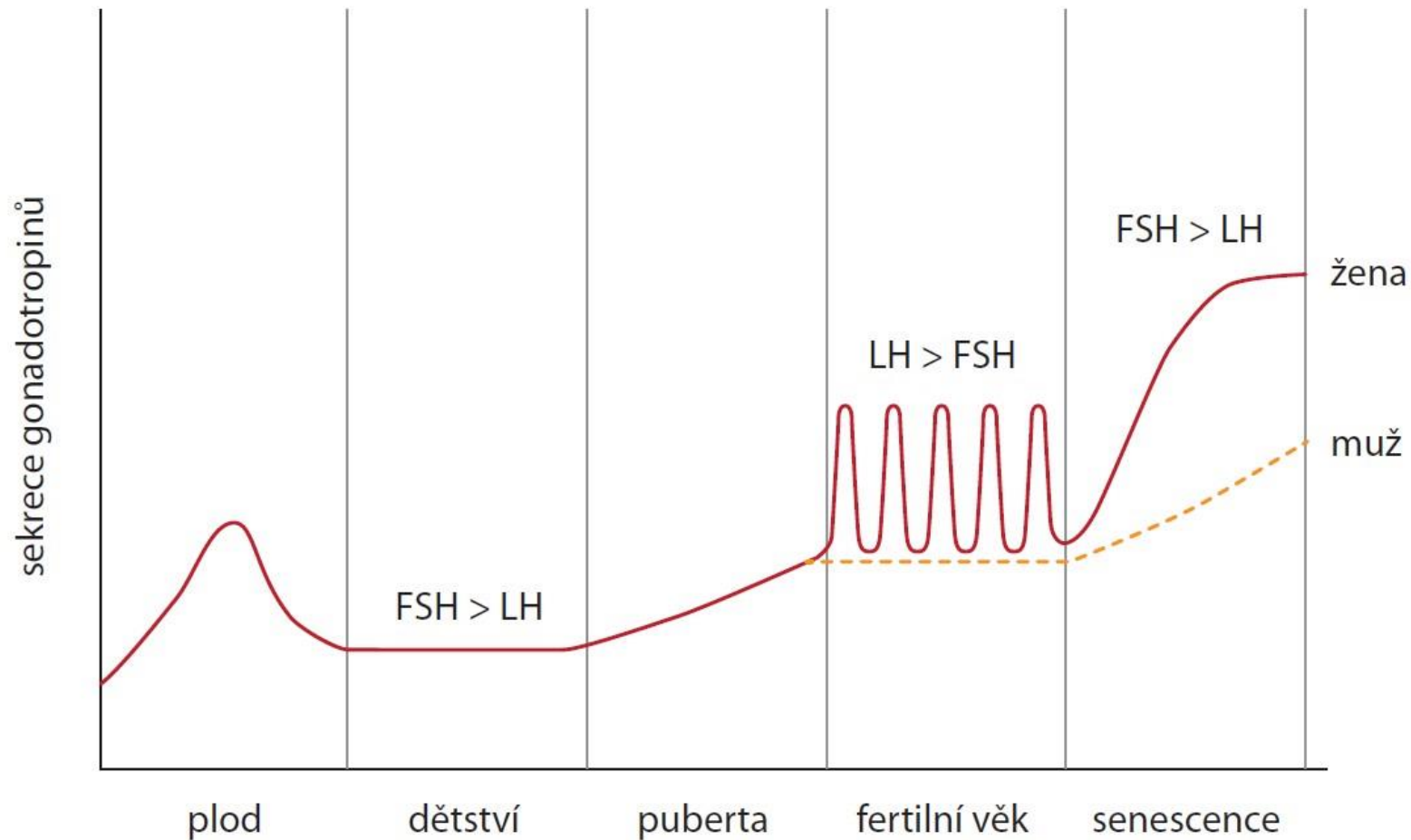

Obr. 2.3 *Sekrece gonadotropinů během života*

LEPTIN AND REPRODUCTION

Activation of reproductive system does not depend on age, but on nutritional state of organism.

LEPTIN: ob-protein, ob-gen, 7.chromosome
„λεπτος“ = thin, slim
polypeptide, 176 AA

Bound in **hypothalamus**: n.paraventricularis, suprachiasmaticus, arcuatus a dorsomedialis

Produced in: **adipocytes**, **placenta**, **mammal epithelium** (???)

Leptin plasmatic levels are sex-dependent (less in males) and do not depend on nutritional state

Leptin receptor: gene on 4.chromosome, 5 types of receptor, A-E
Receptor B – effect in **gonads and hypophysis**

Leptin is not only a factor of body fat amount, but affects also the regulation of neuroendocrine functions, including hypothalamo-hypophyseogonadal axis.

Effects of leptin on **testes** are not fully elucidated yet.

Testosterone and **dihydrotestosterone** suppress production of leptin in adipocytes!

REGULATION OF PUBERTY ONSET BY LEPTIN

Critical body mass (**critical nutritional state**).

Leptin plasmatic levels in pre-pubertal children are sex-independent.

Pre-pubertal „leptin resistance“ (relative).

In puberty, girls produce 2x more leptin per 1kg of adipose tissue than boys.

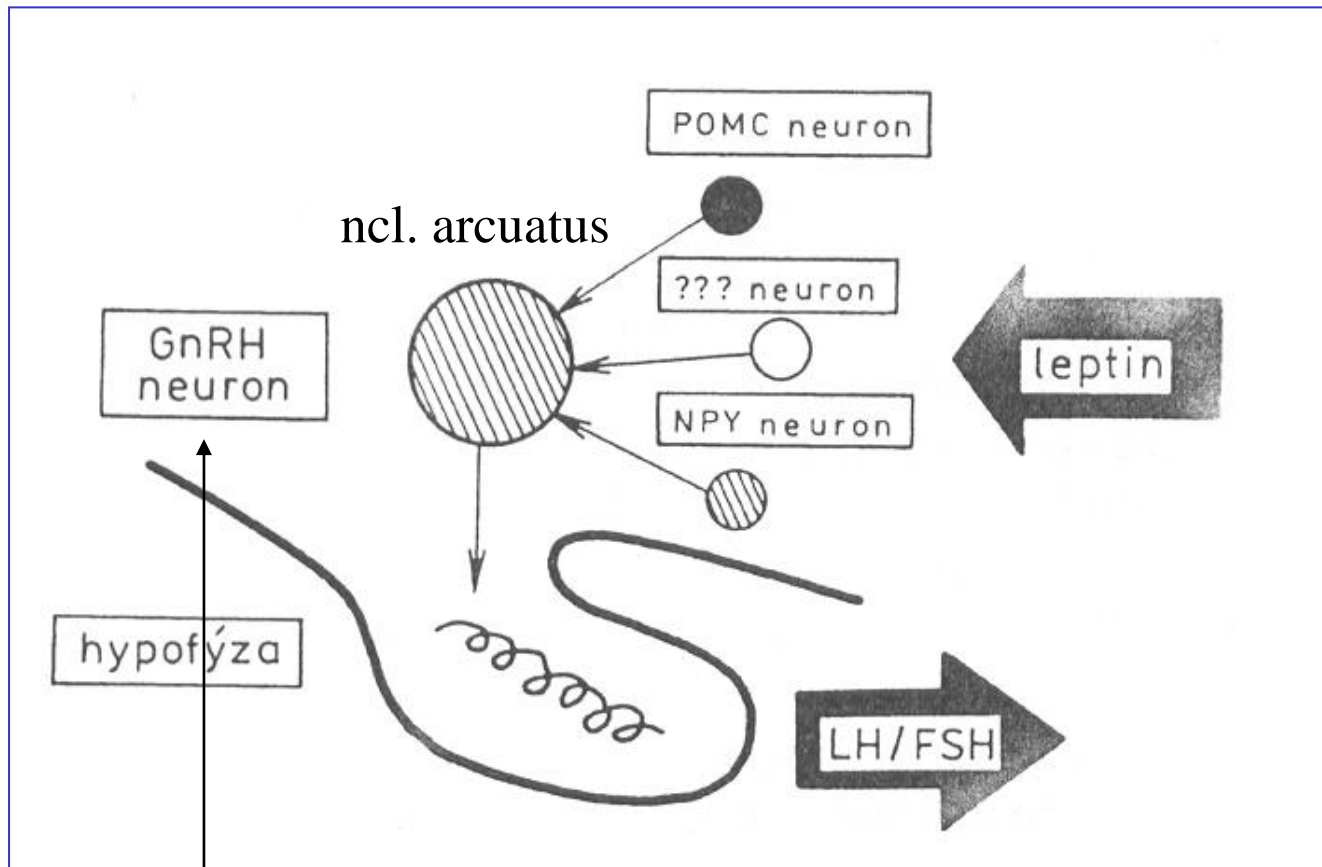

area preoptica - reproduction

Critical amount of adipose tissue – leptin – hypothalamus – LHRH – puberty

KISSPEPTIN

- Peptide, 54 AA
- Regulation of the puberty onset
- Control of GnRH secretion
- Produced also in placenta, syncytiotrophoblast, cytotrophoblast, decidua
- Released together with neurokinin B and dynorphin

- Increased expression of KISS1 gene
- Increased synthesis of kisspeptin
- Increased sensitivity of GnRH neurones to kisspeptin
- Pulsatory GnRH secretion

+

- Secretion of GH
- Decreased secretion of melatonin

PUBERTY

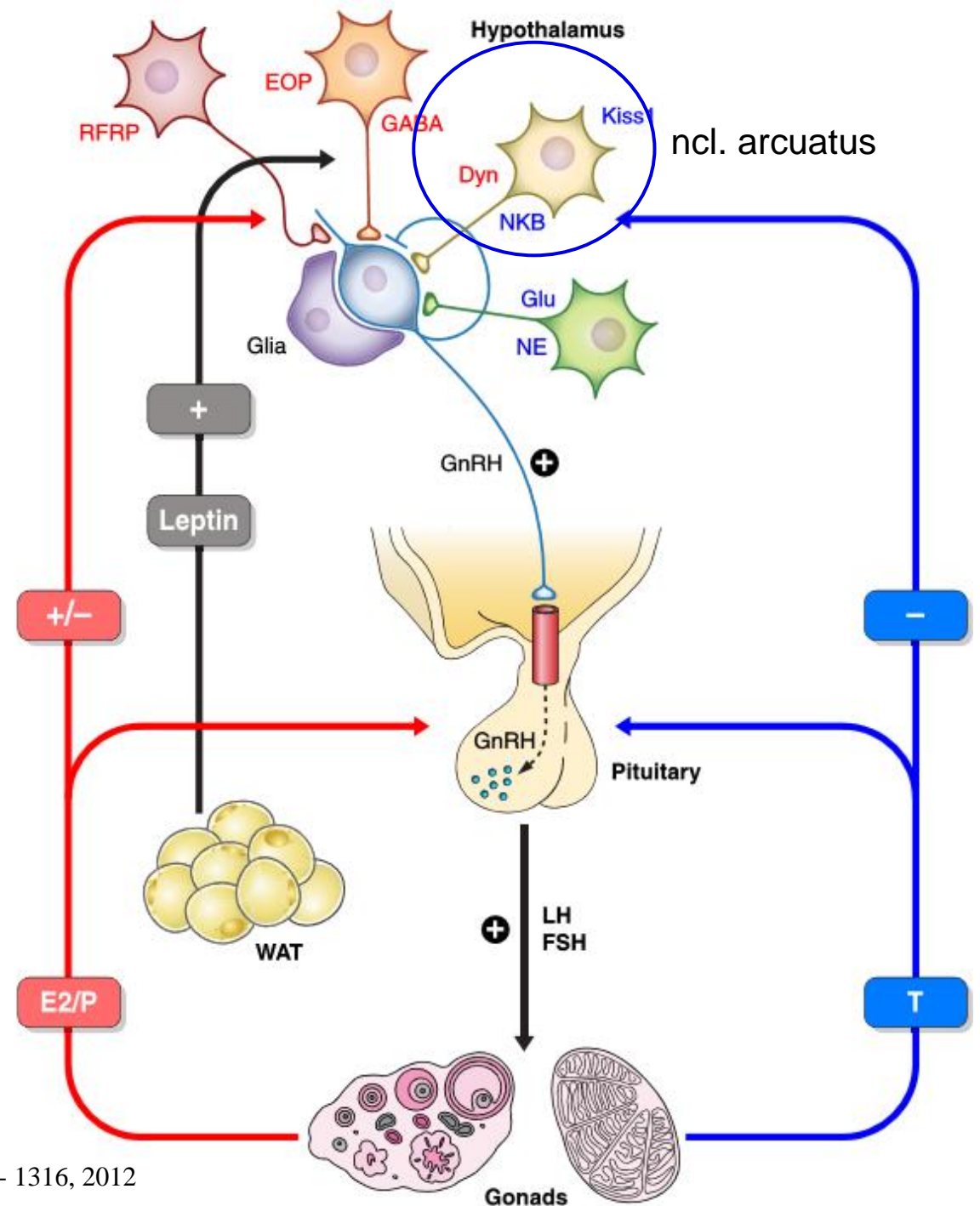

BIOSYNTHESIS OF STEROID HORMONES

Impact of androgens on CNS!

Adrenarche

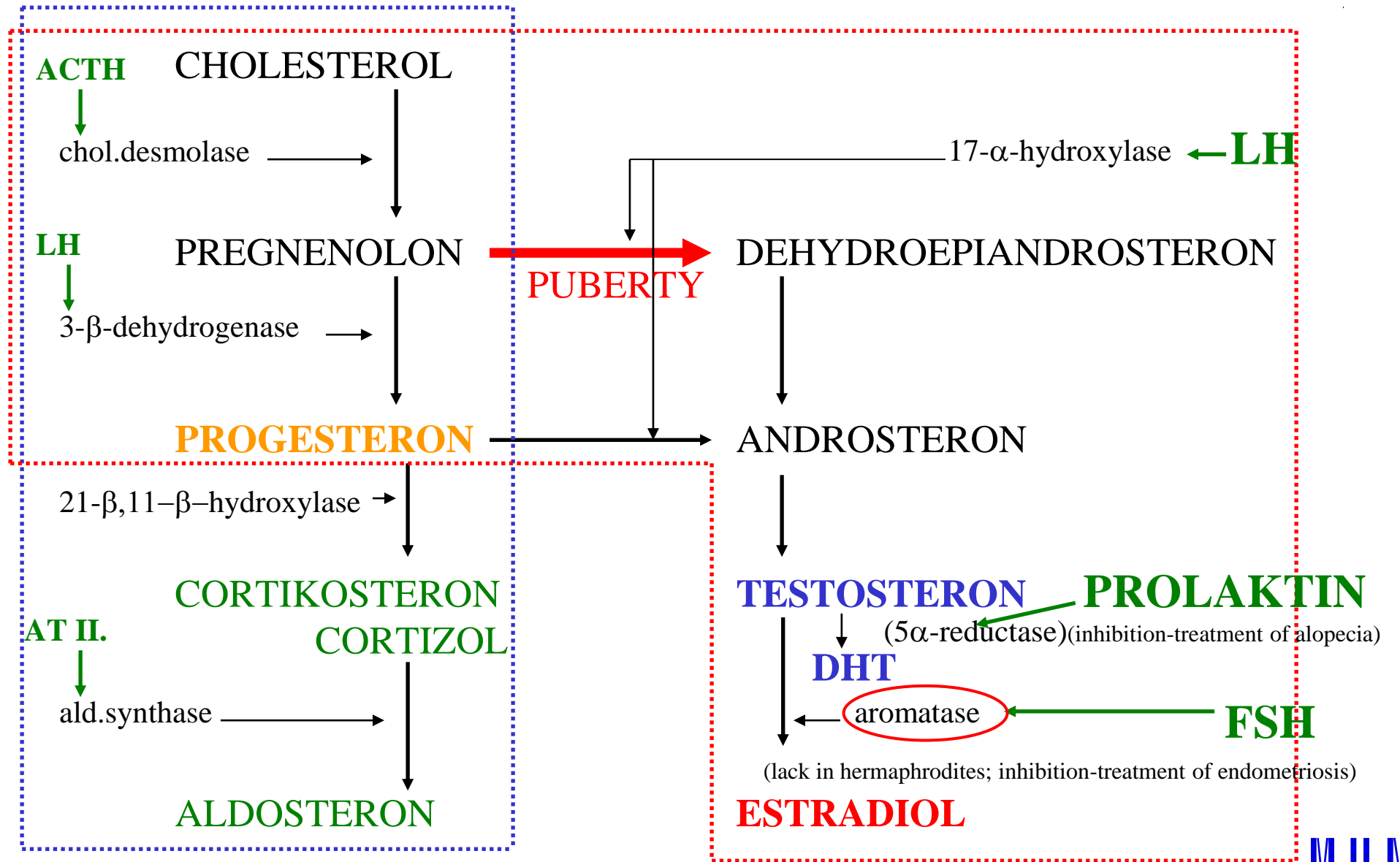

GONADOLIBERIN (GnRH, GONADOTROPIN-RELEASING HORMONE)

- Decapeptide, neurones in **ncl. arcuatus**, inputs from limbic system and other part of CNS related to emotions, smell and stress
- Pulsatory secretion (glycosylation)
- Receptor coupled to G-protein: gonadotrophs in adenohypophysis, lymphocytes, mamma, ovaries, prostate
- (GnRH-I, GnRH-II, (GnRH-III))
- **Stimulation** of secretion: kisspeptin, dopaminergic system in CNS, leptin
- **Inhibition** of secretion: dominating inhibitory effect of gonadal hormones with exception of estradiol (**negative-positive-negative** feedback), **malnutrition** (FA, glu), **lactation** (PRL), **seasonal effect**, **aging**, continual GnRH administration + **gonadostatin** (neuropeptide suppressing LH, FSH, reproductive functions and behaviour)

Control of gonadotrophins release - FSH, LH
Changed GnRH pulse frequency during the cycle

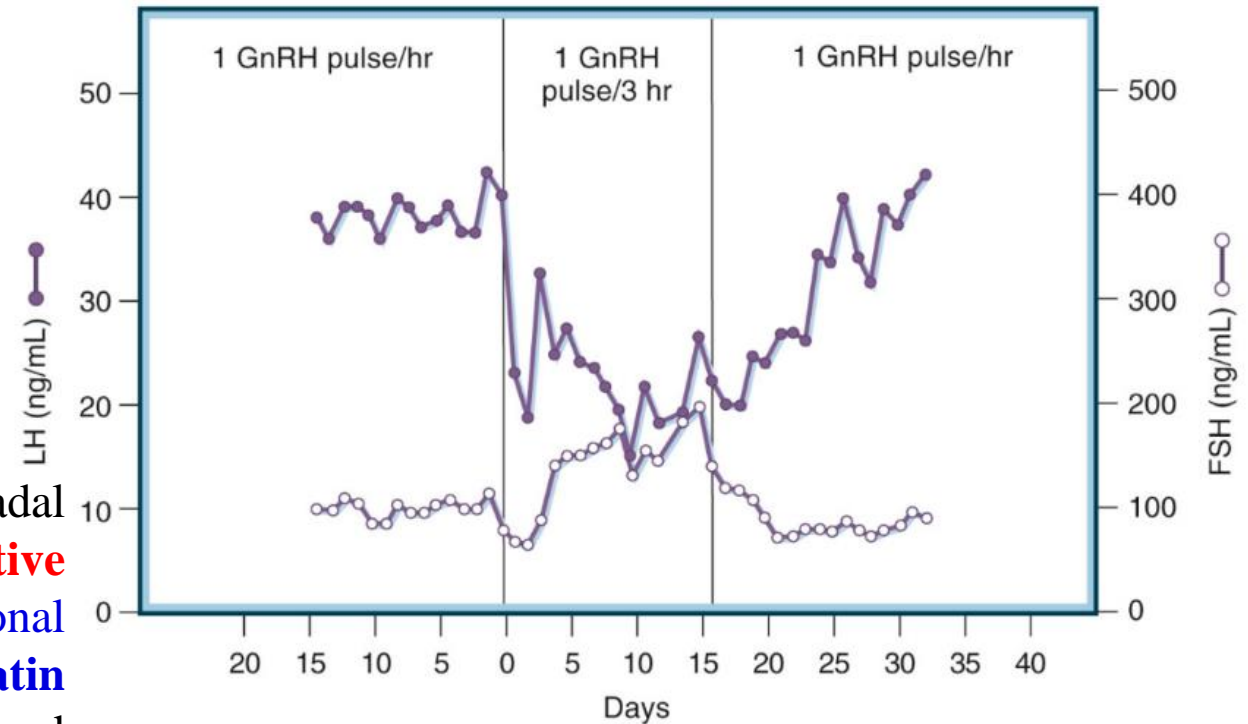

Acute stress – impairment (of cycle) without effect on fertility

Chronic stress – impaired fertility, decreased levels of circulating sex hormones

GONADOTROPHINS

LUTEINIZING HORMONE (LH)

- Heterodimeric glycoprotein
- Subunit alpha common for FSH, LF, TSH, hCG, subunit beta LH specific
- Pulsatory secretion
- Level of glycosylation affects biological half-time
- Structure similar to **hCG**
- Receptor coupled to G-protein: all ovarian cells, Leydig cells, uterus, semenné vâčky, prostate, mamma, skin, suprarenal gland, thyroid gland, retina, neuroendocrine cells
- Regulation of secretion: GnRH

FOLICLES STIMULATION HORMONE (FSH)

- Heterodimeric glycoprotein
- Subunit alpha common for FSH, LF, TSH, hCG, subunit beta FSH specific
- Pulsatory secretion
- Level of glycosylation affects biological half-time
- Receptor coupled to G-protein: granulosa cells, Sertoli cells, endometrium (in secretory phase)
- Regulation of secretion: GnRH, oestrogens, activin, inhibin, follistatin

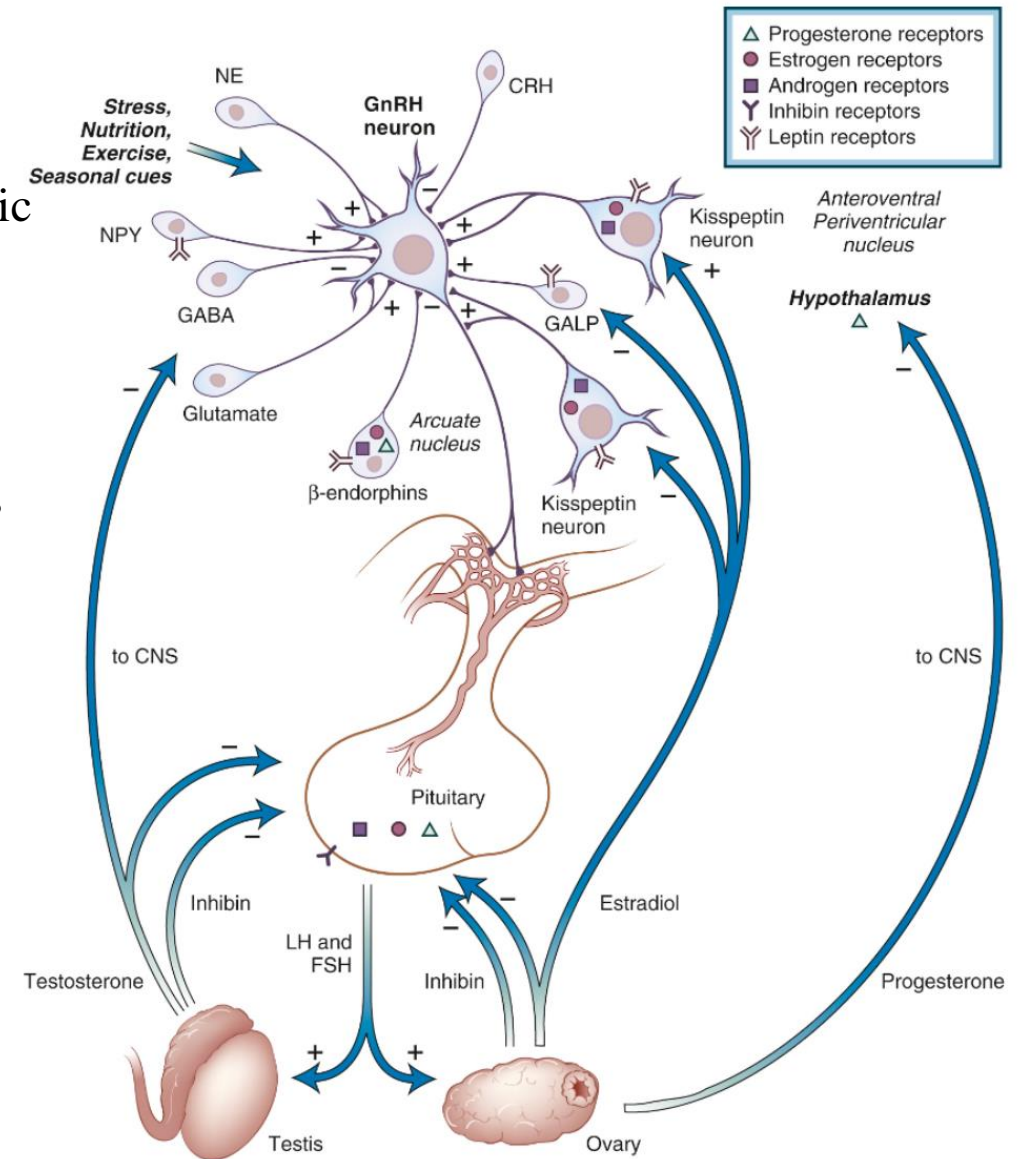

ADDITIONAL REGULATION OF GONADOTROPINS SECRETION (LH)

Activins = regulation of transcription

Inhibins and follistatin = inhibition of activins by binding on their receptor

Produced in gonads and also in CNS, suprarenal glands, medulla.

Inhibins

- heterodimeric glycoprotein ($\alpha + \beta_A$ or β_B)
- produced in women in hypophysis, ovaries and placenta, in men in Sertoli cells
- negative feedback on FSH production
- **inhibin A**
- **inhibin B** (testes)

Activins

- dimeric proteins similar to inhibin, **activin A, B, AB**
- stimulation of FSH production
- autocrine / paracrine factors
- important role in early stages of pregnancy

Follistatin

- glycoprotein
- inhibition of activin
- intragonadal autocrine/paracrine regulator
- expressed mainly in adenohypophysis

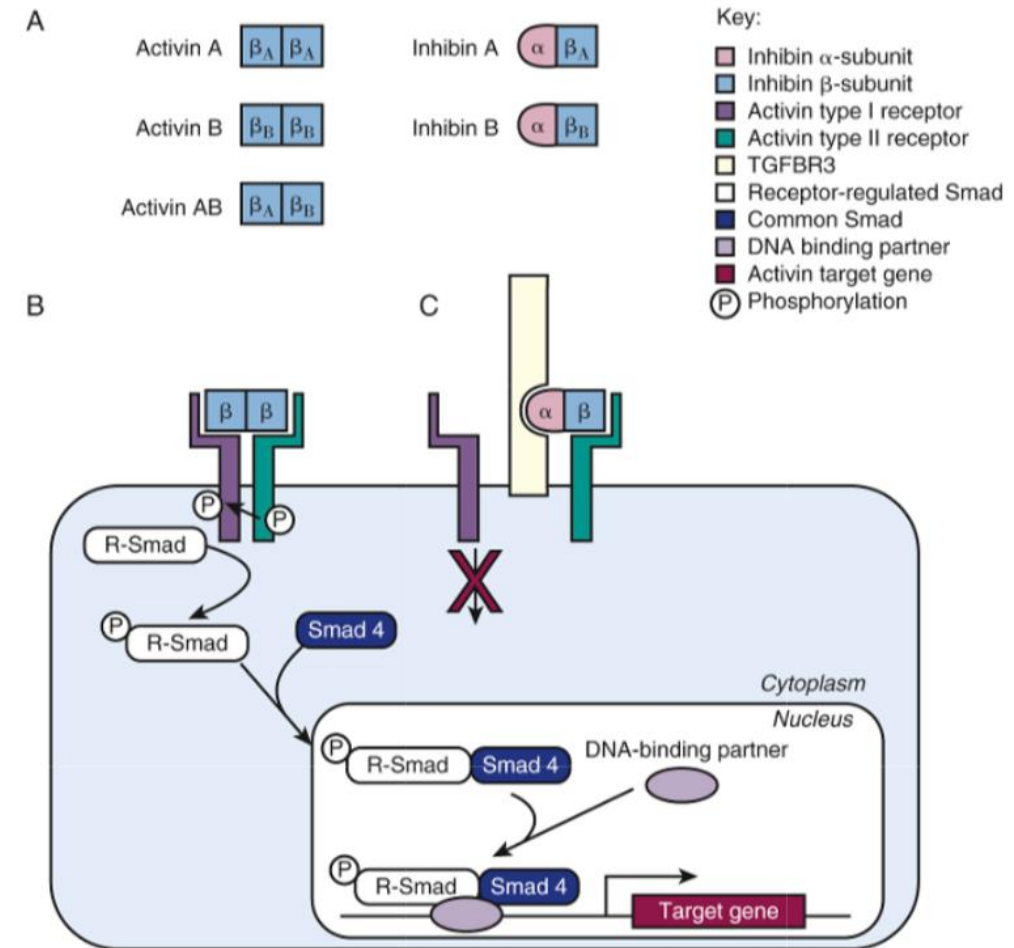

FSH and LH - functions

FEMALES

FSH

- Growth and development of **follicular cell (maturation)**
- **Biosynthesis of estradiol**
- Regulation of inhibin synthesis during follicular phase
- **Upregulation of LH receptors** (preovulatory follicles)
- **Selection of dominant follicle**
- **Recruitment of follicles for next cycle**

LH

- Stimulation of **oestrogen synthesis** at various levels (theca)
- **Oocyte maturation** (preovulatory follicle)
- Rupture of ovulatory follicle, **ovulation**
- Conversion of follicle wall to **corpus luteum**

MALES

LH

Intratesticular **synthesis of testosterone** (Leydig cells)

FSH

Spermatogenesis (Sertoli cells)

PROLACTIN - PRL

- Protein
- Lactotropic cells (only PRL)
- Mammosomatotrophic cells (PRL and GH)
- Hyperplasia – pregnancy and lactation
- Expression regulated by oestrogens, dopamine, TRH and thyroid gland hormones
- PRLR – mamma, adenohipophysis, suprarenal gland, liver, prostate, ovary, testis, small intestine, lungs, myocardium, SNS, lymphocytes

Regulation of secretion

- Pulsatile secretion: 4 – 14 pulses/day
- Highest levels during sleep
- Lowest levels between 10:00 and 12:00
- Gradual decrease of secretion during aging
- **STIMULATION:** TRH, serotonin, melatonin, oxytocin + stress, starving, coitus, pregnancy, pharmacological substances
- **INHIBITION:** dopamine

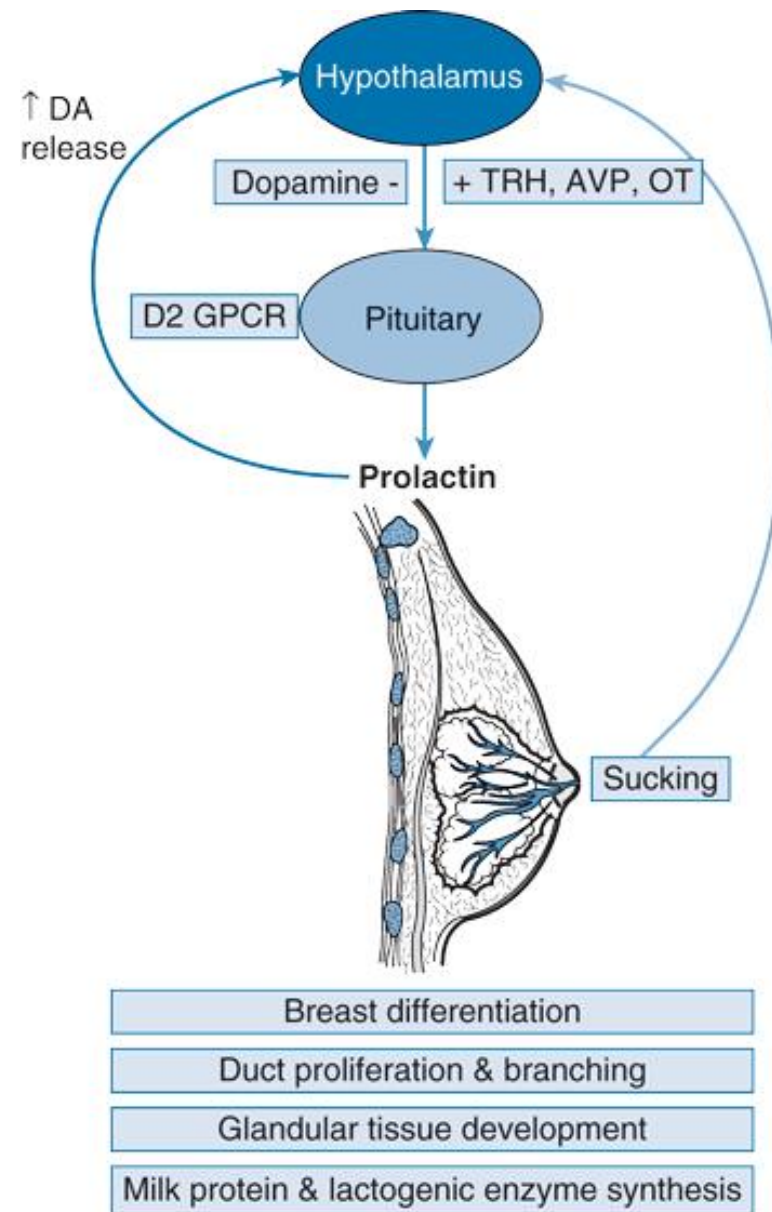

PROLACTIN - functions

MAIN FUNCTION: Milk production during pregnancy and lactation
= „survival“ function

PROLAKTIN AFFECTS PRODUCTION OF KISSPEPTIN.

Other functions – metabolic, synthesis of melanin, maternal behaviour

Breast development a lactation

- Puberty – mamma development under the effects of GH a IGF-1
- Effect of oestrogens and progesterone
- Age of 8 – 13
- During pregnancy – proliferation of alveoli and proteosynthesis (proteins of milk and colostrum)
- During the 3rd trimester – production of colostrum (PRL, oestrogens, progesterone, GH, IGF-1, placental hormones)
- Lactation – increase in PRL post-partum, without sucking drop after approx. 7 days
- Milk accumulation prevents further PRL secretion

Reproductive function of PRL

- Lactation = amenorrhea and secondary infertility
- Inhibition of GnRH secretion

REGULATION OF SEX HORMONES SECRETION – simplified scheme

Stress
 Exercise
 Seasonal variation
 Nutritional state

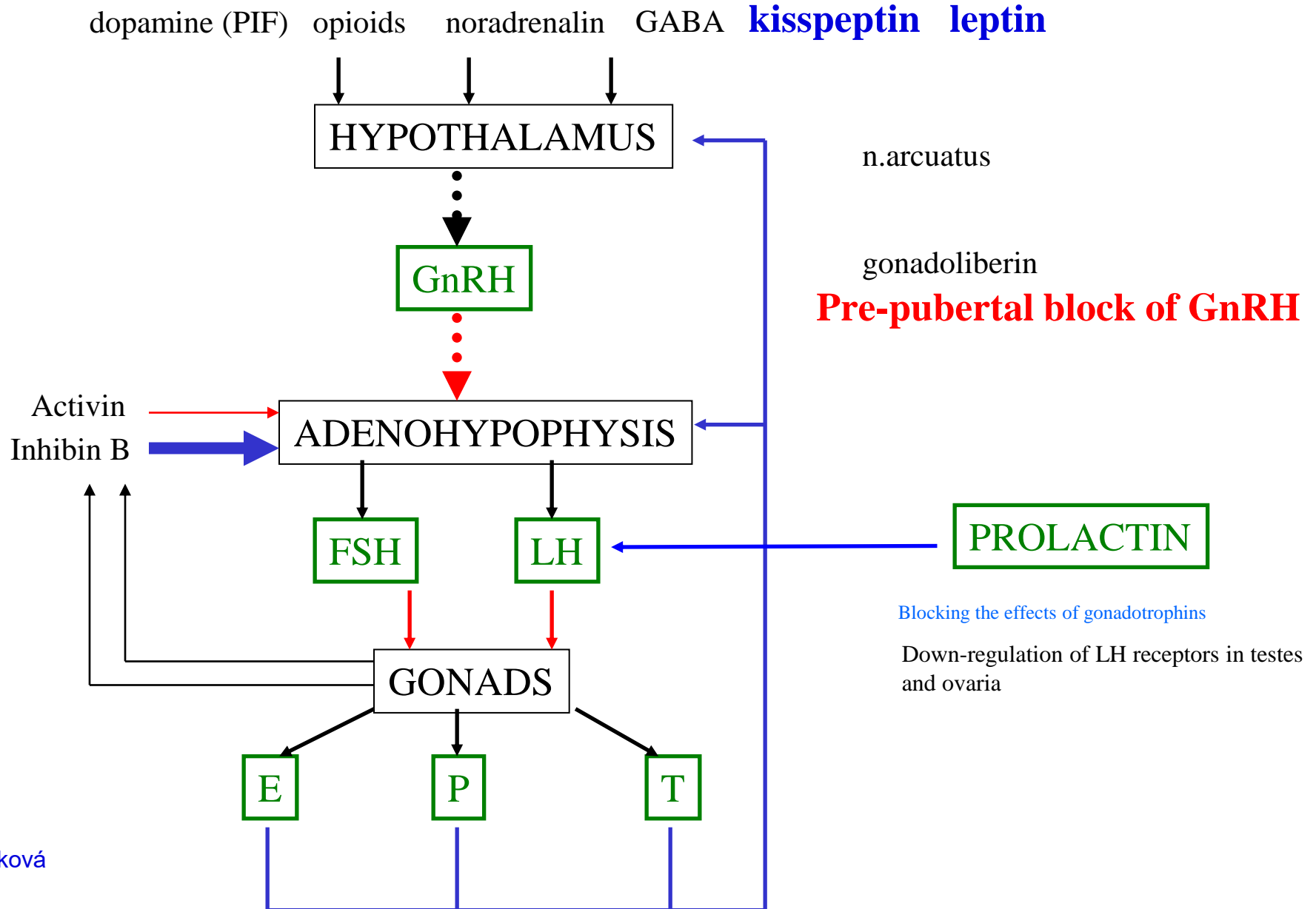

MALE REPRODUCTION SYSTEM

HUMOURAL CONTROL OF REPRODUCTIVE FUNCTIONS IN MAN

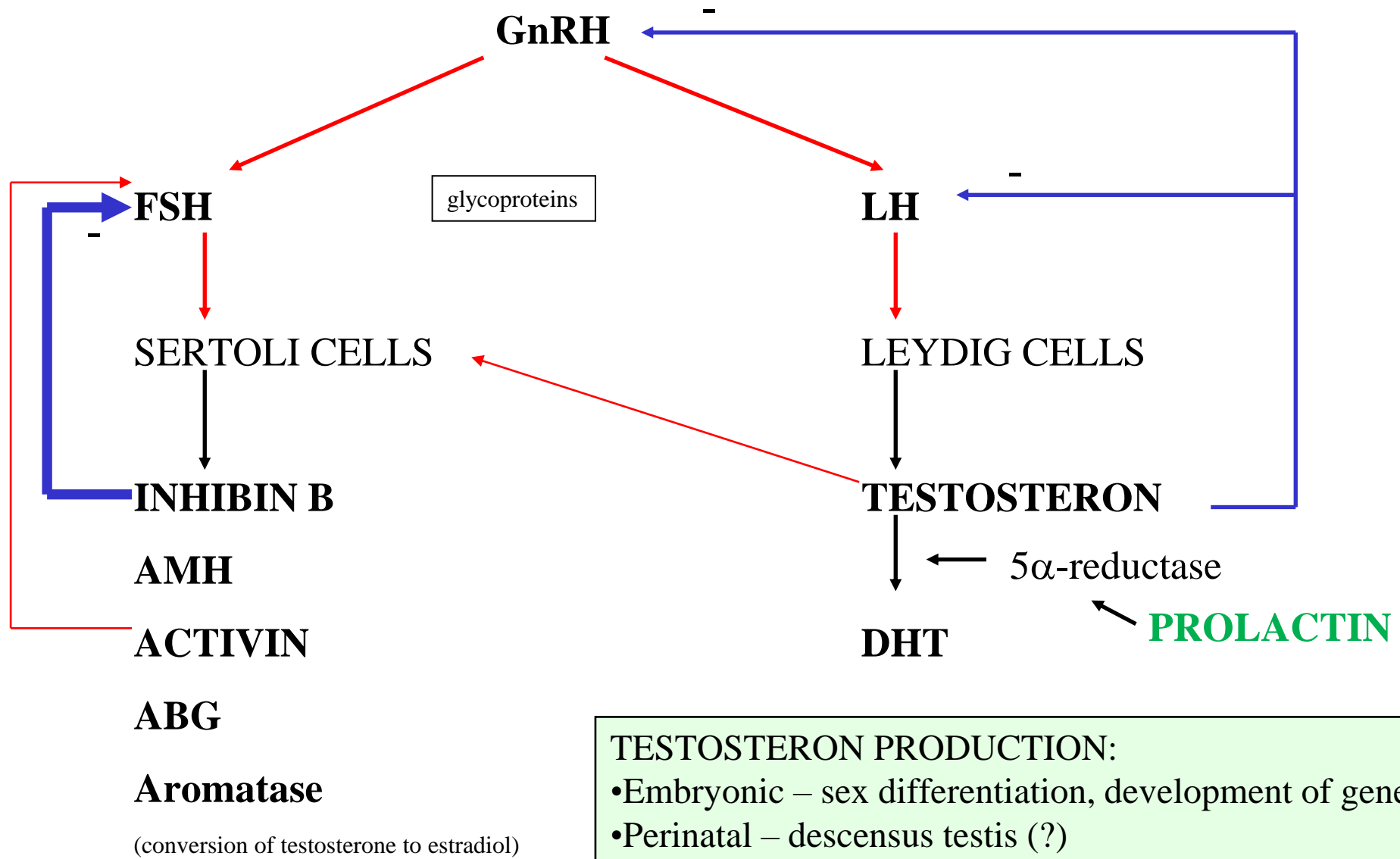

TESTOSTERON PRODUCTION:

- Embryonic – sex differentiation, development of generative organs
- Perinatal – descensus testis (?)
- Fertile period – LH pulsation
- Ageing – decrease of sensitivity to LH

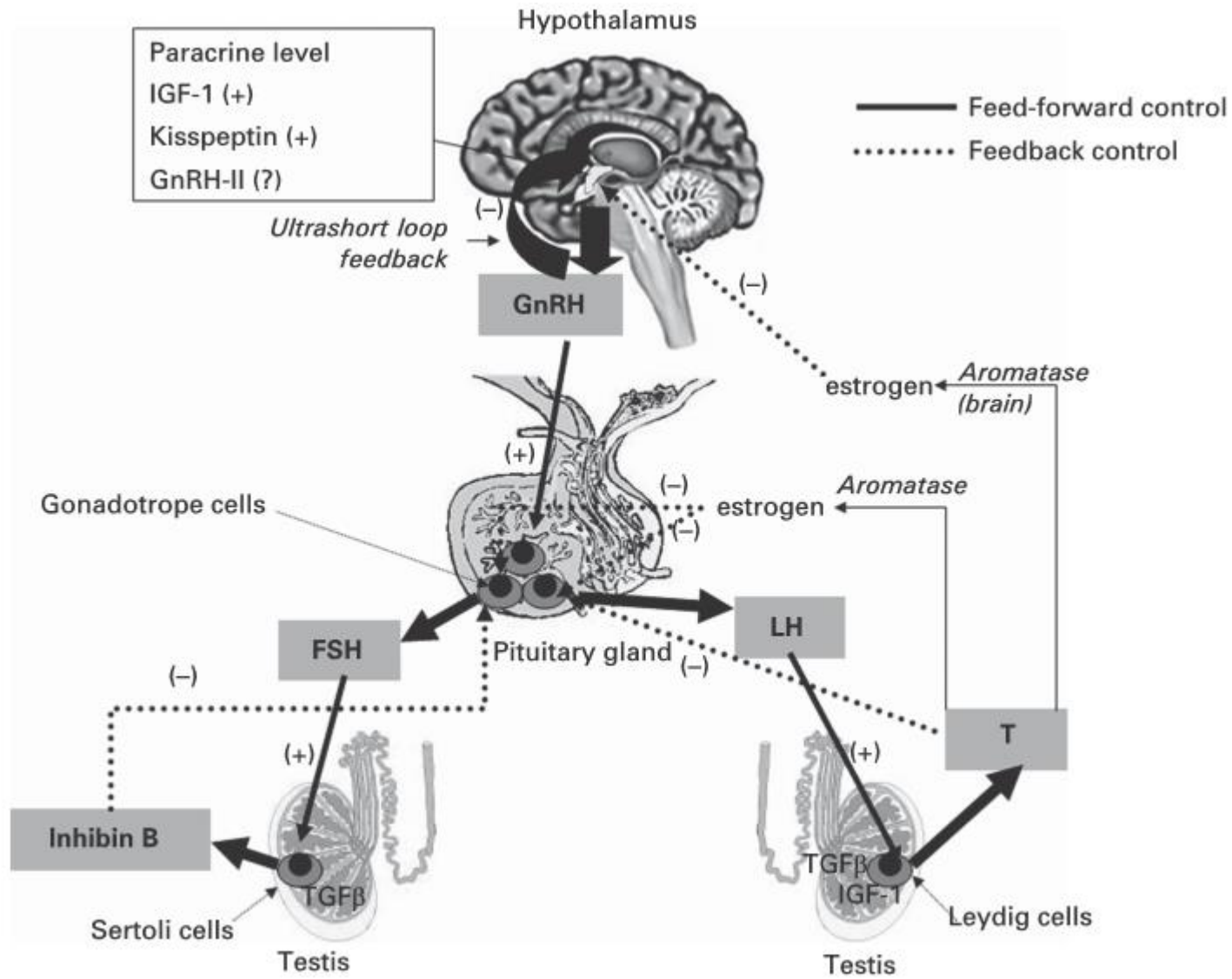

An Introduction to Male Reproductive Medicine
 Edited by Craig Niederberger

Table 1.1 Regulation of hypothalamic–pituitary–gonadal axis hormone release

Hormone	Autocrine regulation	Paracrine regulation	Endocrine regulation
GnRH	GnRH itself (–)	GnRH II (+), IGF-1 (+), kisspeptin (+)	Testosterone (–), estrogens (–), neurotensin (+), norepinephrine (+)
FSH	–	Activin (+), follistatin (–)	GnRH (+), estrogens (–), inhibin B (–)
LH		Activin (+), follistatin (–)	GnRH (+), testosterone (–)
Testosterone	–	IGF-1 (+), GH(+), CRH (–), TGF- β (–), IL-1 α (\pm)	LH (+)

+ Stimulatory effect, – Inhibitory effect. Transforming growth factor- β (TGF- β), corticotropin-releasing hormone (CRH), interleukin 1 α (IL-1 α), growth hormone (GH), insulin-like growth factor 1 (IGF-1).

SPERMATOGENESIS

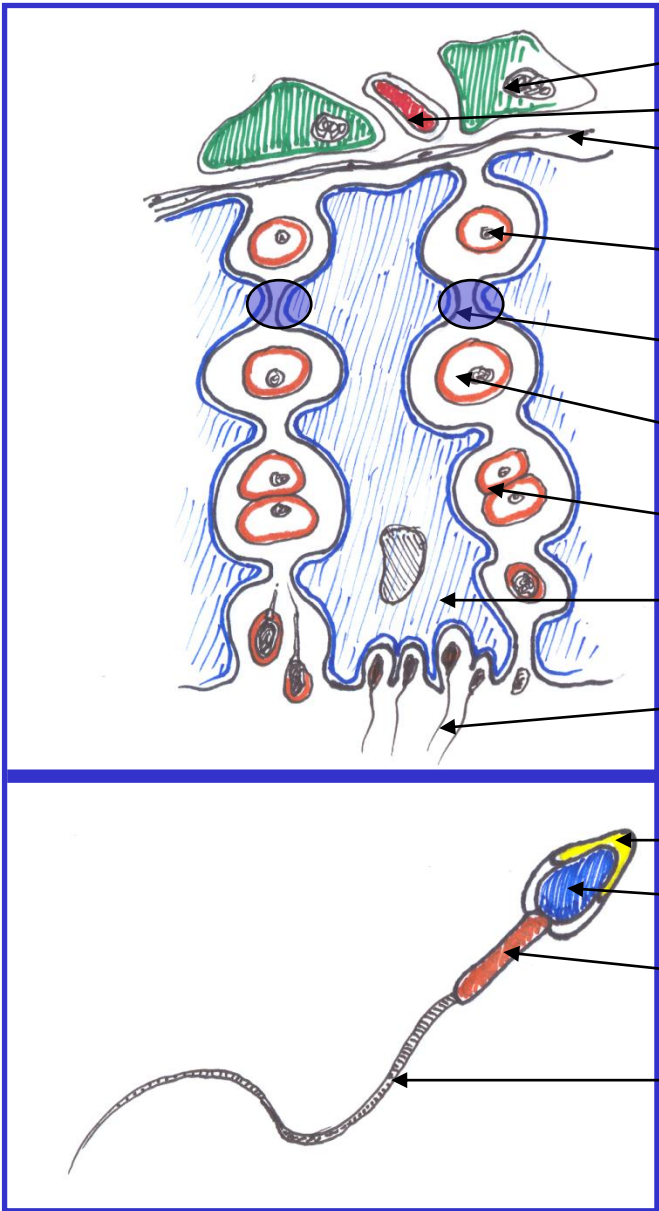

- Leydig cell
- Capillary
- Basal membrane
- Spermatogonium
- Tight junction**
- Spermatocyte
- Spermatide (haploid)
- Sertoli cell (contraction)
- Spermia

70 days
 1-64 (6 divisions)
 Temperature < 35°C

- Acrosom (enzymes)
- Head (nucleus, DNA)
- Body (mitochondria)
- Flagella (microtubules, 9+2)

Lumen:
 androgens, estrogens
 glutamate, aspartate
 inositol

PRODUCTION OF SPERM

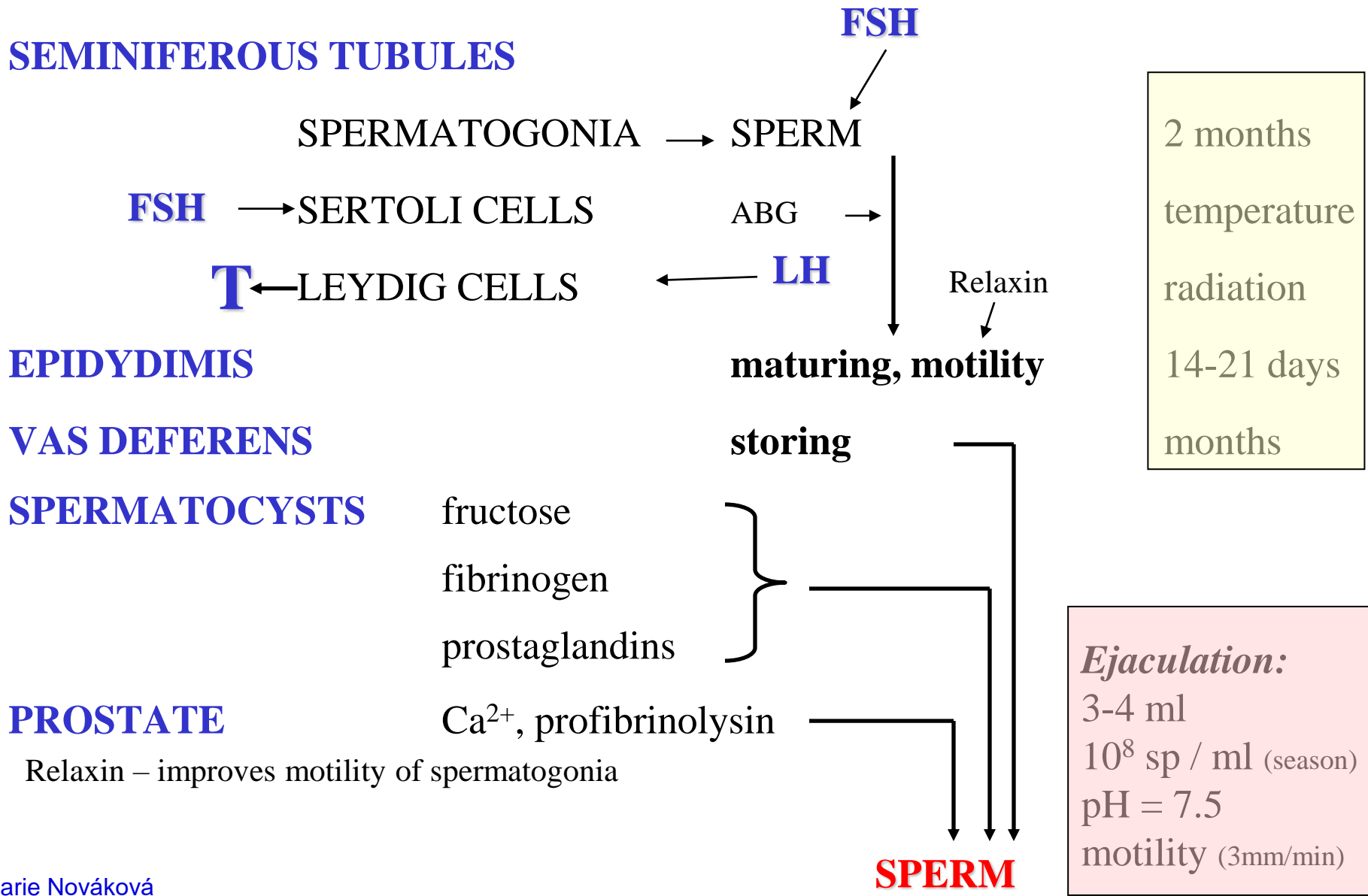

SPERMIOGRAM

Volume	1,5 - 2,0
pH	7,2 - 8,0
Concentration of sperm	20 mil/ml
Total number of sperm	40 mil and more
Motility	50% and more in category A+B, above 25% in A
Morphology	30% and more of normal forms
Vitality	75% and more of living sperm
Leukocytes	up to 1 mil/ml
Autoagglutination	< 2 (scale 0 - 3)

SEXUAL REFLEXES

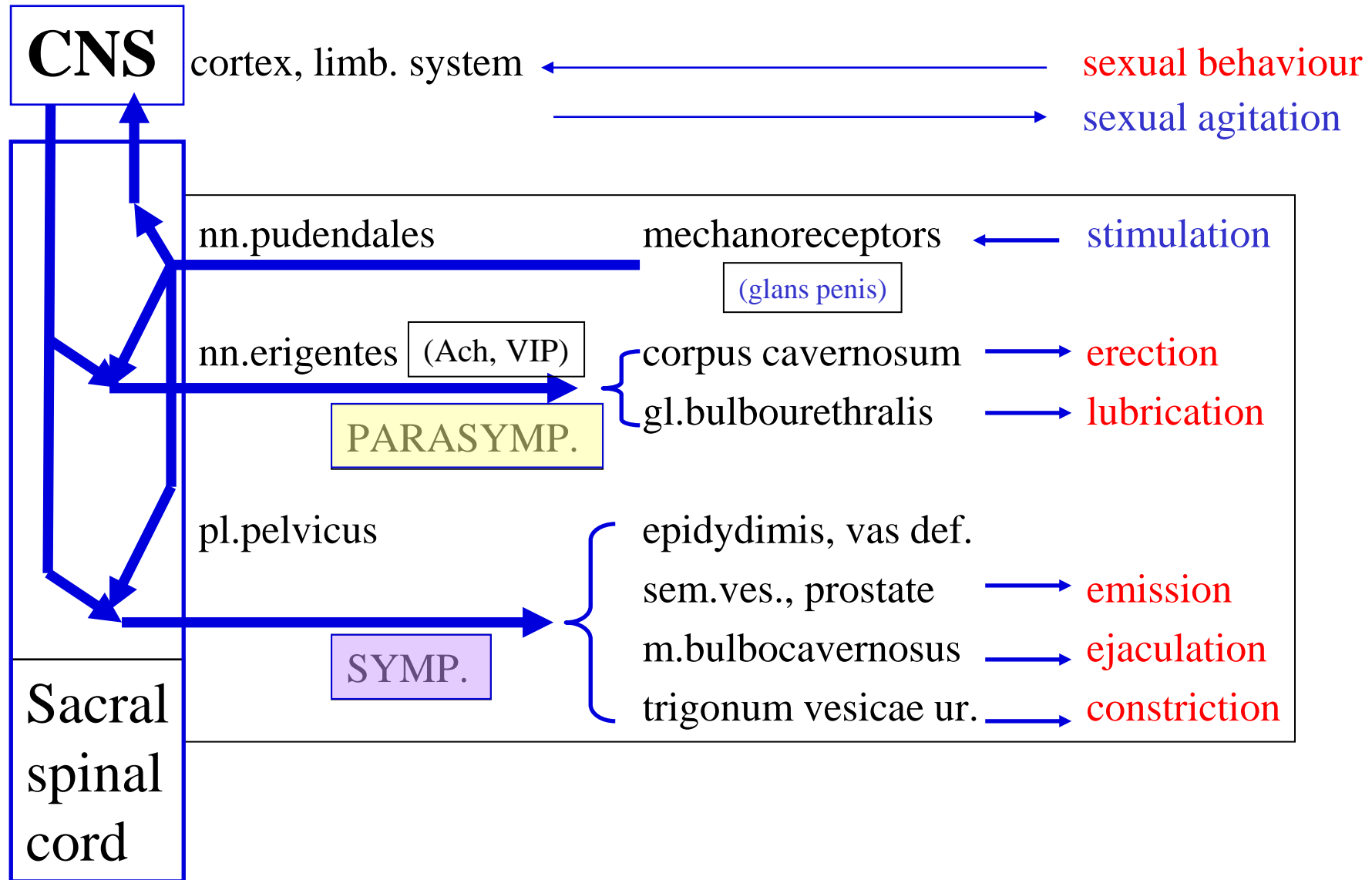

FEMALE REPRODUCTION SYSTEM

O O G E N E S I S

DEVELOPMENT

6-8 weeks

GERMINAL EPITHELIUM

Hormonally
independent

O O G O N I A
mitotic division

F O L L I C L E
P R I M O R D I A L

24 weeks

O O C Y T E S I .

7×10^6

1. meiosis
prophase

2×10^6

birth

Hormonally
dependent
(cyclic)

puberty

O O C Y T E S I I .
haploid
2. meiosis
metaphase
O V U M

3×10^5
D O M I N A N T
A T R E T I C
G R A A F
O V U L A T I O N

2. meiosis – end

menopause

0

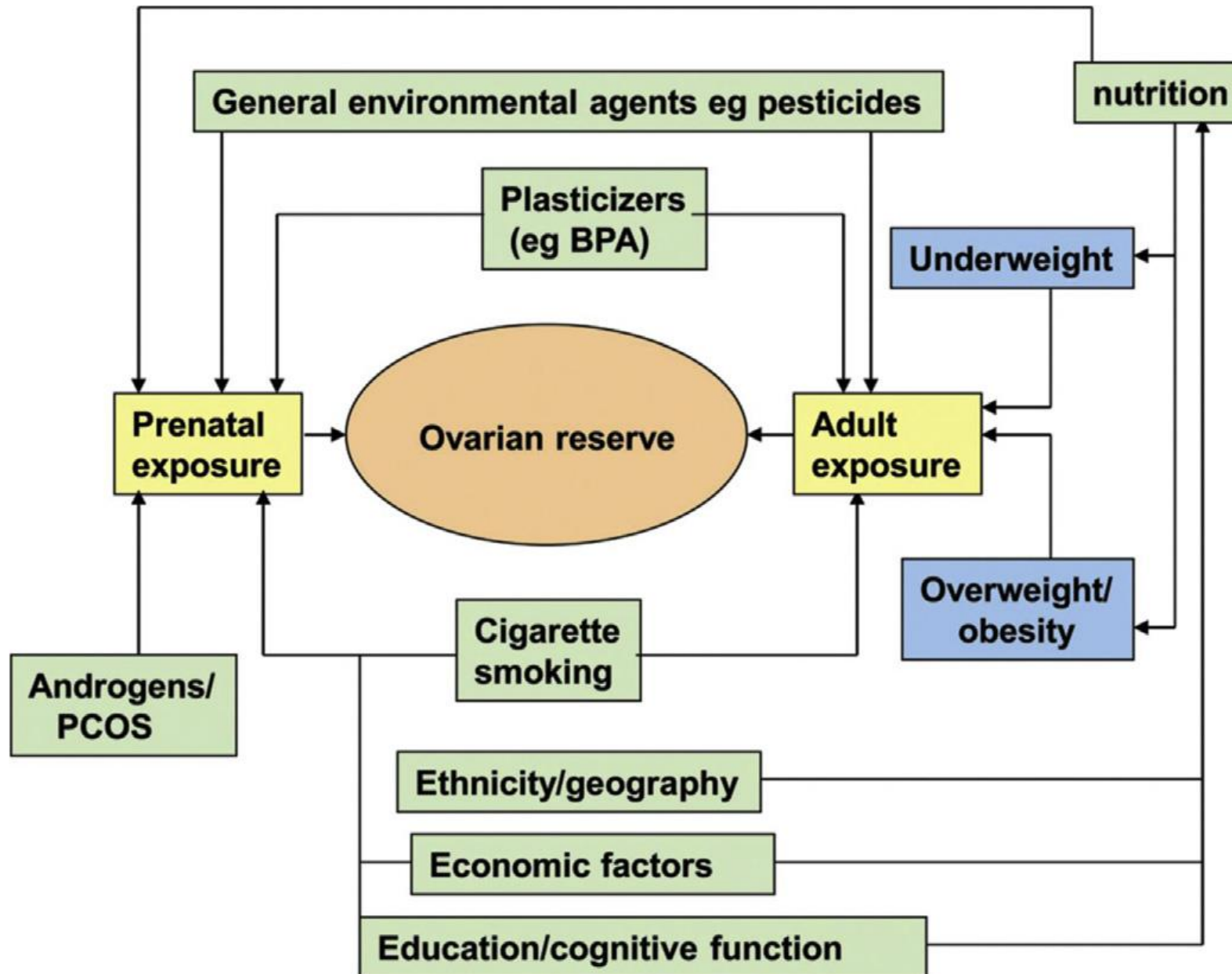

Daan and Fauser, *Maturitas* 82 (2015) 257–265

RECRUITMENT

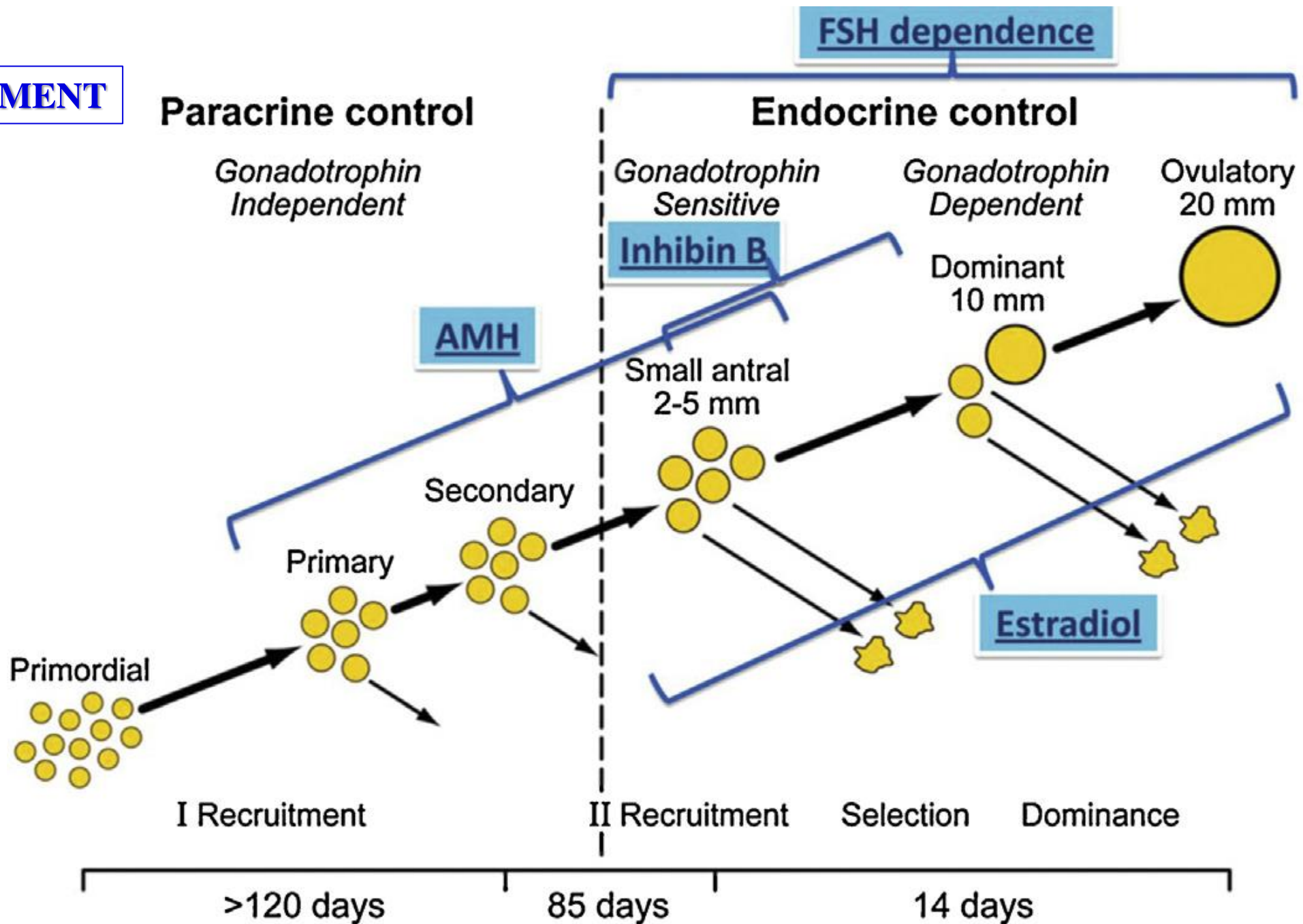

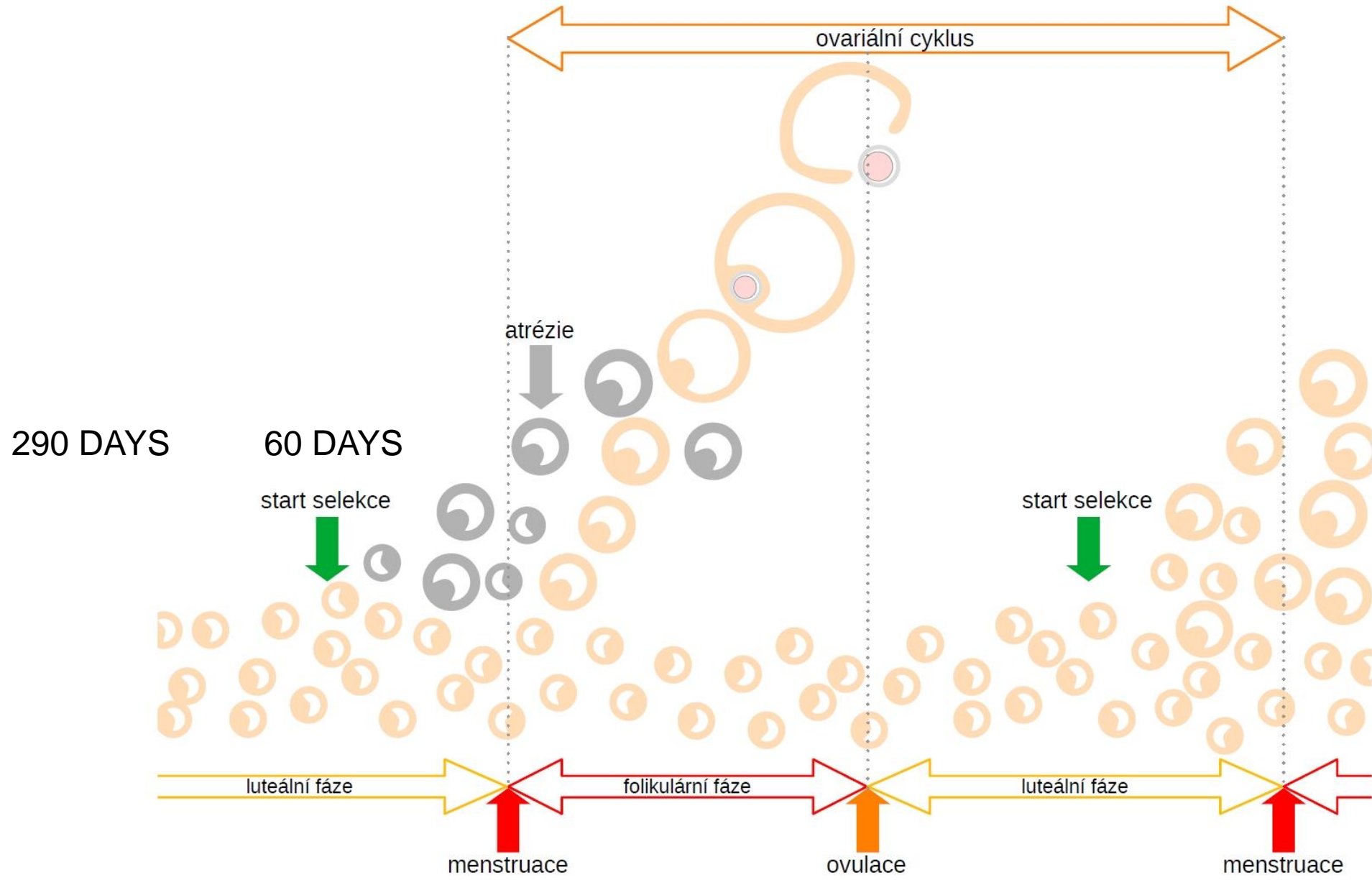

OVARIAN CYCLE

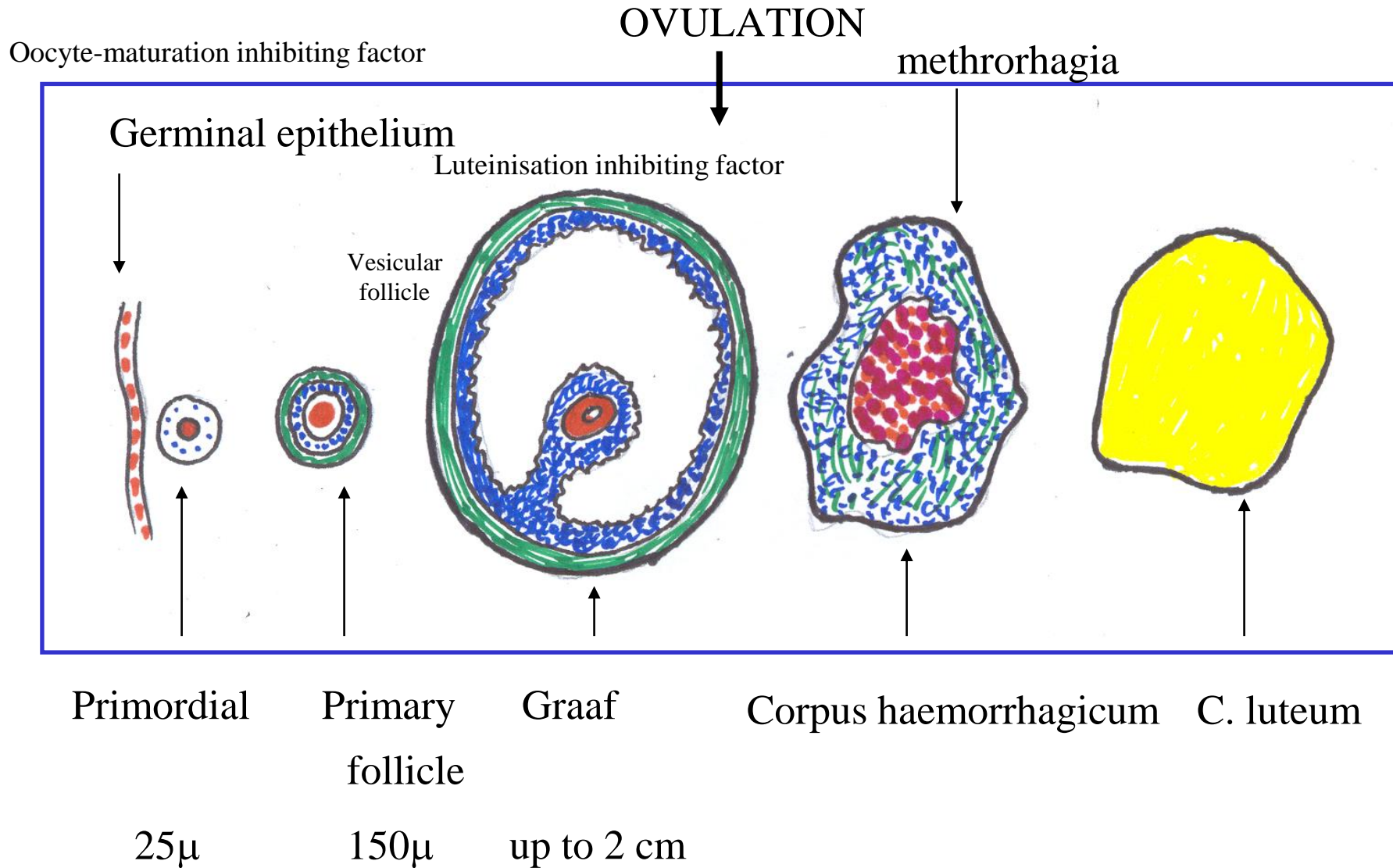

CYCLIC CHANGES

ovarian

uterine

+ vagina/cervix uteri

+ mamma

GnRH

FSH, LH

estradiol

progesteron

basal temper.

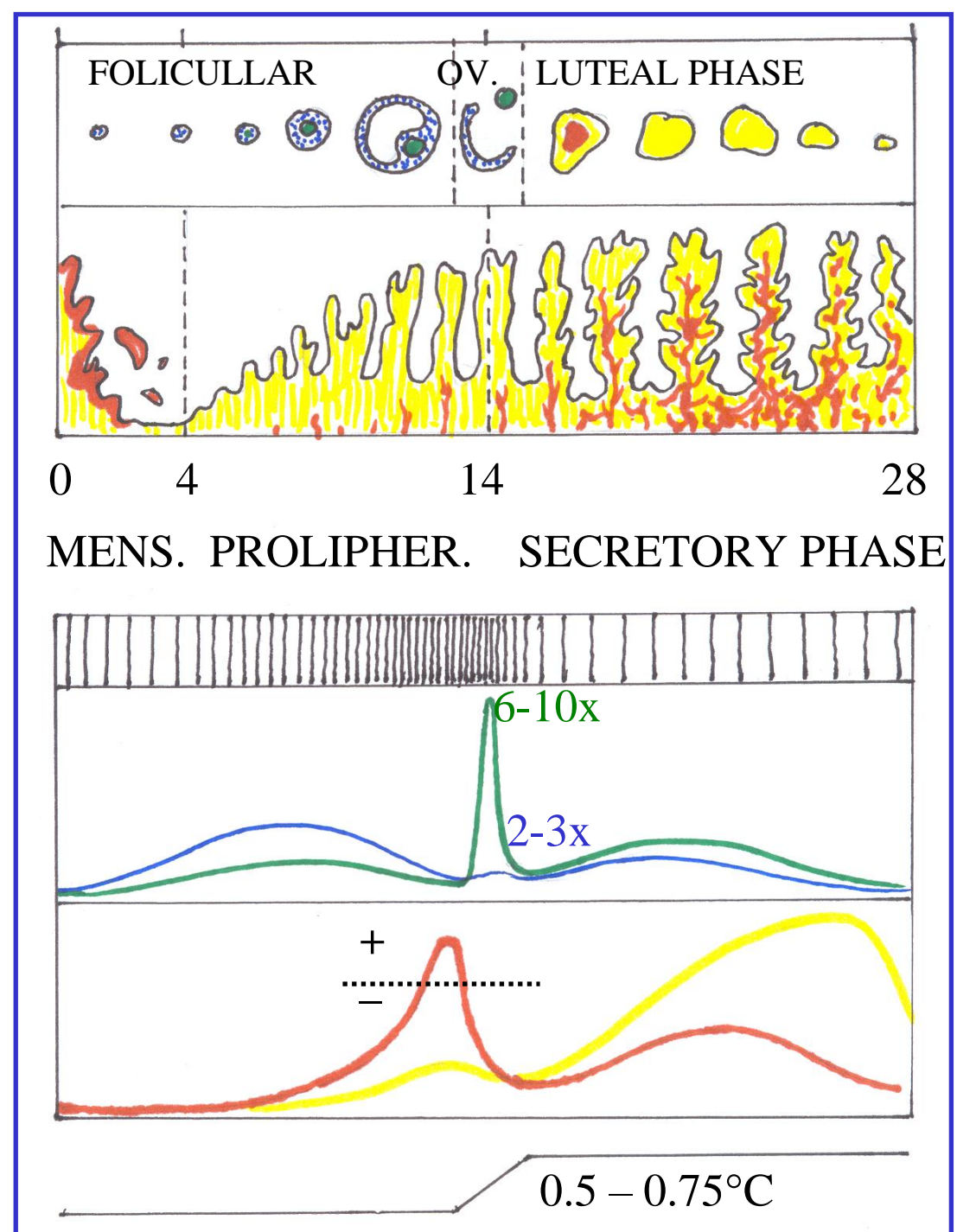

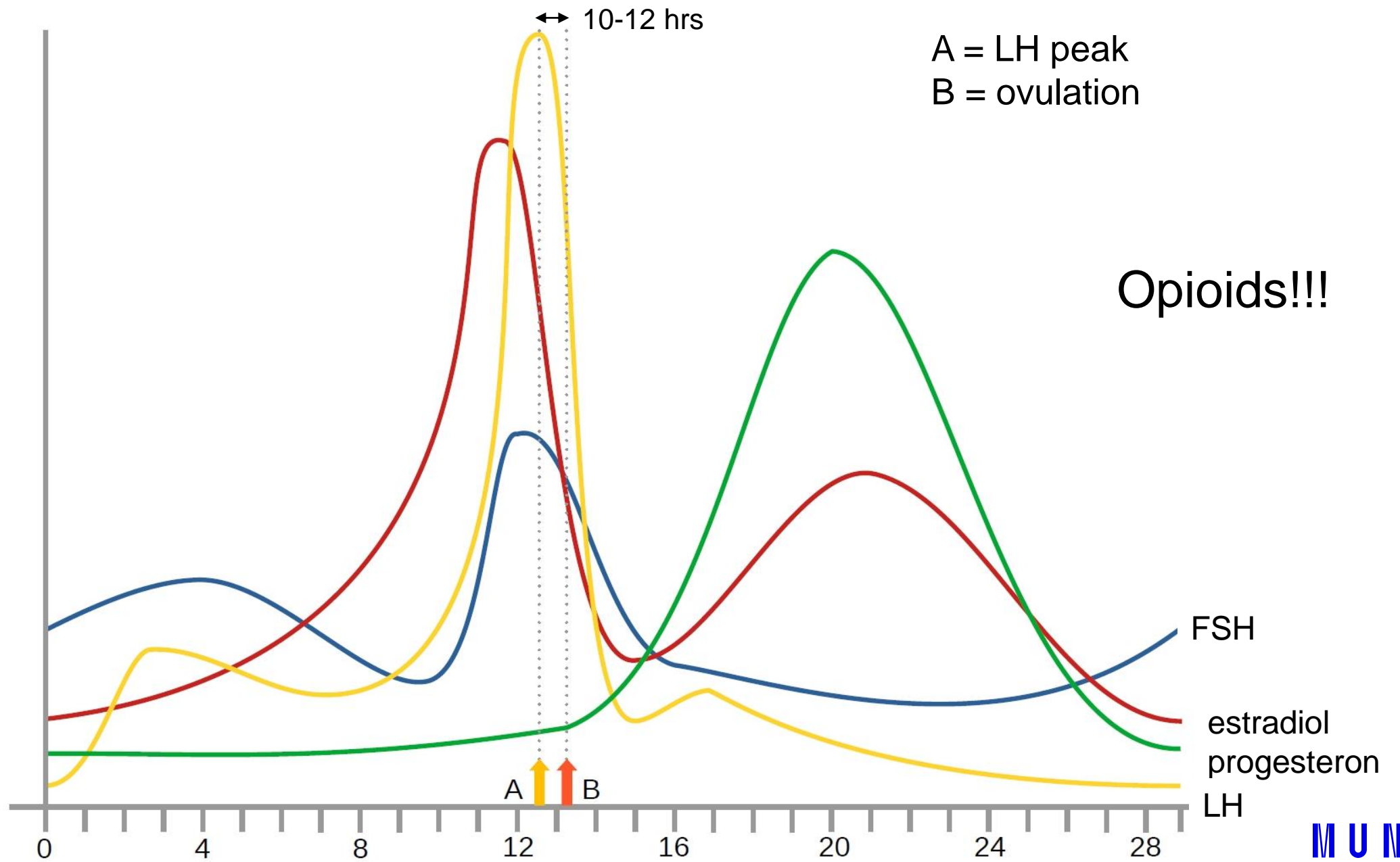

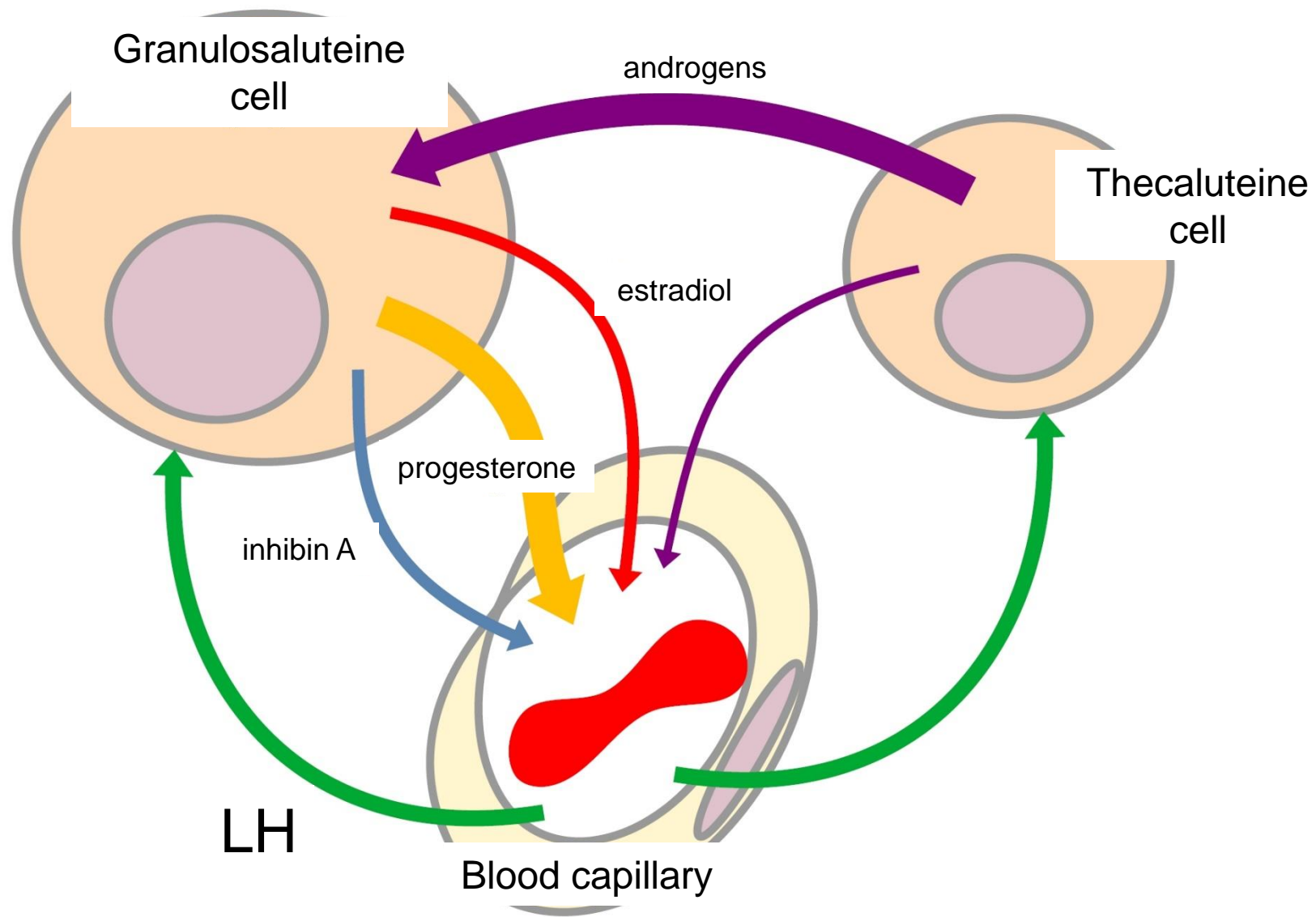

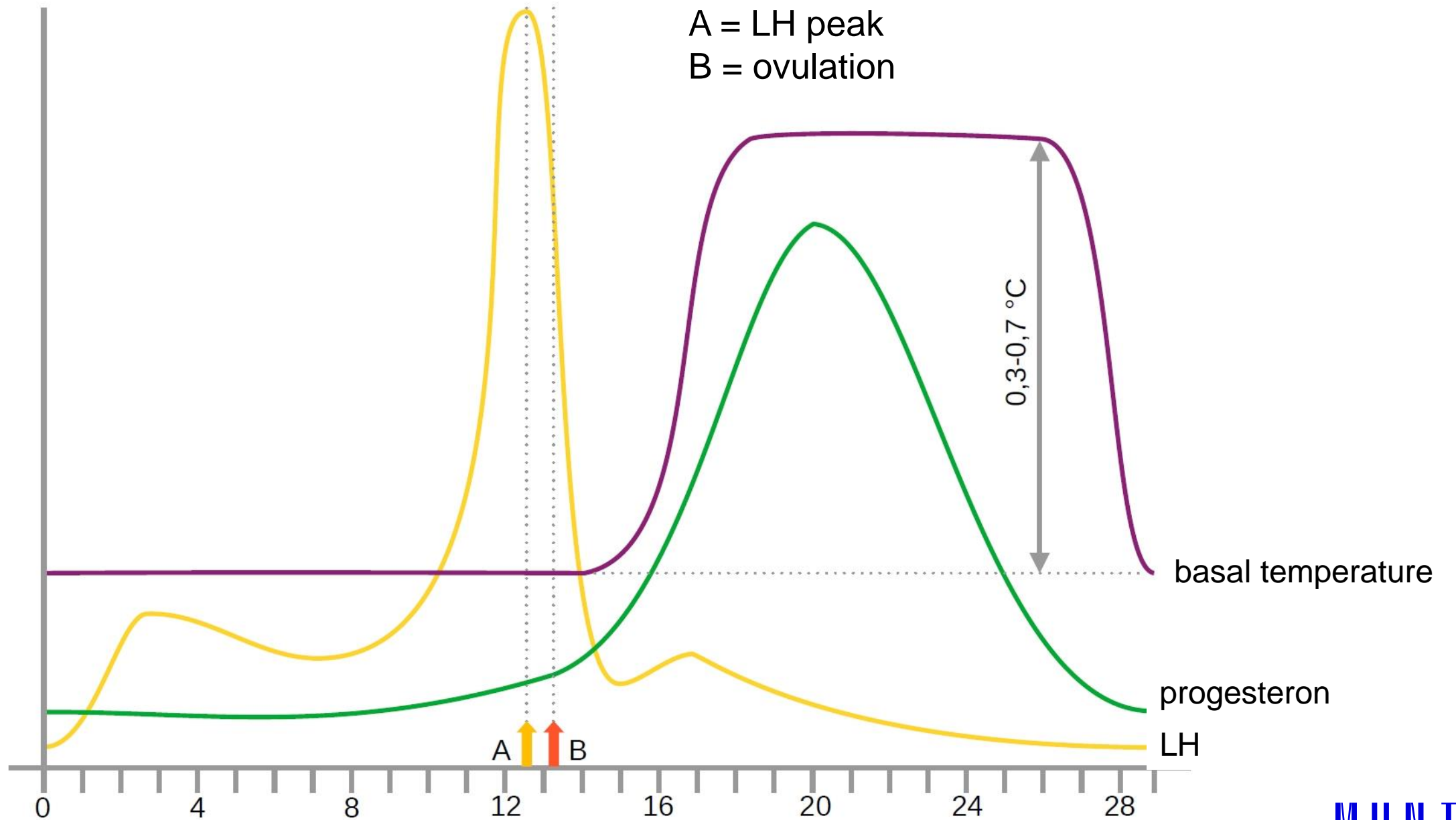

VESICULAR FOLLICLE

PRIMARY FOLLICLE - FSH

Growth acceleration of primary follicle – change into vesicular follicle:

1) estrogens released into follicle stimulate granul. cells



UP REGULATION of **FSH receptors** and **intrinsic positive feedback** (higher sensitivity for FSH!!!)

2) **UP REGULATION** of LH receptors (estrogens and FSH) – another acceleration of growth due to „higher sensitivity“ to LH (**positive feedback**)

3) Increased estrogens and LH secretion accelerates growth of theca cells, secretion is increased

→ **explosive growth of follicle**

DOMINANT FOLLICLE

1. High levels of **oestrogens** from the fastest-growing follicle
2. **Negative** feedback on FSH production from adenohypophysis
3. Gradual decrease in **FSH** secretion
4. „**Dominant** follicle“ continues in growing due to **intrinsic positive** feedback
5. Other follicles grow slowly and subsequently become **atretic**

MECHANISMS OF OVULATION

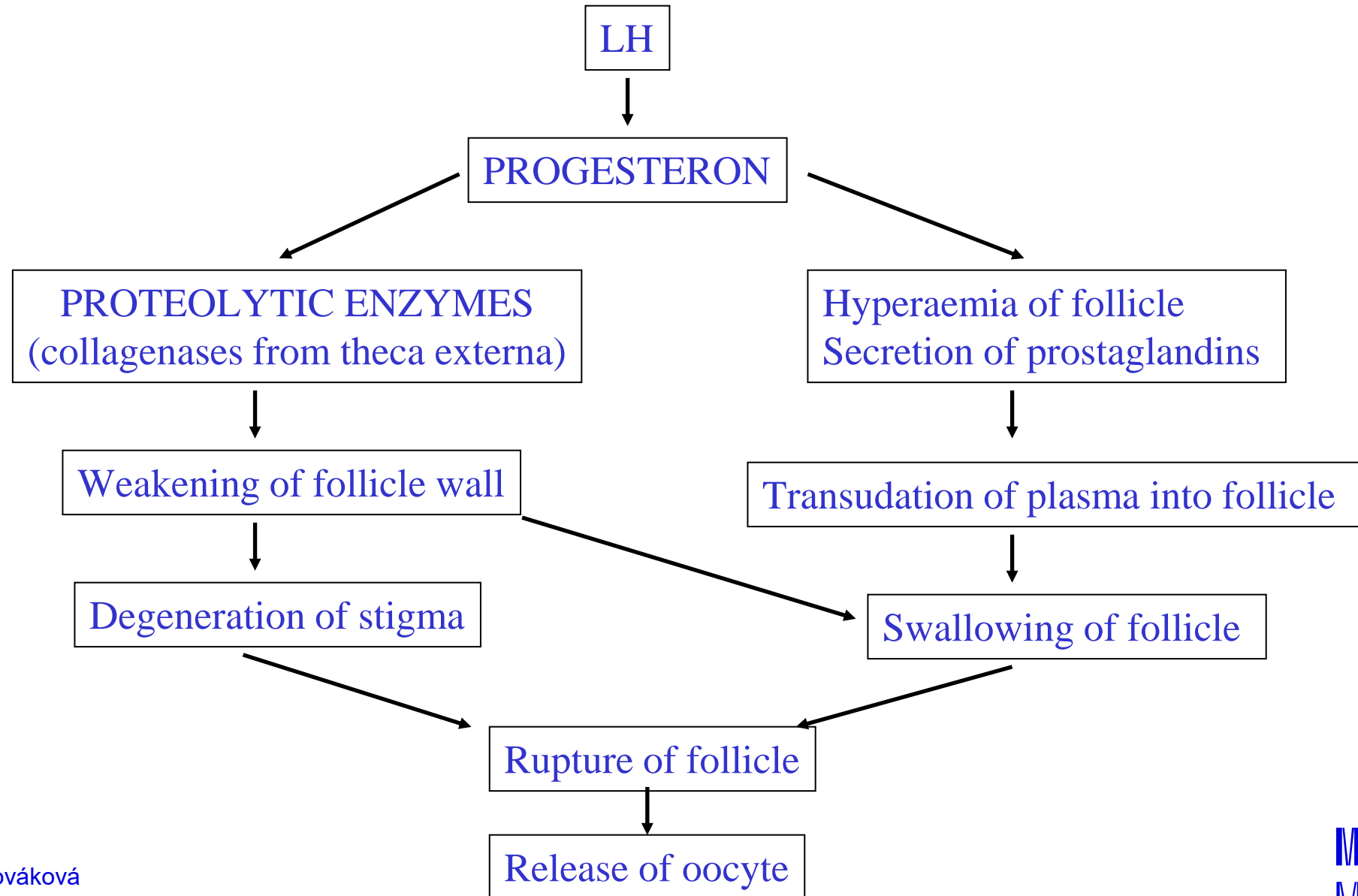

HUMOURAL REGULATION OF THE CYCLE

Follicular phase

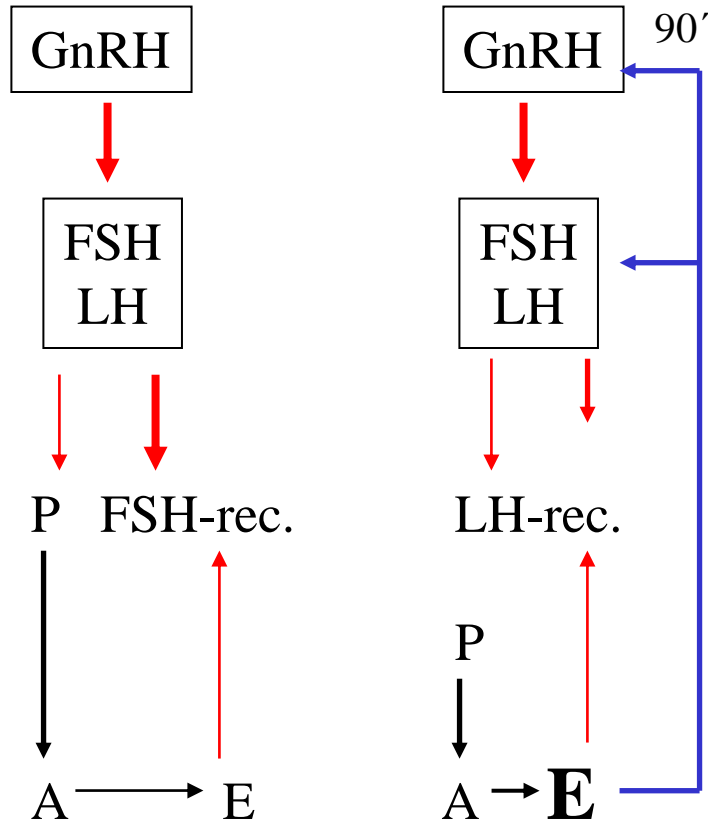

Artesia of follicle (but one!)

Ovulation

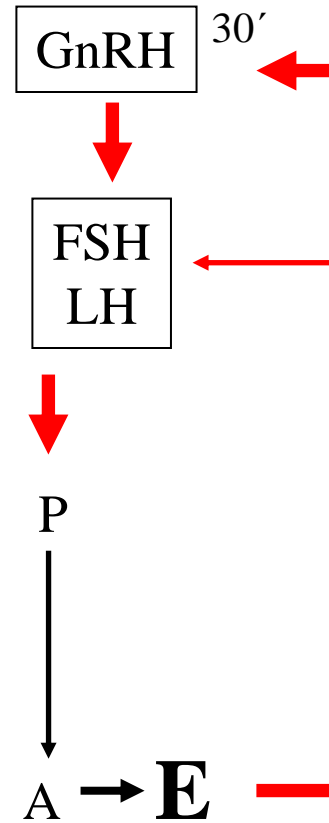

Feedback -/+/-

Luteal phase

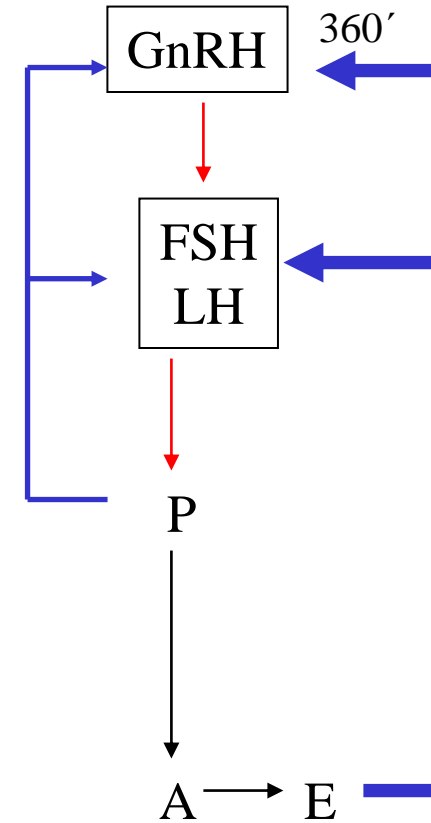

Involution of corpus luteum

EFFECTS OF OVARIAN HORMONES

E

Secondary sexual signs +

Adipose tissue: store (predilection), (critical amount)

Bone tissue: **absorption**

closure of fissures

development of pelvis

Total water retention: +

Sexual behaviour: +

P

-

-

-

-

-

+

-

Ovaries: **maturation of follicles**

Hysterosalpinx: **motility**

Uterus: **proteosynthesis**

vascularisation and proliferation of endom.

EXCITATION

motility

proteosynthesis

secretion of endom. glands

glycogen

RELAXATION

Cervix: **colliquation of „plug“**

Vagina: **cornification of epithelium**

Mamma: **growth of terminals**

creation of „plug“

proliferation of epithelium

growth of acines

PREGNANCY, PARTURITION, LACTATION

FERTILISATION PROCESSES

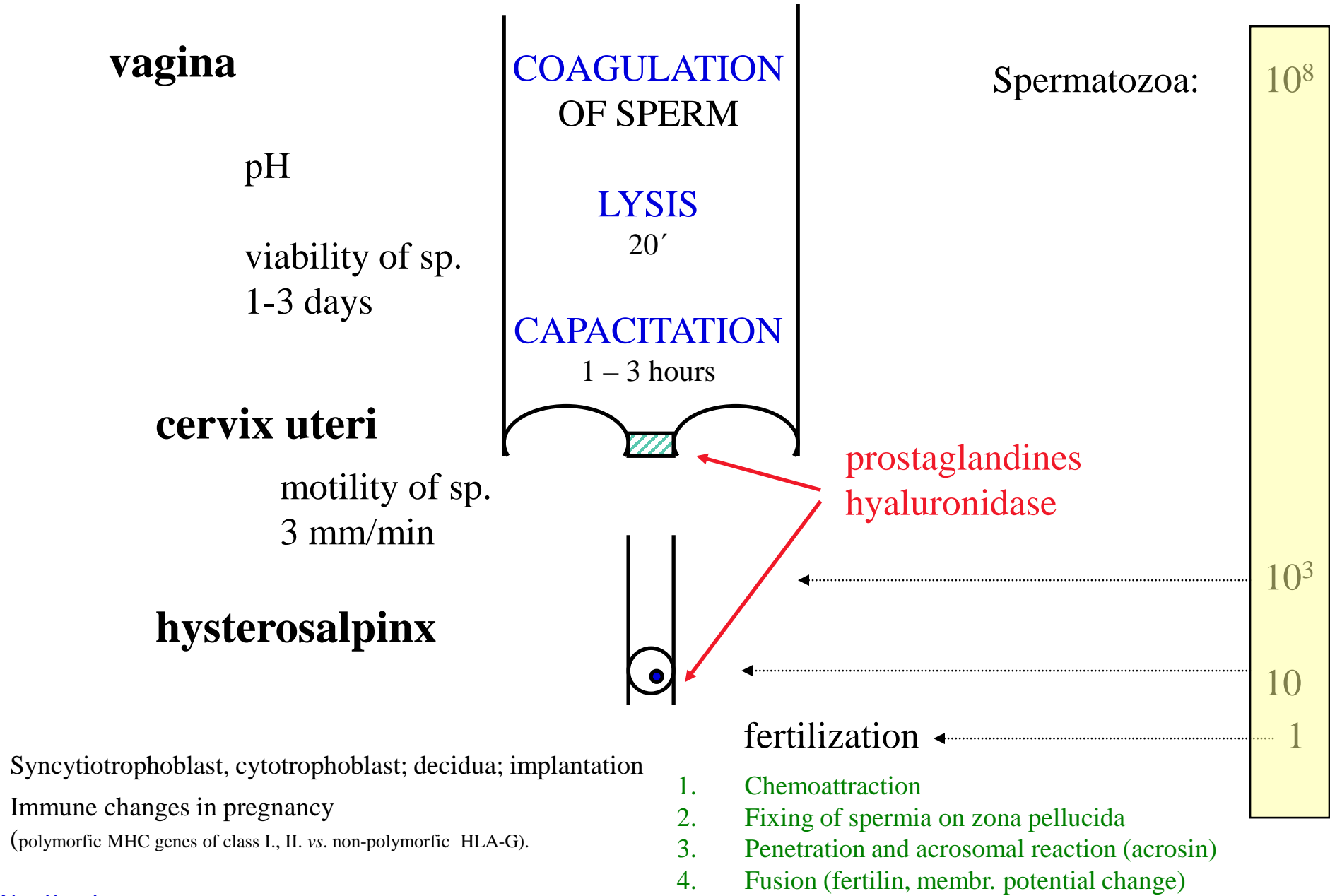

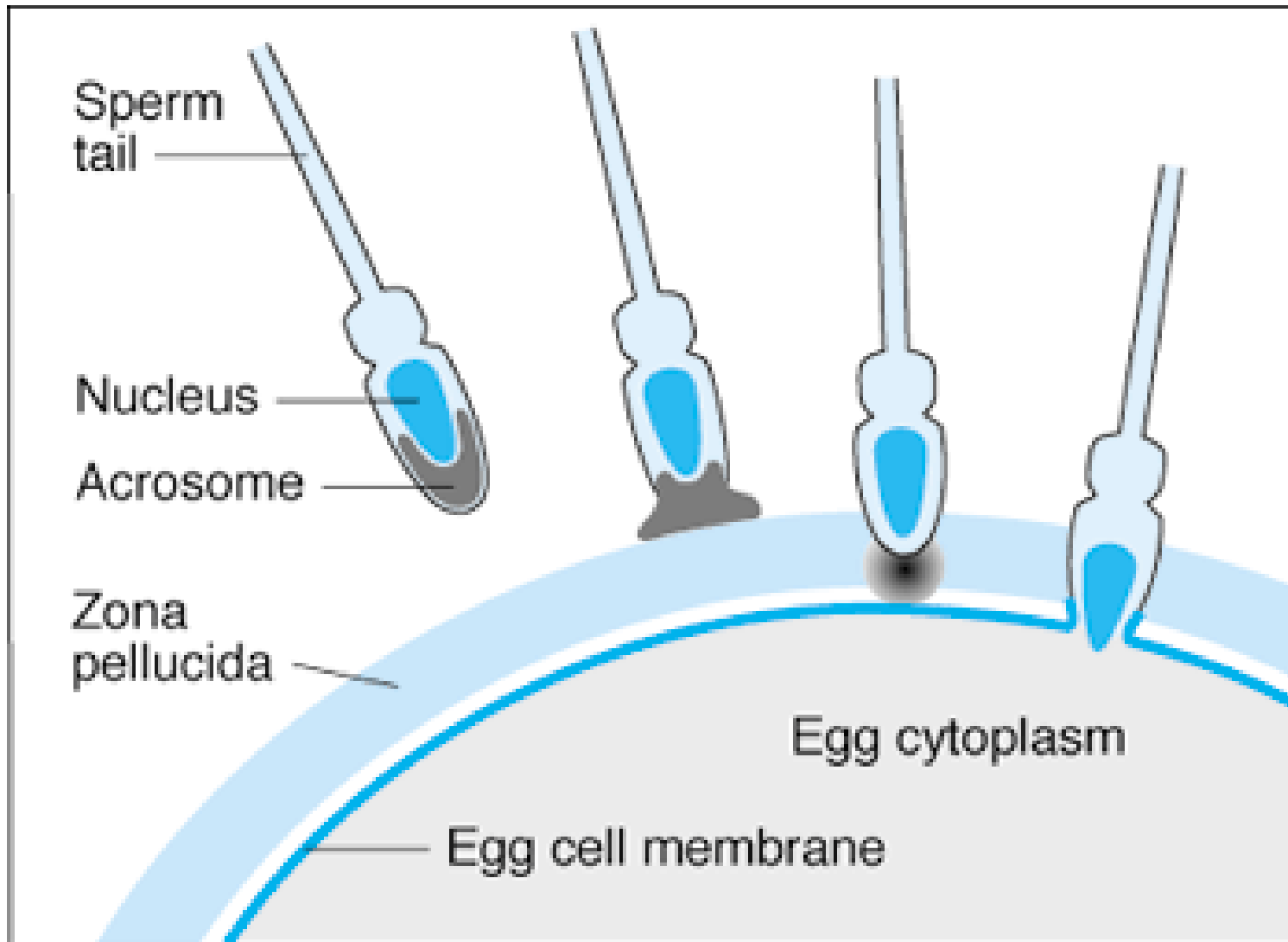

HORMONAL PROFILE DURING PREGNANCY

(8th week!!!)

Corpus luteum graviditatis

Placenta

E, P, Relaxin

hCG, hCS, E, P

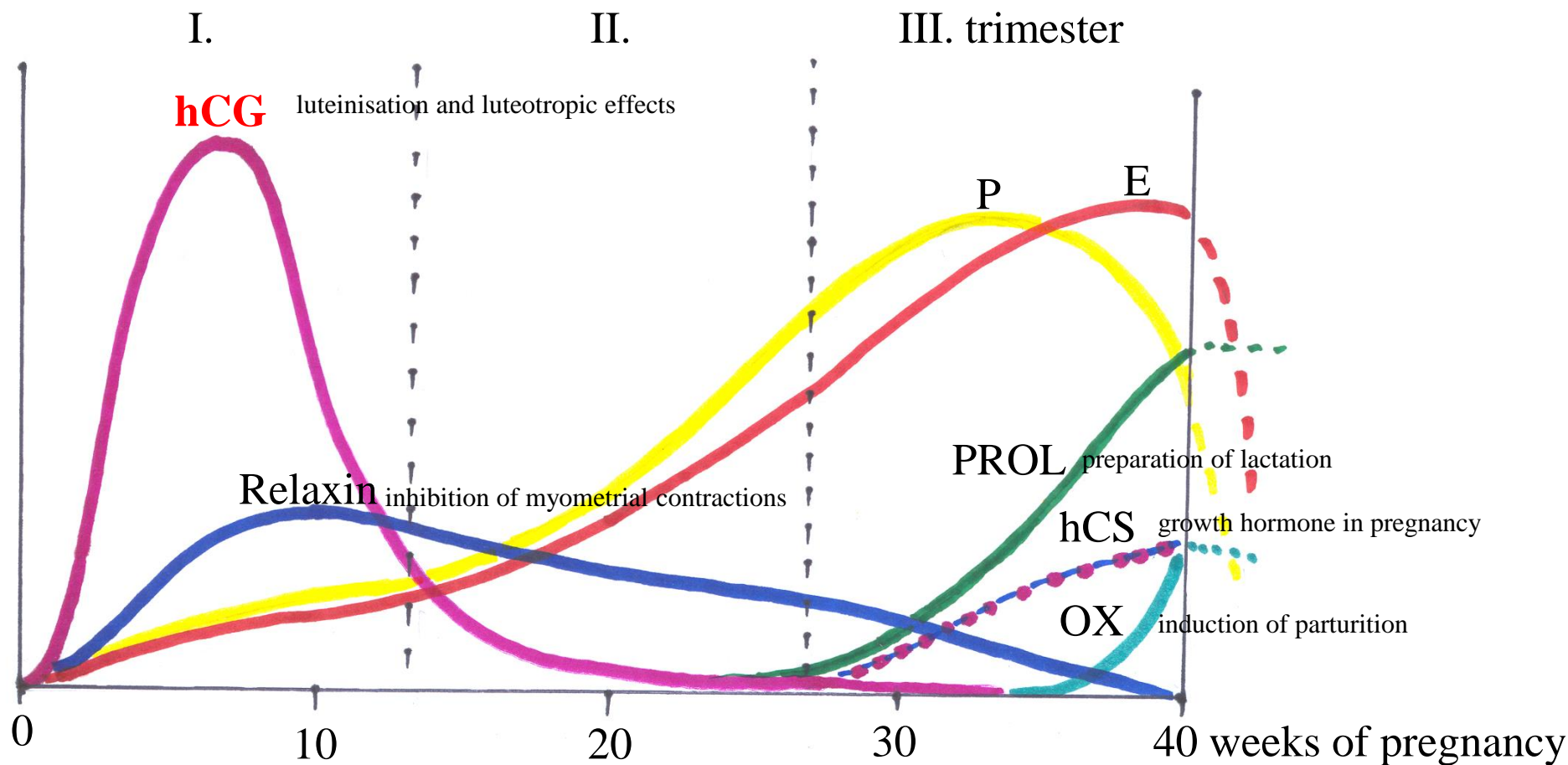

- STH
- TSH
- ACTH
- INS
- KORT
- ALD
- T₄
- PTH

RELATIONSHIP BETWEEN P:E IN PREGNANCY

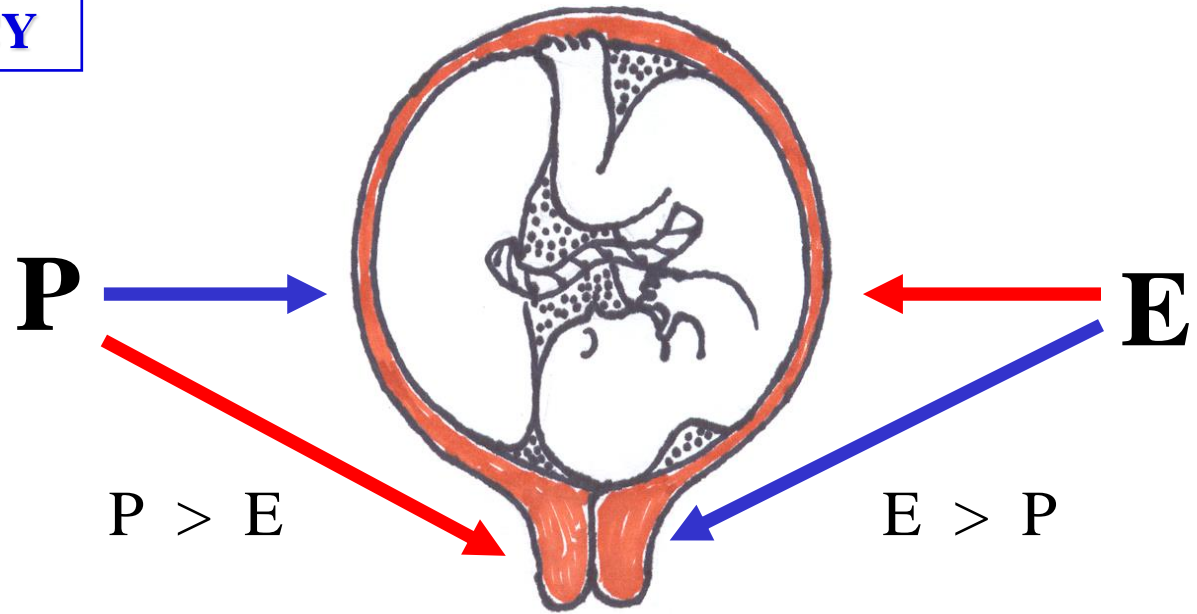

Foetal-placental unit

MOTHER	PLACENTA	FOETUS
cholesterol	pregnenolone	DHEAS 16OH-DHEAS
	progesterone	cortisol aldosterone
DHEAS	estradiol Estriol	

Excretion of estriol in urine
– index of foetal status

Peptide Hormones and Neuropeptides

hCG

Thyrotropin (thyroid-stimulating hormone [TSH])

Placental-variant growth hormone

hCS1 and hCS2, also known as hPL (hPL1 and hPL2)

Placental proteins PP12 and PP14

TRH

Corticotropin-releasing hormone (CRH)

Growth hormone–releasing hormone (GHRH)

GnRH

Substance P

Neurotensin

Somatostatin

Neuropeptide Y

ACTH-related peptide

The inhibins

Steroid Hormones

Progesterone

Estrone

Oestradiol

Estriol

PHYSIOLOGICAL CHANGES DURING PREGNANCY

Changes of reproduction organs

- **Uterus**
 - Growth (from 60 g to 1000 g), change of position
 - Hyperaemia
 - Functional differentiation of myometrium
- **Cervix**
 - Changes of colour, consistency; shortening
 - Hypertrophy a hyperplasia of glandules – mucus plug
- **Vagina**
 - Changes of colour, increase of secretion
- **External genitals**
 - Vascularization, vasocongestion (changes of colour)

Somatic changes

- **Breasts**
 - Growth – alveolar as well as ductal part
 - Enlargement and hyperpigmentation of mammillae and areolas
- **Skin**
 - Increase in subcutaneous fat
 - Changes in connective tissue
 - Hyperpigmentation

Endocrine and metabolic changes

Immunological changes

Psychic changes

ENDOCRINE and METABOLIC CHANGES DURING PREGNANCY

Endocrine glands

- **Thyroid gland**
 - Slight hypertrophy (E), increase in thyroxine production, in III. trimester BEE +25%
- **Parathyroid glands**
 - Increase in production of parathormone
- **Adrenal glands**
 - Increase in production of aldosterone
- **Pancreas**
 - Hyperplasia of Langerhans islets

Anterior pituitary gland

Metabolism

- **Weight gain:** 12-15 kg
- **Glycaemia**
 - Glc – main energetic source for foetus
 - Prohyperglycemic state
 - Decrease of renal glucose reabsorption, increase in glomerular filtration - glycosuria
 - Gestational diabetes
- Increased demand for **Ca** (1300 mg), **P** (1200 g) and **Fe** (18 mg/day)
- **Water retention:** + 6.5 l

OXYTOCIN

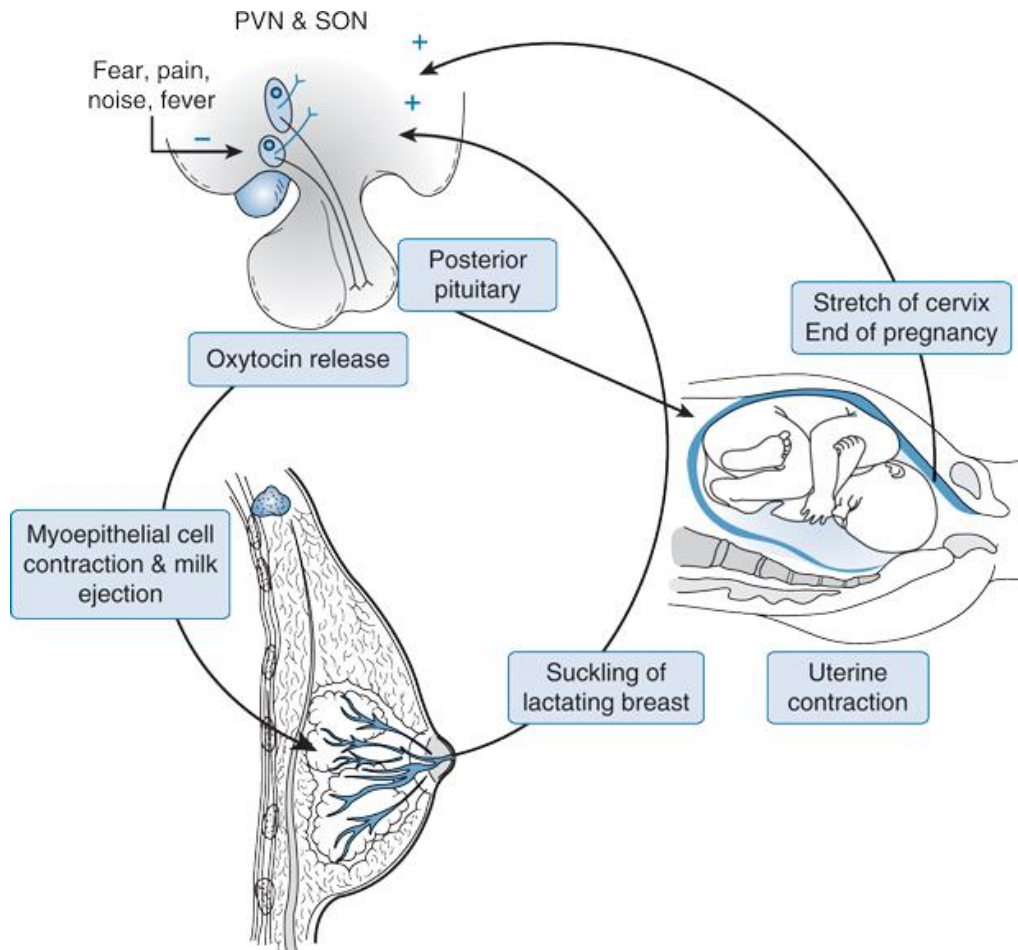

- **Mechanoreceptors/tactile receptors**
- **Magnocellular neurons** (PVN, SON)
 - inhibition by endogenous opioids, NO, GABA
 - Autocrine (+ ZV)
 - Prolactin, relaxin (-), Estrogens (+)
- OXT receptors ($G_{q/11}$) – effect of up/down regulation
- Acts together with prolactin and sex hormones

Functions

- Lactation (under 1 min) – **MILK EJECTION**
- Parturition
 - rhythmical contractions of smooth muscles (gap-junction, stimulation of prostaglandin synthesis – extracellular matrix)
 - postpartum bleeding
 - uterus involution
- Ejaculation (males)
- Behavior

Other functions and places of synthesis

- CNS
 - Stimulation of ACTH secretion through CRH
 - Stimulation of ADH/induced vasoconstriction
 - Stimulation of prolactin secretion
 - Memory traces recollection inhibition
 - Maternal behavior

OXYTOCIN RECEPTORS

- OXT receptors ($G_{q/11}$)
 - **Myoepithelial cells**
 - **Myometrium**
 - Endometrium
 - CNS
- PLC, IP_3 , Ca^{2+}
- Target molecule – MLCK (myosin light chain kinase)

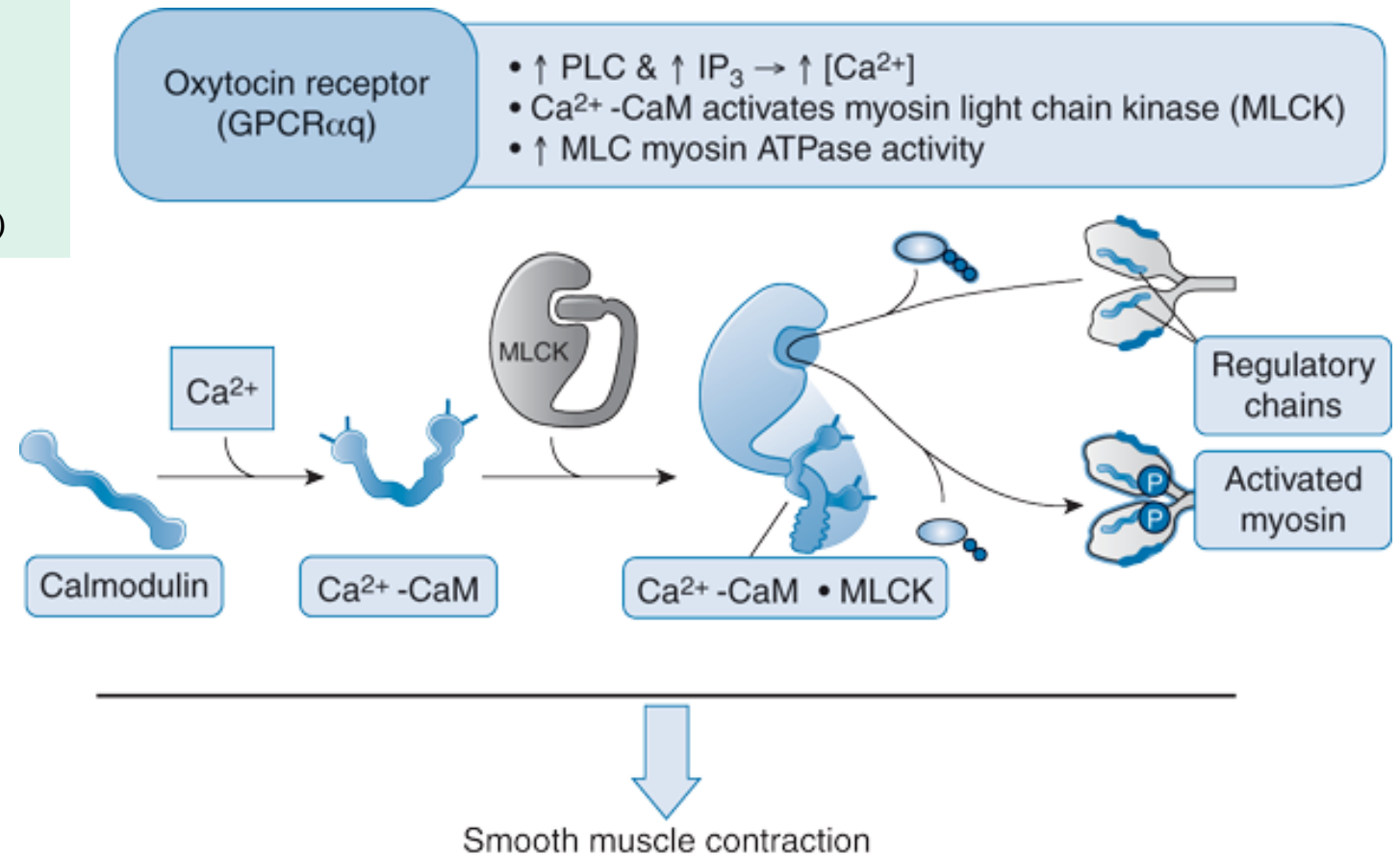

OXYTOCIN

- 9 AA, differs from ADH in the 3. and the 8. AA
- Precursor molecule is synthesized in the same location as ADH (*nucleus paraventricularis*)
- Stimulus for synthesis: dilatation of birth path caused by pressure of foetus and stimulation of mechanoreceptors at breast nipple
- **Reflex release**: during breast-feeding, orgasm
- Main effects – on reproduction system:
 - **Uterokinetic effects** (induction of parturition), milk ejection, involution of uterus
 - In men: probably increases contractions of smooth muscle in *ductus deferens*
- Regulation of water and mineral metabolism – natriuretic effect, potentiation of ADH effect
- **Effect on memory**: opposite to ADH effect – inhibits forming of memory and its recollection
- Note: Melanocytes inhibiting factor – from oxytocin, modulates certain types of receptors, modulation of melatonin effects (melatonin – epiphysis, together with glomerulotrophin and DMT, circadian/circannual biorhythms, controlled by hypothalamus, information from retina)

INDUCTION OF PARTURITION

P > E → E > P

maternal
placental
foetal

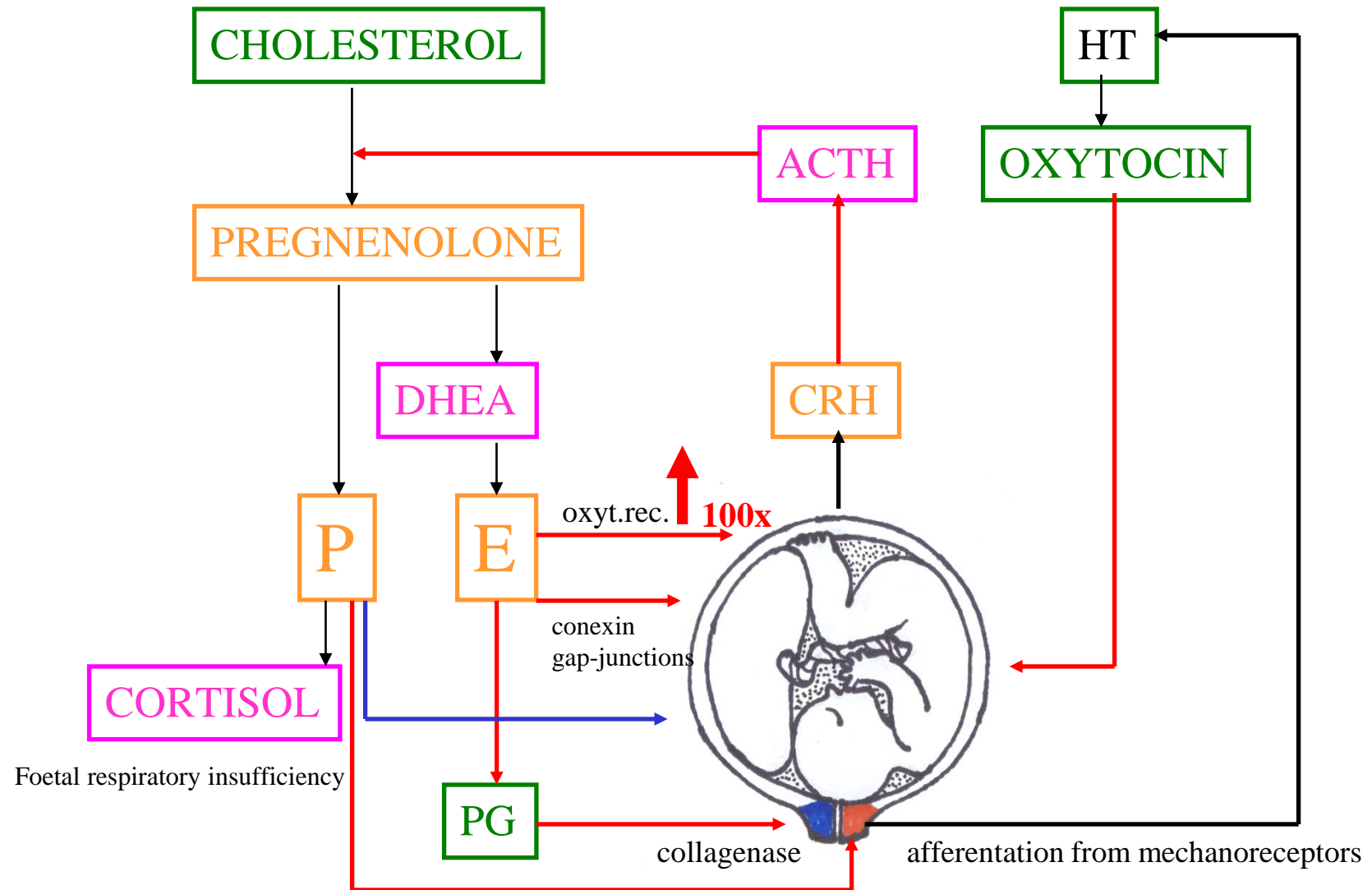

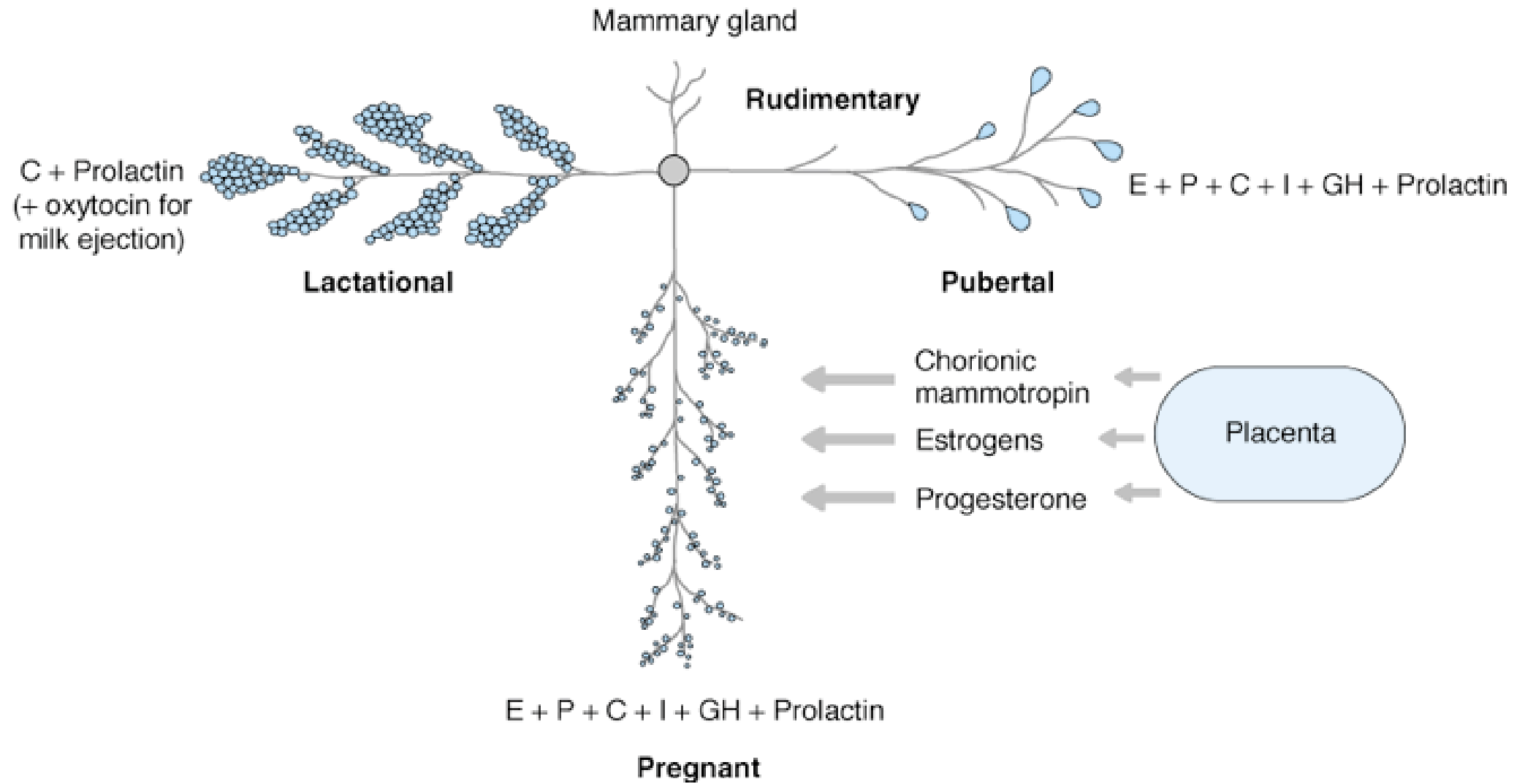

LACTATION

1 – 3 days after birth; initiated by decrease of oestrogens' concentrations *post partum*

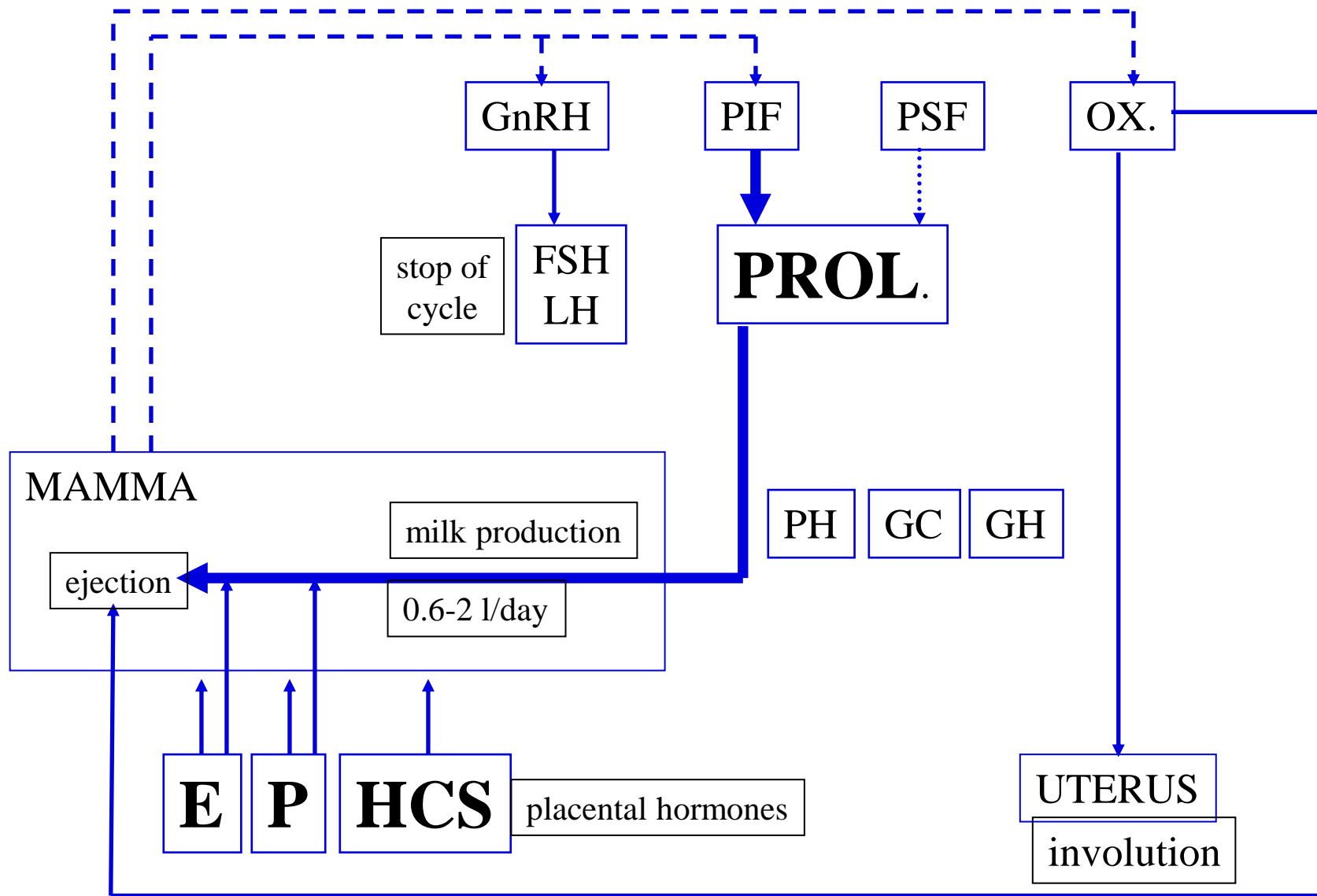

Composition of milk: water (88%), fat (3,5%), lactose (7%), proteins (1%)
trace minerals (Ca), vitamins, antibodies

(hyperprolactinaemia)

LEPTIN AND REPRODUCTIVE FUNCTIONS

LEPTIN IN PREGNANCY

Synthesised by placenta from the 18th week of pregnancy.

Dramatic increase in maternal blood after the 34th week.

Synthesis in placenta, foetal adipose tissue and growing maternal adipose tissue.

BUT leptin plasmatic levels in non-pregnant women do not correspond to adipose tissue amount (BMI).

Decrease after delivery down to the levels typical for non-pregnant women.

Leptin may play a role in proliferation and function of trophoblast, and thus affects foetal growth.

LEPTIN IN NEWBORNS

Plasmatic levels of leptin correspond to newborn body mass and BMI.

Blood of newborn contains maternal and foetal leptin.

Girls have higher levels of leptin than boys.

It is supposed, that sex differentiation of plasmatic levels of leptin is already genetically given, since it is not affected postnatally by sex hormones.