

M U N I

M E D

**M U N I**  
**M E D**

**9**

**Vision I**

# Light

- ✓ Electromagnetic radiation with wavelengths in range of 400 – 700 nm

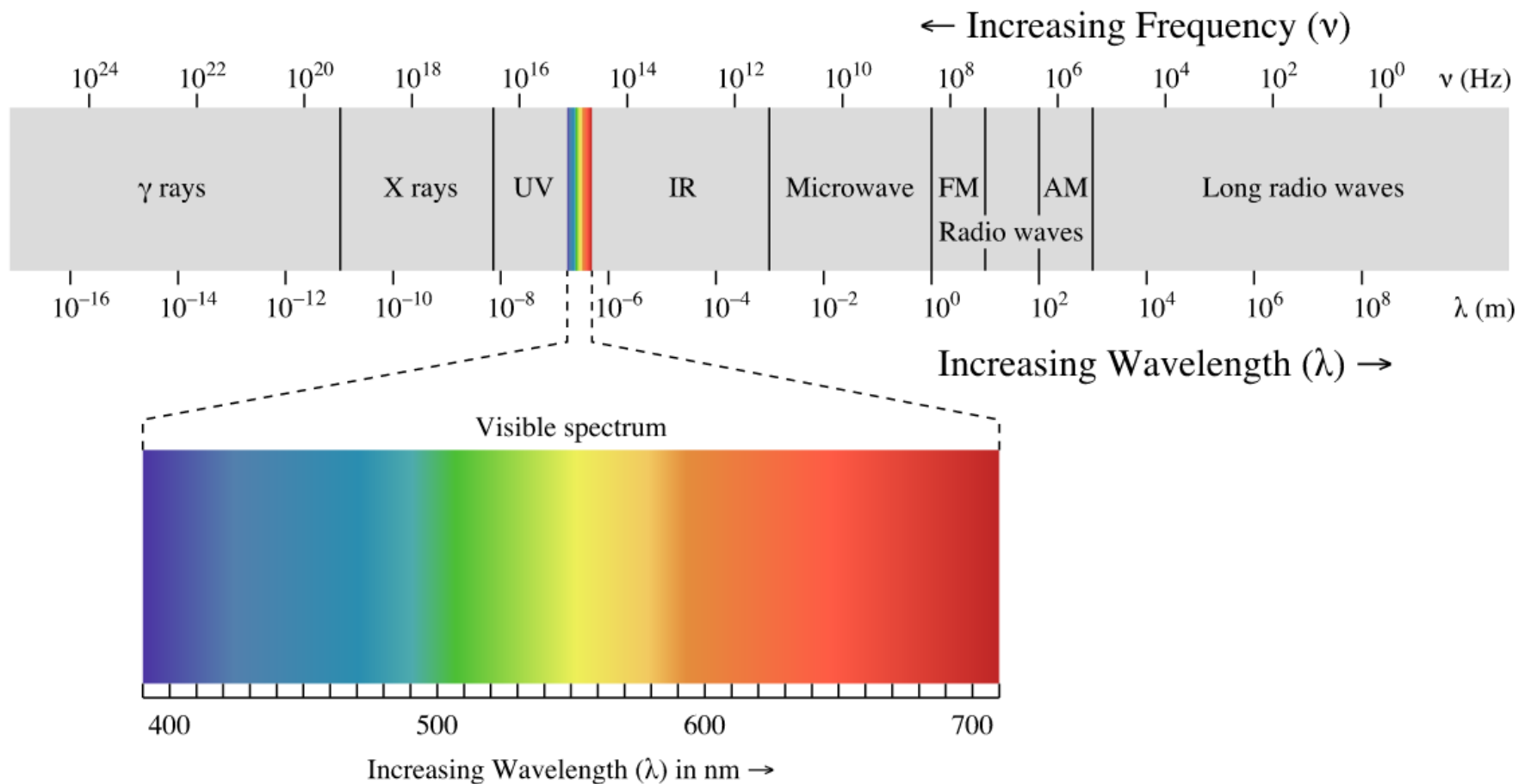

# Color mixing

**RGB**  
Additive  
Color



*mixing light*

**RED GREEN BLUE**

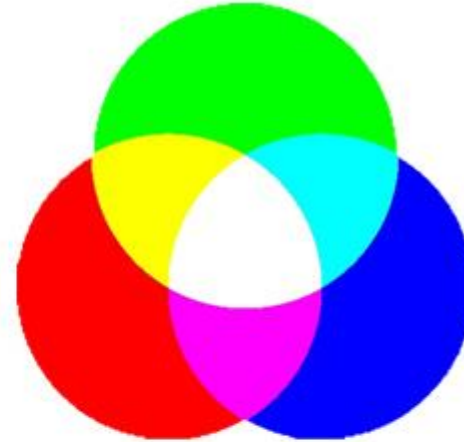

---

**CMYK**  
Subtractive  
Color



*mixing ink*

**CYAN MAGENTA YELLOW**

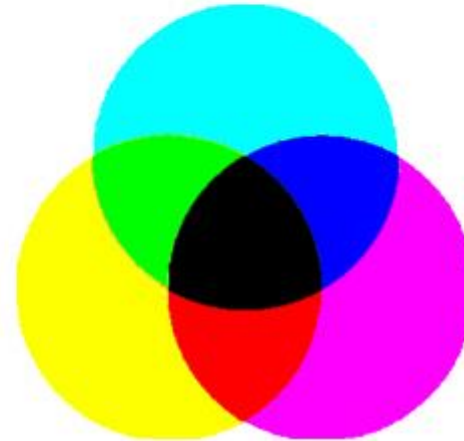

# Photoreceptive organ

✓ Light detection

✓ Image formation

# Light detection

- Circadian activity
  - Both prokaryotes and eukaryotes
  - Day/night cycle is the most influential and the most stable biorhythm

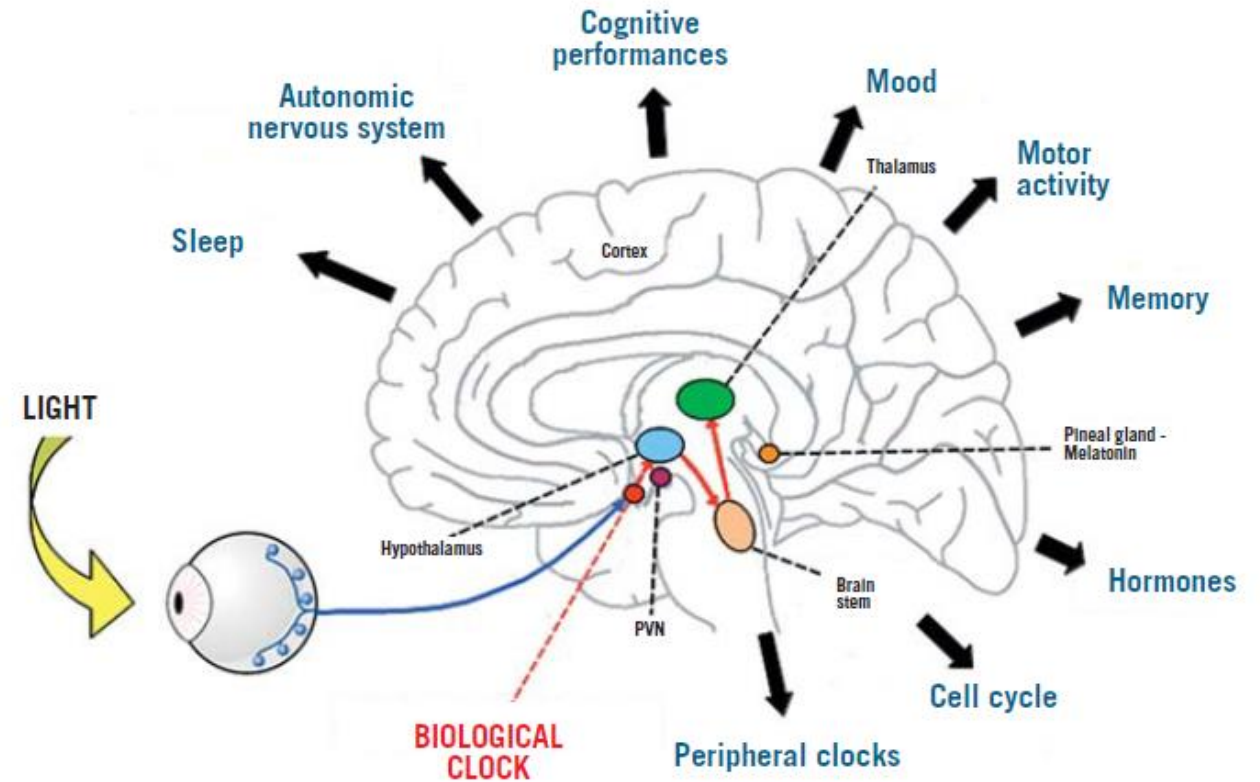

<https://www.pointsdevue.com/article/good-blue-and-chronobiology-light-and-non-visual-functions>

# Light detection

- Circadian activity
  - Both prokaryotes and eukaryotes
  - Day/night cycle is the most influential and the most stable biorhythm

Light/dark  
↓  
„warm/cold“

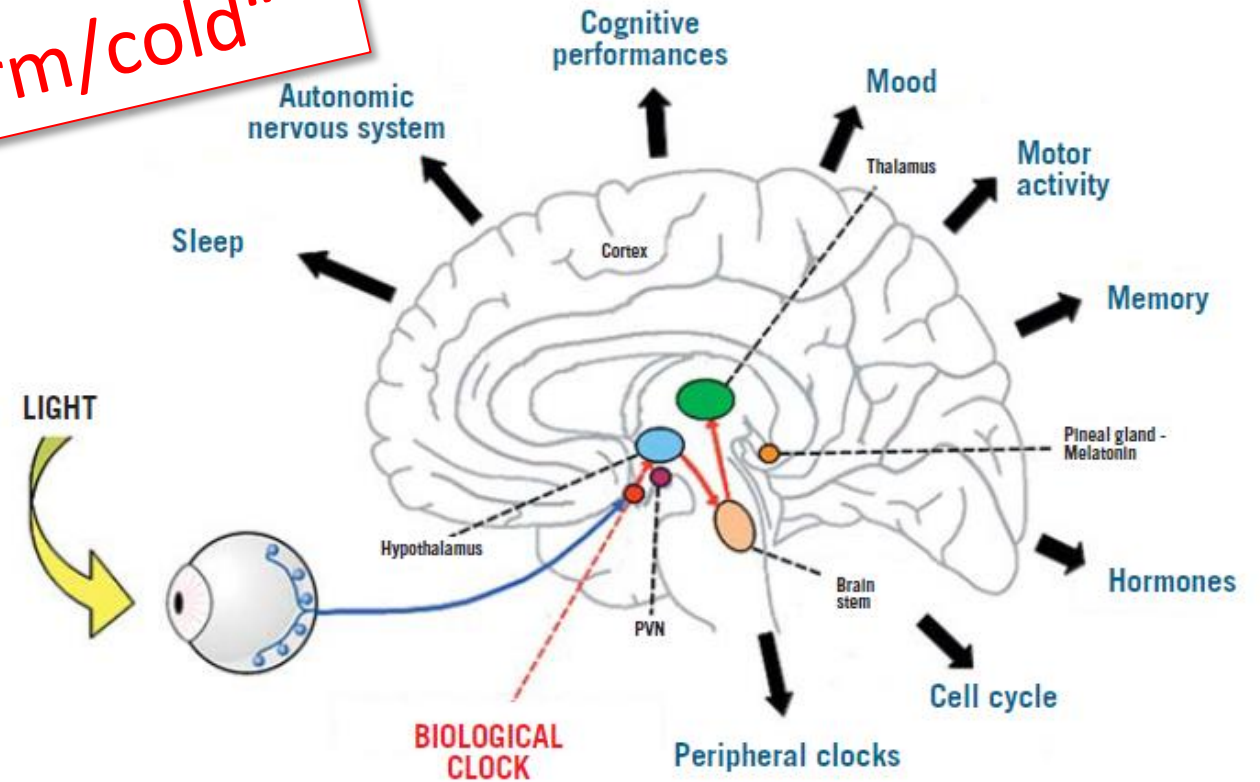

<https://www.pointsdevue.com/article/good-blue-and-chronobiology-light-and-non-visual-functions>

# Light detection

- Circadian activity
  - Both prokaryotes and eukaryotes
  - Day/night cycle is the most influential and the most stable biorhythm
  - Oscillation with a period of approx. 24 hours even without signals from environment
  - Environmental signals synchronize circadian activity
- Seasonal activity

Light/dark  
↓  
„warm/cold“

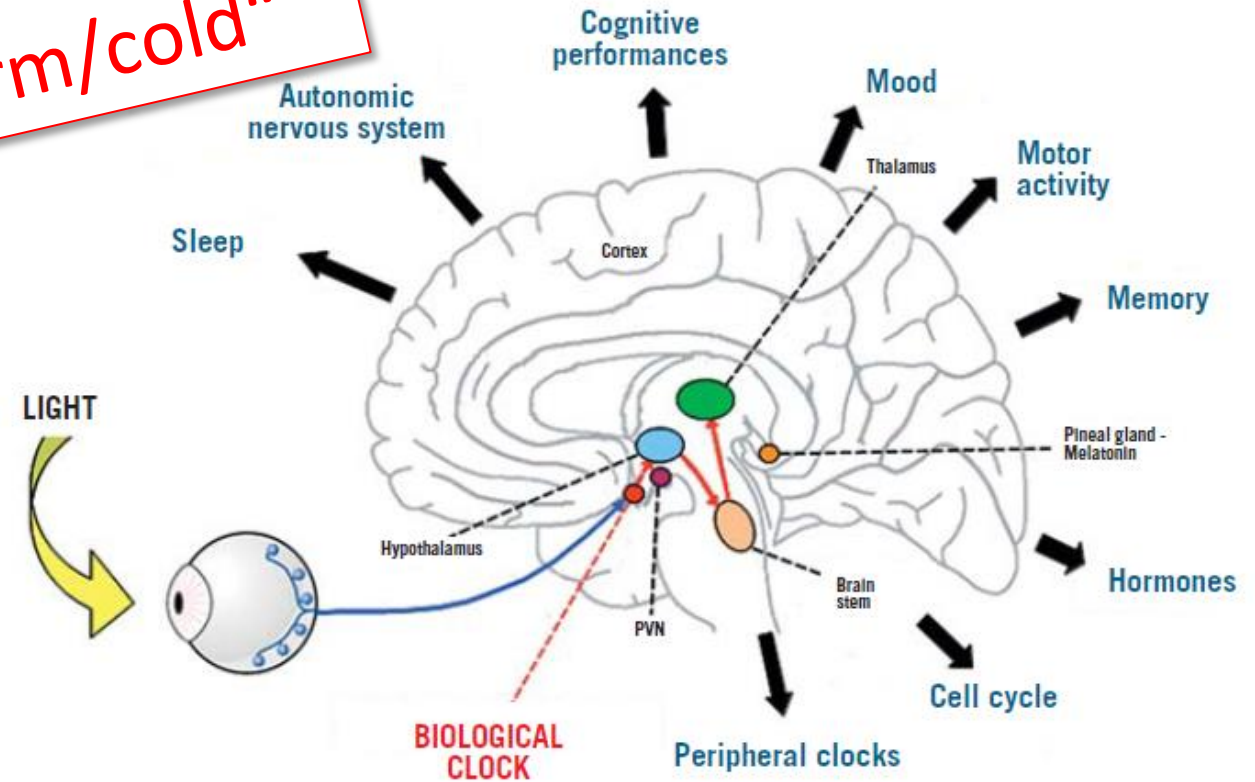

<https://www.pointsdevue.com/article/good-blue-and-chronobiology-light-and-non-visual-functions>



# Circadian activity

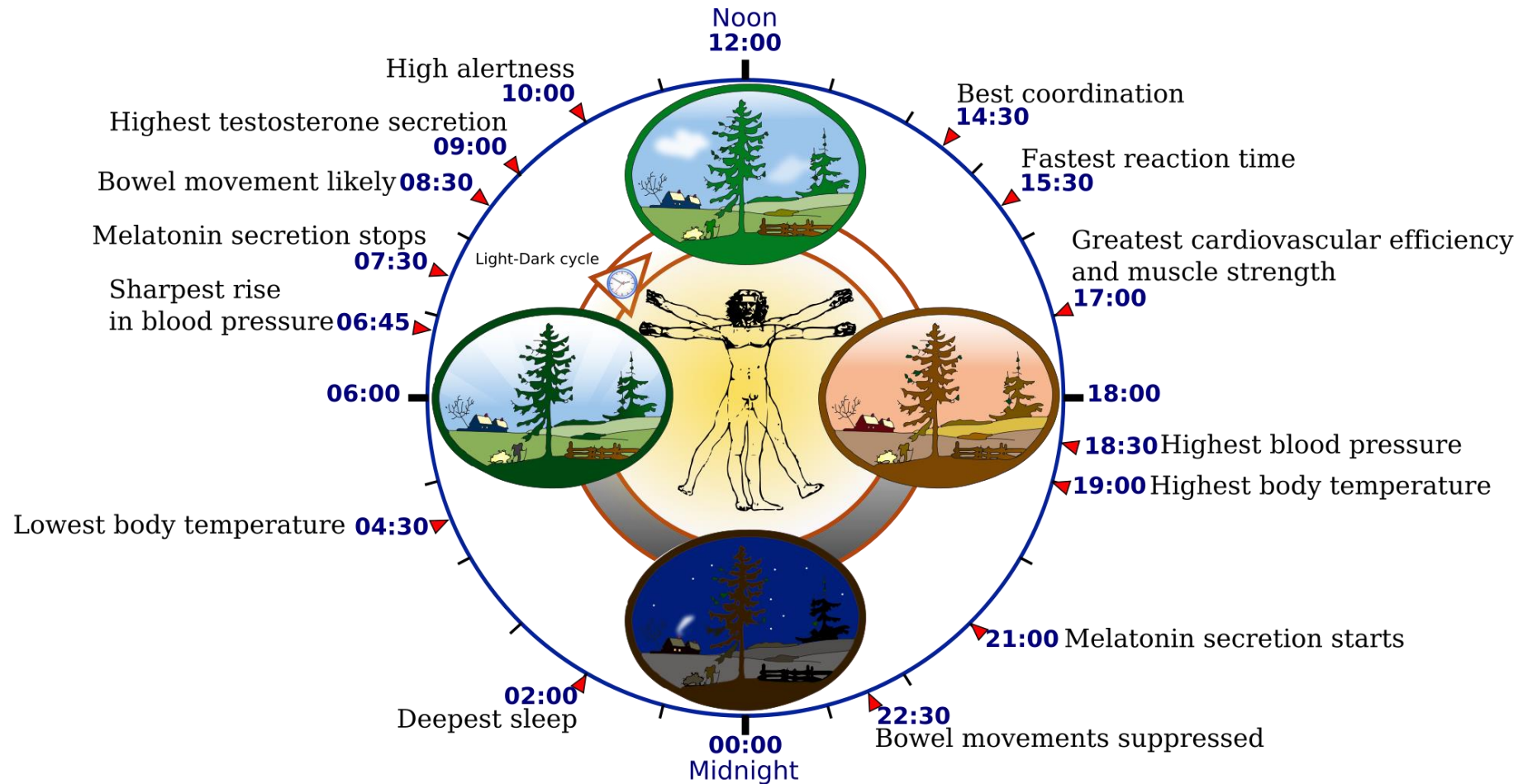

[https://upload.wikimedia.org/wikipedia/commons/thumb/3/30/Biological\\_clock\\_human.svg/2000px-Biological\\_clock\\_human.svg.png](https://upload.wikimedia.org/wikipedia/commons/thumb/3/30/Biological_clock_human.svg/2000px-Biological_clock_human.svg.png)

# Biological clock

- Cellular level
  - Group of proteins rhythmically expressed creating interconnected feedback loops (about 24hours)
    - Peripheral Clock protein expression

# Biological clock

- Cellular level
  - Group of proteins rhythmically expressed creating interconnected feedback loops (about 24hours)
    - Peripheral Clock protein expression
- Tissue level
  - Peripheral oscillators
  - Adrenal gland, lung, liver, pancreas, skin
  - Influenced by neurohumoral factors and also by light

# Biological clock

- Cellular level
  - Group of proteins rhythmically expressed creating interconnected feedback loops (about 24hours)
    - Peripheral Clock protein expression
- Tissue level
  - Peripheral oscillators
  - Adrenal gland, lung, liver, pancreas, skin
  - Influenced by neurohumoral factors and also by light
- Central pacemaker
  - Hypothalamus (nucleus suprachiasmaticus)
    - Central clock protein expression
    - Information about illumination from retina (specialized ganglion cells) – synchronization of central pacemaker
  - Pineal gland - melatonin
  - Autonomic nervous system – adrenal gland - cortisol

# Biological clock

- Cellular level
  - Group of proteins rhythmically expressed creating interconnected feedback loops (about 24hours)
    - Peripheral Clock protein expression
- Tissue level
  - Peripheral oscillators
  - Adrenal gland, lung, liver, pancreas, skin
  - Influenced by neurohumoral factors and also by light
- Central pacemaker
  - Hypothalamus (nucleus suprachiasmatic)
    - Central clock protein expression
    - Information about illumination from retina (specialized ganglion cells) – synchronization of central pacemaker
  - Pineal gland - melatonin
  - Autonomic nervous system – adrenal gland - cortisol

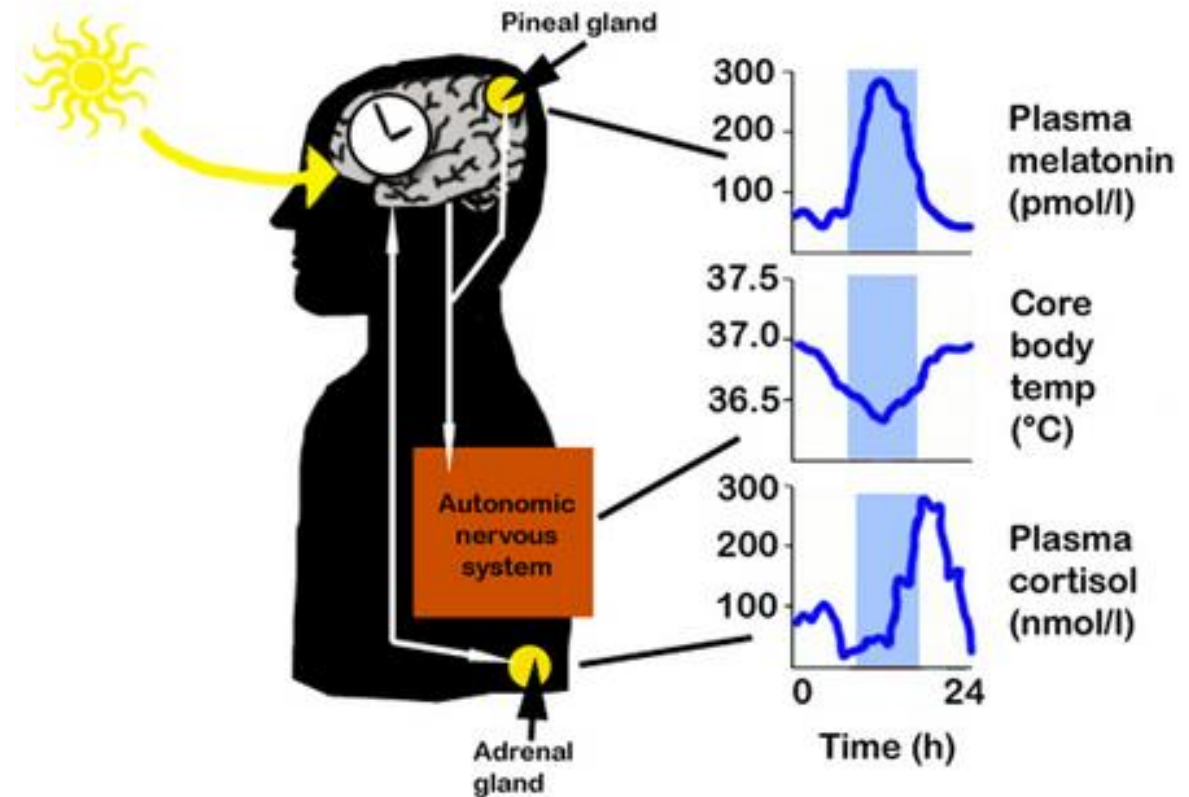

A.J. Hesse, G.E. Duffield

adapted from Hastings, M. BMJ 1998;317:1704-1707

<http://slideplayer.com/slide/7013288/>

# Central pacemaker synchronization

Wahl S, Engelhardt M, Schaupp P, Lappe C, Ivanov IV. The inner clock-Blue light sets the human rhythm. *J Biophotonics*. 2019; e201900102.

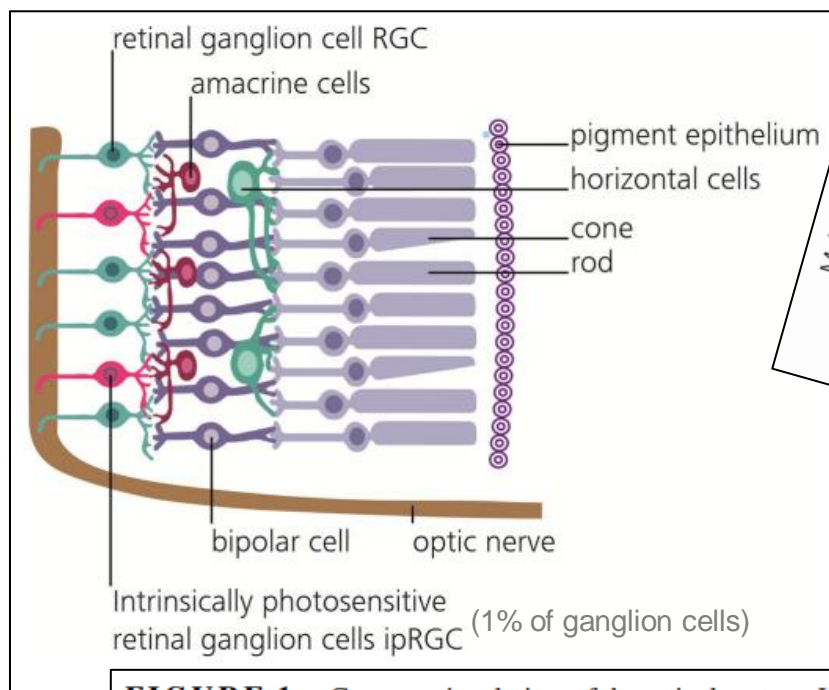

**FIGURE 1** Cross sectional view of the retinal system. Light traverses the system from the left, cones and rods transmit visual information via the bipolar cells, amacrine cells, and ganglion cells to the optic nerve. The sparse subset of intrinsic photosensitive retinal ganglion cells can induce signals themselves, due to their possession of a separate photopigment, melanopsin

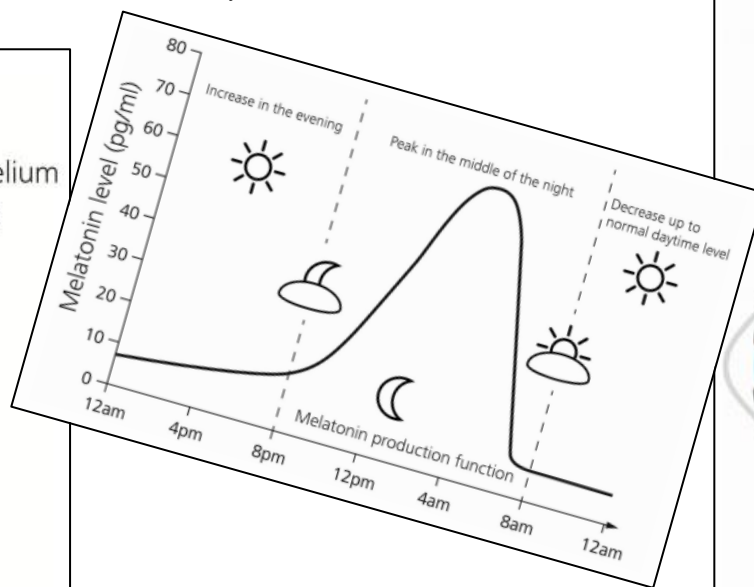

**FIGURE 2** Signal transduction of circadian information. A melanopsin induced signal from the ipRGCs is transmitted via the retino-hypothalamic tract (blue) to the hypothalamic pacemaker neurons in the suprachiasmatic nucleus (green), the human “master clock”. The circadian information is transmitted further downstream via the paraventricular nucleus (yellow), intermediolateral cell column in the vertebral gray matter, superior cervical ganglion (brown) to the pineal gland (purple), which is responsible for melatonin secretion

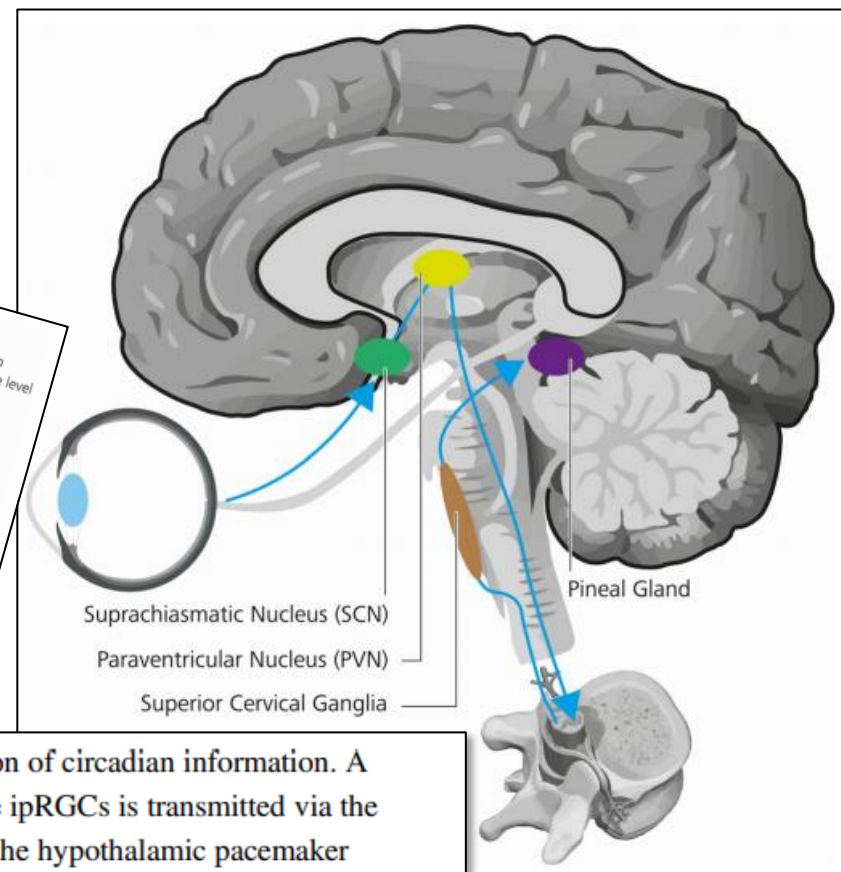

# Image formation

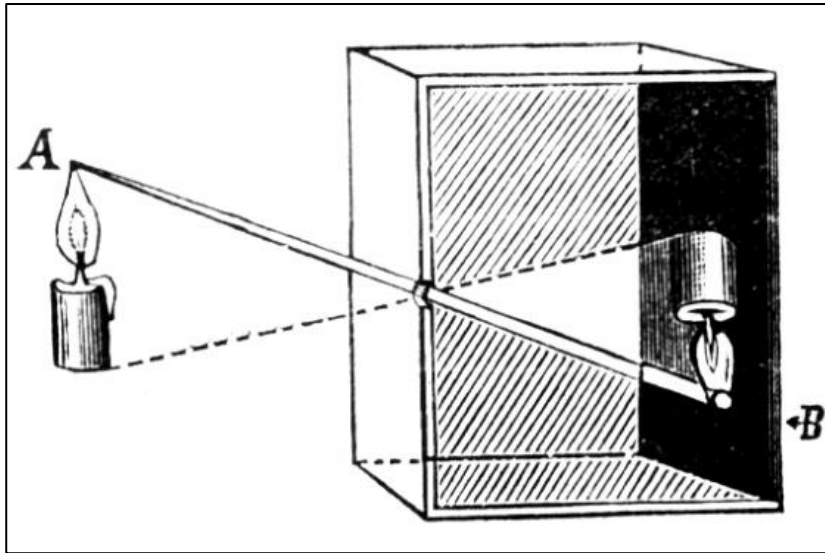

[https://www.fotoskoda.cz/images/manufacturers/camera\\_obscura.png](https://www.fotoskoda.cz/images/manufacturers/camera_obscura.png)

# Image formation

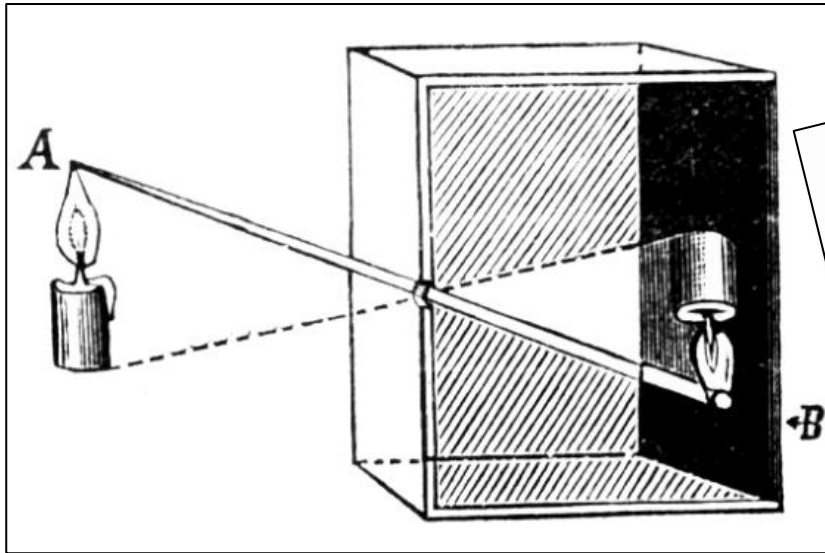

[https://www.fotoskoda.cz/images/manufacturers/camera\\_obscura.png](https://www.fotoskoda.cz/images/manufacturers/camera_obscura.png)

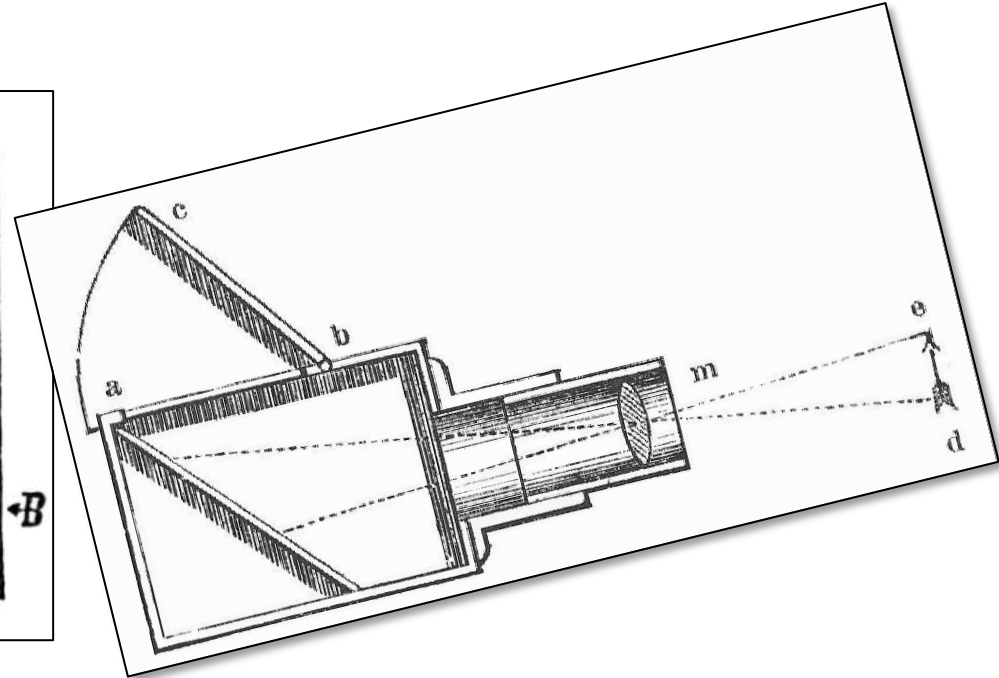

<http://de.academic.ru/pictures/meyers/large/030717c.jpg>



# Image formation

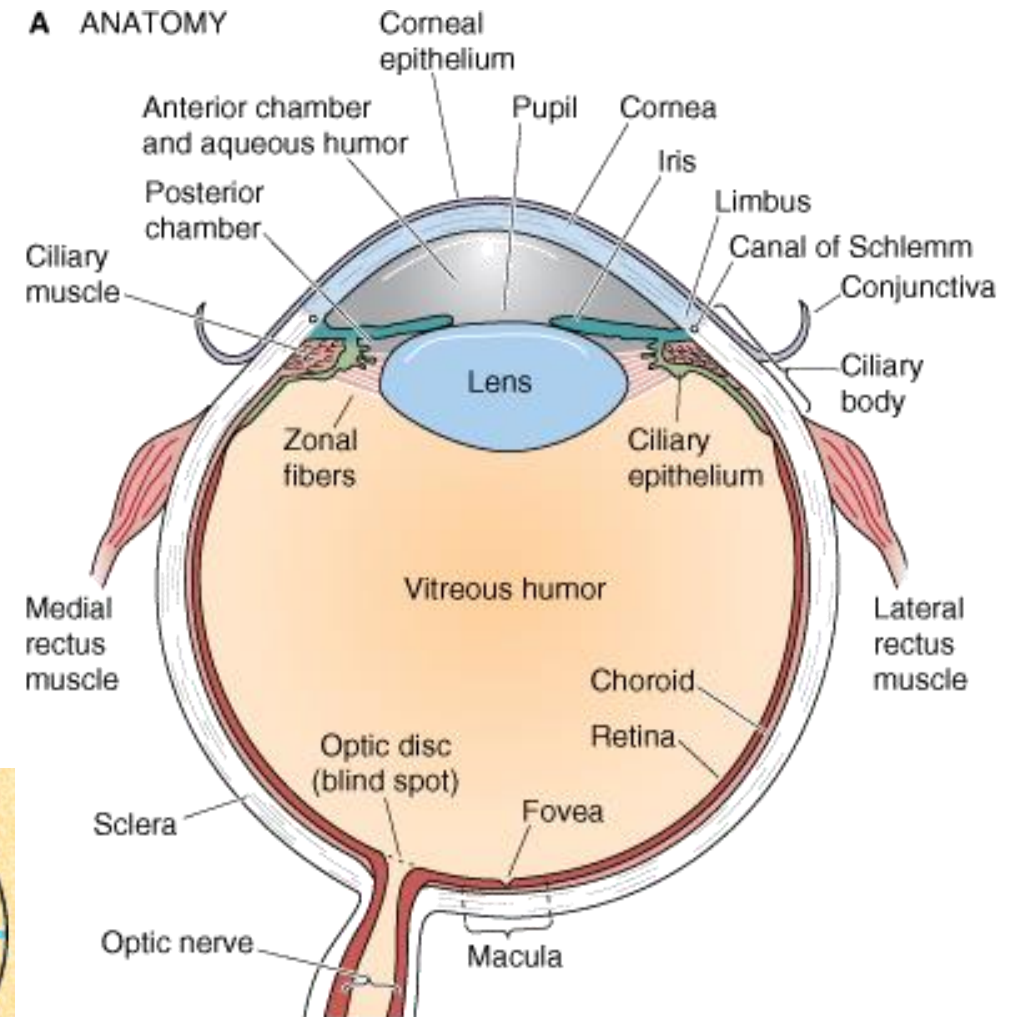
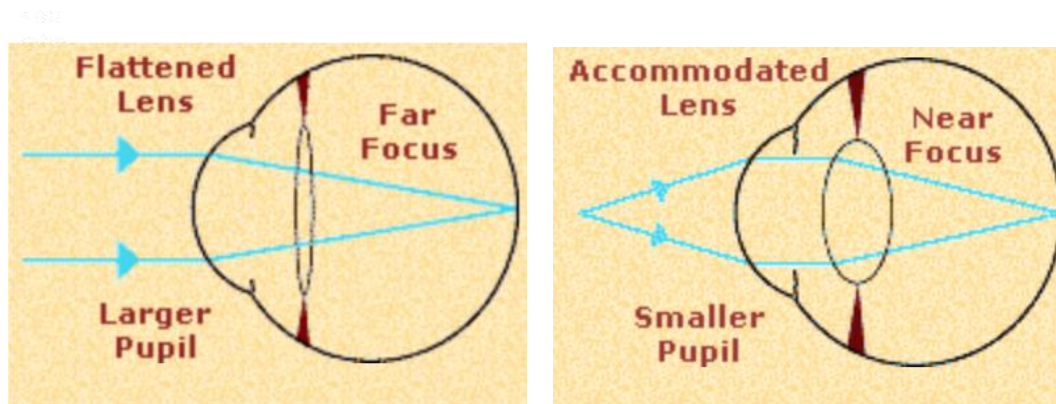

# Image formation

- Shape
- Color
- Localization
- Movement
  
- Image interpretation - CNS

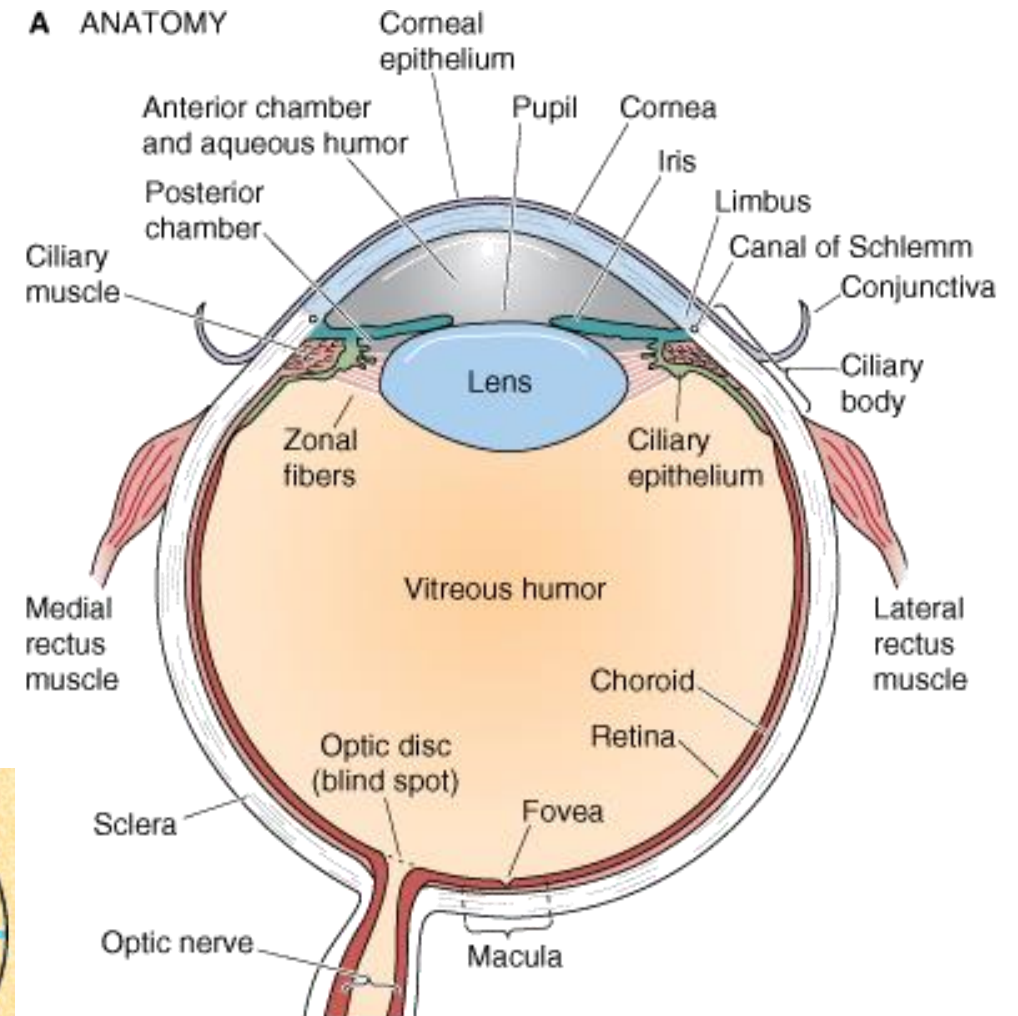
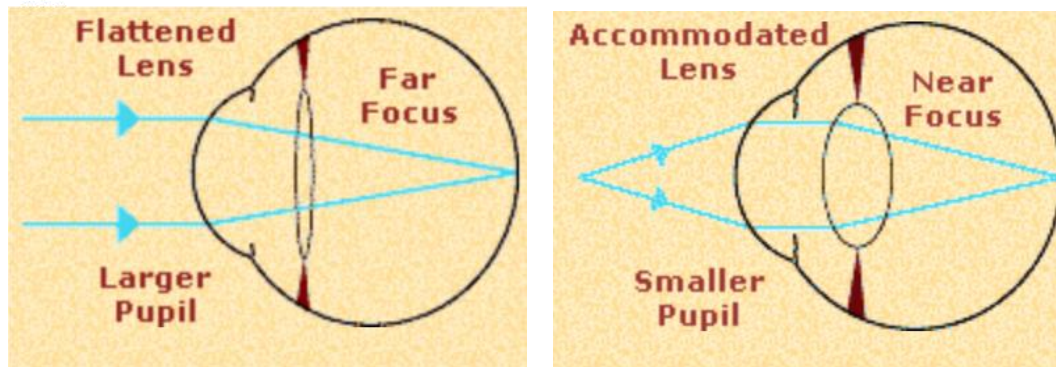

# Image formation

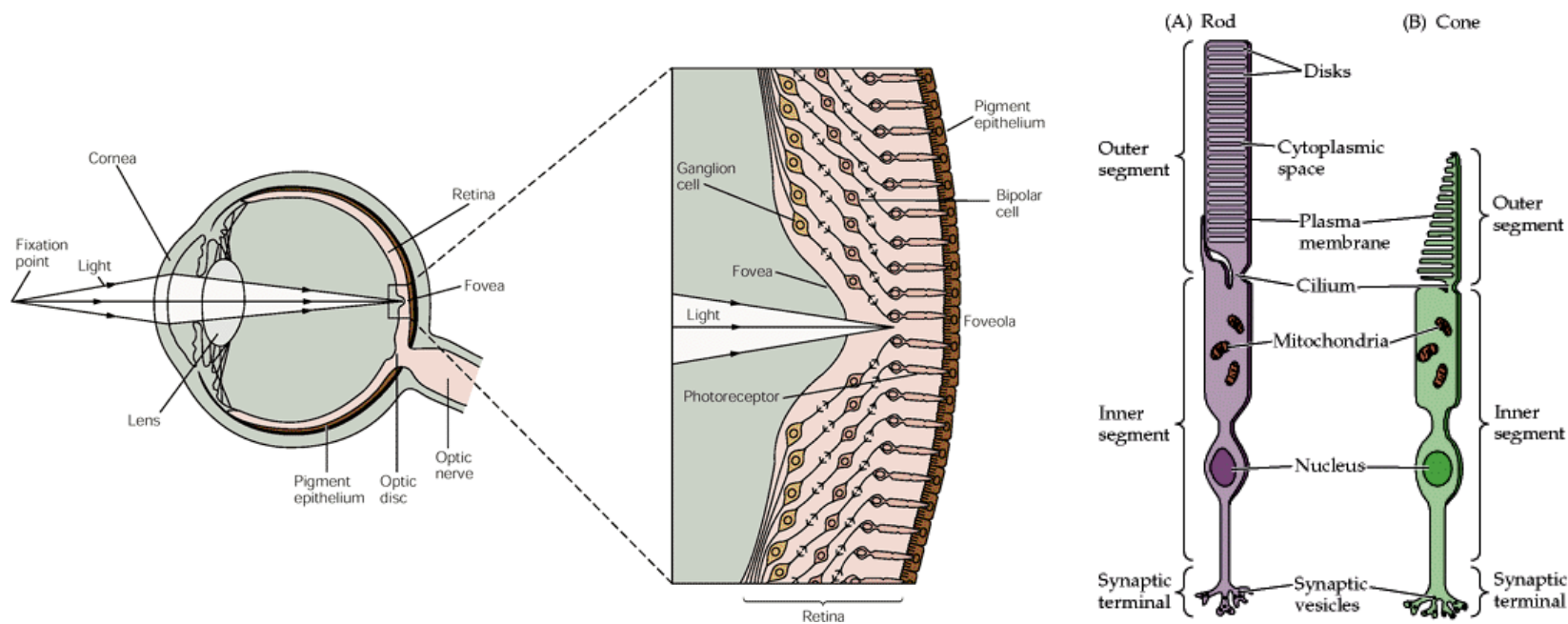
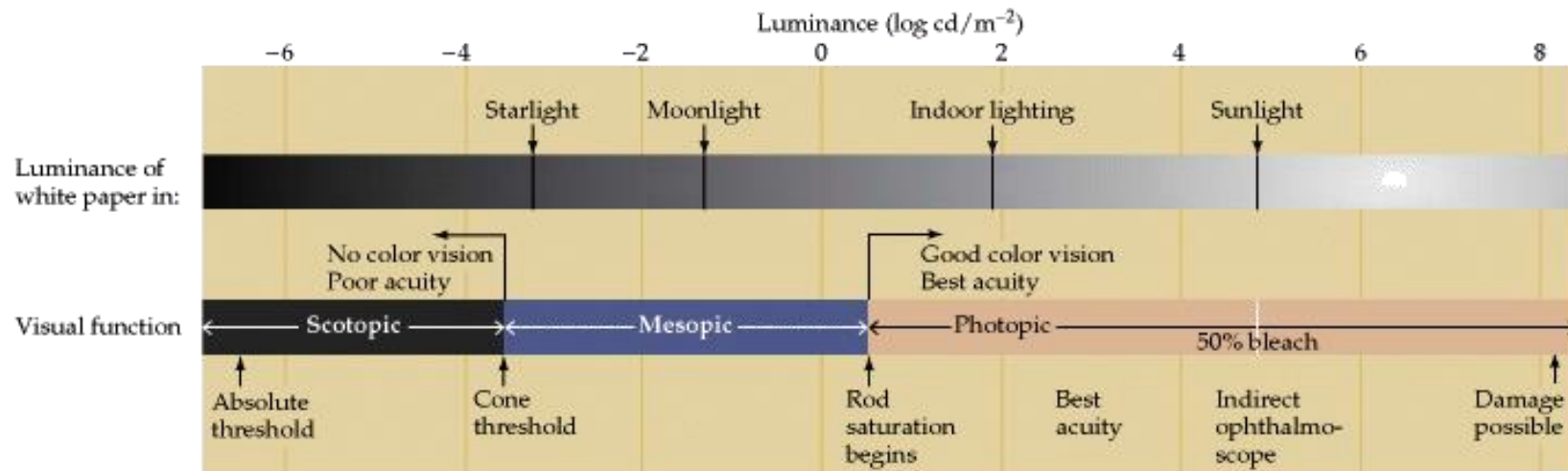
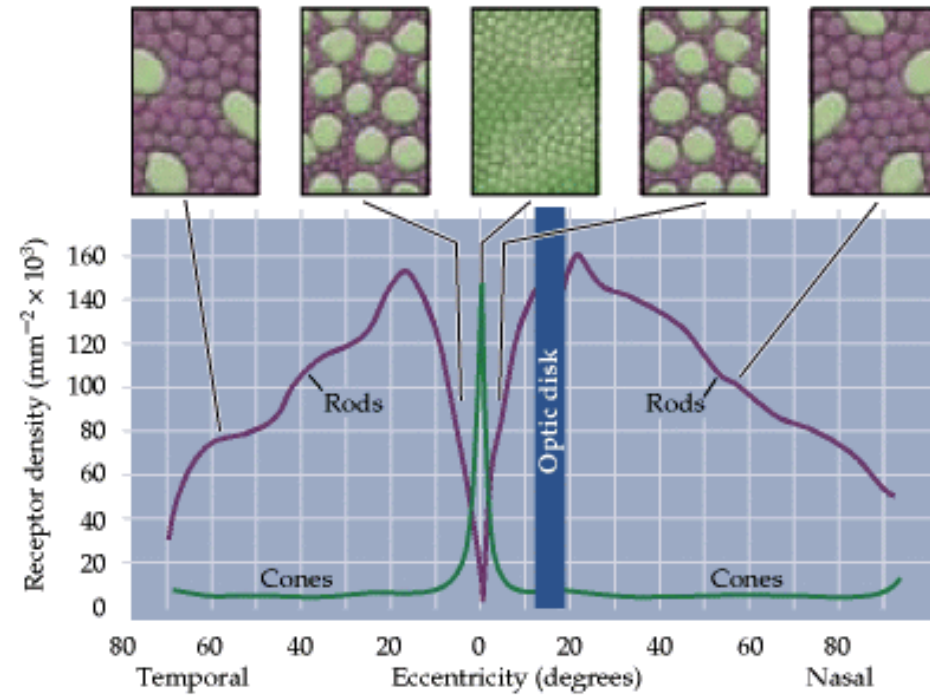

Table 26-1 Differences Between Rods and Cones and Their Neural Systems

Rods	Cones
High sensitivity to light, specialized for night vision	Lower sensitivity, specialized for day vision
More photopigment, capture more light	Less photopigment
High amplification, single photon detection	Lower amplification
Low temporal resolution: slow response, long integration time	High temporal resolution: fast response, short integration time
More sensitive to scattered light	Most sensitive to direct axial rays
<b>Rod system</b>	<b>Cone system</b>
Low acuity: not present in central fovea, highly convergent retinal pathways	High acuity: concentrated in fovea, dispersed retinal pathways
Achromatic: one type of rod pigment	Chromatic: three types of cones, each with a distinct pigment that is most sensitive to a different part of the visible light spectrum



# Photopigment of rods

## Rhodopsin

- Opsin
  - G – protein

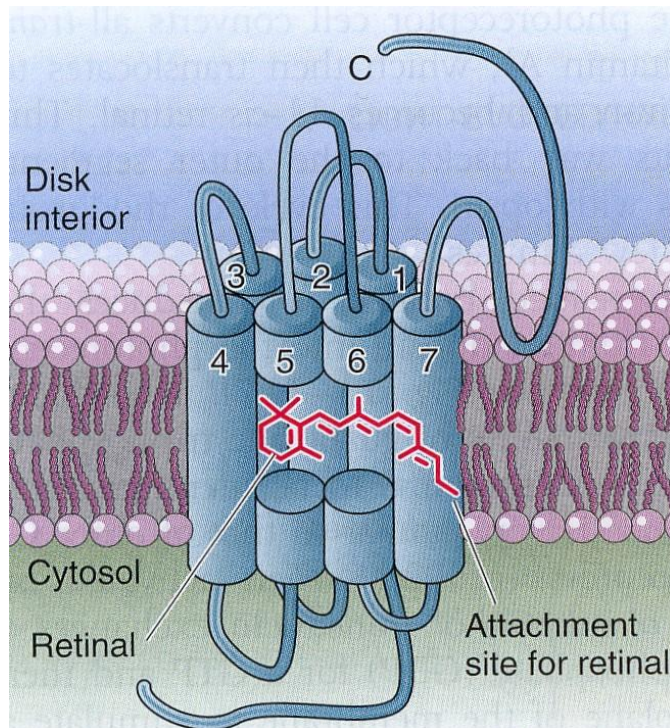

- Retinal
  - Retinol aldehyde (vit. A)

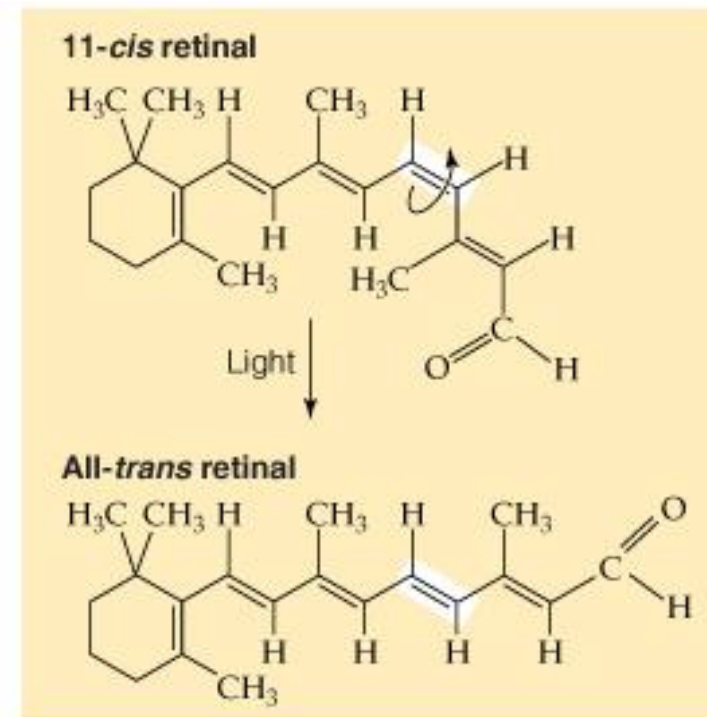

# Photopigments of cones

- 3 types of cones - 3 types of photopigment
  - Blue(420nm)
  - Green (530nm)
  - Red (560nm)

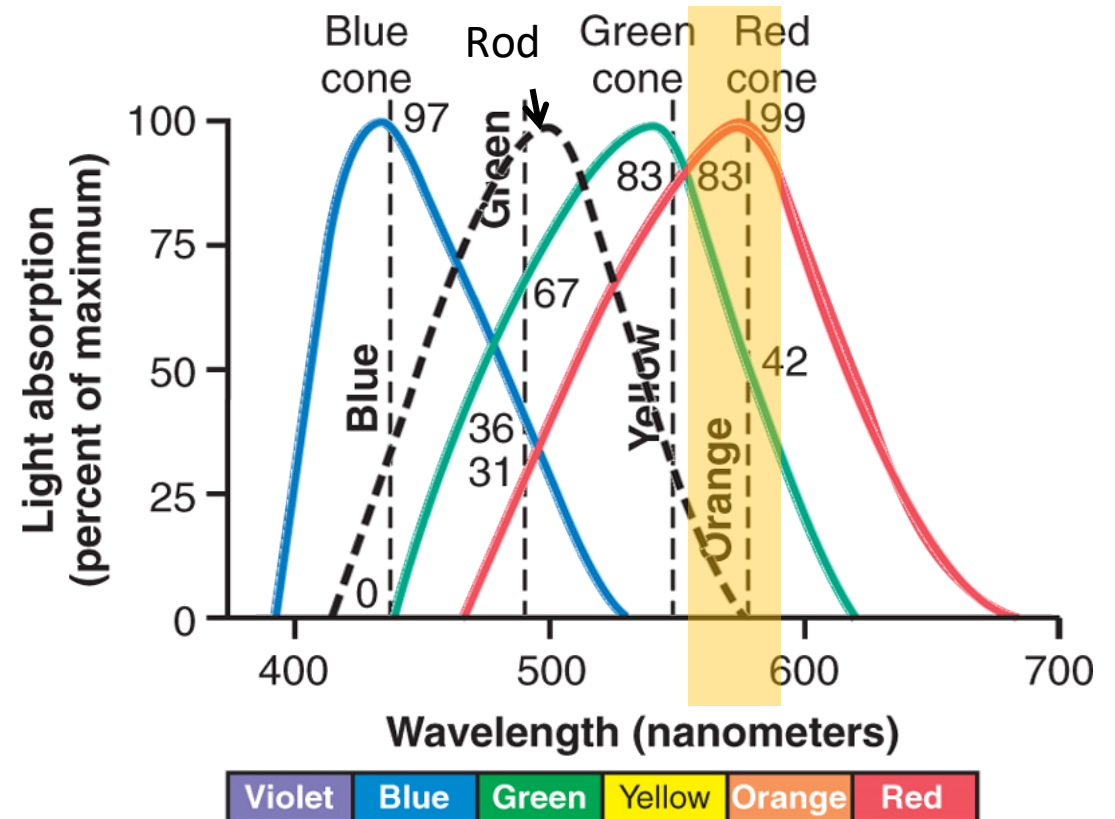

Hall: Guyton and Hall Textbook of Medical Physiology, 12th Edition  
Copyright © 2011 by Saunders, an imprint of Elsevier, Inc. All rights reserved.

<http://www.slideshare.net/CsillaEgri/presentations>

# Photopigments of cones

- 3 types of cones - 3 types of photopigment
  - Blue(420nm)
  - Green (530nm)
  - Red (560nm)
- Color is interpreted by ratio of cone stimulation
  - Orange (580nm)
    - Blue: 0%
    - Green: 42%
    - Red:99%

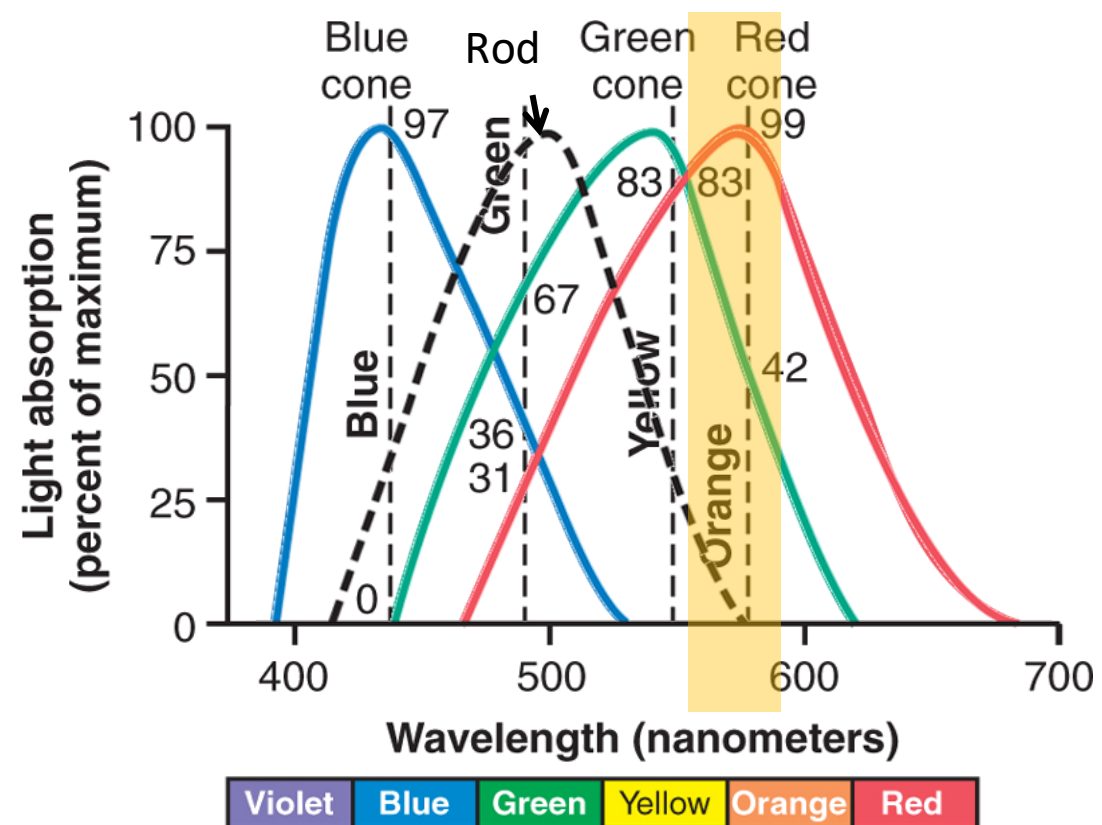

Hall: Guyton and Hall Textbook of Medical Physiology, 12th Edition  
Copyright © 2011 by Saunders, an imprint of Elsevier, Inc. All rights reserved.

<http://www.slideshare.net/CsillaEgri/presentations>

# Phototransduction

- Photoreceptors continuously release neurotransmitter (glutamate) in darkness
- In response to the light, the membrane **hyperpolarizes** and release less neurotransmitter

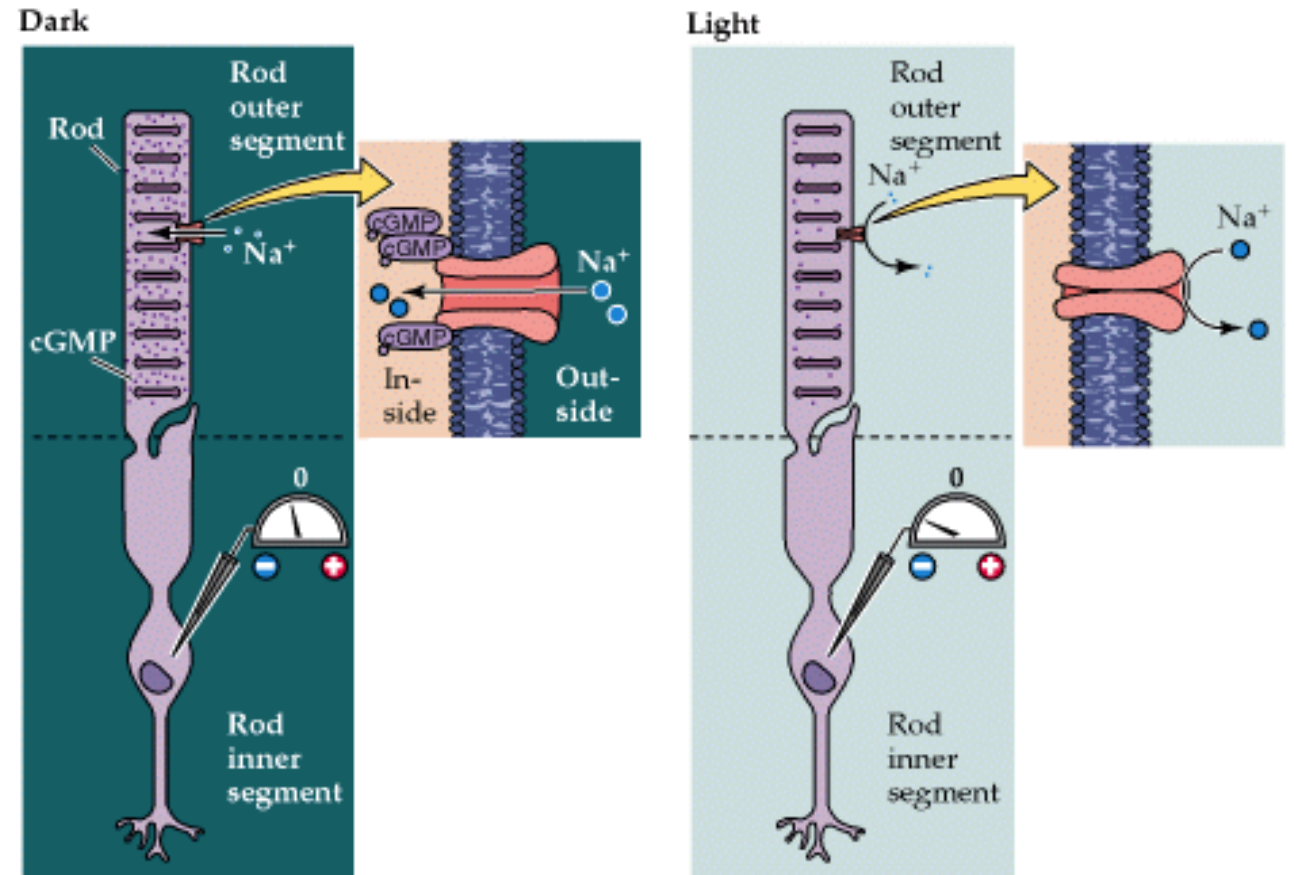

<http://www.slideshare.net/drpsdeb/presentations>



# Phototransduction - darkness

- Guanylate cyclase
  - cGMP
- cGMP-gated  $\text{Na}^+$  channels
  - $\text{Na}^+$  influx
- Voltage gated  $\text{Ca}^{2+}$  channels
  - Release of glutamate
- The balance is kept by
  - $\text{K}^+$  efflux
  - $\text{Na}^+/\text{K}^+$  exchanger
- Resting membrane potential:  $-40\text{mV}$

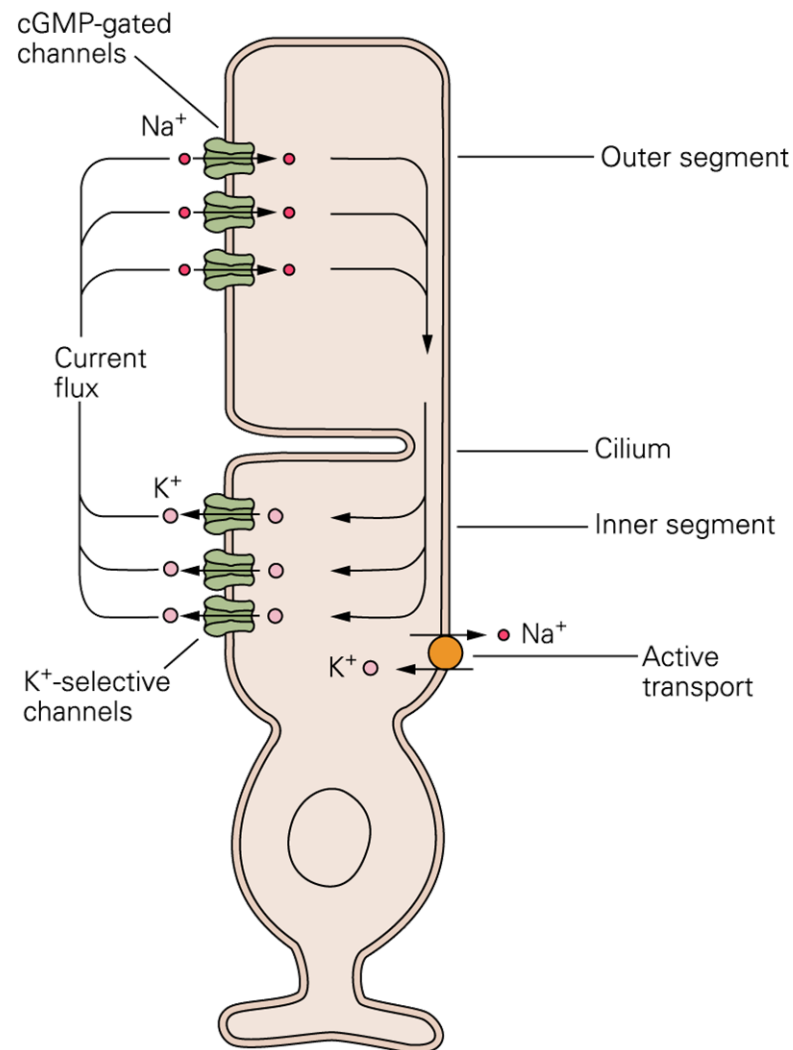

<http://www.slideshare.net/drpsdeb/presentations>

# Phototransduction - light

- Photon is absorbed by photopigment
- Isomerization of retinal
- Cascade of reactions result in cGMP phosphodiesterase
  - cGMP levels decreased
- Deactivation of cGMP gated  $\text{Na}^+$  channels
- $\text{K}^+$  efflux continues
- Membrane hyperpolarization
  - Deactivation of voltage  $\text{Ca}^{2+}$  channels
  - Decrease in glutamate release

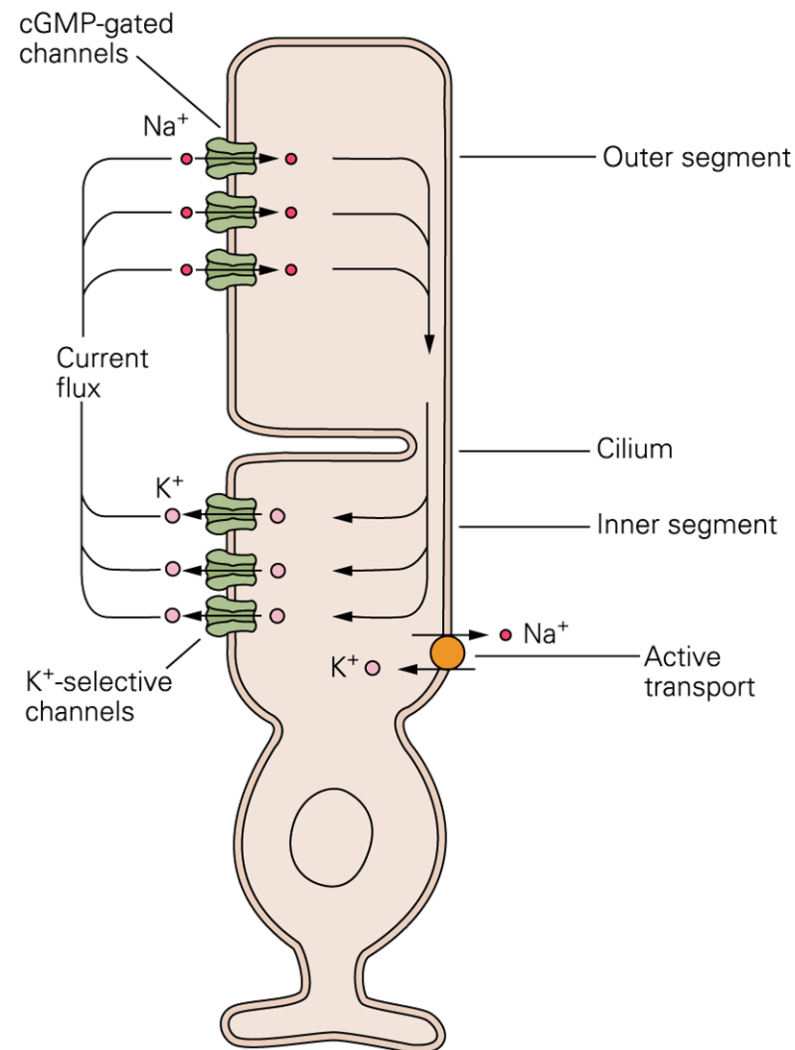

<http://www.slideshare.net/drpsdeb/presentations>

# Adaptation to the light/darkness

- **Optic adaptation**
  - Constriction of pupils
- **Photoreceptor adaptation**
  - $\text{Ca}^{2+}$  inhibits guanylate cyclase
  - cGMP gated  $\text{Na}^+$  channels...
  - Darkness
    - Higher  $\text{Ca}^{2+}$  levels  $\rightarrow$  cGMP decreased  $\rightarrow$  membrane more hyperpolarized  $\rightarrow$  „higher sensitivity to light“
  - Light
    - Lower  $\text{Ca}^{2+}$  levels  $\rightarrow$  cGMP increased  $\rightarrow$  membrane more depolarized  $\rightarrow$  „lower sensitivity to light“

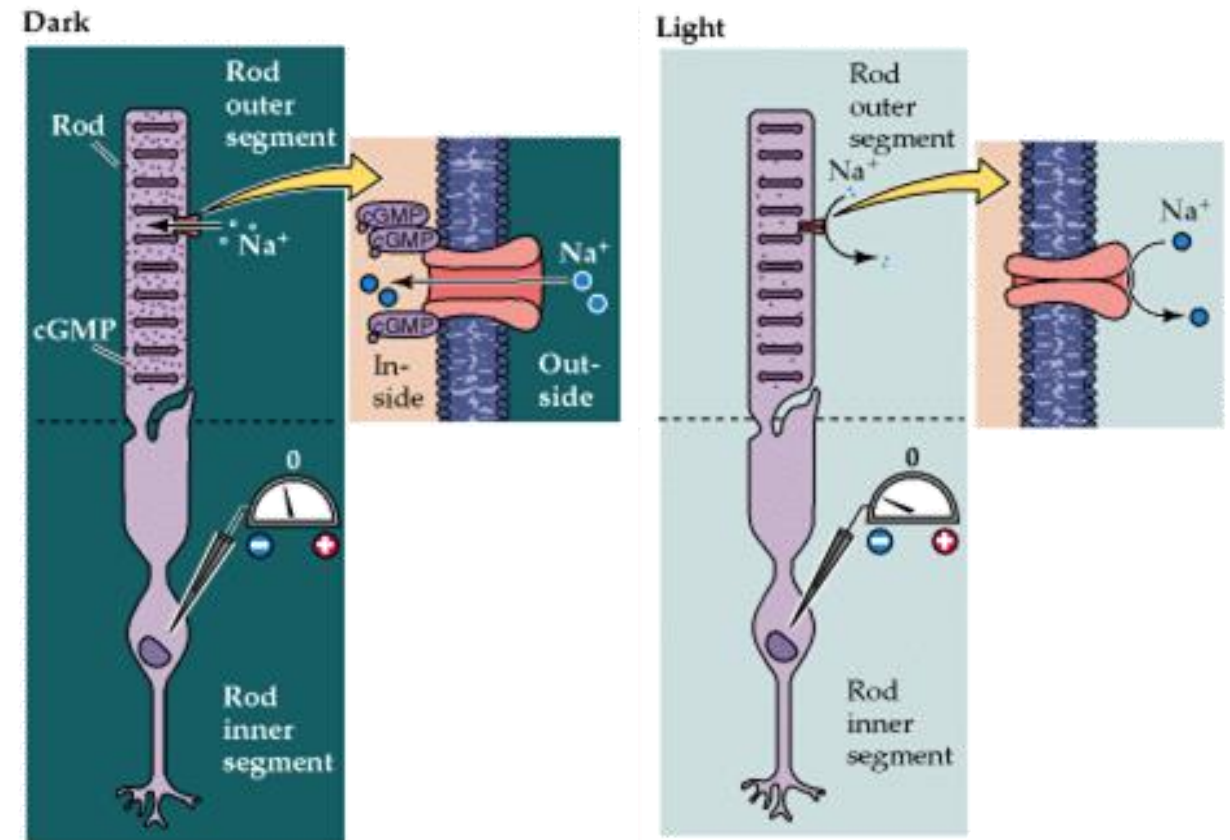

<http://www.slidesare.net/drpsdeb/presentations>

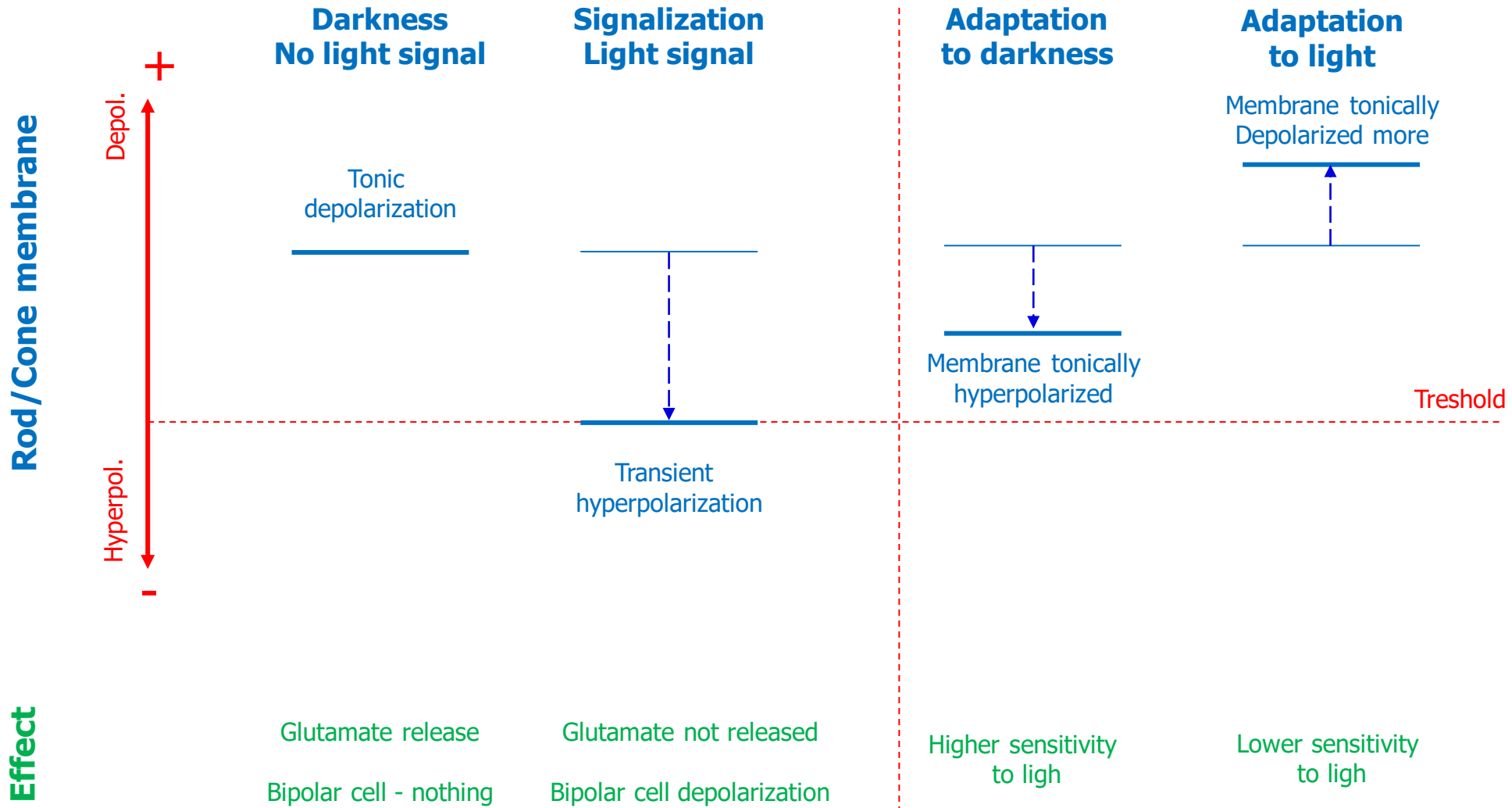

## 77. The basic physiology of visual system – light detection vs. image formation, circadian rhythms

- Brief characterization of light
- Light detection (LD) vs. image formation (IF)
- LD - almost all the living organisms
  - one of the oldest functions
  - mainly for circadian activity synchronization
- IF - Functional overview of eye anatomy (camera obscura with a lens)
- Circadian rhythms
  - Definition + importance
  - Biological clock (cellular level, tissue level, central pacemaker)
  - Brief overview of circadian rhythms in humans (“active” hours, “rest” hours, physiological changes, associated hormone oscillations...)

## 78. The basic physiology of visual system – rods and cones function, on/off receptive field, nervus opticus vs. tractus opticus

- Rods and cones function
  - Characterization and comparison
  - Phototransduction mechanism and adaptation
- Brief overview of retina organization (retina process receptor potential – analog, AP is generated in ganglion cells)
- Receptive field organization
  - On/off receptive fields
  - Magnocellular system (BW)
  - Parvocellular system (Color)
- Nervus opticus vs. tractus opticus
- Projections from tractus opticus (Main centers in the brain involved in visual signals processing)

M U N I

M E D