

Příklad

K danému tělesu sestrojte jednotlivé pohledy.

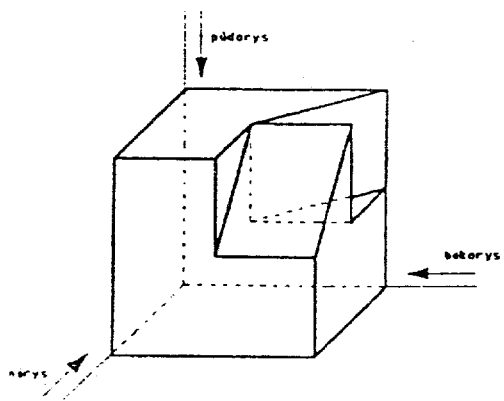

Řešení:

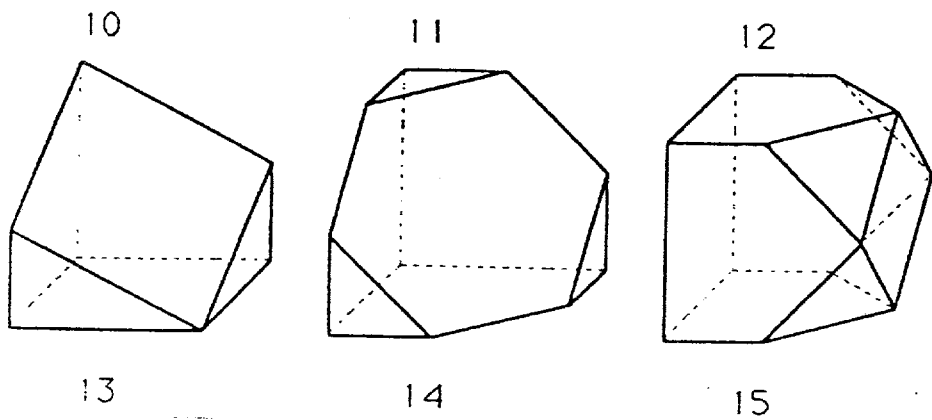
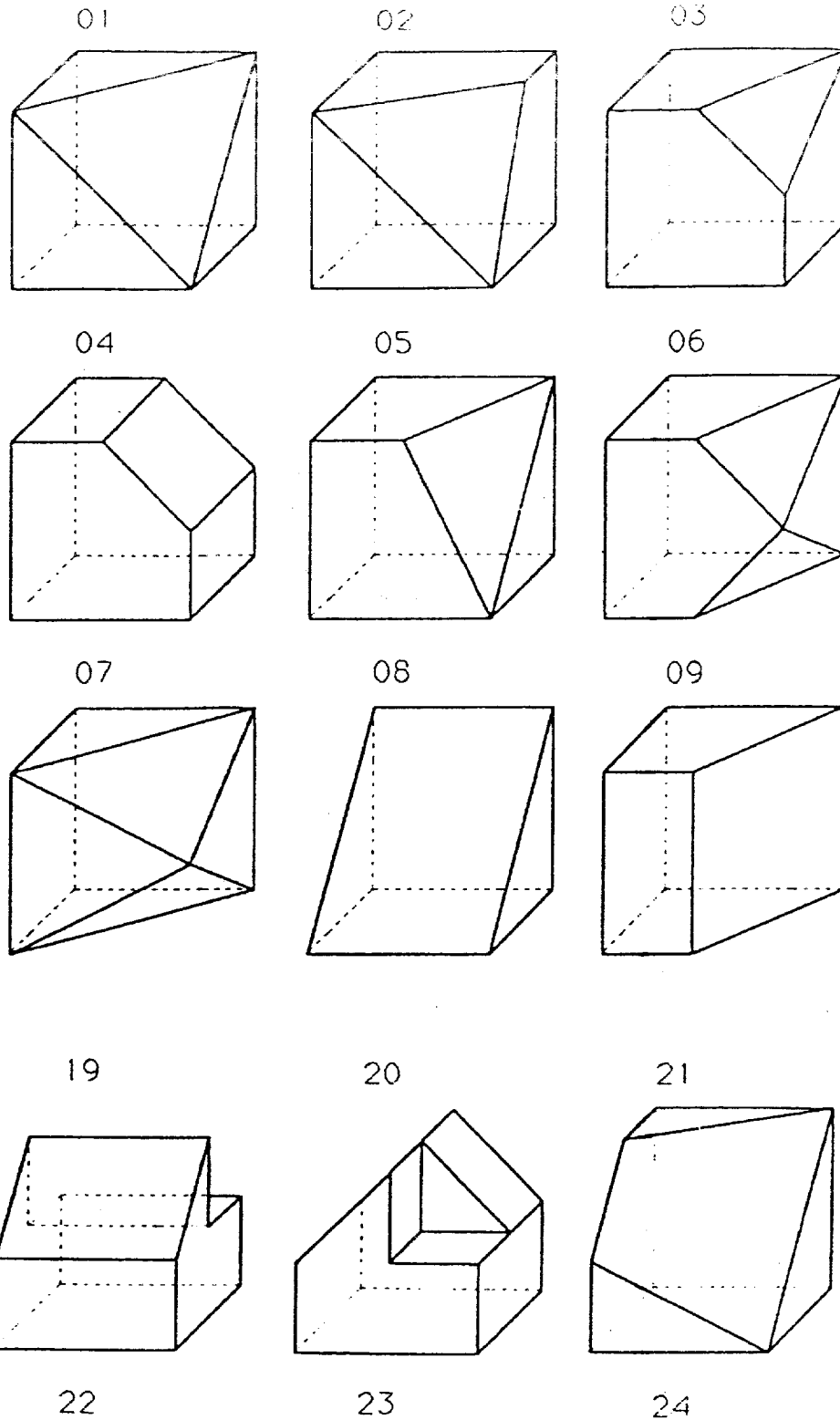
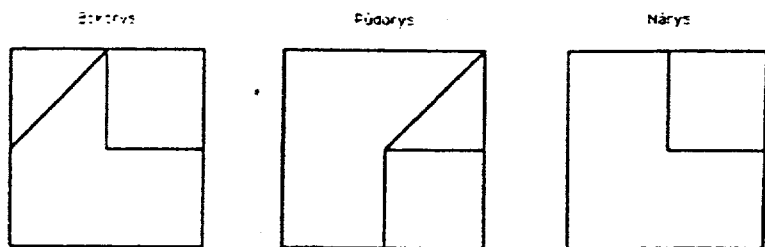

26 Bokorys

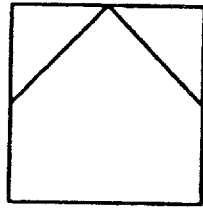

Püörys

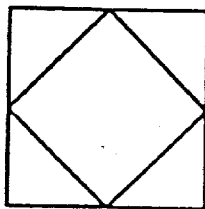

Nárys

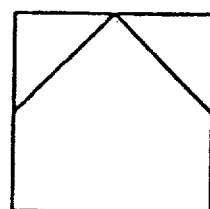

27 Bokorys

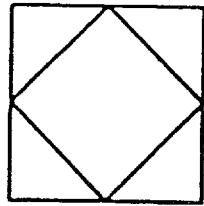

Püörys

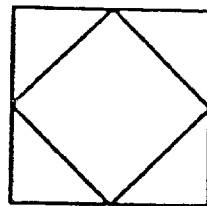

Nárys

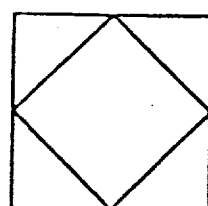

28 Bokorys

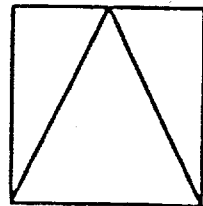

Püörys

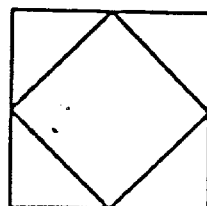

Nárys

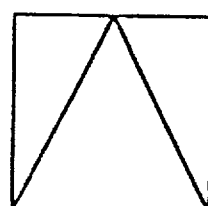

29 Bokorys

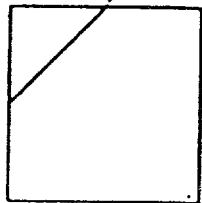

Püörys

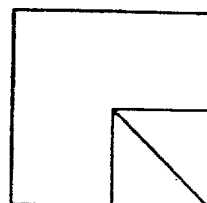

Nárys

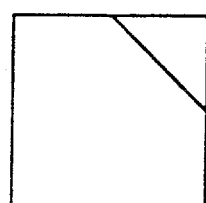

30 Bokorys

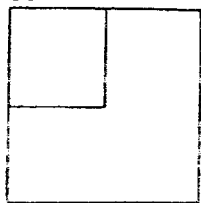

Püörys

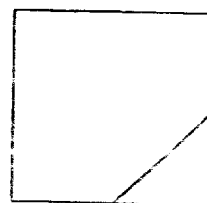

Nárys

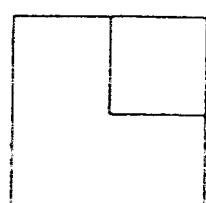

36 Bokorys

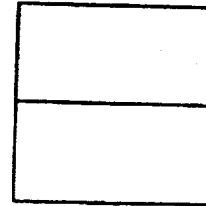

Püörys

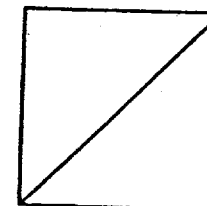

Nárys

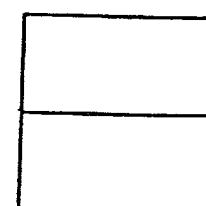

37 Bokorys

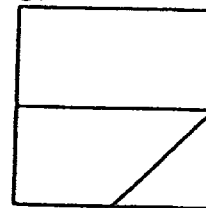

Püörys

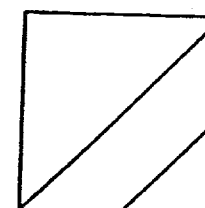

Nárys

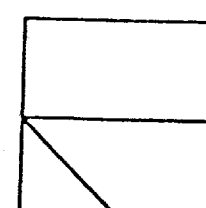

38 Bokorys

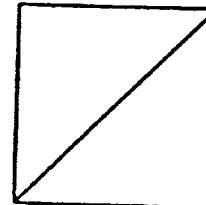

Püörys

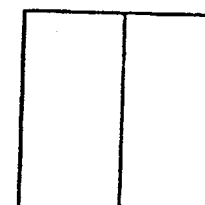

Nárys

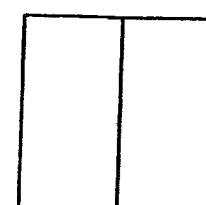

39 Bokorys

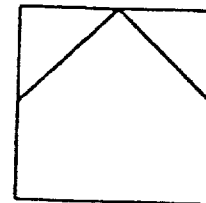

Püörys

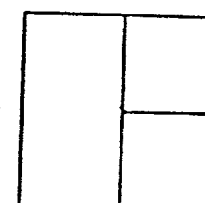

Nárys

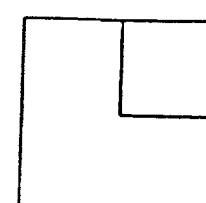

40 Bokorys

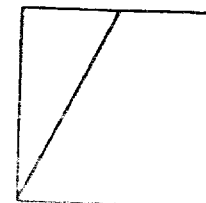

Püörys

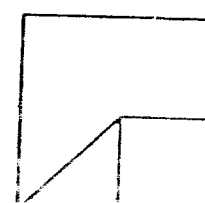

Nárys

