

KRYSTALICKÁ STAVBA LÁTEK (KOVŮ)

Základy krystalografie

Vazba mezi atomy

Molekuly a krystaly pevných látek tvořeny atomy. Typ vazby mezi atomy určen způsobem jakým jsou k sobě atomy poutány (valenční síly):

- Iontová vazba (atomy s výraznou elektronegativitou).
- Kovalentní vazba (překryv valenčních orbitálů – vznik elektronového páru).

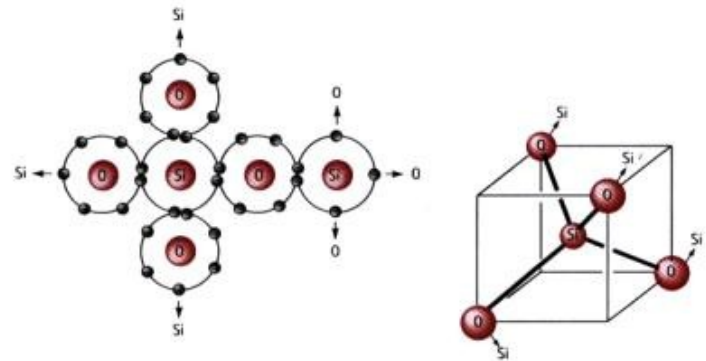
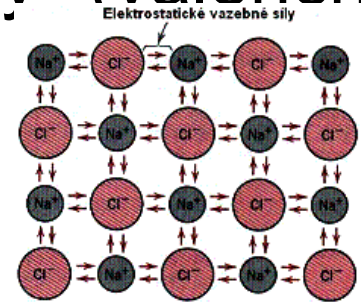

Vazba mezi atomy

- Vazba Van der Waalsova.
- Kovová vazba (klad. ionty+elektronový plyn).

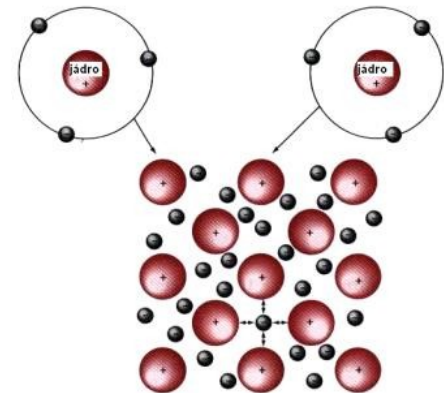
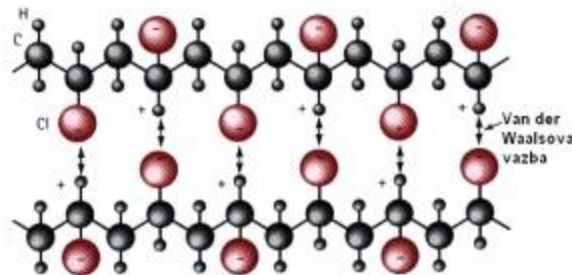
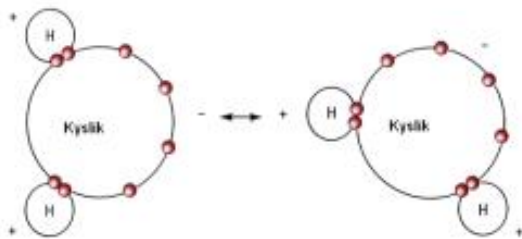

Uspořádání hmoty v prostoru

Skupenství: pevné, plynné, kapalné.

Z hlediska uspořádanosti:

- neuspořádané,
- uspořádané na krátkou vzdálenost,
- uspořádané na velkou vzdálenost
(krystalová mřížka).

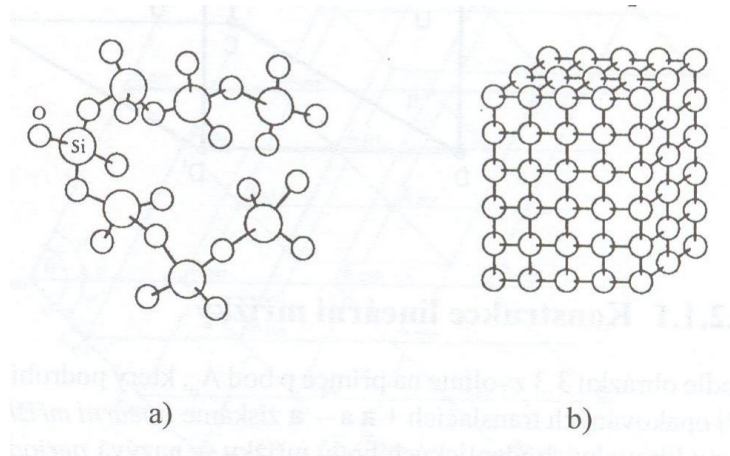

IA											VIII															
1 1.008 H Hydrogen											2 4.003 He Helium															
IIA											IIIA	IVA	VA	VIA	VIIA	VIII										
3 6.941 Li Lithium	4 9.012 Be Beryllium											5 10.811 B Boron	6 12.011 C Carbon	7 14.007 N Nitrogen	8 15.999 O Oxygen	9 18.998 F Fluorine	10 20.180 Ne Neon									
11 22.990 Na Sodium	12 24.305 Mg Magnesium											13 26.982 Al Aluminum	14 28.086 Si Silicon	15 30.974 P Phosphorus	16 32.066 S Sulfur	17 35.453 Cl Chlorine	18 39.948 Ar Argon									
IIIB	IVB	VB	VIB	VIIB	VIII	IB	IIB	IIIA	IVA	VA	VIA	VIIA	VIII	IIIA	IVA	VA	VIA	VIIA	VIII							
19 39.098 K Potassium	20 40.08 Ca Calcium	21 44.956 Sc Scandium	22 47.88 Ti Titanium	23 50.942 V Vanadium	24 51.996 Cr Chromium	25 54.938 Mn Manganese	26 55.847 Fe Iron	27 58.933 Co Cobalt	28 58.70 Ni Nickel	29 63.546 Cu Copper	30 65.38 Zn Zinc	31 69.72 Ga Gallium	32 72.61 Ge Germanium	33 74.922 As Arsenic	34 78.96 Se Selenium	35 79.904 Br Bromine	36 83.80 Kr Krypton									
37 85.468 Rb Rubidium	38 87.62 Sr Strontium	39 88.906 Y Yttrium	40 91.22 Zr Zirconium	41 92.906 Nb Niobium	42 95.94 Mo Molybdenum	43 98 Tc Technetium	44 101.07 Ru Ruthenium	45 102.906 Rh Rhodium	46 106.42 Pd Palladium	47 107.868 Ag Silver	48 112.41 Cd Cadmium	49 114.82 In Indium	50 118.71 Sn Tin	51 121.76 Sb Antimony	52 127.60 Te Tellurium	53 126.905 I Iodine	54 131.29 Xe Xenon									
55 132.905 Cs Cesium	56 137.33 Ba Barium	57 138.906 La Lanthanum	72 178.48 Hf Hafnium	73 180.948 Ta Tantalum	74 183.85 W Tungsten	75 186.207 Re Rhenium	76 186.2 Os Osmium	77 192.22 Ir Iridium	78 195.08 Pt Platinum	79 196.967 Au Gold	80 200.59 Hg Mercury	81 204.38 Tl Thallium	82 207.2 Pb Lead	83 208.980 Bi Bismuth	84 (209) Po Polonium	85 (210) At Astatine	86 (222) Rn Radon									
87 (223) Fr Francium	88 226.025 Ra Radium	89 227.028 Ac Actinium											58 140.12 Ce Cerium	59 140.908 Pr Praseodymium	60 144.24 Nd Neodymium	61 (145) Pm Promethium	62 150.36 Sm Samarium	63 151.97 Eu Europium	64 157.25 Gd Gadolinium	65 158.925 Tb Terbium	66 162.50 Dy Dysprosium	67 164.930 Ho Holmium	68 167.26 Er Erbium	69 168.934 Tm Thulium	70 173.04 Yb Ytterbium	71 174.967 Lu Lutetium
III	IV	V	VI	VII	VIII	IX	X	XI	XII	XIII	XIV	XV	XVI	XVII	XVIII	XIX	XX	XXI	XXII							
90 232.038 Th Thorium	91 231.036 Pa Protactinium	92 238.029 U Uranium	93 237.048 Np Neptunium	94 (244) Pu Plutonium	95 (243) Am Americium	96 (247) Cm Curium	97 (247) Bk Berkelium	98 (251) Cf Californium	99 (252) Es Einsteinium	100 (257) Fm Fermium	101 (258) Md Mendelevium	102 (259) No Nobelium	103 (260) Lr Lawrencium													

	meters	dm	cm	mm	µm	nm	Å
1 Å =	10 ⁻¹⁰	10 ⁻⁹	10 ⁻⁸	10 ⁻⁷	10 ⁻⁶	10 ⁻⁵	1
1 nm =	10 ⁻⁹	10 ⁻⁸	10 ⁻⁷	10 ⁻⁶	10 ⁻⁵	1	10
1 µm =	10 ⁻⁶	10 ⁻⁵	10 ⁻⁴	10 ⁻³	1	10 ³	10 ⁴
1 mm =	10 ⁻³	10 ⁻²	10 ⁻¹	1	10 ³	10 ⁶	10 ⁷
1 cm =	10 ⁻²	10 ⁻¹	1	10	10 ⁴	10 ⁷	10 ⁸
1 dm =	10 ⁻¹	1	10	10 ²	10 ⁵	10 ⁸	10 ⁹
1 m =	1	10	10 ²	10 ³	10 ⁶	10 ⁹	10 ¹⁰

Crystal Structures

- Cubic, face centered
- Cubic, body centered
- Cubic
- Hexagonal
- Monoclinic
- Orthorhombic
- Tetragonal
- Rhombohedral

Atomic Number

Atomic Weight

Symbol

K_a Energy (+)

L_a Energy (+)

M_a Energy (+)

Crystal Structure

Alkali Earth

Alkaline Earth

Rare Earth

Other Metals

Non-Metals

Halogens

Transition Metals



Metalloids

Noble Gases

58 140.12 Ce Cerium	59 140.908 Pr Praseodymium	60 144.24 Nd Neodymium	61 (145) Pm Promethium	62 150.36 Sm Samarium	63 151.97 Eu Europium	64 157.25 Gd Gadolinium	65 158.925 Tb Terbium	66 162.50 Dy Dysprosium	67 164.930 Ho Holmium	68 167.26 Er Erbium	69 168.934 Tm Thulium	70 173.04 Yb Ytterbium	71 174.967 Lu Lutetium
90 232.038 Th Thorium	91 231.036 Pa Protactinium	92 238.029 U Uranium	93 237.048 Np Neptunium	94 (244) Pu Plutonium	95 (243) Am Americium	96 (247) Cm Curium	97 (247) Bk Berkelium	98 (251) Cf Californium	99 (252) Es Einsteinium	100 (257) Fm Fermium	101 (258) Md Mendelevium	102 (259) No Nobelium	103 (260) Lr Lawrencium

Základy krystalografie

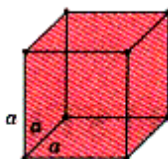
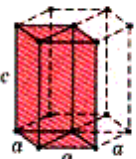
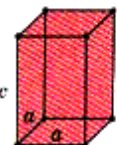
7 krystalografických soustav

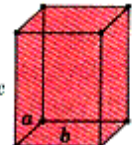
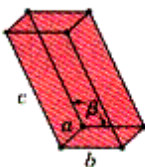
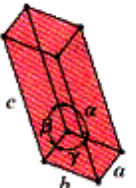
Soustava	Úseky na osách	Úhly	Elementární buňka
Kubická (krychlová) prostá, prostorově a plošně centrovaná.	$a = b = c$	$\alpha = \beta = \gamma = 90^\circ$	
Šesterečná (hexagonální), prostá	$a = b \neq c$	$\alpha = \beta = 90^\circ, \gamma = 120^\circ$	
Čtverečná (tetragonální), prostá a prostorově centrovaná	$a = b \neq c$	$\alpha = \beta = \gamma = 90^\circ$	
Trigonální - klencová (romboedrická), prostá	$a = b = c$	$\alpha = \beta = \gamma \neq 90^\circ$	
Kosočtverečná (ortorombická), prostá, bazálně, plošně i prostorově centrovaná.	$a \neq b \neq c$	$\alpha = \beta = \gamma = 90^\circ$	
Jednoklonná (monoklinická), prostá a bazálně centrovaná	$a \neq b \neq c$	$\alpha = \gamma = 90^\circ \neq \beta$	
Trojklonná (triklinická), prostá	$a \neq b \neq c$	$\alpha \neq \beta \neq \gamma \neq 90^\circ$	

Základy krystalografie

14 Bravaisových mřížek.

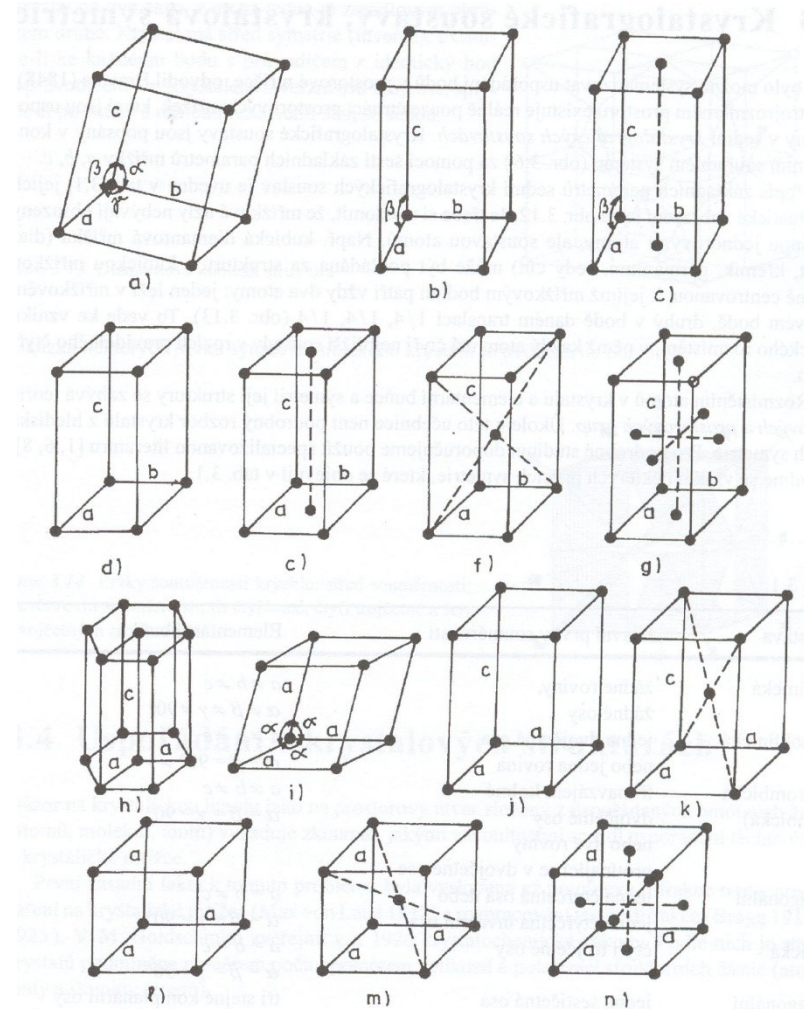
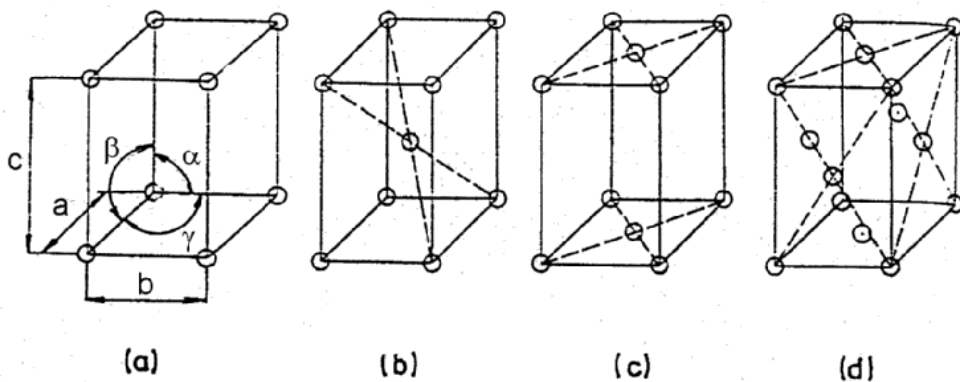

Základní typy kovových struktur

Většina kovů a jejich slitin krystalizuje:

- Krychlová plošně centrovaná mřížka **fcc** (face centred cubic).
- Krychlová prostorově centrovaná mřížka **bcc** (body centred cubic).
- Hexagonální těsně uspořádaná mřížka **hcp** (hexagonal close packed).

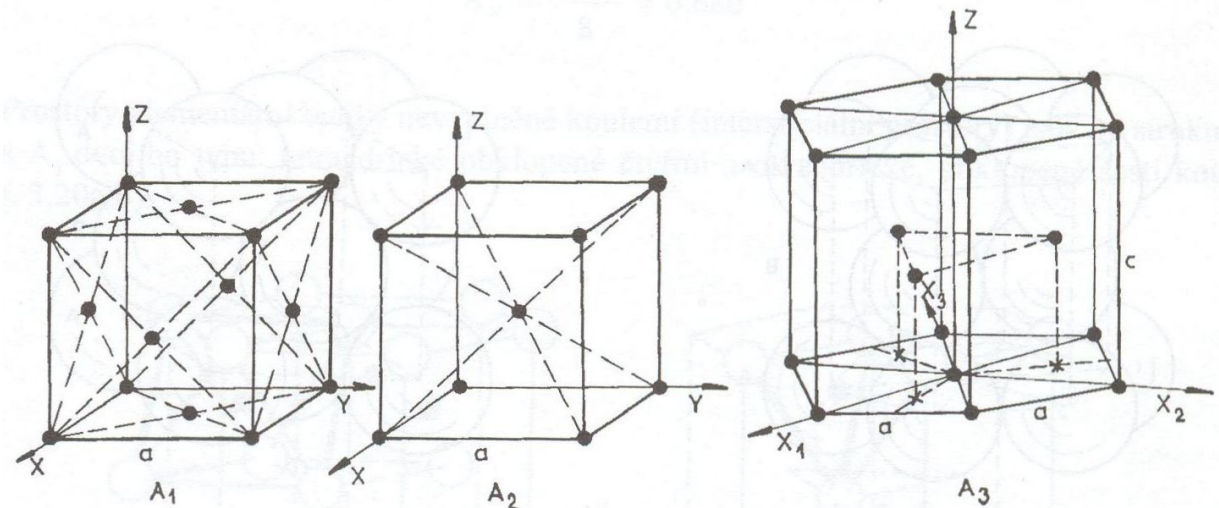

Základní typy kovových struktur

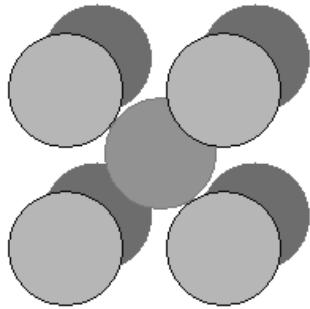

bcc

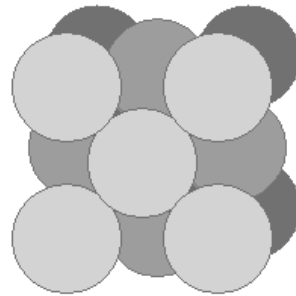

fcc

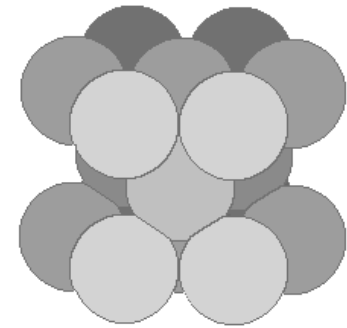

hcp

I přes výrazné zaplnění prostoru atomy zůstávají v mřížce volná místa – tzv. intersticiální dutiny.

Poruchy krystalické mřížky

V ideálním krystalu jsou všechny uzlové body obsazeny atomy.

Vady v krystalech:

- bodové vady,
- čárové vady,
- plošné vady,
- prostorové vady.

Bodové poruchy

Poruchy v čistých kovech:

- vakance,
- intersticiály.

V tuhých roztocích navíc:

- substituční a
- intersticiální příměsi.

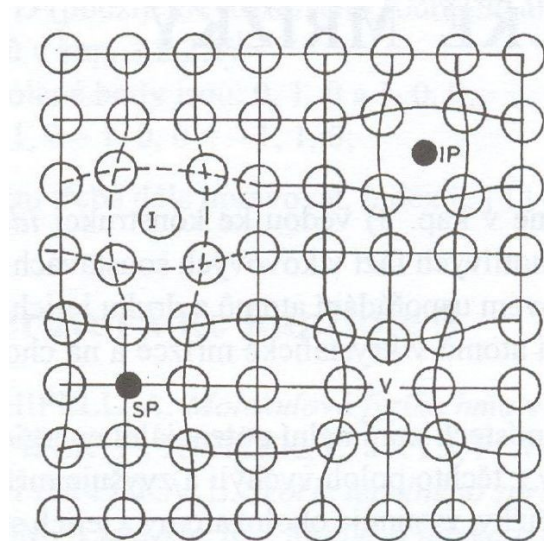
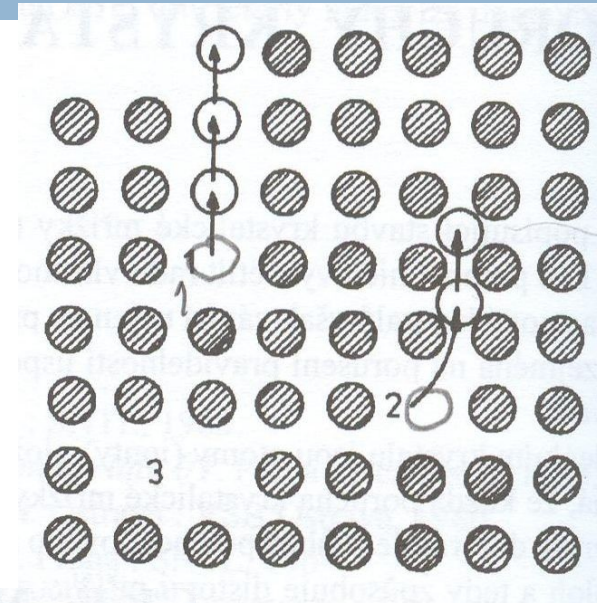

Čárové a hranové poruchy

Vznikají přesunutím (dislokováním) určitého množství atomů při skluzovém pohybu.

Dislokace:

- hranové,
- šroubové.

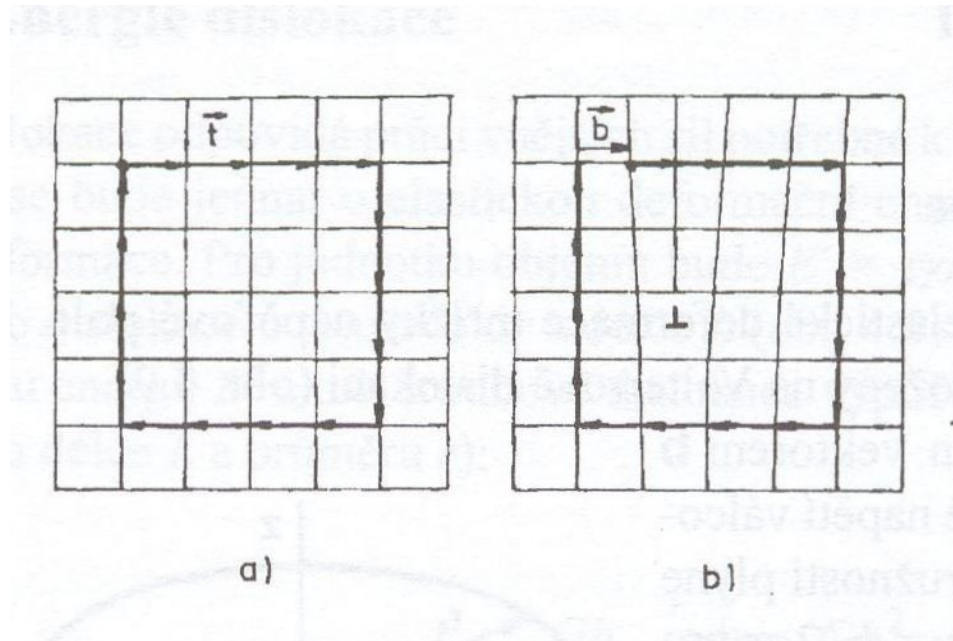

b - Burgersův vektor udává charakter dislokace.

Závěr

Literatura:

- [1] Askeland, D.R. *The Science and Engineering of Materials*. Chapman & Hall, 1996.
- [2] Ptáček a kol. *Nauka o materiálu I a II*. CERM, 2003, 520+396 s.
- [3] Hluchý, M., Kolouch, J. *Strojírenská technologie 1*. Scientia, 2007, 266 s.
- [4] internet <<http://ime.fme.vutbr.cz/vyukazs.html>>
- [5] internet < http://ime.fme.vutbr.cz/studijni_opory.html >

