

VÝROBKY ZE DŘEVA

inspirace pro tvorbu

DŘEVÁK

ZAČÁTEČNÍCI

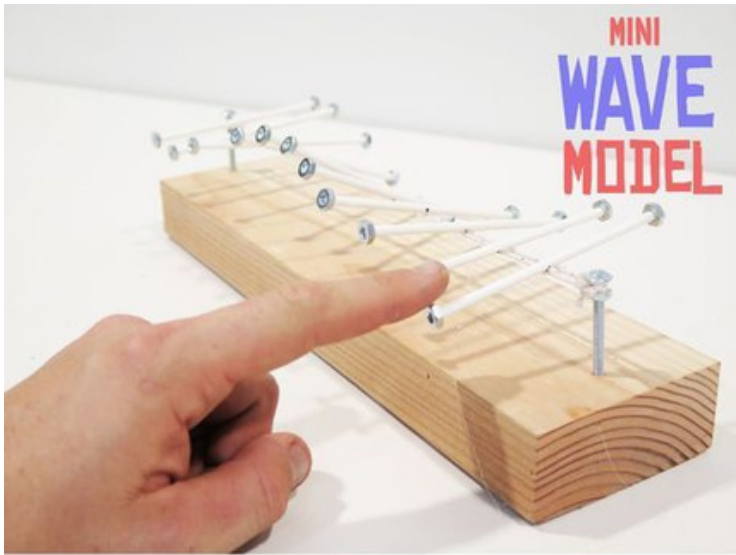

DŘEVONÁPADY

DŘEVÁK

inspirace pro tvorbu

ZAČÁTEČNÍCI



family handyman

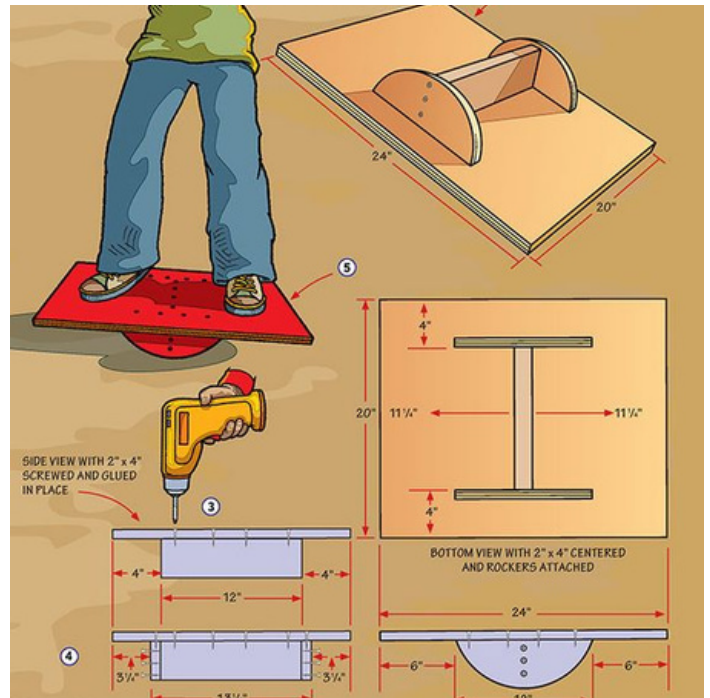

DŘEVONÁPADY

DŘEVÁK

inspirace pro tvorbu

ZAČÁTEČNÍCI

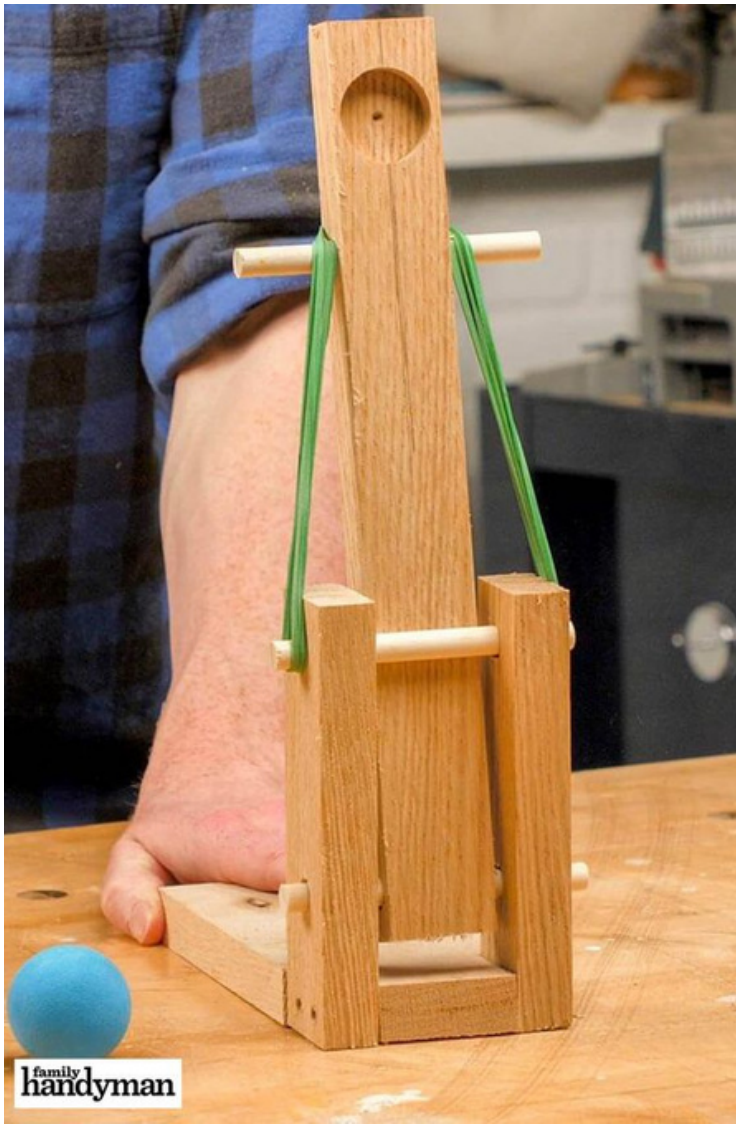

DŘEVONÁPADY

DŘEVÁK

inspirace pro tvorbu

ZAČÁTEČNÍCI

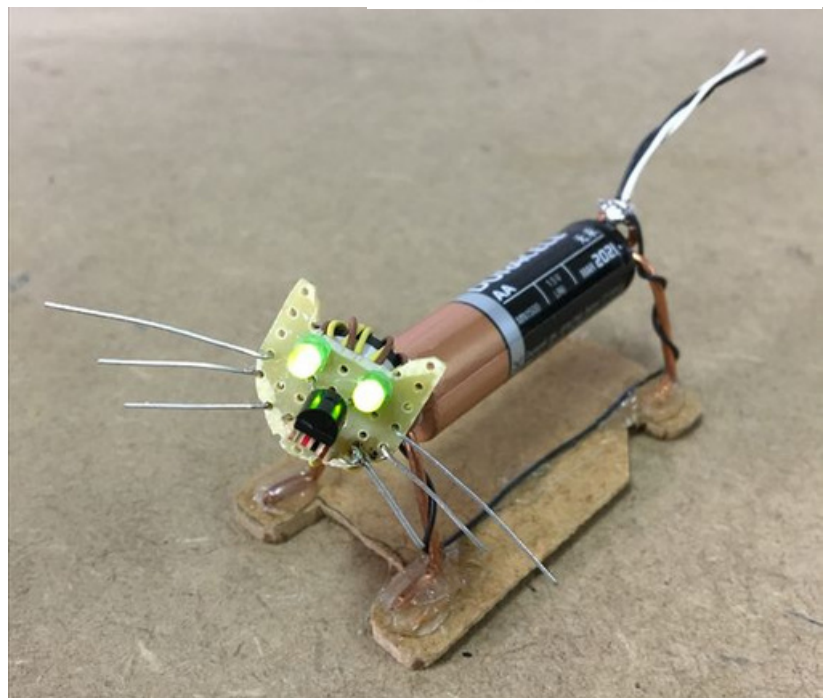

DŘEVONÁPADY

DŘEVÁK

inspirace pro tvorbu

ZAČÁTEČNÍCI

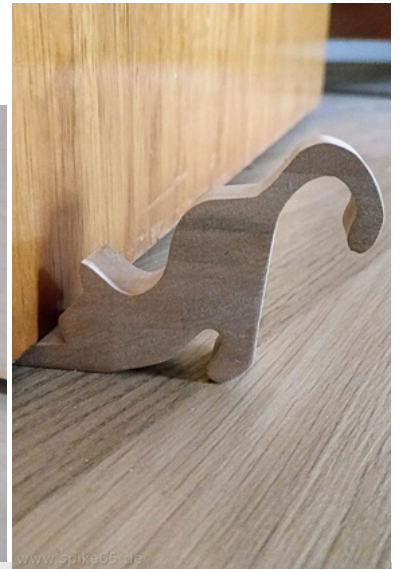

DŘEVONÁPADY

DŘEVÁK

inspirace pro tvorbu

ZAČÁTEČNÍCI



DŘEVONÁPADY

DŘEVÁK

inspirace pro tvorbu

ZAČÁTEČNÍCI



ROBŮTČI ZE DŘEVA

inspirace pro tvorbu

DŘEVÁK

ZAČÁTEČNÍCI

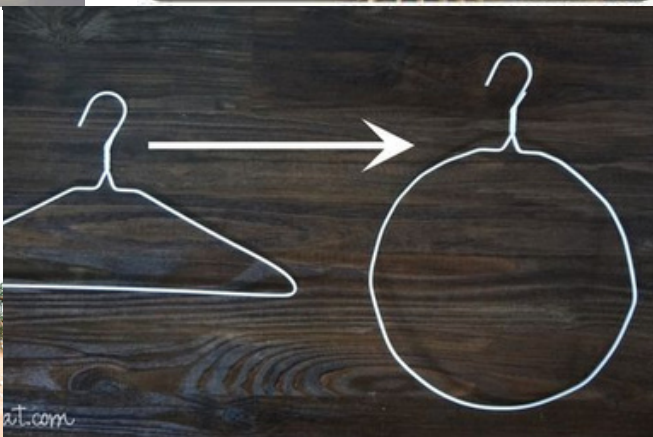

VÁNOČNÍ VÝROBKY

inspirace pro tvorbu

DŘEVÁK

ZAČÁTEČNÍCI



VÁNOČNÍ VÝROBKY

inspirace pro tvorbu

DŘEVÁK

ZAČÁTEČNÍCI



VÁNOČNÍ VÝROBKY

inspirace pro tvorbu

DŘEVÁK

ZAČÁTEČNÍCI



inspirace pro tvorbu **VÁNOČNÍ JÁ**



scrap wood
Christmas Village
video tutorial



Trois
fois
rien
★

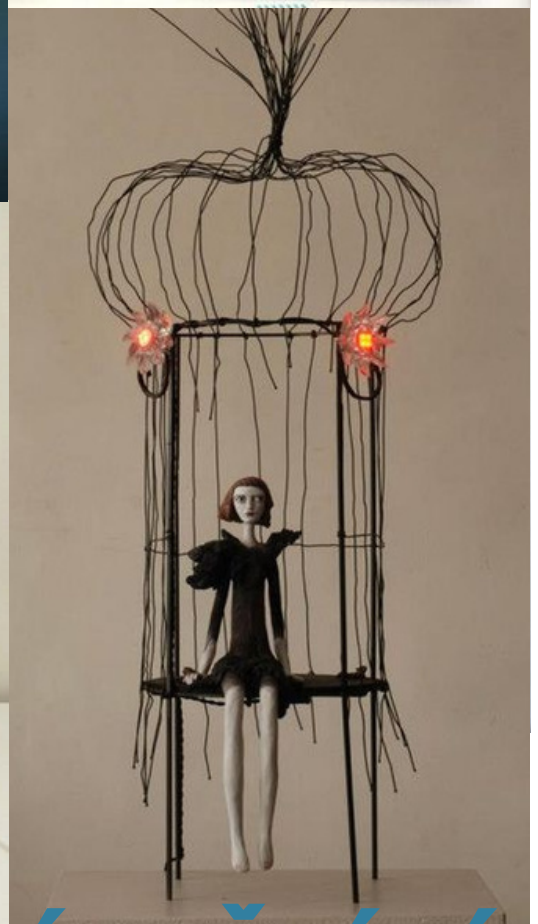

inspirace pro tvorbu **VÁNOČNÍ JÁ**



Trois
fois
rien
★



inspirace pro tvorbu **VÁNOČNÍ JÁ**



inspirace pro tvorbu

PRYSKYŘICE



inspirace pro tvorbu **MOTÝLEK** ze dřeva



inspirace pro tvorbu **SNÍDAŇOVÝ TÁČ** ze dřeva



inspirace pro tvorbu **SNÍDAŇOVÝ TÁČ** ze dřeva

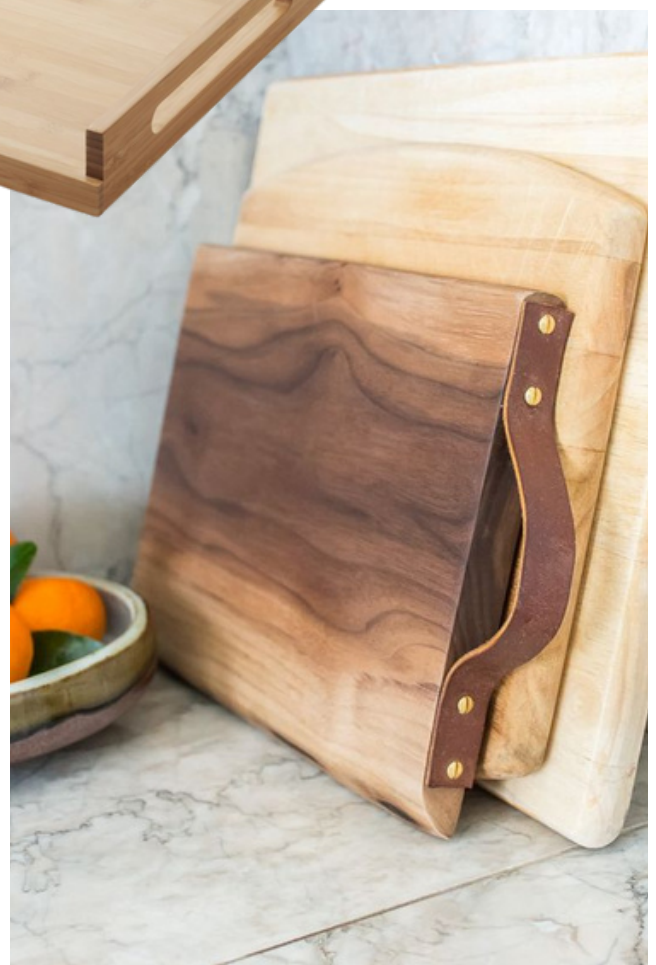

inspirace pro tvorbu **SNÍDAŇOVÝ TÁČ** ze dřeva



inspirace pro tvorbu

KRMÍTKO *pro ptáčky*



inspirace pro tvorbu

KRMÍTKO

pro ptáčky

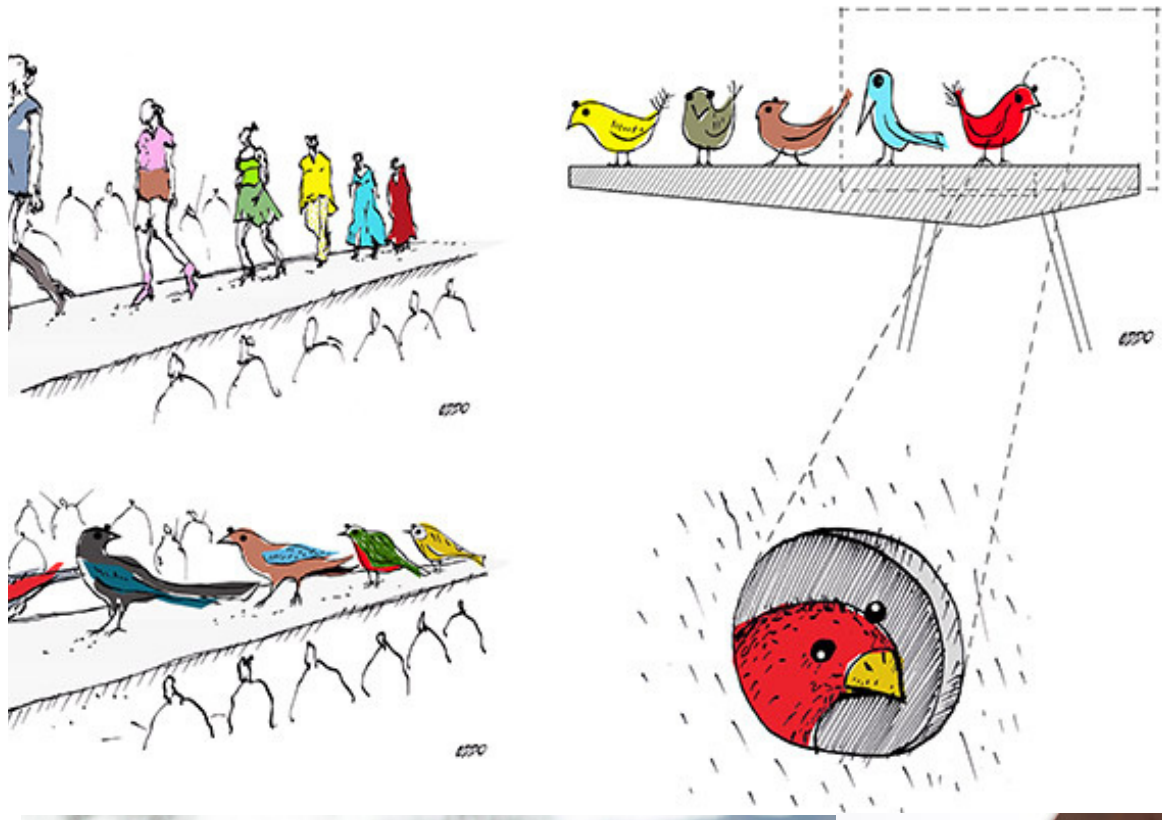

ODDO
architects



inspirace pro tvorbu

KRMÍTKO

pro ptáčky

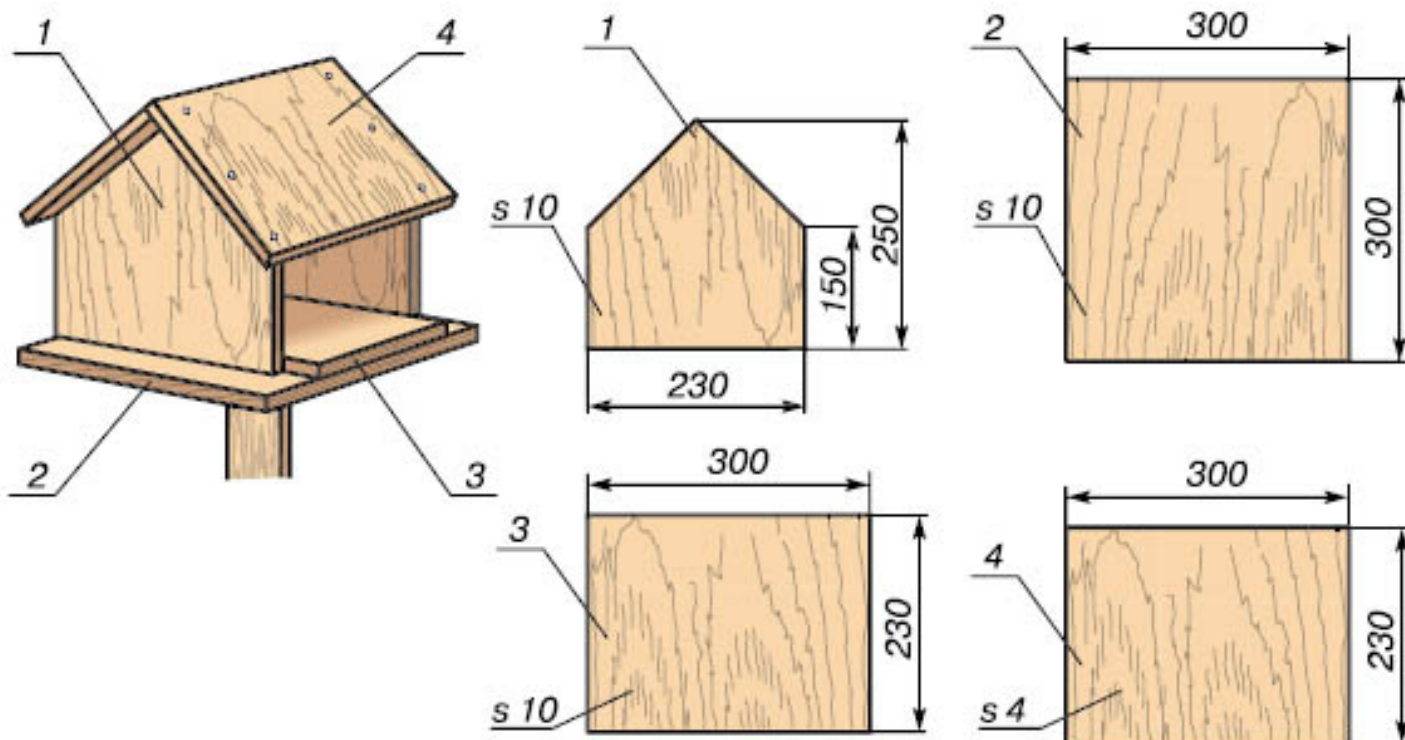

№		kusů	materiál	rozměr
1	boční stěna	2		250×230×10
2	spodní dno	1		300×300×10
3	dno	1		300×230×10
4	střecha	2		300×230×4

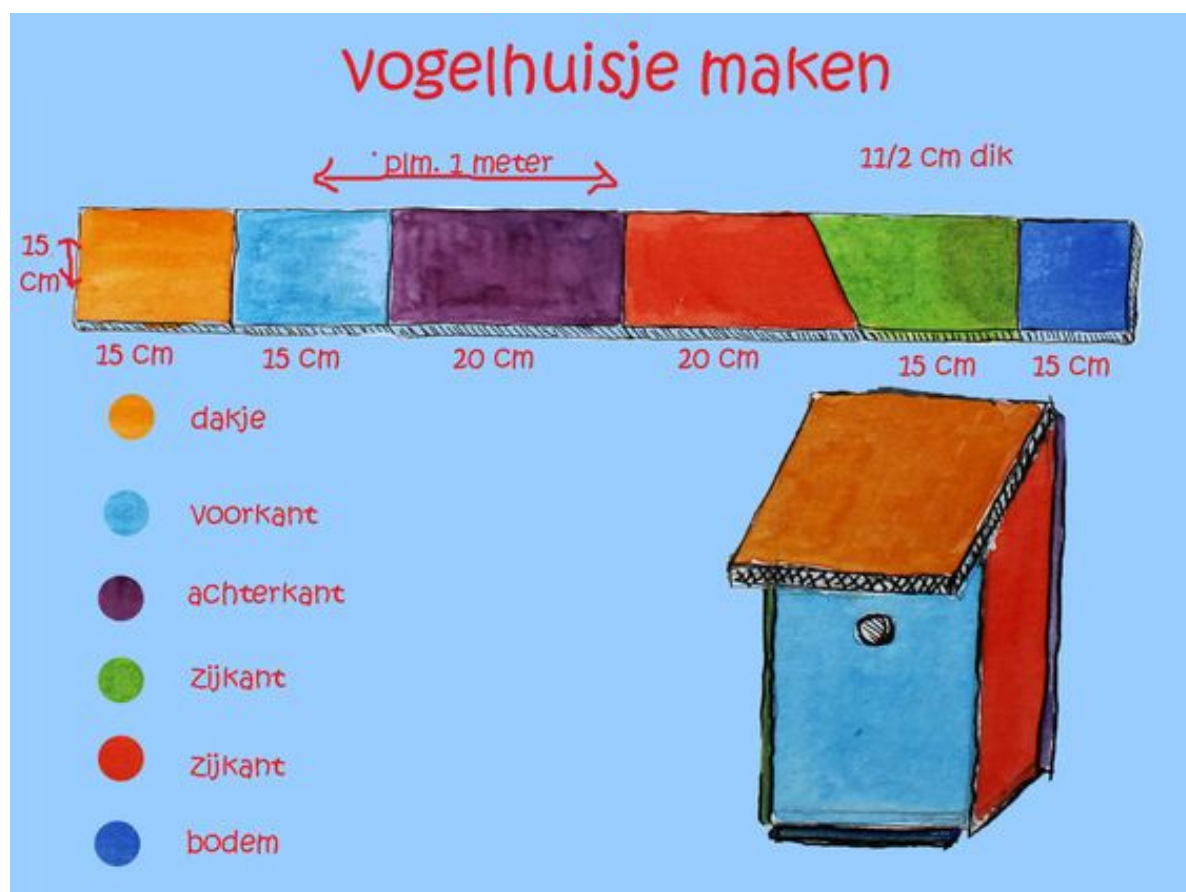

plán výroby

KRMÍTKO pro ptáčky

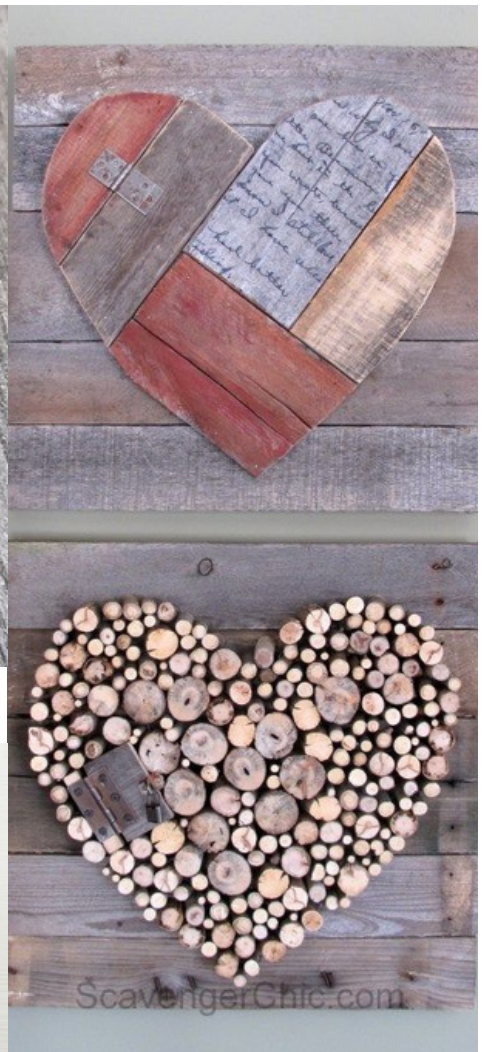

inspirace pro tvorbu

SRDCE

pro mamku

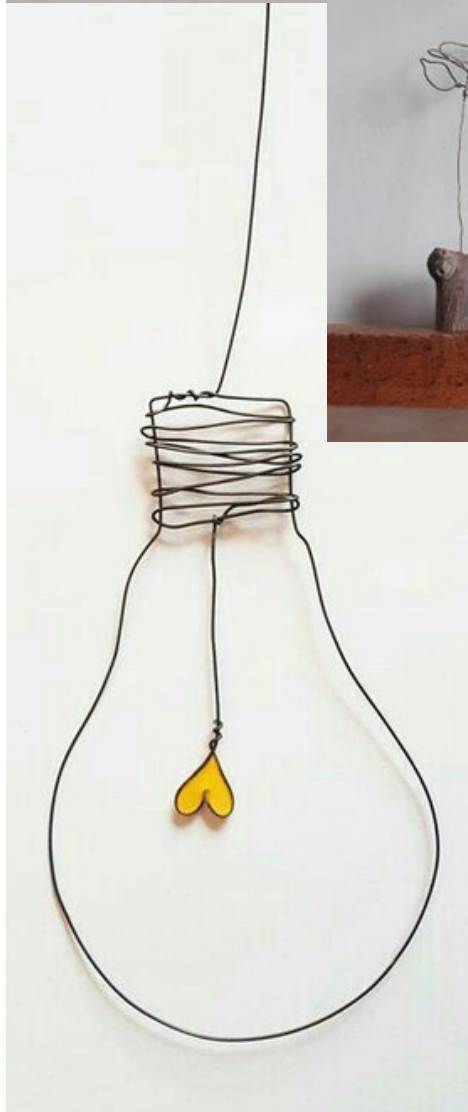

inspirace pro tvorbu

SRDCE

pro mamku

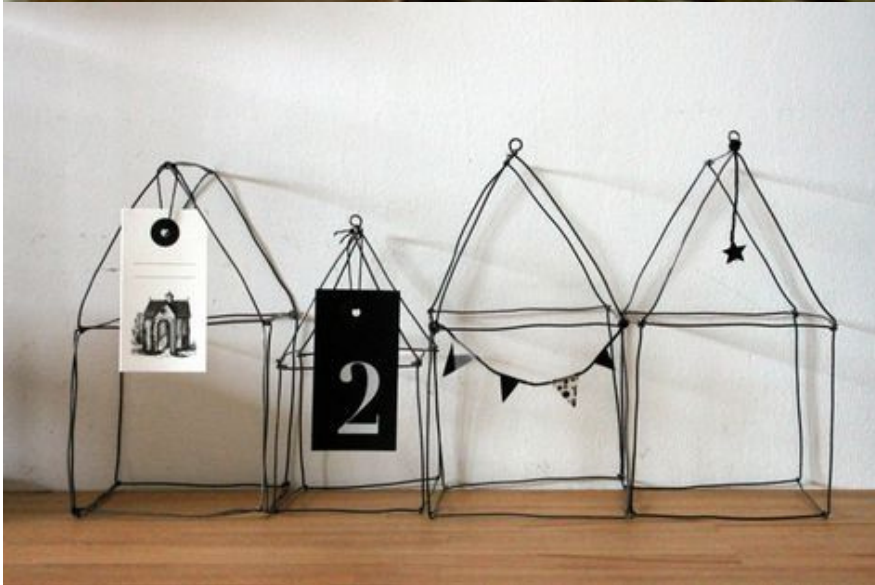
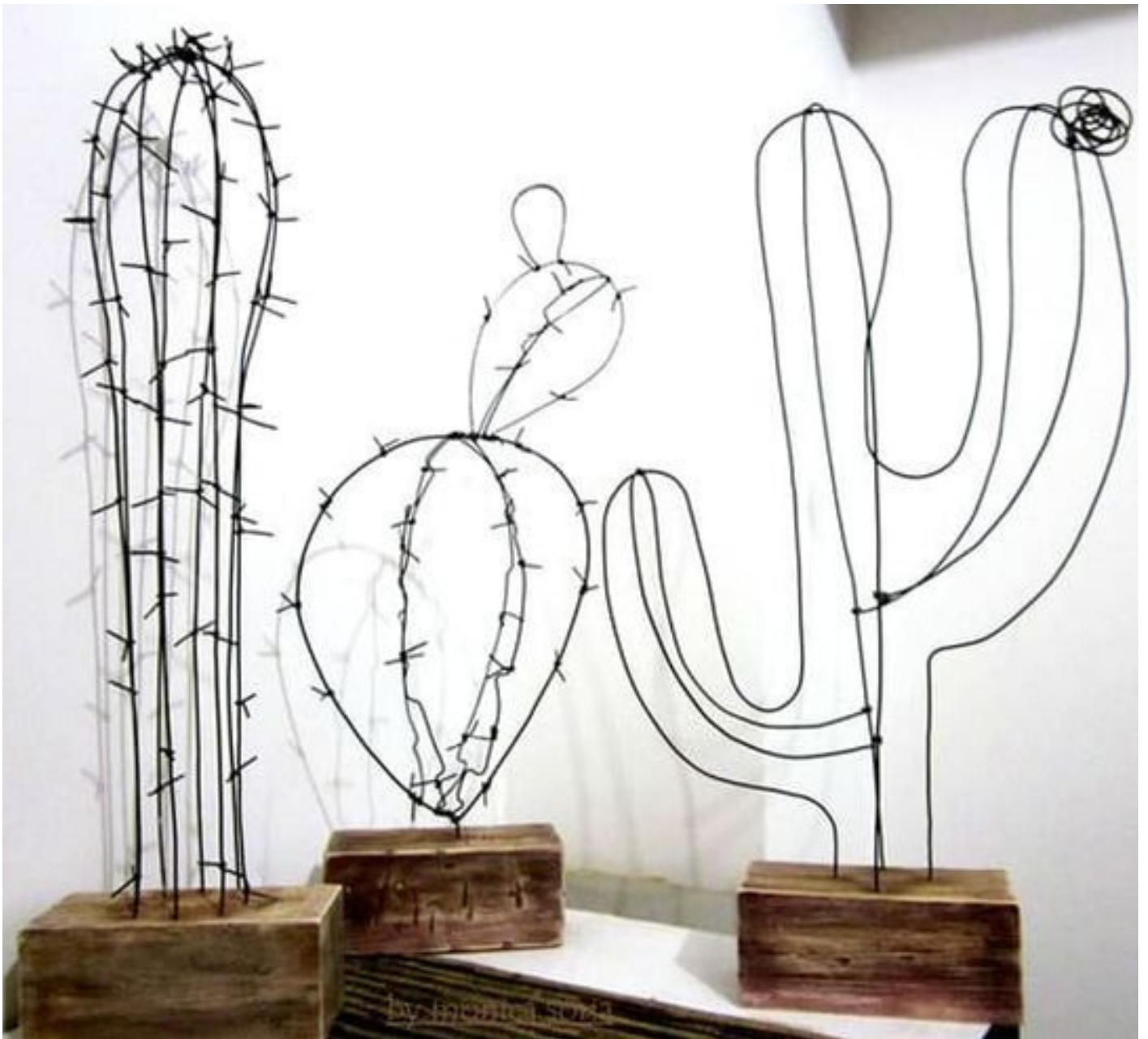

"at wire+"

inspirace pro tvorbu

SRDCE

pro mamku



inspirace pro tvorbu

PLYŠ



inspirace pro tvorbu

PLYŠ



inspirace pro tvorbu

PLYŠ

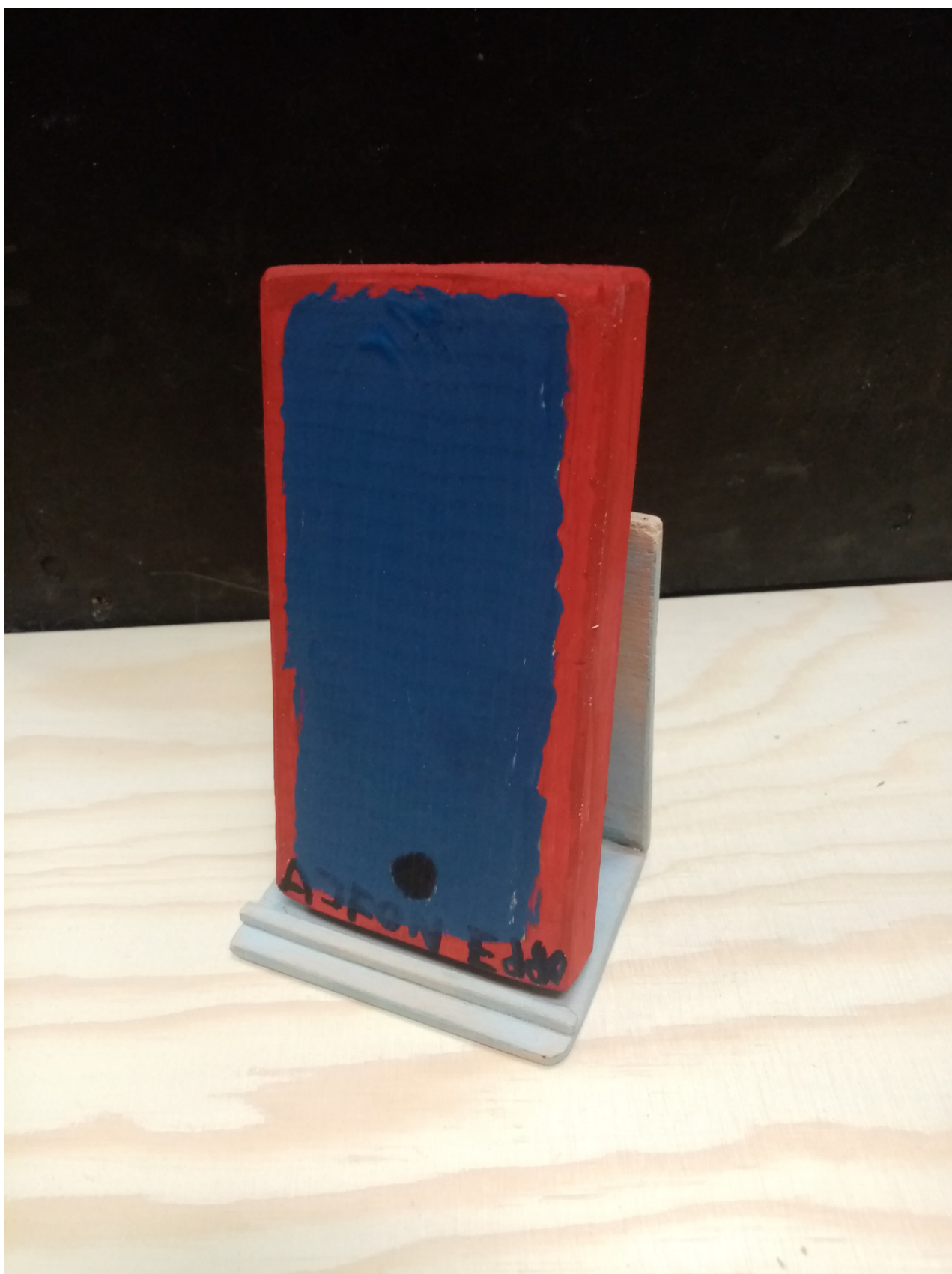

AJFON ZE DŘEVA

DŘEVÁK

ZAČÁTEČNÍCI



SRDCE ZE DŘEVA

DŘEVÁK

ZAČÁTEČNÍCI