

Medicinal Chemistry II

	◀07:00 1. 08:00▶	◀08:00 2. 09:00▶	◀09:00 3. 10:00▶	◀10:00 4. 11:00▶	◀11:00 5. 12:00▶	◀12:00 6. 13:00▶	◀13:00 7. 14:00▶	◀14:00 8. 15:00▶	◀15:00 9. 16:00▶	◀16:00 10. 17:00▶	◀17:00 11. 18:00▶	◀18:00 12. 19:00▶	◀19:00 13. 20:00▶	◀20:00 14. 21:00▶	◀21:00 15. 22:00▶
Mon		◀8:15 44-37 17.9.12 - 10.12.12 Farsa													
Tues															
Wed															
Thurs						◀13:00				44-342 Sudý 20.9.12 - 13.12.12 Farsa					20:30▶
Fri															
Sat															
Sun															

Key: Lecture Tutorial Seminar

Even Thursday 13.00 - 20.30

Dear students, let me invite you to an alternative extraordinary lecture in Medicinal Chemistry devoted to the topics

1. Antibacterial agents

2. Antihistamines

The lecture will be held by Dr. Zeynep Ateş-Alagöz from the Department of Pharmaceutical Chemistry, Faculty of Pharmacy, Ankara University, Turkey, who will be here at the Erasmus teaching staff mobility programme.

The lecture will take place September 24th from 10.30 a.m. at the 44-37 seminary room.

Assoc. Prof. PharmDr. Oldřich Farsa, PhD., Dept. of Chem. Drugs

Antibacterial chemotherapeutics

= compounds used for treatment of bacterial infections

Part 1

1. Antibacterial sulfonamides

2. Nitrofuranes

3. Quinolones

4. Tetracyclins

chapters 1.-3. contain.: chemotherapeutics in „narrower word meaning“, i.e. fully synthetic compounds

Sulfonamides

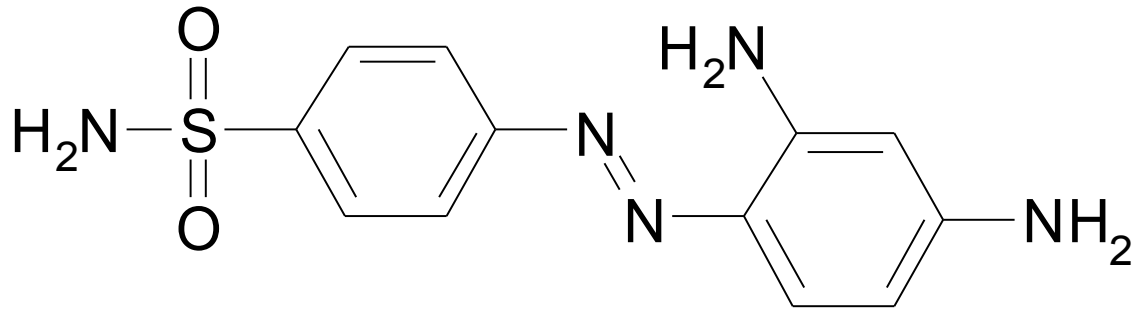

4-(2,4-diaminofenylazo)benzenesulfonamid

Prontosil rubrum

- 1932 Mietsch & Klarer - synthesis
Gerhard Domagk - successful tests on activity against *Streptococci*
- 1935 Jacques & Thérèse Tréfoulé: sulfanilamide is the proper active compound

Sulfonamides

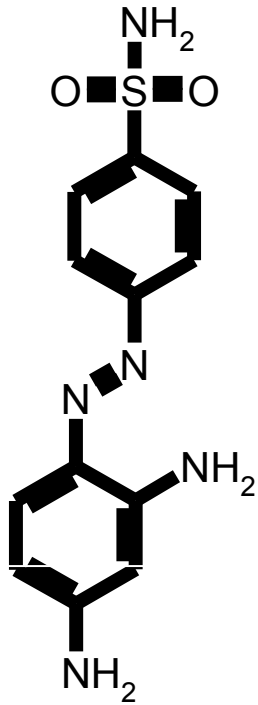

reduction
by bacteria

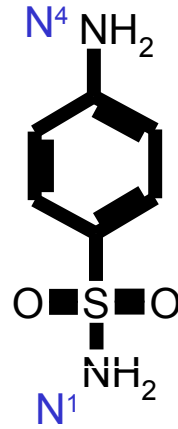

4-aminobenzensulfonamide
sulfanilamide

+

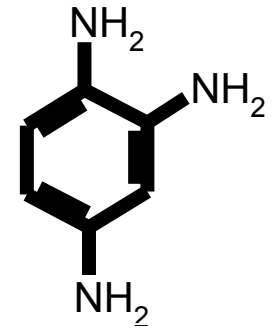

1,2,4-triaminobenzene

4-(2,4-diaminophenylazo)benzenesulfonamide **proper active compound**

Prontosil rubrum

(Prontosil album)

Sulfonamides

Structure-activity relationships (SAR)

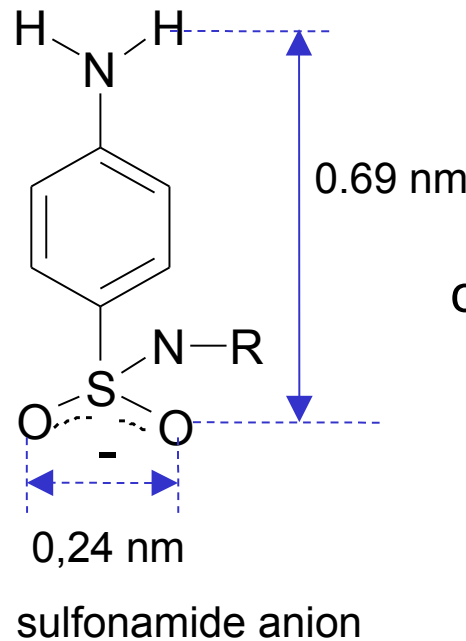
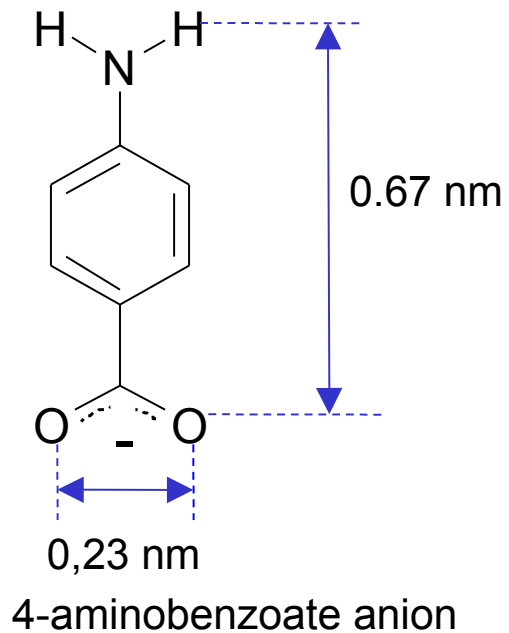

steric (spatial) similarity ↗
competition for a binding site

Sulfonamides

Mechanism of action

Scheme of synthesis of tetrahydrofolic acid in bacteria

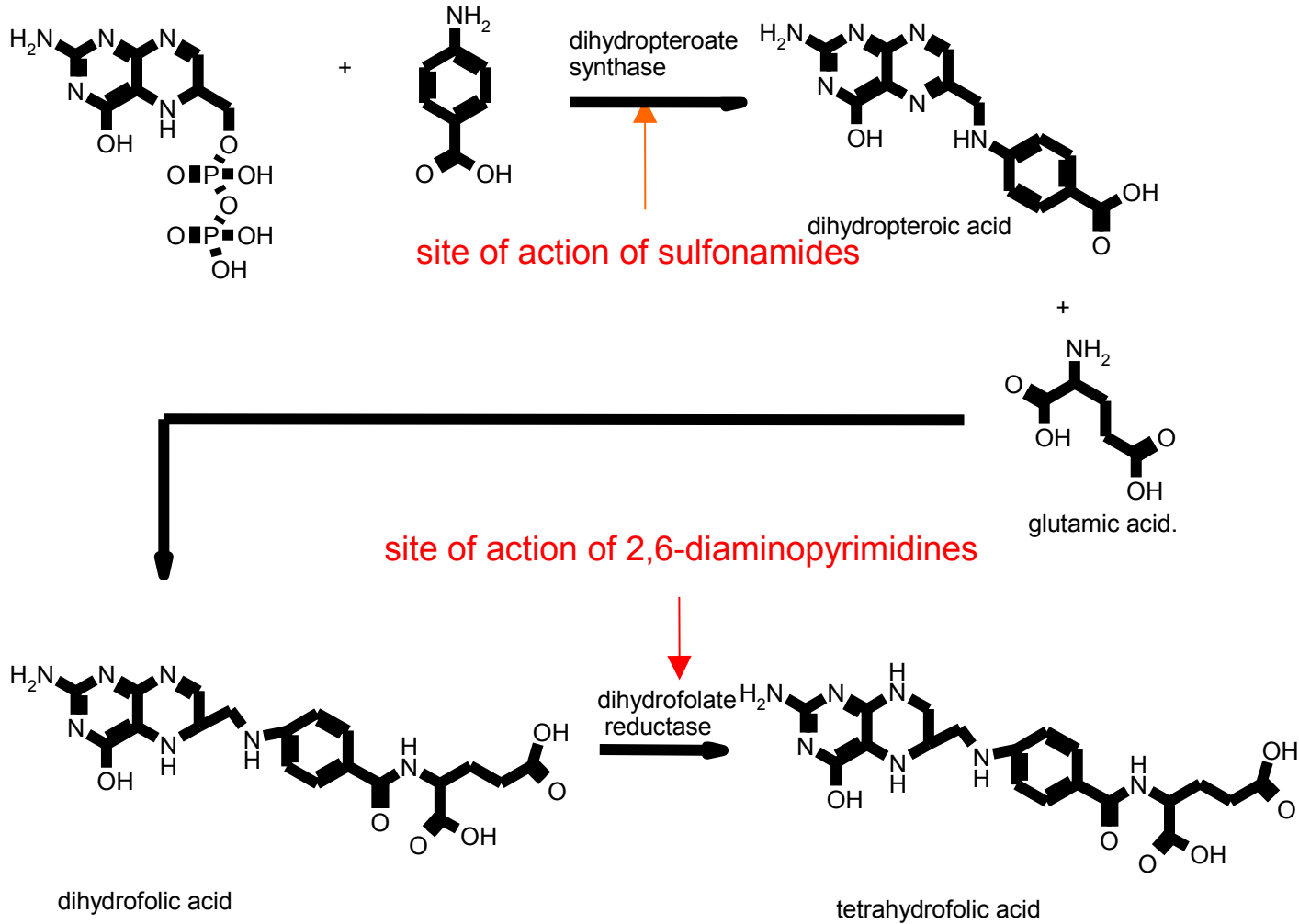

Sulfonamides

- effect is **bacteriostatic**, only in combination with 2,6-diaminopyrimidines (trimetoprim) **bactericidal**

Spectrum of effect:

broad, G⁺ as well as G⁻

Sulfonamides

the most of used compounds are sulfonamides substituted with a nitrogenous heterocycle on N¹

Overview of structures of commonly used compounds

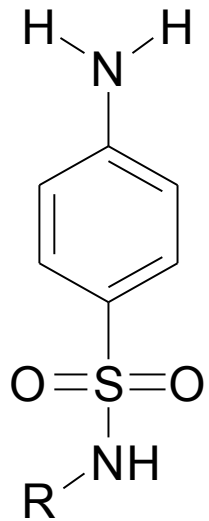

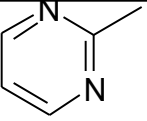
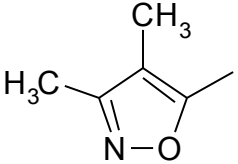
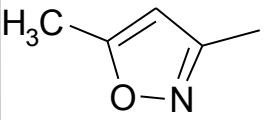
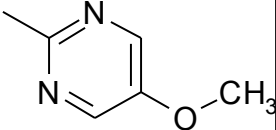
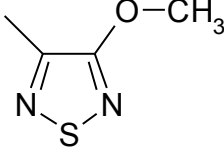
R	INN name/official name	Notice	Preparation authorized in the CR
	sulfadiazine <i>Sulfadiazinum</i> <i>PhEur</i>	a.u.v.	Norodine [®] 24 a.u.v. inj.
	sulfafurazol (syn. sulfizoxazole [USAN])		Sulfisoxazol [®] tbl.
	sulfamethoxazole	in combination with trimetoprim - cotrimoxazol	Biseptol [®] , Co- trimoxazol AL [®] ...
	sulfamethoxydiazine (syn. sulfameter [USAN])	also leprostatic	
	sulfametrole	in combination with trimetoprim - lidaprim	

Sulfonamides

Overview of structures of commonly used compounds - continued

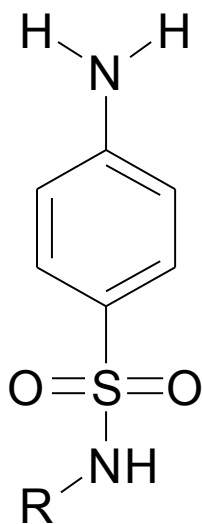

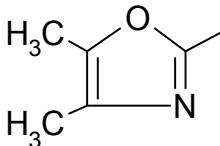
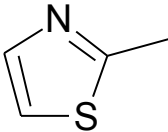
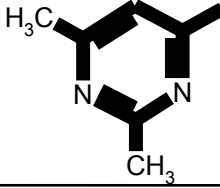
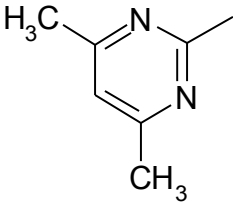
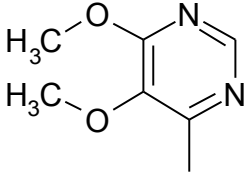
R	INN name/official name	Notice	Preparation authorized in the CR
	sulfamoxole	in combination with trimethoprim - supristol	
	sulfathiazole <i>Sulfathiazolum</i> <i>PhEur</i>		Sulfathiazol Neo [®] ung. Argosulfan [®] 2% (Ag salt)
	sulfisomidine		Aristamid [®] gel
	sulfadimidine <i>Sulfadimidinum</i> <i>PhEur</i>	a.u.v. treatment of coccidiosis	Sulfadimidin Bioveta [®] a.u.v. plv. sol.
	sulfadoxine <i>Sulfadoxinum</i> <i>PhEur</i>		.

Sulfonamides

Overview of structures of commonly used
compounds - continued

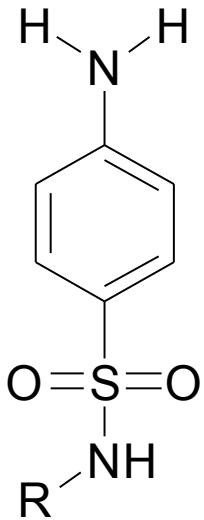

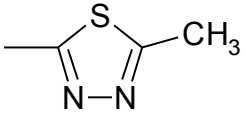
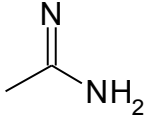
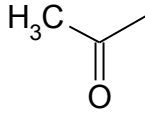
R	INN name/official name	Notice	Preparation authorized in the CR
	sulfamethizole <i>Sulfamethizolum</i> <i>PhEur</i>		
	sulfaguanidine <i>Sulfaguanidinum</i> <i>PhEur</i>	a.u.v.	
	sulfacetamide <i>Sulfacetamidum</i> <i>natricum</i> <i>monohydricum</i> <i>PhEur</i>		

Sulfonamides Combinations

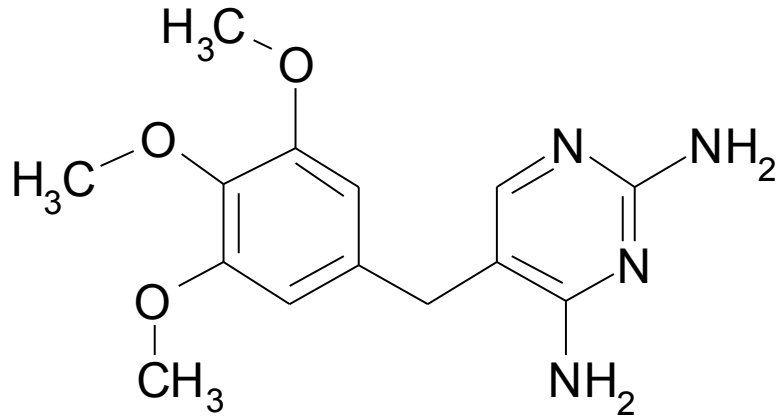

trimethoprim

- originally antimalaric

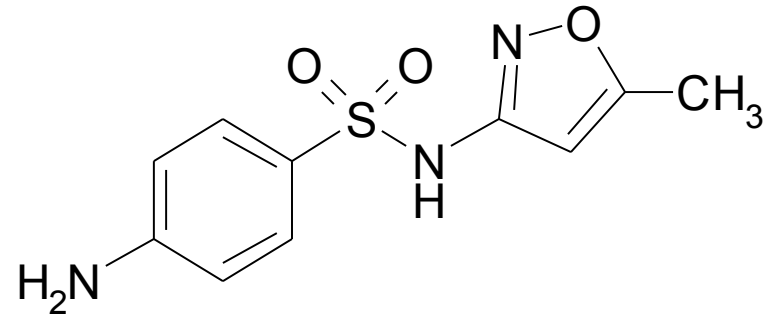

sulfamethoxazole

Cotrimoxazol (co-trimoxazol)

- baktericidal effect
- used since early 1970th

Sulfonamides Combinations

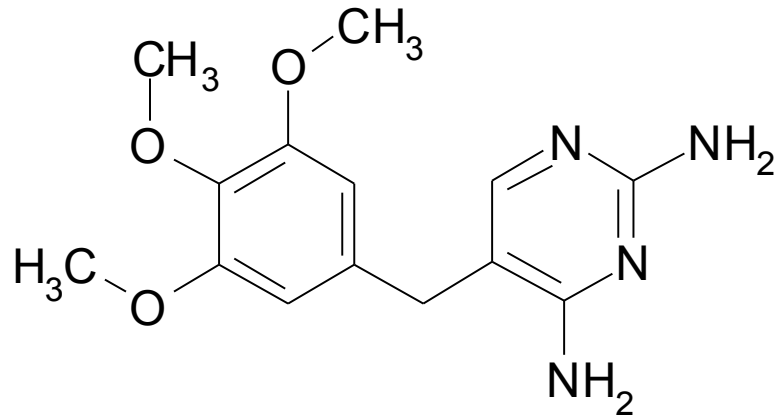

trimethoprim

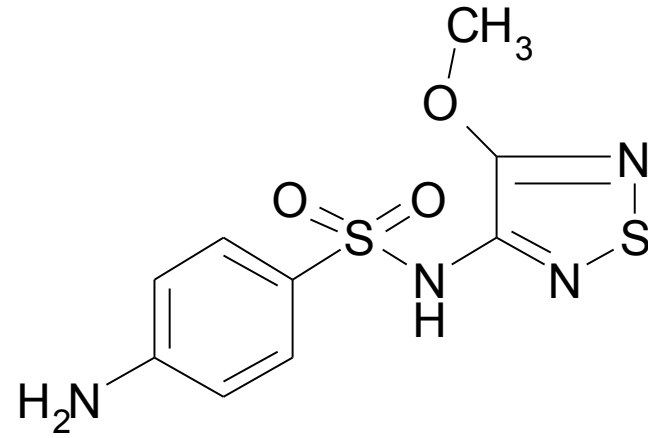

sulfametrole

lidaprim

Sulfonamides Combinations

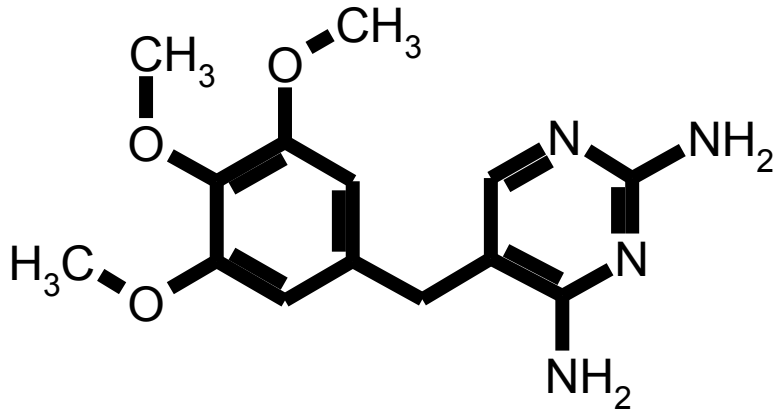

trimethoprim

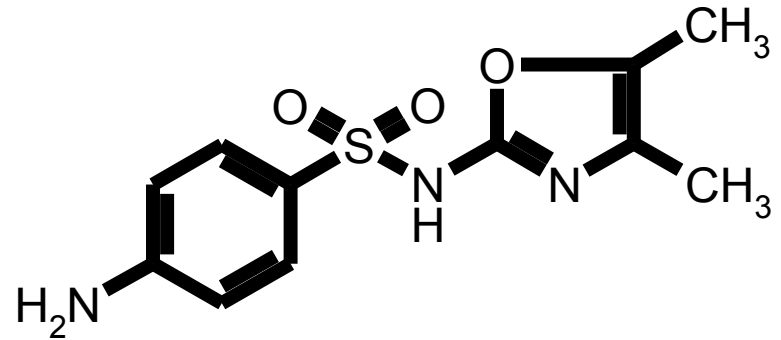

sulfamoxole

supristol

Sulfonamides

Chemical properties

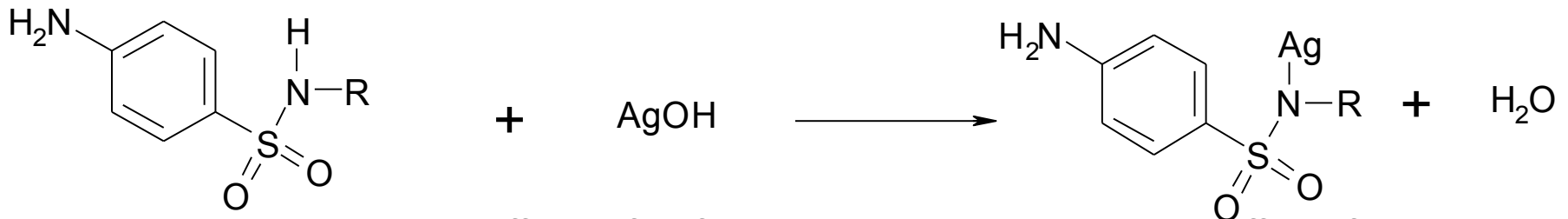
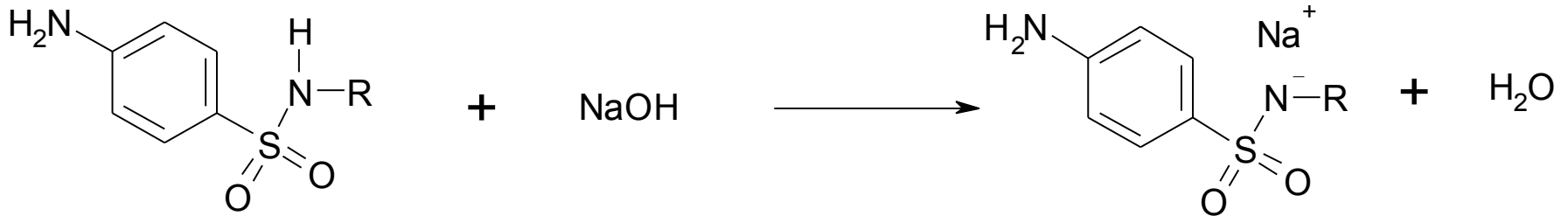
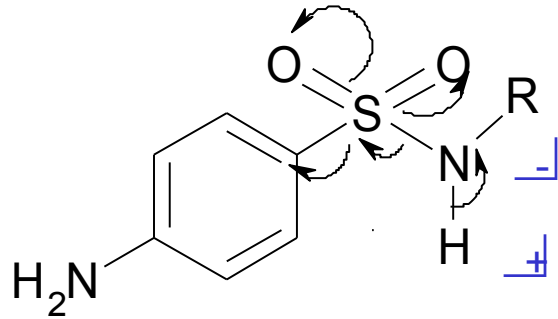

· **H on N¹** is due to M^- and I^- effects of sulfonamide moiety together with I^- effect of arom. ring relatively strongly **acidic** \nearrow forming of salts with bases; salts are used in topical preparations (eye drops, ointments)

· **N⁴** is **very slightly basic** (aniline nitrogen), some **heterocycles** attached to N¹ are much **stronger bases** \nearrow forming of therapeutically useful salts with strong acids (hydrochlorides, idy, mesylates etc.).

Nitrofurans

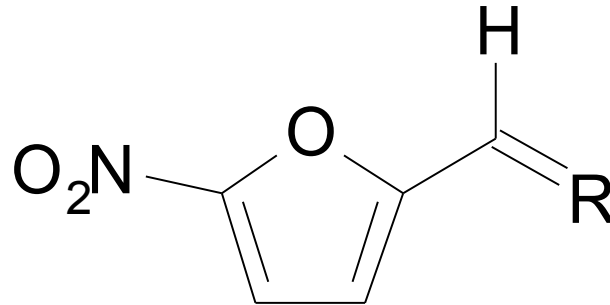

- 5-nitrofurancarbaldehyde derivatives, in most Schiff bases (azomethines)
- -NO₂ moiety in position 5 is necessary for their effect
- spectrum: both G⁺ and G⁻ bacteria, some protozoa (*Trichomonas vaginalis*)
- infections of urinary tract, topically in infections of skin and genital tract
- mode of action: related to reduction of -NO₂ moiety to -NH₂ group by bacteria; 2 hypotheses:
 - either formed amino compound reacts with bacterial DNA by electrophilic mechanism
 - or it is bound to ribosomes and obstruct proteosynthesis
- mutagenic, contraindication in the 1st trimester of gravidity (relative exception: nifuratel)

Nitrofurans

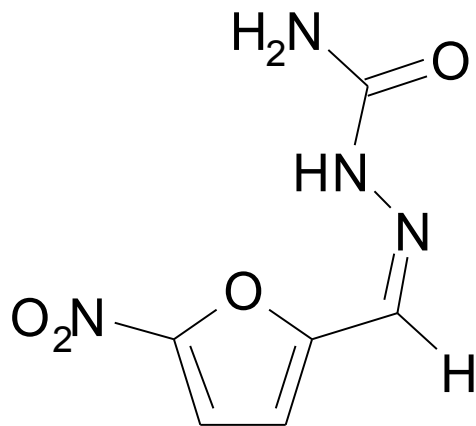

5-nitro-2-furancarbaldehyde semicarbazone
nitrofur
syn. nitrofurazone [USP, BAN]

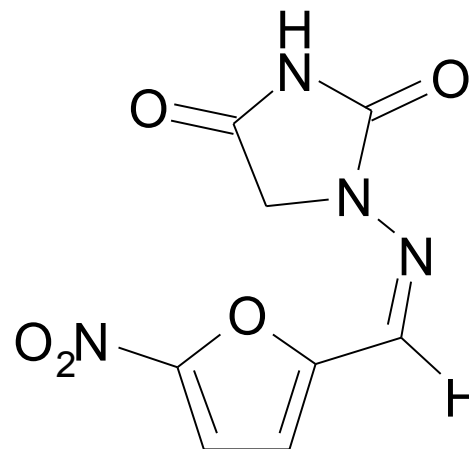

1-[(5-nitrofurfurylidene)amino]hydantoin
nitrofurantoin
Furantoin[®]
Urofur[®] forte/mite a.u.v.

Nitrofurans

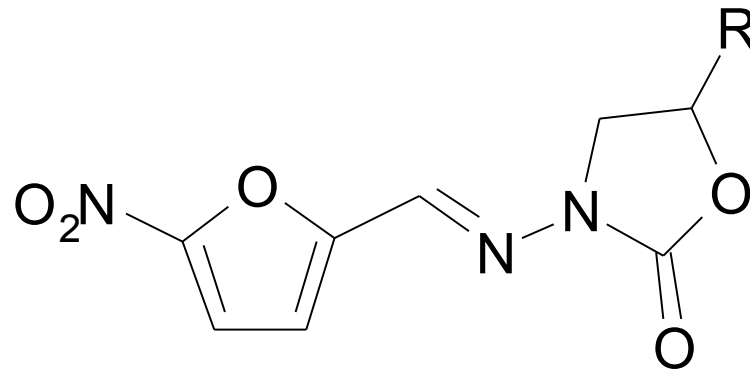

R = H- **furazolidone**

R = CH₃SCH₂-

nifuratel

Macmiror → tbl., Macmiror complex →
ung., sup. vag. (+ nystatin)

Nitrofurans: physical & chemical properties

- double bonds of $-\text{NO}_2$ and azomethine $-\text{CH}=\text{N}-$ moieties are conjugated with the π electrons system of the furane ring \rightarrow chromophore \rightarrow yellow – orange crystalline compounds
- unstable at the light
- other properties depend on a particular structure

Example: nitrofurantoin

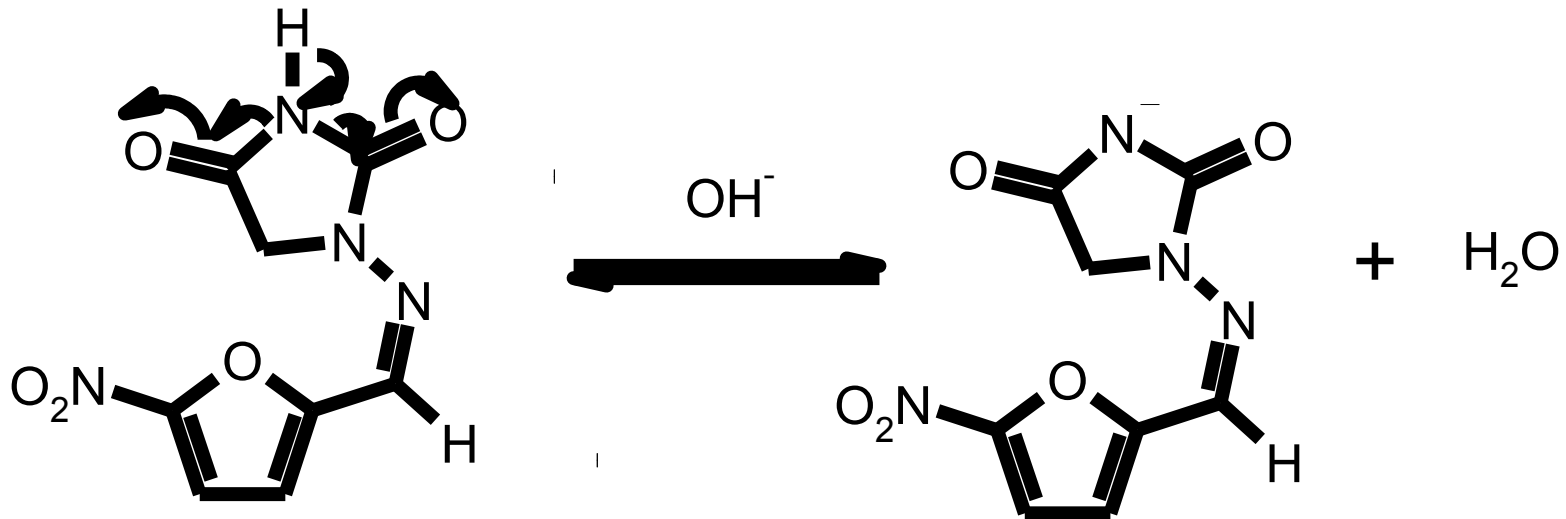

- like other hydantoines, nitrofurantoin is weakly acidic due to M^- effect of both imide carbonyls \rightarrow forming of salts with bases; $\text{pK}_a = 7.2$

Quinolones

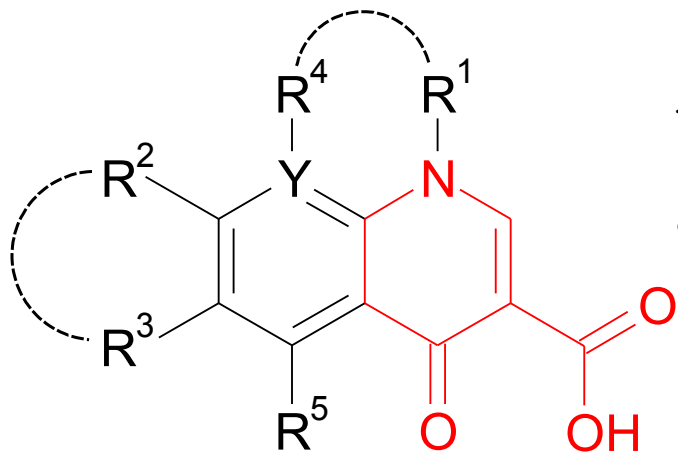

the fragment necessary for the effect:

1-alkyl-1,4-dihydro-4-oxopyridine-3-carboxylic acid

• it must be fused to an other ring (benzene, pyridine)

Y = -N= (1,8-naphthyridine derivatives) or -C= (quinoline derivatives)

R¹= alkyl, cykloalkyl, or a part of a heterocycle R¹+R⁴

R²= alkyl, saturated N-heterocycle, R¹ + R² can together form a heterocycle (dioxomethylene moiety)

R³= -H, halogen

R⁴ = -H, -F, or a part of a heterocycle R¹+ R⁴

R⁵ = -H, -NH₂

Quinolones

- mode of action:** interference with the replication of bacteria by inhibition of bacterial gyrase (topoisomerase II) and topoisomerase IV; both enzymes are essential for bacterial DNA replication
- bactericidal**, acts on both dividing and quiescent-state bacteria
- effect is inhibited by chloramphenicol: completely in the 1st generation, partially in fluoroquinolones

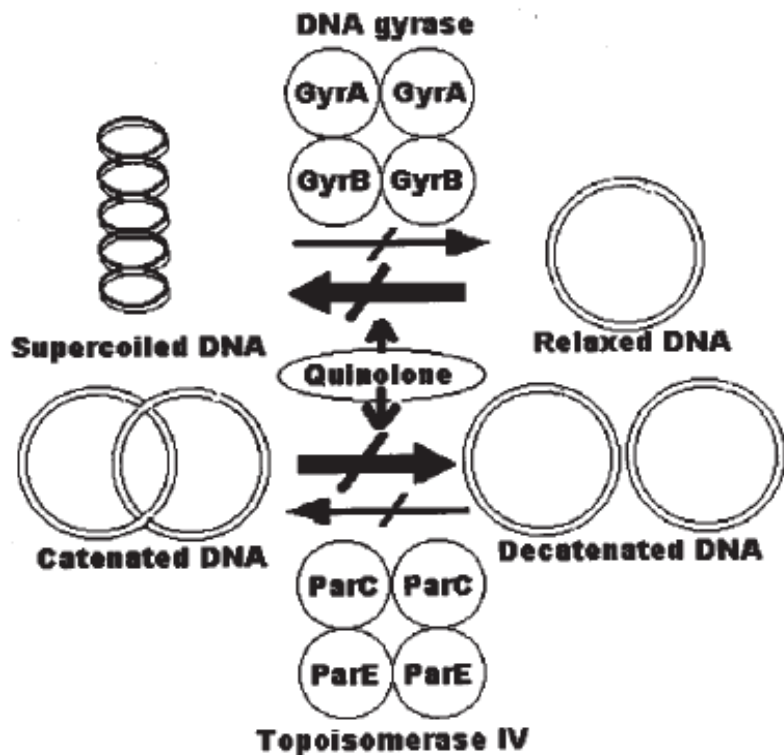

Major activities of DNA gyrase and topoisomerase IV. According to older hypotheses, quinolones simply block these activities by stabilizing a enzyme-DNA complex, which also functions as a barrier to the movement of other proteins such as DNA polymerase and RNA polymerase along the DNA.

Quinolones: more recent and detailed view to mechanism of action

(a) Gyrase or topoisomerase IV (circles), DNA (parallel lines), and quinolones (triangles) form a ternary complex. (b) Quinolones bind to GyrA and ParC subunits of gyrase and topoisomerase IV, respectively. At this stage the DNA is intact. (c) One DNA strand is broken, forming a cleaved complex. Inhibition of DNA synthesis at substaturing concentrations of quinolone correlates with single-strand chromosome breaks. (d) Second DNA strand is broken. Inhibition of DNA synthesis correlates with the activity (MIC). (e) Release of doublestrand DNA breaks from cleaved complex leads to cell death. Inhibition of protein synthesis by chloramphenicol (Cm) completely blocks the lethal action of first-generation quinolone inhibitors of gyrase (nalidixic acid, oxolinic acid). (f) Release of lethal double-stranded DNA breaks via subunit dissociation. Fluoroquinolone lethality is incompletely blocked by chloramphenicol, requiring a second lethal pathway. (g) Release of double-strand DNA breaks by cell lysis in the presence of sodium dodecyl sulfate (SDS); single-strand breaks are released if cells are lysed at step (c).

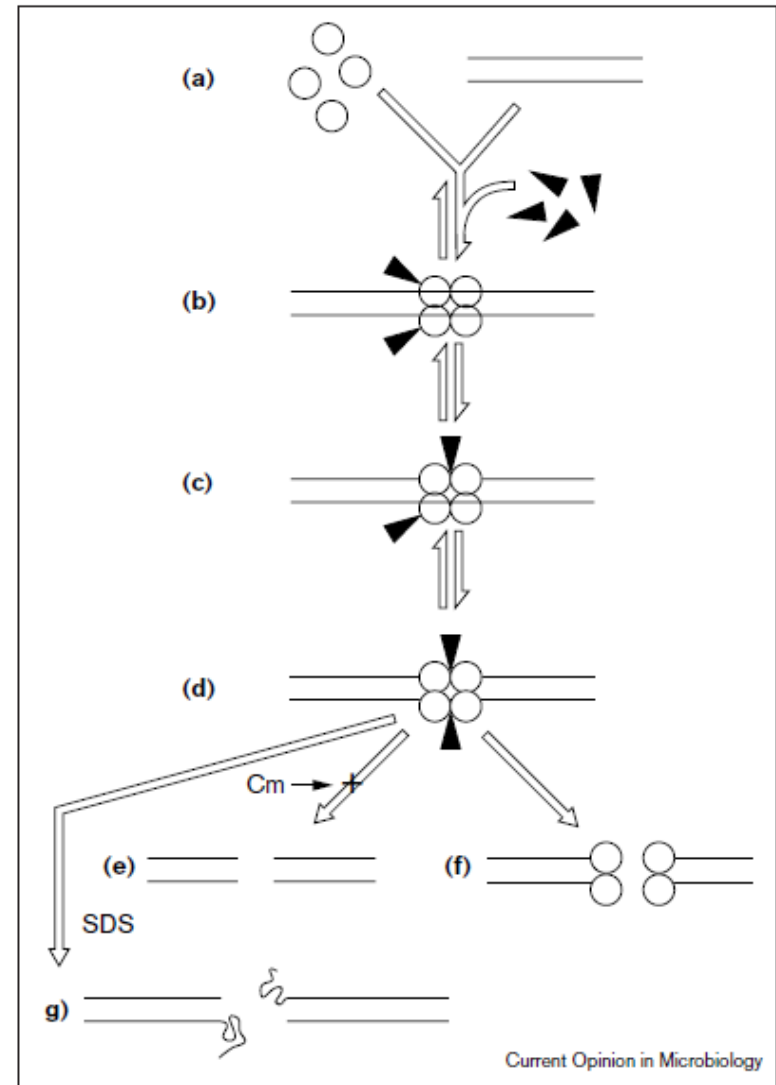

Quinolones

„1st generation“ – treatment of urinary tract infections

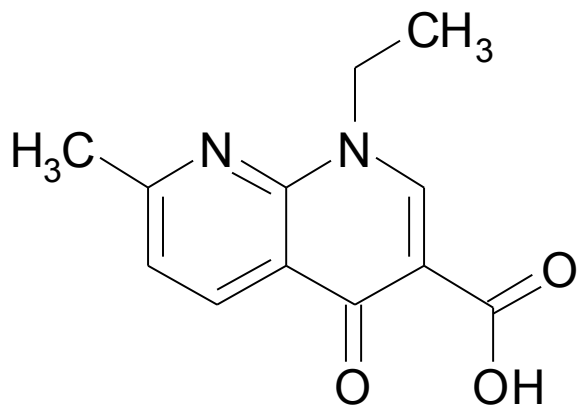

nalidixic acid

•mainly G⁻

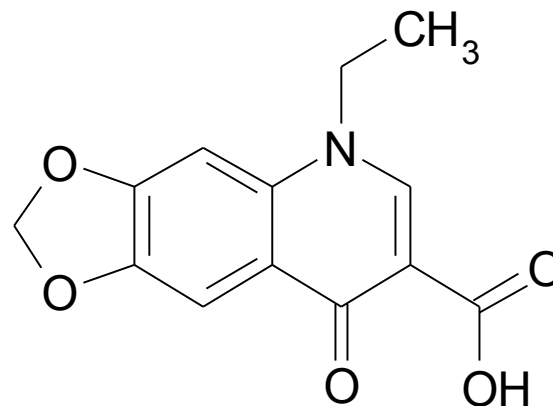

oxolinic acid

Desuro[®]

•mainly G⁻, *E. coli*, *Proteus*, *St. aureus*

Quinolones

„2nd - 4th generation“ – fluorinated derivatives

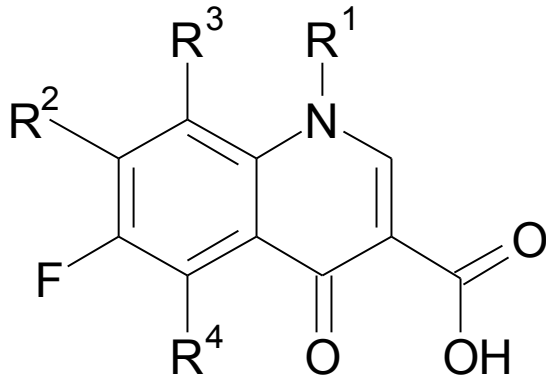

R¹ = cycloalkyl, alkyl, sec. aminogroup, or a part of a heterocycle R¹+R³

R² = saturated basic heterocycle attached through nitrogen

R³ = -H, -F, or a part of a heterocycle R¹+ R³

R⁴ = -H, -NH₂

- 6-fluoro-4-oxo-1,4-dihydroquinoline-3-carboxylic acids substituted in positions 1 and 7, less frequently also 8, exceptionally 5
- spectrum: broad, G⁺ i G⁻, e.g. *E. coli*, *Citrobacter*, *Klebsiella*, *Enterobacter*, *Yersinia*, *Serratia*, *Providencia*, *Vibrio*, *Pseudomonas aeruginosa*, *Proteus*, *Salmonella*, *Shigella*, *Legionela*...
- therapy of systhemic infections, urinary tract, eyes, GIT...

Quinolones

„2nd and 3rd generation“ – fluorinated derivatives

Overview of used compounds

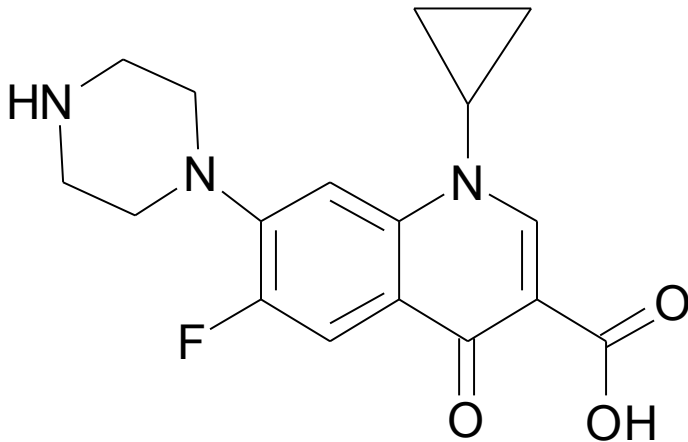

ciprofloxacin
Ciphin®

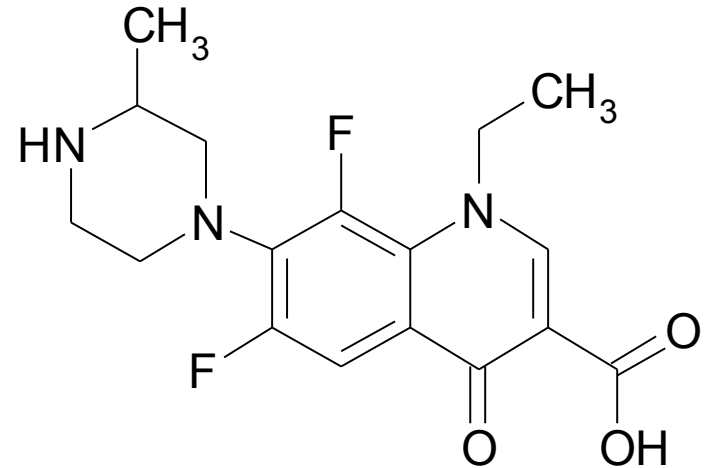

lomefloxacin
Maxaquin® tbl. obd.

- spectrum includes also some strains *M. tuberculosis*
- as bases or salts with acids

Quinolones

„2nd and 3rd generation“ – fluorinated derivatives

Overview of used compounds - continued

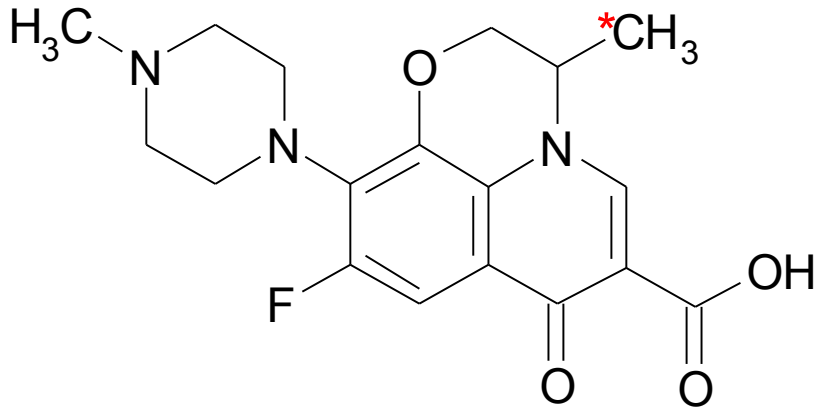

ofloxacin
-racemate
Ofloxin[®] tbl.

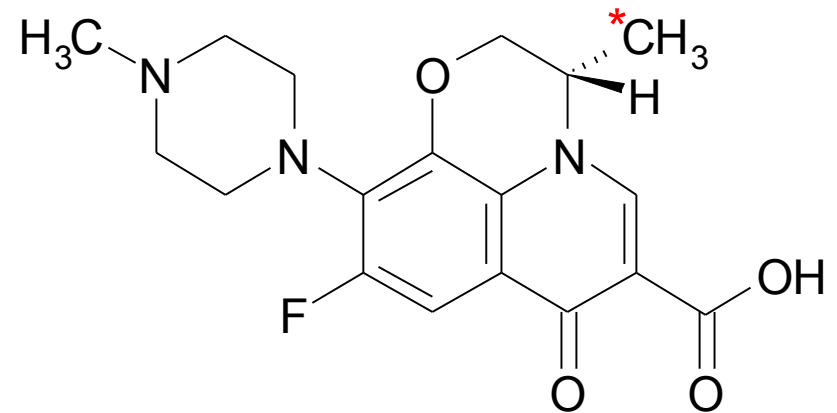

levofloxacin
- pure **S** – (-) -enantiomer
Tavanic[®] tbl. obd., inf. sol.

Quinolones

„2nd and 3rd generation“ – fluorinated derivatives

Overview of used compounds - continued

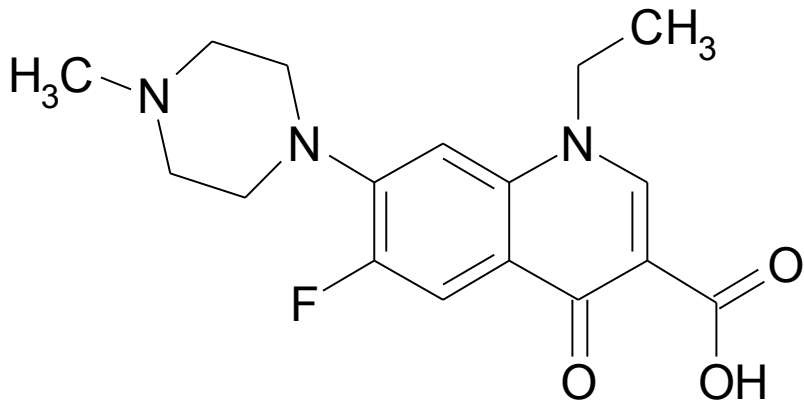

pefloxacin

Abaktal® tbl., inj.

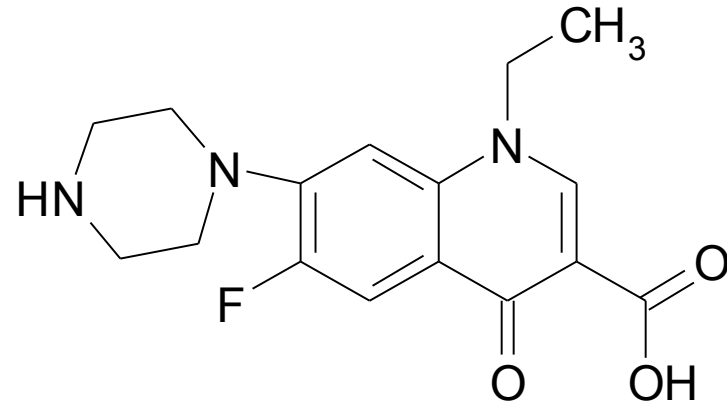

norfloxacin

Nolicin® tbl. obd.

Quinolones

„2nd and 3rd generation“ – fluorinated derivatives

Overview of used compounds - continued

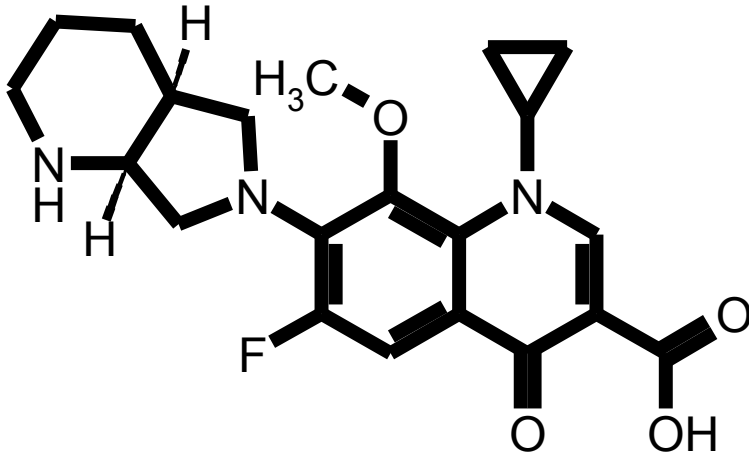

1-cyclopropyl-6-fluoro-8-methoxy-7-(octahydropyrrolo[3,4-b]pyridine-6-yl)-4-oxo-1,4-dihydroquinoline-3-carboxylic acid

moxifloxacin

Avelox[®] tbl. obd.

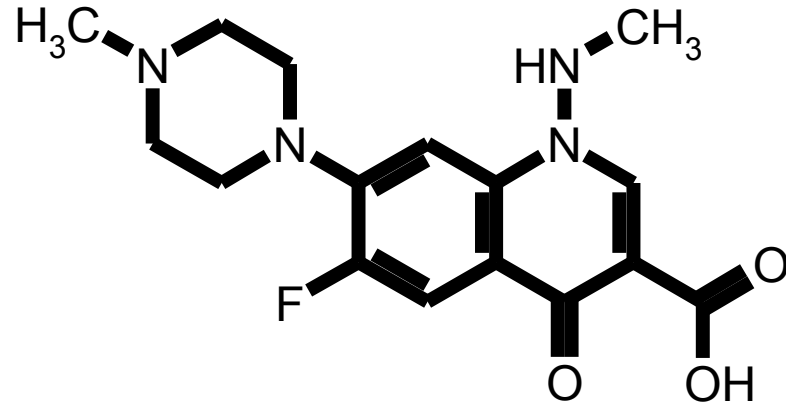

amifloxacin

Quinolones

„3rd and 4th generation“ – fluorinated derivatives

Overview of used compounds

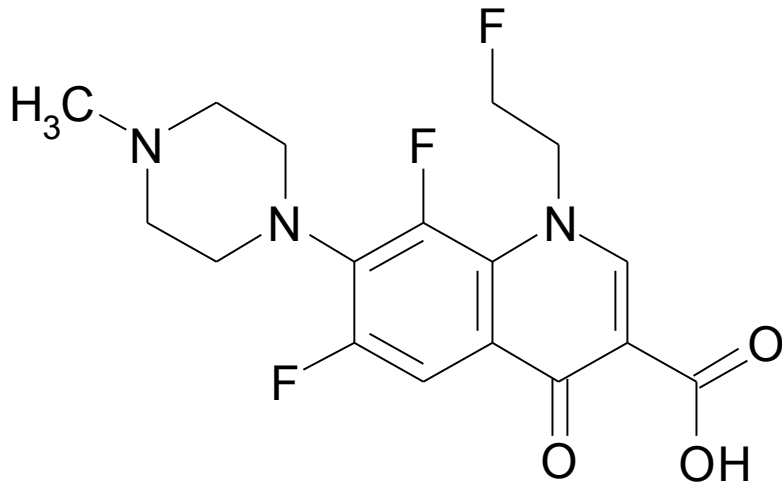

fleroxacin

3rd generation

Quinodis Roche® tbl. obd.

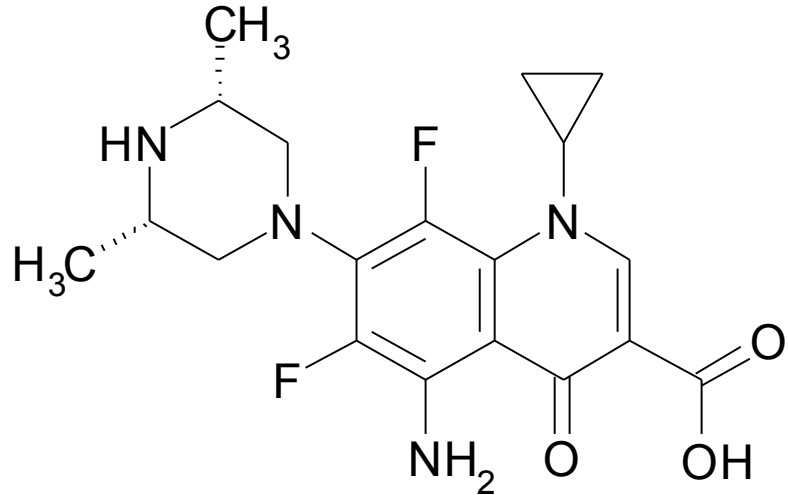

sparfloxacin

4th generation

Zagam® tbl. obd.

- also *Mycobacterium sp.*
- serious systemic infections

Tetracyclines

- „true“ antibiotics: initial compounds produced by microorganisms

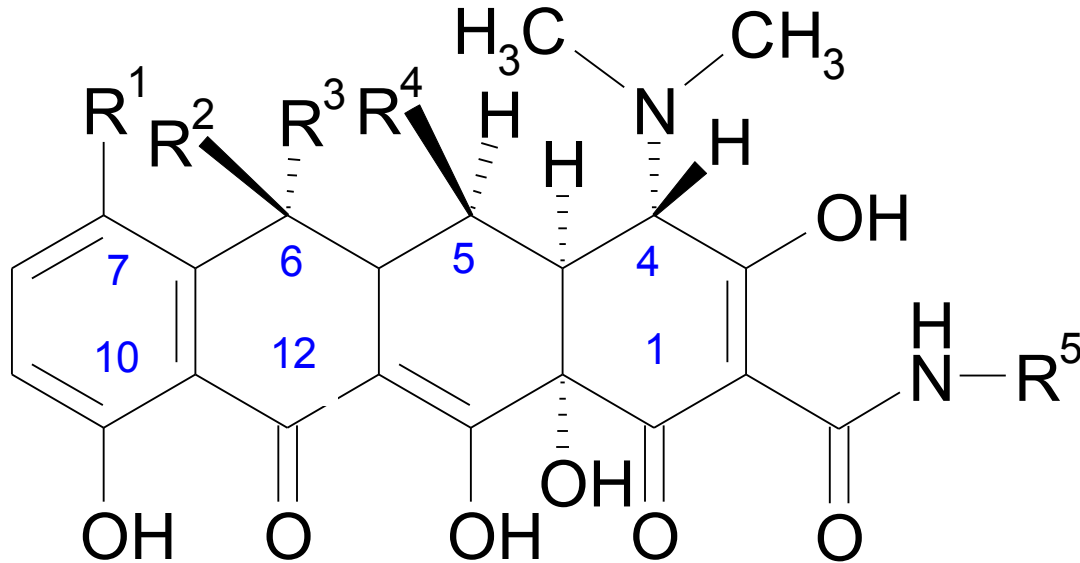

R¹ = -H, halogen, -NHCH₃

R² = -OH, -H

R³ = -CH₃, -H

R⁴ = -H, -OH

R⁵ = H, heterocyclic aminoalkyl, carboxyalkyl

Tetracyclines Mechanism of action

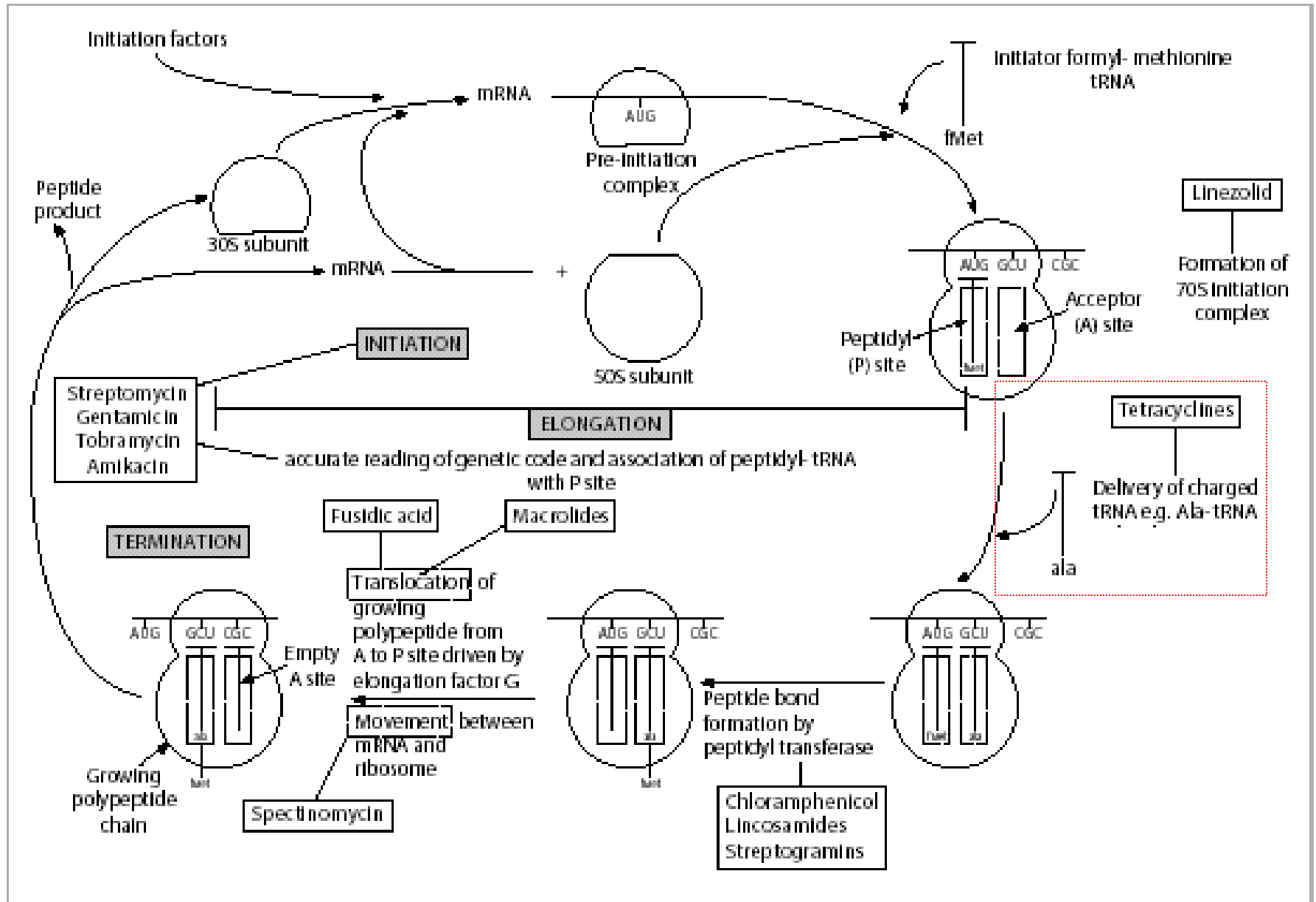

Tetracyclines

Mechanism of action

- inhibition of proteosynthesis: inhibit transfer of amino acids attached to tRNA („charged tRNA“) to acceptor site of mRNA
- effect **bacteriostatic** (exception: rolitetracycline)

Tetracyclines

Chemical properties

- ability to form coordination compounds bivalent (Ca^{2+} , Mg^{2+} , Cu^{2+} , Fe^{2+} , Zn^{2+} ...), trivalent (Fe^{3+} , Al^{3+} ...) and polyvalent cations
- complexes are water-soluble and non-absorbable ↗ salts of metals · effect of tetracyclines
- doxycycline has the lowest affinity to metal ions
- chelates form deposits in teeth and bones, namely growing ones ↗ relative contraindication in children

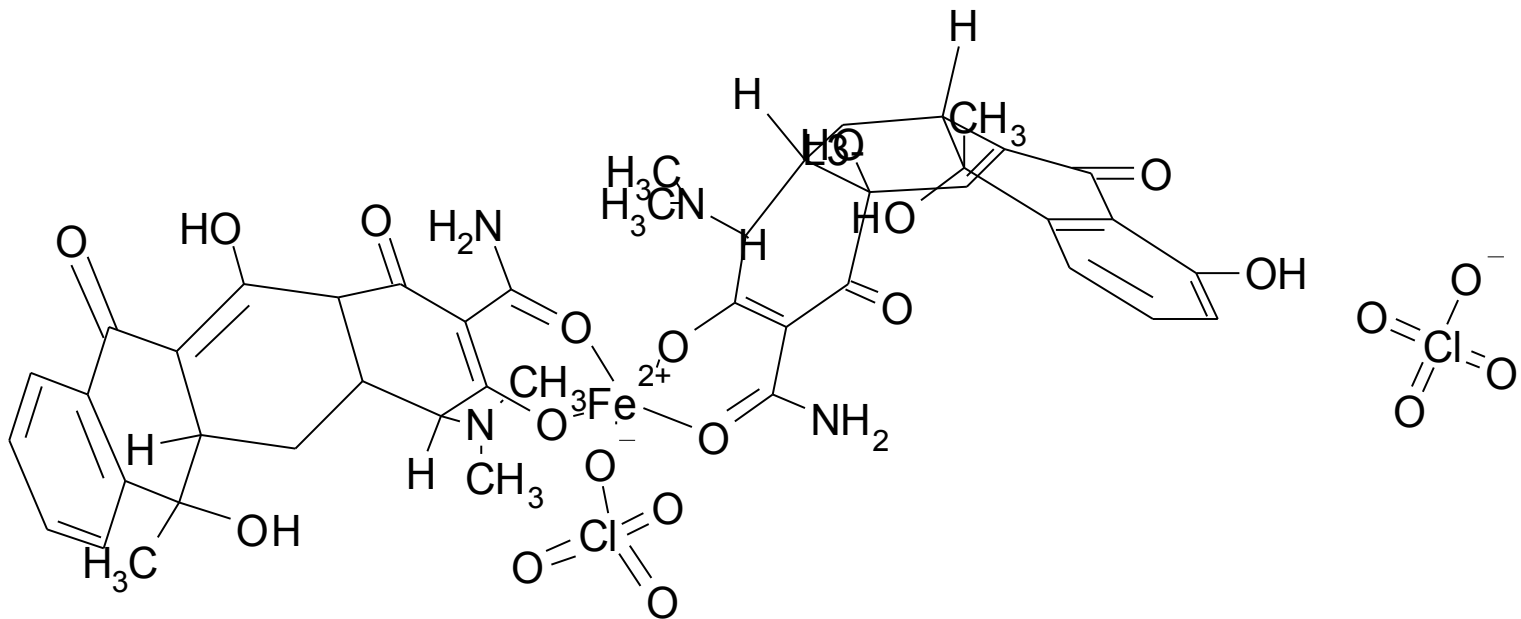

A complex of tetracycline with ferrous perchlorate

Tetracyclines

Chemical properties - continued

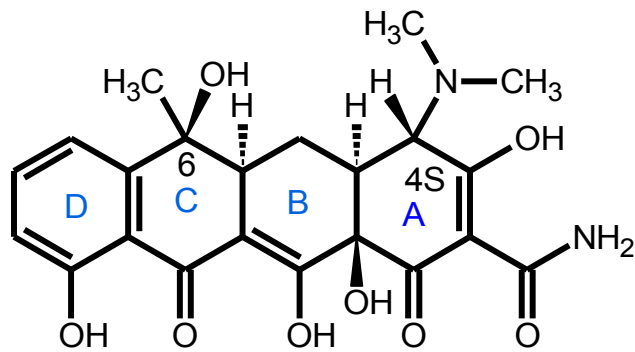

tetracycline

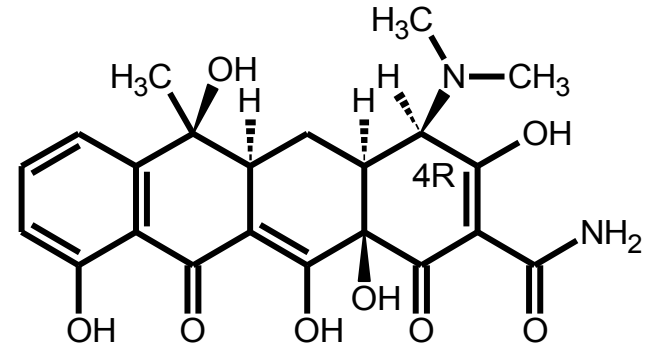
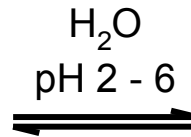

4-epitetracycline

< 10 % activity, nephrotoxic

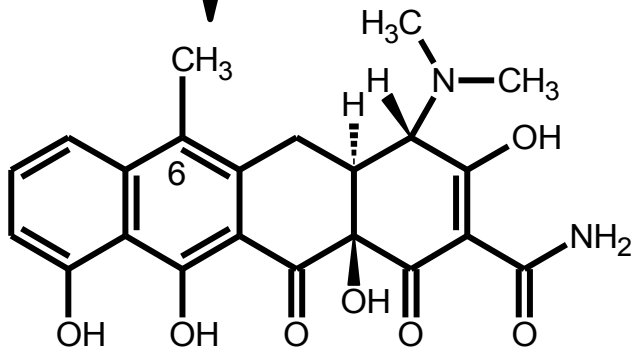
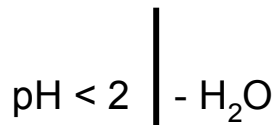

anhydrotetracycline

less active, nephrotoxic

Tetracyclines

Overview of compounds

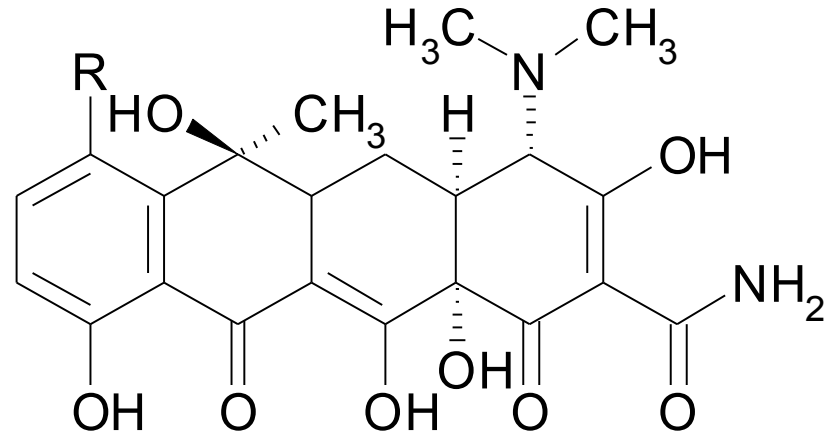

R = H **tetracycline**

- isolated from *Streptomyces viridifaciens*
- Rimatet® cps.

R = Cl **chlortetracycline**

- isolated from *Streptomyces aureofaciens*
- also antiprotozoal activity
- today a.u.v.
- start material for production of other tetracyclines
- Tetramutin Bio® a.u.v.

Tetracyclines

Overview of compounds - continued

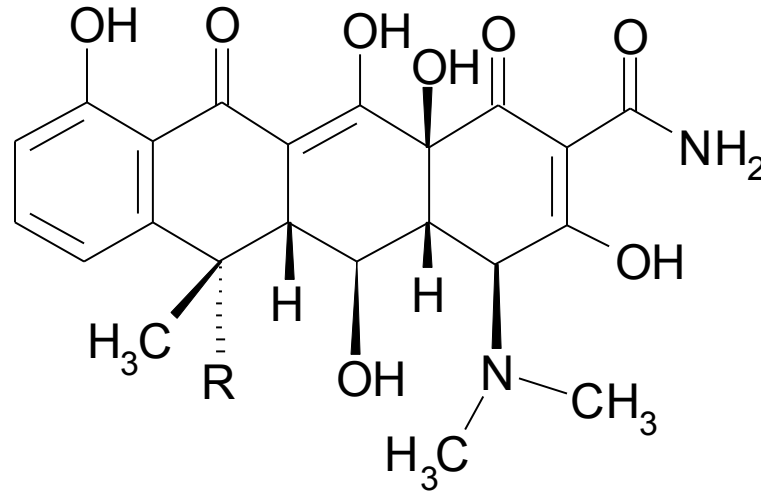

R = OH **oxytetracycline**

Oxytetracycline[®] cps.

R = H **doxycycline**

Deoxymykoin[®] tbl.

Tetracyclines

Overview of compounds - continued

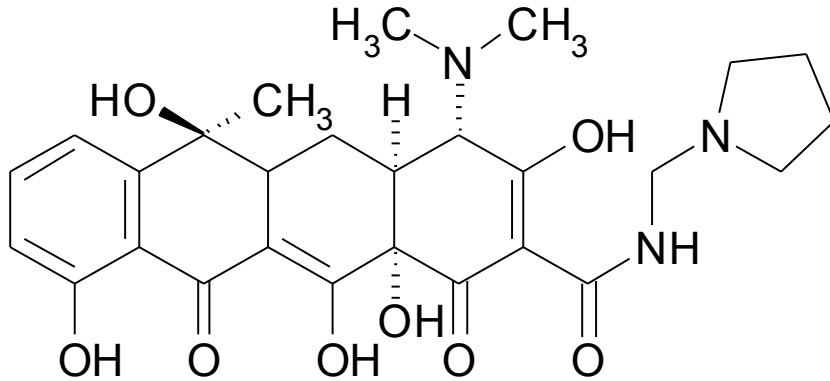

rolitetracycline

- bactericidal
- injection administration only

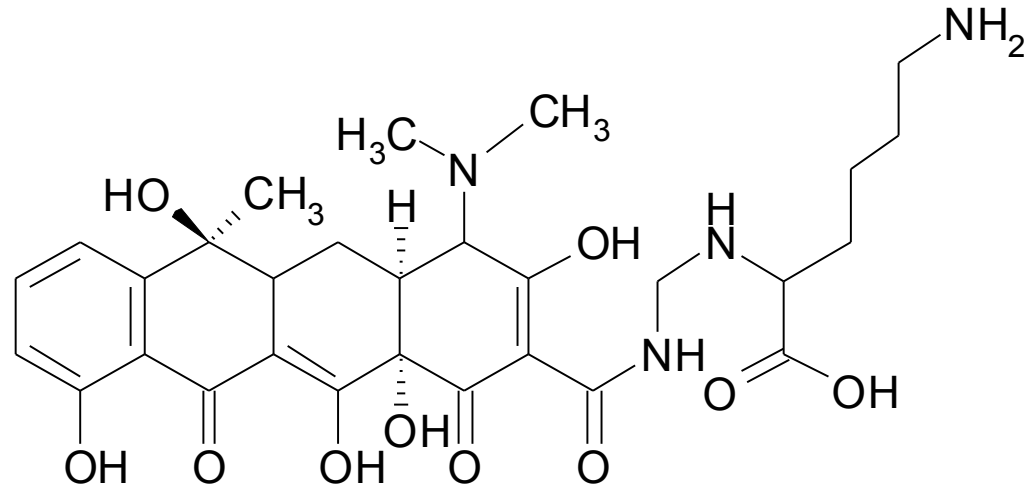

lymecycline

Tetralysal® cps.

Tetracyclines

Overview of compounds - continued

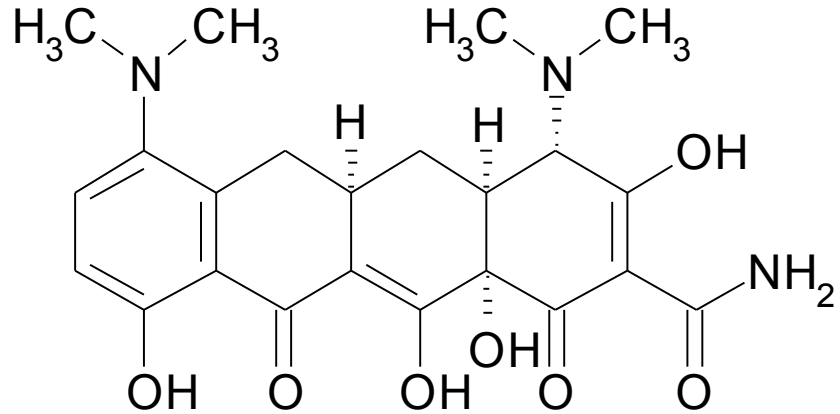

minocycline

Skid® tbl.

Tetracyclines

Overview of compounds: newer subgroup of **glycylcyclines**

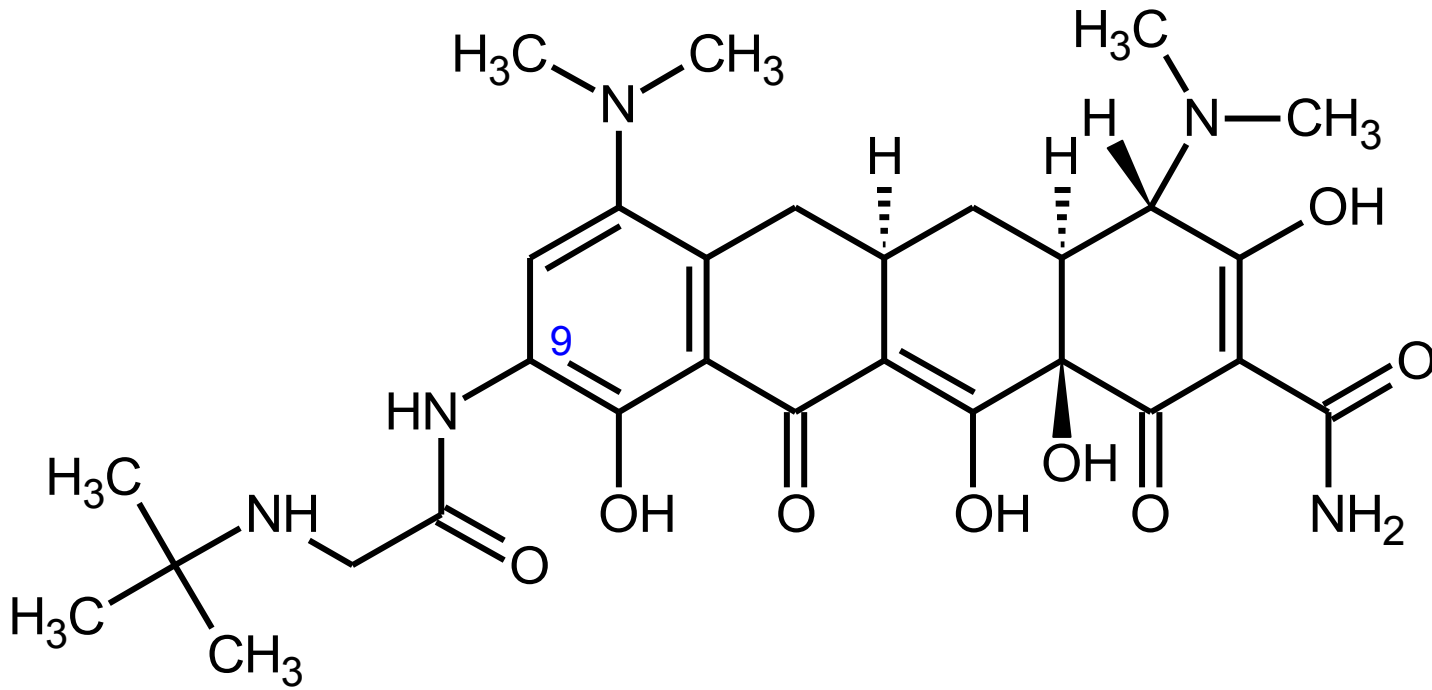

tigecycline

- complicated infections of the skin and soft tissue (the tissue below the skin), but not foot infections in people with diabetes
 - infections in the abdomen
 - only in hospitals
- Tyagacil ® inf. plv. sol.