

Drill4

KSCB113

第二十课

外国人在中国

生词

火锅

讨论/discussion

- 你吃过火锅吗？



生词

者

生词

电视剧

讨论/discussion

- 你喜欢看电视剧吗？



生词

演员

讨论/discussion

- 你有喜欢的演员吗？



生词

永远

生词

推销

讨论/discussion

- 你有被推销的经验吗？



生词

国外

讨论/discussion

- 你喜欢去国外吗？



生词

客人

生词

聚会

讨论/discussion

- 你常常参加聚会吗？



生词

聚

讨论/discussion

- 你常和朋友聚在一起吗？



生词

流

生词

校友

讨论/discussion

- 你知道你的大学有哪些有名的校友吗？



生词

而已

生词

年轻

讨论/discussion

- 你觉得你年轻吗？



生词

面熟

生词

火

讨论/discussion

- 什么东西在你的国家很火？



生词

庆祝

讨论/discussion

- 你会庆祝什么节日？



生词

众人

生词

同事

讨论/discussion

- 你有同事吗？你喜欢他们吗？



生词

周

讨论/discussion



- 你这周做了什么有意思的事情吗？

生词

联系

讨论/discussion

- 你和你小时候的朋友还有联系吗？



生词

友谊

生词

稳定

讨论/discussion



- 你想要稳定的生活吗？

生词

出差

讨论/discussion



- 你会想要常常出差吗？

生词

值[得]

生词

接受

生词

关照

讨论/discussion

- 进入大学以后，你接受过谁的关照？



生词

不仅

生词

欧洲

讨论/discussion



- 你最喜欢欧洲的哪个国家？

生词

热水器

生词

放心

生词

- 考试，你放心吧？



生词

搞

讨论/discussion

- 搞怪



生词

接风

讨论/discussion



- 你给人接风过吗？

生词

饯行

讨论/discussion

- 你给人饯行过吗？



课文

课文

- 林雪梅他们在哪里聚会？



讨论/discussion

- 你喜欢在哪里聚会？



课文

- 张天明
- 丽莎
- 李文
- 马克
- 林雪梅
- 李哲
- 柯林

- 谁参加了庆祝晚会？

课文



- 他们聚会的原因是什么？



讨论/discussion

- 你会因为什么原因聚会？



课文

- 雪梅的总经理是谁？

李哲哥哥的好朋友

课文

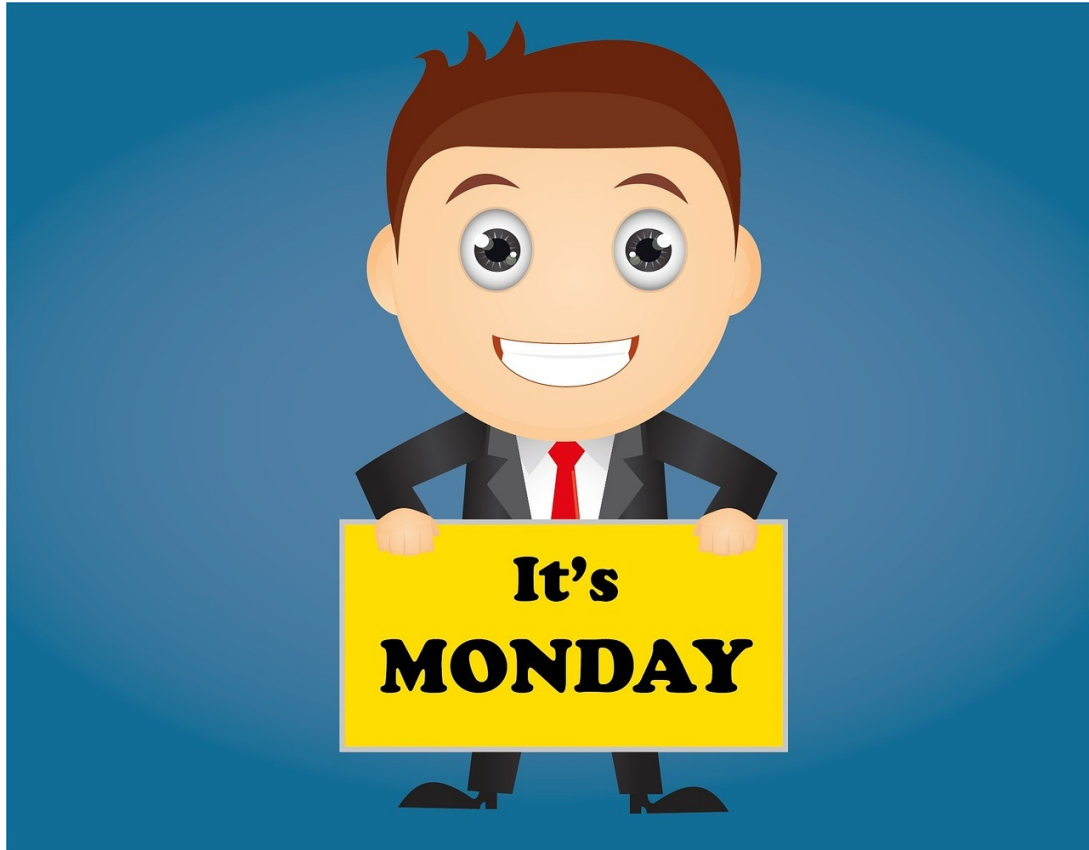

- 雪梅什么时候上班？

课文

- 雪梅的工作是什么？



课文



- 李哲是谁？

课文

- 马克做过哪些工作？



讨论/discussion

- 你做过哪些工作？



课文

- 马克在中国生活怎么样？



课文

- 丽莎在中国生活怎么样？



讨论/discussion

- 你觉得在你的国家外国人多吗？



锅



锅



- https://www.youtube.com/watch?v=Zw_tJOwZmac
- <https://www.youtube.com/watch?v=tIINA5jsfbU>
- <https://www.youtube.com/watch?v=EzOxAeqoCso>

语法

Word order in Chinese

- Subject + [adverbial] + verb + [complement] + [object/reception]
- 我 端午节的时候 吃 了 粽子

Word order in Chinese

- Topic + comment
- 面试你的那个人 我 认识
- Recipient of action subject verb

Word order in Chinese

- Direct Object + verb + indirect object
- 请你把那支笔 拿给 我

- Direct Object + verb + [indirect object]
- 请你把那支笔 拿过来

Word order in Chinese

- Recipient of action + agent verb + complement
- 林雪梅 被总经理 录用了
- 林雪梅 被 录用了

Word order in Chinese

- 这一课+comment

第二十课
外国人在中国

Word order in Chinese

- 这个周末我+comment



Word order in Chinese

- Topic+我觉得很重要



Word order in Chinese

- Topic+我觉得很有意思



Word order in Chinese



- 你会把钱投资...

Word order in Chinese



- 假日的时候，你会把时间花在...

Word order in Chinese

- 要学好中文，我们要把...

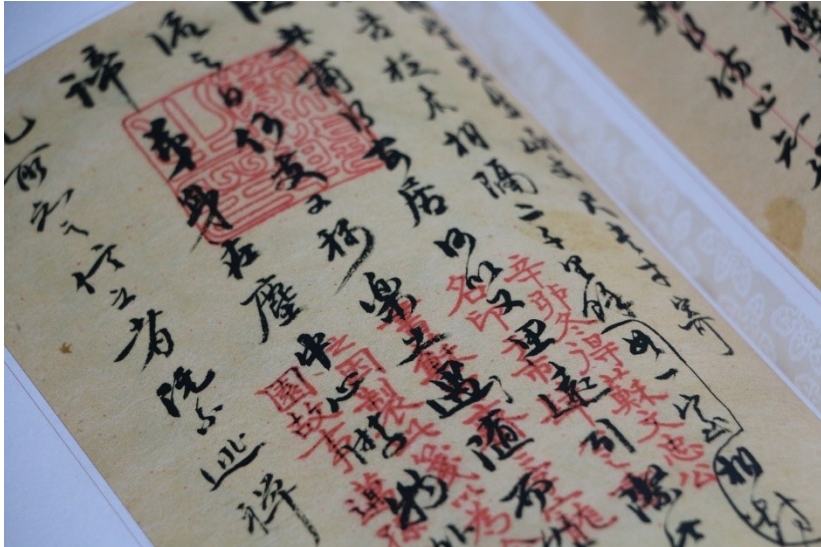

Word order in Chinese

- 我有被推销...的经验



Word order in Chinese

- 大→小
- 时间
- 地方
- 2018年一月一日十点二十三分
- 台湾台北市罗斯福路一号

Word order in Chinese

- 先→后

- 时间[action]

- 表哥开车到机场接我们

Word order in Chinese

- 你住的地方是...



Word order in Chinese

- 你的生日是...



Word order in Chinese



- 我常常去+ place + verb



Word order in Chinese

- 早上起床我习惯...

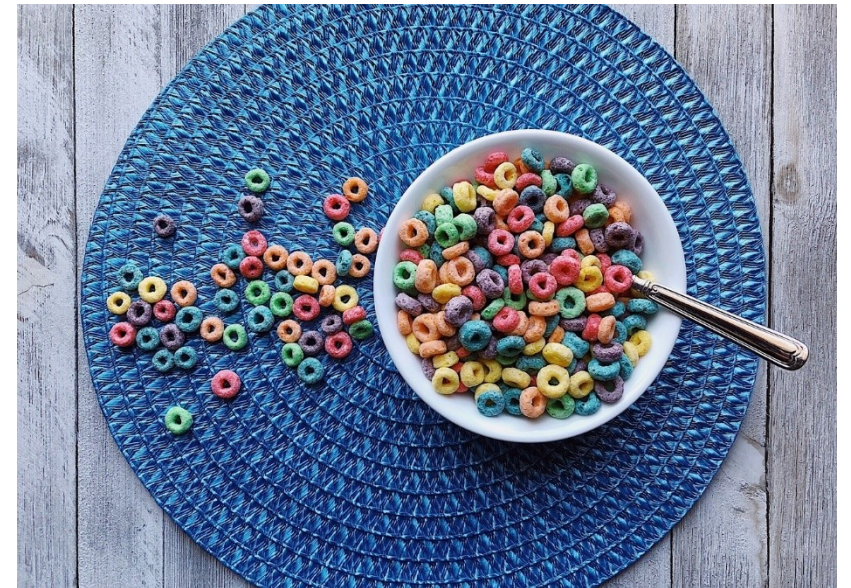

Word order in Chinese

- 我这个周末会+...+...+...



接受

- To accept
 - To take on
 - To undertake
 - 建议、领导、礼物...
 - person
- 我不能接受你这么贵的礼物

接受

- 你会接受很贵的礼物吗？



接受

- 你觉得你是个善于接受批评的人吗？



接受

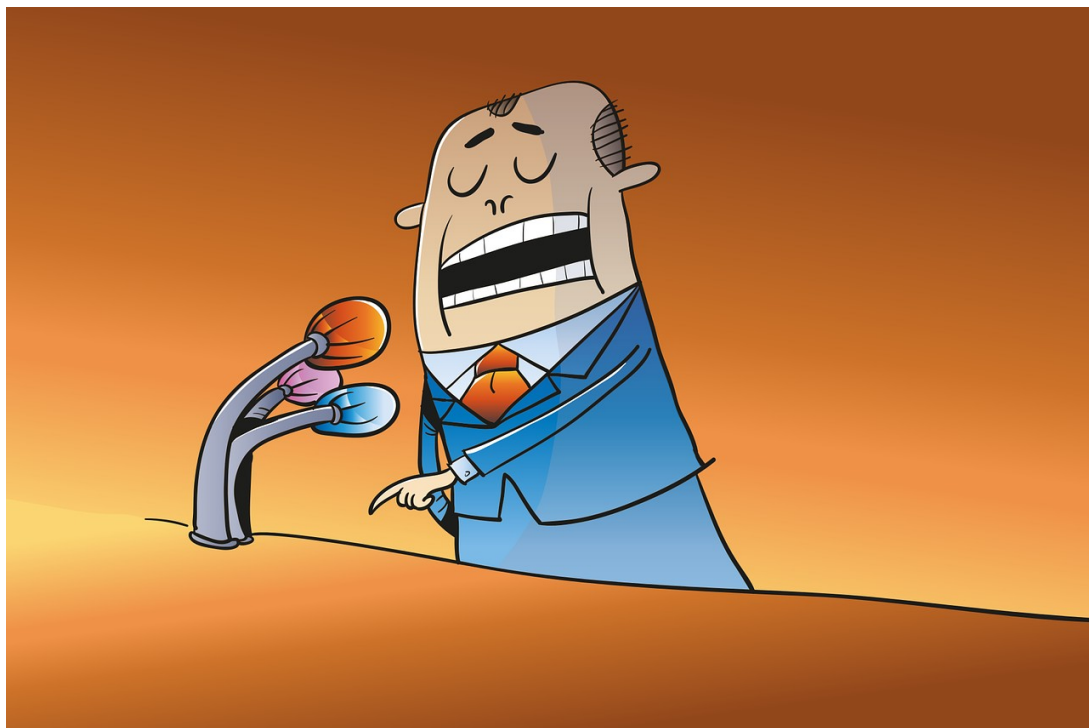

- 你不能接受怎么样的人？

接受

- 你不会接受什么样的人当你的同屋？

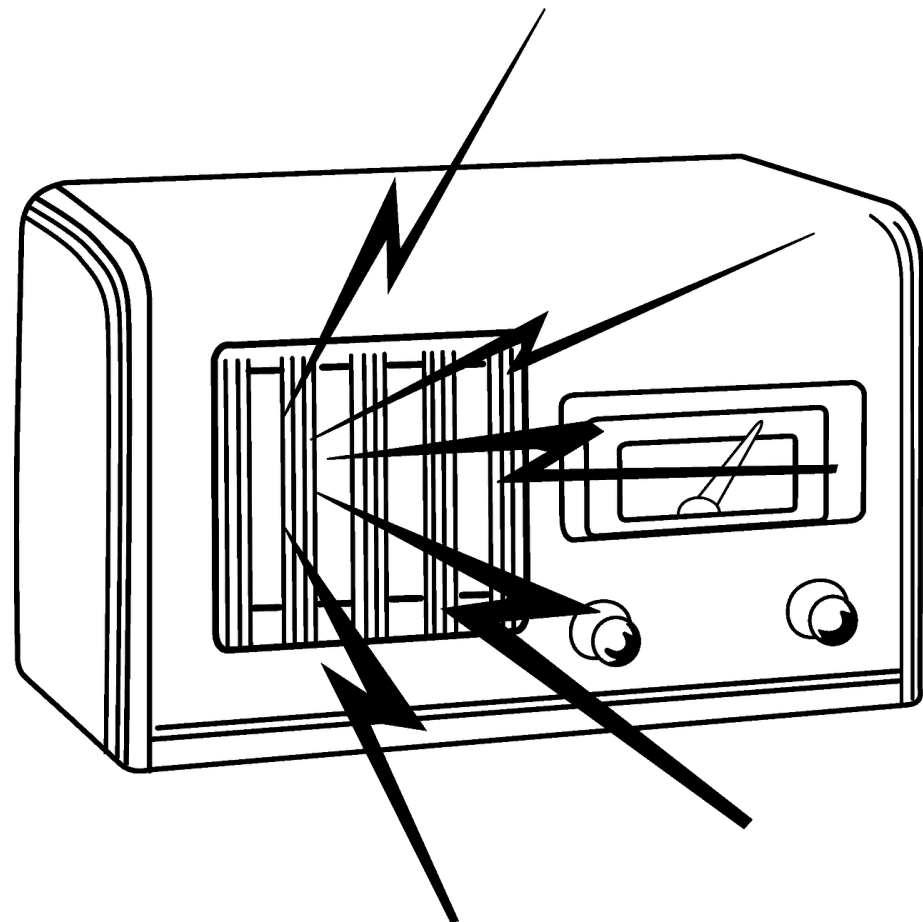

而已

- And no more
- Downplay the importance or statement
- 罢了
- 我只是开开玩笑而已，你不要生气。

而已

- To show or represent humble

- 我学中文只学了几个月而已，说的还不是很很好。

而已

- 我这学期选的课不多，只有操
练课、...而已

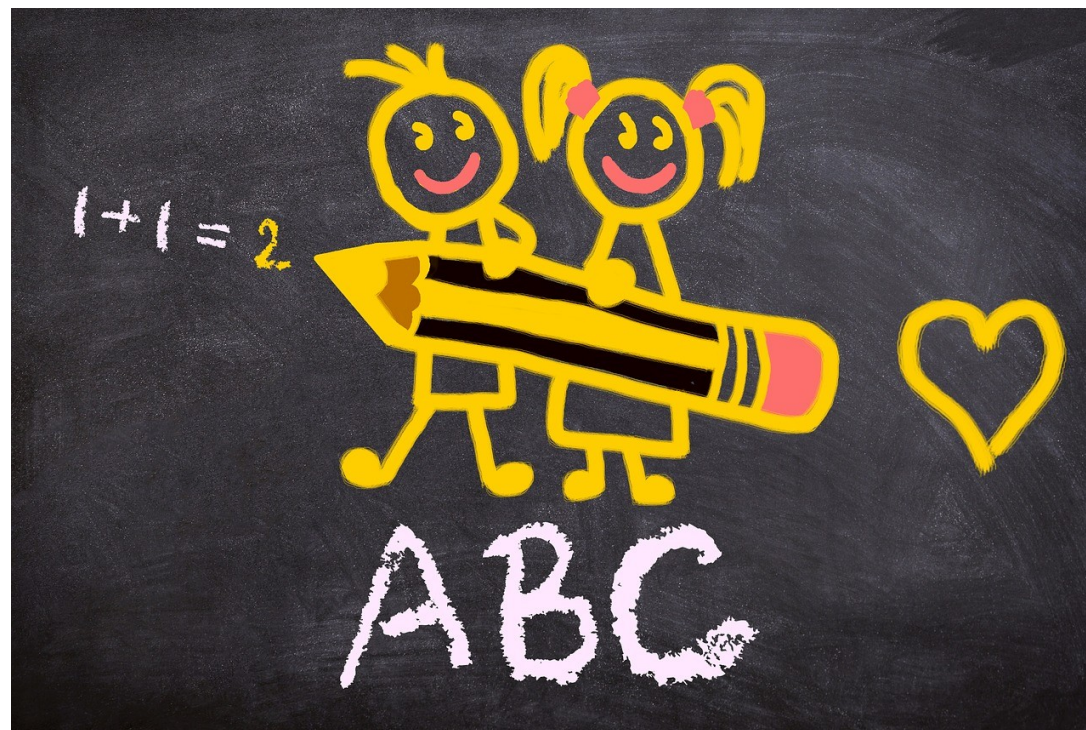

而已

和

- 我学中文只学了...而已。

而已

- 我只是一个学生而已...



而已



- 你打工能赚多少钱？
- 不多...而已。

在...下

- Under a condition
- Before a verb or subject
- 在他的领导下，公司越办越好，我哥哥还买了他们公司很多股票呢

在...下

- 在老师的指导下，我的中文...



Speaking Exercise

- 你会安排替人接风的聚会吗？
会怎么安排呢？



Speaking Exercise

- 你会安排替人饯行的聚会吗？
会怎么安排呢？



Speaking Exercise

- 去中国前，你会做什么准备？

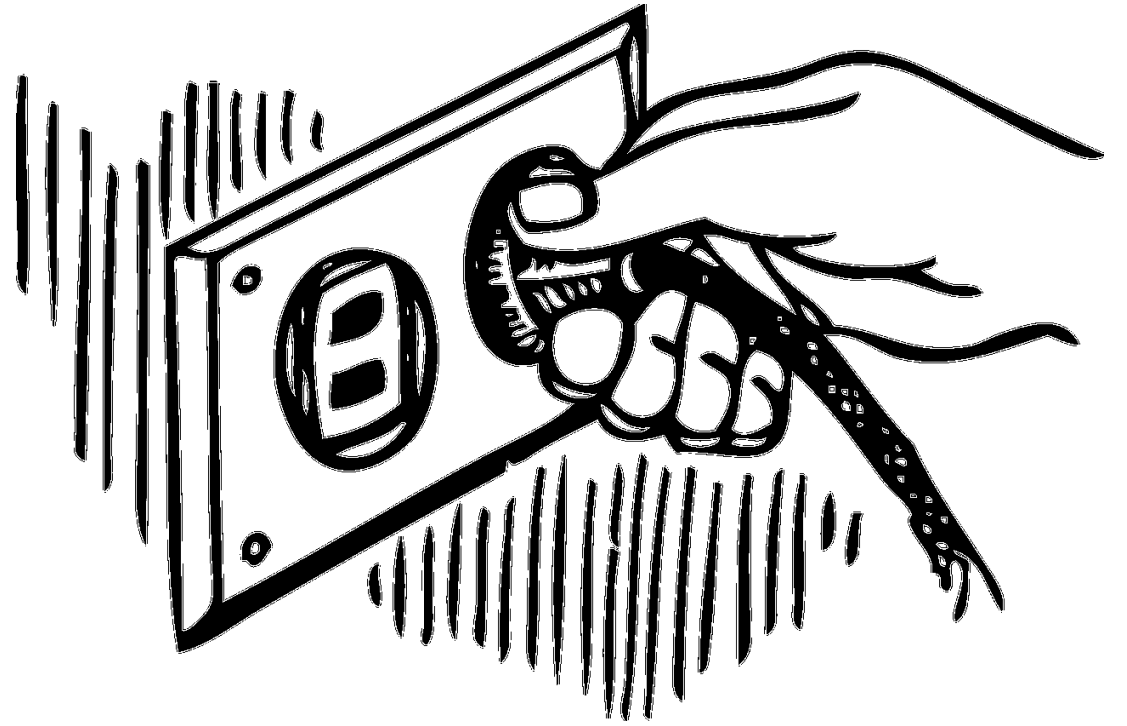

Speaking Exercise



- 去了中国之后，你会想要做什么呢？