

INTRODUCTION TO AMERICAN STUDIES

Identity and
the
Declaration of
Independence

- National identity

- What is it based on?

- Which of these hold for the United States?

LANGUAGE?

- What is the national language of the United States?
- Pennsylvania Dutch (Amish/Mennonites)
 - 1736, 225,00
- Cajun French (Louisiana)
 - 1760s, 400,000

Largest:
Holmes, OH
213 congregations



LOST BAYOU RAMBLERS

108 BIRCH DRIVE, LAFAYETTE, LA 70506
WWW.LOSTBAYOURAMBLERS.COM

BOOKING: 337.962.6674
LOSTBAYOURAMBLERS@YAHOO.COM

■ Spanish

- 1598, N. New Mexico
- San Miguel Chapel-1610

■ Chinese

- 1849, originally California
- Chinatown, San Francisco

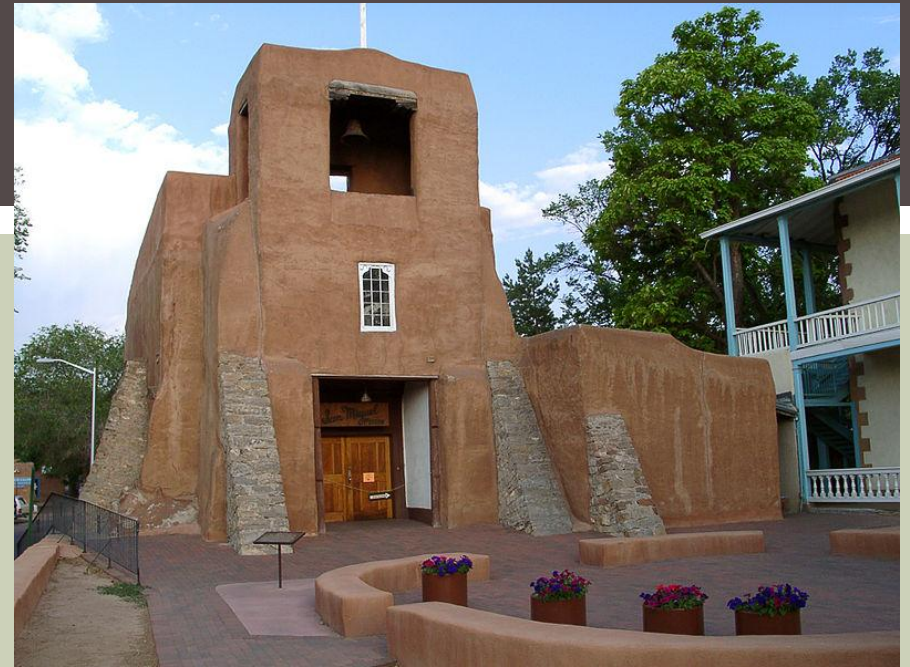

NON-ENGLISH SPEAKERS, 2000

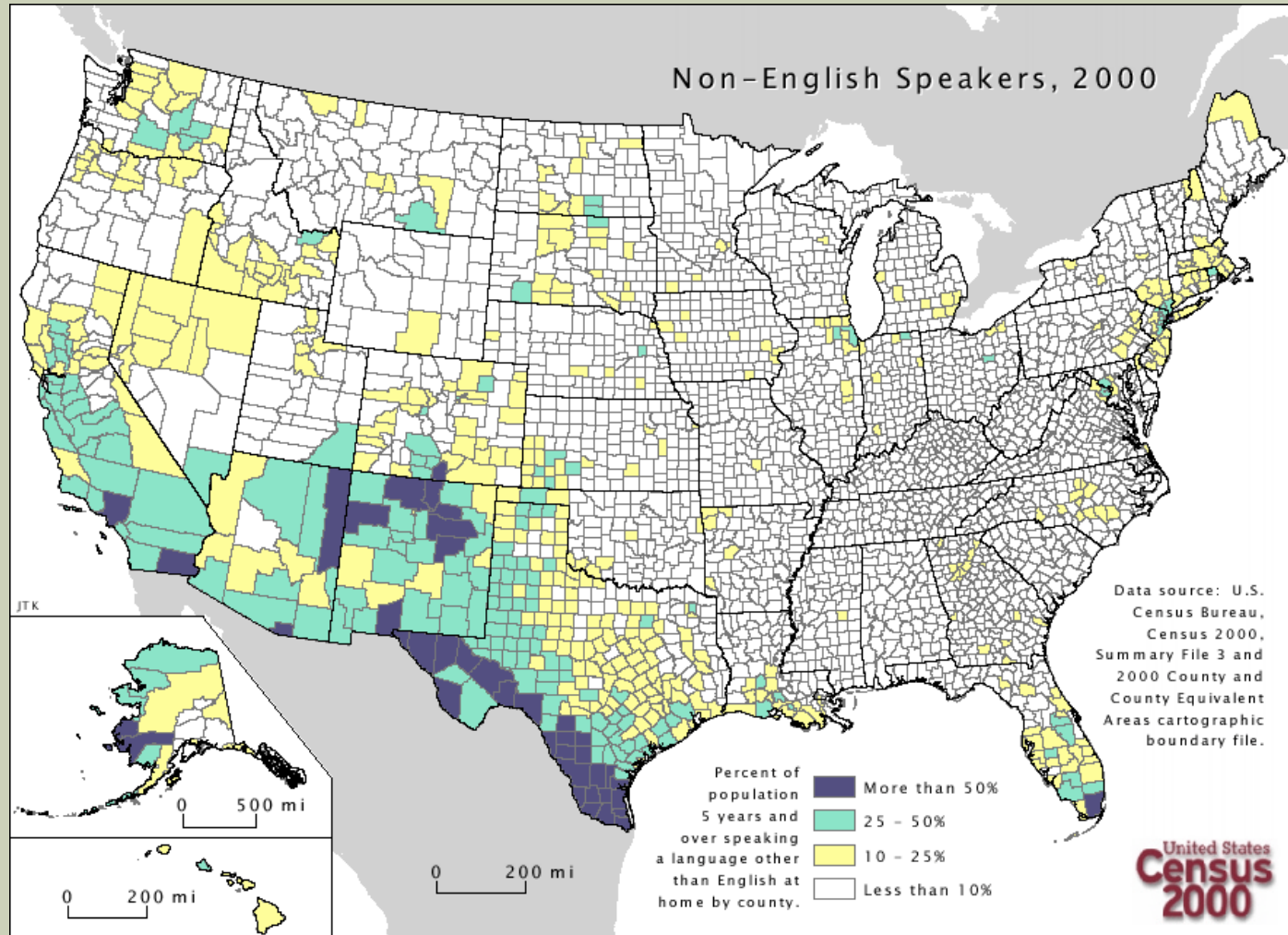

LEADING LANGUAGES SPOKEN AT HOME

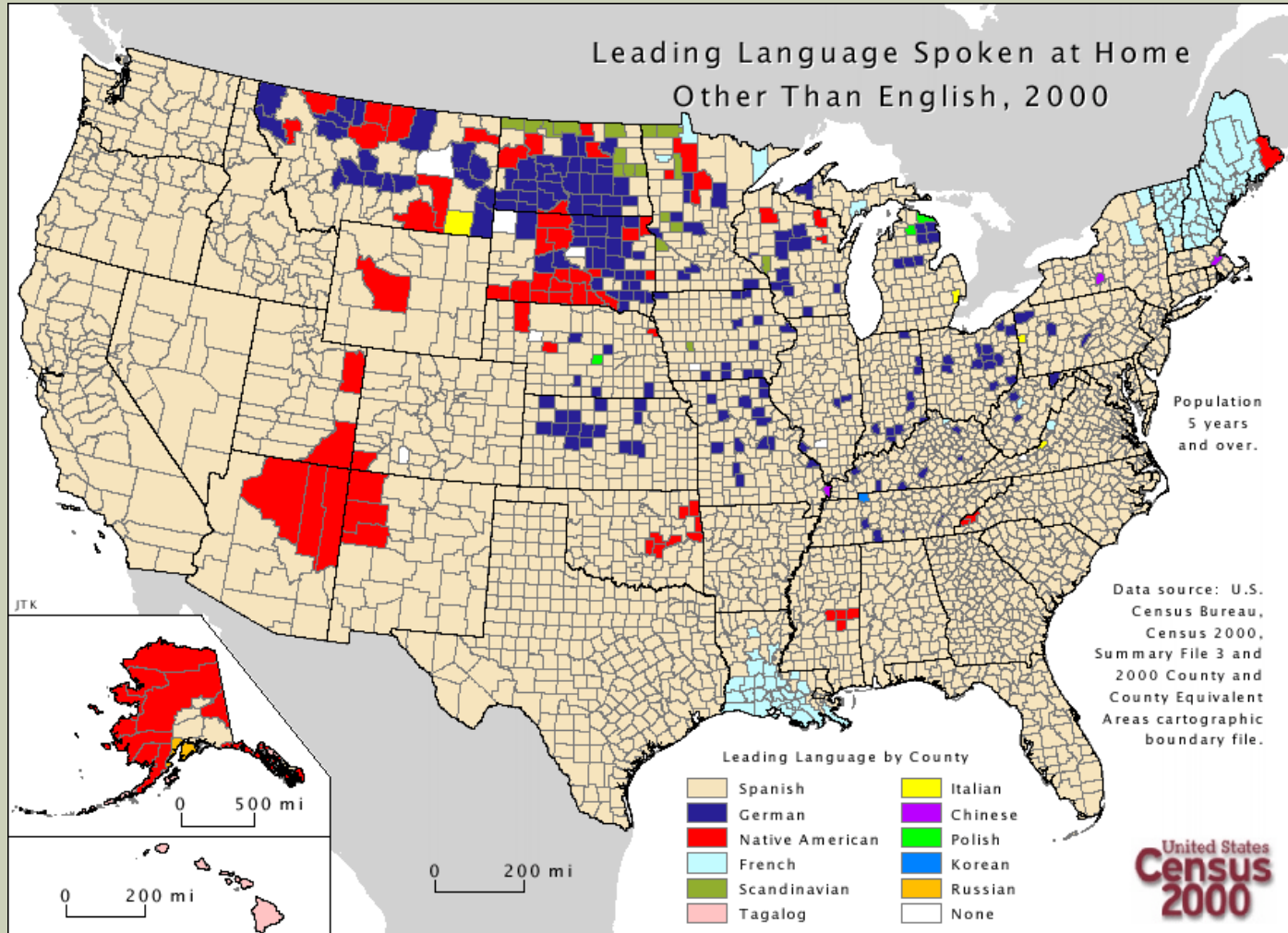

STATES WITH ENGLISH-ONLY LAWS

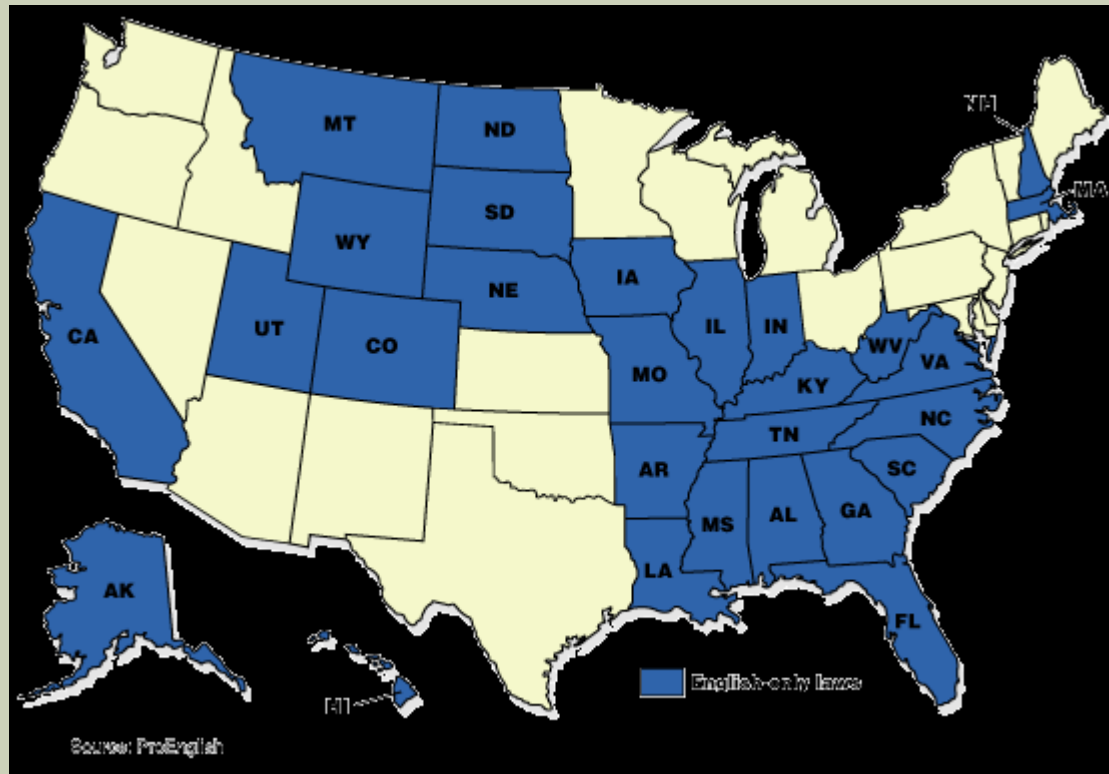

INFORMATION ON DRIVER'S LICENSE EXAMS IN CALIFORNIA (WWW.DMV.CA.GOV)

- What other languages is the written or audio test available in?
- Besides English, the basic Class C written driver license exam is also available in the following languages:
 - Amharic Arabic Armenian Cambodian
 - Chinese Croatian French German
 - Greek Hebrew Hindi Hmong
 - Hungarian Indonesian Italian Japanese
 - Korean Laotian Persian/Farsi Polish
 - Portuguese Punjabi Romanian Russian
 - Samoan Spanish Tagalog Thai
 - Tongan Turkish Vietnamese
- Besides English, the basic Class C audio driver license exam is also available in the following languages:
 - Armenian Chinese/Mandarin Hindi Hmong
 - Japanese Korean Portuguese Punjabi
 - Russian Spanish Vietnamese

WEBSITE FOR THE CHICAGO BOARD OF ELECTIONS



Board of Election Commissioners for the City of Chicago

Commissioners

Langdon D. Neal, Chairman
Richard A. Cowen, Secretary/Commissioner
Marisel A. Hernandez, Commissioner

Lance Gough, Executive Director
Kelly Bateman, Asst. Executive Director

English Español Polski 中文

Home For Voters For Candidates Information News Election Results

Most Visited

- "Voter Engagement: 2012"
- My Voter Information
- Register to Vote
- Change Name/Address
- Military/Overseas Voters
- Accessibility/Disability Service
- 2012 Election Calendar
- New Maps: State Districts
- New Maps: Congress Dists.
- Contact Us

Area Election Agencies

- Suburban Cook
- DuPage County
- Lake County
- Kane County
- McHenry County
- Will County
- City of Aurora
- State Board of Elections

March 20 Primary

Click here to find your polling place or check your voter status.
On March 20, 2012 all polling places will be open from 6 am-7 pm.



Voter Status

Use this voter lookup tool for the status of your voter registration, your polling place and related information.



Election Results

Select an election and a specific contest to view results by Ward and Precinct.



Visit the Facebook page on "Voter Engagement 2012"

Multilingual Voter Links

한국어	Assyrian	Bosanski	Hrvatski
Gujarati	اردو	عربي	Română
Русский язык	Srpski	Tagalog	Tiếng Việt

FOOD?

- Regional diversity that reflects local history and immigration
 - South: cornbread, grits, biscuits and gravy, barbeque
 - Midwest: German, Polish (kielbasa), Greek
 - Northeast: Jewish (bagels), Italian
 - West: Mexican (tamales, tacos, burritos, enchiladas), Asian food



ETHNIC ENCLAVES IN THE U.S.

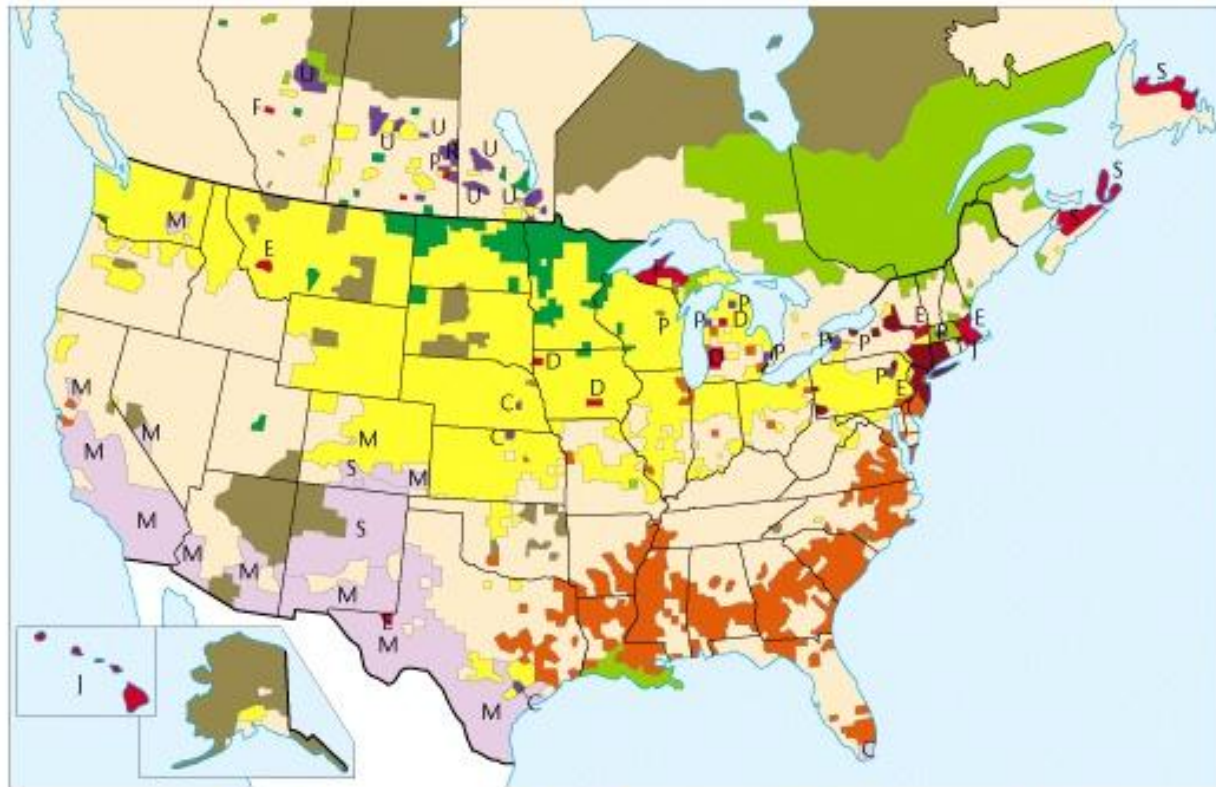

THANKSGIVING

- Tradition goes back to the seventeenth century
 - “Pilgrims”
- Fourth Thursday in November
- Dated fixed by Abraham Lincoln during Civil War

New England Thanksgiving Menu



Roast Turkey with Gravy



New England Stuffing



Mashed Potatoes



Mashed Turnip



Creamed Onions



Cranberry Sauce



Buttered Rolls



Celery Sticks



Pumpkin Pie



Pumpkin Bread

THANKSGIVING DINNER ORGANIZED BY ASIAN STUDENTS



AMERICAN NATIONAL IDENTITY

- So if these other things don't seem to work, what is American identity based on?
- Flag
 - "Patriotism"
- "Charters of Freedom"
 - Declaration of Independence
 - Constitution
 - Bill of Rights

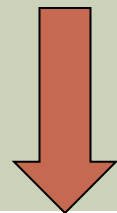

NO PRESIDENTIAL PORTRAIT(S) IN US CLASSROOMS



THE PLEDGE OF ALLEGIANCE

I pledge allegiance to the Flag of the United States of America and to the Republic for which it stands, one Nation *under God*, indivisible, with liberty and justice for all.

- Originally written by Francis Bellamy in 1892
 - Words “under God” added in 1954

AN ILLINOIS PRIMARY SCHOOL



MICHIGAN AVENUE BRIDGE IN CHICAGO



ORDINARY HOUSES



OUTSIDE A CONFUCIAN TEMPLE IN CHICAGO



A CHINESE GROCERY IN CHICAGO



NEW YORK: ST. PATRICK'S CATHEDRAL & SAK'S FIFTH AVENUE DEPT. STORE



RELIGIOUS INTERIORS: CATHOLIC, PROTESTANT AND JEWISH



FLAG CONTROVERSY IN LAWRENCE, KANSAS

- The 600-square-foot (55 sq. m) brightly illuminated U.S. flag flying outside Heritage Baptist Church is causing a stir among church neighbors, some of whom say the lights are a nuisance. The church has no intention of giving up the display. “As far as I’m concerned, the people complaining are un-American,” said Rev. Scott Hanks, right, pastor at the church.

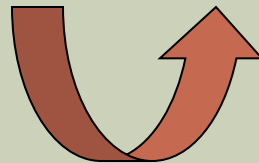

WHAT IS THIS BUILDING?



THE NATIONAL ARCHIVES ARE LOCATED ON PENNSYLVANIA AVENUE

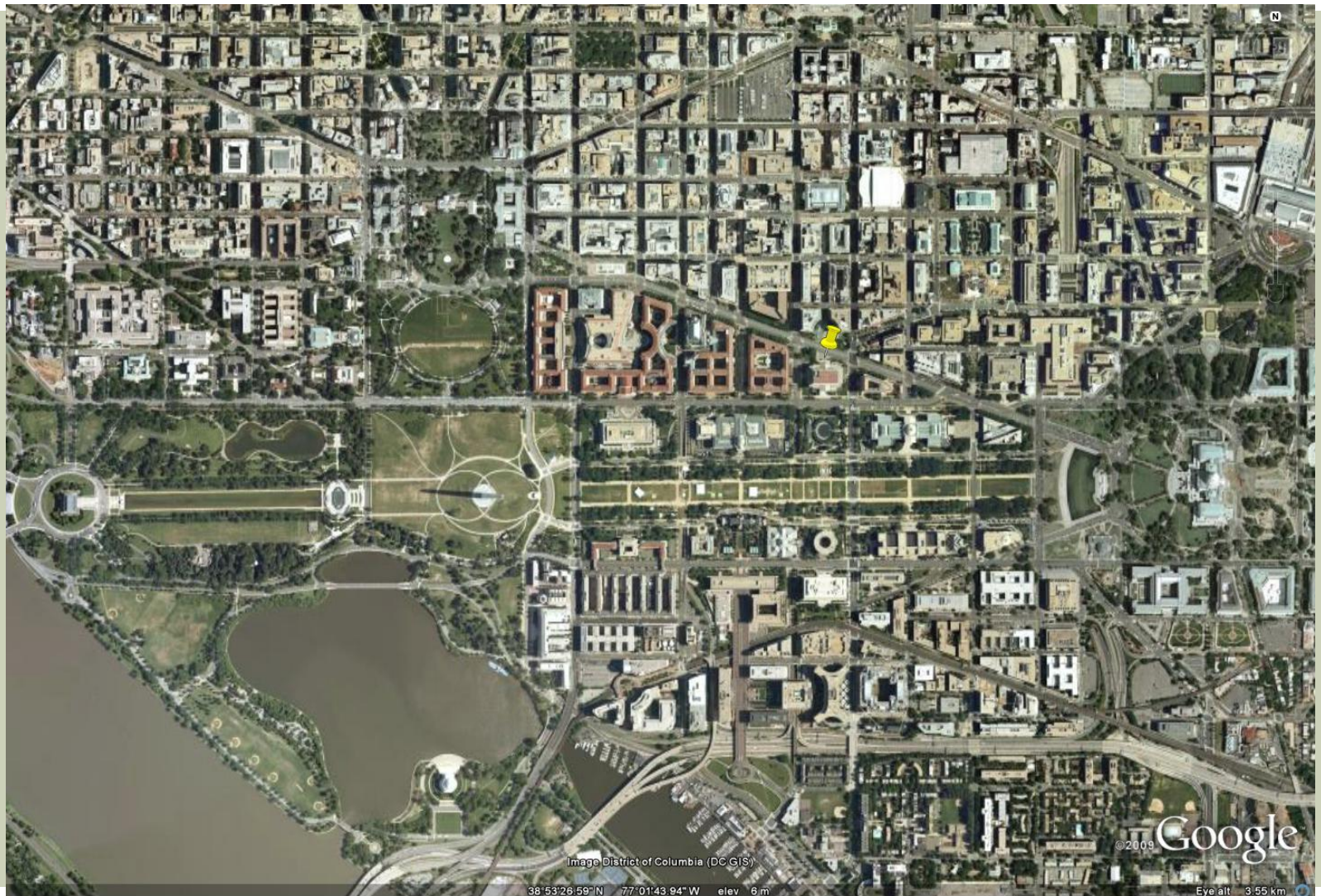

DECLARATION OF INDEPENDENCE

- **Copy of the original kept at the National Archives**
 - Visited by more **1 million** annually
 - Building built in **1952** specifically to house these documents
- **Together with the Constitution and Bill of Rights they form the “Charters of Freedom”**

- **The next slide contains more images of the National Archives’ interior and the specially designed storage case holding the Charters of Freedom**

PRESIDENT & MRS. BUSH AT THE REOPENING OF THE NATIONAL ARCHIVES



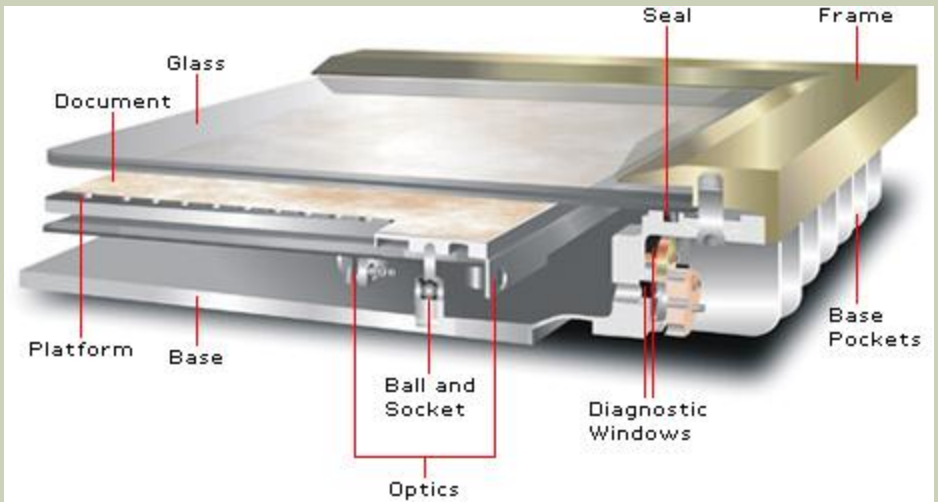

THE DECLARATION OF INDEPENDENCE: INTRODUCTION

IN CONGRESS, July 4, 1776.

The unanimous Declaration of the thirteen united States of America,

When in the Course of human events, it becomes necessary for one people to dissolve the political bands which have connected them with another, and to assume among the powers of the earth, the separate and equal station to which the Laws of Nature and of Nature's God entitle them, a decent respect to the opinions of mankind requires that they should declare the causes which impel them to the separation.

THE DECLARATION OF INDEPENDENCE: PREAMBLE (1)

We hold these truths to be self-evident, that all men are created equal, that they are endowed by their Creator with certain unalienable Rights, that among these are Life, Liberty and the pursuit of Happiness.—That to secure these rights, Governments are instituted among Men, deriving their just powers from the consent of the governed, —That whenever any Form of Government becomes destructive of these ends, it is the Right of the People to alter or to abolish it, and to institute new Government, laying its foundation on such principles and organizing its powers in such form, as to them shall seem most likely to effect their Safety and Happiness.

THE DECLARATION OF INDEPENDENCE: PREAMBLE (2)

Prudence, indeed, will dictate that Governments long established should not be changed for light and transient causes; and accordingly all experience hath shewn, that mankind are more disposed to suffer, while evils are sufferable, than to right themselves by abolishing the forms to which they are accustomed. But when a long train of abuses and usurpations, pursuing invariably the same Object evinces a design to reduce them under absolute Despotism, it is their right, it is their duty, to throw off such Government, and to provide new Guards for their future security.—

THE DECLARATION OF INDEPENDENCE: INDICTMENT OF GEORGE III (1)

Such has been the patient sufferance of these Colonies; and such is now the necessity which constrains them to alter their former Systems of Government. The history of the present King of Great Britain is a history of repeated injuries and usurpations, all having in direct object the establishment of an absolute Tyranny over these States. To prove this, let Facts be submitted to a candid world.

He has refused his Assent to Laws, the most wholesome and necessary for the public good.

He has forbidden his Governors to pass Laws of immediate and pressing importance, unless suspended in their operation till his Assent should be obtained; and when so suspended, he has utterly neglected to attend to them.

...

THE DECLARATION OF INDEPENDENCE: INDICTMENT (2)

He has abdicated Government here, by declaring us out of his Protection and waging War against us.

He has plundered our seas, ravaged our Coasts, burnt our towns, and destroyed the lives of our people.

He is at this time transporting large Armies of foreign Mercenaries to compleat the works of death, desolation and tyranny, already begun with circumstances of Cruelty & perfidy scarcely paralleled in the most barbarous ages, and totally unworthy the Head of a civilized nation.

He has constrained our fellow Citizens taken Captive on the high Seas to bear Arms against their Country, to become the executioners of their friends and Brethren, or to fall themselves by their Hands.

He has excited domestic insurrections amongst us, and has endeavoured to bring on the inhabitants of our frontiers, the merciless Indian Savages, whose known rule of warfare, is an undistinguished destruction of all ages, sexes and conditions.

...

In every stage of these Oppressions We have Petitioned for Redress in the most humble terms: Our repeated Petitions have been answered only by repeated injury. A Prince whose character is thus marked by every act which may define a Tyrant, is unfit to be the ruler of a free people.

THE MISSING INDICTMENT

- In the original draft this last complaint is followed by one further charge leveled against George III.
- Here it can be seen in the original draft in Jefferson's own hand:

JEFFERSON'S ORIGINAL DRAFT:

he has endeavored to bring on the inhabitants of our frontiers the merciless Indian savages, whose known rule of warfare is an undistinguished destruction of all ages, sexes, & conditions [of existence].

He has incited treasonable insurrections of our fellow citizens, with the abettors of forfeiture & confiscation of our property. ^{to be} he has ^{been} ^{incited} ^{to} ^{commit} ^{crimes} ^{which} ^{are} ^{the} ^{most} ^{heinous} ⁱⁿ ^{the} ^{eyes} ^{of} ^{human} ^{nature} ^{itself}, violating its most sacred rights of life & liberty in the persons of a distant people who never offended him, captivating & carrying them into slavery in another hemisphere, or to incur miserable death in their transportation thither. This piratical warfare, the opprobrium of infidel powers, is the warfare of the Christian king of Great Britain, determined to keep open a market where MEN should be bought & sold he has prostituted his negative for suppressing every legislative attempt to prohibit or to restrain this execrable commerce; and that this assemblage of horrors might want no fact of distinguished die, he is now exciting those very people to rise in arms among us, and to purchase that liberty of which he has deprived them, by murdering the people upon whom he also obtruded them: thus copying off former crimes committed against the liberties of one people, with crimes which he urges them to commit against the lives of another.]

in every stage of these oppressions we have petitioned for redress in the most humble forms; our repeated petitions have been answered ^{only} by repeated injuries. a prince

AMERICAN HANDWRITING (CURSIVE)

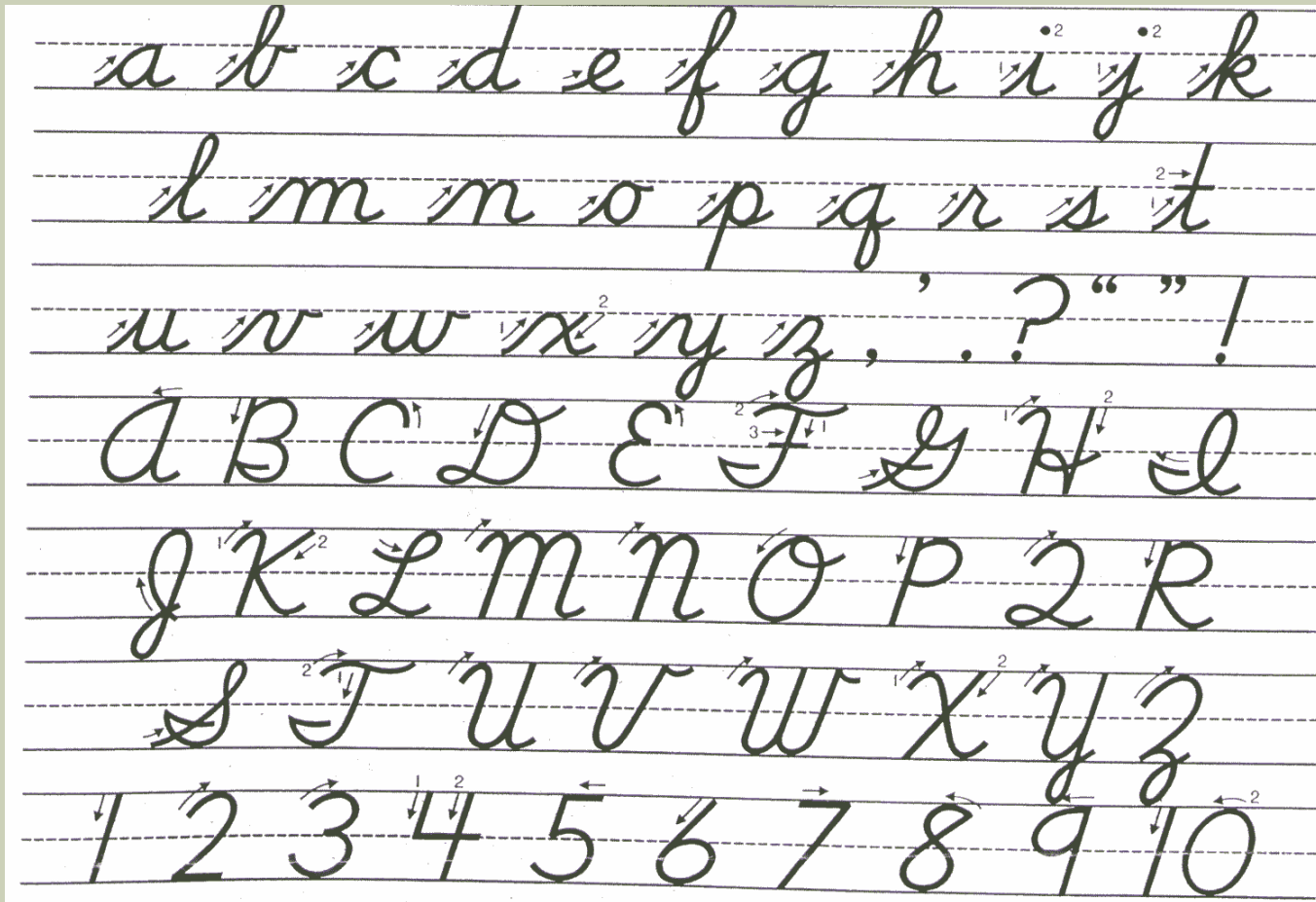

TEXT OF THE MISSING INDICTMENT

he has waged cruel war against human nature itself, violating it's most sacred rights of life and liberty in the persons of a distant people who never offended him, captivating and carrying them into slavery in another hemisphere, or to incur miserable death in their transportation hither. this piratical warfare, the opprobrium* of infidel powers, is the warfare of the Christian king of Great Britain. [determined to keep open a market where MEN should be bought and sold,] he has prostituted his negative for suppressing every legislative attempt to prohibit or to restrain this execrable commerce [determining to keep open a market where MEN should be bought and sold]: and that this assemblage of horrors might want no fact of distinguished die, he is now exciting those very people to rise in arms among us, and to purchase that liberty of which he had deprived them, by murdering the people upon whom he also obtruded them: thus paying off former crimes committed against the liberties of one people, with crimes which he urges them to commit against the lives of another.

*Opprobrium -- something that brings disgrace, public disgrace or ill fame that follows from conduct considered grossly wrong or vicious

WHO WAS THOMAS JEFFERSON (1743-1826)?

- Thomas Jefferson, quintessential Enlightenment figure
 - Author of Declaration of Independence
 - University of Virginia (1825)
 - Virginia Statute on Religious Freedom
 - Monticello
 - *Notes on the State of Virginia*
- The Thomas Jefferson Memorial in Washington, D.C. (1943)



JEFFERSON PORTRAIT AND TOMBSTONE



UNIVERSITY OF VIRGINIA

- Jefferson even designed some of the buildings, including this Rotunda

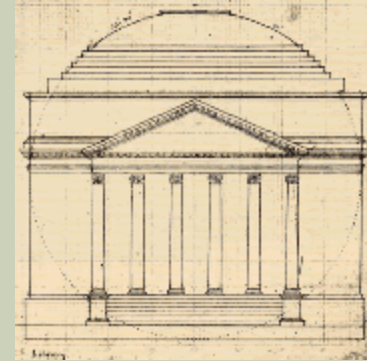

MONTICELLO

- Jefferson not only designed all the buildings but ran the estate as a model farm
- Estate covered more than 5000 acres (2000 hectares)



© 2001 Jim Wark, Airphoto

NOTES ON THE STATE OF VIRGINIA (1781)

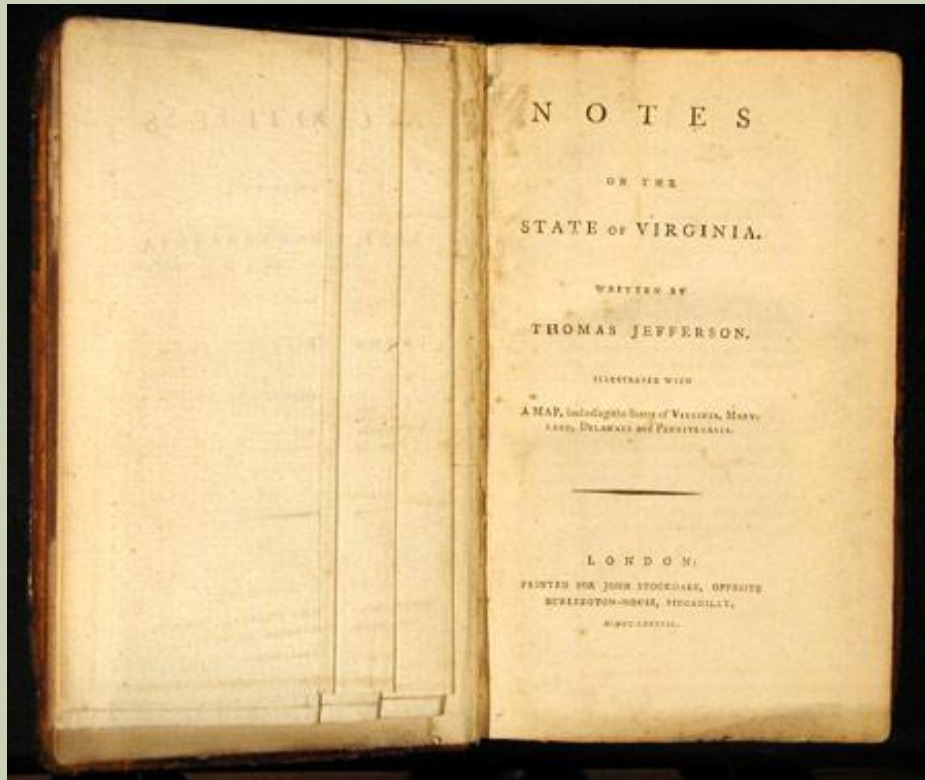

AMERICAN PHILOSOPHICAL SOCIETY

NOTES on the state of VIRGINIA,
written in the year 1781, somewhat corrected and enlarged in the winter of 1782,
for the use of a Foreigner of distinction, in answer to certain queries proposed by him respecting

1. Its boundaries	- - -	page 1
2. Rivers	- - -	3
3. Sea ports	- - -	17
4. Mountains	- - -	18
5. Cascades and caverns	- - -	33
6. Productions mineral, vegetable and animal	-	41
7. Climate	- - -	134
8. Population	- - -	151
9. Military force	- - -	162
10. Marine force	- - -	165
11. Aborigines	- - -	166
12. Counties and towns	- - -	191
13. Constitution	- - -	193
14. Laws	- - -	215
15. Colleges, buildings, and roads	-	275
16. Proceedings as to treaties	- - -	285
17. Religion	- - -	287
18. Manners	- - -	298
19. Manufactures	- - -	301
20. Subjects of commerce	- - -	304
21. Weights, Measures and Money	-	311
22. Public revenue and expences	- - -	313
23. Histories, memorials, and state-papers	-	322

MDCCLXXXII.

THOMAS JEFFERSON, SLAVE OWNER

- Inherited more than 2,000 hectares and between 20-40 slaves in 1757 from his father
 - This land included the Monticello estate
- Owned more than 600 individuals over the course of his life
- Inherited first at the age of 14
- Sold more than 110 slaves during his life and gave a further 85 as gifts

- Jefferson's "Memorandum Book" for 1773:
- January 29.: sold Sandy to Colo [Colonel] Chas [Charles] Lewis for £100 paiable [sic] in June. From which deduct £9.4.8. my present debt with him; leaves £90.15.4. to be sec'd [secured]

in 18. charge Mr. Morgan good from 2. 12. 2 1/2
 Jan 18. Dalton v. Lewis on 1/6 rec'd
 20. pd at Byrd ord. old bal. 2/6
 21. pd ferris at Woodson's 1/3
 bot Ursula, and her sons George and
 Baynell of Fleming's estate for £ 210.
 pd ferris at Michaux 1/3
 22. pd for work at Byrd ord. 7 1/2
 26. charge Geo. Dudley 12 1/2 barrels corn the
 whole deliv'd this year. Rich. Sorrells witness
 I am to pay Wm Page 10/ for bringing things
 from Wm.burgh for myself.
 also 10/ for Randolph Jefferson for bring-
 ing his bed and trunk up fr Wm.burgh
 29. sold Sandy to Colo Chas Lewis for £ 100.
 paiable in June. from which de-
 duct £ 9. 4. 8 my present debt with
 him, leaves £ 90. 15. 4. to be sec'd.
 Jan 31. on settling Anderson Bryan's acct till Feb. 4.
 at which time will be done, he is in my debt 2/9
 which give up
 lent him 10/ to be charged for future work
 Feb 1. Henry Walker (great Wm.burgh) v. John
 Kemp (Mechlenb. Co.) bring acct on the
 Case Deam. £ 200.
 Feb. 1. pd T. Morgan 6/.
 pd entent at Byrd ord. 4/6
 4. gave Sup. to pay omith near Tuckahoe 1/3
 11. pd Bishop for bringing letters 1/6

ISAAC JEFFERSON (1775-1850) IN 1845



THOMAS JEFFERSON, FATHER OF SLAVES

- Sally Hemmings
- As early as 1802 rumors existed that Jefferson had fathered children by one or more of his slaves
 - In 1802, the journalist James Thomson Callender wrote in the newspaper *The Richmond Recorder*, “The PRESIDENT AGAIN. It is well known that the man, whom it delighteth the people to honor, keeps, and for many years past has kept, as his concubine, one of his own slaves. Her name is SALLY. The name of her eldest son is TOM. His features are said to bear a striking although sable resemblance to those of the president himself. The boy is ten or twelve years of age...We hear that our young MULLATO PRESIDENT begins to give himself a great number of airs of importance in Charlottesville, and the neighbourhood...By this wench, Sally, our president has had several children. There is not an individual in the neighborhood of Charlottesville who does not believe the story, and not a few who know it...The AFRICAN VENUS is said to officiate, as housekeeper at Monticello.”

A PHILOSOPHIC COCK

- ‘A philosophic cock’ attributed to James Akin, Newburyport, Massachusetts, ca. 1804.
- “Tis not a set of features or complexion or tincture of a Skin that I admire”
 - Joseph Addison (1672-1719), *Cato*, Act 1



WHO WERE HIS SLAVE CHILDREN?

- **1873 memoirs of Sally's son Madison claimed that Jefferson was the father of at least three of her children**
- **Sally Hemmings children were light-skinned, and three of them (daughter Harriet and sons Beverly and Eaton) lived as members of white society as adults.**
- **According to contemporary accounts, some of Sally Hemmings children strongly resembled Thomas Jefferson.**
- **Thomas Jefferson freed all of Sally Hemmings children: Beverly and Harriet were allowed to leave Monticello in 1822; Madison and Eaton were released in Jefferson's 1826 will. Jefferson gave freedom to no other nuclear slave family.**
- **DNA analysis has shown that Thomas Jefferson and one of Sally's children (Eaton) share their Y-chromosome**
 - **A male Jefferson other than Thomas (e.g. his brother Randolph) could also have been the father**

THE DESCENDENTS OF THOMAS JEFFERSON AND SALLY HEMMINGS



JEFFERSON'S OWN RECOGNITION OF THE PROBLEM

- Jefferson discussing the Missouri question and slavery to John Holmes April 22, 1820:
- “But as it is, we have the wolf by the ear, and we can neither hold him, nor safely let him go. Justice is in one scale, and self-preservation in the other.”

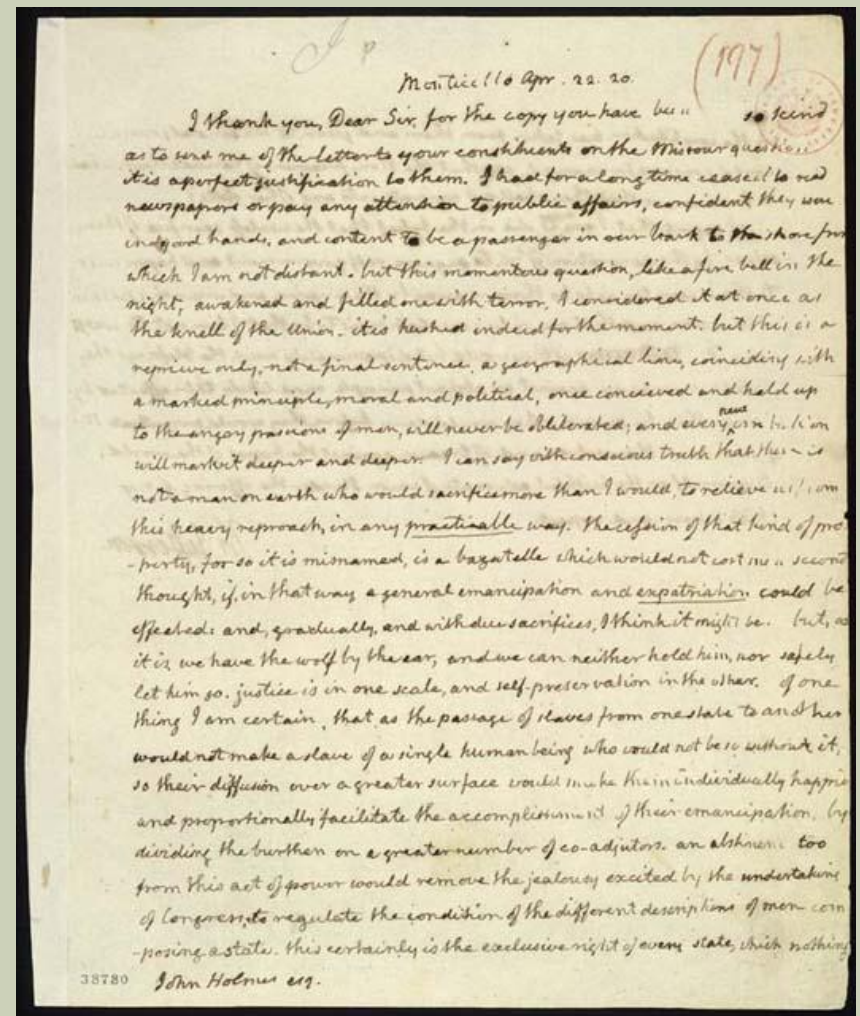

Monticello Apr. 22. 20. (1820)

I thank you, Dear Sir, for the copy you have been so kind as to send me of the letters of your constituents on the Missouri question. It is a perfect justification to them. I had for a long time ceased to read newspapers or pay any attention to public affairs, confident they were in good hands, and content to be a passenger in our boat to the shore from which I am not distant. But this momentous question, like a fire bell in the night, awakened and filled me with terror. I considered it at once as the knell of the Union. It is hushed indeed for the moment, but this is a reprieve only, not a final sentence. A geographical line, coinciding with a marked principle, moral and political, once conceived and held up to the angry passions of men, will never be obliterated; and every new breeze will mark it deeper and deeper. I can say with conscious truth that there is not a man on earth who would sacrifice more than I would, to relieve us from this heavy reproach, in any practicable way. The cessation of that kind of pro-
-perty, for so it is misnamed, is a bagatelle which would not cost us a second thought, if in that way a general emancipation and expatriation could be effected: and, gradually, and with due sacrifices, I think it might be. But, as it is, we have the wolf by the ear, and we can neither hold him, nor safely let him go. Justice is in one scale, and self-preservation in the other. Of one thing I am certain, that as the passage of slaves from one state to another would not make a slave of a single human being who could not be so without it, so their diffusion over a greater surface would make him individually happier and proportionally facilitate the accomplishment of their emancipation, by dividing the burthen on a greater number of co-adjutors. An abstinence too from this act of power would remove the jealousy excited by the undertaking of Congress, to regulate the condition of the different descriptions of men composing a state. This certainly is the exclusive right of every state, which nothing

38780 John Holmes esq.