

Celková úmrtnost na rakovinu v USA podle typu

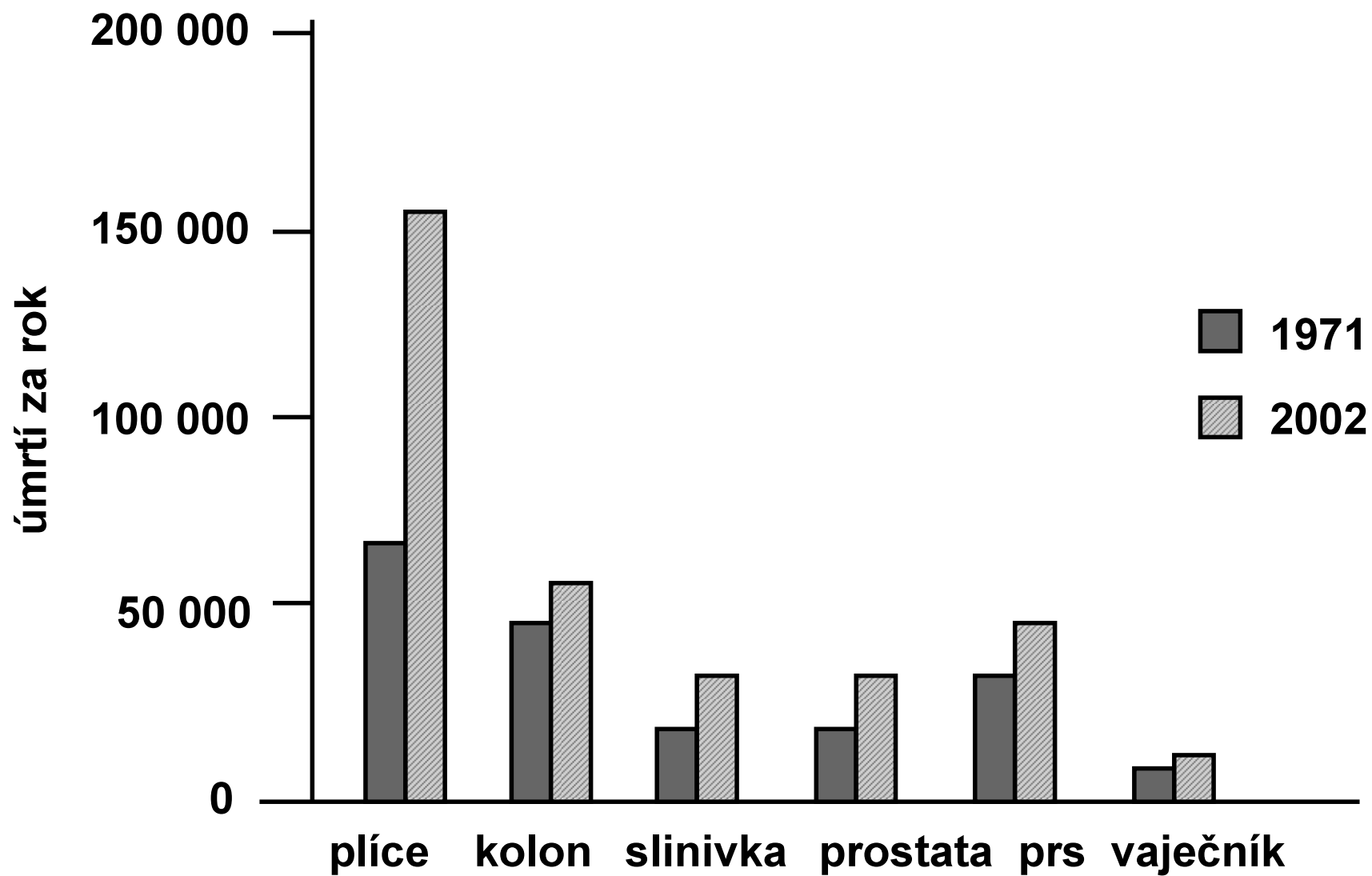

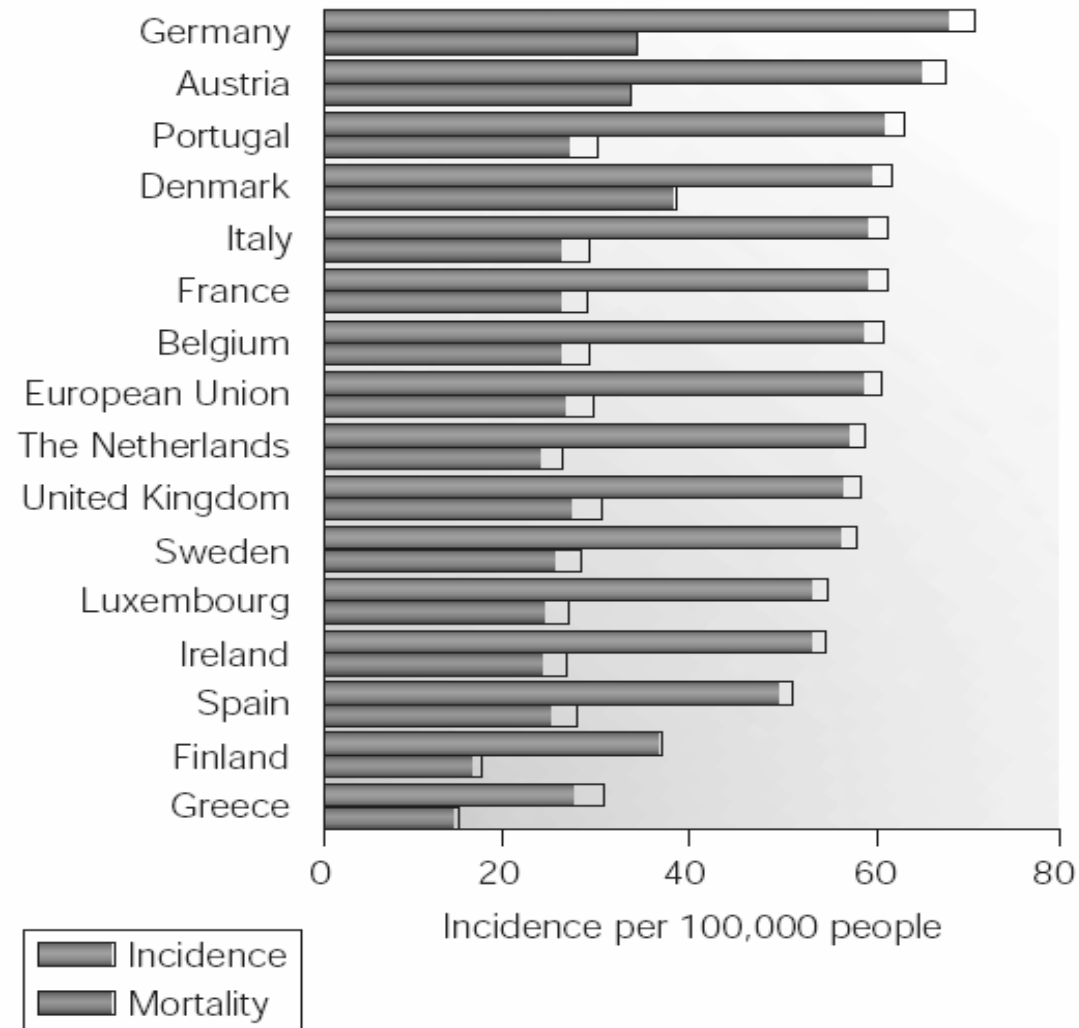
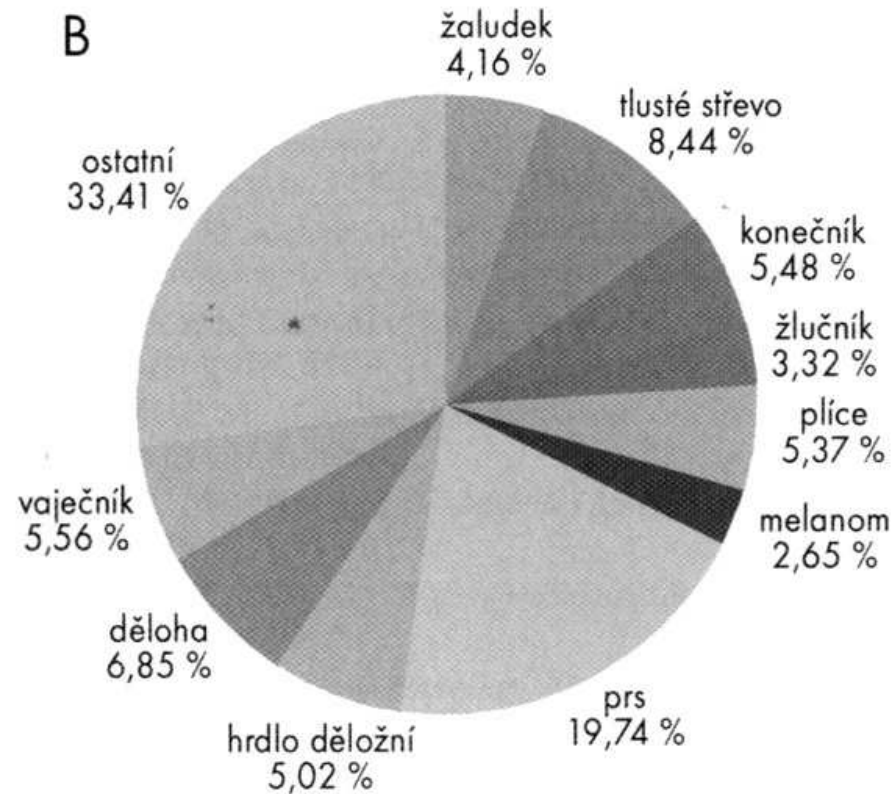
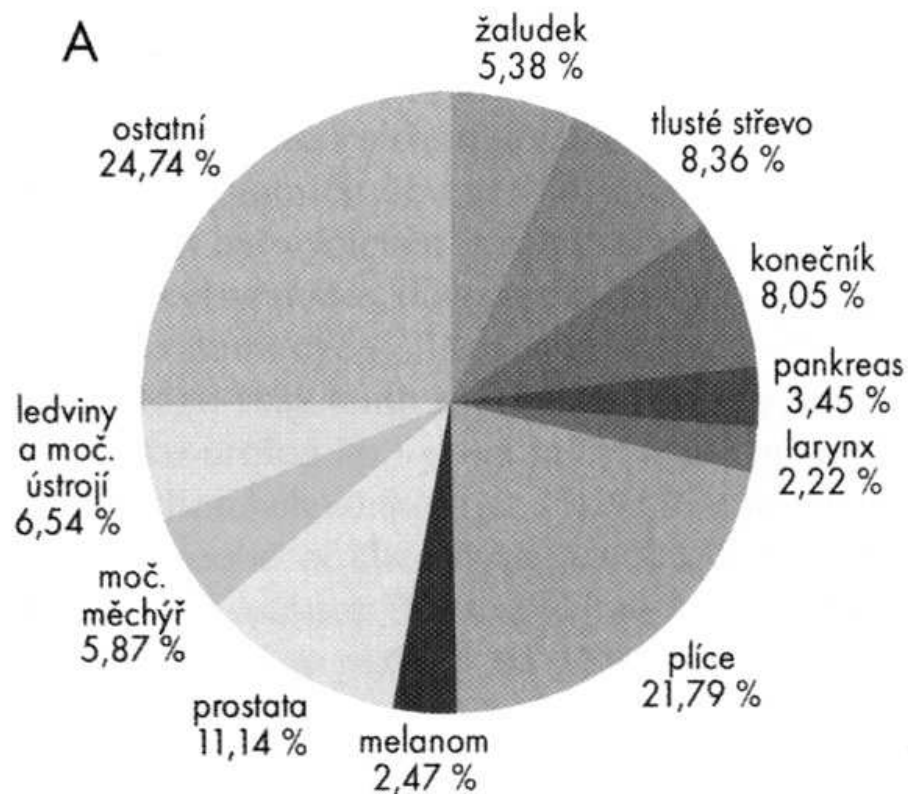

Figure 1 | **Colorectal cancer incidence in males in the European Union.** Rates of colorectal cancer by incidence, per 100,000 people, and mortality during 1996. Data were collected from Eucan — a service that provides data on the incidence and mortality of 24 key cancers in 15 member states of the European Union².

ils
d



Struktura hlášených onemocnění novotvary bez dg. C44. A – muži; B – ženy (podle ÚZIS)

Výskyt kolorektálních nádorů (per 100 000 obyvatel; 1988-1992)

Country	Male	Female
Croatia	17.0	17.7
CzechRepublic	31.7	25.0
Denmark	31.5	32.4
Finland	15.7	18.6
GDR	20.1	24.7
Latvia	13.4	14.7
Sweden	28.6	28.2
UK, Engl.&Wales	27.9	26.9
USA	39.9	29.9

Úmrtnost na kolorektální nádory (per 100 000 obyvatel; 1987-1988)

Country	Male	Female
Australia	26.1	14.2
CzechRepublic	29.4	16.4
Denmark	23.6	17.5
Finland	11.9	8.7
GDR	20.1	15.2
Canada	18.1	12.9
Sweden	14.7	11.2
UK, Engl.&Wales	20.2	14.2
USA	17.2	12.0

STŘEVNÍ EPITEL

Sebeobnovná tkáň s unikátní topologií – dvourozměrná struktura:

Proliferativní krypty a diferencované klky (villi). Jednovrstevná bariera mezi lumen a vnitřním prostředím.

TENKÉ STŘEVO – krypty – dolní část – kmenové a Panethovy buňky, proliferující „transit-amplifying“ diferencující se buňky postupují k vrcholu, klky z diferencovaných buněk na vrcholu se odlupují.

TLUSTÉ STŘEVO – nejsou klky, na dně krypt kmenové buňky (nejsou zde P. buňky), 2/3 krypty proliferující buňky, 1/3 diferencované b. na konci se odlupují do lumenu (apoptóza – anoikis).

2 hlavní linie buněk:

Enterocyty – absorbtivní linie, nejpočetnější

Sekreční linie: goblet buňky (sekretují protektivní muciny – přibývají směrem ke kolonu)

Enteroendokrinní buňky (asi 1%, sekretují hormony – serotonin, sekretin)

Panethovy buňky – jen v t. střevě – sekretují antimikrobiální látky – kontrola mikrob. obsahu ve střevě.

Aktivní migrace buněk doprovázená diferenciací a odlupováním do lumenu
3-5 dní

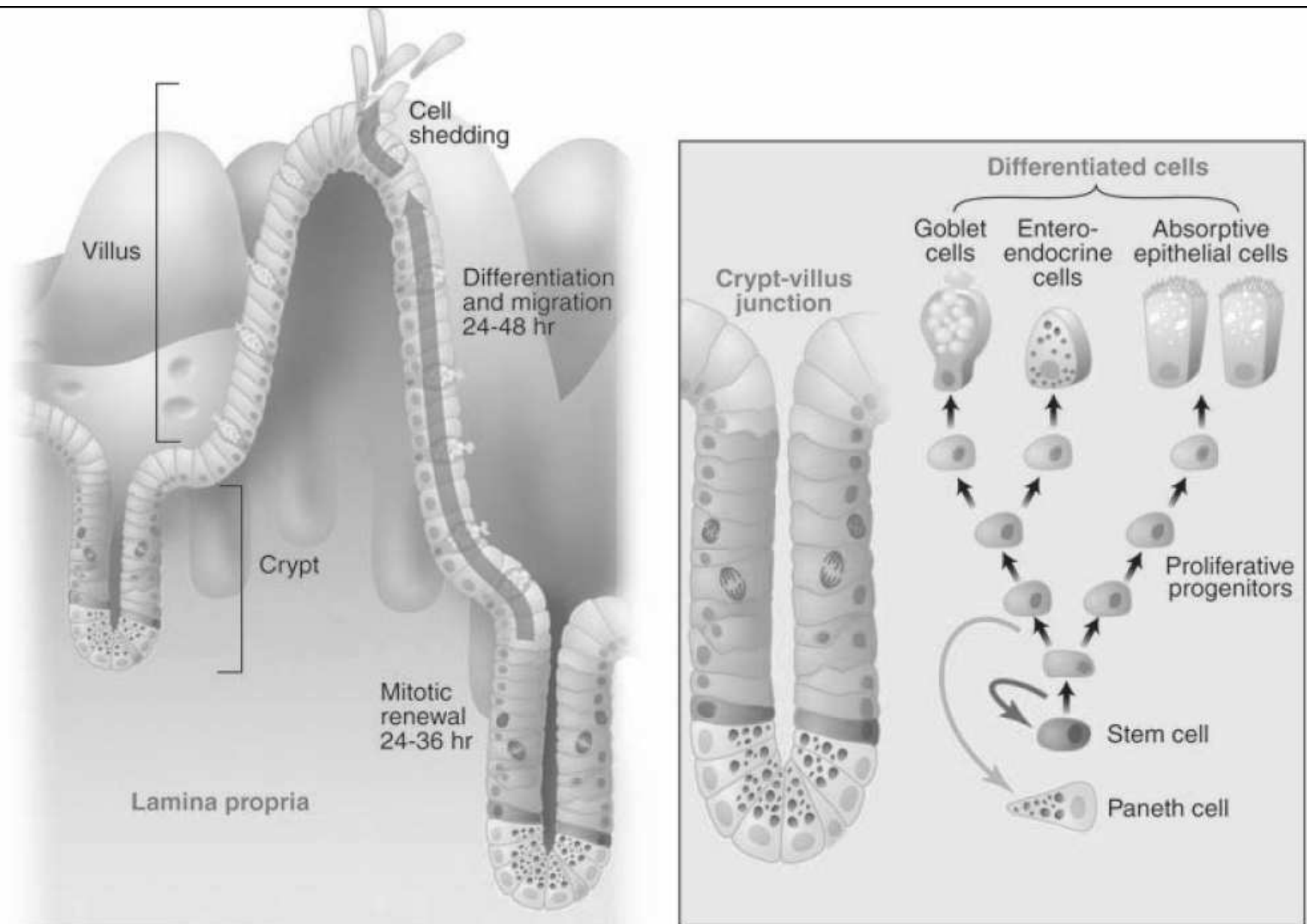

Fig. 1. The anatomy of the small intestinal epithelium. The epithelium is shaped into crypts and villi (left). The lineage scheme (right) depicts the stem cell, the transit-amplifying cells, and the two differentiated branches. The right branch constitutes the enterocyte lineage; the left is the secretory lineage. Relative positions along the crypt-villus axis correspond to the schematic graph of the crypt in the center.

Obnova střevní výstelky

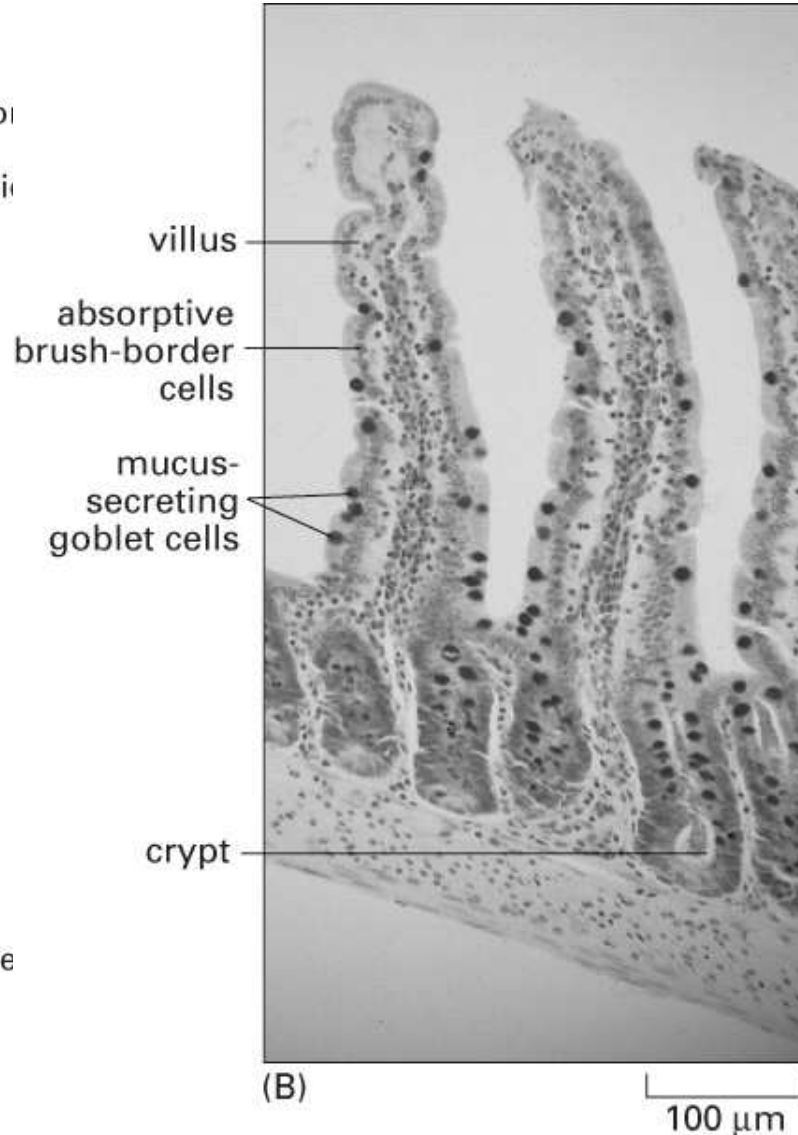
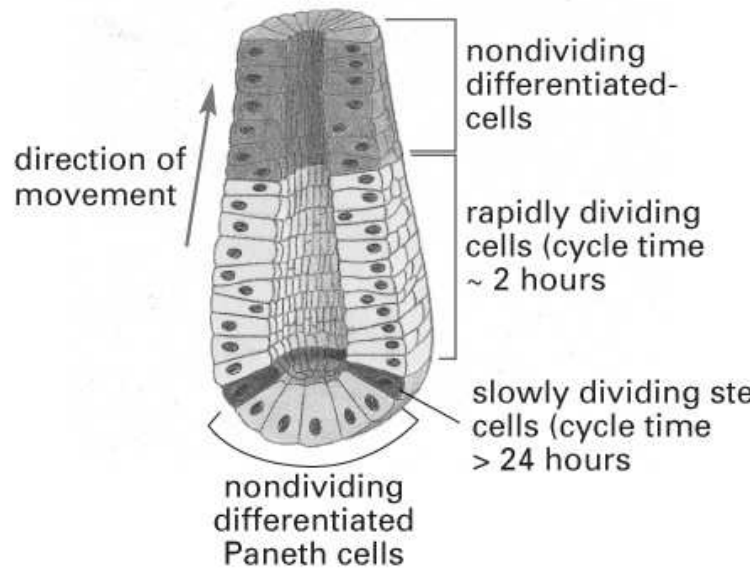
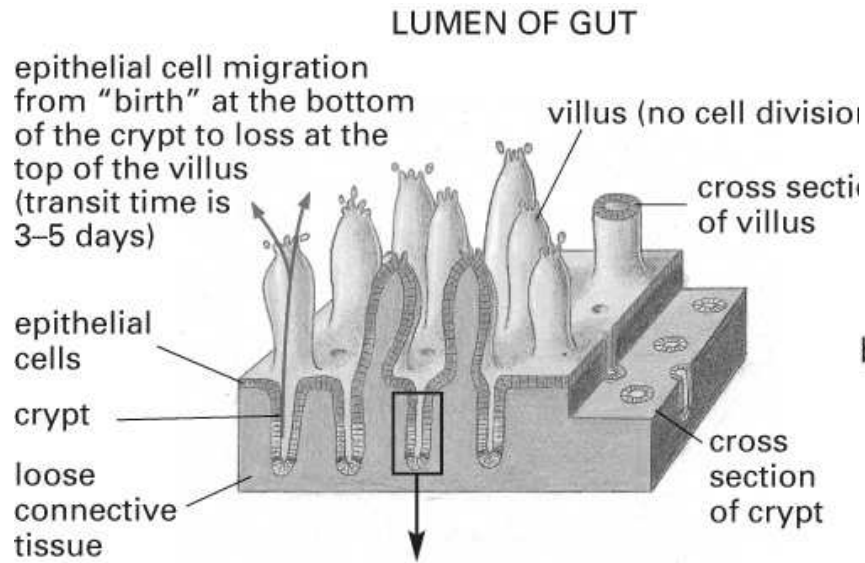

Figure 22-19 part 1 of 2. Molecular Biology of the Cell, 4th Edition

Příčný řez částí stěny střeva

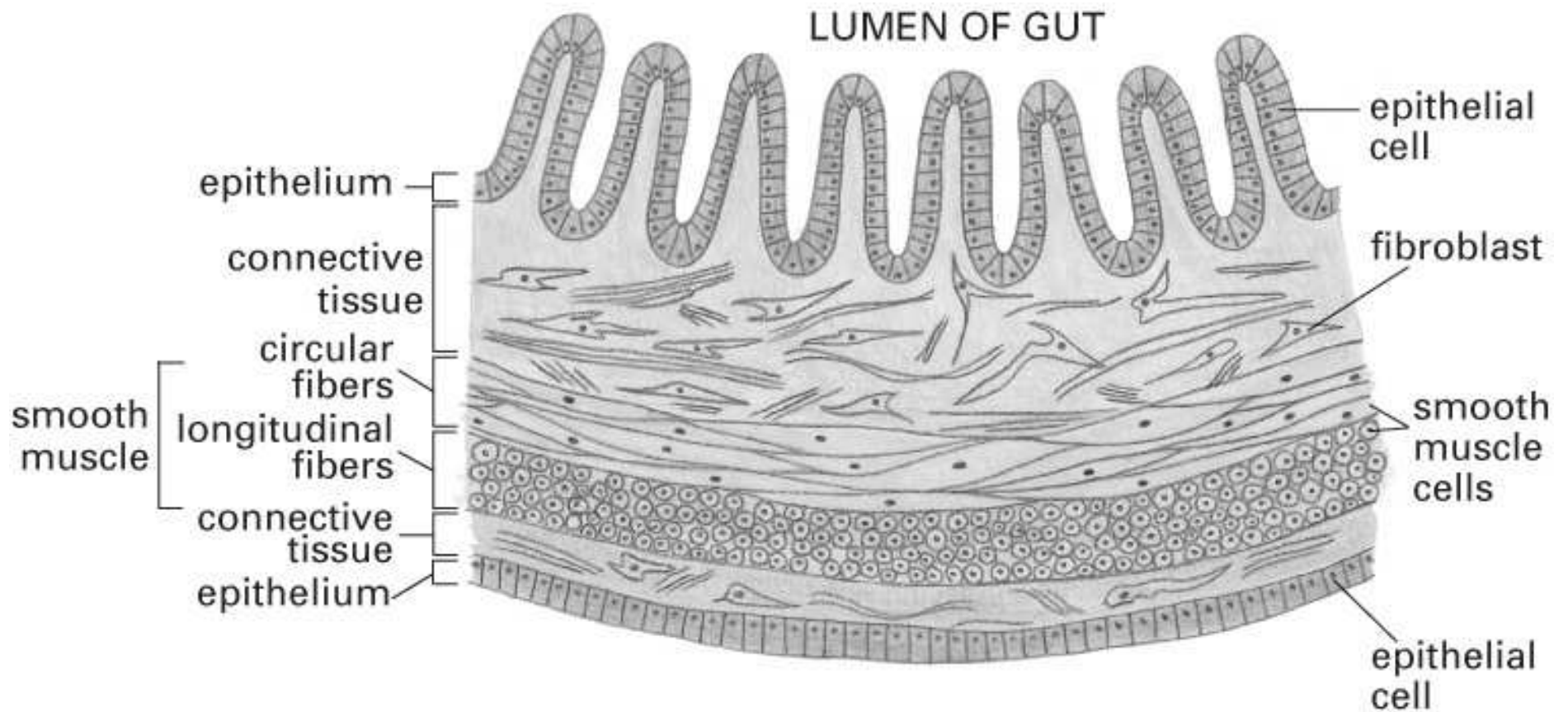

Figure 19-1. Molecular Biology of the Cell, 4th Edition.

Každá tkáň je organizovaným seskupením buněk držených pohromadě buněčnými adhezemi, ECM nebo oběma. Tkáně jsou spojeny dohromady v různých kombinacích a tvoří funkční jednotky - orgány

NÁDORY KOLOREKTA (CRC)

Výskyt

industrializované země (životní styl, výživa)

ČR (třetí nejčastější příčina úmrtí na rakovinu)

věková distribuce (muži nárůst případů od 60 let; ženy od 70 let)

Epitel kolorekta

střevní krypty (část proliferační a diferenciací)

výměna epitelu (zránění buněk, odumírání apoptózou-anoikis
(detachment-induced apoptosis)

koncentrace růstových faktorů v kryptách (v proliferační části více buněk produkujících GF)

Kolorektální karcinogeneze

porušení rovnováhy mezi proliferací a diferenciací v kryptě

hyperproliferativní krypta, adenom, adenokarcinom, karcinom,
metastázy

a Incidence rates of colorectal cancer



b Estimated red-meat consumption (grammes/day)

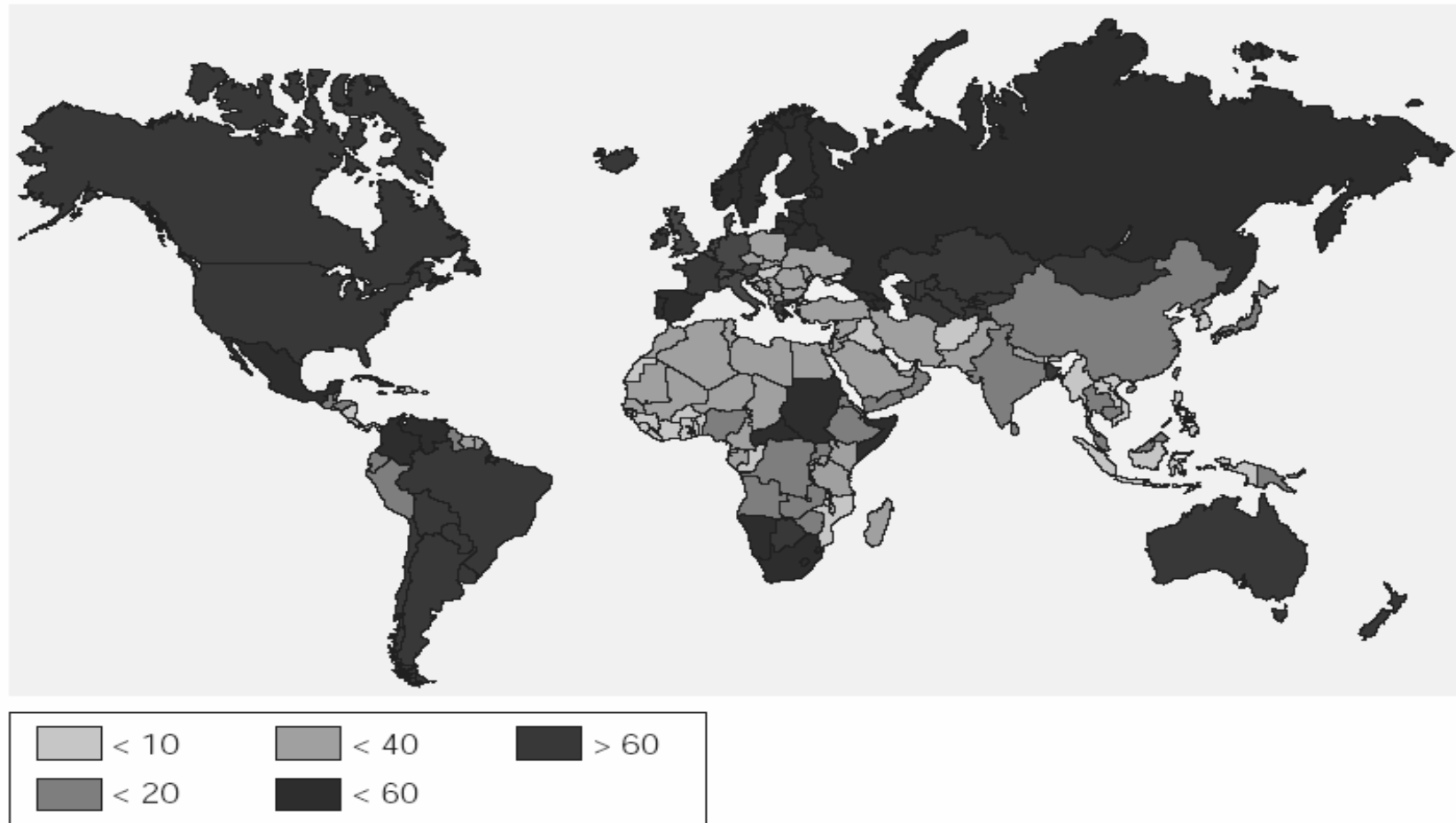

Figure 5 | **Colorectal cancer incidence and red-meat consumption worldwide in men.**
a / Countries with a high incidence of colon cancer (cases per 100,000 people) are indicated with blue (North America, Australia); countries with moderate levels in pink or red; and countries with low incidence in green (Asia, Africa). Colon cancer incidence is correlated with red-meat intake.
b | Countries that consume the most red meat, in g/day, are indicated in blue (North and South America, Australia); countries with moderate levels of consumption in pink or red; and countries with the lowest levels of red-meat intake in green (Africa, Asia). Figure adapted with permission from Ref. 1 © (2003) IARC Press.

Podélný řez kryptou tenkého střeva

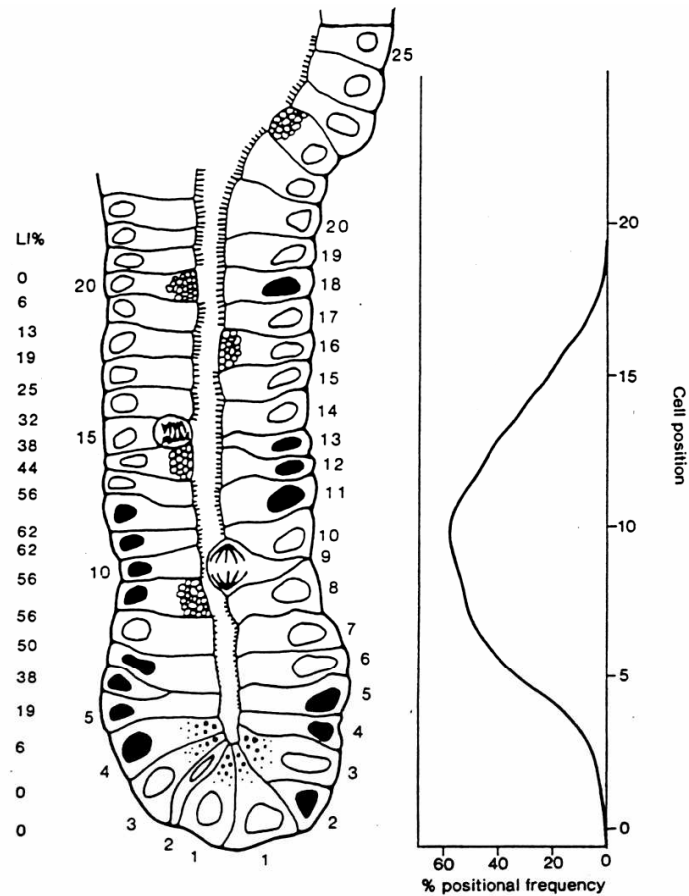
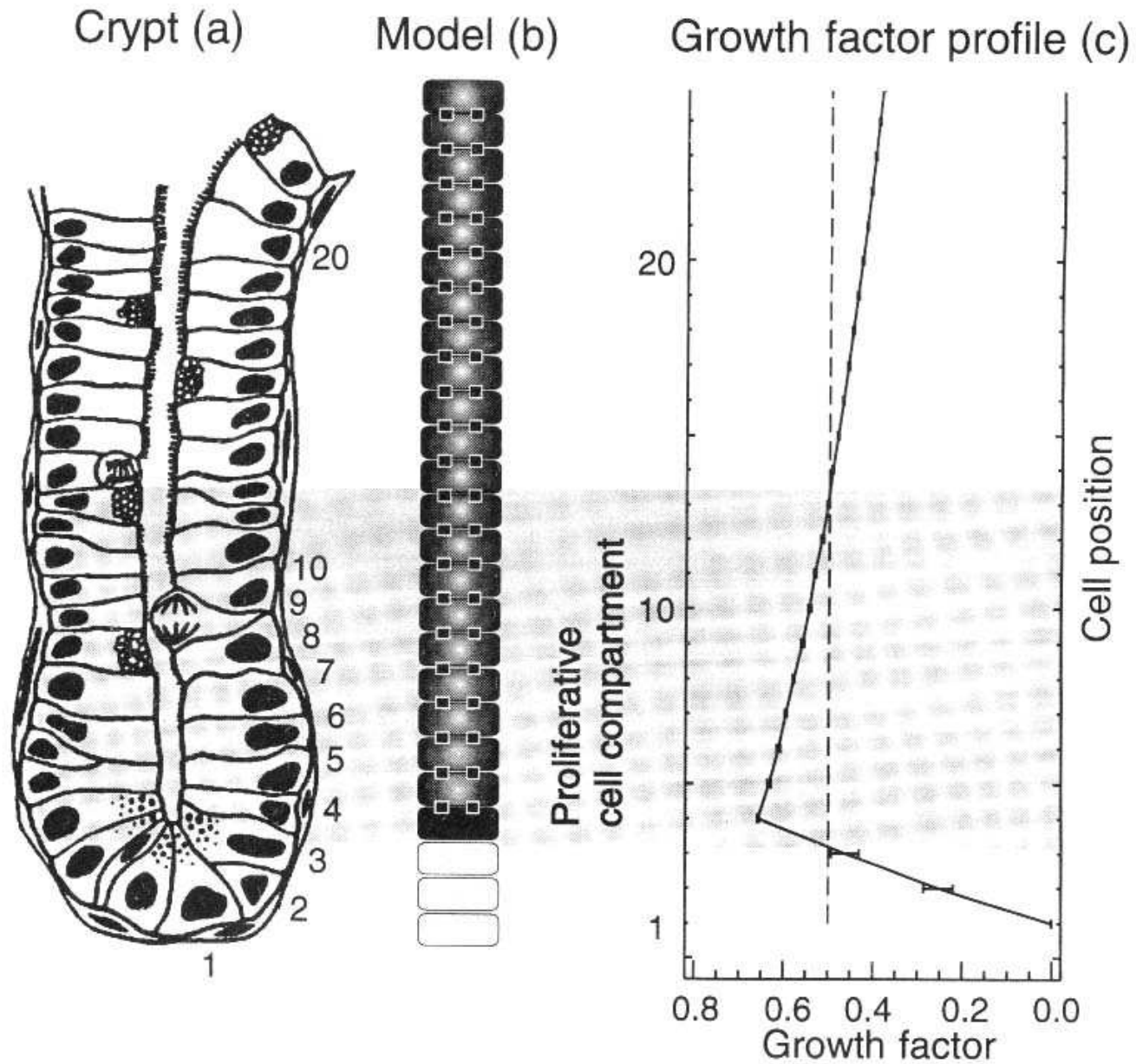
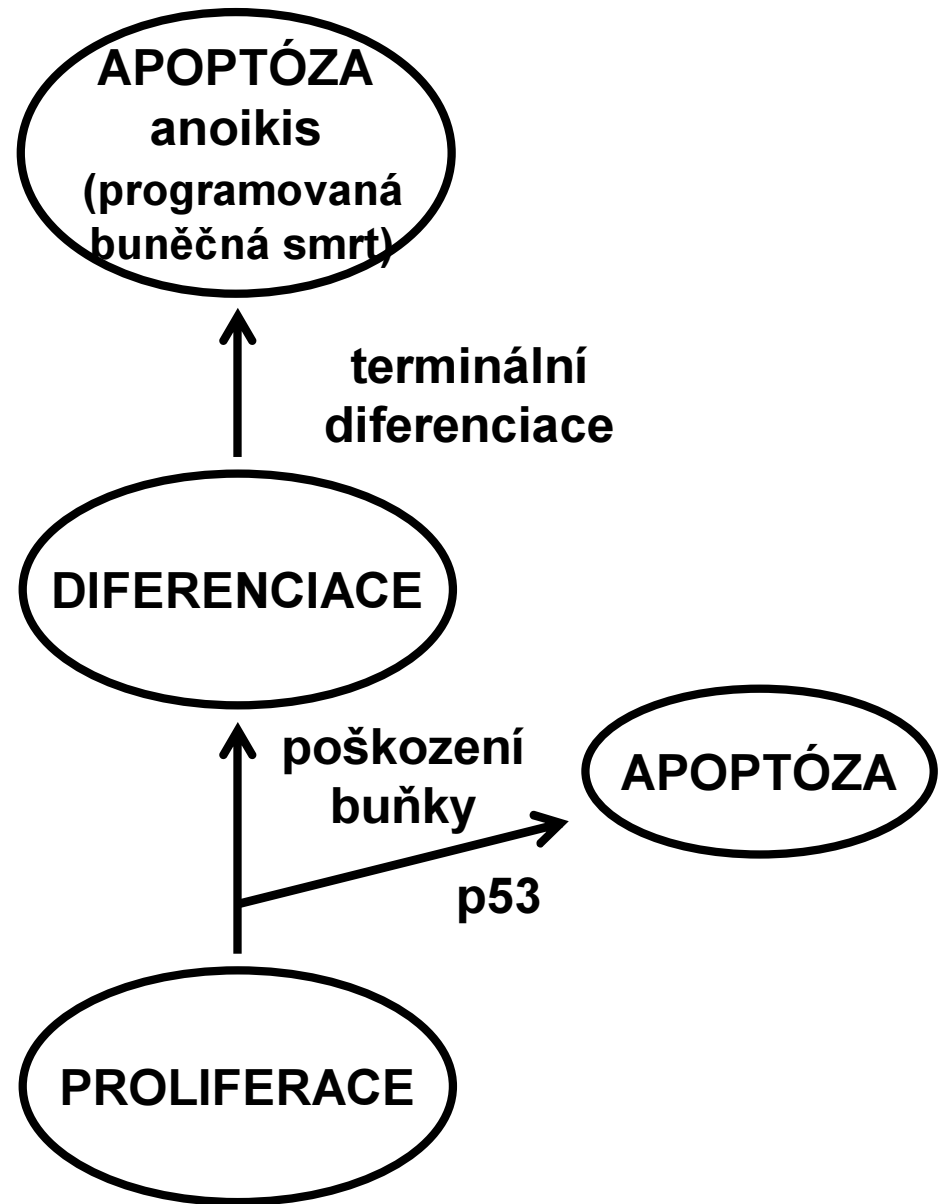
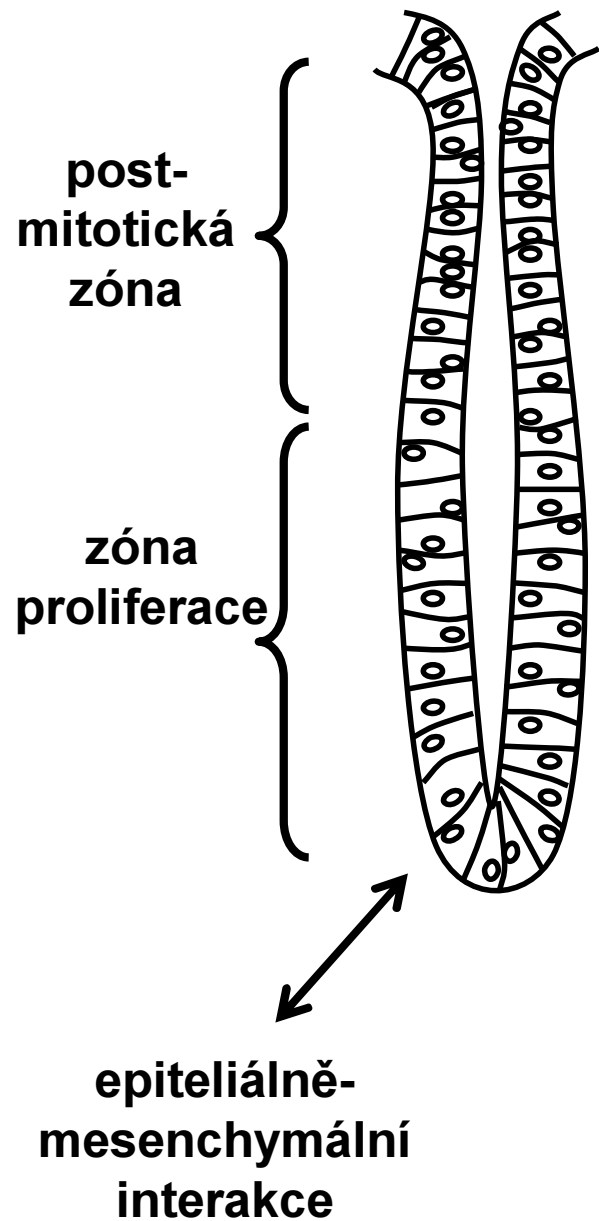

Fig. 5. Diagram showing a longitudinal section through a small intestinal crypt illustrating how the cell positions are numbered from the base. The diagram shows a typical distribution for the DNA synthesising (S-phase) cells in the crypt (shaded nuclei). An actual set of experimental data are illustrated (left) together with a labelling index frequency plot where labelling index as a percentage is plotted against cell position. This approach can be used to measure any parameter associated with crypt cells including the distribution of dead or dying apoptotic cells. These cell positional distributions are commonly presented with the frequency plotted on the vertical scale and cell position plotted on the horizontal scale with the base of the crypt on the left.

Střevní krypta a profil růstových faktorů





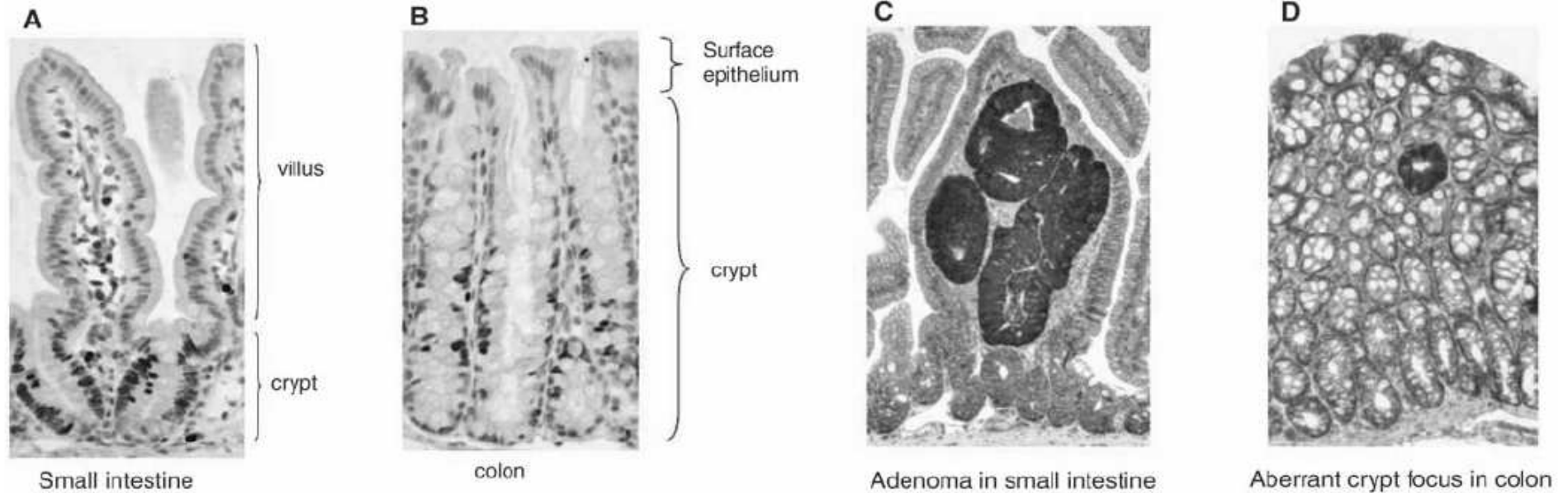
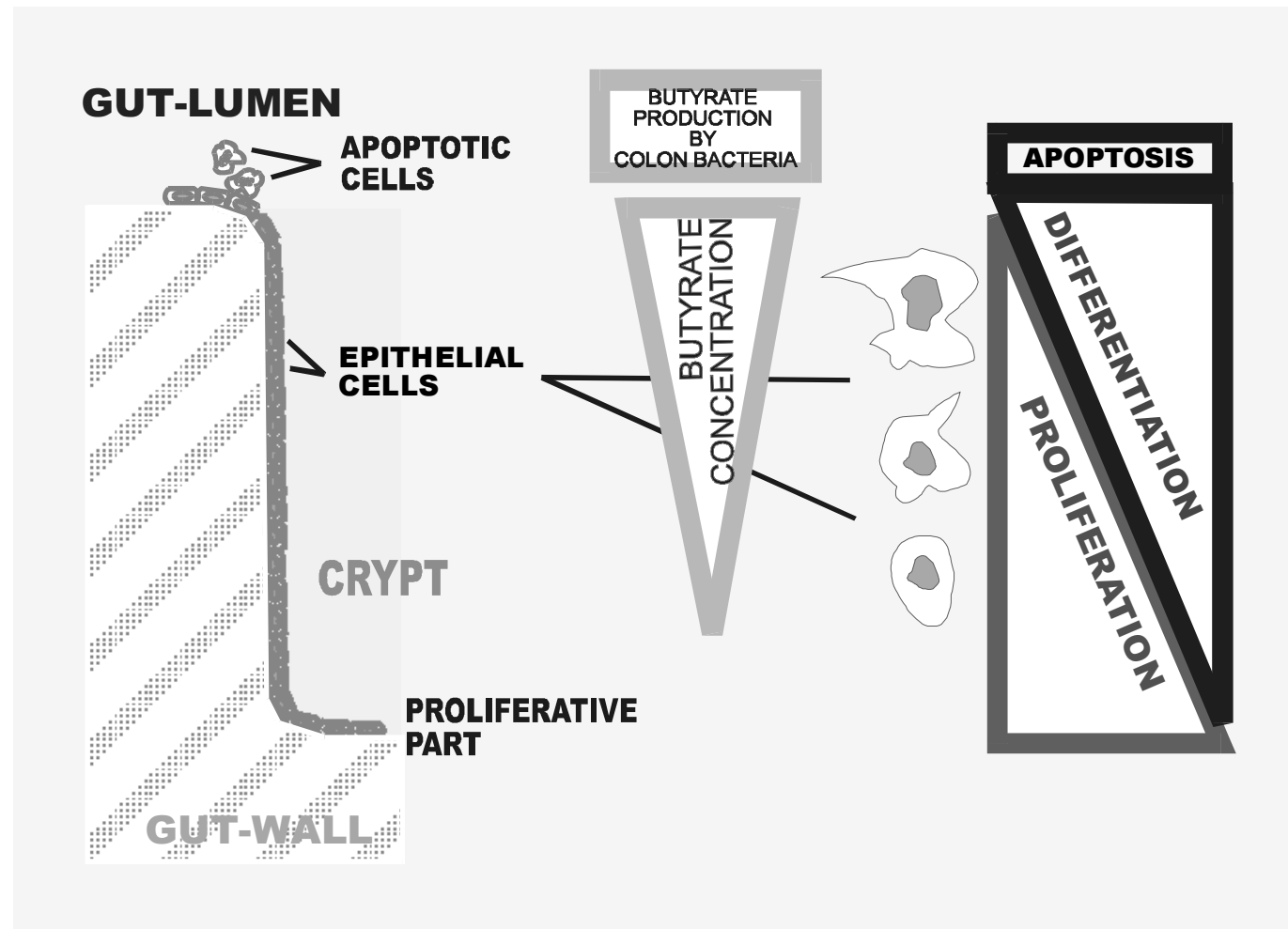

Fig. 2. Comparison of normal epithelium and adenomas in murine small intestine and colon. (A) Small intestinal crypt and villus. (B) Colonic crypt and surface epithelium. Proliferative cells are stained for the cell cycle marker Ki67 (brown nuclei) in (A) and (B). (C) An adenoma residing inside a villus of the small intestine of a *min* mouse. (D) A small

aberrant crypt focus in the colon of a *min* mouse. (C) and (D) are stained for β -catenin. Note the presence of β -catenin (in brown) in the cell boundaries of all nondiseased epithelial cells and the accumulation of β -catenin throughout the cells in the adenoma and aberrant crypt focus.

In vivo progression of colon epithelial cells



BIRTH OF AN EPITHELIAL CANCER



PROLIFERATION.

An initial mutation in a single cell (highlighted) disrupts signal transduction or the cell cycle, and the errant cell divides more frequently than its neighbors. The changed cell and its descendants constitute dysplasia, a pre-cancerous growth whose cells are still differentiated and confined to the bottom cell layer.

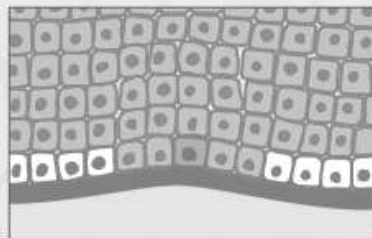

Time passes.

A second mutation occurs in an already affected cell, ushering in sweeping changes in gene expression that modify metabolism, growth characteristics, and cell shape, as adhesion and anchorage slip. The doubly mutant cell and its descendants are slightly less specialized than their neighbors.

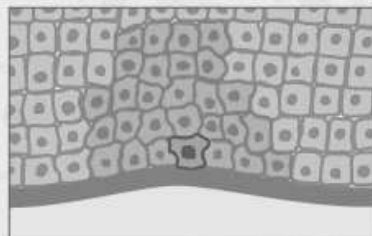

Further escape from growth constraints, caused by a third mutation, perturbs the cell cycle in a different way, allowing rapid expansion of the growth. As mitotic activity jumps, specializations continue to fade away as new cells form. Their nuclei appear enlarged and misshapen, reflecting the chaos within.

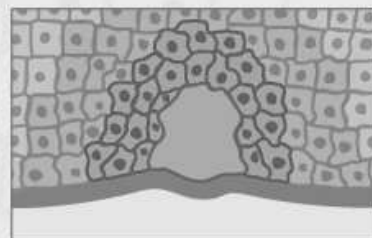

With still more mutations, the increasingly aggressive growth is now a misshapen, if still microscopic, mass. Yet it remains contained within the epithelium bounded by the basement membrane. The tiny tumor may remain here, as in situ carcinoma, for years. The abnormal cells now occupy all cell levels, and all are de-differentiated to some degree.

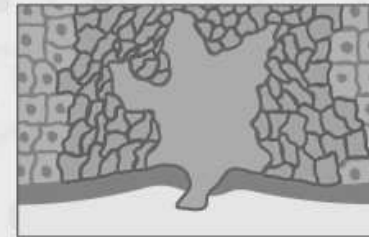

INVASION.

As the dividing cancer cells extend through the basement membrane into the surrounding stroma, malignancy begins. The tumor and stroma communicate, as the cancer locally takes over. Meanwhile, cancer cells secrete fibroblast growth factor and vascular endothelial growth factor, which subvert normal angiogenesis to recruit capillaries, which snake in and around the tumor.

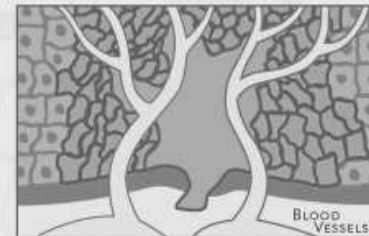

Some cancer cells creep along the associated blood vessels; others squeeze between the lining cells to enter the circulation.

Spread begins.

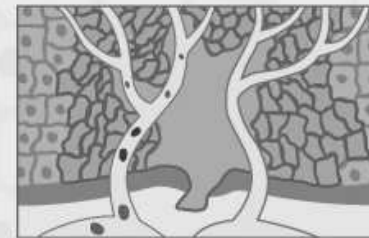

METASTASIS.

Supplied with nutrients, oxygen, a waste removal service and conduits, ferocious cancer cells exit and home to lymph nodes and more distant sites, the trajectory characteristic of tumor type: kidney or breast to lung; prostate to bone. Here, further mutations and changes in gene expression ensue, often rendering the original tumor's offspring so different that treatments that once worked now fail.

Kolorektální nádory vznikají progresivní akumulací genetických a epigenetických změn vedoucích k transformaci normálního střevního epitelu do adenokarcinomu.

Molekulární mechanismy kontrolující homeostázu jsou terčem změn podílejících se na vzniku nádorů.

Molekulárně genetické poznatky

- ▶ Mnohastupňová progresse na molekulární i morfologické úrovni.
- ▶ Genetické (mutační aktivace onkogenů a inaktivace nádorově supresorových genů) a epigenetické změny (metylace) podporují tvorbu nádoru poskytující klonální růstovou výhodu změněným buňkám.
- ▶ Klíčovým molekulárním krokem je ztráta genomové stability.
- ▶ Dědičné nádorové syndromy často odpovídají formám klíčových genetických defektů u zárodečných linií, jejichž somatický výskyt nastartuje sporadické nádory kolonu.

Ztráta genomové stability je klíčovým molekulárním a patogenetickým krokem vyskytujícím se na počátku nádorového procesu a vytváří permissivní prostředí pro výskyt změn onkogenů a nádorově supresorových genů.

3 hlavní formy:

- ▶ Nestabilita mikrosatelitů (MSI)
- ▶ Nestabilita chromozómů (CIN) - zisk či ztráta úseků chromozómů, aneuploidie)
- ▶ Chromozomální translokace

Dědičné poruchy predisponující jedince k nádorům autozomálně dominantní typ dědičnosti

► polypózní formy (familiární adenomatózní polypóza - FAP) asi 1%

mutace APC (adenomatous polyposis coli) genu
tisíce adenomatózních polypů ve střevě – riziko vzniku nádoru
téměř 100%.

APC gen

► nepolypózní formy (heredit. nepolyp. kolorektální karcinom – HNPCC), Lynch syndrom

asi 15%, zvýšené riziko dalších typů nádorů, mutace genů pro MMR enzymy (mismatch DNA repair), množství mutací v repetitivních sekvencích DNA - mikrosatelitech

Stádia vývoje nádoru epitelu děložního krčku

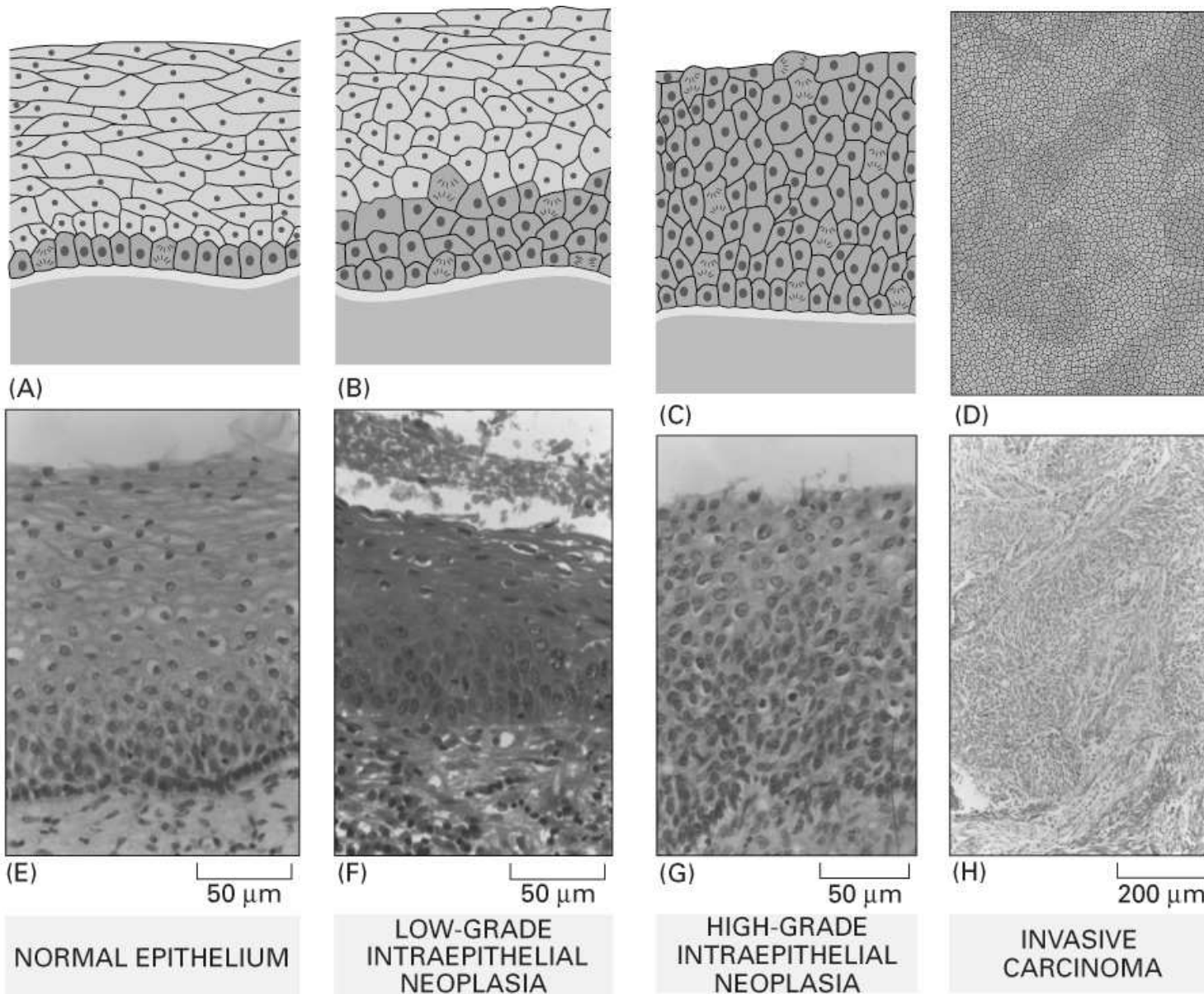

Figure 23-9 part 2 of 2. Molecular Biology of the Cell, 4th Edition.

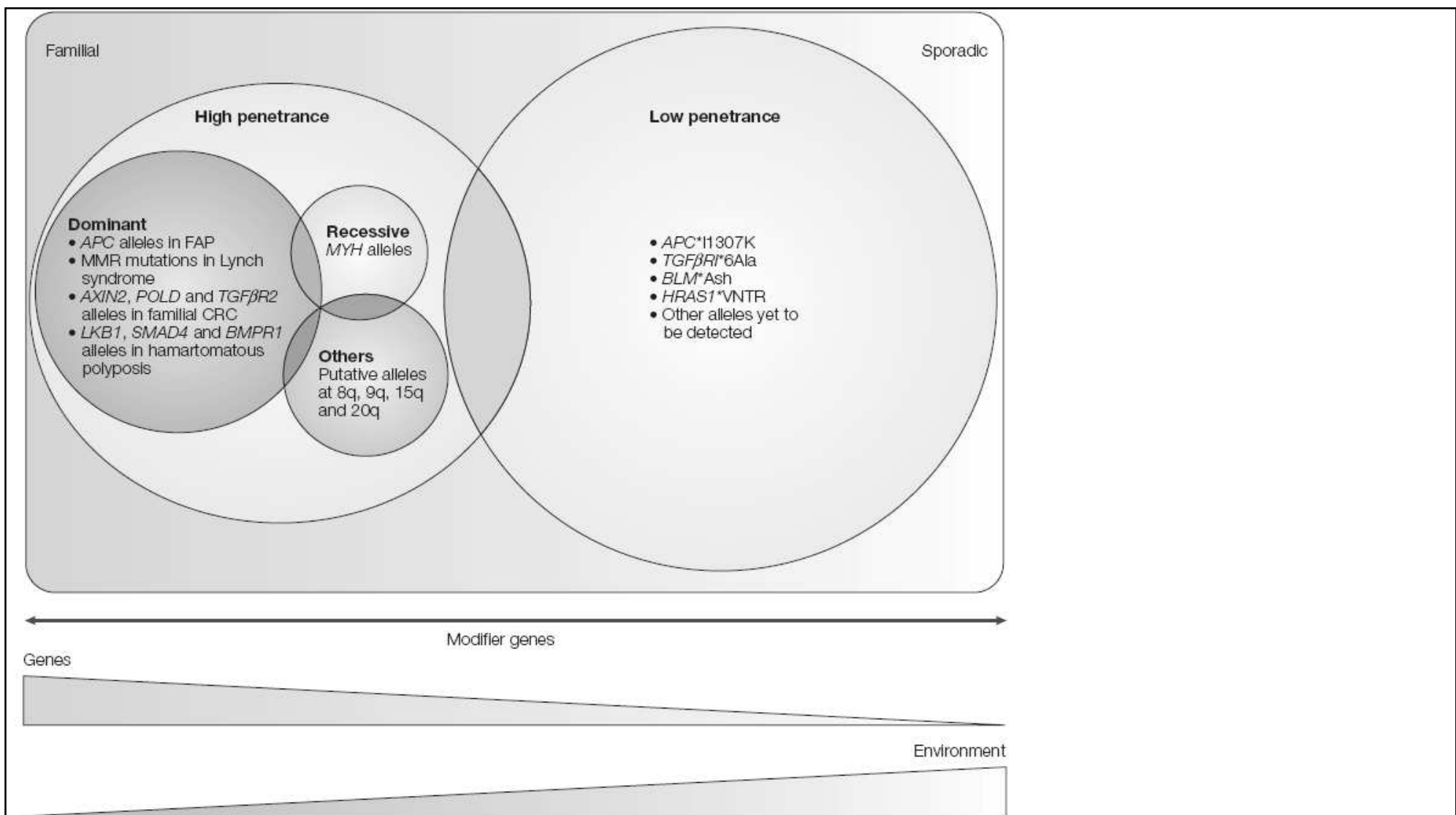

Figure 1 | **A global view of the genetic contribution to colorectal cancer.** The highly penetrant causative mutations in familial adenomatous polyposis (FAP), Lynch syndrome, the hamartomatous polyposis syndromes and other familial conditions underlie cases of colorectal cancer (CRC) that have a strong hereditary component, with little environmental influence. However, there are also several low-penetrance mutations that contribute to CRC susceptibility in an additive way, involving interactions between genes and with environmental factors. As well as accounting for cases of hereditary CRC, these mutations are also likely to contribute to cases of CRC that are classified as 'sporadic'. In addition, although none has been identified so far, modifier genes are also likely to influence the effects of genetic and environmental factors that contribute to CRC. Therefore, the distinction between 'sporadic' and 'familial' cases and between 'genetic' and 'environmental' predisposing factors has become blurred and might be better thought of as a continuum of risks contributing to CRC development. *APC*, adenomatous polyposis coli; *BLM*, Bloom syndrome; MMR, mismatch repair; *TGFβR2*, transforming growth factor-β receptor 2

Table 1 | **Heritability of selected cancers**

Cancer type	Study 1 family risk ratios*	Study 2 family risk ratios*	Proportion of variance due to heritable factors‡
Testicular	8.57	8.50	ND
Thyroid	8.48	12.42	ND
Laryngeal	8.00	ND	ND
Multiple myeloma	4.29	5.62	ND
Lung	2.55	3.16	0.26
Colorectal	2.54	4.41	0.35
Kidney	2.46	5.26	ND
Prostate	2.21	9.41	0.42
Melanoma	2.10	3.41	ND
Breast	1.83	2.01	0.27

*The ratios shown here were in part recalculated by Risch⁹⁷. Study 1 was carried out in Utah⁹⁸. Ratios are based on all first-degree relatives; first-degree relatives of 35,228 probands with cancer were studied. Study 2 was carried out in Sweden⁹⁹. Ratios are based on siblings; data comprised from 435,000 parents with cancer who had 5,520,756 offspring, 71,424 of whom had cancer.

‡Based on a twin study comprising 44,788 pairs¹⁰⁰. ND, not determined.

Sporadická forma nádorů kolonu – nedědičná, postupný vývoj řadu let

Na vzniku se podílí rovněž vnější faktory (dieta, životní styl)

Pozitivní korelace – spotřeba tuku, červeného masa, alkohol, kouření

Negativní korelace – zelenina, ovoce, vláknina, NSAIDs

Rodinný výskyt „sporadického“ kolorektálního karcinomu – kombinace genetických predispozic se zevními faktory

Potřeba pravidelných vyšetření od určitého věku (okultní krev, sigmoidoskopie, kolonoskopie)

Funkce APC (adenomatous polyposis coli) proteinu

300kD cytoplasmatický protein kódovaný APC genem – často mutovaný v prvotních stádiích CRC (u adenomů)

APC interaguje s řadou bun. proteinů a drah a přispívá tak k regulaci diferenciaci, migrace, proliferace a adheze. Jeho mutace tak ovlivňuje všechny tyto procesy.

- ▶ Regulace signálu indukovaného beta-keninem (regulace Wnt dráhy)
- ▶ Regulace buněčné adheze prostřednictvím beta-keninu a E-kadherinu
- ▶ Regulace migrace buněk interakcemi s mikrotubuly a F-aktinem
- ▶ Blok buněčného cyklu zřejmě přímou inhibicí jeho komponent

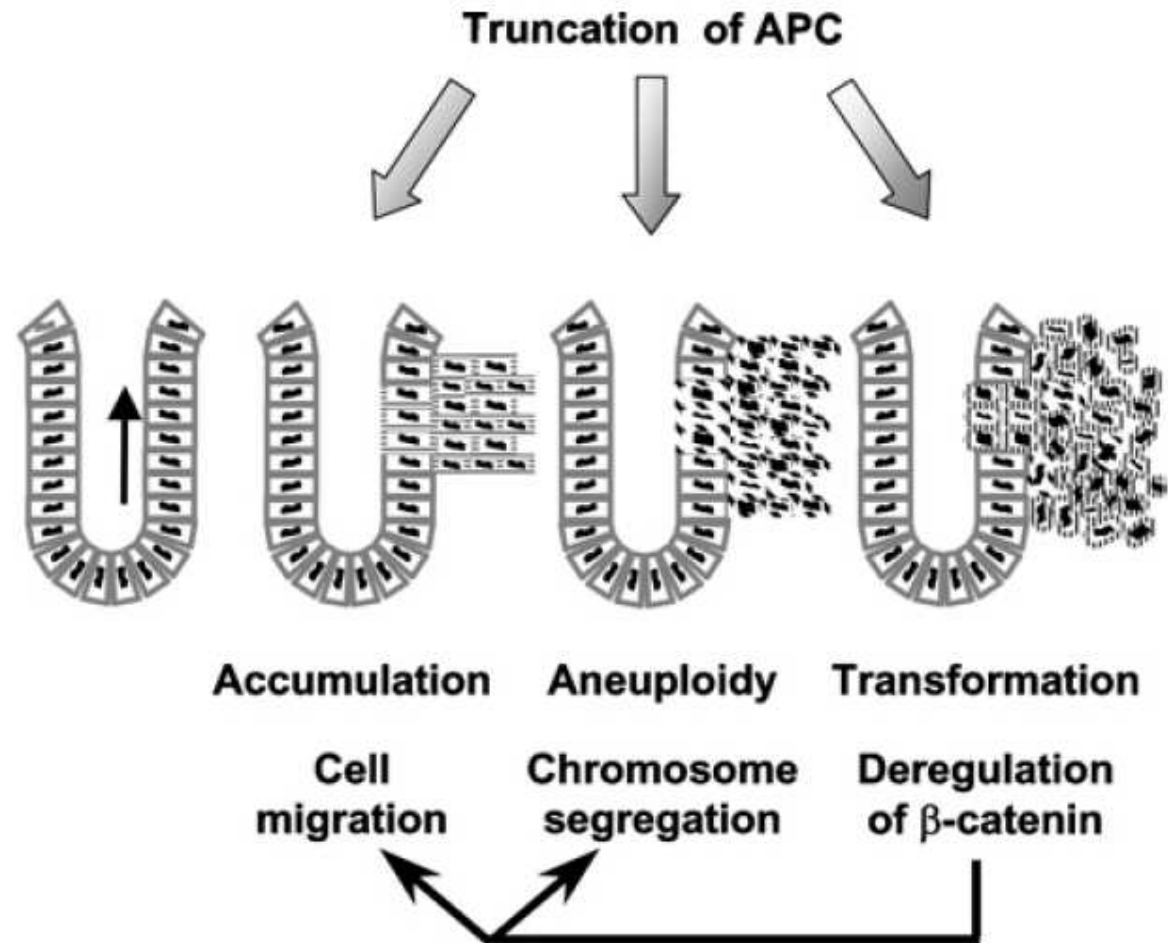

Figure 1 | Truncation mutations in APC affect cytoskeletal organization and the deregulation of β -catenin

The resulting cytoskeletal changes lead to defects in cell migration and compromised mitotic spindles. This causes the inappropriate accumulation of tissue and also leads to aneuploidy. Deregulation of β -catenin leads to defects in differentiation and gene expression, causing transformation. Elevated levels of β -catenin in cells leads to a reduction in the ability of APC to bind microtubules and perform its function as a cytoskeletal regulator. This could contribute indirectly to defects in cell migration and chromosome segregation.

Geny zahrnuté v kolorektální karcinogenezi

- **Onkogeny** (ras, c-myc, c-myb, hst-1, trk, c-raf, c-src, c-myb, Her2-neu)
- Proteiny H-ras, K-ras, N-ras aktivované přes receptory spojené s G proteiny a s tyrosin kinázami – aktivace drah kináz RAF, MEK, MAPK – přechod adenom - karcinom
- **Nádorově supresorové geny**
 - p53 – mutace či delece u 70-80% nádorů, poruchy apoptózy,
 - APC – delece či mutace, brzký děj u adenomů 80%, spojené s deregulací signální dráhy Wnt a chromosomální nestabilitou. Chyby spojení mikrotubulů a kinetochoru – abnormální segregace chromosomů - polyploidie
 - DCC – deletovaný gen u 70-80% nádorů, úloha v zástavě G2/M a apoptóze
- **Geny reparace DNA** – MMR mismatch repair (hMSH2, hMLH1)

Genetický model kolorektální karcinogeneze

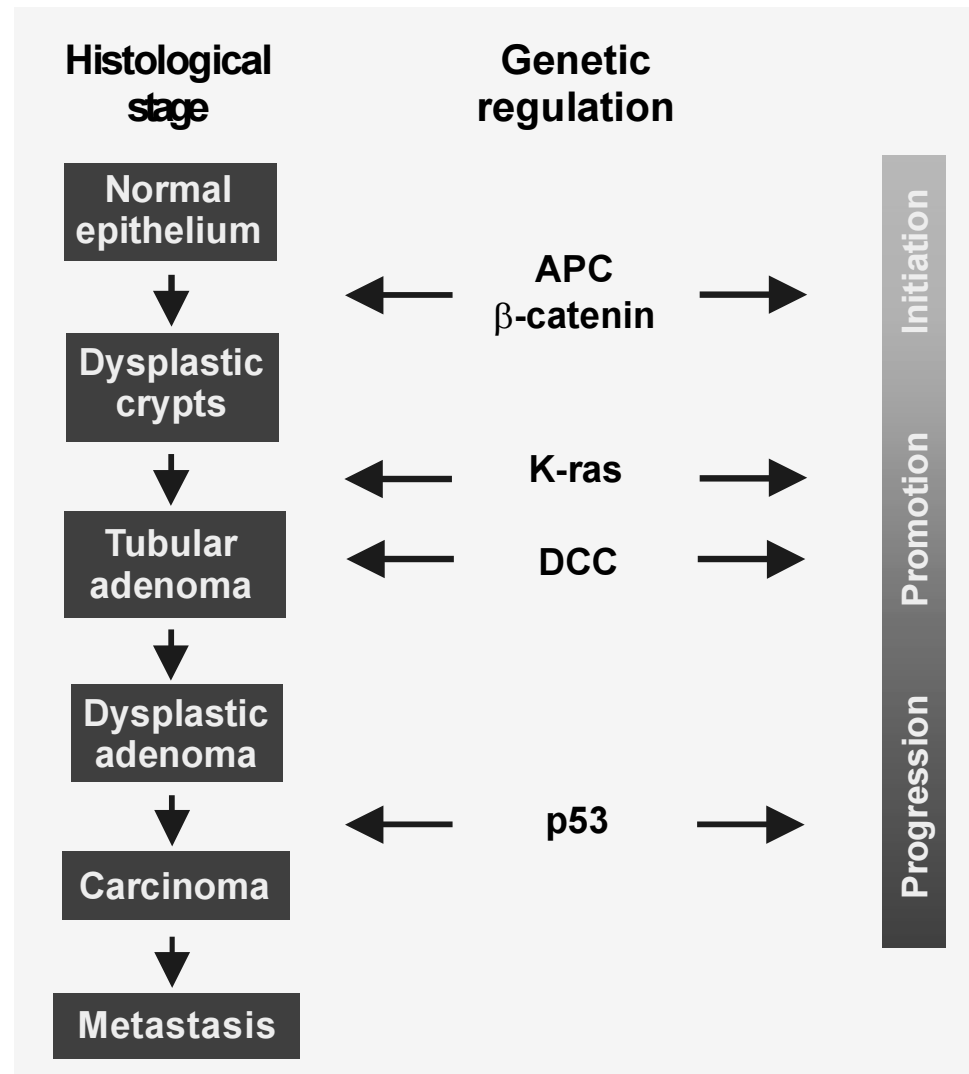

Reproduced from Sharma *et al.*, *Eur. J. Cancer* 2001

Genetické změny spojené s kolorektální karcinogenezí

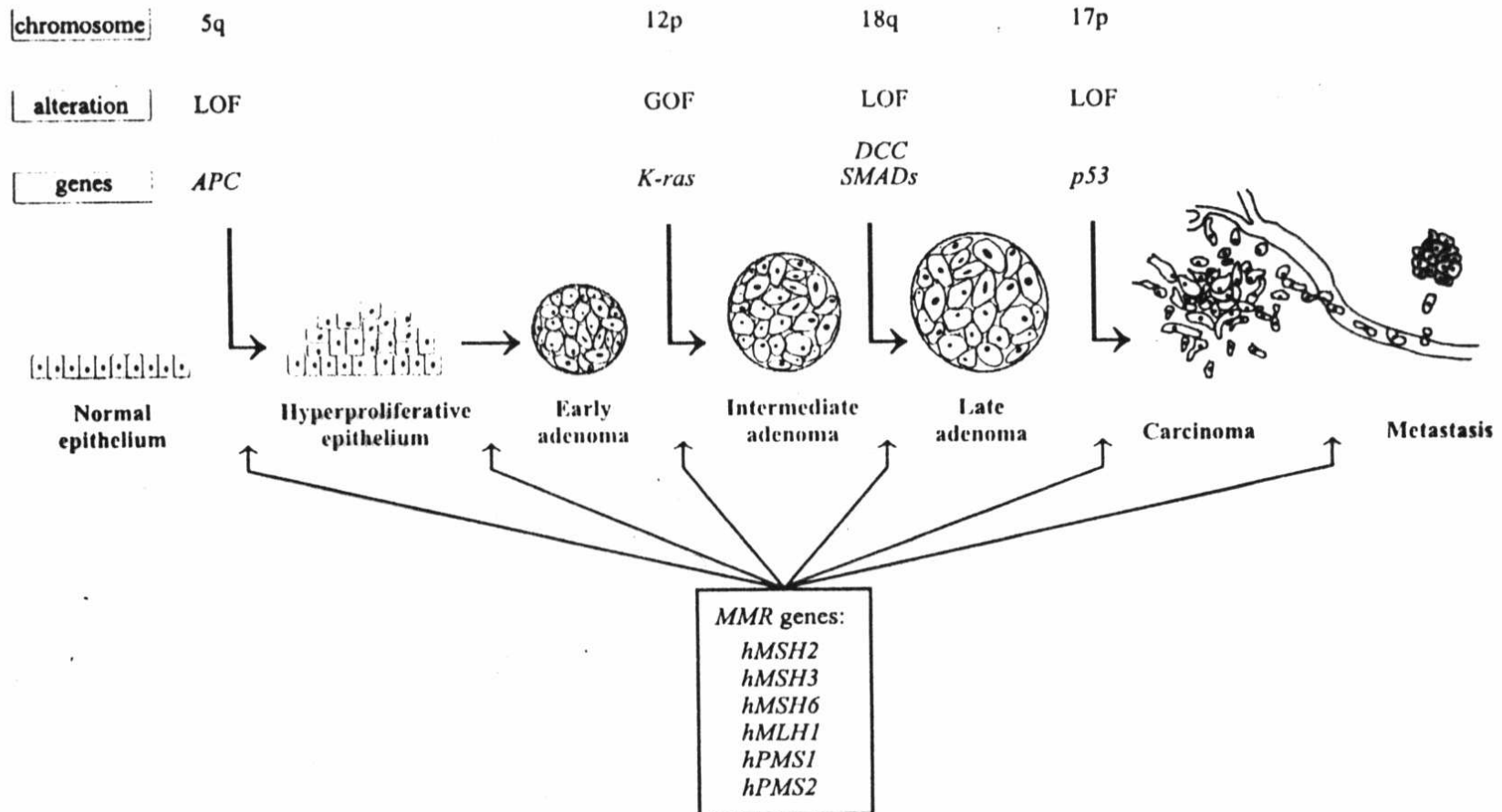

Fig. 1. Genetic changes associated with colorectal tumorigenesis. This process is accelerated by MMR deficiency (see text for details). Abbreviations: LOF, loss of function; GOF, gain of function; MMR, mismatch repair. Reproduced from Kinzler & Vogelstein (2) with modifications.

The Chromosomal Instability Pathway

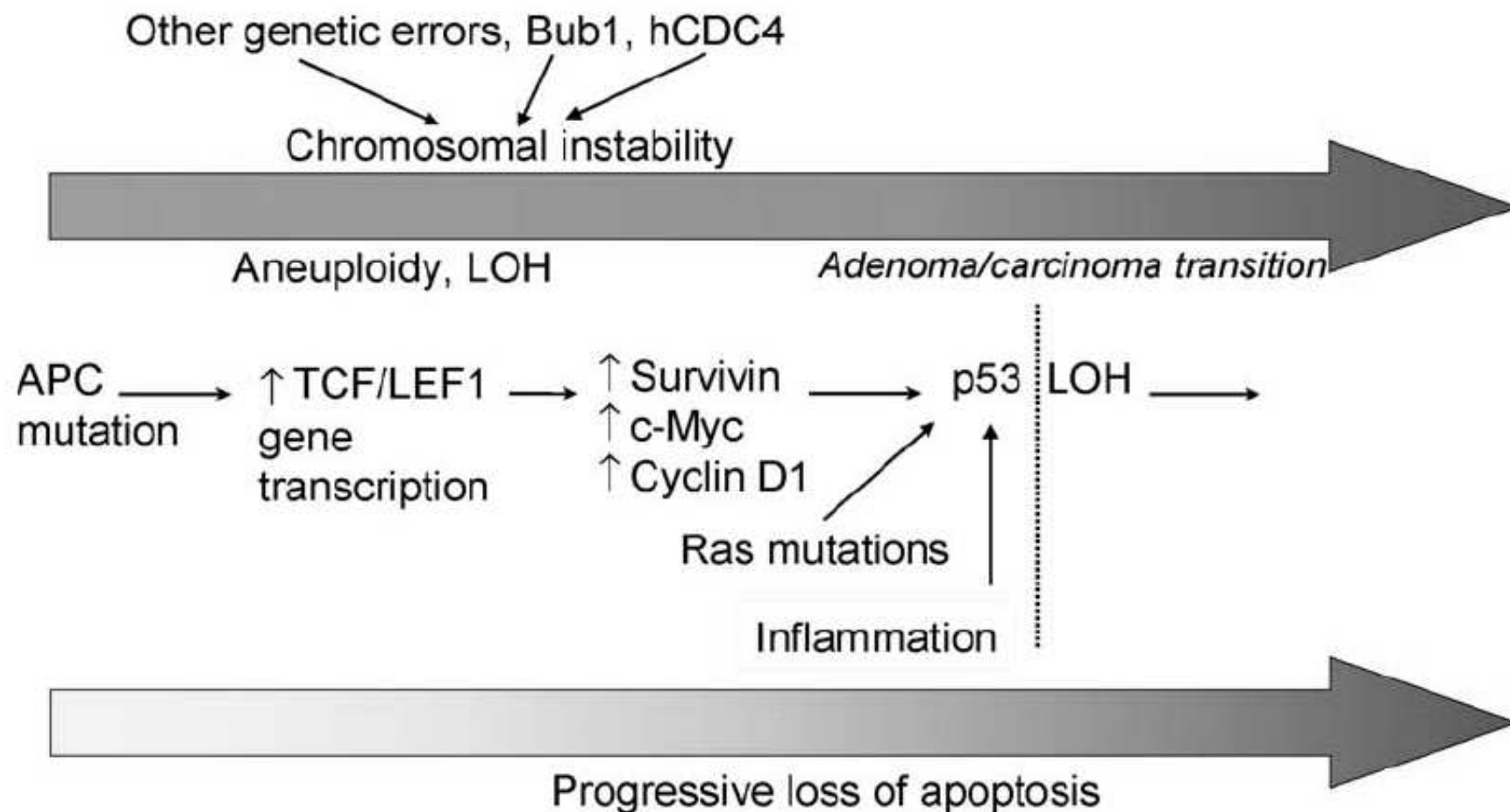

Fig. 2. The chromosomal instability pathway to colorectal cancer.

Mitogenní signál přenášený Ras proteiny

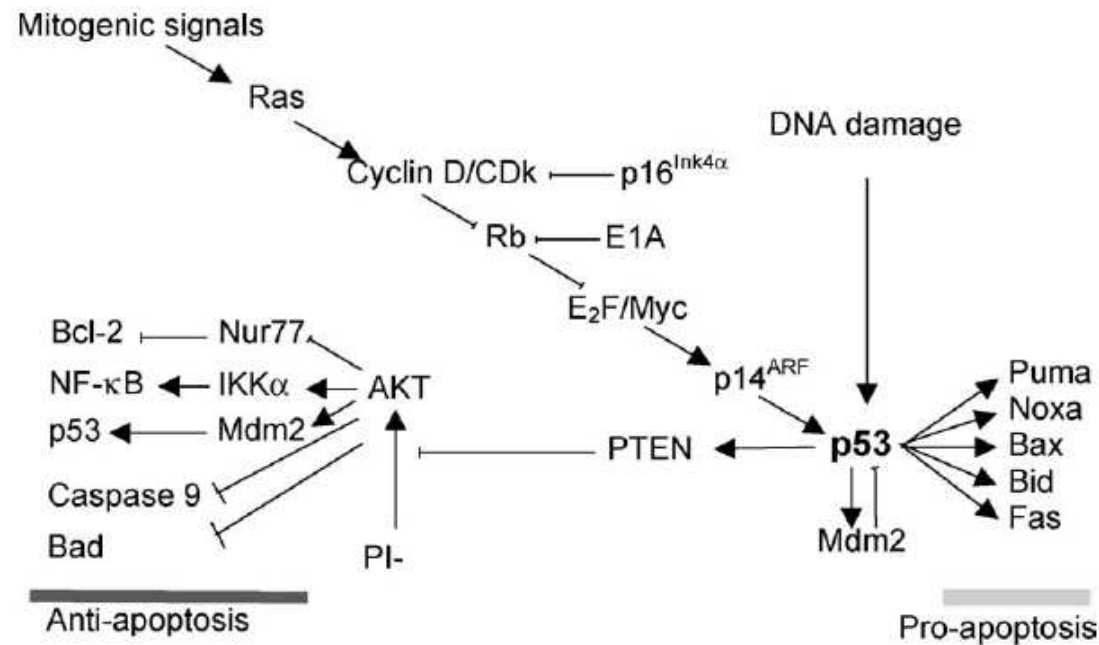

Fig. 3. Mitogenic signals are transduced by Ras which inhibits the retinoblastoma (Rb) protein allowing E2F and Myc to promote cell cycle progression. p16^{INK4a} is a tumour suppressor whose mutation permits cyclin D dependent kinase (CDK) to inhibit Rb. High levels of E2F or Myc activates p14^{ARF} and thereby p53 which has multiple outputs. A series of proapoptotic bcl-2 family members are stimulated and via PTEN the antiapoptotic actions of AKT are inhibited. Note that p53 can still respond to DNA damage, and therefore chemotherapy, if the Ras/Rb pathway is disabled.

Interakce buněk kolonových krypt s látkami vznikajícími v krvi nebo v lumenu

- ▶ Mutace APC (adenomatous polyposis coli gene) v kmenových buňkách jako výsledek působení látek z krve nebo zárodečné mutace, produkuje abnormality v buněčné proliferaci, migraci a adhezi
- ▶ Abnormální buňky se akumulují na vrcholu krypt, tvoří se aberantní fokusy krypt (ACF), které vyčnívají do proudu stolice
- ▶ Zvyšuje se pravděpodobnost dalších mutací kontaktem proliferujících buněk s fekálními mutageny a adenomy se tvoří postupnou klonální expanzí

Epigenetické změny

Hypo- nebo hypermetylace promotorů

Hypometylace – obecný a raný děj – odpovědná např. za overexpresi k-ras

Hypermetylace – inaktivace nád. supresorových genů

Deregulace růstových faktorů

TGF beta – negativní růstových faktor epiteliálních buněk – zástava v G1 fázi, receptor I a II signálování přes SMAD proteiny

Inaktivační mutace signální dráhy – poruchy apoptózy- progrese adenom-karcinom.

Zánětlivé onemocnění střeva (IBD)

Nádory často vznikají v prostředí zánětu

Produkce prozánětlivých cytokinů – TNF alfa, IL-1, -6, -8, ROS, prostaglandiny – podpora, poškození DNA, angiogeneze, inhibice apoptózy a invaze.

Úloha transkripčního faktoru NF kB

Faktory vnějšího prostředí

► Výživa

- celkový kalorický příjem a frekvence příjmu potravy
- obsah a kvalita tuků v potravě (působení žlučových kyselin, obsah a kvalita nasycených a nenasycených tuků, lipidová peroxidace, zvýšená tvorba prostaglandinů)
- ochranný vliv vlákniny (vazba karcinogenů, zkrácení doby tranzitu střevem, snížení pH)
- vitaminy a další mikrokomponenty živin (vit. A, C a E a selen jsou antioxidanty)
- konzumace alkoholu a kávy
kouření (hlavně doutníky a dýmky)
- potravinové mutageny (zejména heterocyklické aminy ve vařeném a pečeném mase a tucích)
 - konzumace masa a vajec (vyšší konzumace je riziková – vepřové, hovězí, jehněčí)

▶ **Fyzická aktivita**

nedostatek je rizikovým faktorem

předpoklad modifikace diety s vysokým obsahem tuků

▶ **Profesionální faktory**

profese zdrojem látek zvyšujících riziko nádorů kolorekta (zejména kovoprůmysl, automobilový a dřevařský průmysl)

▶ Věk (zvýšený výskyt s věkem)

▶ Neefektivní imunitní systém

Chemoprevence

nesteroidní protizánětlivé léky (NSADs); antioxidanty; vápník; selen ; folát

MASTNÉ KYSELINY S KRÁTKÝM ŘETĚZCEM (SCFA)

▶ C2-5 organické mastné kyseliny (acetát, propionát, **butyrát**)

▶ vznikají bakteriální fermentací vlákniny a účastní se regulace funkcí a cytokinety v kolonu

▶ butyrát slouží jako zdroj energie pro normální epiteliální buňky a indukuje diferenciaci a apoptózu nádorových buněk střeva

CYTOKINY

Důležité endogenní faktory ovlivňující kolorektální karcinogenezi
TNF-family (TNF- α , Fas ligand, TRAIL – TNF relating apoptosis inducing factor)

TGF-family (TGF- β)

EGF – epidermální růstový faktor

Tumour necrosis factor-alpha (TNF- α), interleukiny

- ▶ multifunkční cytokin
- ▶ jeden z hlavních mediátorů zánětu
- ▶ TNF- α je produkován makrofágy a dalšími buňkami imunitního systému
- ▶ koncentrace TNF- α v kolonu je zvýšena během chronického zánětu (ulcerativní kolitida nebo Crohnova choroba)
- ▶ úloha v nádorové kachexii
- ▶ existuje interakce mezi cytokiny a dietetickými faktory – mastné kyseliny a eikosanoidy

Přenos signálu cytokinů rodiny TGF beta

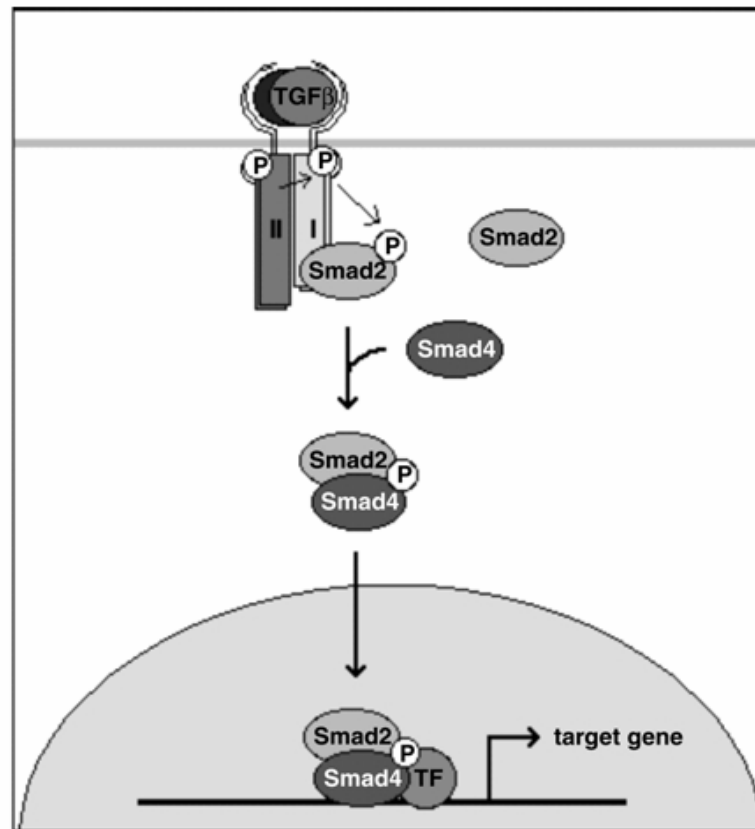

Figure 1. Mechanism of Signaling by TGFβ superfamily members. Binding of TGFβ superfamily ligands results in activation of a heteromeric receptor complex comprised of type I and type II receptors. The activated receptor complex then phosphorylates specific R-Smads. These R-Smads associate with the common Smad, Smad4 and then translocate to the nucleus where they interact with a variety of DNA binding partners to regulate gene expression.

Model signálů dráhy Wnt

Normální stav

Podpora karcinogeneze

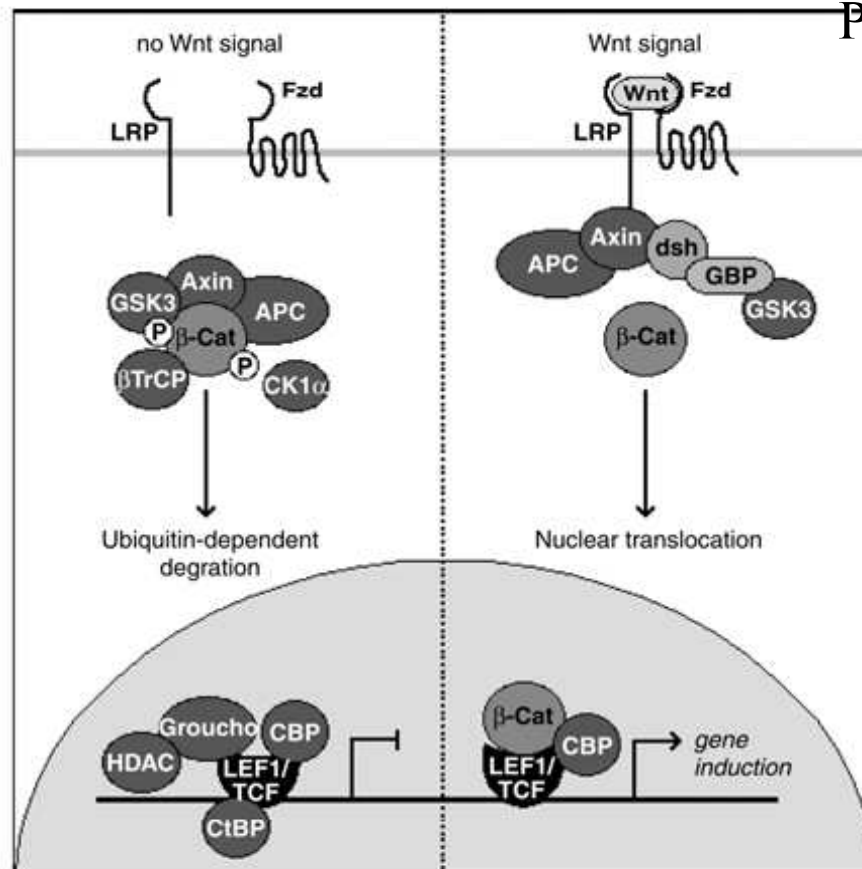

Figure 2. A model of Wnt signaling. In the absence of Wnt ligand (left panel) APC, Axin and GSK3 form a complex that results in β -catenin phosphorylation and degradation. Binding of Wnt to the Frizzled receptors (right panel) results in stabilization of β -catenin that then accumulates in the nucleus where it associates with LEF1/TCF transcription factors to regulate gene expression.

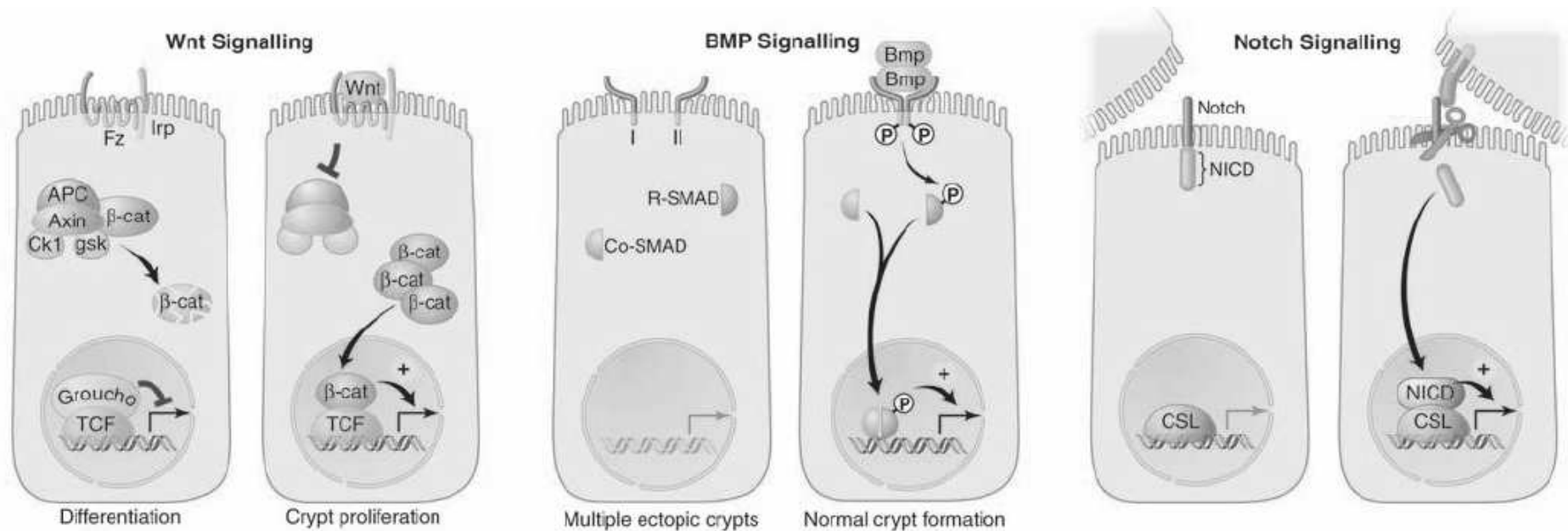

Fig. 3. Wnt, BMP, and Notch pathways control target gene transcription. **(Left)** Wnt-responsive cells carry a receptor complex consisting of a frizzled seven-transmembrane receptor (Fz) and Lrp5 or Lrp6. In the absence of secreted Wnt factor (left), the destruction complex (APC, axin, and the kinases CK1 and GSK3 β) induces degradation of cytoplasmic β -catenin. Tcf complexed to corepressors such as groucho represses specific Wnt target genes. Receptor engagement (right) blocks the destruction complex; β -catenin accumulates and binds to Tcf in the nucleus to activate transcription of Wnt target genes. **(Center)** Type I

and type II BMP receptors are not complexed in the absence of signal. Secreted BMP factors bring the two receptors together, ultimately leading to the phosphorylation of R-SMADs, their association with Co-SMAD, translocation to the nucleus, and subsequent activation of BMP target genes in the nucleus. **(Right)** When Notch receptor meets its cell-bound ligand (jagged or delta), sequential proteolytic steps lead to the release of its intracellular domain (NICD), which travels to the nucleus, where it complexes with the transcription factor CSL to activate Notch target gene transcription.

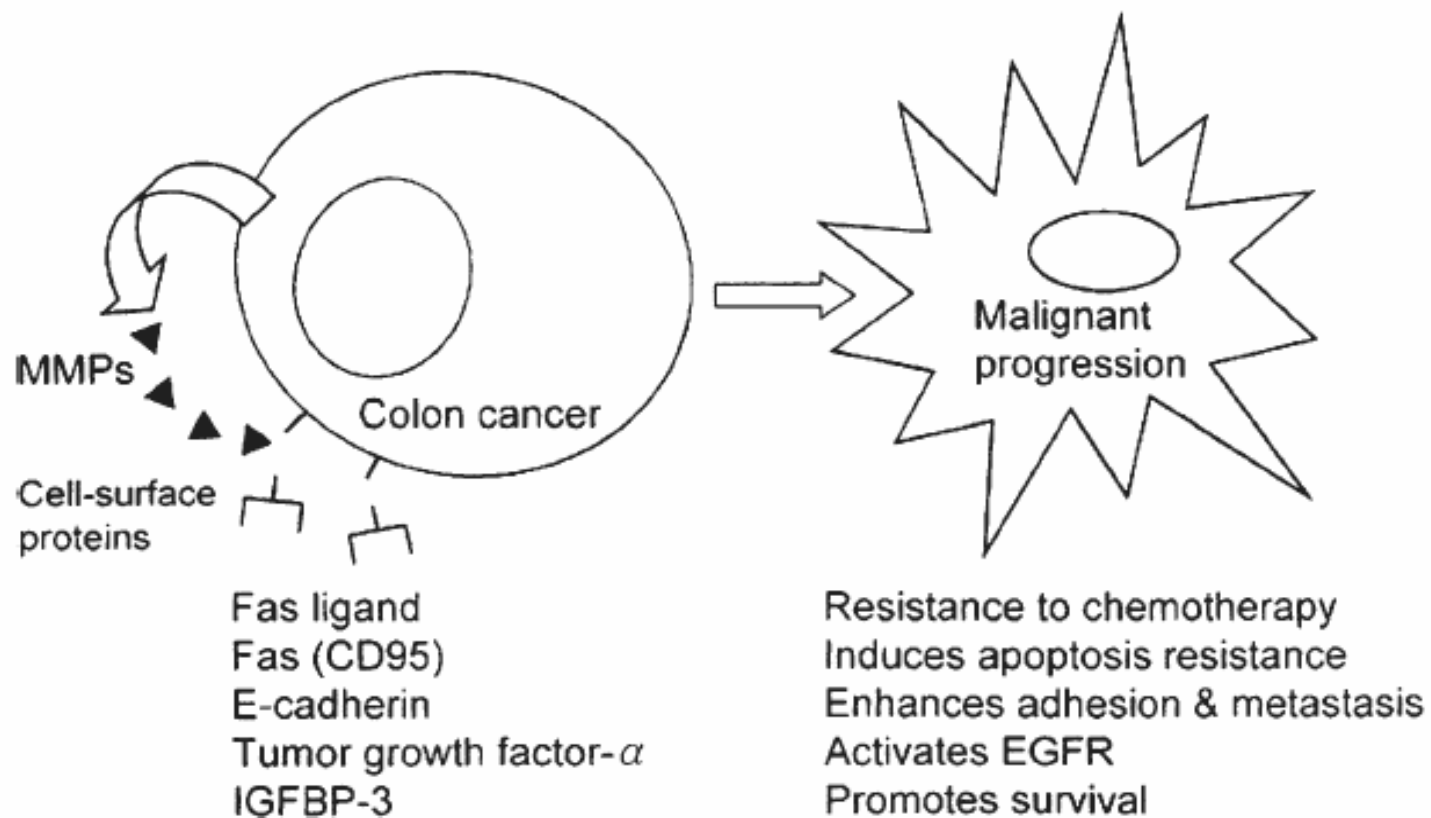

Figure 1. Cleavage of cell-surface proteins other than the ECM components is crucial for MMP-mediated CRC tumorigenesis.

Mechanismy působení vysoce nenasycených mastných kyselin (PUFAs) zahrnuté v kolorektální karcinogenezi

METABOLISMUS KYSELINY ARACHIDONOVÉ (AA)

COX-2

u kolorektálních karcinomů je zvýšena exprese COX-2 a množství PGE2

PGE2 stimuluje růst a inhibuje apoptózu nádorových buněk

PGE2 působí prozánětlivě a reguluje funkce imunitních buněk (imunosuprese)

nesteroidní antiflogistika (NSAIDs) snižují riziko kolorektálních nádorů a zánět inhibicí COX-2

LOX (5-, 12, -15)

u kolorektálních karcinomů zvýšená produkce 12- a 15- HPETE

Ovlivnění cytokinetiky, adhezivity a invazivity

Změny genové exprese - aktivace specifických transkripčních faktorů
(PPAR, NFκB, AP1)

Účinky lipidové peroxidace (LP)

Produkty LP mohou mít genotoxické účinky a mohou ovlivňovat buněčný cyklus.

Během LP jsou produkovány reaktivní kyslíkové radikály (ROS)

ROS mohou aktivovat NF-κB

Dráhy přeměny kyseliny arachidonové v prostaglandiny

Úloha COX-1 a COX-2

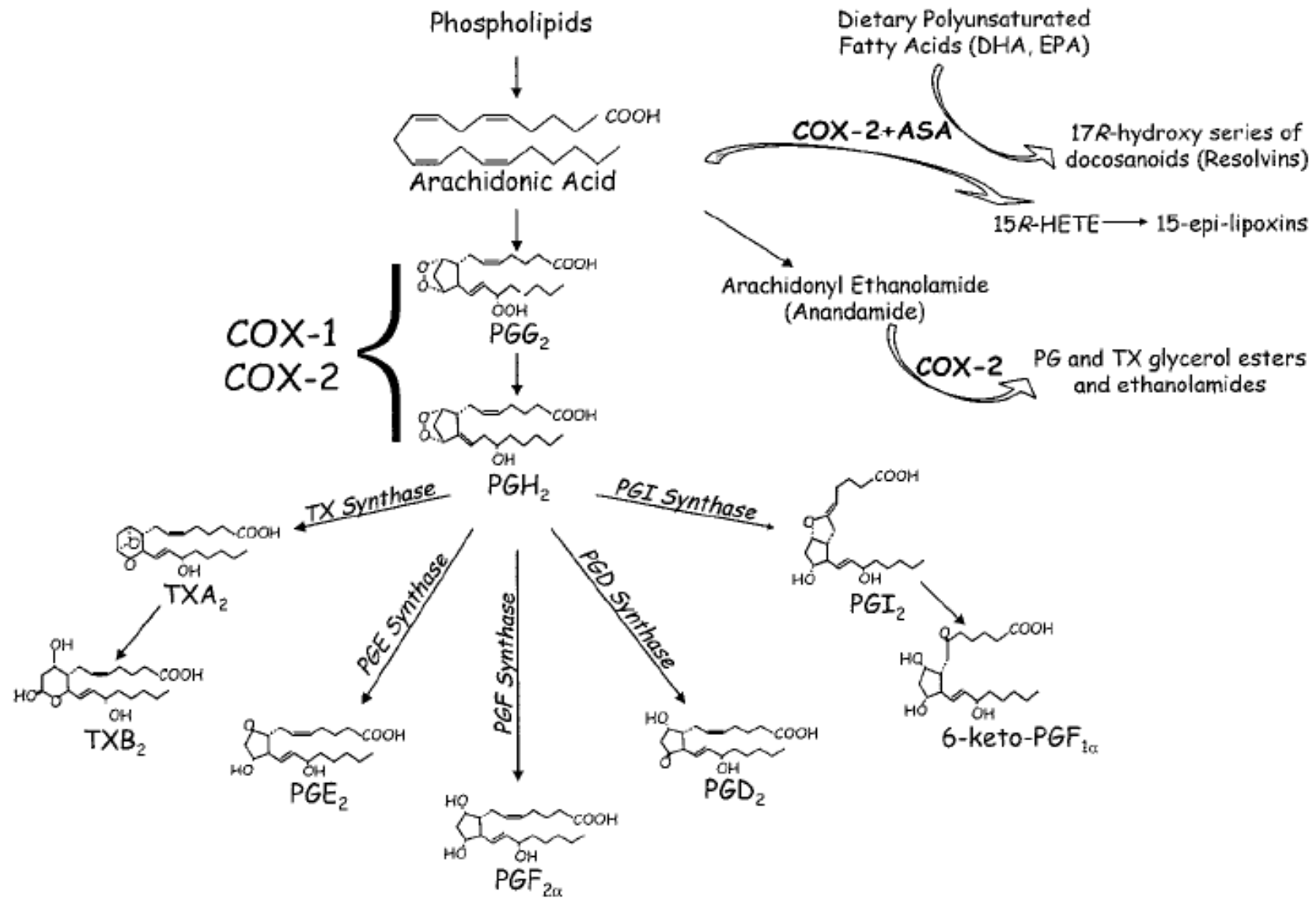

Dráha 5-lipoxygenázy – vznik leukotrienů

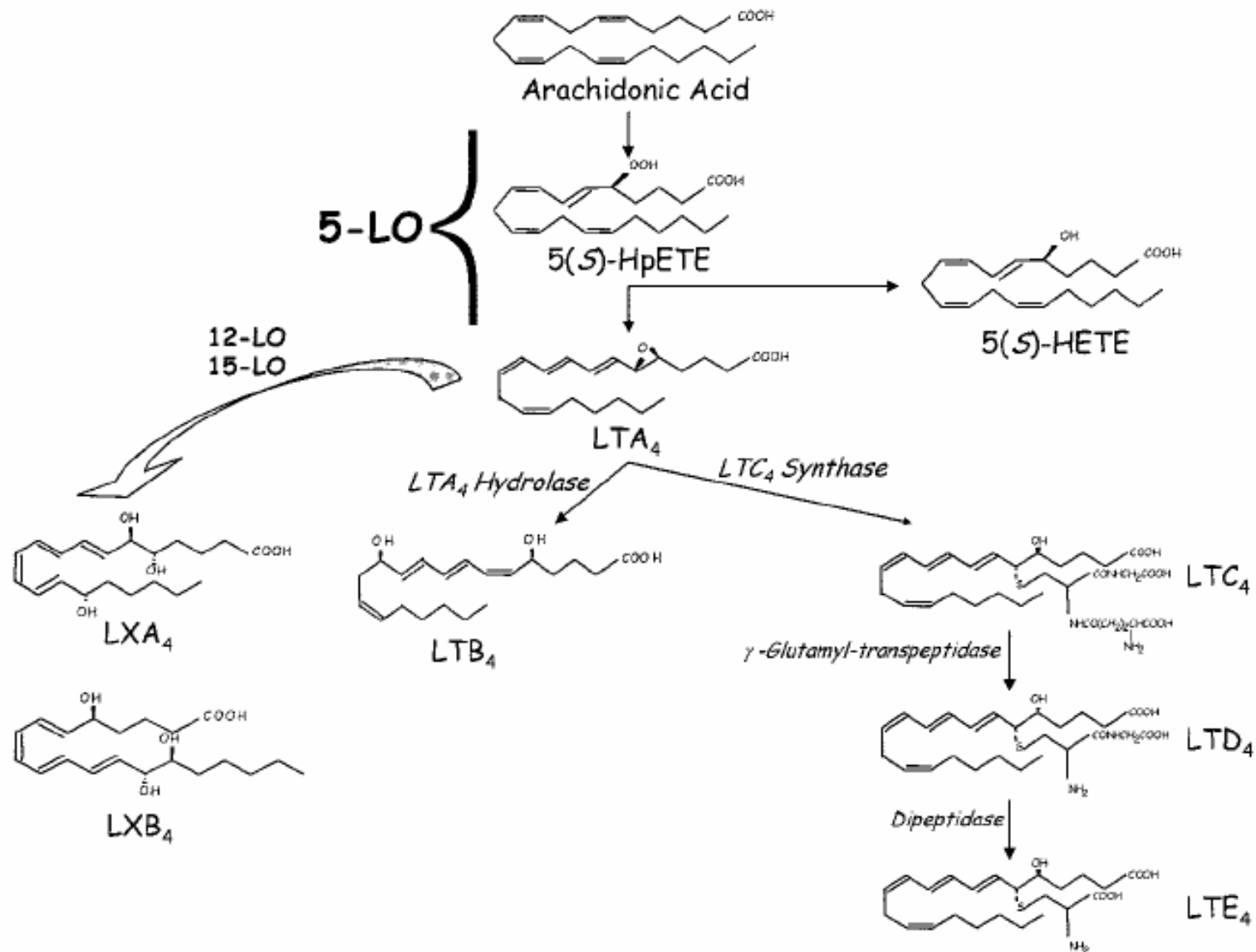

COX-2 i 5-LPO stimuluji buněčnou proliferaci, inhibují apoptózu a indukují neoangiogenezi

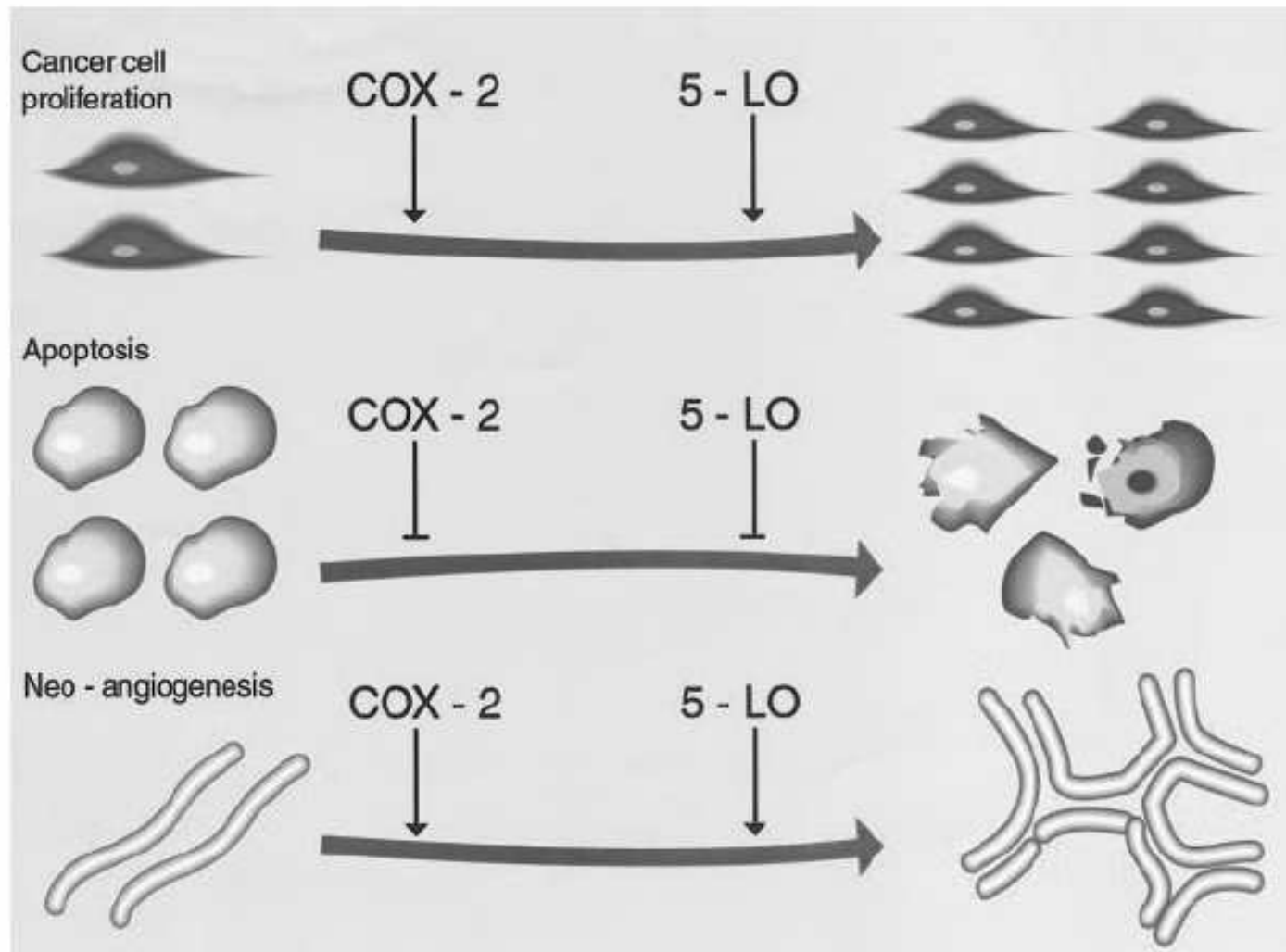

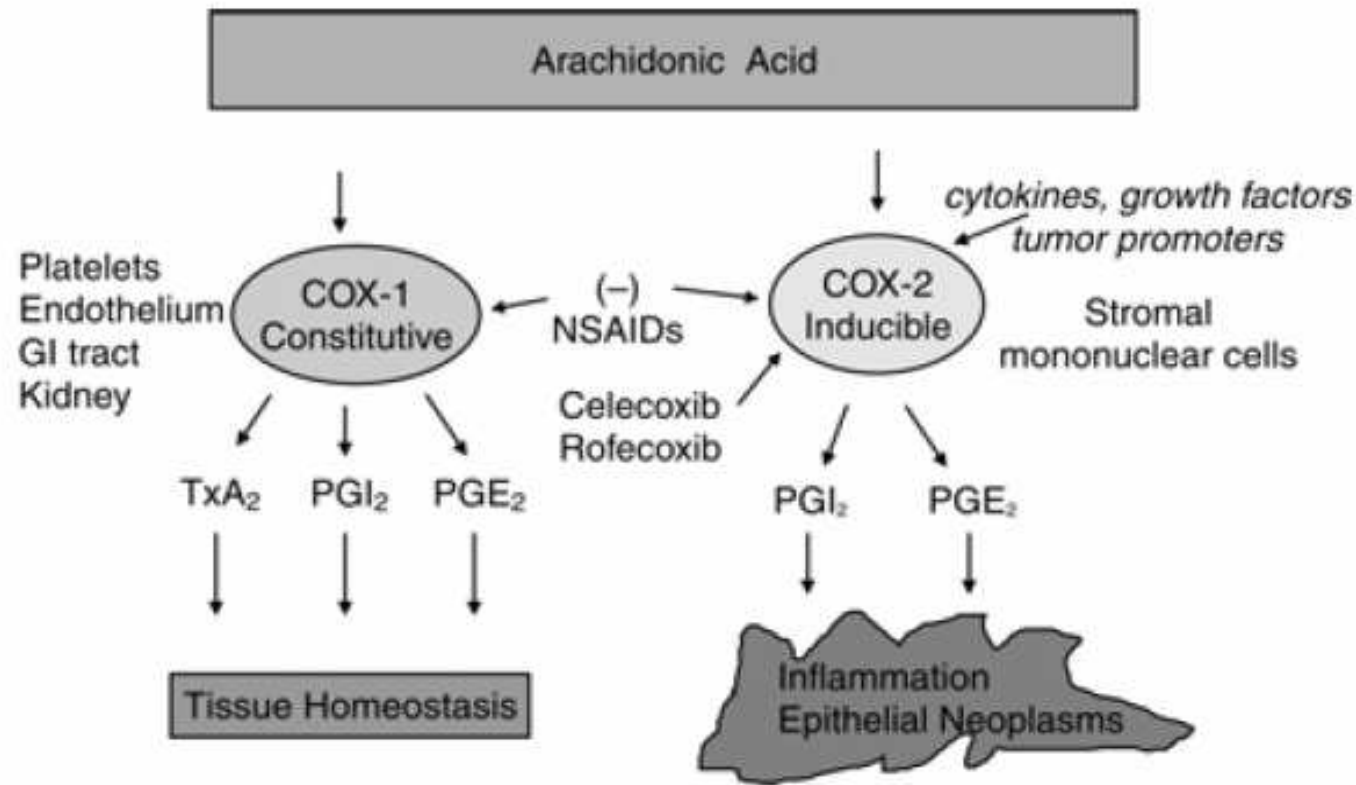

Figure 1. COX isoforms include constitutive COX-1 which is involved in normal tissue homeostasis and inducible COX-2 which is upregulated at sites of inflammation and in colorectal neoplasms. NSAID inhibit both COX isoforms, whereas COX-2 inhibitors are selective for the COX-2 enzyme. TxA₂ = -thromboxane.

COX-2 je nadměrně exprimována u 40-90% kolorektálních adenomů a u 90% adenokarcinomů

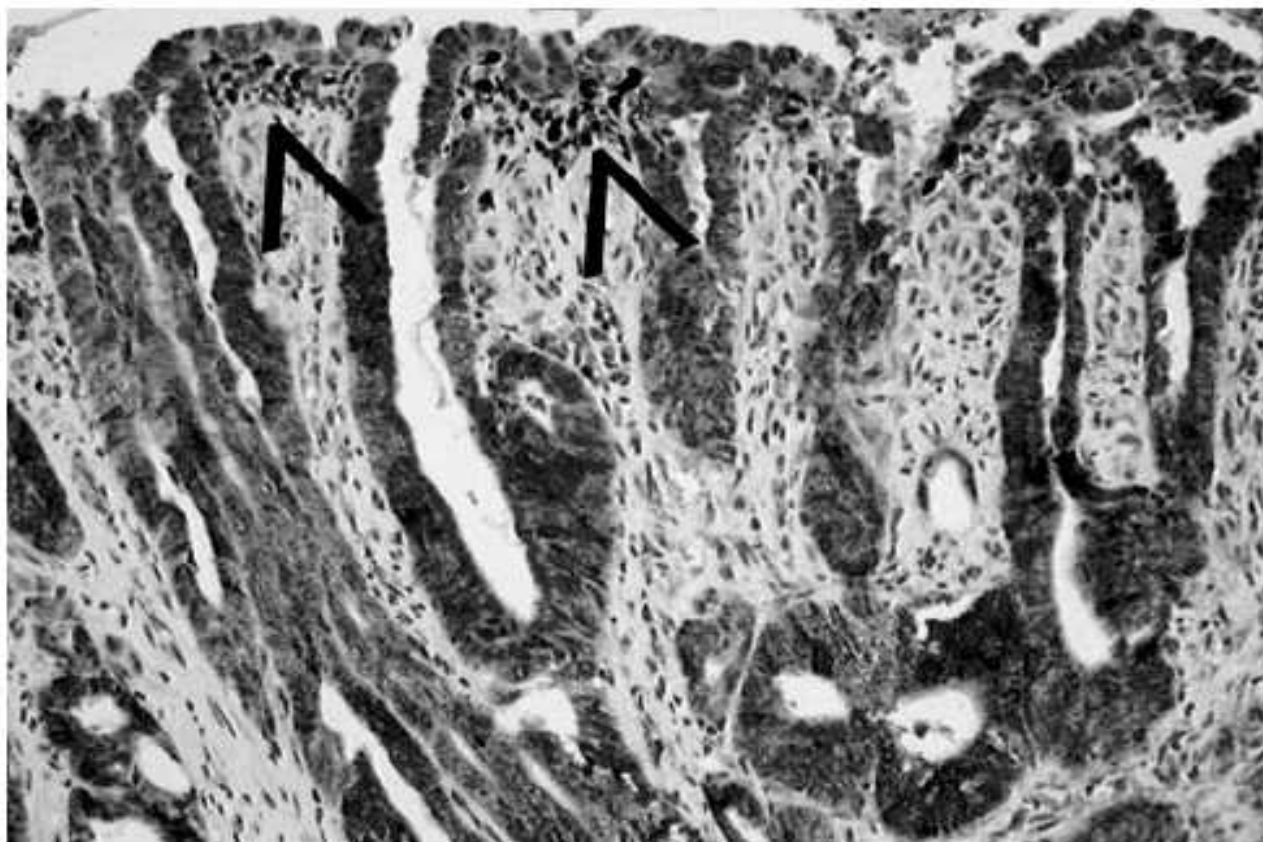

Fig. 2 COX-2 expression in tumoral cells and superficial interstitial cells (*arrows*) in a well differentiated colon adenocarcinoma. Immunohistochemistry, $\times 200$

Table 1. COX2 expression in malignant or premalignant human tumours

Premalignant or malignant lesion	COX2 expression (%)
Colorectal	80–90
Gastric	80
Oesophageal	70
Hepatocellular (liver cirrhosis)	54 (81)
Pancreatic	67
Head and neck	80
Non-small-cell lung cancer	70
Breast (ductal carcinoma-in-situ)	40 (60)
Prostatic	83–93
Bladder	86
Cervix	43
Endometrial	37
Cutaneous basal cell	25
Cutaneous squamous cell	80
pPNET	100
Glioblastoma multiforme	71–74
Anaplastic astrocytoma (low grade)	44 (30)

References available at <http://image.thelancet.com/extras/03oncl205webfr.pdf>

Některé inhibitory COX-1 a COX-2 (NSAIDs)

TABLE 1.

Structural class	Members	
	COX-1- nonselective	COX-2- selective
alkanones	nabumetone	
anthranilic acids	meclofenamic acid, mefenamic acid	meclofenamate esters and amides
arylpropionic acids	ibuprofen, flurbiprofen, ketoprofen, naproxen,	
diarylheterocycles	SC560	celecoxib, etoricoxib, parecoxib, rofecoxib, valdecoxib
di-tert-butyl phenols		darbufelone
enolic acids	piroxicam, tenoxicam, phenylbutazone	meloxicam
heteroaryl acetic acids	diclofenac, ketorolac, tolmetin	lumiracoxib
indole and indene acetic acids	indomethacin, sulindac	etodolac, indomethacin amides (and esters)
para-aminophenol derivatives	acetaminophen	
salicylic acid derivatives	aspirin, diflunisal, sulfasalazine	o-(acetoxyphenyl)hept-2-ynyl sulfide (APHS)
sulfanilides		nimesulide, flosulide

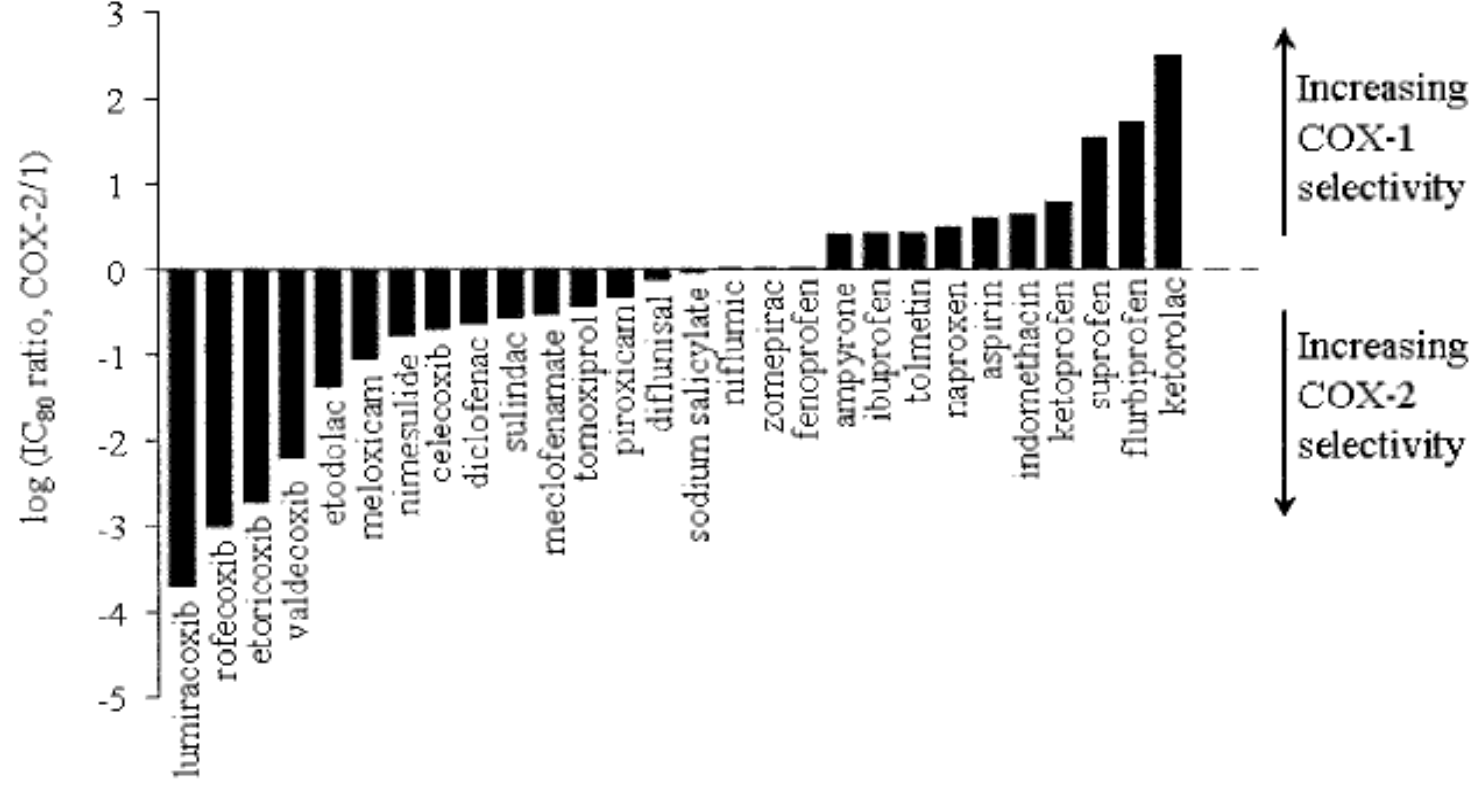

Schematické dráhy některých funkčních efektů inhibice COX-1 a COX-2

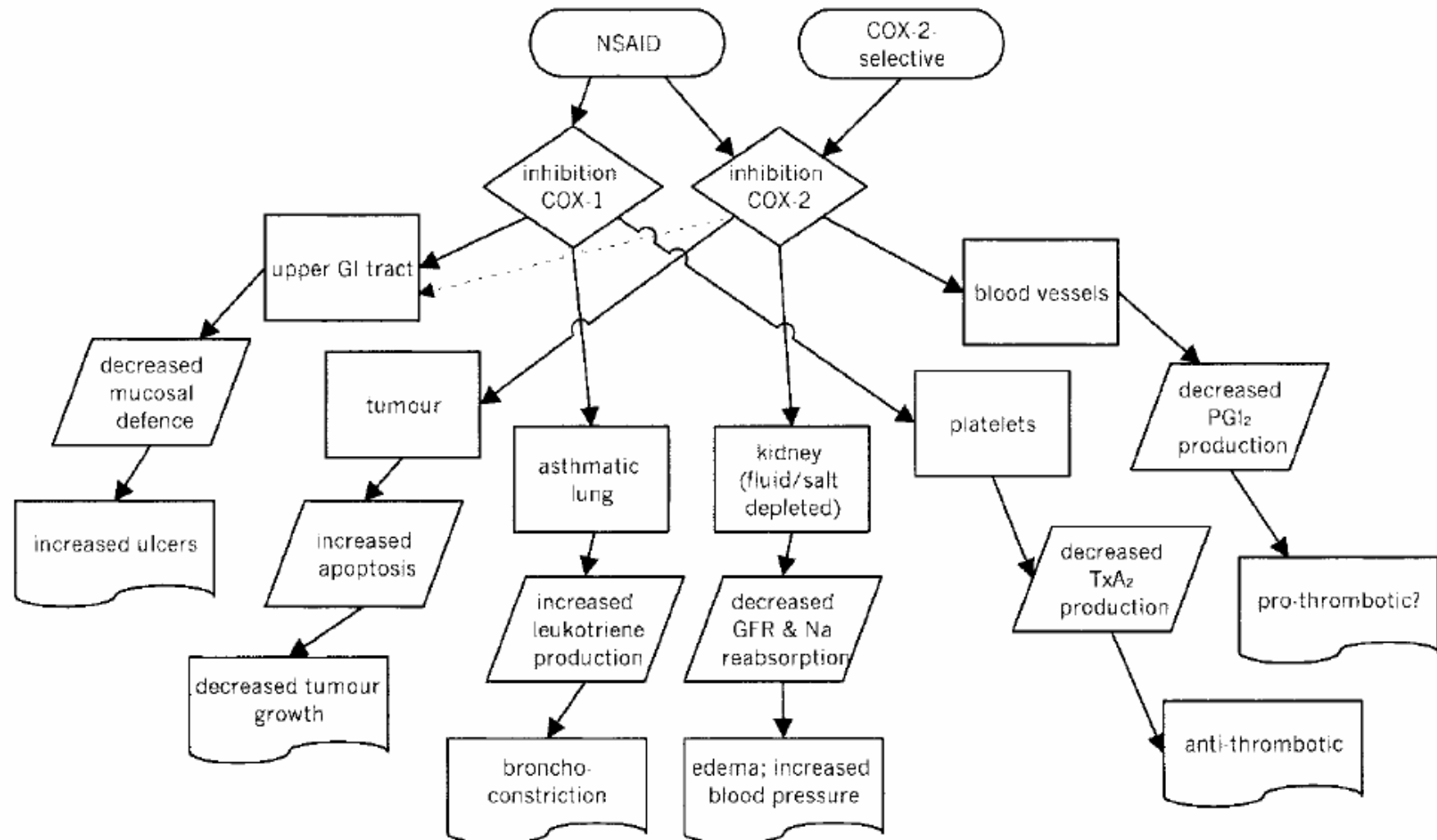

TABLE 2.

COX-2-selective agents compared to traditional NSAIDs	
	<i>Therapeutic indication</i>
inflammation	equi-effective
pain (arthritic, inflammatory, surgical)	equi-effective
	<i>Other beneficial effects</i>
Alzheimer's disease	NSAID benefit shown from epidemiology but no current evidence for effectiveness of COX-2 selectives
Cancer	Both groups reduce development of colon cancer and possibly esophageal cancer; both groups effective in animal models of cancers in lung and pancreas
	<i>Side effect</i>
Asthma	no evidence for COX-2- selectives causing asthma attacks in NSAID-sensitive individuals
gastrointestinal toxicity, minor such as dyspepsia, diarrhoea	similar effects
gastrointestinal toxicity, major such as perforations, obstructions and bleeds	COX-2- selectives produce less than NSAIDs
reproduction	both groups may delay ovulation, implantation, and preterm labor
thrombosis	some suggestion that COX-2- selectives may increase thrombotic events at supratherapeutic doses

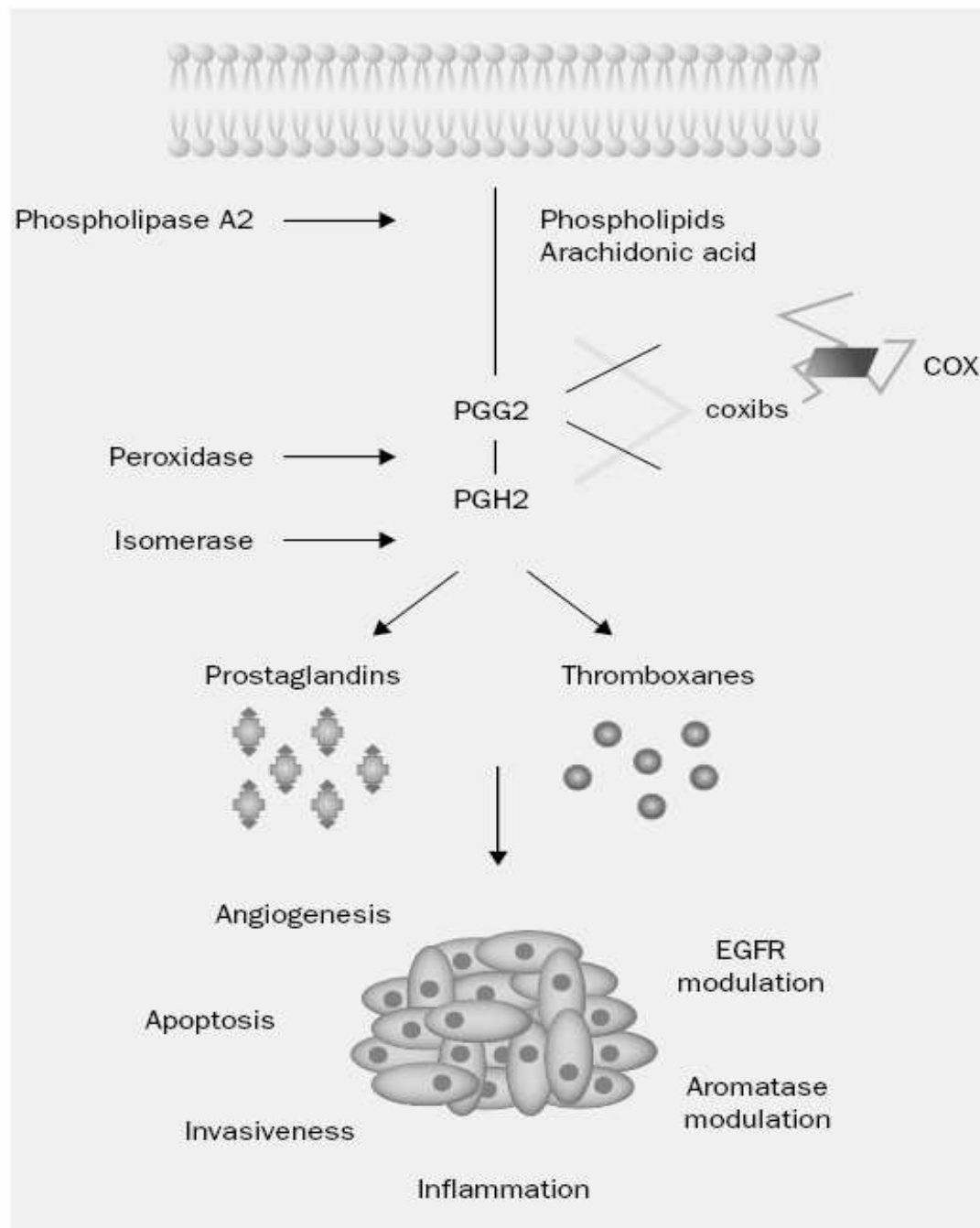

Figure 1. The pathways which stimulate tumour growth through COX2 and the mechanisms of action of coxibs.

Mechanismy účinků exprese COX-2 na vývoj kolorektálních nádorů:

Účinky nezávislé na produkci prostaglandinů (PGE₂):

Aktivace karcinogenů

Produkce malondialdehydu

Redukce hladiny volné AA

Účinky závislé na produkci PGE₂:

Indukce buněčné proliferace

Inhibice apoptózy

Indukce angiogeneze

Zvýšení buněčné motility

Zvýšené metastatického potenciálu

Indukce lokální imunosuprese

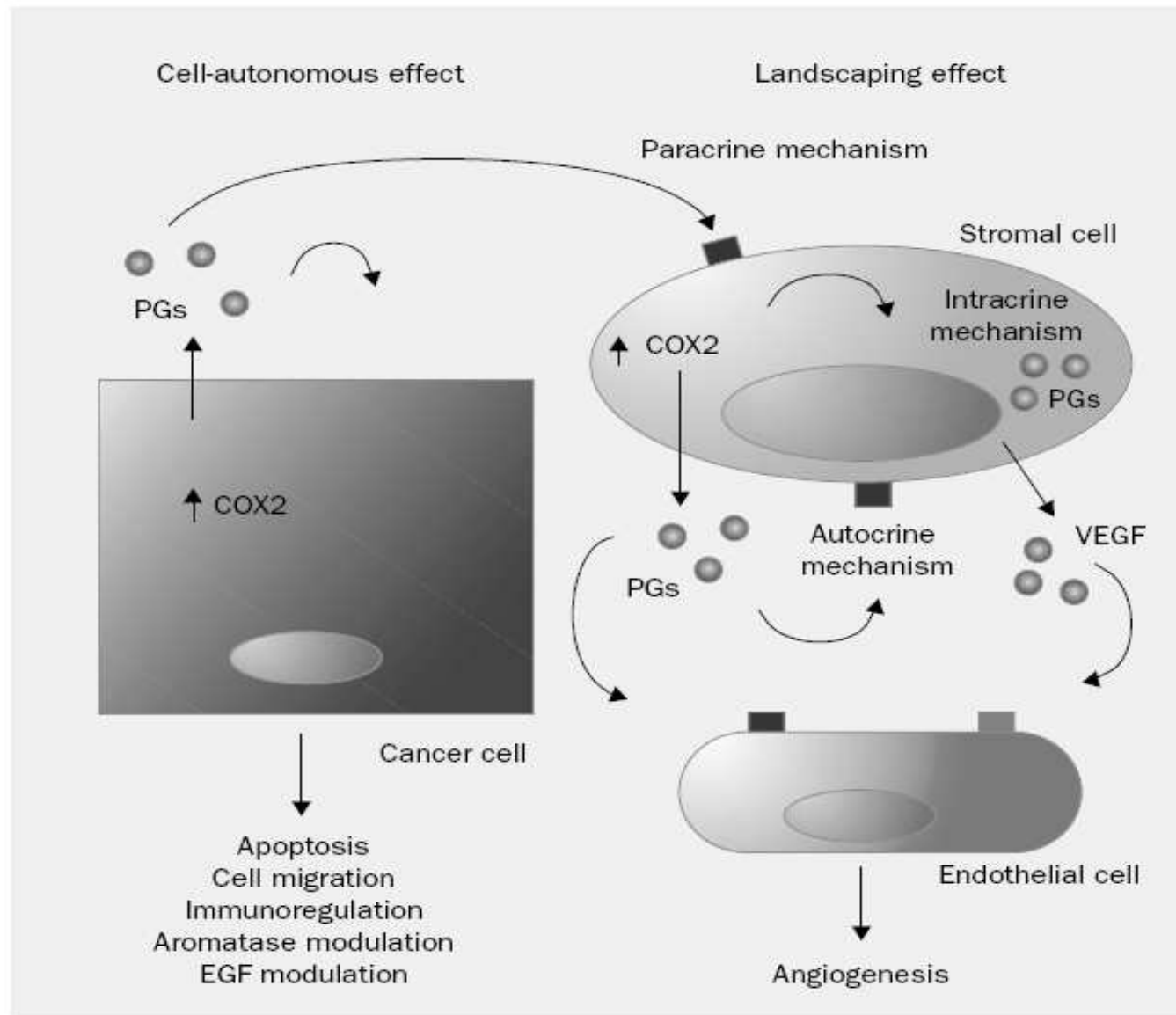

Figure 3. COX2 is overexpressed in several cell types, such as macrophages, synoviocytes, fibroblasts, osteoblasts, tumour endothelial cells, and “activated” endothelial cells, and may contribute to tumour growth through several mechanisms: COX2-dependent -prostaglandins can stimulate intracellular receptors (intracrine mechanism), self-prostaglandin membrane receptors (autocrine mechanism), and prostaglandin membrane receptors of different cells, such as endothelial cells, with proangiogenic effects (paracrine or landscaping effect).

Molekulární mechanismy COX-2 a NSAIDs

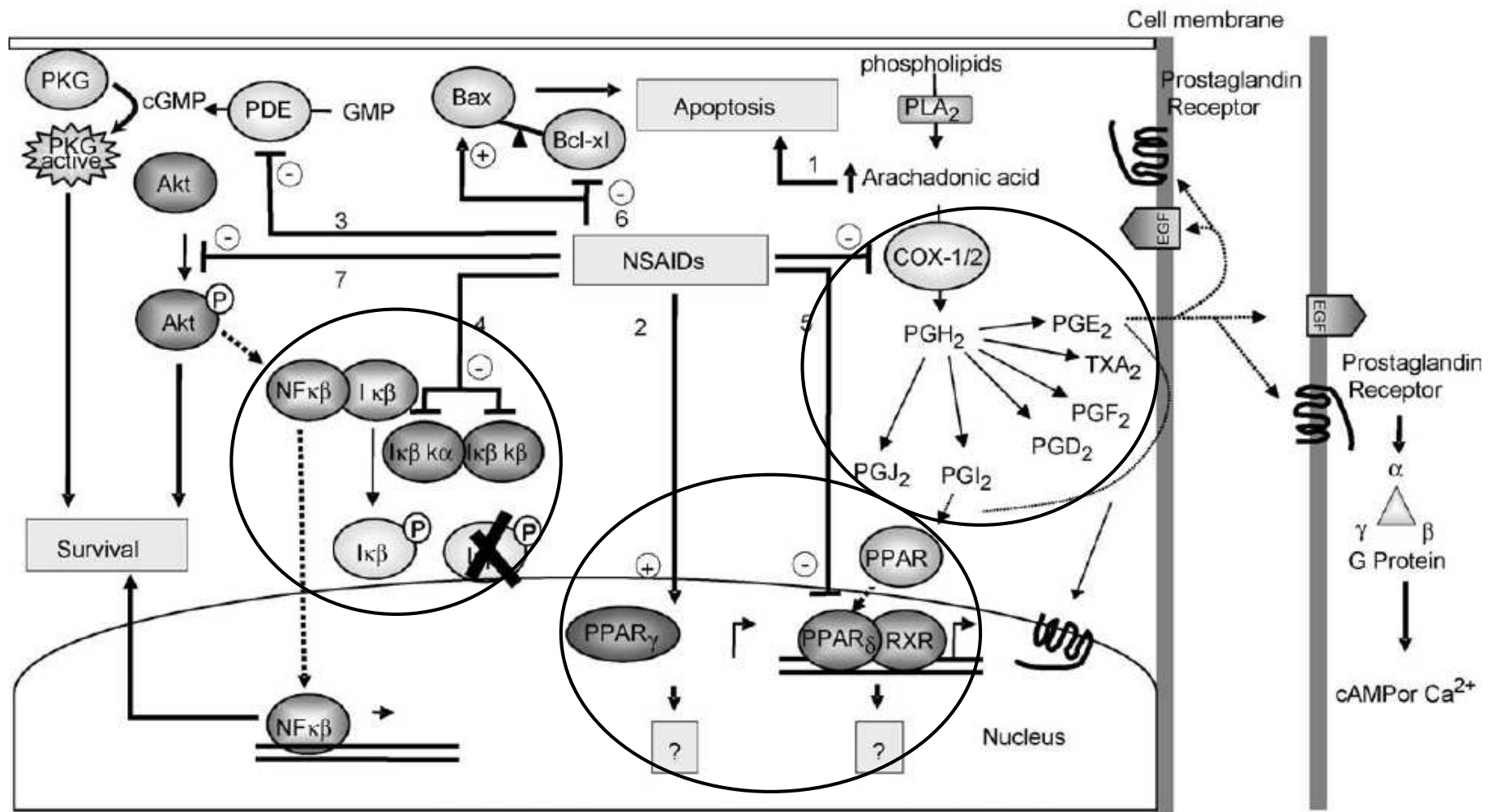

Fig. 4. Molecular mechanisms for COX-2 and NSAIDs. The right part of the model illustrates the prostaglandin synthesis pathway as well as the subsequent receptor signaling—the specific prostaglandin receptors as well as the non-canonical EGF receptor pathway. As the result of inhibiting COX enzymes, accumulation of arachadonic acid would directly promote apoptosis and attenuation of positive feedback to proliferation and survival through receptors. The rest of the figure demonstrates several COX-2 independent mechanisms proposed for NSAIDs. Since, not all NSAIDs are able to act through these mechanisms in every cell type, a brief table is attached to summarize the particular NSAIDs used in each experiment as well as the cell lines involved.

Mechanismy preventivního působení NSAIDs v kolorektální karcinogenezi

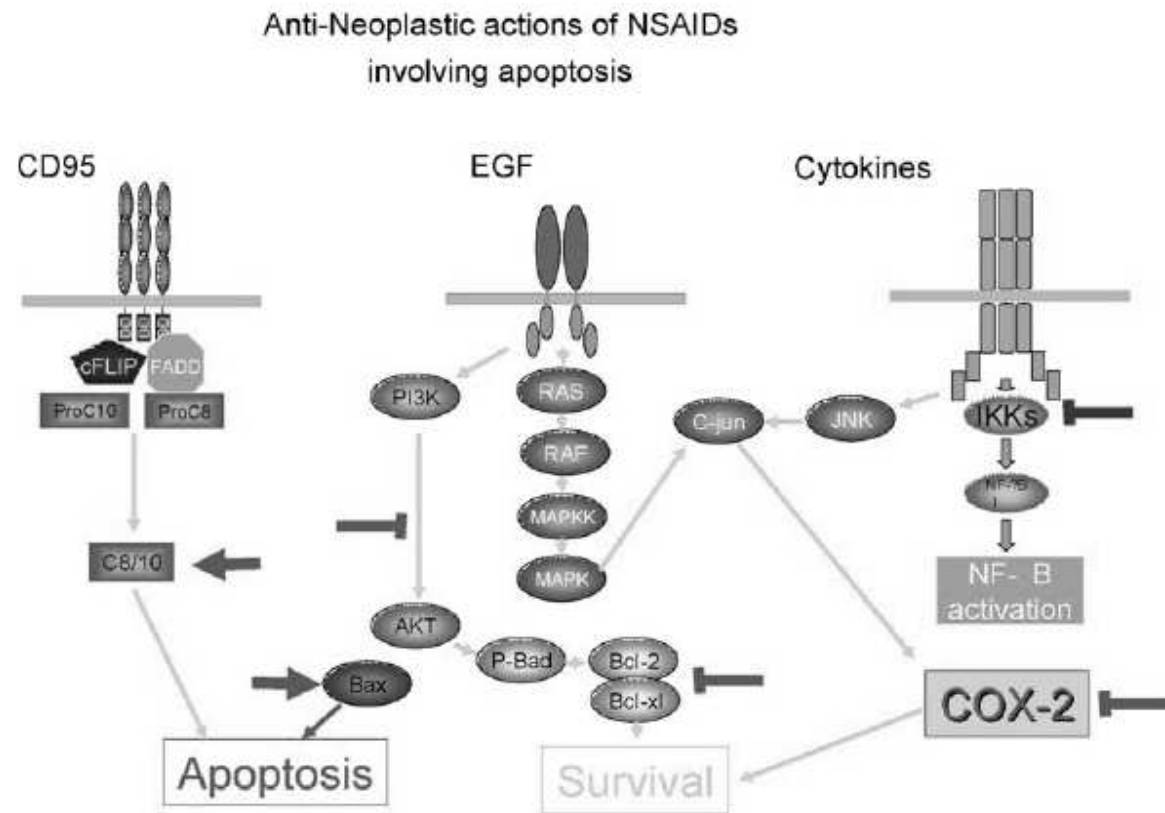

Fig. 6. A summary of the known actions of NSAIDs relevant to prevention of colorectal cancer. Red arrows and blocks indicate actions of NSAIDs.

Mechanismy účinků některých NSAIDs

No	Mechanism	NSAID (concentration)	Cell line system	Reference
1	Accumulation of AA causes apoptosis	Sulindac (200 μ M), indomethacin (300 μ M)	HT29, HEK293	[141]
2	Serve as ligands for PPAR γ	Indomethacin (40 μ M), flufenamic acid (100 μ M), fenoprofen (100 μ M), ibuprofen (100 μ M)	Fibroblast (C3H10T1/2)	[145]
3	Inhibits PED	Sulindac sulfone (165 μ M)	SW480	[140]
4	Inhibits I- κ B kinase β	Aspirin, sulindac sulfide, not indomethacin	HCT16, Cos, etc.	[146]
5	Blocks DNA binding of PPAR δ/β	Sulindac sulfide (100–250 μ M)	HCT116, SW480	[136]
6	Suppresses Bcl-xl	Sulindac (120 μ M)	HCT116	[137]
7	Blocks Akt activation	Celecoxib (25–50 μ M)	PC-3, LNCaP	[147]

COX-2 v angiogenezi

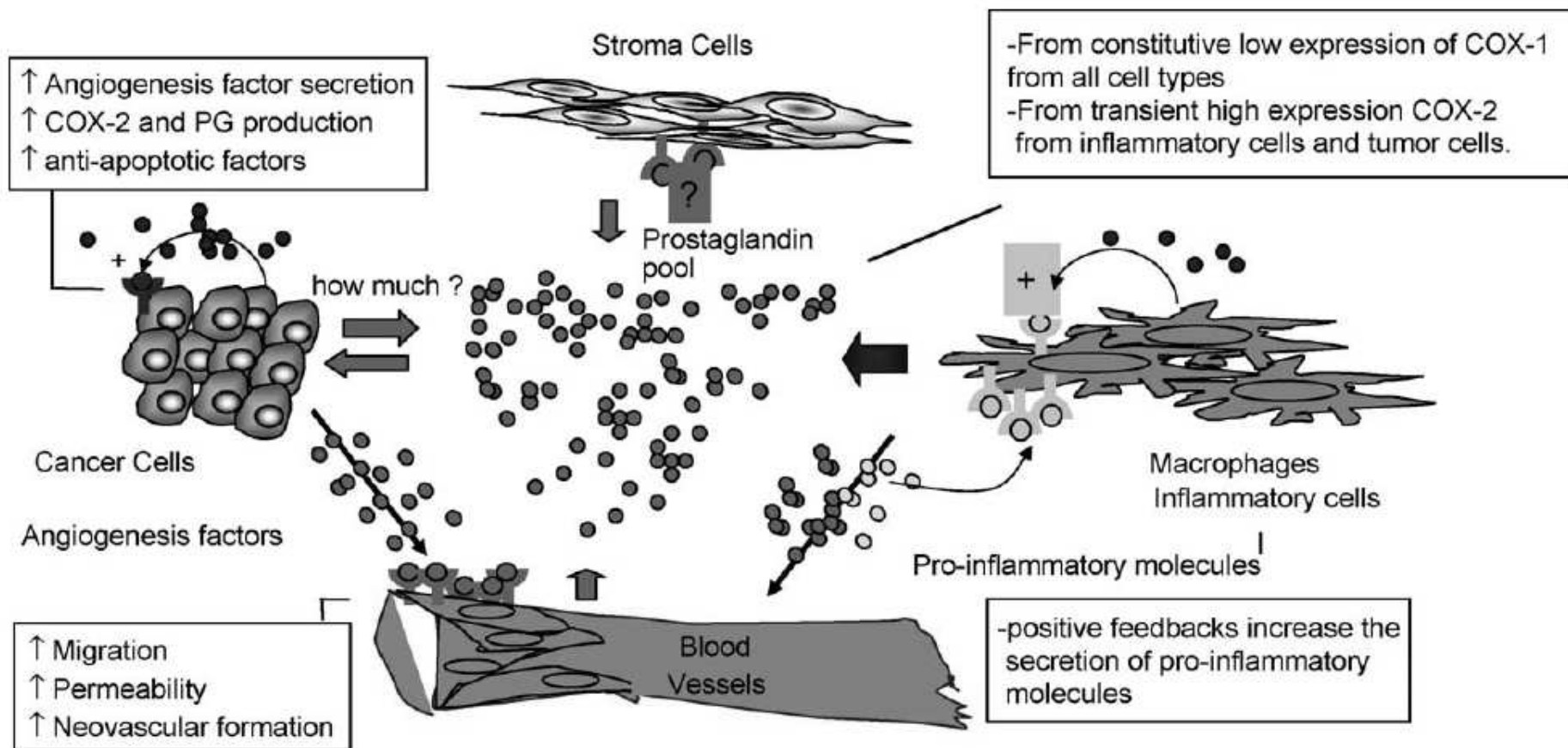

Fig. 1. COX-2 in angiogenesis. This figure models the interactive relationship among cancer cells, endothelial cells and infiltrating inflammatory cells at the site of tumorigenesis. The prostaglandin pool is contributed to by all three different cell types and occasionally stromal cells. The positive feedback through prostaglandin receptors increases COX-2 expression and ensures the continued generation of prostaglandins. In the cancer cell, prostaglandin signaling also results in the production of multiple angiogenesis factors, through which they stimulate neovascular formation at the site of tumorigenesis. In inflammatory cells, prostaglandin signaling stimulates the generation of pro-inflammatory molecules such as IL-2, which further recruits additional circulating monocytes and amplifies the inflammatory response. As a response to increased levels of prostaglandins, angiogenesis factors and pro-inflammatory molecules, endothelial cells proliferate, migrate and undergo tubal formation, providing additional nutrients for oncogenesis as well as a potential route for metastasis.

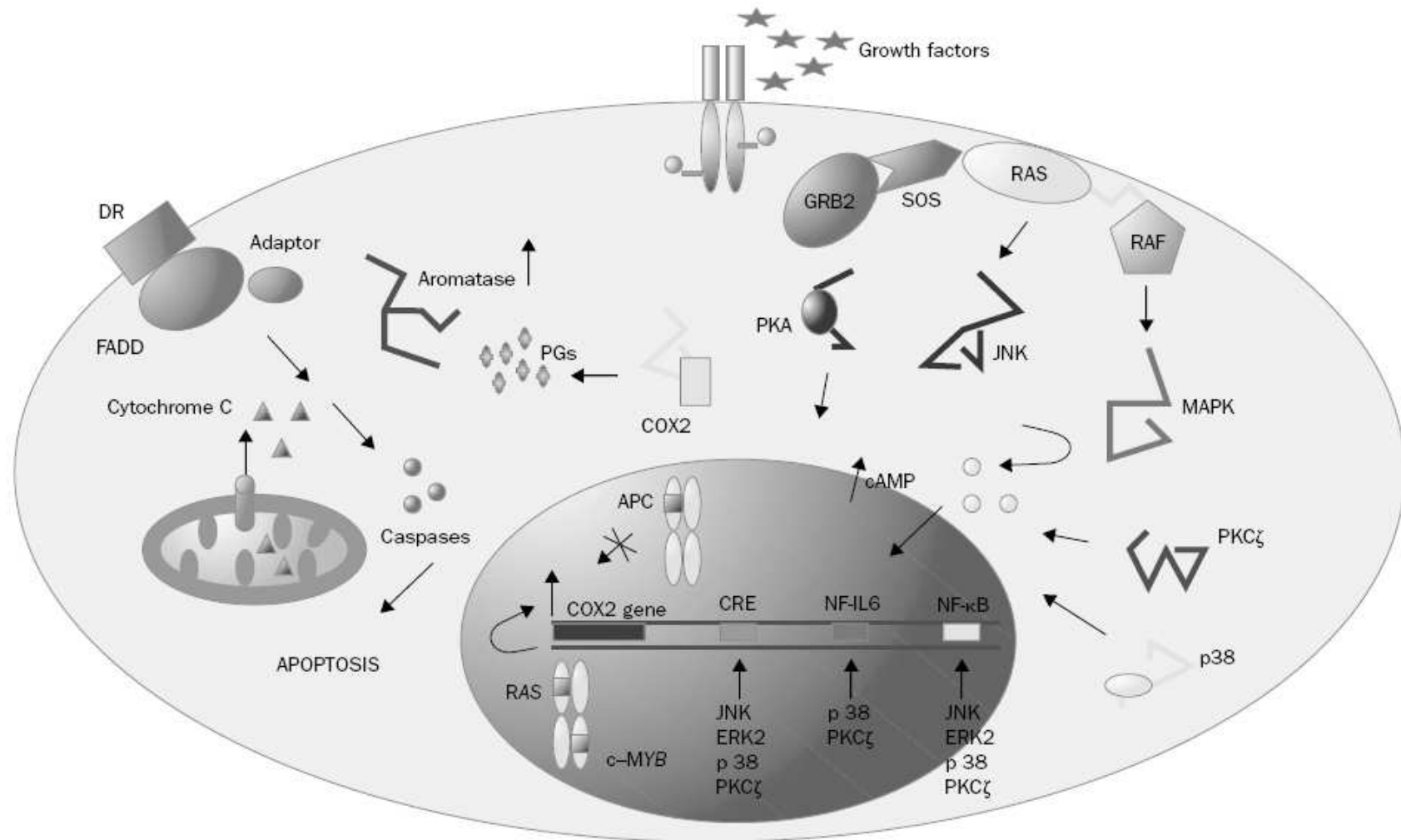

Figure 2. Increased expression of COX2 in human cancers is likely to occur via several pathways: mitogen-activated protein kinases (MAPKs), protein kinase C ζ (PKC ζ), c-Jun N-terminal kinase (JNK), p38, and protein kinase A (PKA), that induce cAMP synthesis and activation of NF κ B and NF-IL6, as well as the CRE promoter site. COX2 gene transcription is induced through NF κ B by an extracellular-signal-related kinase (ERK2), p38, and JNK, through NF-IL6 via p38, and through CRE via ERK2 and JNK pathways. PKC ζ seems to mediate COX2 transcription through all the three promoter sites. COX-2 is transcriptionally downregulated by APC and upregulated by c-Myb, and nuclear accumulation of β -catenin, through the Wnt-signalling pathway, in human colon and liver carcinogenesis, whereas K-ras induces COX2 mRNA stabilisation. DR, death receptor; FADD, Fas-associated death domain protein.

The Inflammatory Pathway To Colorectal Cancer

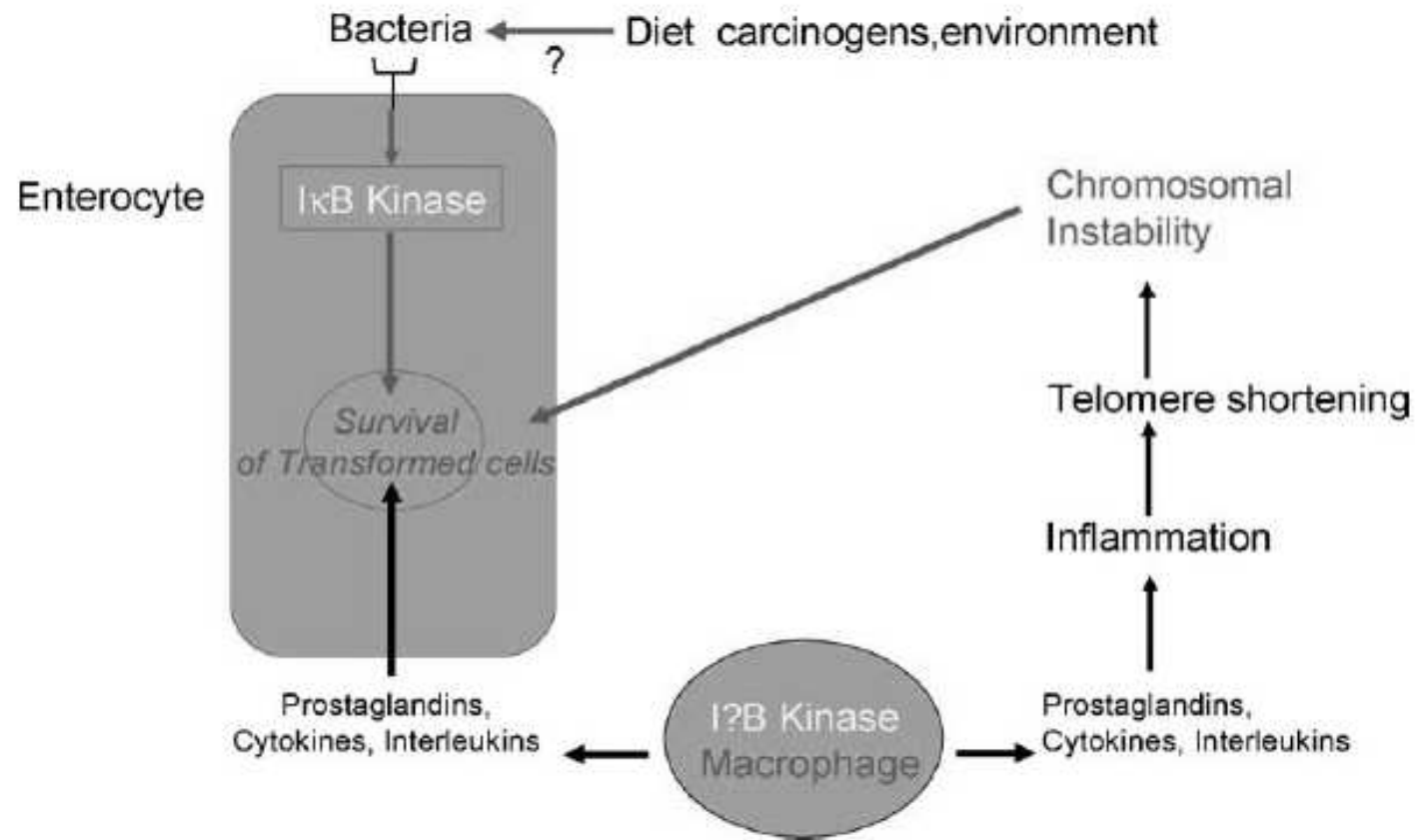

Fig. 5. A speculative model for initiation of colorectal cancer by gut flora.

Aktivace NFκB bakteriemi

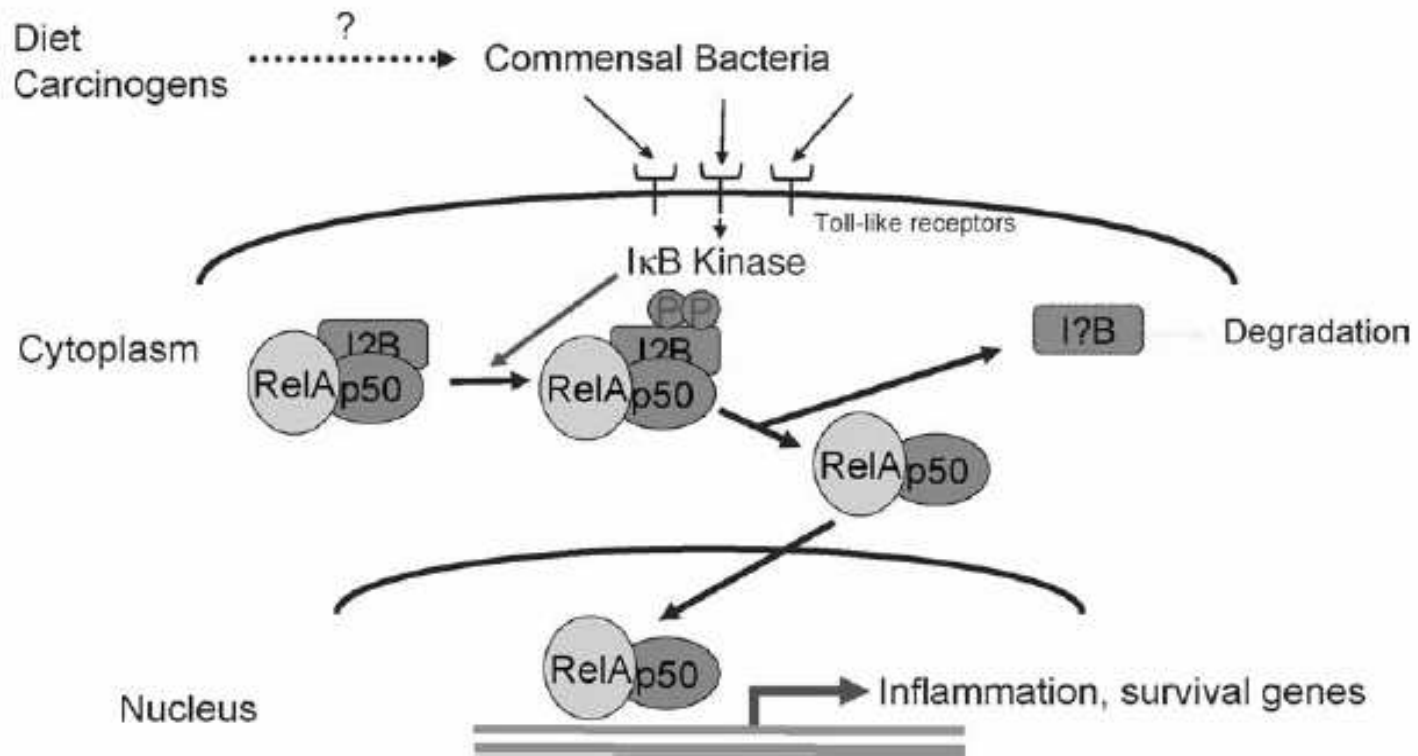
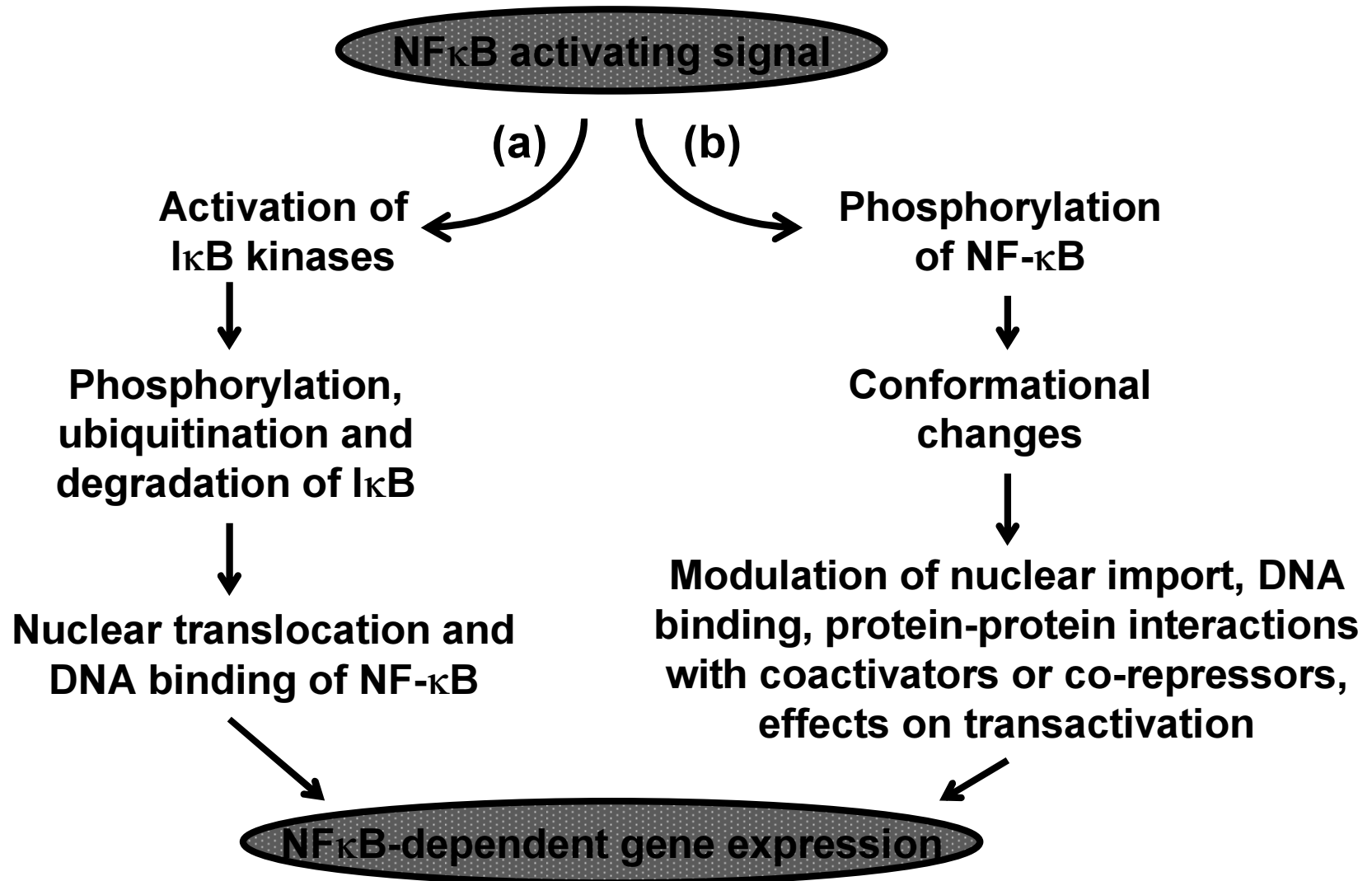

Fig. 4. The classical NF-κB pathway and its activation by bacteria. After reference [98].



Regulace aktivity NF- κ B závislá a nezávislá na I κ B. (a) NF κ B je aktivován po aktivaci I κ B kinázy (IKK). Tyto kinázy fosforylují I κ B, což vede k jeho degradaci a jaderné translokaci uvolněného NF- κ B. (b) Zároveň samotný NF- κ B je fosforylován cytosolovými nebo jadernými protein kinázami, což zvyšuje účinnost genové exprese indukované NF- κ B. I κ B, inhibitor NF- κ B; NF- κ B, jaderný faktor κ B.

Vliv různé intenzity apoptózy na homeostázu

Rychlost buněčné
proliferace

Intenzita (rychlost)
apoptózy

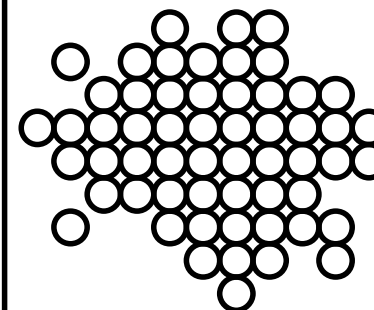
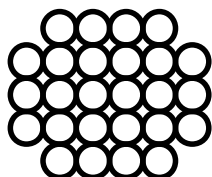

akumulace
buněk

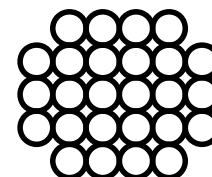
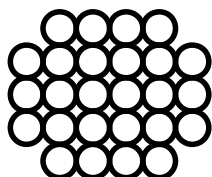

homeostáza

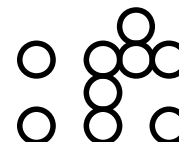
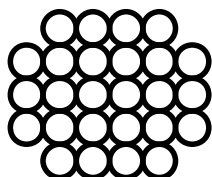

úbytek buněk

Vliv narušení (stimulace/inhibice) průběhu apoptózy v rámci procesu vícestupňové karcinogeneze

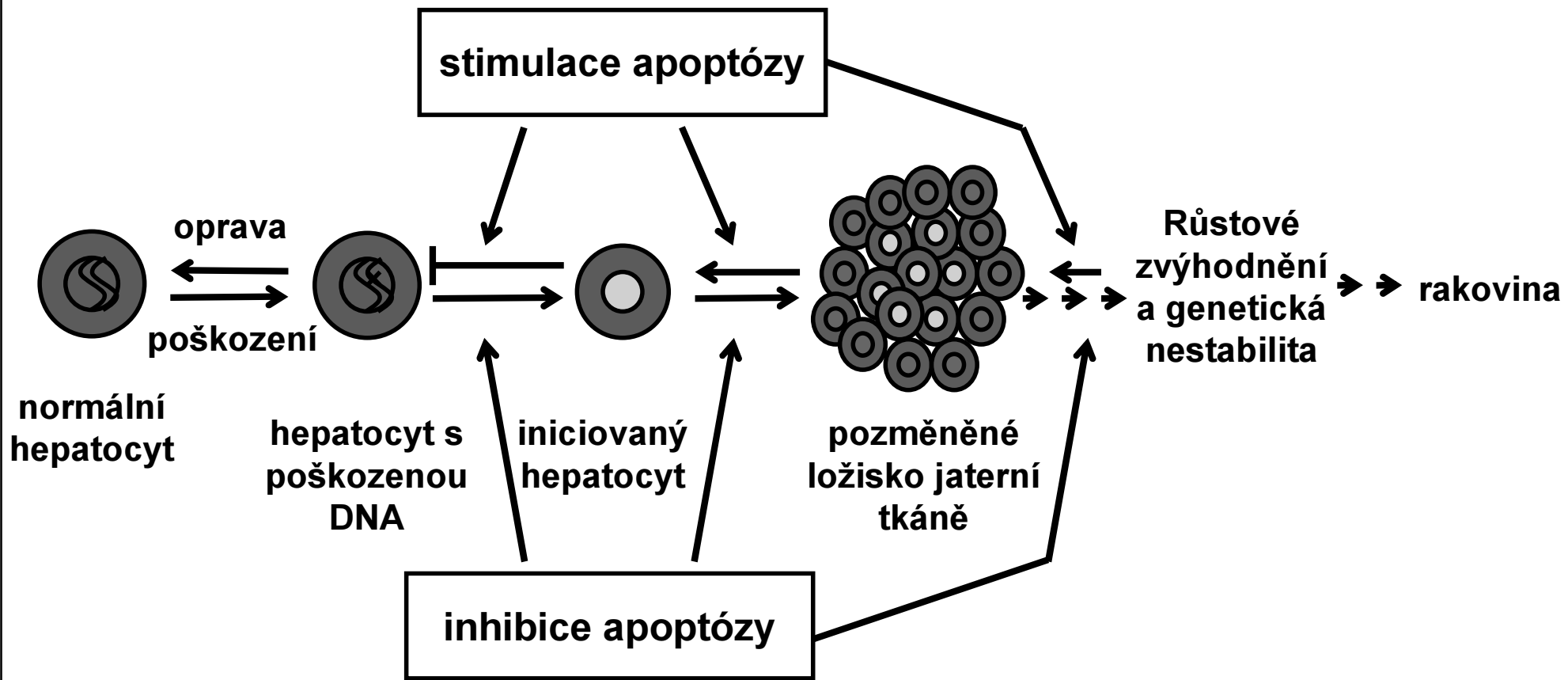

Schematic representation of apoptosis, oncosis and necrosis

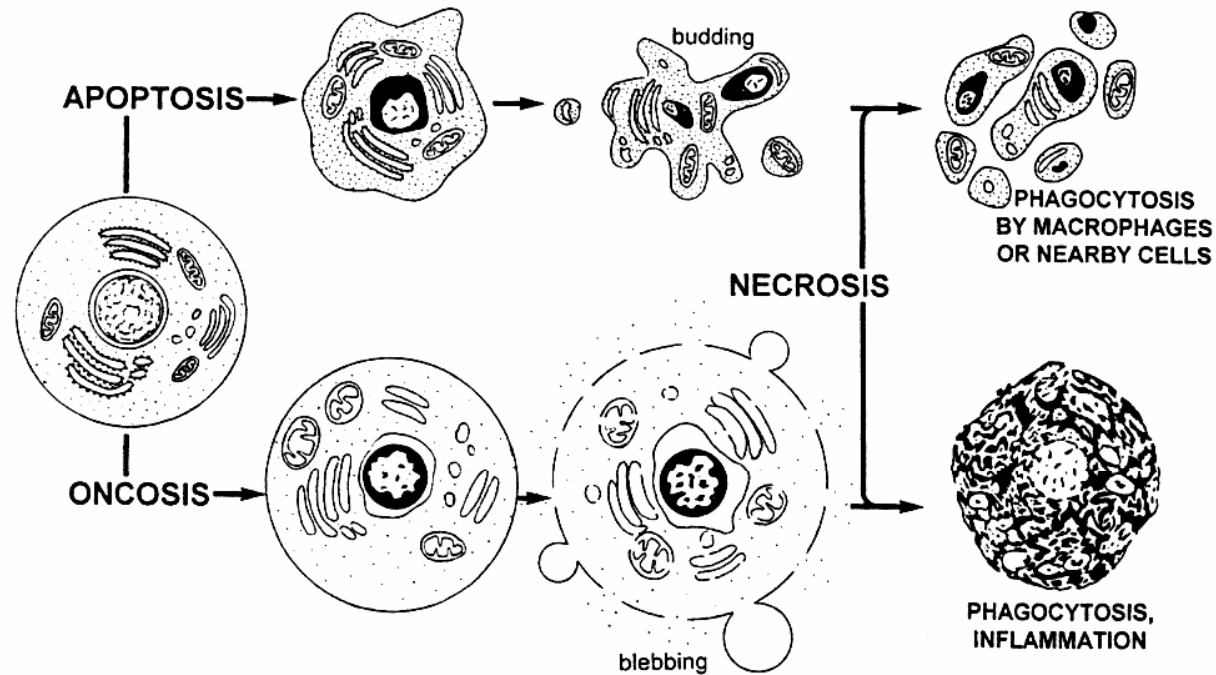
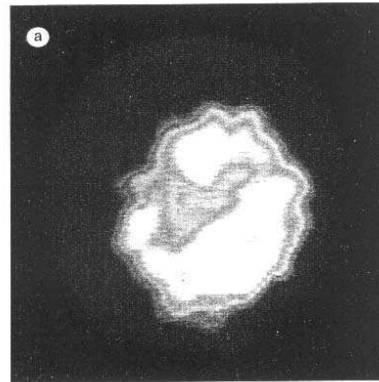

FIG. 3. Schematic representation of apoptosis, oncosis, and necrosis, according to taxonomy of cell death proposed by Majno and Joris (67). The early stages of apoptosis are characterized by a relatively intact plasma membrane and intracellular changes as described in the legend to Figure 1 and in the text. During the late stage (apoptotic necrosis) the plasma membrane transport function fails resulting in cells that cannot exclude trypan blue or PI, and the remains of the apoptotic cell are

engulfed by neighboring cells. During oncosis, cell mitochondria swell concomitant with a distortion of the mitochondrial structure and swelling of the whole cell. For some period of time, however, other vital cell functions are preserved albeit to different degrees. Rupture of the plasma membrane leads to a necrotic stage (oncotic necrosis) which is associated with local inflammation (modified, after Majno and Joris, ref. 67).

Stage of apoptosis viewed by confocal fluorescence microscopy



Viable cell

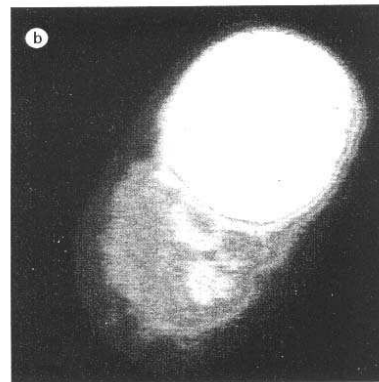

Early stage of apoptosis

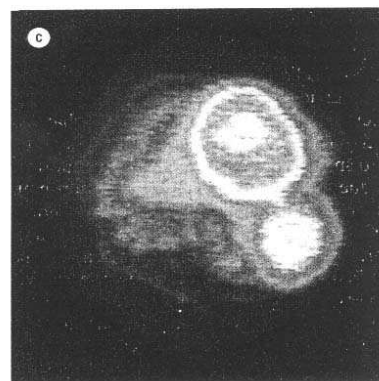

Mid-stage of apoptosis

Analysis of DNA fragmentation of apoptosis

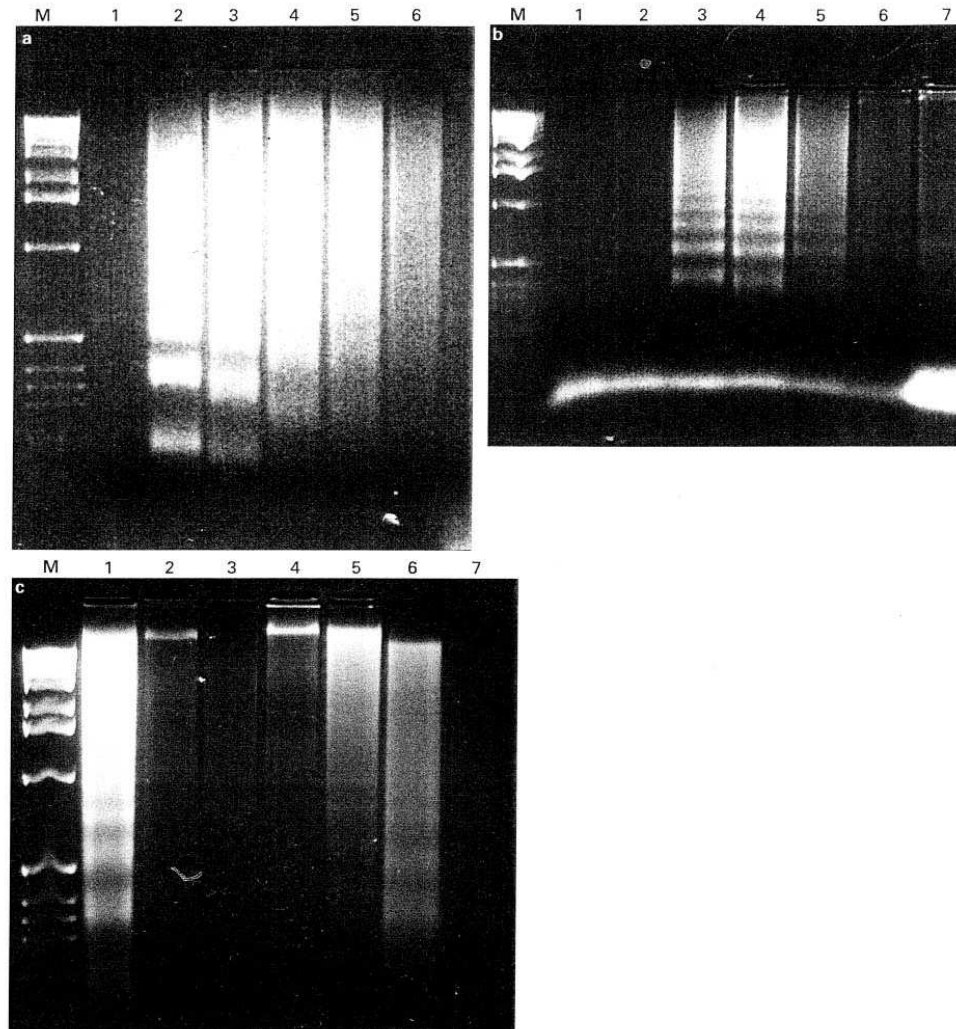
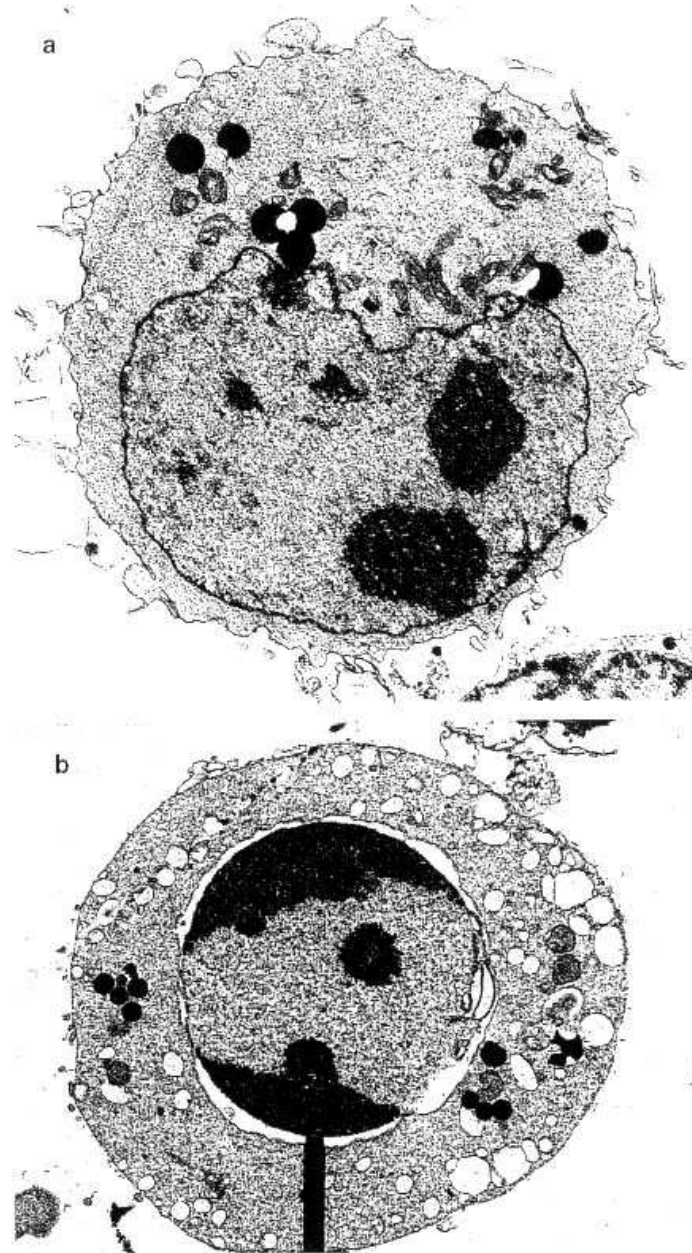
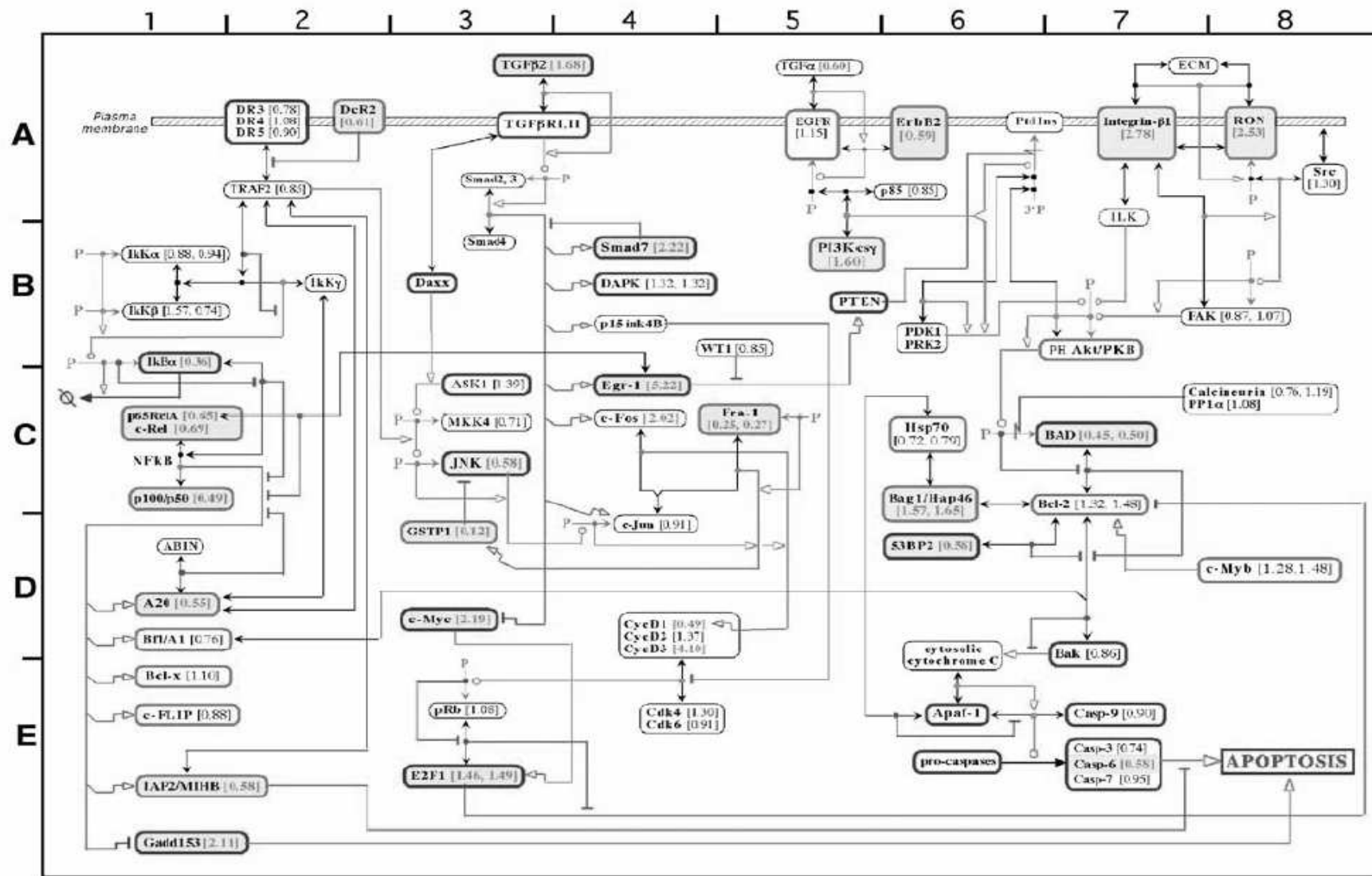

Fig. 4—Analysis of DNA fragmentation of apoptosis from three cell lines. (a) HL-60 cells, exposed to camptothecin ($0.5 \mu\text{M}$). Lanes: M=marker lane containing a 1 kb ladder of DNA fragments from 0.5 to 12.0 kb; 1=control, time 0; 2=+camptothecin, time 6 h; 3=+camptothecin, time 12 h; 4=+camptothecin, time 24 h; 5=+camptothecin, time 30 h; 6=+camptothecin, time 48 h. (b) HL-60 cells exposed to EPA ($100 \mu\text{M}$). Lanes: M=marker lane; 1=control, time 6 h; 2=+EPA, time 6 h; 3=+EPA, time 12 h; 4=+EPA, time 24 h; 5=+EPA, time 30 h; 6=+EPA, time 49 h; 7=control, time 49 h. (c) *c-myc*-transfected fibroblasts after serum withdrawal (lanes 1–5) and Mia-Pa-Ca-2 cells exposed to $100 \mu\text{M}$ EPA (lanes 6 and 7). Lanes: M=marker lane as above; 1=fibroblasts detaching between 23 and 35 h; 2=fibroblasts attached at 48 h; 3=fibroblasts detaching between 35 and 48 h; 4=fibroblasts attached at 74 h; 5=fibroblasts detaching between 48 and 74 h; 6=Mia-Pa-Ca-2 cells detaching between 23 and 35 h showing a 'chromatin ladder' of apoptosis; 7=Mia-Pa-Ca-2 cells detaching between 35 and 48 h.

Viability and apoptotic cells on electron microscopy





Molekulární interakční mapa drah spojených s apoptózou, u nichž byly pozorovány rozdíly v genové expresi.

Molekuly podporující apoptózu – červená

Molekuly suprimující apoptózu – zelená

Expres mRNA se mění očekávaným směrem – žlutě, opačným směrem - modře

Anti-apoptické signály z NF-κB

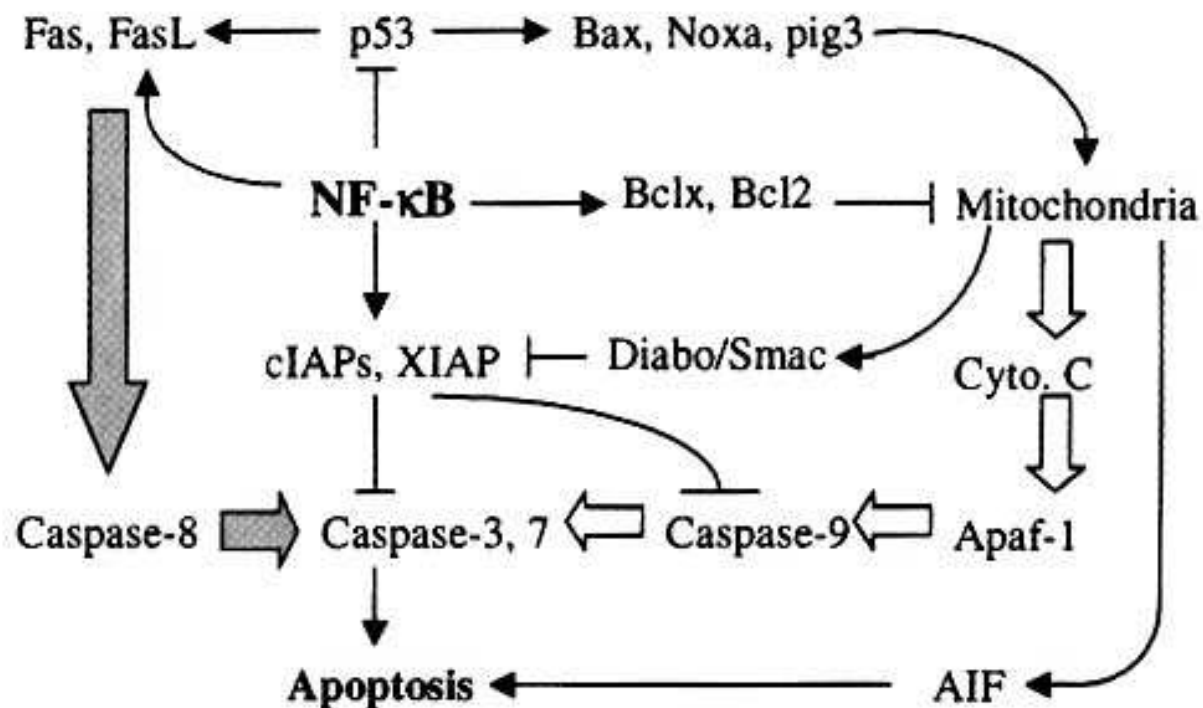
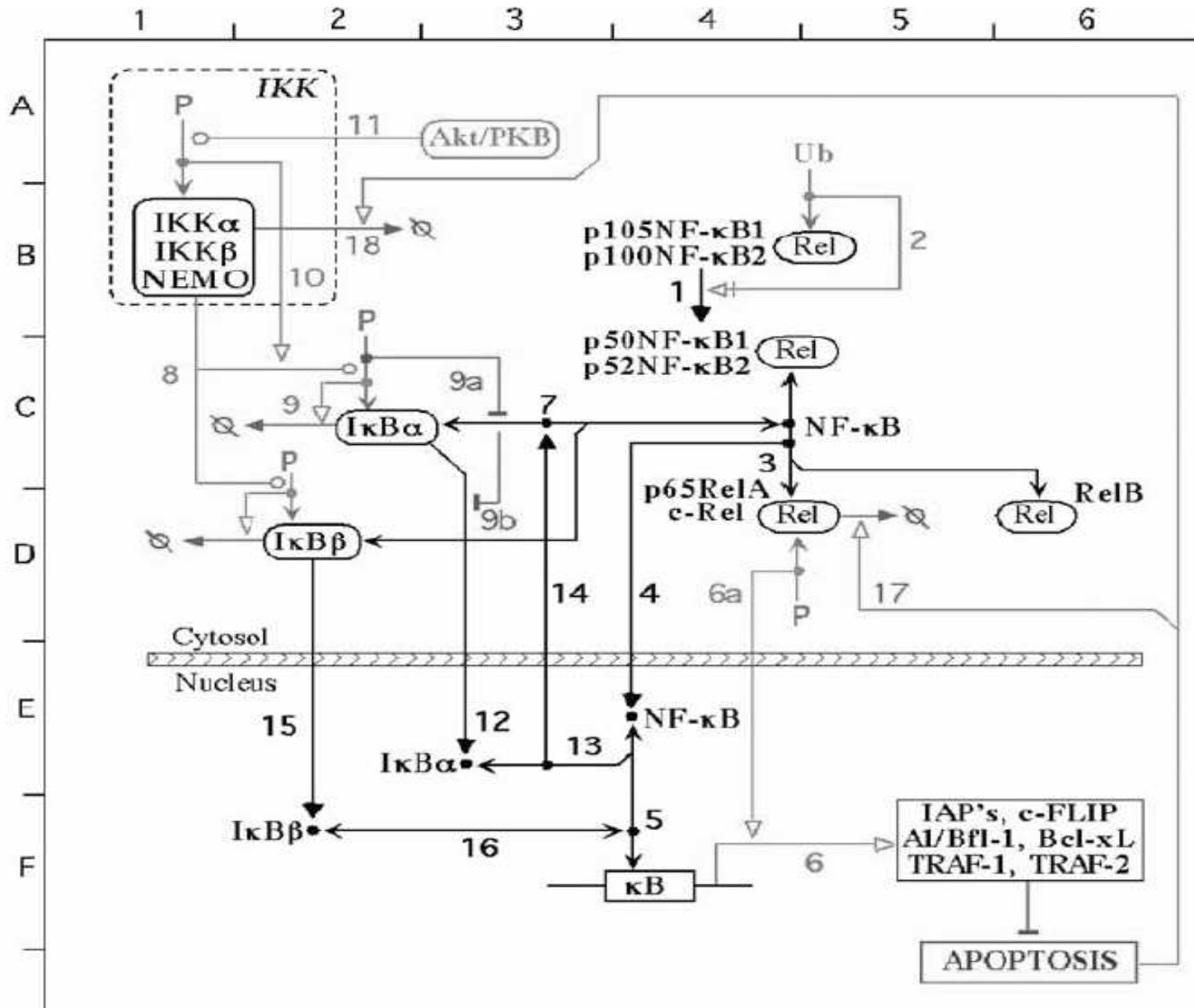

Figure 2. Possible targeting point of anti-apoptotic signals from NF-κB. Intrinsic (**open arrows**) and extrinsic (**filled arrows**) apoptosis pathways are depicted. The effector caspases, such as caspase-3 and caspase-7, are activated by upstream initiator caspases, caspase-8 and caspase-9. The initiator caspases themselves are activated by either ligands binding to the death receptor complex or cytochrome c released from damaged mitochondria. An anti-apoptotic effect of NF-κB is achieved through its up-regulation of IAPs that inhibits caspases and Bcl-xl that protects mitochondria from further damaging. →, activation; ⊥, inhibition.

Molekulární interakční mapa NFκB/I κB



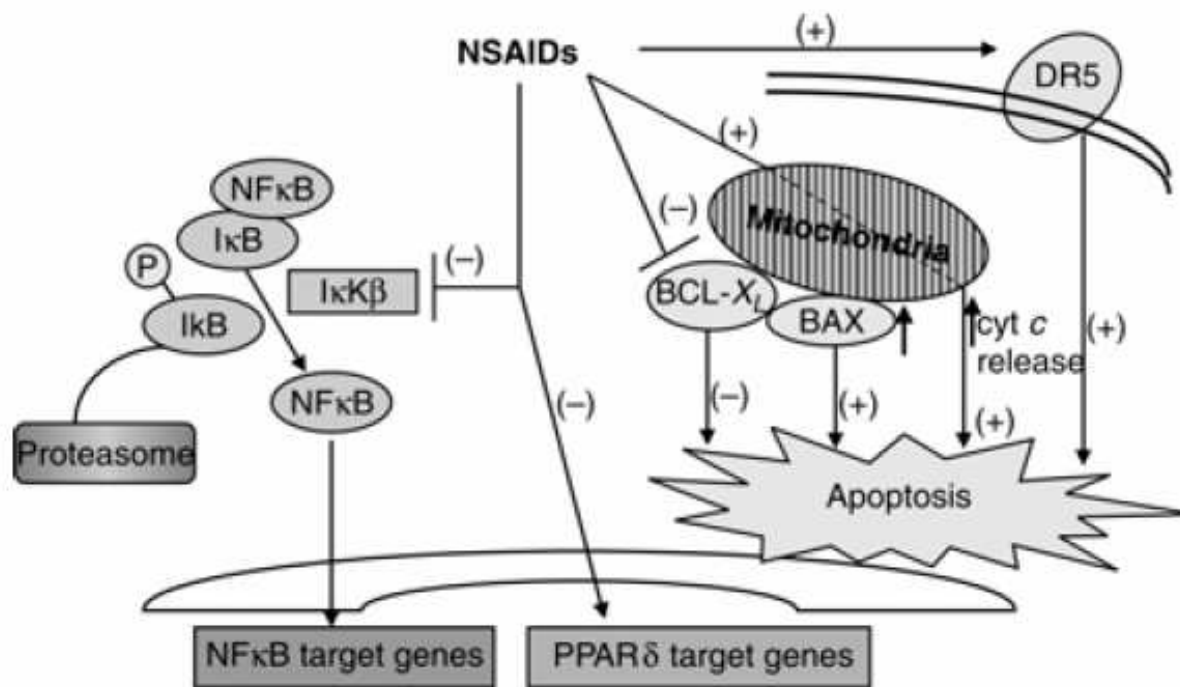

Figure 2. (1) NSAIDs inhibit activity of IκB kinase β (IκKβ) which inhibits NFκB signaling by blocking the degradation of IκB and thereby, preventing the translocation of NFκB to the nucleus. (2) NSAID (sulindac) can inhibit the DNA binding activity of PPARδ. (3) NSAIDs trigger both the mitochondrial and death receptor-mediated apoptotic pathways with resultant cytochrome c (cyt c) release and DR5 up-regulation, respectively. NSAIDs also inhibit the anti-apoptotic Bcl- X_L protein resulting in an increase in the ratio of pro-apoptotic BAX: Bcl-X_L

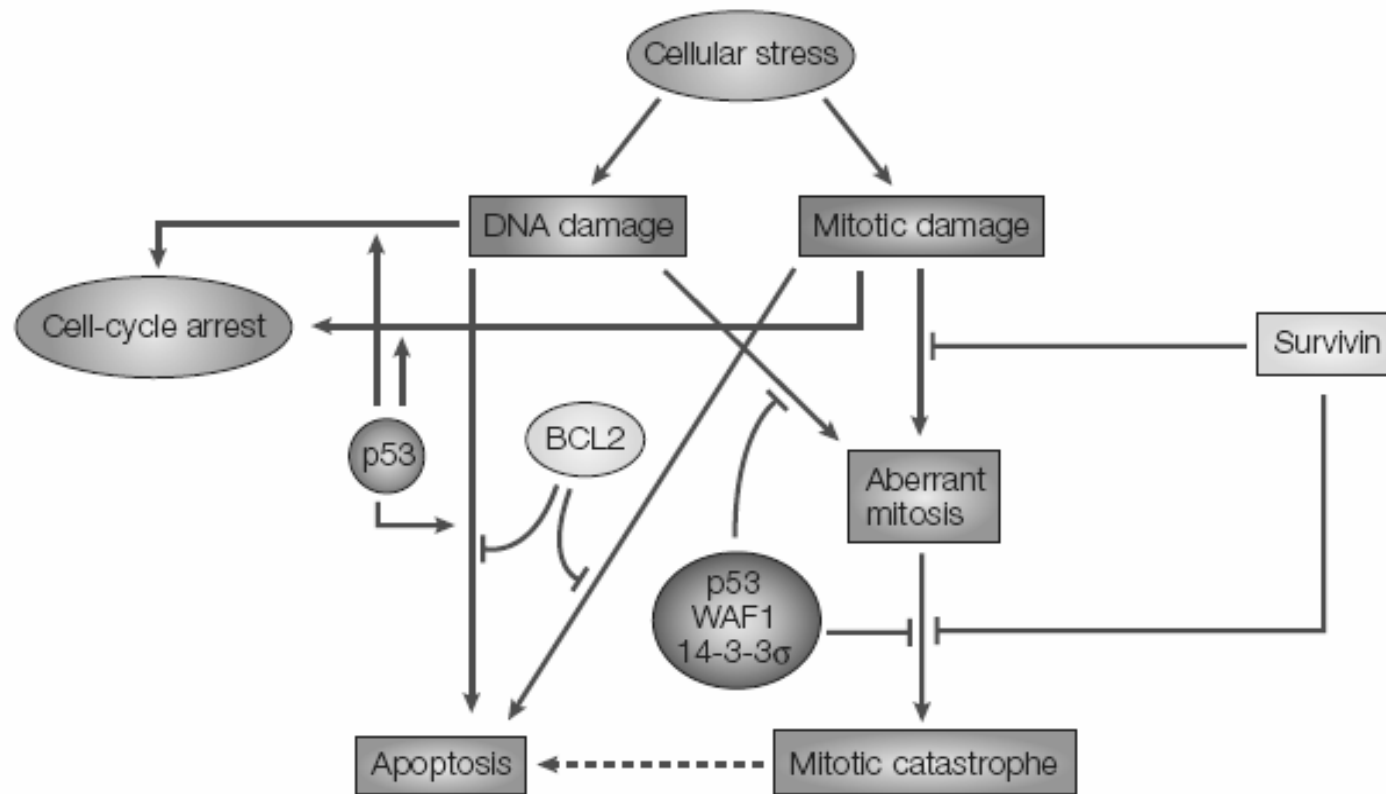
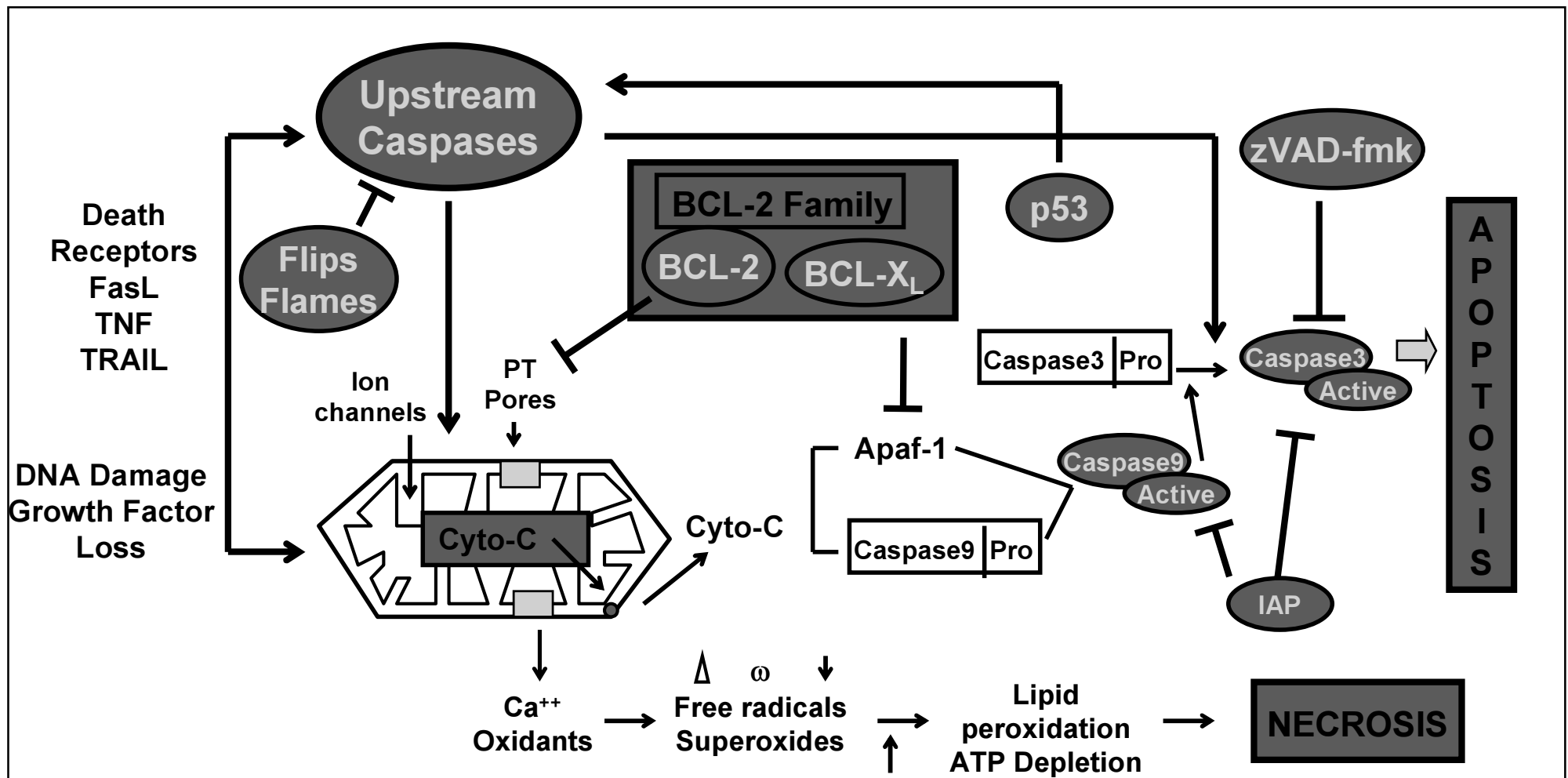

Figure 2 | **Model for survivin-mediated protection against mitotic catastrophe.** Cellular stresses induce both DNA damage and defects in the mitotic machinery (mitotic damage). DNA damage can lead to cell-cycle arrest, apoptosis or aberrant mitosis. Mitotic damage can lead to cell-cycle arrest, apoptosis or mitotic catastrophe through aberrant mitosis. In situations in which p53 activity has induced apoptosis, BCL2 expression can rescue cells from death. p53 — and its target genes that encode WAF1 and 14-3-3 σ — also help to prevent aberrant mitosis and mitotic catastrophe. The normal function of survivin is to maintain the integrity of the mitotic spindle and promote mitotic progression. Loss of survivin induces cell-cycle arrest and cell death by mitotic catastrophe in a manner that is independent of both p53 and BCL2. However, loss of survivin also induces p53 and WAF1 expression, perhaps indirectly triggering p53-dependent apoptosis (dashed line).



Pathways controlling apoptosis and necrosis. Activation of death receptors, DNA damage, growth factor loss, radio- or chemotherapy can result in activation of upstream caspases, activation of mitochondria, release of cytochrome c, activation of Apaf-1, subsequent activation of downstream caspases, and finally DNA fragmentation and apoptosis. The central role of anti-apoptotic Bcl-2 family members (Bcl-2, Bcl-X_L) and of inhibitors like IAP (inhibitors of apoptosis proteins) is demonstrated. Mitochondrial activation resulting in release of Ca⁺⁺, generation of free radicals, lipid peroxidation and ATP-depletion leads to necrosis.

Oxidativní stres jako mediátor apoptózy

Mnoho látek, které indukují apoptózu jsou buď oxidanty nebo stimulatory buněčného oxidativního metabolismu. Naopak řada inhibitorů apoptózy má antioxidační účinky.

Možné mechanismy:

- ▶ Bcl-2 protein (produkt bcl-2 onkogenu) - v mitochondriích, endopl. retikulu a jaderné membráně - regulace ROS
- ▶ Aktivace poly-ADP-ribose-transferasy a akumulace p53 - polymerizace ADP-ribosy s proteiny vyústuje v rychlou ztrátu zásoby NAD/NADH, kolaps zásob ATP a smrt buňky.
- ▶ Oxidace lipidů v bun. membránách - mediatory apoptózy HPETE (po působení $\text{TNF}\alpha$)
- ▶ Aktivace genů odpovědných za apoptózu přes aktivaci specifických transkripčních faktorů jako je $\text{NF}\kappa\text{B}$ – rozporná úloha.
- ▶ AP-1, antioxidant-responsivní faktor může také přispívat k regulaci apoptózy.

Fyziologicky se ROS se tvoří v:

Peroxisomech - rozklad mastných kyselin (MK) - peroxid

Kataláza využívá peroxid v detoxifikačních reakcích

Mitochondriích - respirační cyklus a katabolismus MK. Mn superoxid dismutasa a další antioxidanta v mitochondriích udržují nízkou hladinu těchto ROS.

Byla prokázána silně inverzní korelace mezi produkcí ROS mitochondriemi a délkou existence savčího druhu.

Mikrosomální systém transportu elektronů (cytochrome P450) - vyžaduje elektrony z NADPH k produkci částečně redukovaných kyslíkových druhů.

ROS vznikají jen za přítomnosti selektovaných xenobiotik - superoxidový radikál - konverze na reaktivnější hydroxylový radikál

Mimobuněčné děje - oxidativní vzplanutí aktivovaných makrofágů - NADPH-oxidáza -superoxid.

Antioxidační obranný systém:

- ▶ neenzymatický: molekuly jako vit E, vit C a glutation působící přímo na ROS
- ▶ enzymatický: superoxid dismutáza (SOD), kataláza (CAT), GSH peroxidasa (GSH-Px) a GSH S transferasa (GST). Mohou buď přímo odstraňovat ROS nebo působit recyklaci neenzymatických molekul.

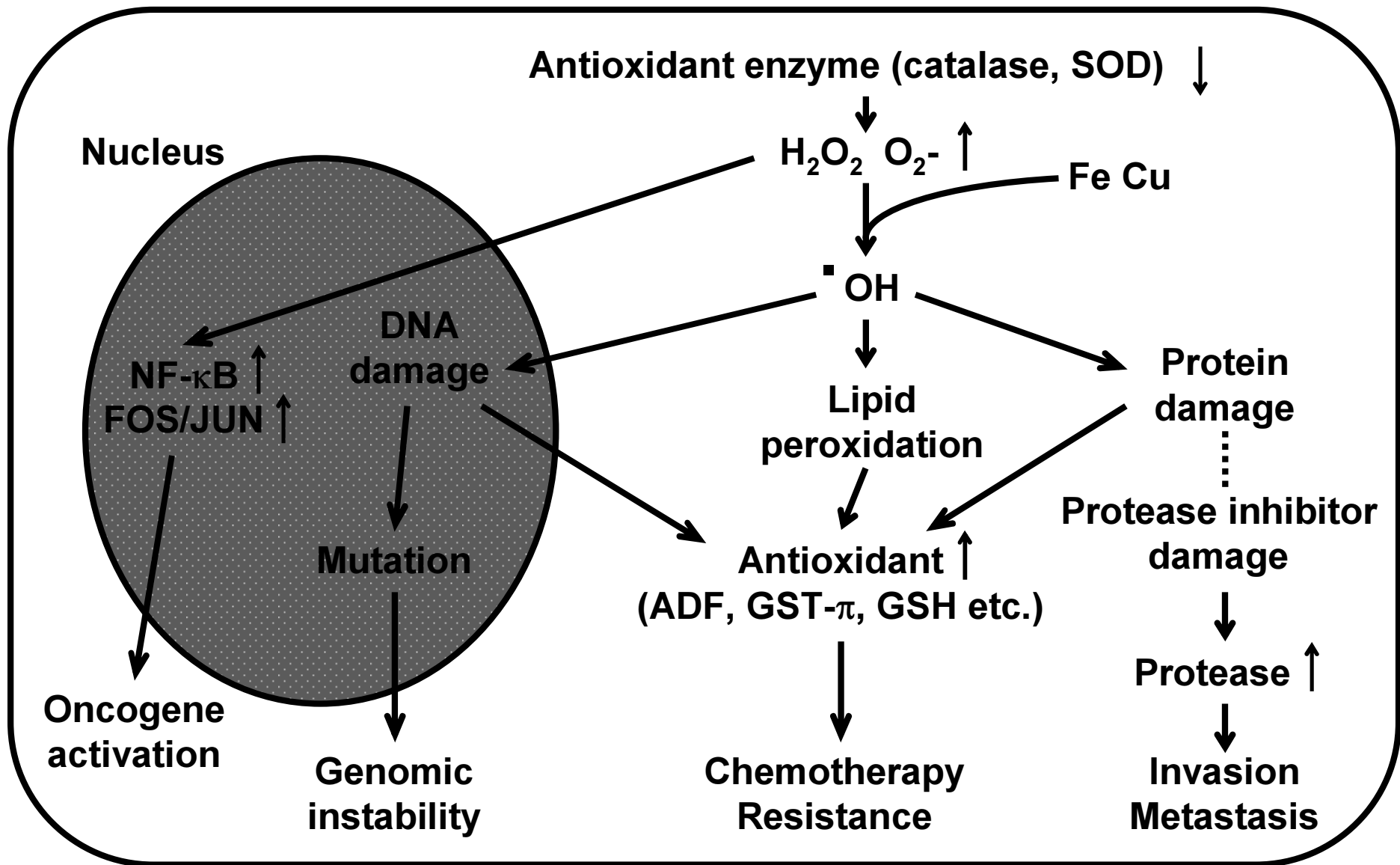

Schematický přehled úlohy reaktivních kyslíkových radikálů v karcinogenezi. SOD, superoxide dismutase; ·OH, hydroxyl radical; ADF, adult T-cell leukemia-derived factor; GST, glutathione S-transferase; GSH, glutathione.

Pravděpodobný mechanismus chemopreventivního účinku vitamínu C v karcinogenezi

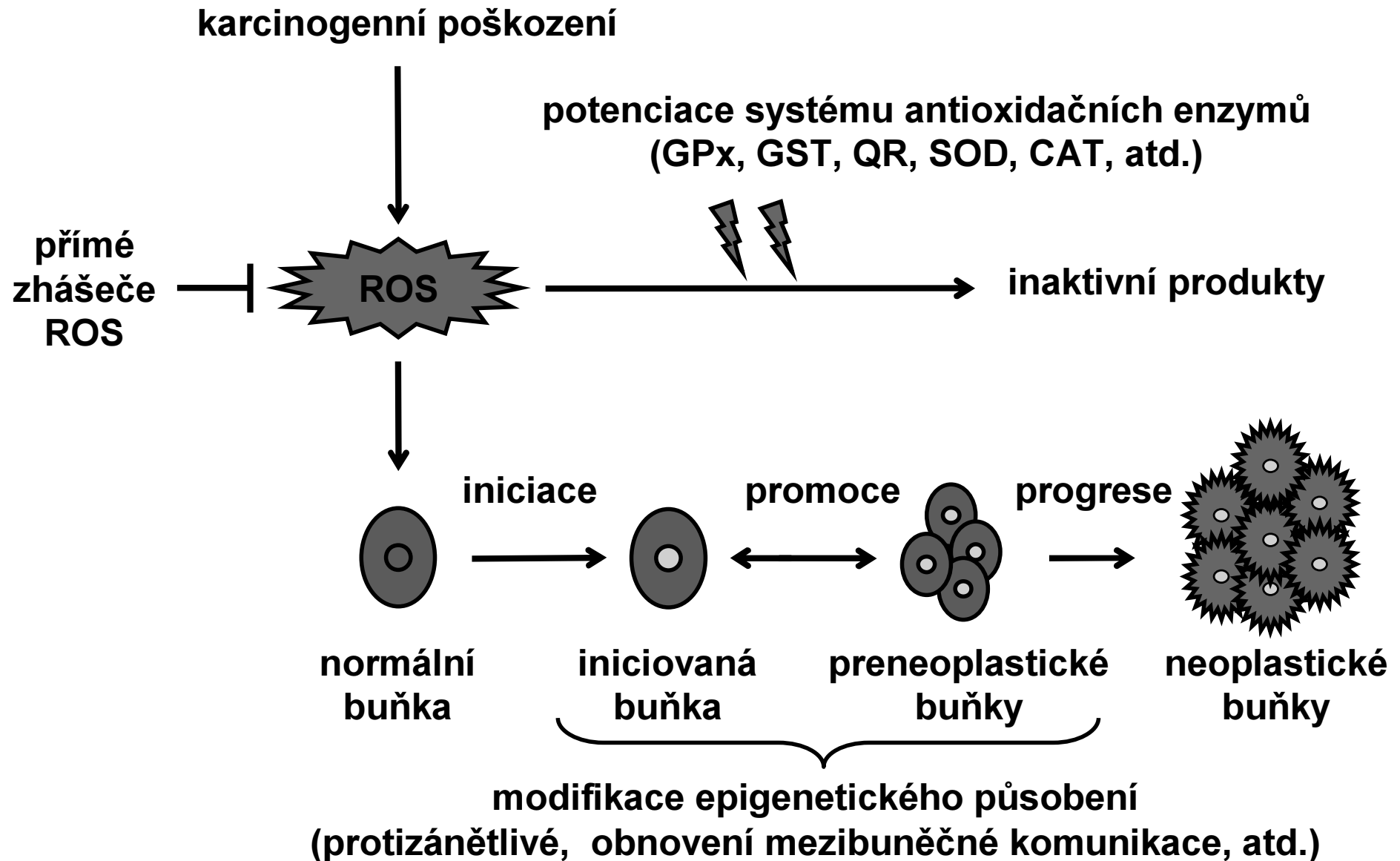

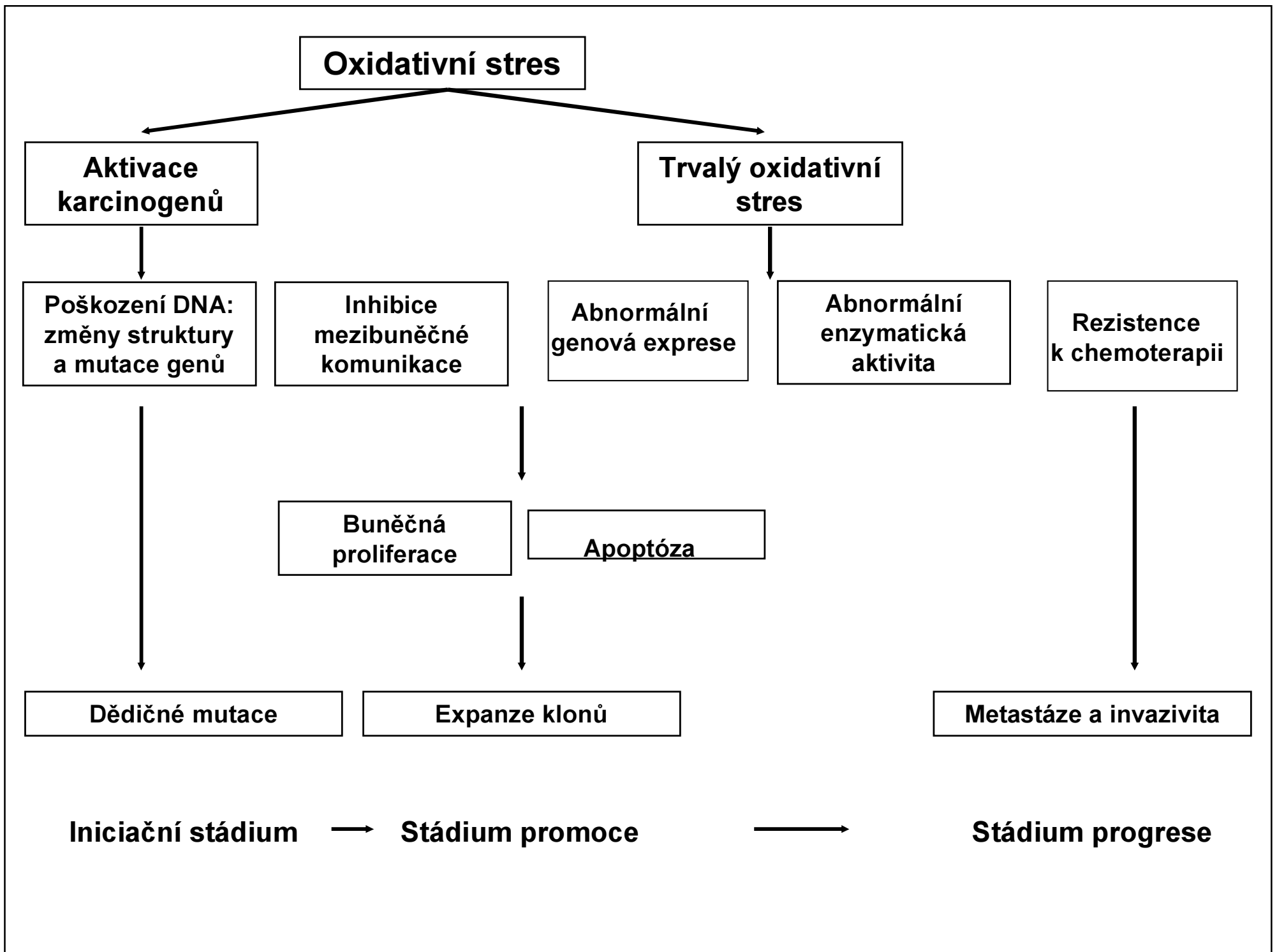

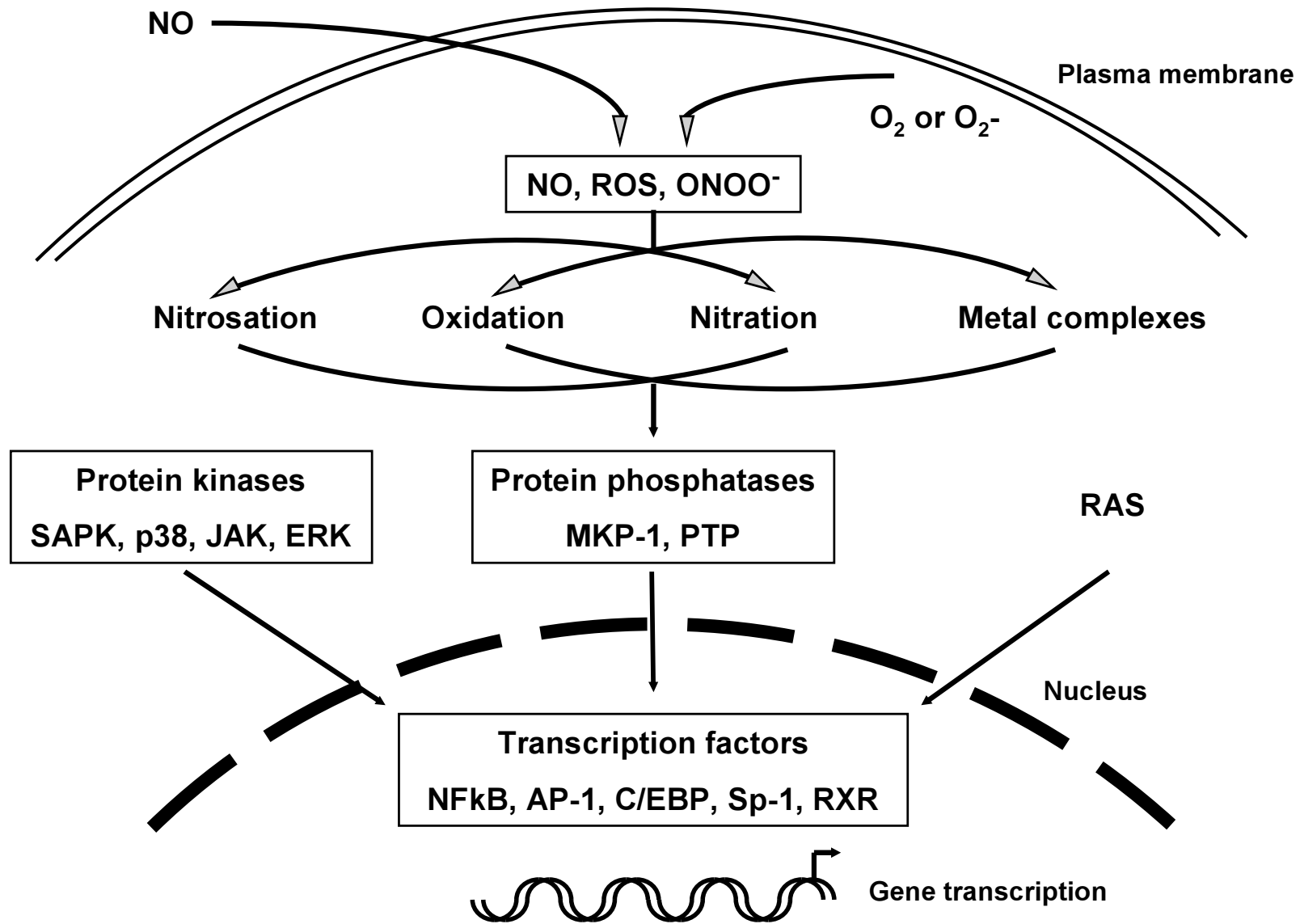

Hypotetické schéma ilustrující modulaci signálů oxidem dusíku (NO) vedoucí ke změně aktivity transkripčních faktorů a exprese genů. (*AP-1* activator protein 1, *ERK* extracellular signal-regulated kinases, *JAK* Janus protein kinases, *MKP-1* mitogen-activated protein kinase phosphatase-1, *NFκB* nuclear factor κB, *NO* nitric oxide, *O₂⁻* superoxide, *ONOO⁻* peroxynitrite, *p38* p38 mitogen-activated protein kinases, *PTP* protein tyrosine phosphatase, *Ras* small GTP-binding protein, *ROS* reactive oxygen species, *RXR* retinoid X receptor, *SAPK* stress-activated protein kinases)

OXIDATIVNÍ STRES A REDOXNÍ NEROVNOVÁHA VE STŘEVĚ

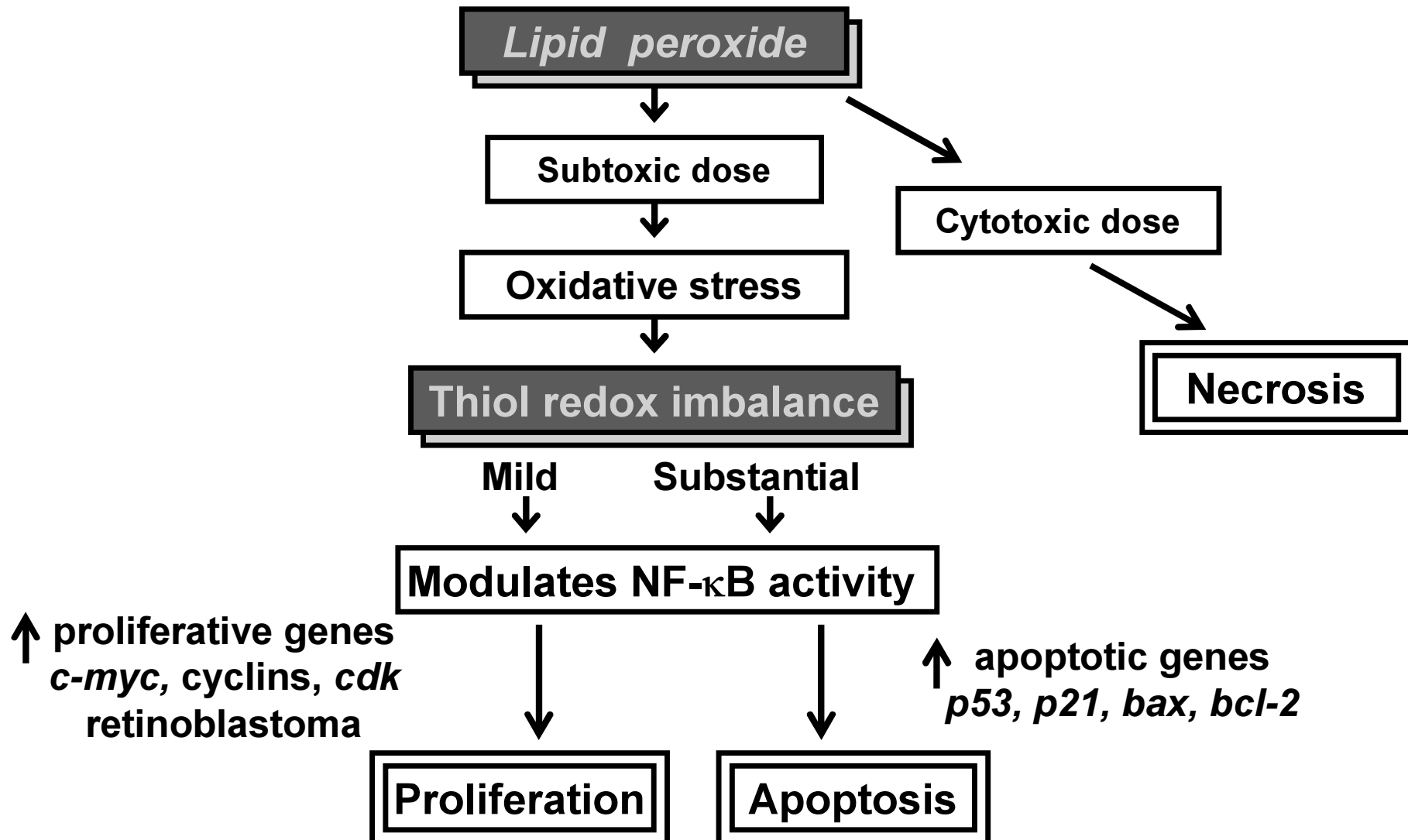

Hypotéza buněčné proliferace a apoptózy indukované lipidovou peroxidací. NF- κ B, jaderný transkripční faktor κ B.

OXIDATIVNÍ STRES A REDOXNÍ NEROVNOVÁHA VE STŘEVĚ

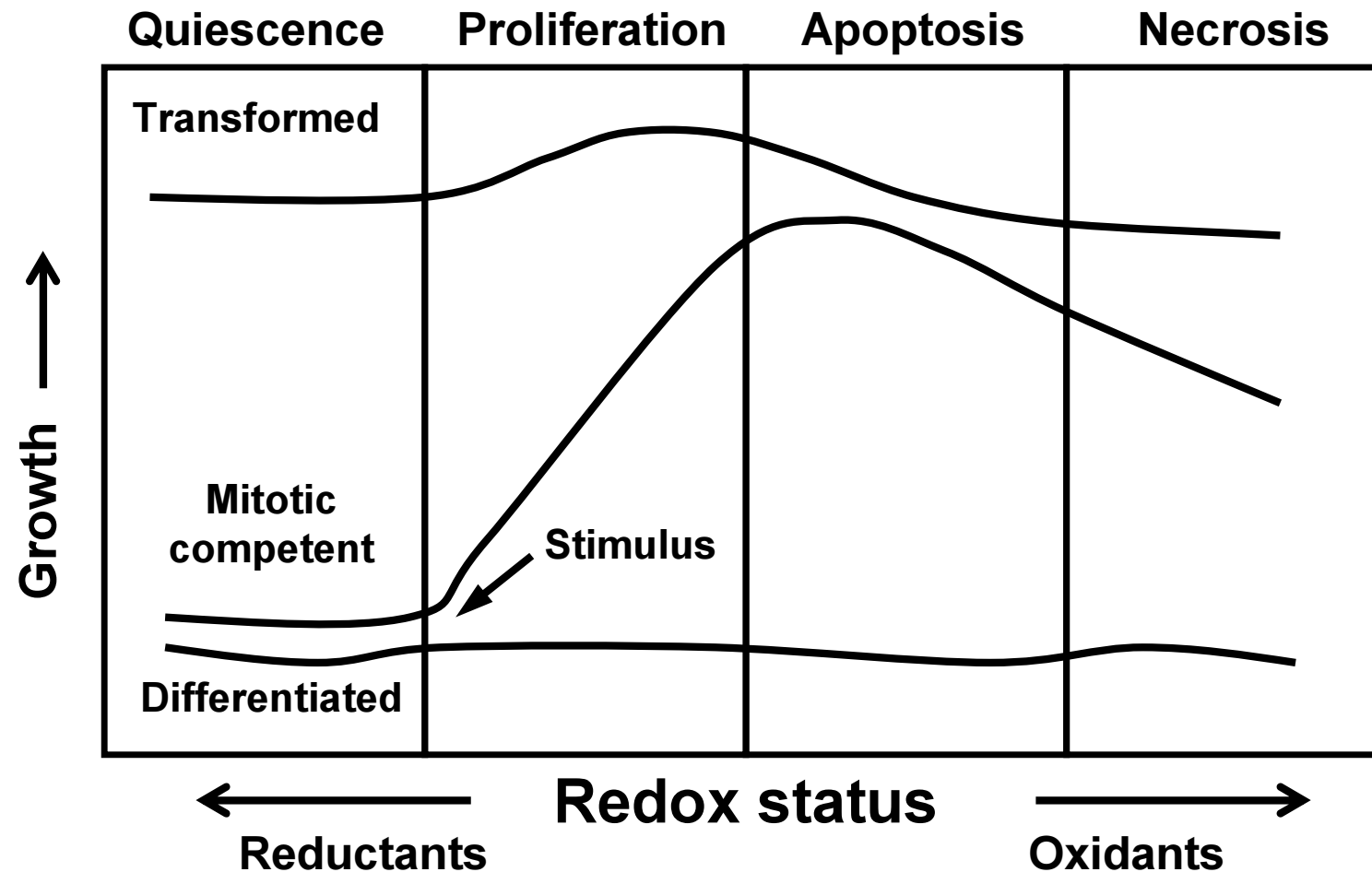

Buněčná odpověď na oxidativní stres a oxidačně-redukční (redox) stav. Křivky představují terminálně diferencované, mitoticky kompetentní a transformované buněčné typy.

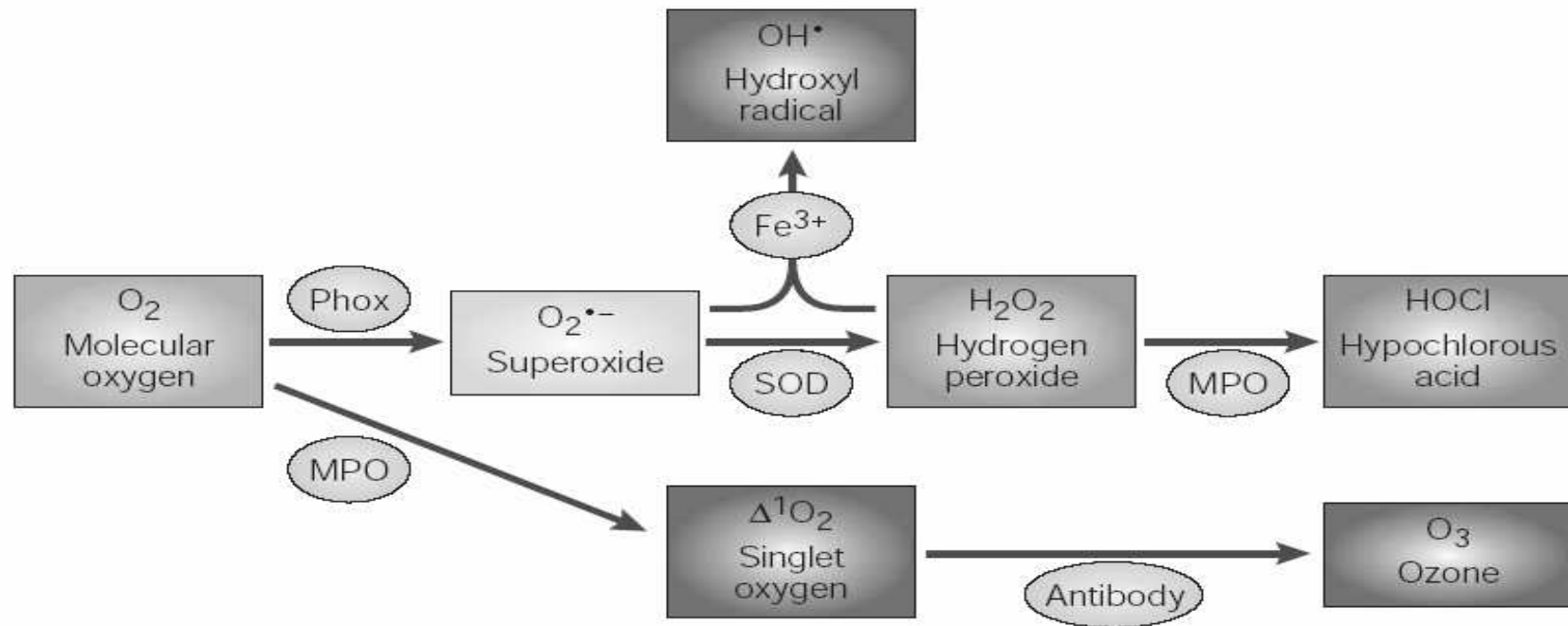

Figure 1 | **Reactive oxygen species.** Superoxide is generated from various sources, which include the NADPH oxidase (NOX) enzymes (such as the phagocyte NOX, Phox). Two molecules of superoxide can react to generate hydrogen peroxide (H_2O_2) in a reaction known as dismutation, which is accelerated by the enzyme superoxide dismutase (SOD). In the presence of iron, superoxide and H_2O_2 react to generate hydroxyl radicals. In addition to superoxide, H_2O_2 and hydroxyl radicals, other reactive oxygen species (ROS) occur in biological systems. In inflamed areas, these include hypochlorous acid (HOCl), formed in neutrophils from H_2O_2 and chloride by the phagocyte enzyme myeloperoxidase (MPO); singlet oxygen, which might be formed from oxygen in areas of inflammation through the action of Phox and MPO-catalysed oxidation of halide ions⁶⁴; and ozone, which can be generated from singlet oxygen by antibody molecules^{65,66}. The last reaction is likely to be important in inflamed areas in which antibodies bound to microorganisms are exposed to ROS produced by phagocytes. The colour coding indicates the reactivity of individual molecules (green, relatively unreactive; yellow, limited reactivity; orange, moderate reactivity; red, high reactivity and non-specificity). For further details see BOX 1.

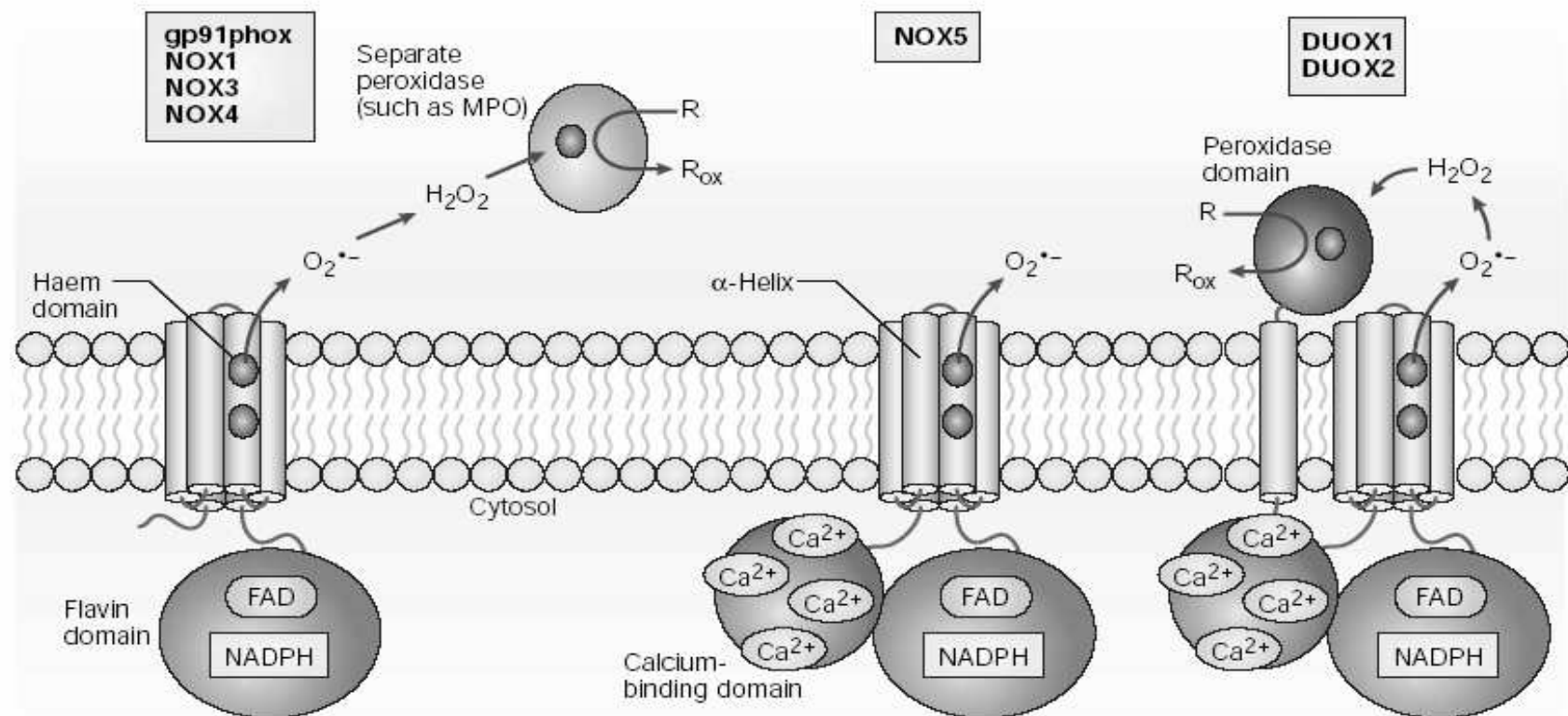
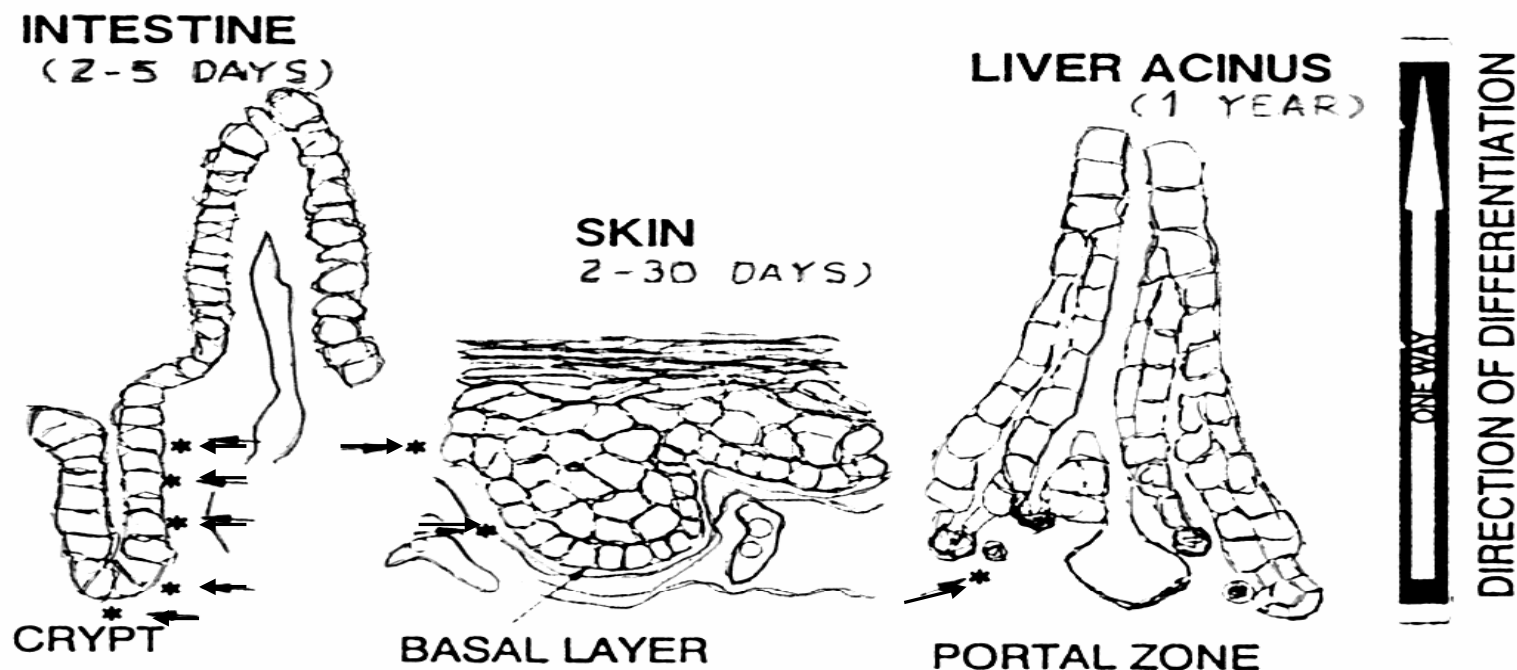

Figure 2 | **Transmembrane topology and domain structure of NOX and DUOX enzymes.** NADPH oxidase 1 (NOX1), NOX3 and NOX4 are similar in size and domain structure to the well-studied gp91phox, also known as NOX2. They contain an amino-terminal hydrophobic domain that is predicted to form six transmembrane α -helices. This region contains five conserved histidine residues, four of which provide binding sites for two haems. Haem is an iron-containing prosthetic group found in enzymes, electron transfer proteins and oxygen-binding pigments such as haemoglobin. The iron in haems is capable of undergoing reduction and re-oxidation, thereby functioning as an electron carrier. The two haems are located approximately within the two leaflets of the membrane bilayer, and together provide a channel for electrons to pass across the membrane. The carboxy-terminal portion of the molecule folds into an independent cytoplasmic domain that contains binding sites for the co-enzymes flavin adenine dinucleotide (FAD) and NADPH. The NOX enzymes catalyse the NADPH-dependent reduction of oxygen to form superoxide, which can react with itself to form hydrogen peroxide (H_2O_2). For gp91phox, the H_2O_2 serves as a substrate for myeloperoxidase (MPO), but it is not known whether other NOX enzymes provide H_2O_2 for separate peroxidase enzymes. NOX5 contains the same gp91phox-like catalytic core, plus an amino-terminal calcium-binding domain. The dual oxidase (DUOX) enzymes build on the NOX5 structure by adding at the amino terminus an extra transmembrane α -helix followed by a domain that is homologous to peroxidases such as MPO. This peroxidase-homology domain is predicted to be localized on the outside of the membrane, where it can use ROS generated by the catalytic core to generate more powerful oxidant species that then oxidize extracellular substrates (R).

Srovnání obnovy buněk ve střevě, kůži a jaterních proliferonech



Comparison of cell renewal in intestine, skin, and liver proliferons. Normal cell turnover in the gastrointestinal tract, skin, and liver appears to proceed similarly, but at greatly different rates. The small arrows and asterisks denote the location of proliferating stem cells. Proliferating cells may be demonstrated in crypts of the gastrointestinal tract up to the opening of the crypt, limited to the basal layer of the skin, and rarely in the liver. Toxic or destructive events may increase the proliferation rate in these organs so that proliferating cells may be seen in higher layers in the skin and in the hepatic cords. Induction of proliferation of hepatic stem cells requires either massive loss of hepatocytes or inhibition of hepatocyte proliferation by a necrotic dose of genotoxic carcinogen.

KARCINOGENEZE KŮŽE

Epidermis je vysoce účinné signální rozhraní mezi vnějším prostředím a tělem.

Tzv. hyperplastická transformace zahrnuje obranné reakce jako je zánět a protektivní a reparační procesy jako je vývoj hyperplasie a hojení ran.

Keratinocyty epidermis jsou nejvíce exponované a mají hlavní kontrolní funkci. Po podráždění a poškození velmi rychle reagují (aktivují se) a uvolňují řadu signálních molekul, jako jsou cytokiny, růstové faktory a prozánětlivé mediátory.

Význam metabolismu AA – eikosanoidy působí jako tkáňové mediátory a účastní se kontroly proliferace a diferenciací, apoptózy, zánětu, invaze leukocytů apod. Bylo prokázáno, že tvorba eikosanoidů je důležitým dějem při rozvoji nádorů.

Interakce s cytokiny

In vivo – vícestupňový model a synergismus genotox. a negenotox. faktorů.

Iniciace je navozena genotox. látkou a k promoci dochází opakovanou indukcí regenerativní hyperproliferační odpovědi po působení buď nádorovými promotory jako je TPA nebo po mechanickém poranění.

Proces začíná reverzibilní hyperplasií kůže, následuje objevení se klonálních preneoplastických poškození (revers. nebo irevers. papilomy) a končí vznikem invazivních a metastázuujících karcinomů kůže.

Důležitou roli zde hrají ROS, které vznikají z velké části oxidativním metabolismem lipidů. Antioxidanta a vychytávače radikálů mohou karcinogenezi kůže inhibovat, tj. působí chemopreventivně.

Linie kožních buněk a typy nádorů.

Fenotyp epidermálního karcinomu se vztahuje ke stadiu diferenciace buněčného typu, kde se exprimuje maligní fenotyp.

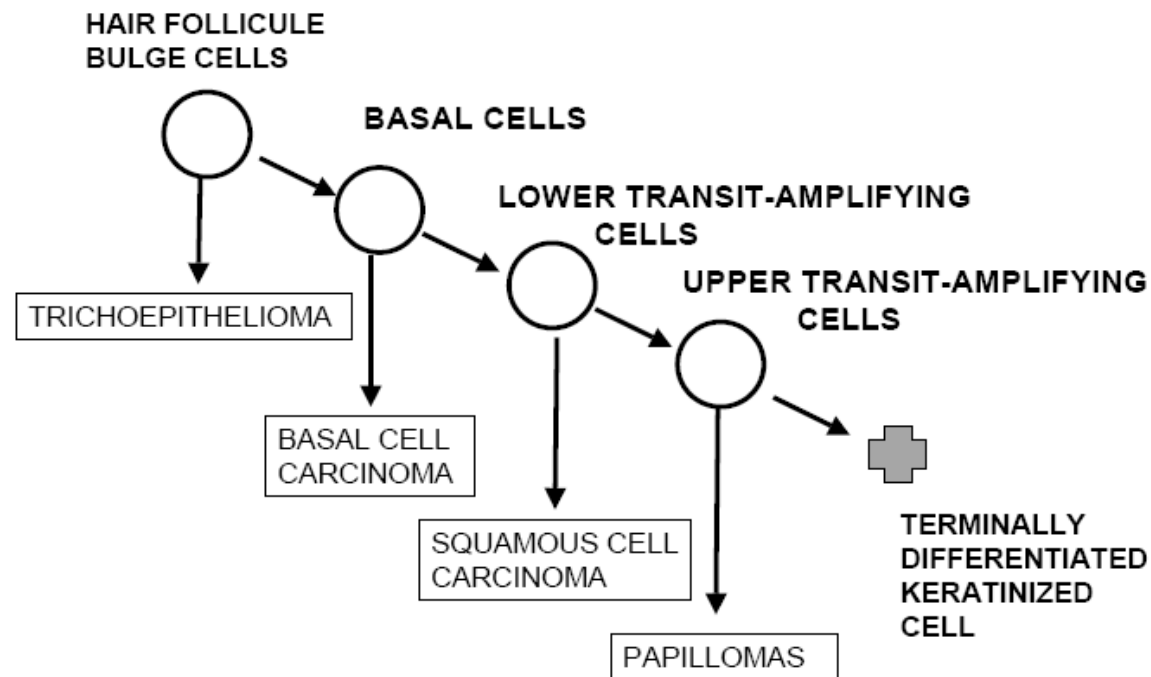

Fig. 6. Skin cell lineage and cancer type. The phenotype of epidermal carcinomas is related to the stage of differentiation of the cell types in the skin where the malignant phenotype is expressed. The most primitive cell is in the bulb of the hair follicle, and the most differentiated cell is the terminally differentiated keratinized cell.

Epidermální karcinomy jsou často obklopeny oblastí morfologicky pozměněných buněk, často s mutacemi (p53) vedoucími k abnormální proliferaci. Další mutace (např- c-myc pak vedou k maligní transformaci.

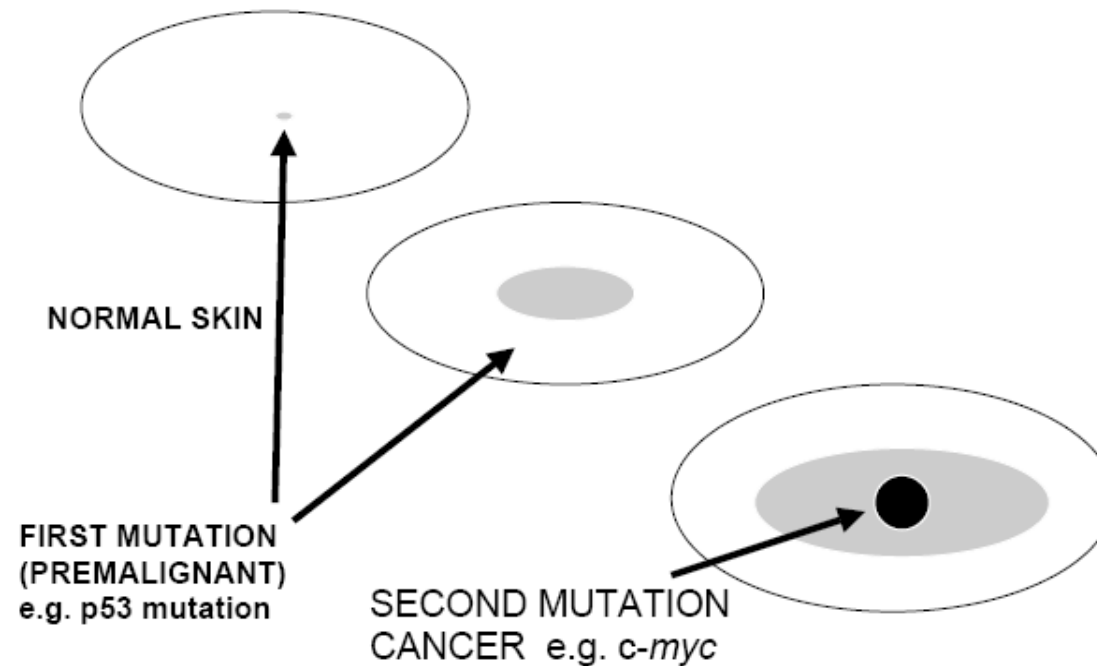

Fig. 7. Field Cancerization. Epidermal carcinomas are frequently found to be surrounded by a “field” of morphologically altered cells. These cells are believed to be changed by mutation or loss of a gene such as p53, which produces abnormalities in proliferation. It is postulated that a second mutation, such as in *c-myc*, then leads to malignant transformation.

Úloha metabolismu AA

- ▶ enzymy se indukují a AA a eikosanoidy se uvolňují po působení nádorových promotorů
- ▶ zatímco indukce je přechodná v normální tkáni, v neoplastických místech je konstitutivní
- ▶ díky mutaci v ras onkogenu a dalším genetickým defektům působí na neoplastické buňky i některé autokrinně stimulované faktory jako např. $TGF\alpha$, který dále indukuje uvolňování AA z fosfolipidů a de novo syntézu kritických enzymů metabolismu AA
- ▶ nádorech kůže je zvýšené množství prostaglandinů a 8- a 12- HETE
- ▶ dochází k aberantní expresi enzymů jako je PGH syntáza 2 (COX 2) a 8- a 12- lipoxygenáza.
- ▶ chemoprevence – využití inhibitorů eikosanoidů

HEPATOKARCINOGENEZE

Játra - klidový orgán s velmi nízkou bazální hladinou replikace DNA.

V odpověď na specifické stimuly reagují rychlou proliferací zprostředkovanou pravděpodobně novou expresí genů.

Dediferenciace, změny v regulaci bun. cyklu, působení růst. faktorů HGF(hepatocyte growth f.) a EGF(epidermal growth f.)

K regenerativní hyperplasii dochází při reparaci poškození jater v důsledku chirurgické resekce, částečné hepatektomie nebo po působení toxických látek.

Negenotoxické karcinogeny např. peroxisom. proliferátory (PP) nebo phenobarbital - přímý mitotický stimul in vivo stimulující asi 30% buněk během 48h. Ke stimulaci dochází i u hepatocytů kultivovaných in vitro. Molekulární mechanismy nejsou zcela objasněny.

Silná korelace mezi indukcí s. DNA a následnou hepatokarcinogenitou.

Tento proces však dále závisí na ploiditě. U jaterních buněk endoreplikace - polyploidizace. Narušení regulace bun. cyklu - buňky citlivější k působení chem. látek.

Negenotoxické karcinogeny působí u hepatocytů též supresi apoptózy. Poškozené buňky pak persistují v populaci a po dalším mitogenním působení negenotox. karcinogenů z nich mohou vznikat nádory.

Při působení např. PP hrají důležitou úlohu receptory PPAR α , jejichž kvantitativní exprese je pravděpodobně odpovědná za rozdíly v citlivosti mezi hlodavci a jinými živ. druhy i člověkem.

Proliferace hepatocytů může být zprostředkována cytokiny

TNF α a IL-6 - přechod G0/G1

Hepatocyte growth factor (HGF), epidermal growth f. (EGF) a TGF α -
přechod mezi střední a pozdní G1 fází

Signály mezi různými typy buněk - Kupfferovy buňky (jaterní makrofágy)
po stimulaci PP uvolňují TNF α a IL-6 \rightarrow aktivace specifických
transkripčních faktorů jako je NF κ B nebo STAT proteinů (přenos signálů a
aktivace transkripce) v hepatocytech.

U lab. zvířat sledovány počty a velikost morfologicky a enzymaticky
změněných fokusů (v nich s. DNA a apoptóza).

Další stupeň hepatocelulární adenomy a karcinomy.

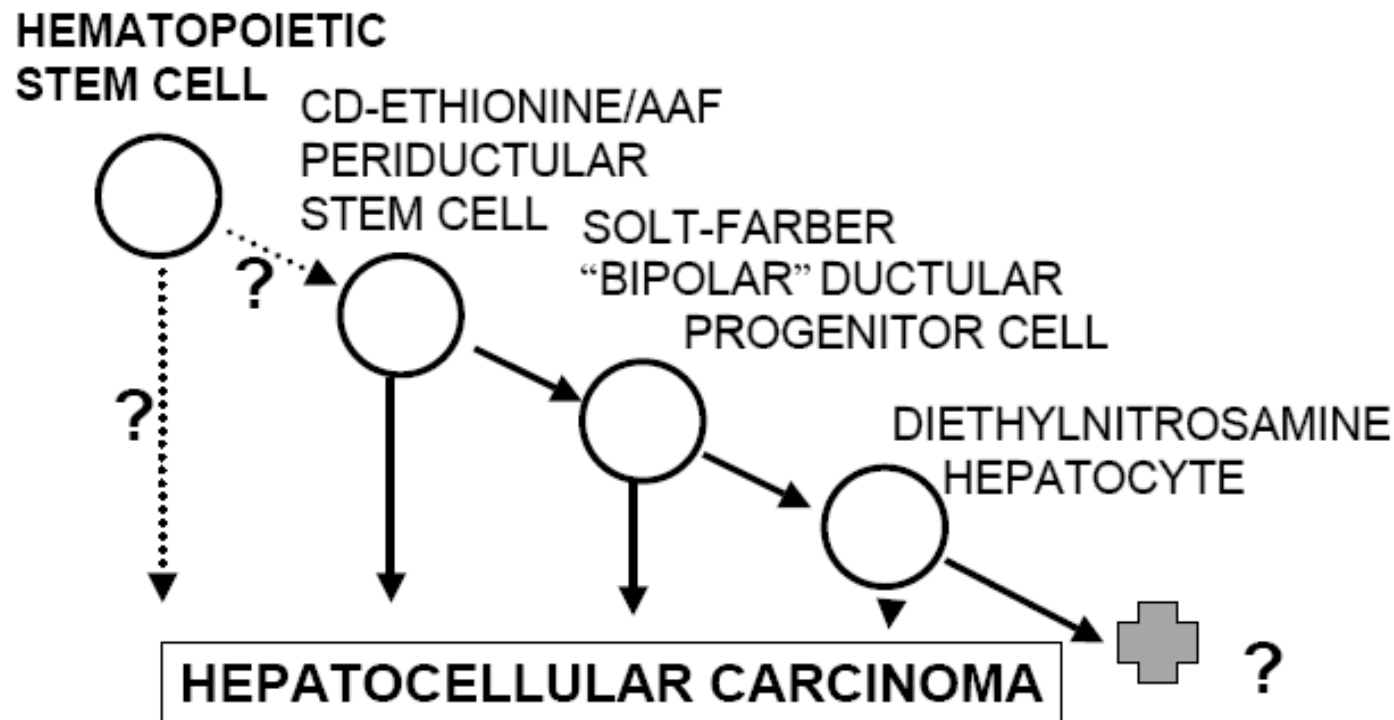
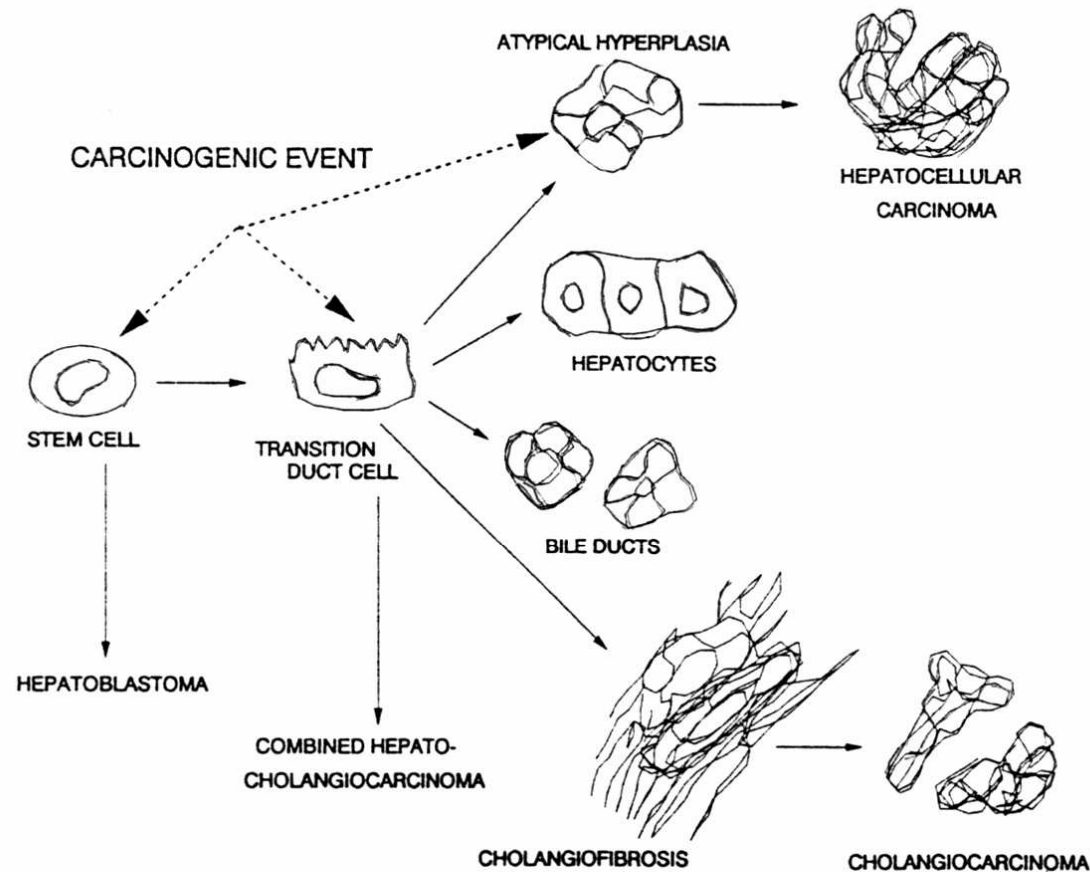

Fig. 8. Postulated stages of the hepatocytic lineage that may respond to liver injury or carcinogenic protocols. Following various models of liver injury or chemical hepatocarcinogenesis different cell types in the hepatocytic lineage may respond: 1 Undifferentiated periductular oval cells, which may arise from circulating bone marrow precursor cells. 2. Periductular cells intrinsic to the liver, 3. Bipolar ductal progenitor cells, or 4. Mature hepatocytes, which retain the potential to divide. Periductular cells respond to periportal injury induced by allyl alcohol or to choline deficiency-ethionine carcinogenesis. Bipolar ductal progenitor cells respond to injury and to carcinogenic regimens, such as the Solt-Farber model, when proliferation of hepatocytes is inhibited. Hepatocytes respond to partial hepatectomy and to carcinogenesis by diethylnitrosamine (DEN) (from [132,315]).

Hepatokarcinogeneze



Postulated levels of expression of carcinogenic events during hepatocarcinogenesis. The stem cell model of hepatocarcinogenesis postulates that carcinogenic events occur in proliferating cells at some stage during differentiation, resulting in expression of the malignant phenotype (blocked ontogeny). Because carcinogenesis most likely results from the accumulation of more than one mutation, it is likely that the first mutation (initiation) takes place at the level of the stem cell and that later mutations occurring at the level of the transition duct cells or in aberrantly differentiating cells (atypical hyperplasia or cholangiofibrosis) direct the level of expression of malignancy. Hepatoblastoma may represent tumors that arise because of multiple mutations at the stem cell level. Tumors with combined features of hepatocytes and bile ducts (hepatocholangiocarcinomas) may arise from multiple mutations at a later stage of differentiation. Hepatocellular carcinomas arise from a still later stage of differentiation.

**Peroxisome proliferators
(fibrates, phtalates, etc.)**

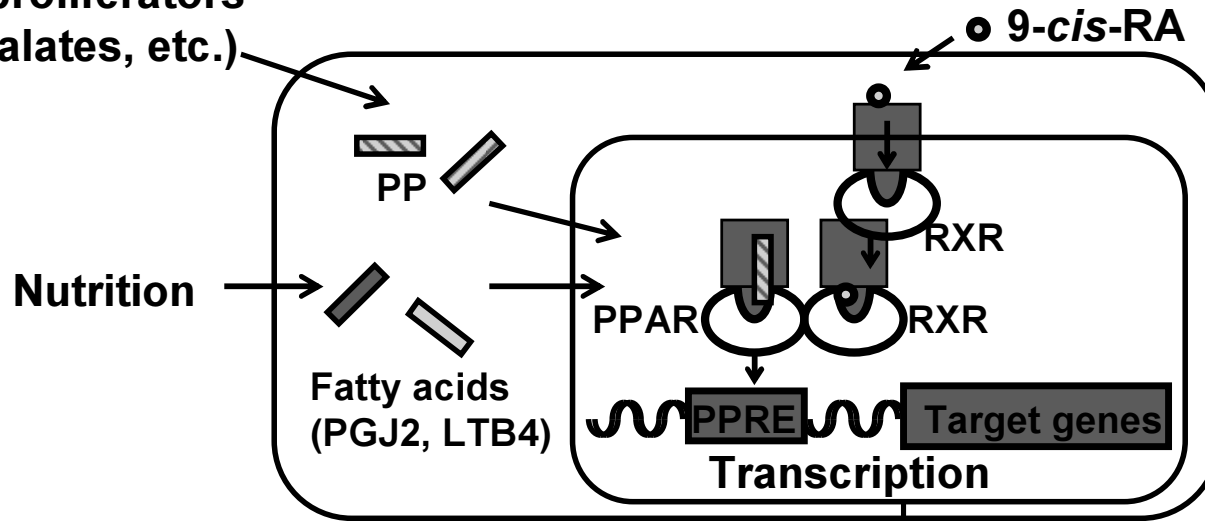

Importance of PPARs in cell proliferation, differentiation and apoptosis.

After activation, PPAR and RXR form heterodimers which bind to DNA regulatory sequences of target genes through interaction with PPRE. The control by PPARs of the transcriptional activity of target genes gives rise to biological effects which may have consequences for human health. LTB4, leukotriene B4; PGJ2, prostaglandin J2; PP, peroxisome proliferator; PPAR, peroxisome proliferator-activated receptor; PPRE, peroxisome proliferator responsive element; 9-cis-RA, 9-cis-retinoic acid; RXR, 9-cis-retinoic acid receptor.

CELL SPECIFIC RESPONSES

Proliferation

Differentiation and maturation

Apoptosis

MEDICAL RELEVANCE

* Clonal expansion of preadipocytes promoting adipogenesis (participation on PPAR γ .)

* Hypothetical risk in man of cell growth stimulation by activation of PPARs.

* Monocyte / macrophage differentiation (implication of PPAR γ) leading to accelerated atherosclerosis.

* Protective effects of PPAR α .

* Adipocyte differentiation responsible of obesity and other related disorders (implication of PPAR α .)

* Enhanced PPAR γ expression could lead to tumoral cell apoptosis and represents a therapeutic approach in malignant disease.

Schéma signálních drah PPAR

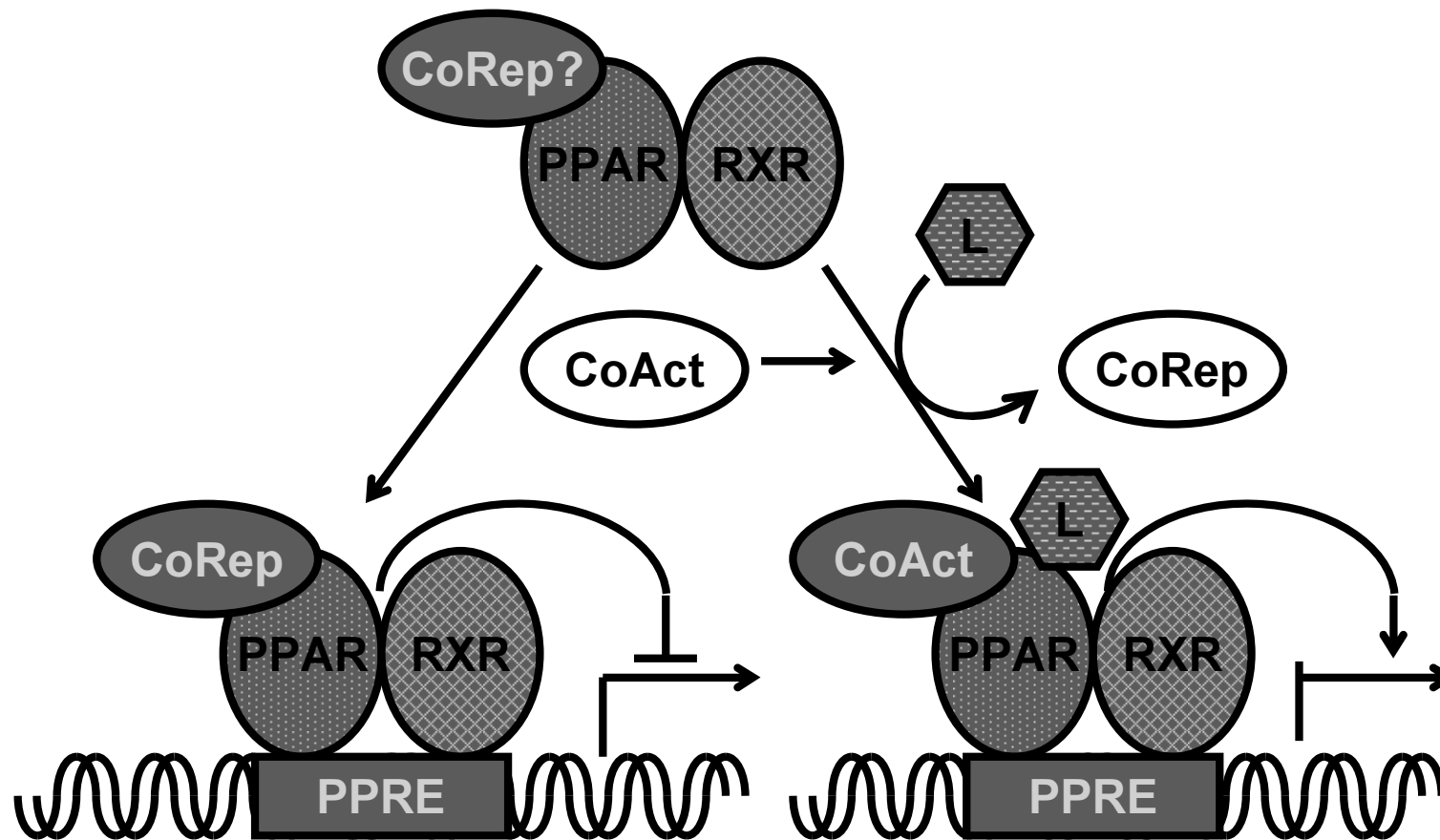

PPARs fungují jako heterodimery s jejich obvyklým partnerem - retinoidním receptorem (RXR).

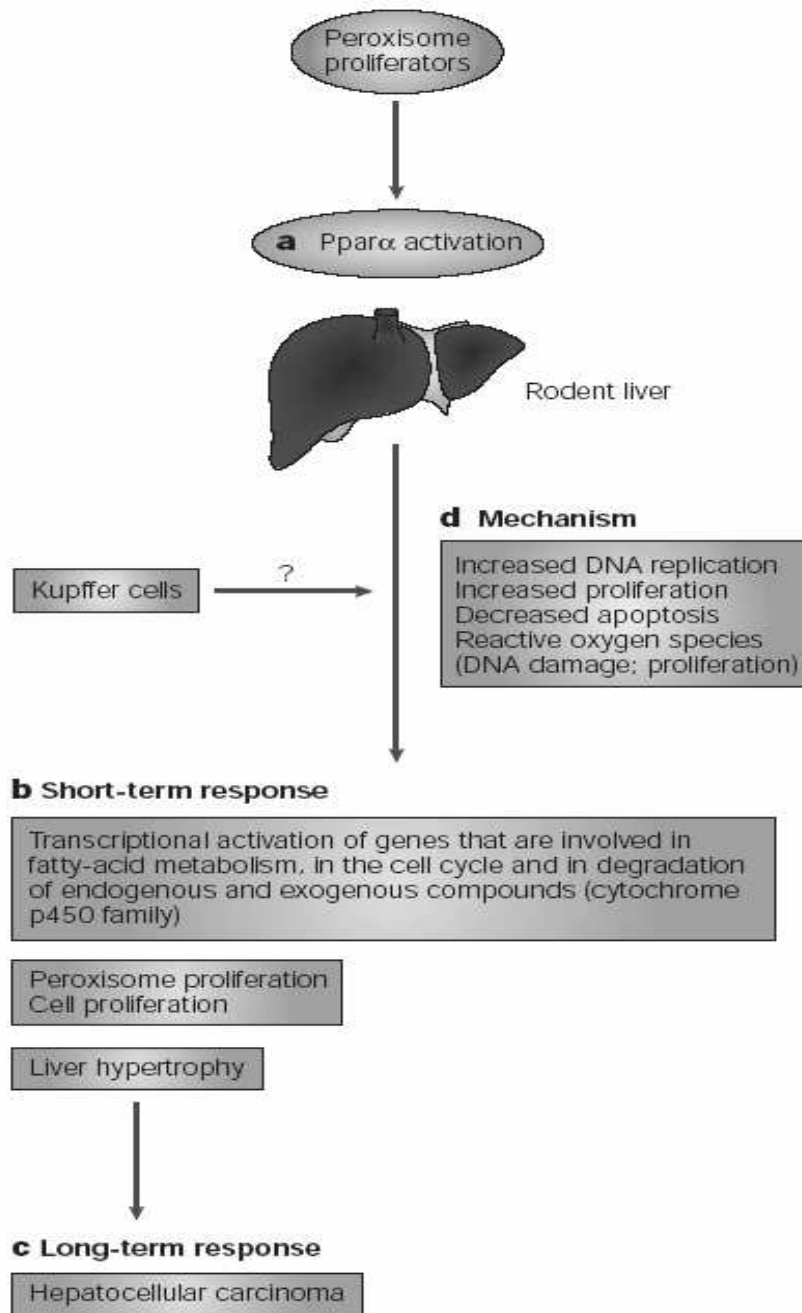

Figure 2 | Consequences of Ppar α activation by PP in the liver and proposed underlying mechanisms. Long-term chronic activation of peroxisome-proliferator-activated receptor- α (Ppar α) in the hepatocytes by its ligands (initial event; **a**) induces a short-term pleiotropic response (**b**) followed by hepatocellular carcinomas in both rats and mice (**c**). The short-term response includes transcriptional activation of enzymes that are involved in fatty-acid metabolism (fatty-acid β -oxidation, fatty-acid transporters and cytoplasmic liver fatty-acid-binding protein (L-FABP)), of genes that are involved in cell-cycle control and of genes coding for enzymes of the cytochrome p450 family (second-line events)¹⁴; peroxisome and cell proliferation (third-line events); and liver hypertrophy and hyperplasia (fourth-line events). The long-term consequence of these events is the development of hepatocellular carcinomas in rodents. **d** | Several underlying mechanisms are being debated^{15,16}. Peroxisome proliferators (PPs) induce DNA replication and proliferation of hepatocytes in a Ppar α -dependent manner^{19,22}. Furthermore, PPs repress spontaneous and induced hepatocyte apoptosis, *in vitro* and *in vivo*. As well as controlling of the cell cycle, the production of reactive oxygen species in response to Ppar α agonists might damage DNA and promote hepatocyte proliferation, but the implication of Ppar α in this effect remains to be proven. Additionally, non-hepatocyte cells, such as Kupffer cells, might participate in the short-term cascade of events by promoting hepatocyte proliferation³¹.

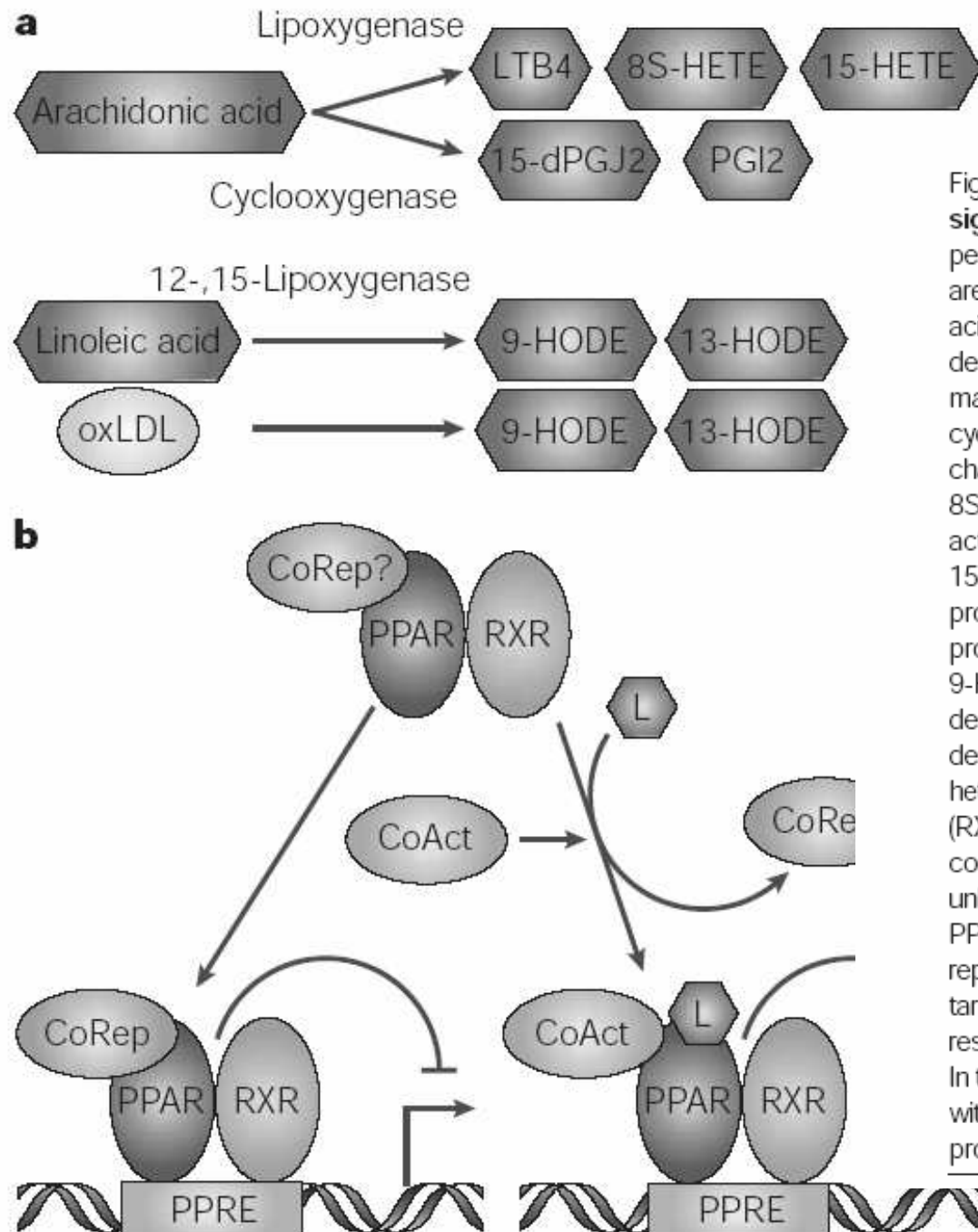

Figure 1 | Schematic representation of the PPAR signalling pathways. a | Endogenous agonists of peroxisome-proliferator-activated receptors (PPARs). PPARs are ligand-inducible receptors, which can be activated by fatty acids — such as arachidonic or linoleic acids — and their derivatives. The fatty-acid metabolites that activate PPARs are mainly derived from arachidonic or linoleic acids through the cyclooxygenase or the lipoxygenase pathways. The best characterized at the moment are leukotriene B4 (LTB4) and 8S-HETE (hydroxyeicosatetraenoic acid), which preferentially activate PPAR α ; 15-deoxy-prostaglandin J2 (15-dPGJ2) and 15-HETE, which are PPAR γ -selective ligands; and the prostaglandin I2 (PGI2, also called prostacyclin), which is probably a PPAR β/δ natural ligand. PPAR γ is also activated by 9-HODE (hydroxyoctadecadienoic acid) and 13-HODE, either derived from linoleic acid or as components of oxidized low-density lipoprotein (oxLDL). **b** | PPARs function as heterodimers with their obligate partner, retinoid receptor (RXR). The dimer probably interacts with co-regulators, either co-activators (CoAct) or co-repressors (CoRep). In the unliganded form, PPAR β/δ -RXR heterodimer, in contrast to PPAR α -RXR and PPAR γ -RXR heterodimers, recruits co-repressors and represses the activity of PPAR α and PPAR γ target genes by binding to the peroxisome proliferator response element (PPRE) that is present in their promoters^{6,7}. In their liganded form, the PPAR-RXR heterodimers interact with co-activators, bind to the PPRE that is present in the promoters of their target genes and activate their transcription.

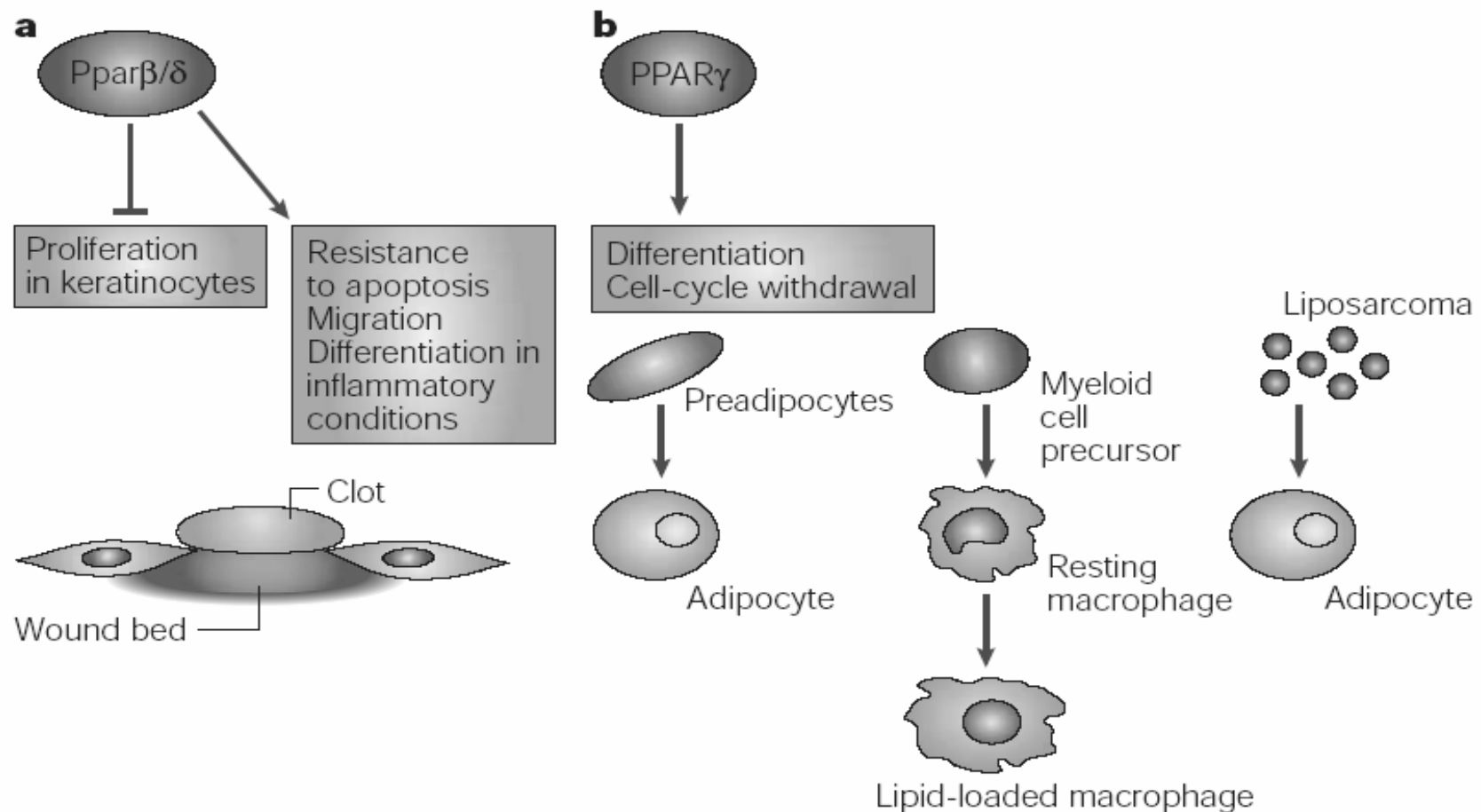

Figure 3 | **PPARβ/δ and PPARγ functions that relate to their carcinogenic properties.**

a | As demonstrated in a mouse-skin wound-healing model, Pparβ/δ inhibits keratinocyte proliferation and participates in inflammation-induced keratinocyte differentiation, which are anti-carcinogenic actions. However, it also increases both migration and keratinocyte resistance to Tnf-α-induced apoptosis. **b** | PPARγ is implicated in the differentiation of pre-adipocytes to adipocytes and of monocytes to macrophages. In the presence of PPARγ and retinoid receptor (RXR) ligands, myeloid-cell precursors become resting macrophages, which can be turned to lipid-loaded macrophages, when PPARγ and RXR ligands are maintained. PPARγ can also withdraw liposarcoma-derived cells from cell division to trigger their differentiation to adipocytes.