

Moderní metody analýzy organických polutantů

Jana Klánová

klanova@recetox.muni.cz

- **Moderní metody analýzy polutantů**

- **část II – organické polutanty**

- **Sylabus 2004**

- Moderní metody neřeší jen momentální koncentraci polutantů, ale i jejich původ a další osud, perzistenci, vlastnosti, efekty, transformace, degradace...

- **1. Úvod**

- Specifické problémy moderní environmentální analýzy (mezinárodní konvence: požadavky na analýzy nových typů polutantů, snižující se koncentrace, analýzy reziduí, velké množství kontrolních vzorků, automatizace, požadavky na komplexní analýzu rizik: propojení analytických informací s toxikologickými, vzorkování a analýza biodostupných frakcí, biotesty, průnik metod analytických, biochemických a molekulárně biologických, požadavky na studium osudu látek, biotické a abiotické transformace, spektrální a laserové metody. Koncentrace a vlastnosti kontaminantů, efekty matrice, stabilita vzorků, nehomogenita. Nároky na analýzu vzorků, čistota chemikálií, riziko sekundární kontaminace, zatížení chybami, náklady.

- Obecné schéma analytického postupu.

- **2. Vzorkování**

- Přehled standartních technik odběru vzorků ovzduší a vod, odběr vzorků plynné fáze na sorbenty, studium fázové distribuce, vzorkovací média, aktivní a pasivní vzorkovače, výhody a nevýhody, rozsah použití – vzorkování pro účely studia osudu látek, dálkového transportu, vlivu starých zátěží, filtrujících efektů, transformací. Membránové techniky. Miniaturní vzorkovače vod. Průtokové analýzy. Vzorkování za účelem studia distribuce, biodostupnosti, bioakumulace

- **3. Techniky přípravy environmentálních vzorků**
- Extrakce (automatizovaná extrakce – Soxtec, mikrovlnná a ultrazvuková extrakce, superkritická fluidní extrakce, extrakce na tuhou fázi, mikroextrakce, analýza rovnovážné plynné fáze), čištění, frakcionace. Extrakce biodostupné frakce SFE (CO₂, vodou za vysokého tlaku)

- **4. Techniky analytického stanovení**
- Chromatografické techniky, jejich princip, instrumentace, využití, interpretace dat.
- HPLC, GC, výběr kolon, fází, detektorů, GC-GC, LC-GC, kombinované metody (GC/MS, MS-MS, LC/MS, LC/NMR)

- **5. Techniky fotochemické**

- **6. Techniky molekulárně biologické**
- ELISA, sekvenace a fragmentace

- 7. Analytická data, jejich analýza a interpretace

Návaznost na další přednášky

Analytická chemie životního prostředí

Chromatografické metody I a II (GC, HPLC, GPC, TLC, elektroforéza)

Hmotnostní spektroskopie

Elektronová spektroskopie

Správná laboratorní praxe

Chemie životního prostředí II a IV

Doporučená literatura:

Reeve R.: Introduction to environmental analysis

Fifield F.W., Haines P.J.: Environmental analytical chemistry

Skoog D.A., Leary J.J.: Principles of instrumental analysis

Hewitt C.N.: Instrumental analysis of pollutants

Keith L.H.: Environmental sampling and analysis

Environmentální vědy zahrnují komplexní studium prostředí a celou řadu disciplín.

Pro většinu z nich je však v jistém stádiu nevyhnutná chemická analýza. Může se jednat o studium

- úrovně znečištění různých složek prostředí
- kvality vody a potravy
- regionální kontaminace
- účinnosti remediací
- dopadu mezinárodních direktiv na úroveň kontaminace
- transportu látek v různých prostředích
- biotických a abiotických transformací
- bioakumulace
- úbytku ozónu v závislosti na přítomnosti některých látek
- vlivu chemických látek na živé organismy
- toxických účinků chemických látek v závislosti na jejich struktuře

Moderní environmentální analýza však přináší specifické problémy:

- mezinárodní konvence: požadavky na analýzy nových typů polutantů
- snižující se koncentrace: požadavky na detekční limity
- staré zátěže: analýzy reziduí
- mezinárodní studie: potřeba standardizace
- velké množství kontrolních vzorků: automatizace
- studium transportu látek: potřeba velkoplošného monitoringu, požadavek na vývoj nových metod vzorkování
- studium osudu látek: potřeba znalosti rovnováhy, distribuce
- chemické a fotochemické reakce: spektrální a laserové metody
- komplexní analýza rizik: propojení analytických a toxikologických metod, biochemických a molekulárně biologických

• Persistence increases the relative importance of transport relative to transformation in controlling a contaminant's fate

atmospheric transport (gas phase, particles, cloud water)



transport by migratory animals

riverine transport
(dissolved phase, particles)

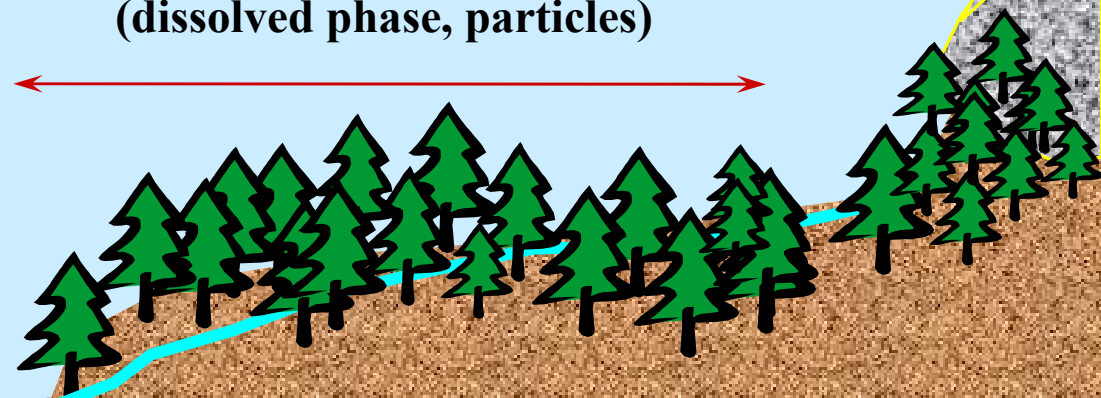

anthropogenic transport (products, waste)



oceanic transport
(dissolved phase, particles)



Pro splnění tak rozličných zadání musí environmentální chemie nutně stavět na znalosti řady fyzikálně chemických vlastností, principů a metod:

- charakter vazeb a jejich energie
- strukturní informace
- rozpustnost, tenze par
- acidobazické rovnováhy
- oxidoredukční rovnováhy
- elektrochemické reakce
- fázové rovnováhy
- distribuční koeficienty
- difúzní charakteristiky
- strukturní informace
- spektrální vlastnosti

Specifické problémy environmentální analýzy

- široký rozsah koncentrací i vlastností analytů
- monitorování na hladinách blízkých mezi detekce
(stopové a ultrastopové koncentrace analytů, riziko chyb)
- riziko sekundární kontaminace
- nehomogenita vzorků
- nutnost aplikace složitých metod pro izolaci analytů z matrice
- omezená stabilita analytů a matic
- cena instrumentace, čistých chemikálií, standardů

Pro kontrolu chemického znečištění životního prostředí je nezbytná kontinuální analýza

- definice problému, co a proč chceme sledovat
- monitorování s cílem určit rozsah problému
- nalezení optimálního postupu
- vyhodnocení stavu a prognóza vývoje
- odhad expozice a posouzení rizik
- návrh opatření
- vytvoření legislativy pro účinnou kontrolu
- monitorování pro zjištění účinnosti opatření

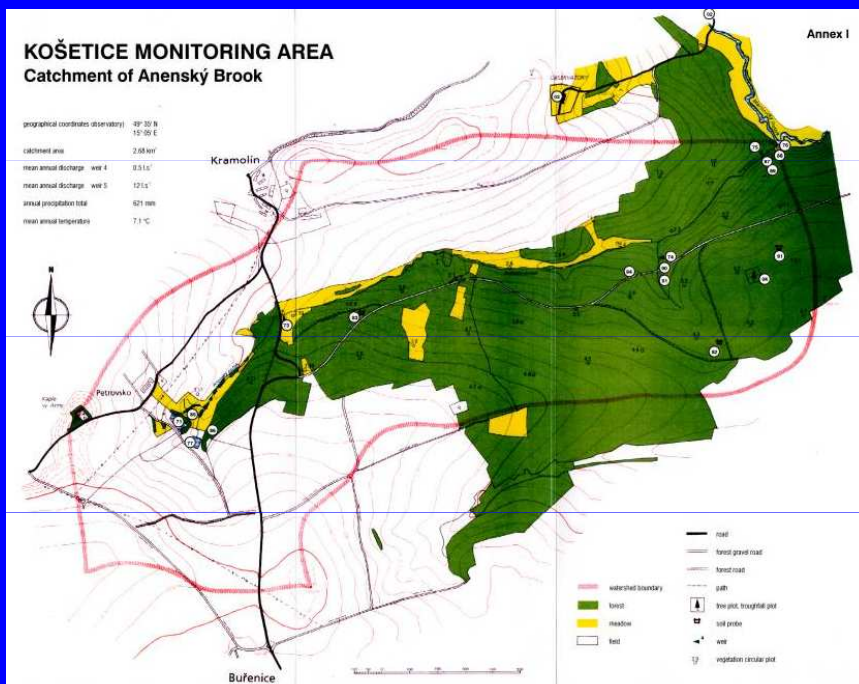
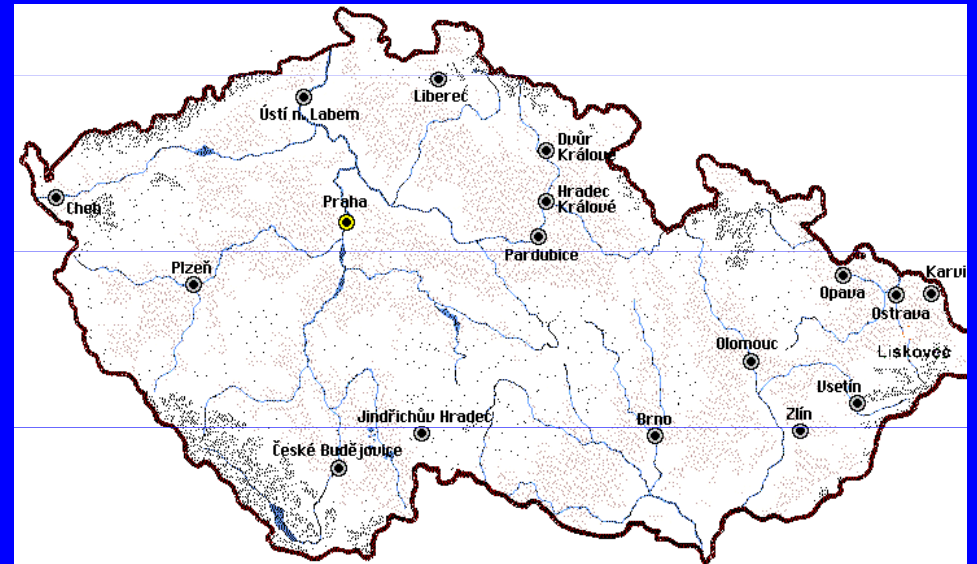
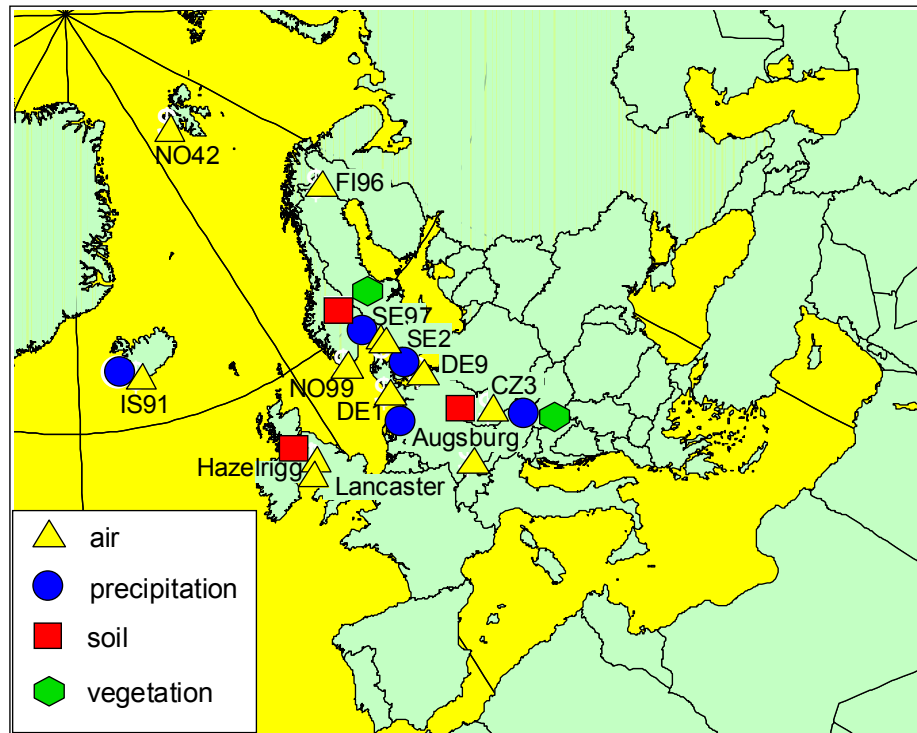

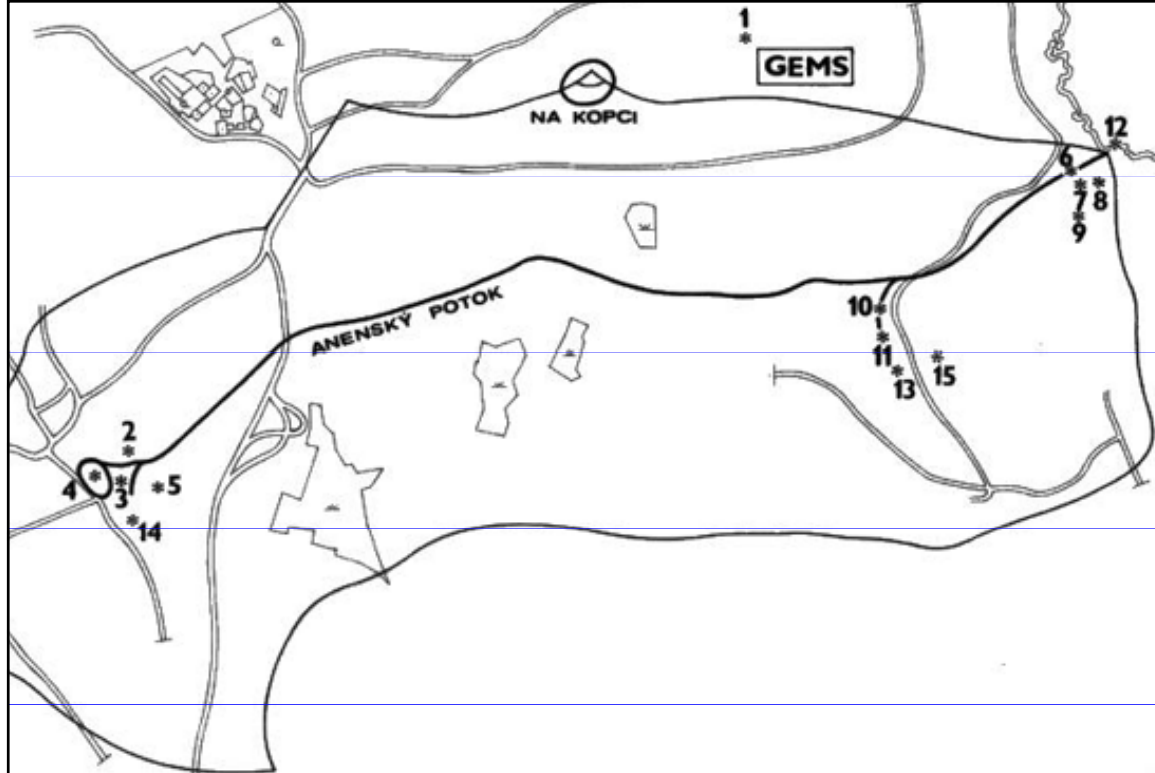

**Integrated monitoring
of POPs - sampling
sites and sampling
frequency -
Observatory Košetice -
from 1988**

Ambient air	01	Weekly
Wet deposition	01	Evently
Surface waters	04, 02, 10, 12a, 12b, 14	Yearly
Sediments	04, 02, 10, 12a, 12b, 14	Yearly
Soils	01, 03, 05, 07, 08, 09, 11, 13, 15	Yearly
Litter	09	Yearly
Spruce and pine needles	05, 07, 08, 09, 13, 15, 16	Yearly
Mosses	05, 07, 08, 09, 13, 15, 16	Yearly

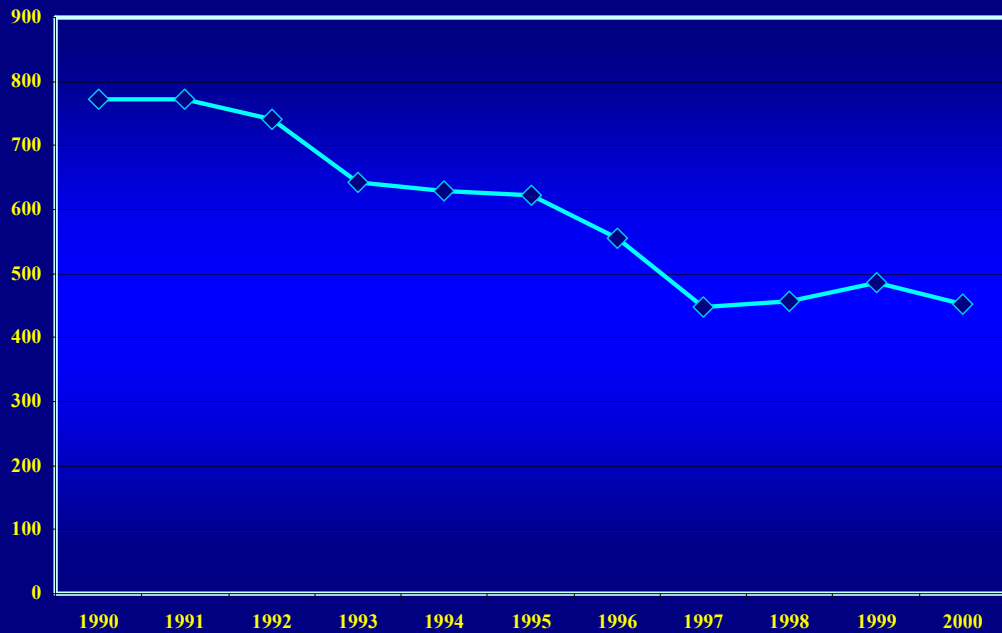

PCBs in ambient air - Observatory Košetice 1996-1999 (7 indicator congeners)

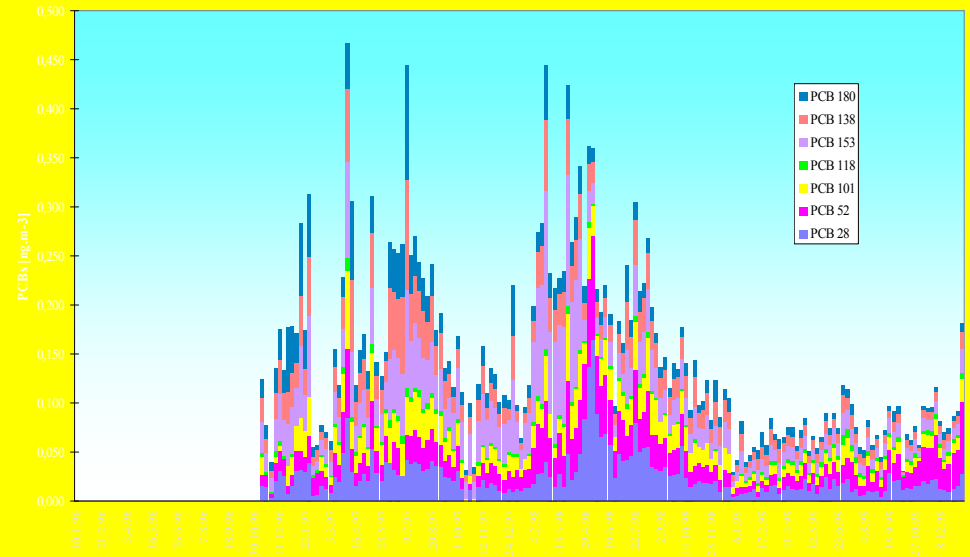

Sum of PCBs Observatory Košetice 3.09

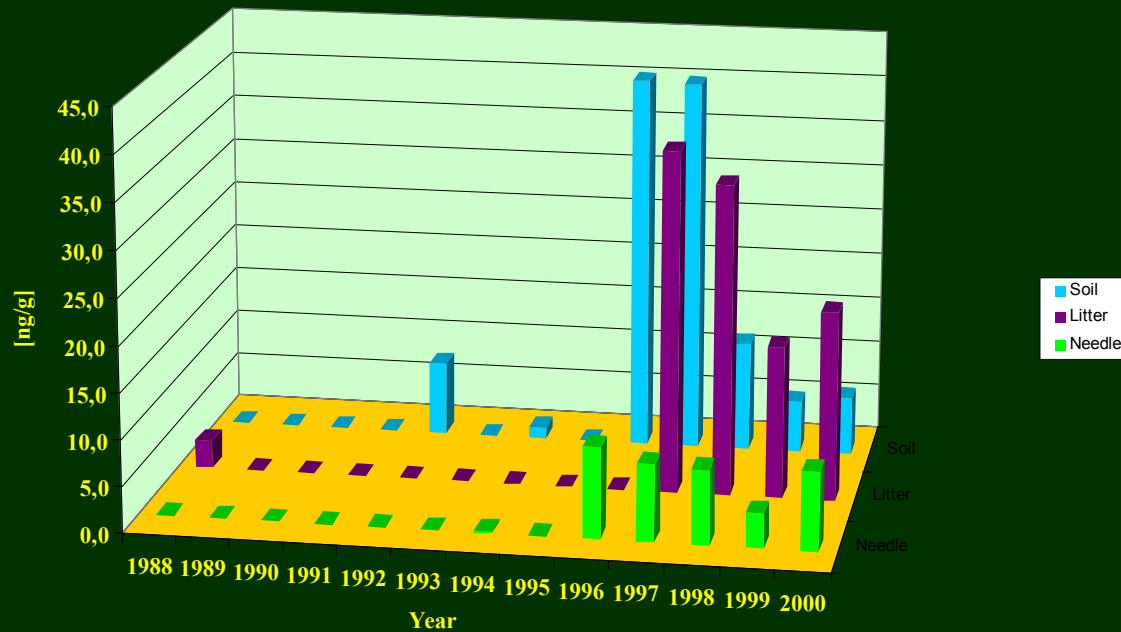

Trends of environmental levels of POPs in the CR – regional background monitoring – observatory Košetice – case of PCBs

PCBs levels in ambient air in Europe [ng.m⁻³]

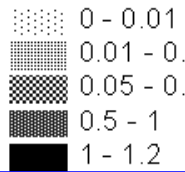
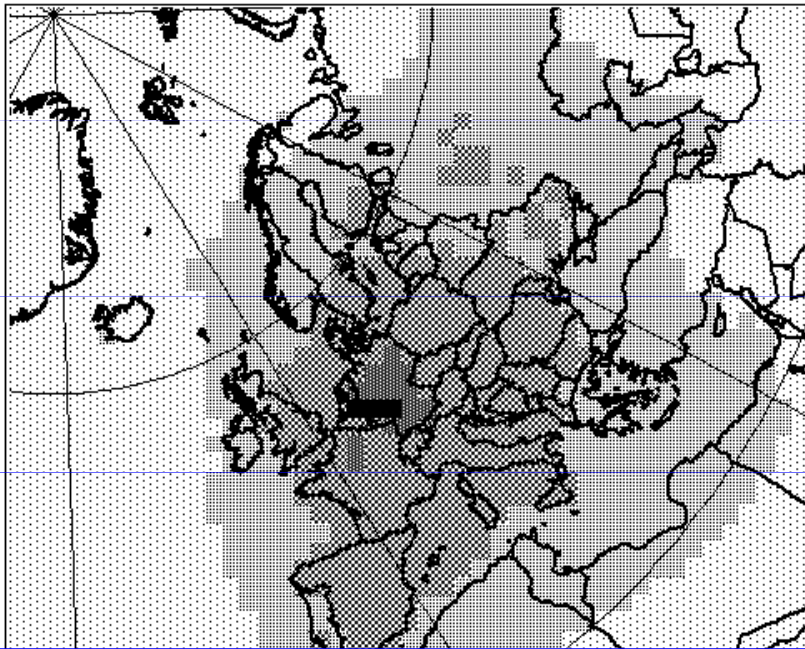

NOAA Air Resources Laboratory

This product was produced by an Internet user on the NOAA Air Resources Laboratory's web site. See the disclaimer for further information (<http://www.arl.noaa.gov/ready/disclaim.html>).

Sum of PCBs in ambient air - Košetice 2000 (7 indicator congeners)

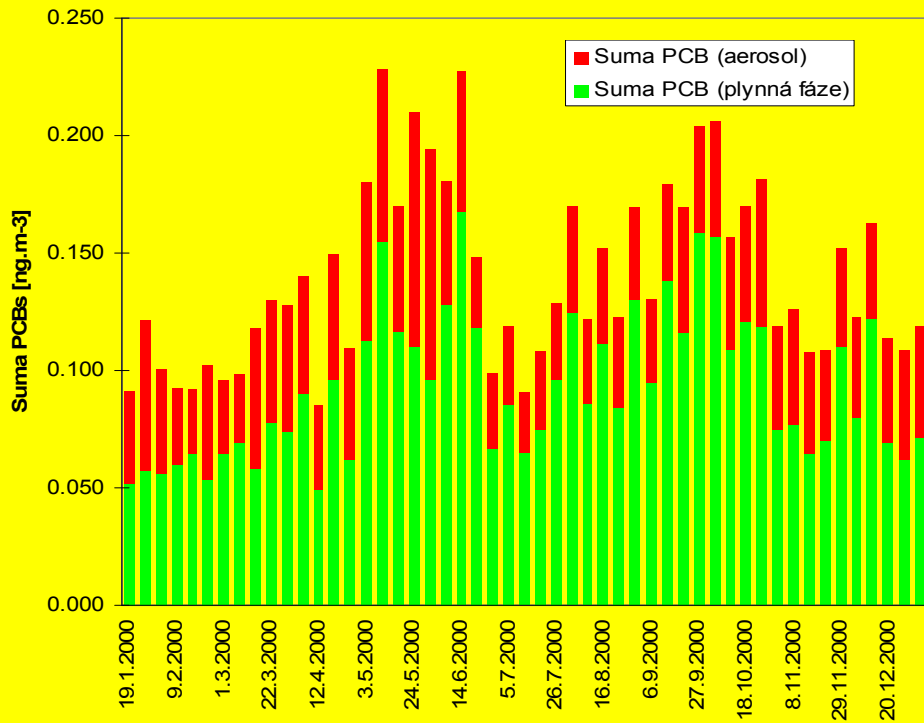

NOAA AIR RESOURCES LABORATORY
Backward Trajectory Ending- 20 UTC 14 JUN 00

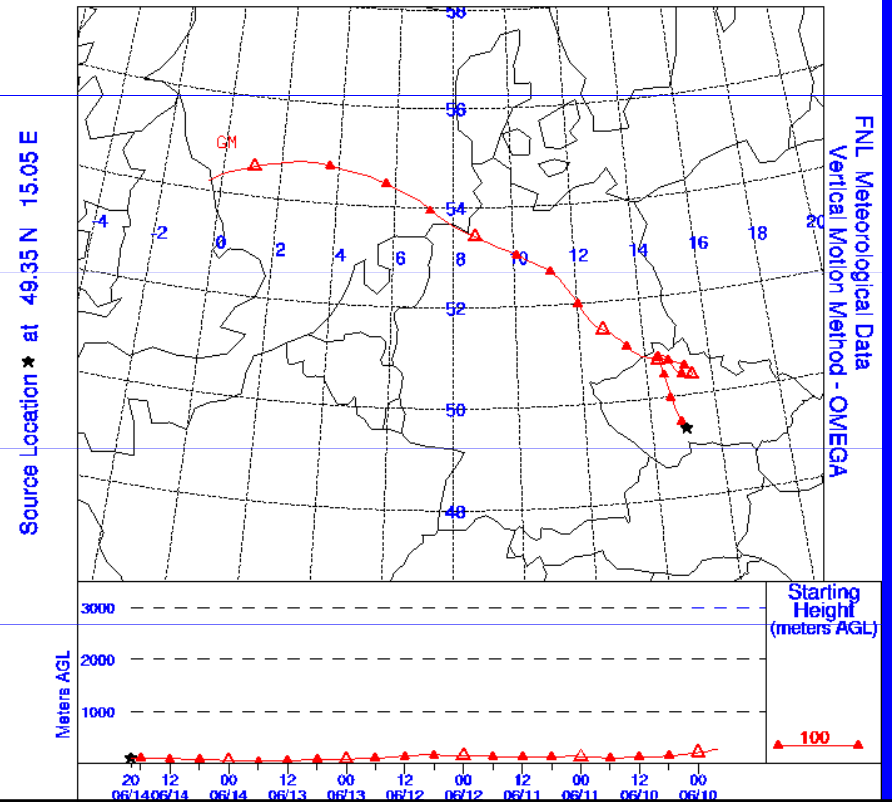

Annual average atmospheric concentrations of PAHs (sum of 12) from four European sites 1996-2001

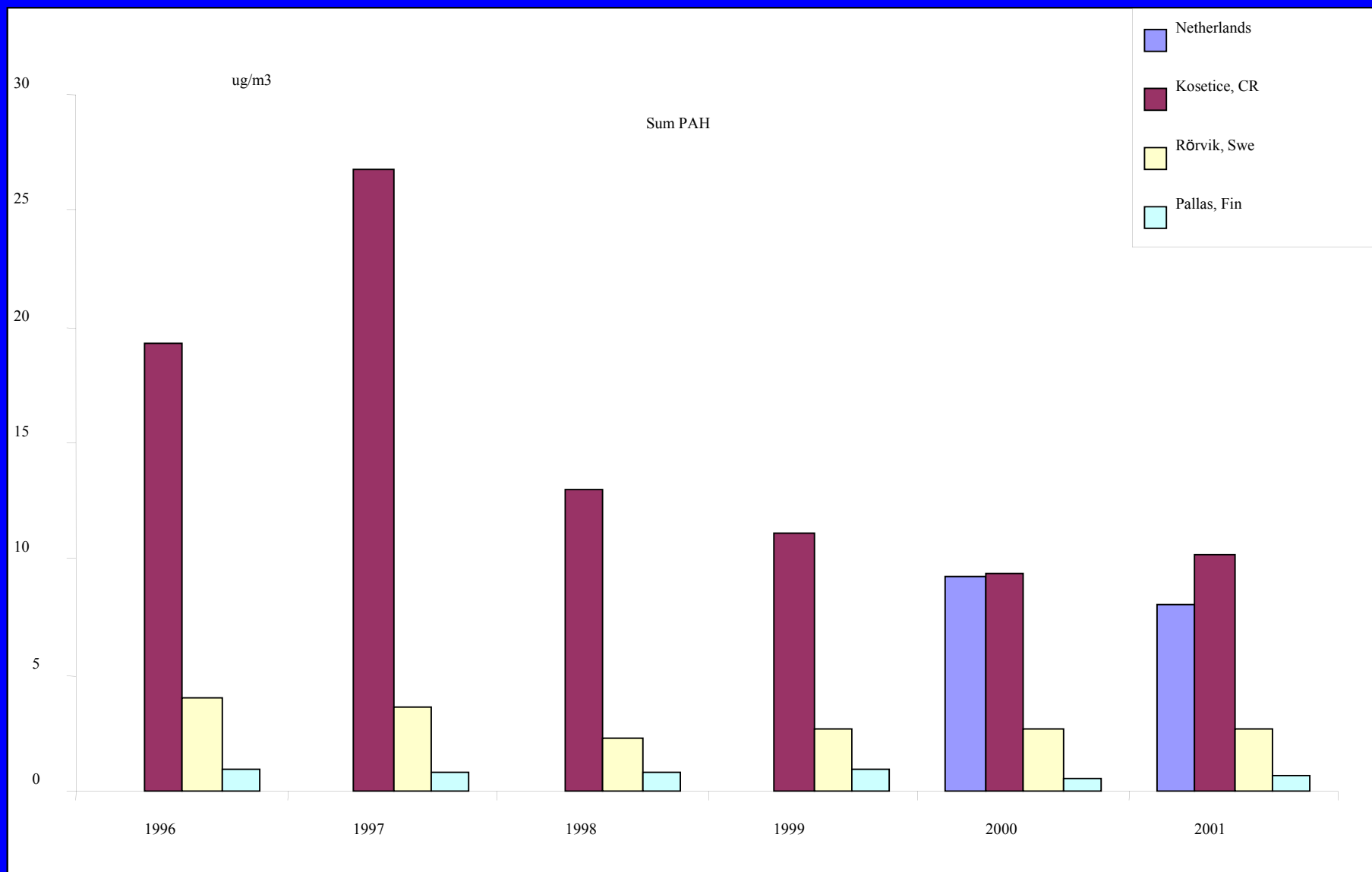

Annual average atmospheric concentrations of PCB (sum of seven) from four European sites 1996-2001

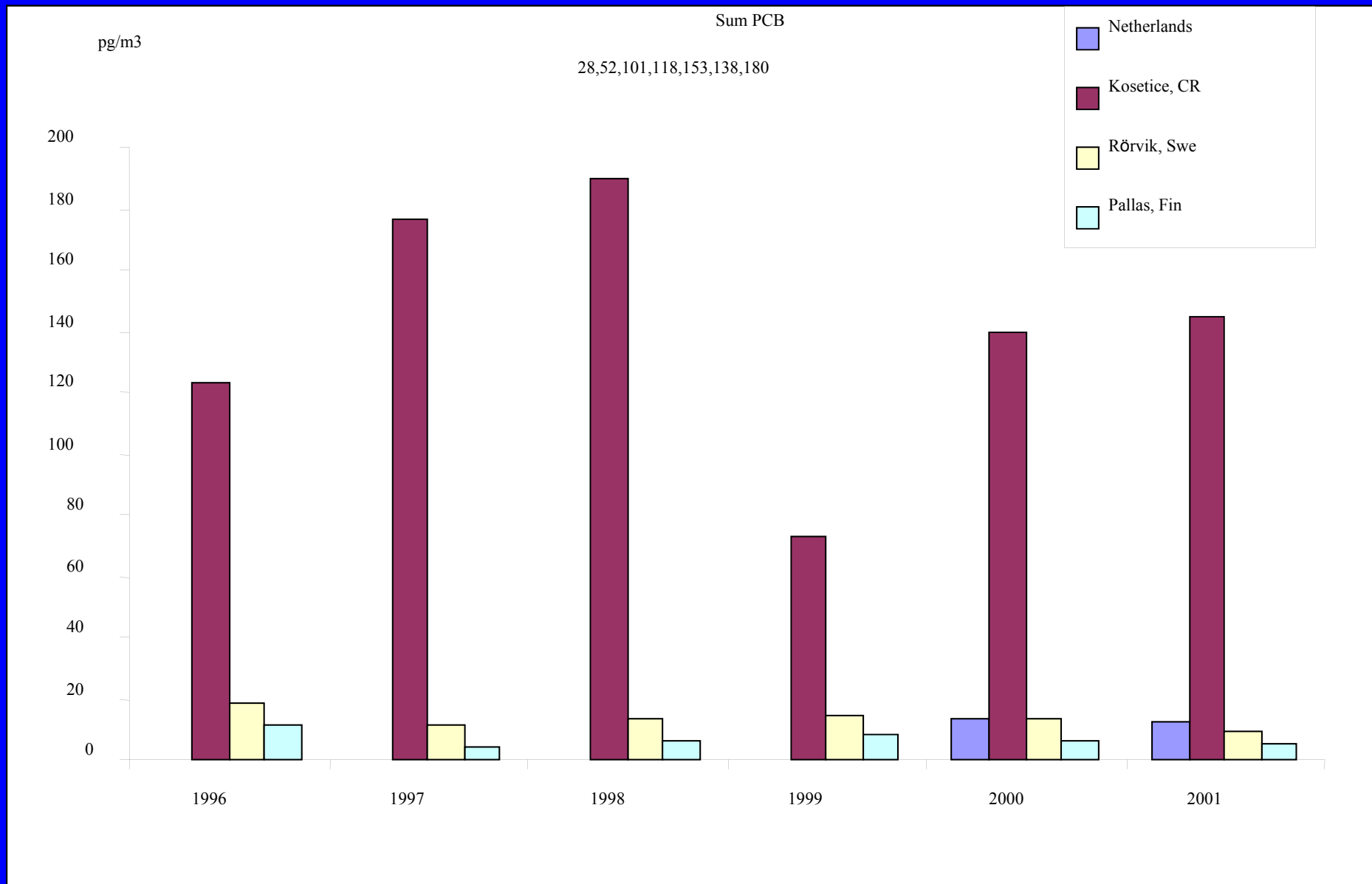

Regional background observatory Košetice, 1996 – 2002,
every weeks, 52 samples per year, annual medians of PAHs
[ng.m⁻³]

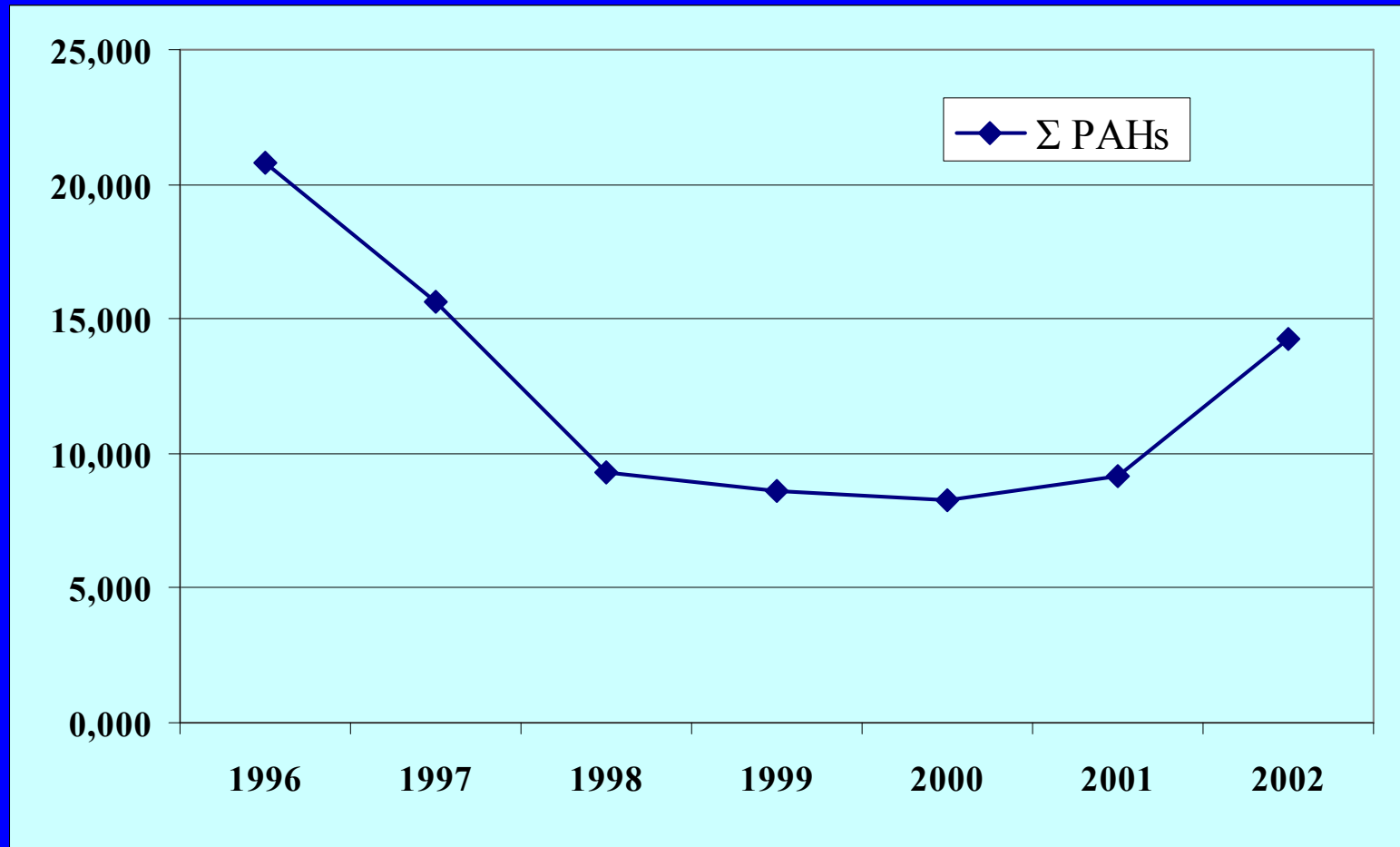

Levels of PCBs, HCHs, DDTs, ambient air (g+s) (CZ, Košetice, 1996-2002, annual medians) - time trends

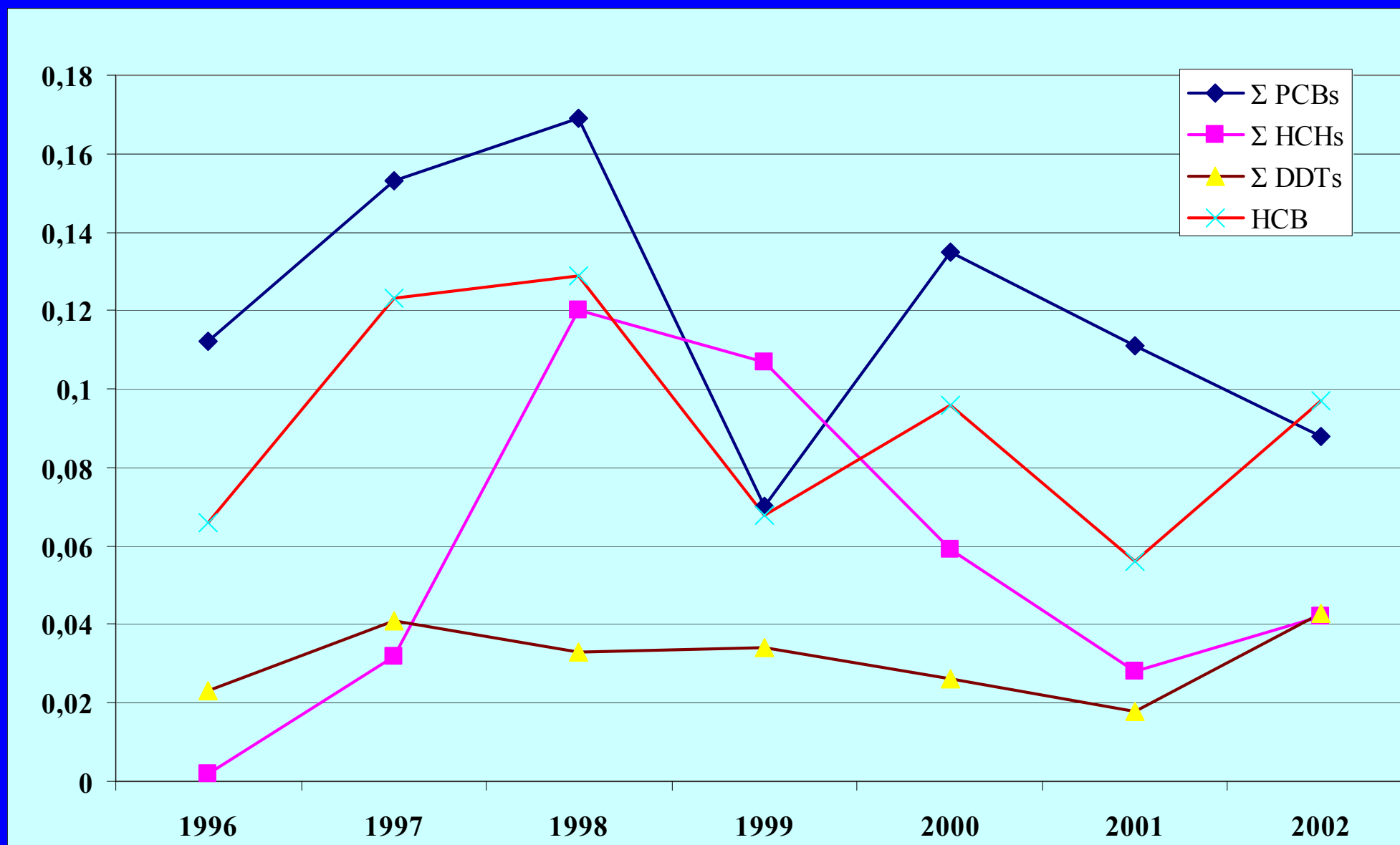

Obecné schéma analytického postupu

- odběr vzorku - konzervace
 - transport
 - skladování
- příprava vzorku - extrakce
 - přečištění, odstranění interferentů
 - frakcionace
 - zakoncentrování
 - derivatizace
- analytické stanovení
- interpretace dat

Odběry ovzduší

- volné ovzduší
- permanentní plyny
- těkavé látky
- pevné částice
- ovzduší v místnostech
- pracovní ovzduší
- emise
- imise

Techniky odběru ovzduší

- odběr plynné fáze do vzorkovnice s pevným objemem - těkavé (kanystr, vak, plynotěsná stříkačka, vyprázdní se do promývačky)
- absorpce plynu v roztoku (promývačka, filtr impregnovaný absorpční kapalinou, je třeba kalibrované zařízení na měření objemu)
- záchyt plynů na sorbentech (detekční trubičky s aktivním uhlím, silikagelem, polymery, denudery - nezachycují aerosol)
- vzorkování pevných částic (vysokoobjemové vzorkovače, odběrové filtry křemenné a polyuretanové, vzorkování respirabilní frakce $< 5\mu\text{m}$ -kaskádový a cyklónový impaktor, univerzální vzorkovač VAPS)
- pasivní vzorkovače (náplň PUF, amberlit, semipermeabilní membrána, extrakční disk EMPORE)

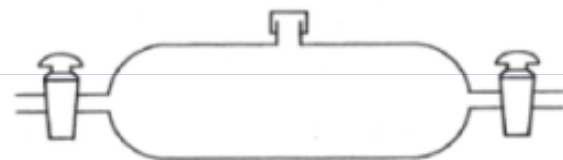

Sampling bulb with septum

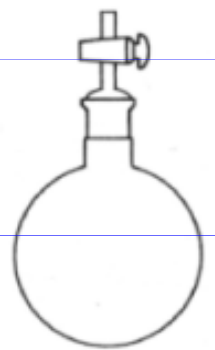

Evacuated sample container

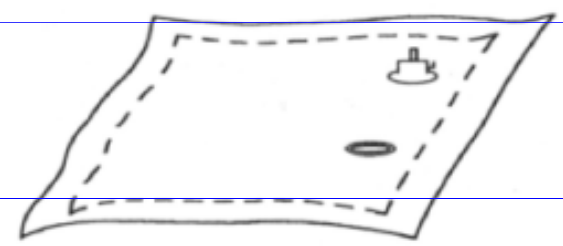

Sampling bag



Gas-tight syringe

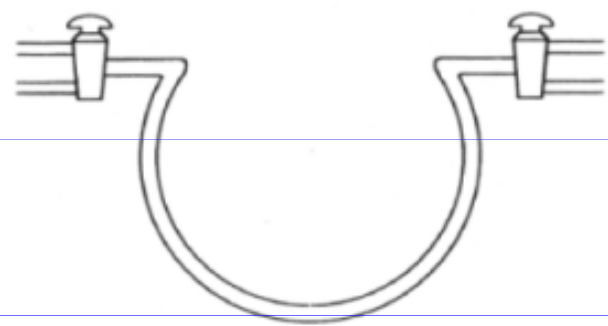

Gas sampling loop

Figure 6.16 Some examples of the equipment used for gas sampling.

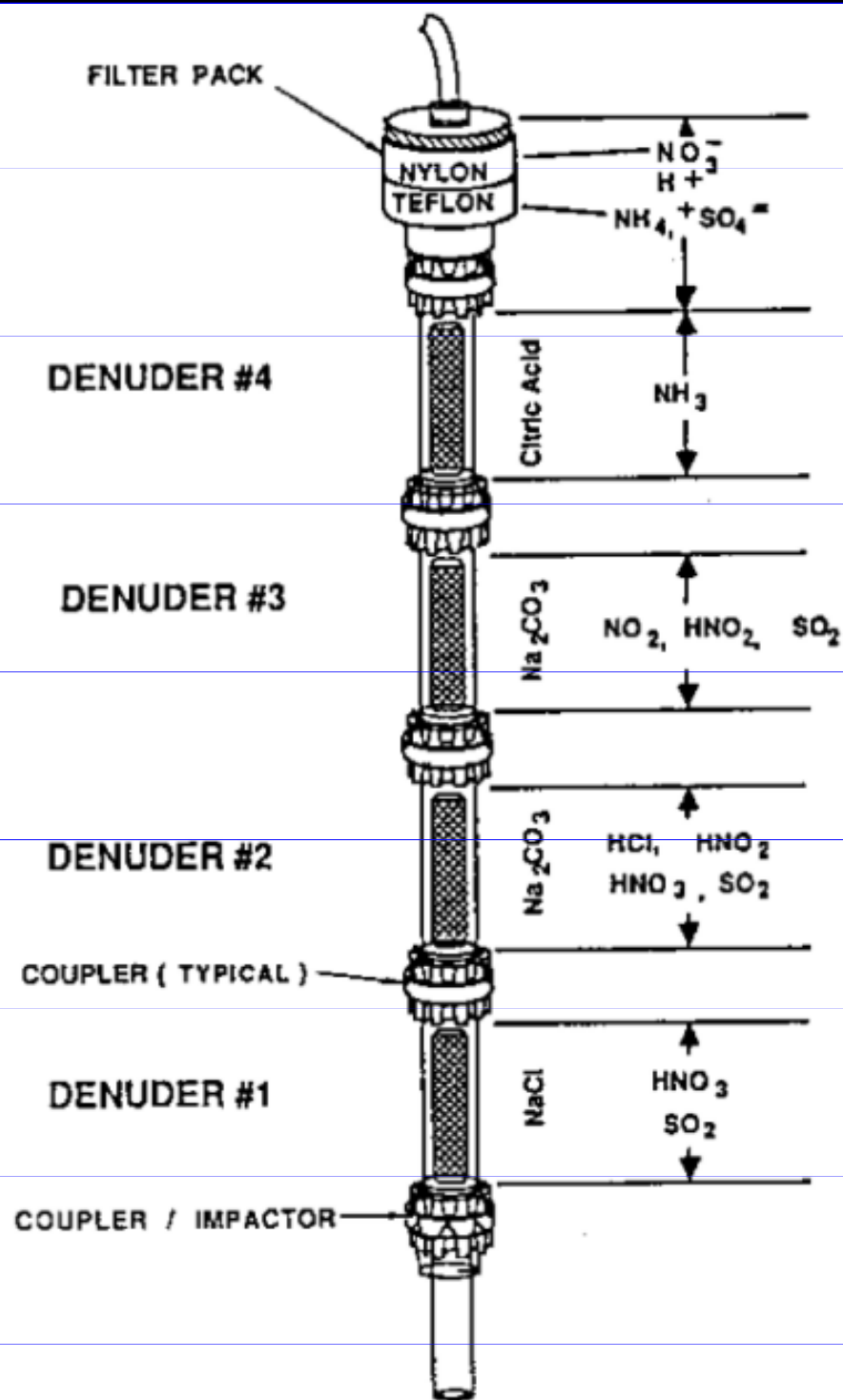

Figure 1. Schematic View of Annular Denuder Showing Species Collected

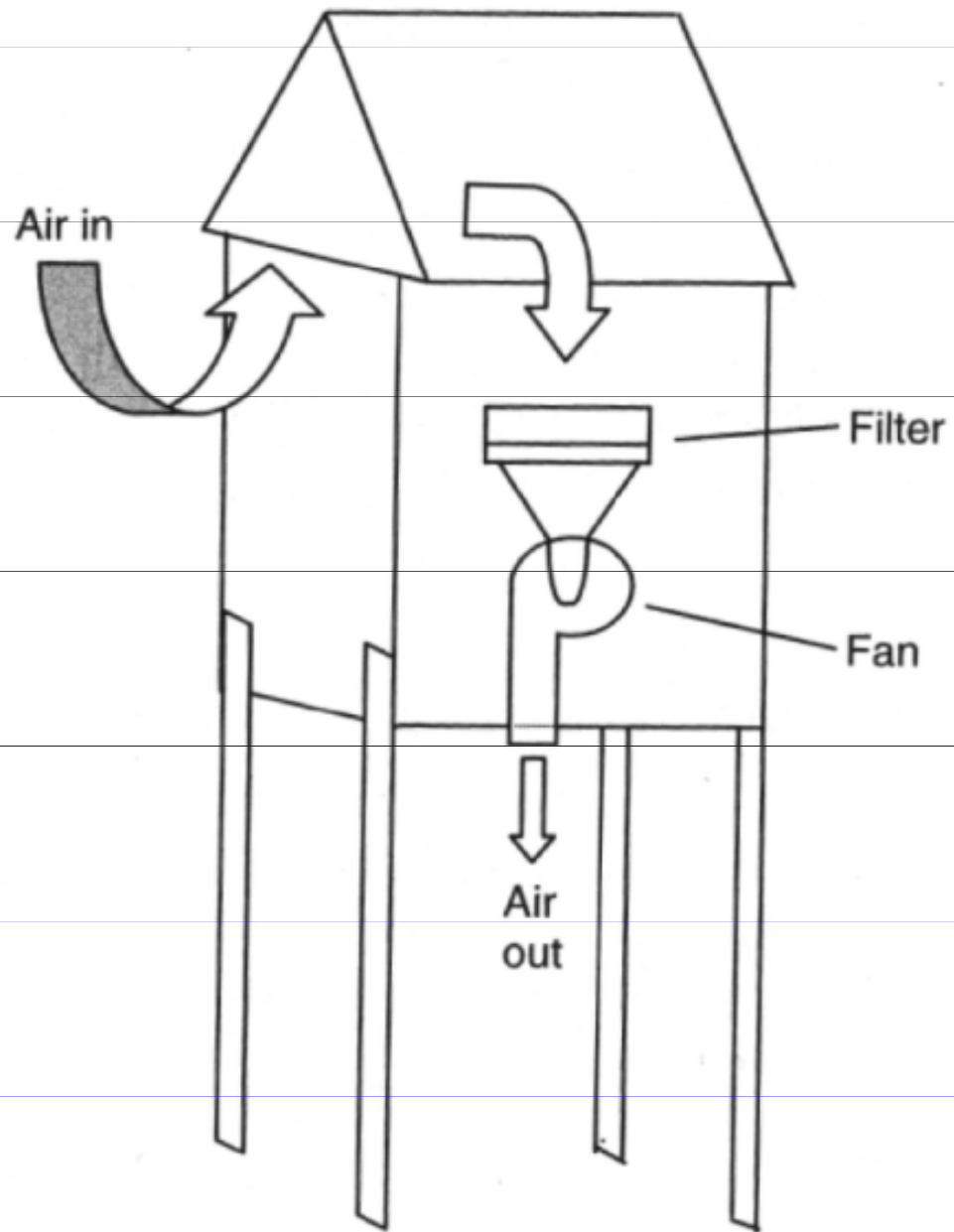

Figure 7.1 Schematic of a high-volume sampler with shelter.

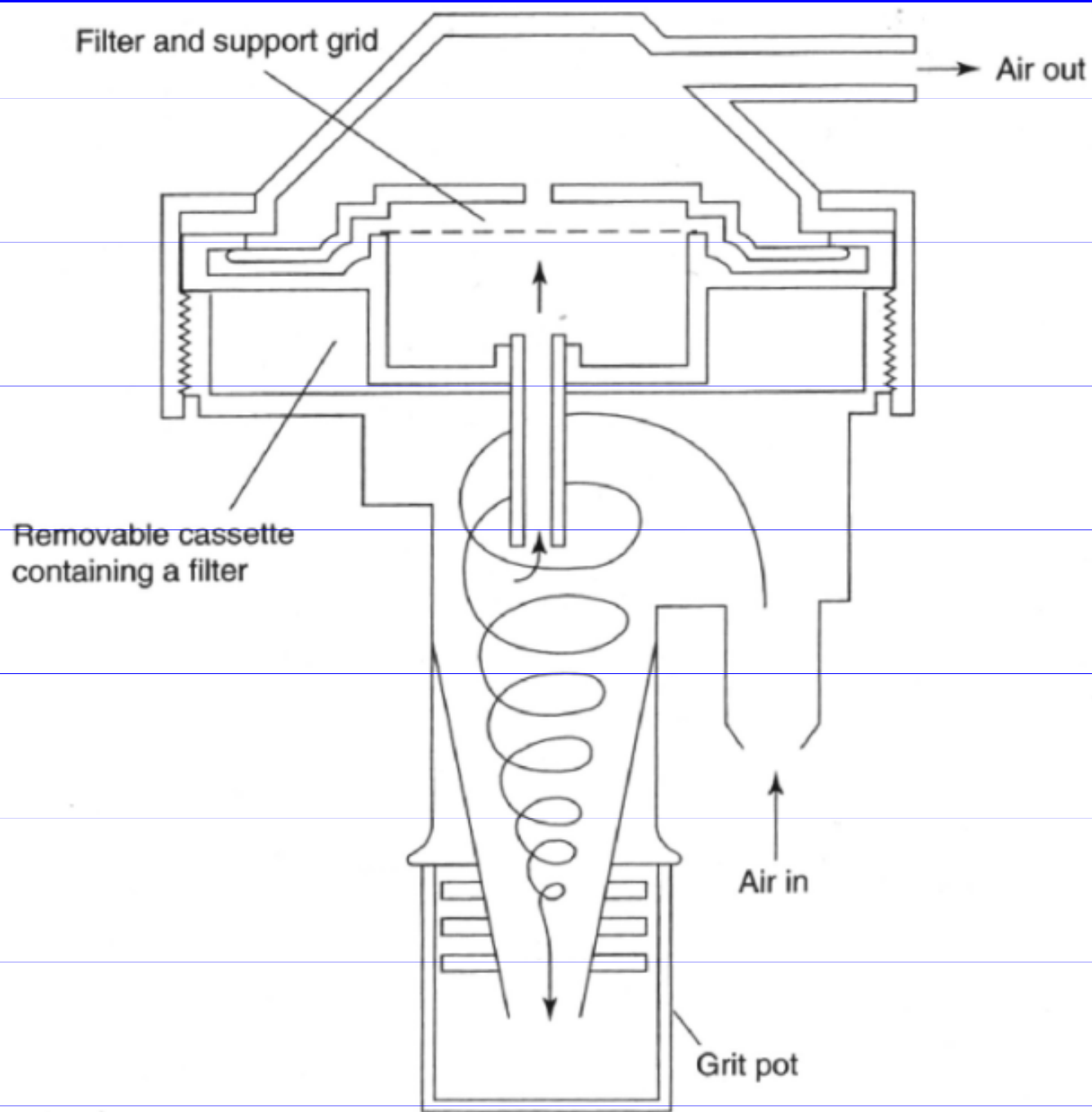

Figure 7.2 Schematic of a cyclone elutriator.

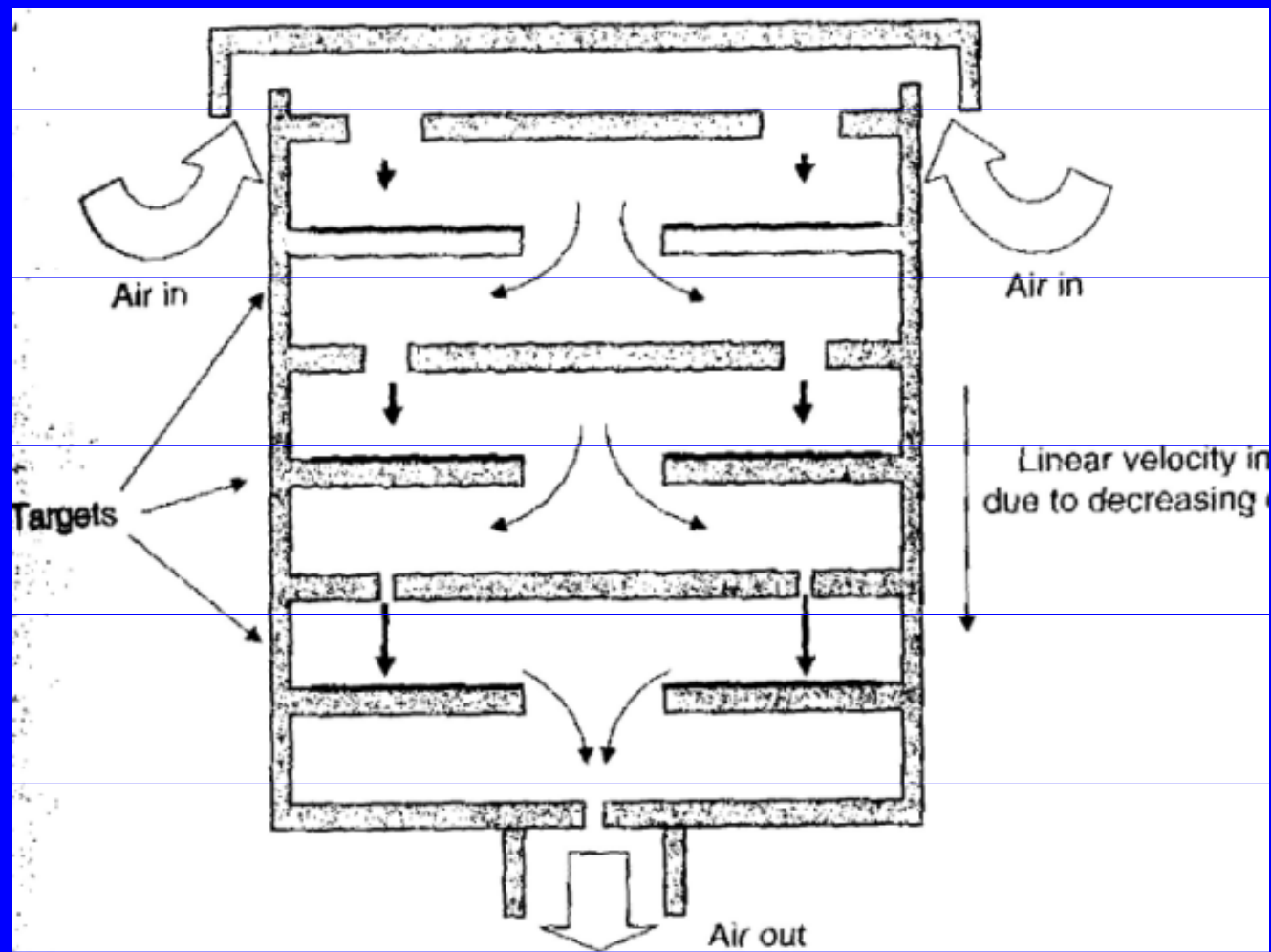

Figure 7.3 Schematic showing the operation of a cascade impactor.

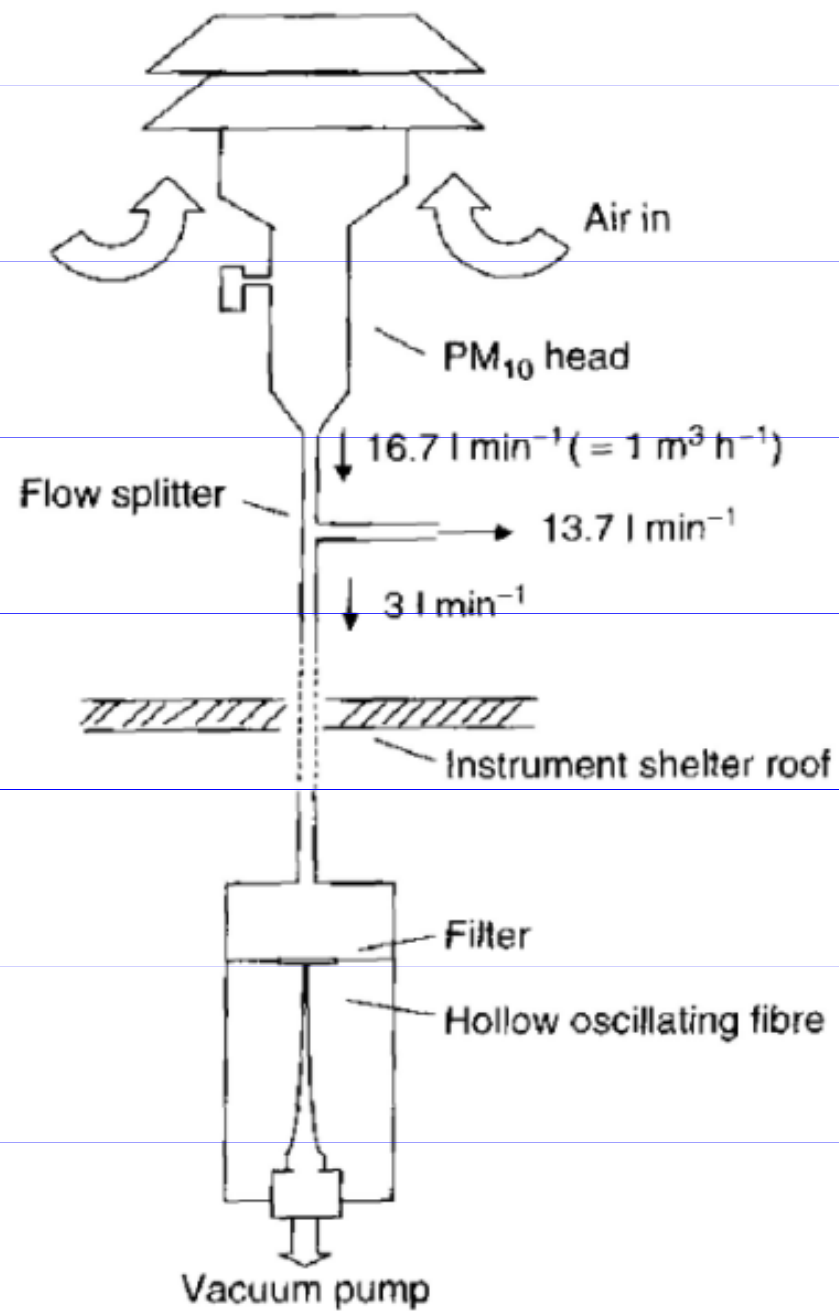
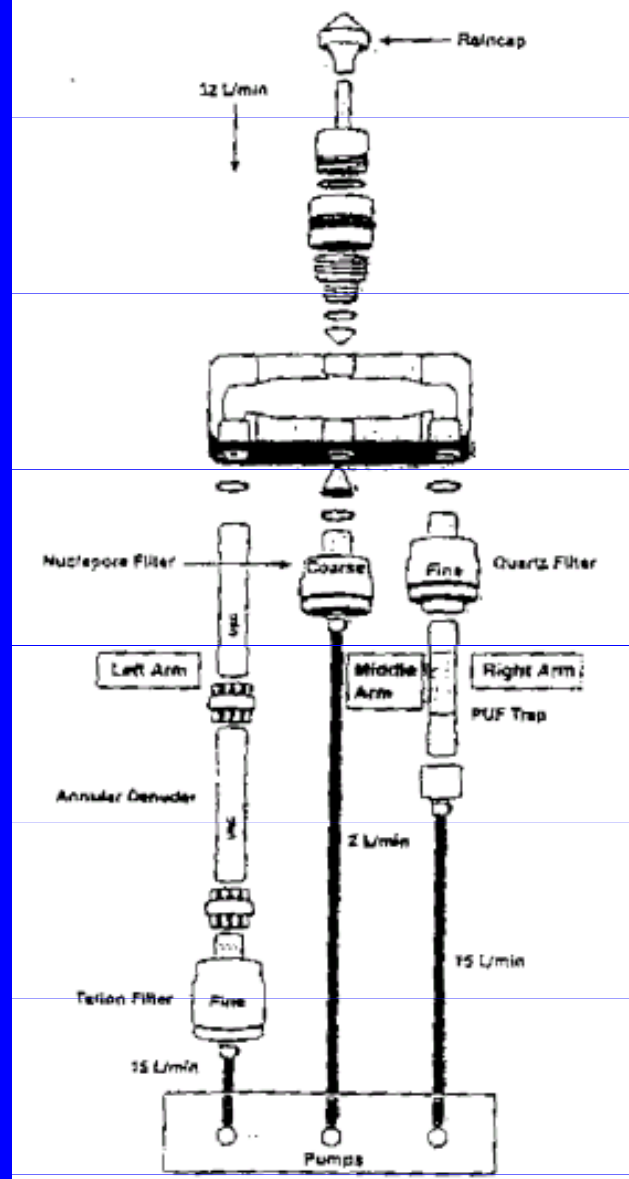
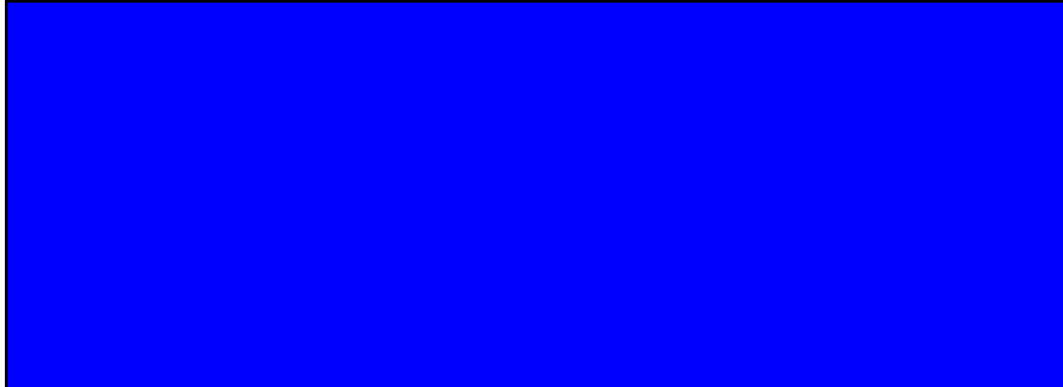

Figure 7.6 Schematic of a tapered element oscillating microbalance with PM₁₀ head.

Vzorkovač VAPS - funkční schéma





↘ **Active sampling – cost, training, power, supporting meteo data**

↳ Such techniques provide a cheap and powerful tool for obtaining detailed spatially resolved and time trend data relatively cheaply and efficiently.

↳ A number of exciting developments have been made in this field in recent years; the utility of passive samplers has been demonstrated for local, national and regional scale monitoring.



- ↪ **The general concepts behind passive air sampling have been discussed elsewhere (Ockenden *et al.*, 2001).**
- ↪ **A sorbent/solid phase sampler is used, to which gas phase POPs can partition (ad-/absorb).**
- ↪ **The mass of chemical on the sampler will increase with exposure time (kinetic uptake phase), and approach equilibrium.**
- ↪ **The time to equilibrium will vary, depending on the ‘capacity’ of the sampler.**
- ↪ **The rate of supply may be influenced by wind speed, deployment conditions and compound.**

The advantages/opportunities of passive air samplers are as follows:

↳ Low cost

↳ Excellent opportunities for high spatial and temporal sampling resolution data

↳ No power supply needed, easy deployment and little operator training required

Their disadvantages/constraints are:

↪ **Current techniques are still ‘semi-quantitative’, requiring knowledge of the sampling rate (m^3 air sampled/day) and the effects of temperature**

↪ **Optimisation of sampling requires further study, of the effects of wind speed, temperature**

↪ **Sampling is efficient for the gas phase component, but generally poorer for the particulate phase**

↪ **The time to reach gas phase-sampler equilibrium varies widely between POPs**

The development of passive air samplers for POPs is an active area of research.

Different designs are being tested/used.

There is no consensus yet as to what is the ‘best design’; indeed, it is probable that different samplers will be useful for different purposes (i.e. different time scales; different compounds).

**The most promising techniques deployed so far are:
Semi-permeable membrane devices (SPMDs)**

↳ **Research has been carried out to ‘calibrate’ them**

↳ **SPMDs have been used to show spatial and temporal trends (Meijer *et al.*, 2003)**

↳ **SPMDs have ‘long’ equilibration times (months/years)**

↳ **Interpretation of data is complicated by the presence of 2 phases (membrane and triolein) and the ‘weathering’ of the membrane which can occur over time**

↳ **SPMDs are expensive to use and analyse, and the clean-up and analysis is complicated (Petty *et al.*, 2000)**

Polymer-coated glass (POG) samplers

↳ This technique is very new, but shows considerable promise for short- and medium- time resolution deployments (weeks) (Harner *et al.*, in press)

XAD resin samplers

↳ This technique utilises a ‘high capacity’ resin to sample the gas phase, and has been deployed on a regional scale study in orth America (Wania *et al.*, in press).

↳ It shows considerable promise as a sampler.

↳ Potential problems may include ensuring low blanks and sample clean-up times

XAD-Resin Based Passive Air Sampling System for POPs

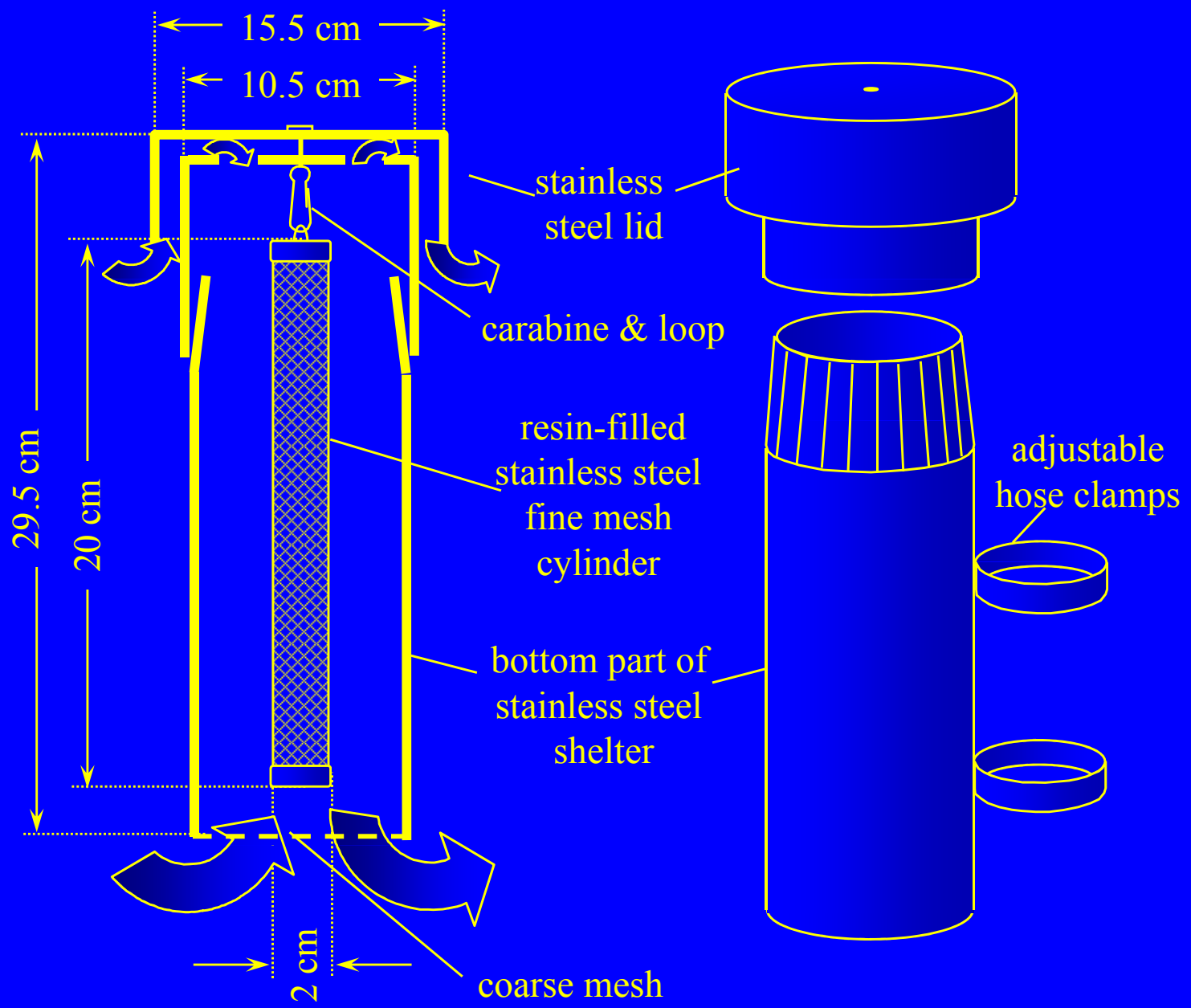

Hexachlorocyclohexanes Across North America

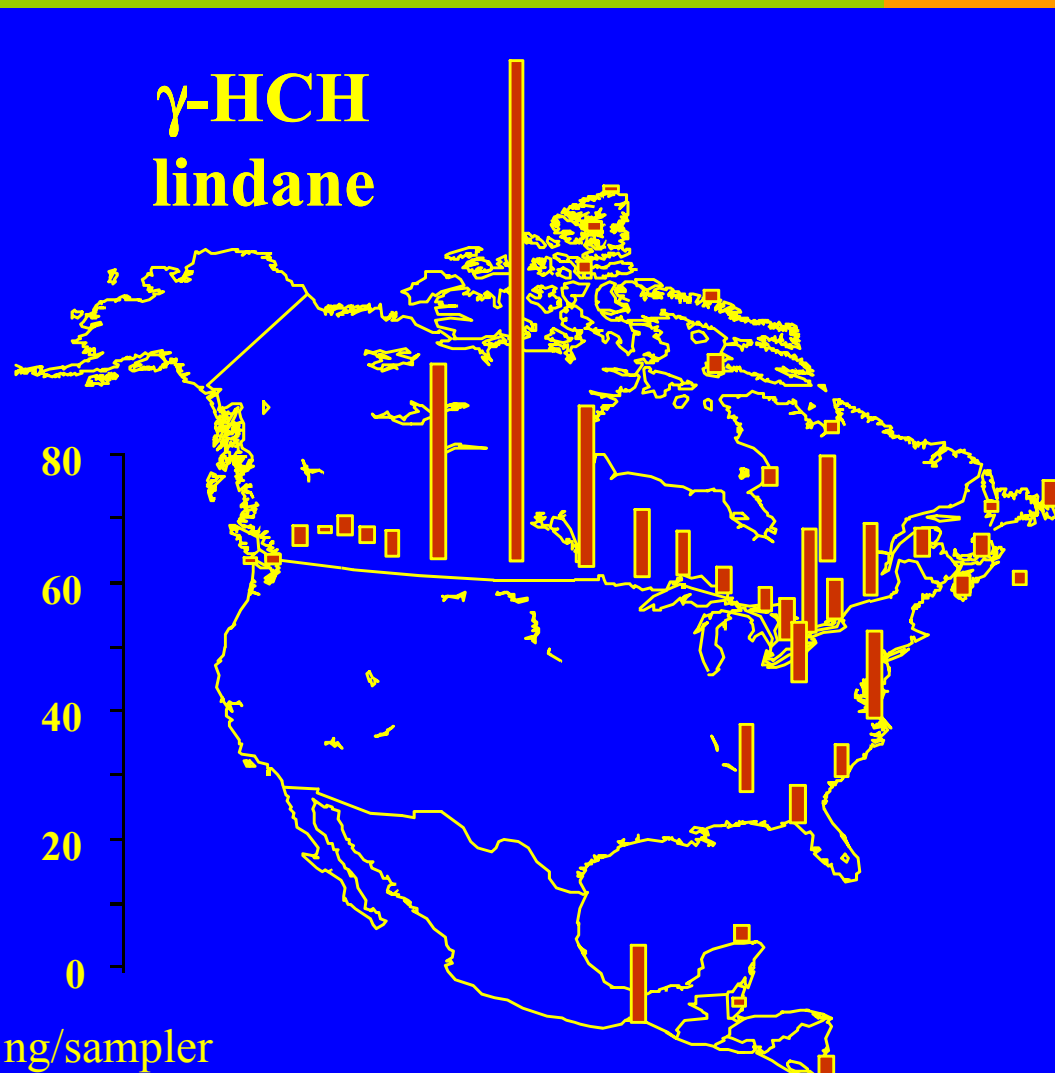
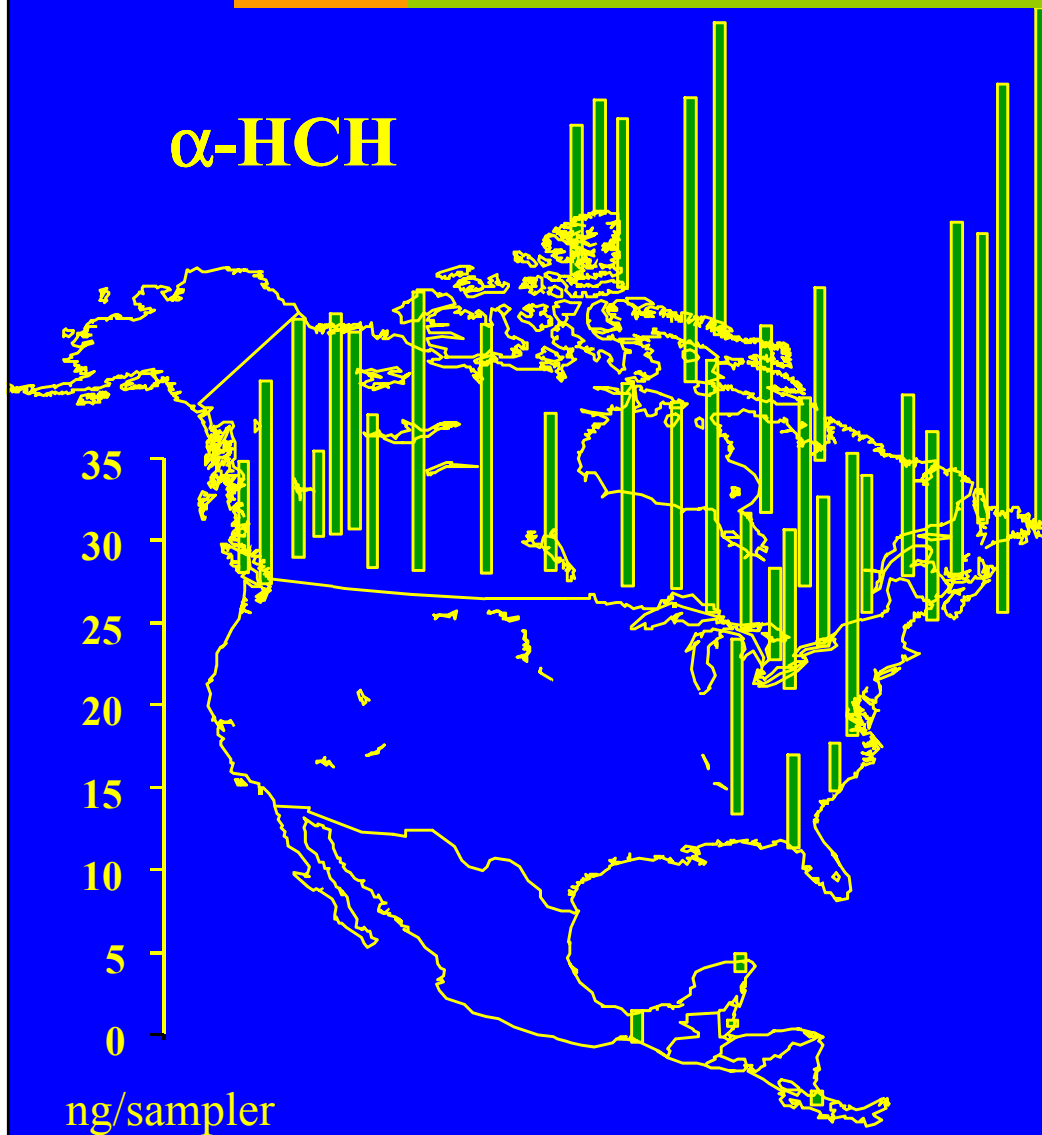

- relatively uniform across Canada and US
- highest levels in Atlantic Canada

- large differences across North America
- highest levels in Canada Prairies

R-○ & A low levels in central America

PUF disk passive air samplers

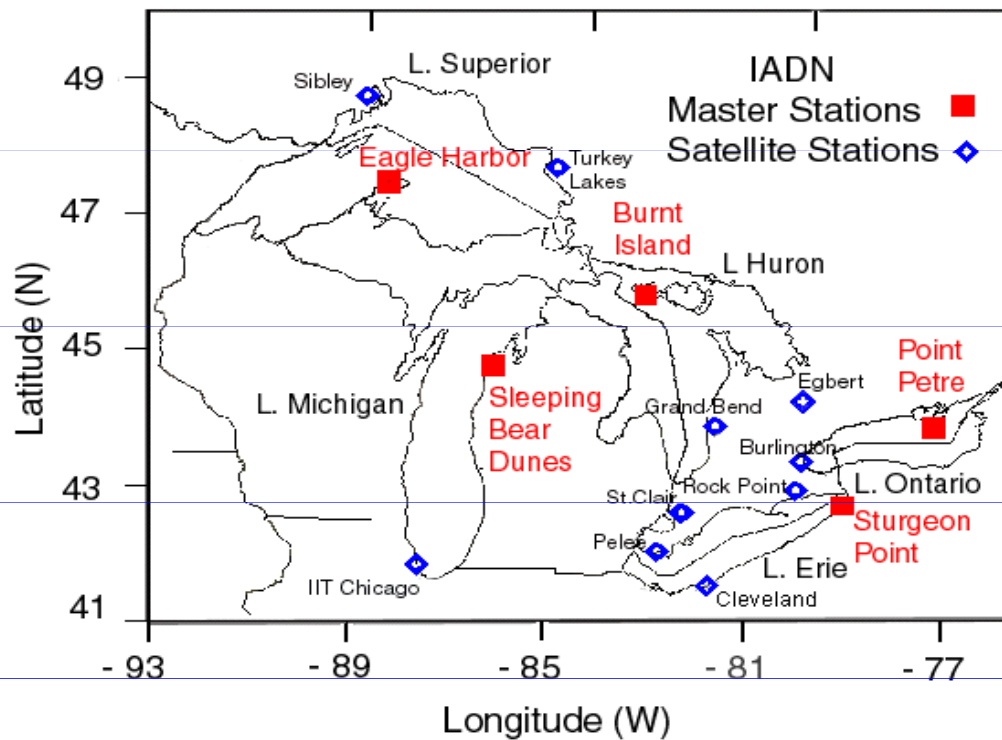

Mapping POPs in the Great Lakes Basin

Meteorological Service of Canada (Tom Harner)

Lancaster University (Kevin Jones)

Health Canada (Jiping Zhu)

- ↻ ~ 25 sites
- ↻ 3 month integration (started July 2002) (summer, fall, winter, spring)
- ↻ equivalent ~400m³ sample volume
- ↻ targets - PBDEs, PFOS precursors and OCs
- ↻ indoor vs. outdoor air – Ottawa, Canada (80 homes, winter 2003)



Polyurethane foam (PUF) discs

- ⇒ **The design and analysis is very straightforward; they are cheap, easy to construct, prepare and analyse (Shoeib and Harner, 2002)**
- ⇒ **Initial studies have characterised their general performance and sampling rates**
- ⇒ **PUF discs have been used for large-scale spatial mapping exercises in Canada and Europe**
- ⇒ **Their ideal deployment times are typically weeks/months**

PASAE Programme – Lancaster Study Across Europe



POPs in air – spatial mapping

⇒ Summer sampling campaign

⇒ Simultaneous passive air
sampling ~ 100 sites

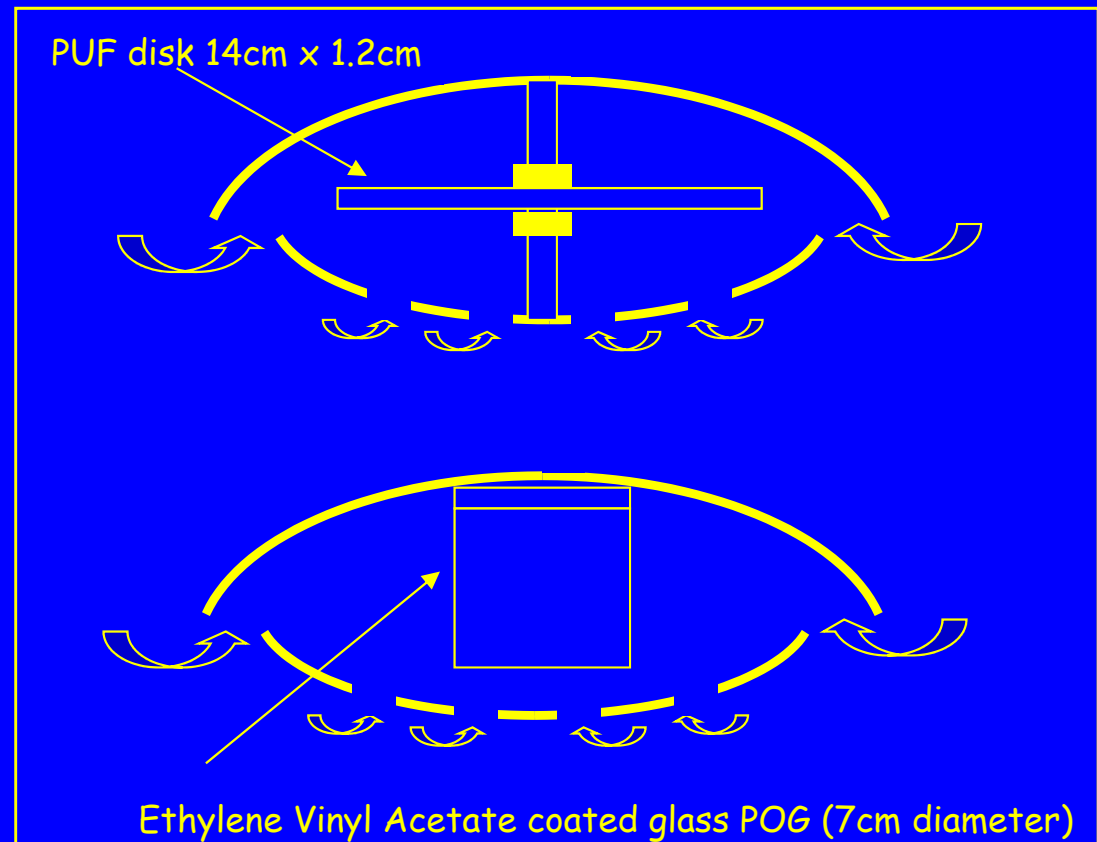

Spatial Distribution of Σ PAHs

Largest bar = 10 400 ng/sample (Moscow)

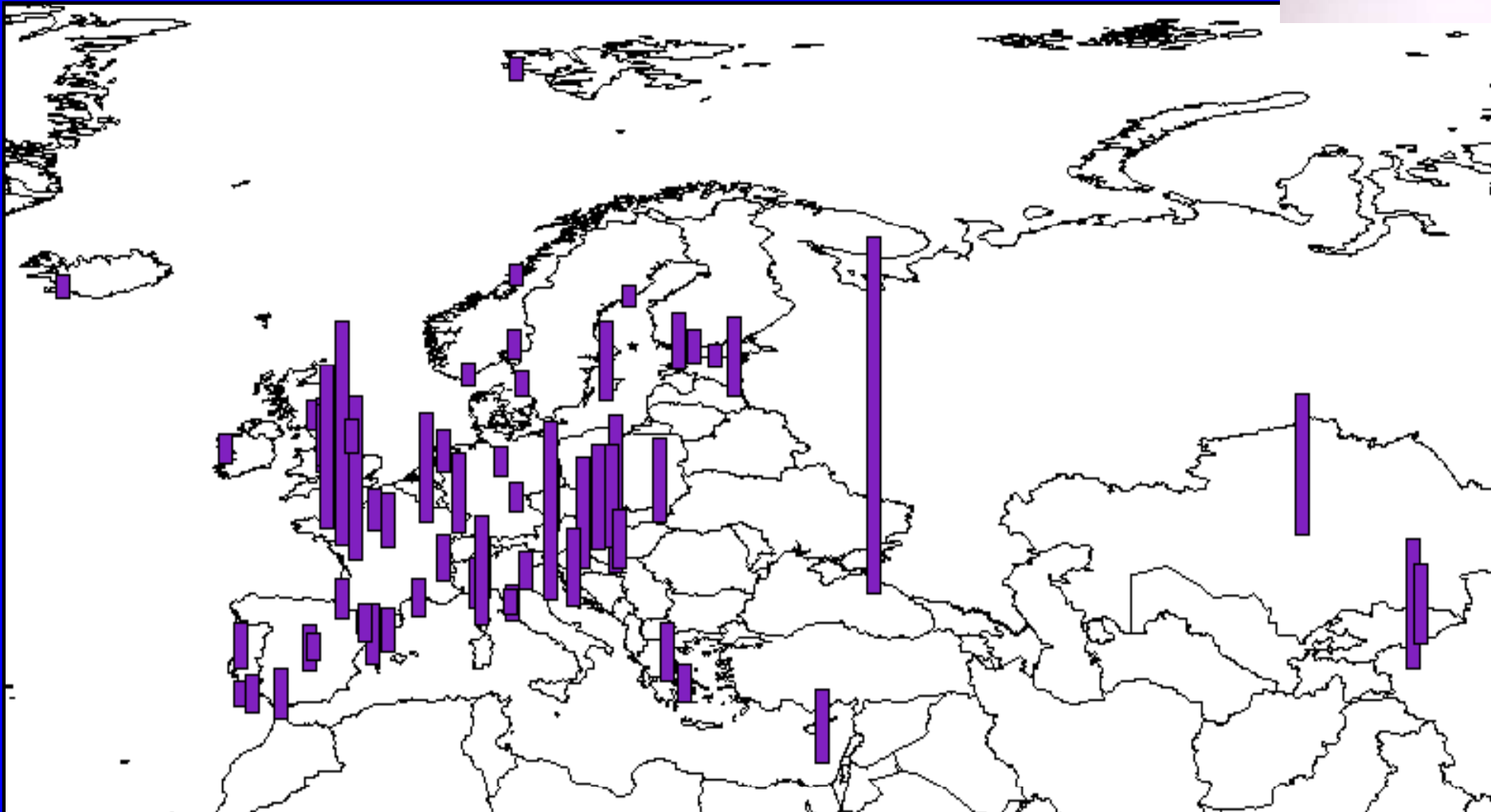

Spatial Distribution of Σ PCBs

Largest bar = 280 ng/sample (Moscow)

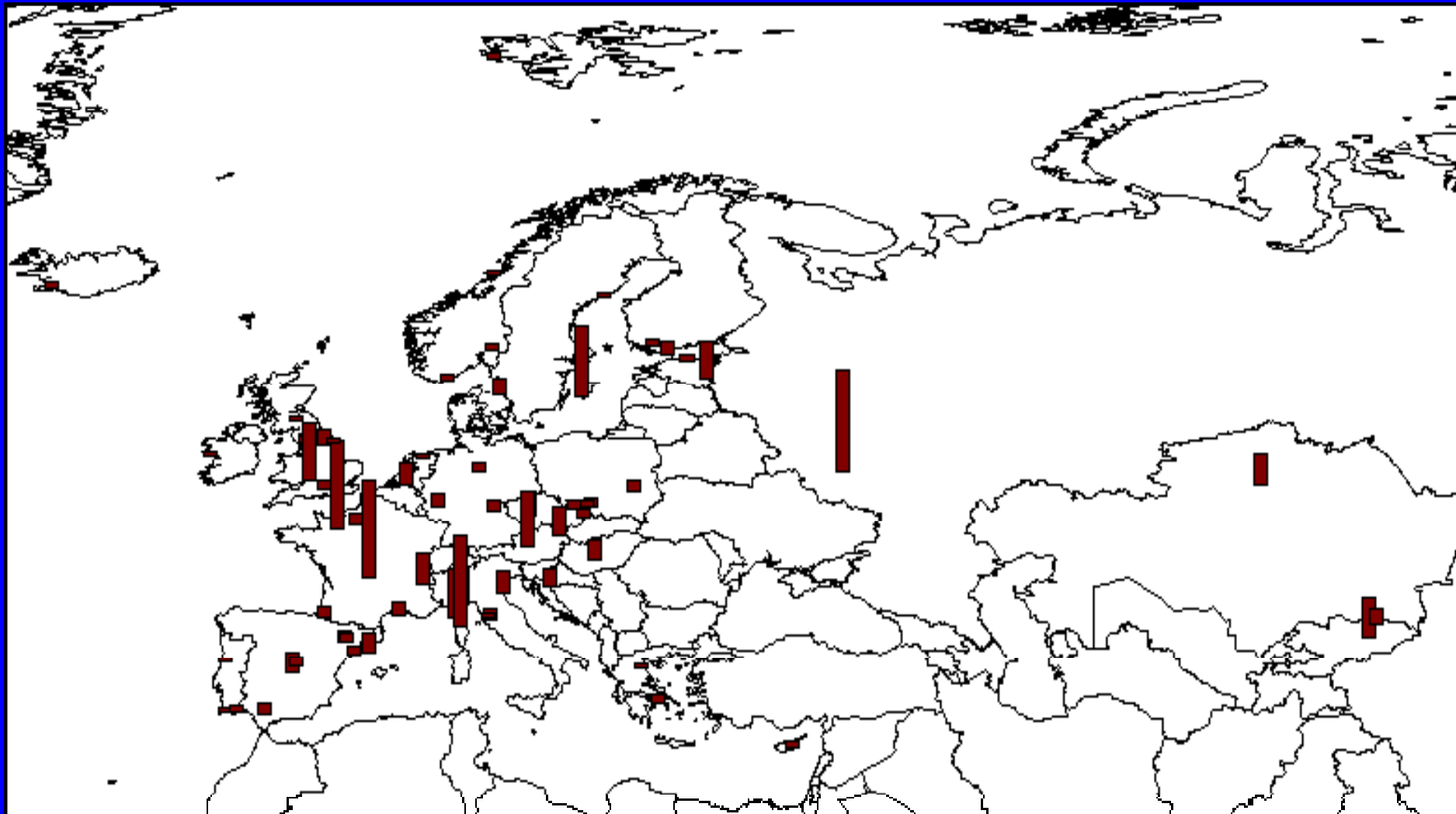

Spatial Distribution of Σ PBDEs

Largest bar = 43 ng/sample (Manchester)

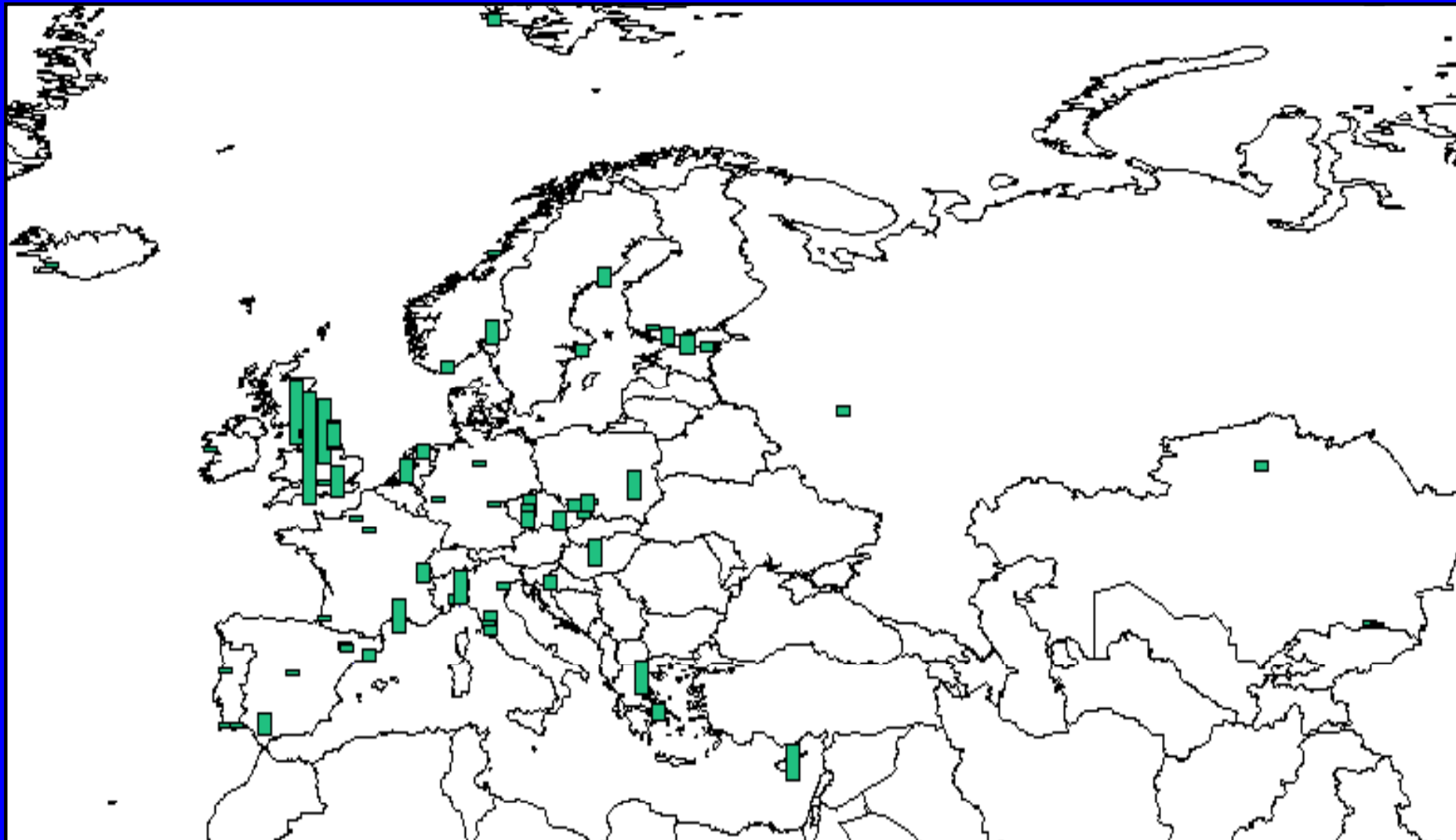

Spatial Distribution of Σ PCNs

Largest bar = 33 ng/sample (Poland)

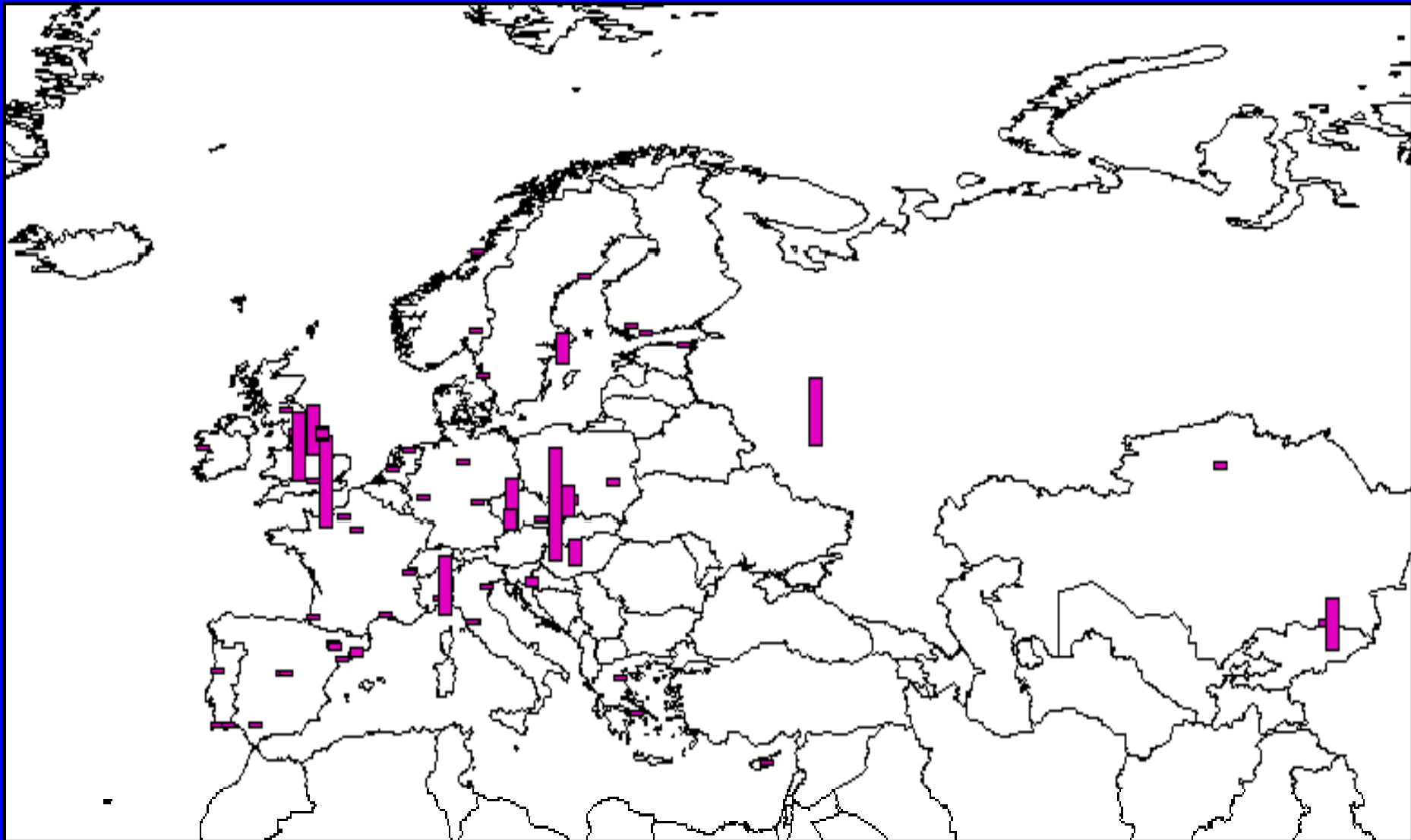

Spatial Distribution of HCB (ng/sample)

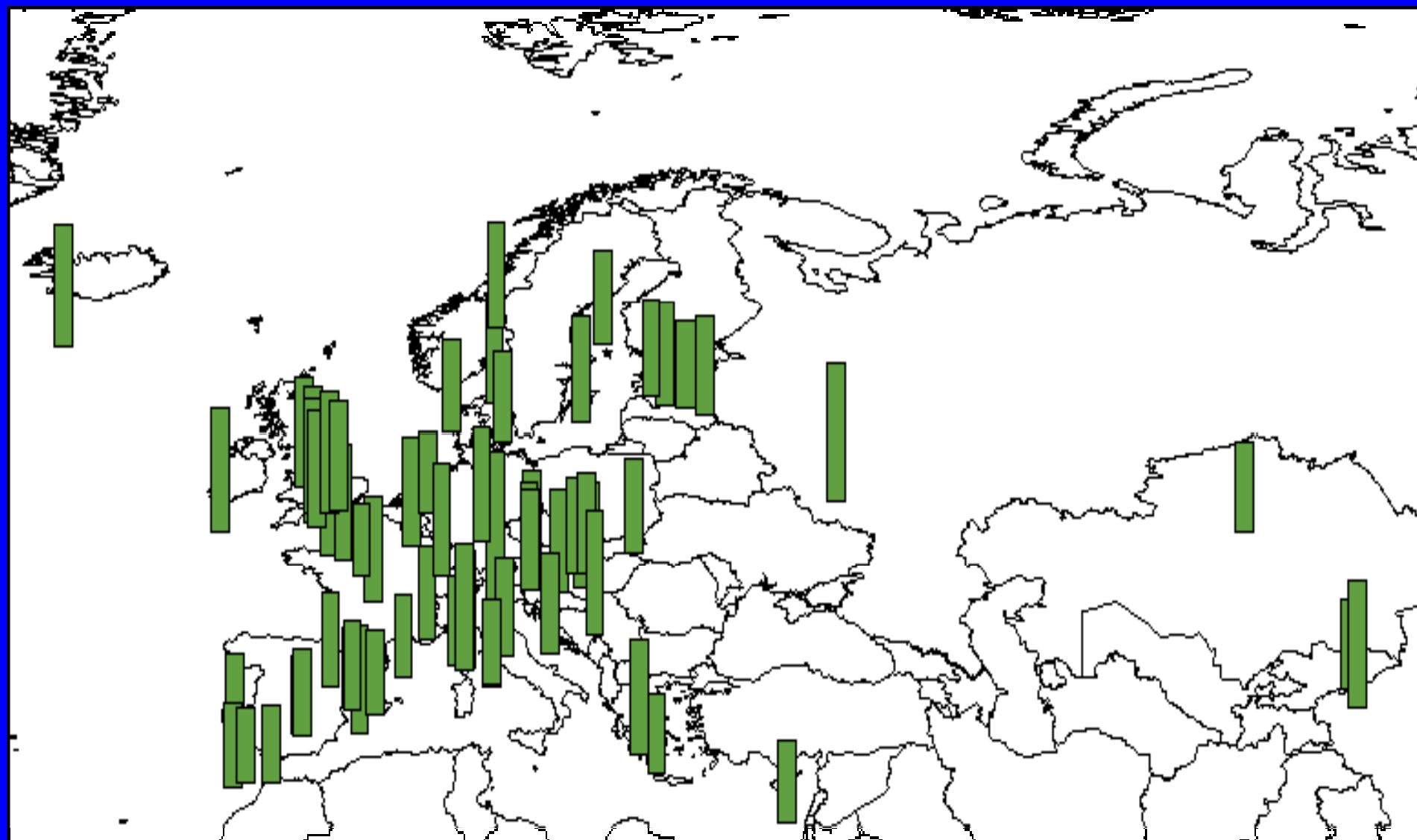

Summary of results

Compounds	Detection limit (ng/sample)	Measured range (ng/sample)	High : Low ratio	Air conc. [pg/m ³]
Σ PCBs	0.03 - 0.64	2.5 - 280	>100	20 - 1 700
Σ PAHs	0.5	64 - 10 400	>160	500 - 61 200
PBDEs	0.06 - 1.5	0.06 - 43	>700	0.5 - 250
Σ PCNs	0.1 - 1.3	0.03 - 34	>1 100	0.2 - 200
HCB	0.13	1.4 - 9	6	11 - 50

PASAE Programme - CR Study

Brno, region Zlín

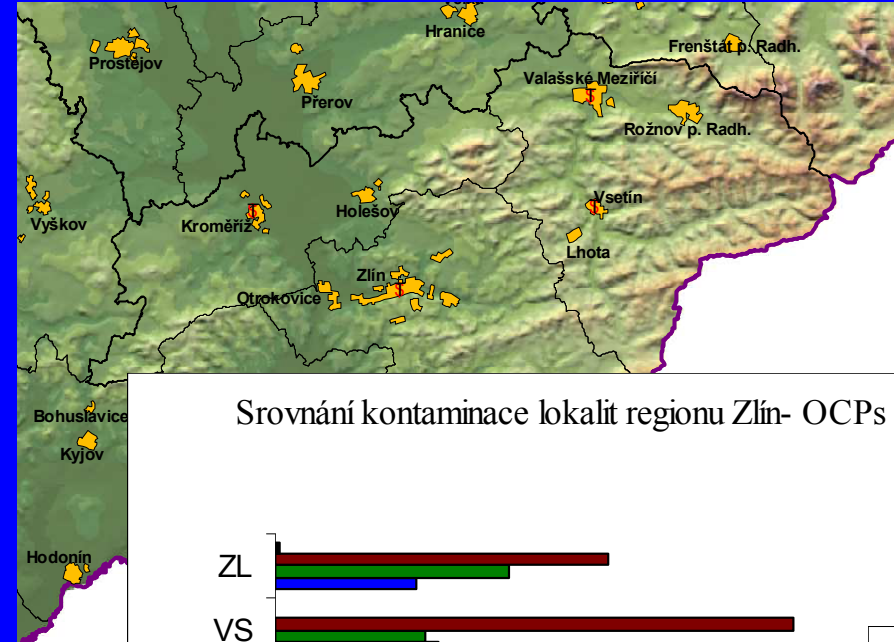

Srovnání kontaminace lokalit regionu Zlín-PAHs

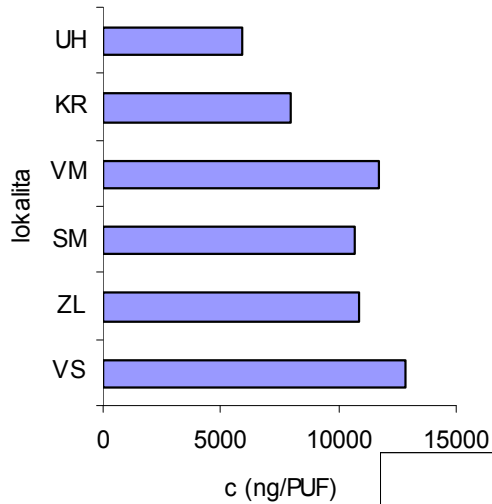

Srovnání kontaminace lokalit regionu Zlín- OCPs

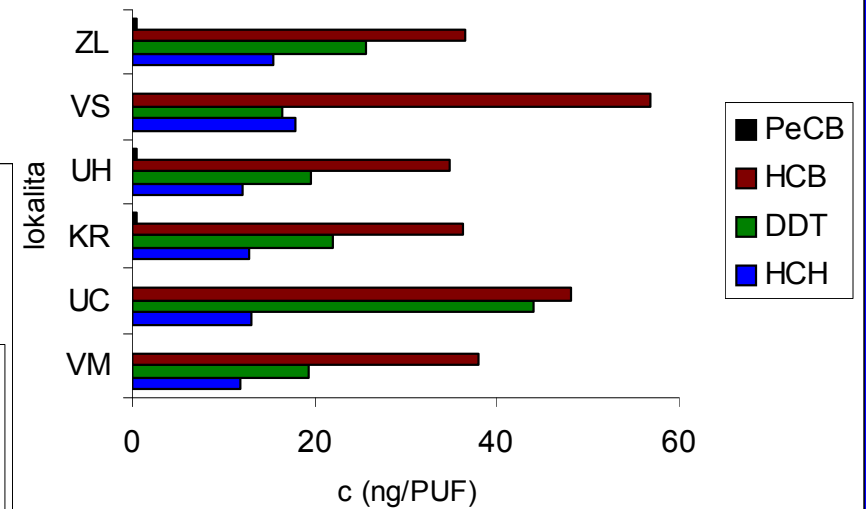

Srovnání kontaminace brněnských lokalit- OCPs

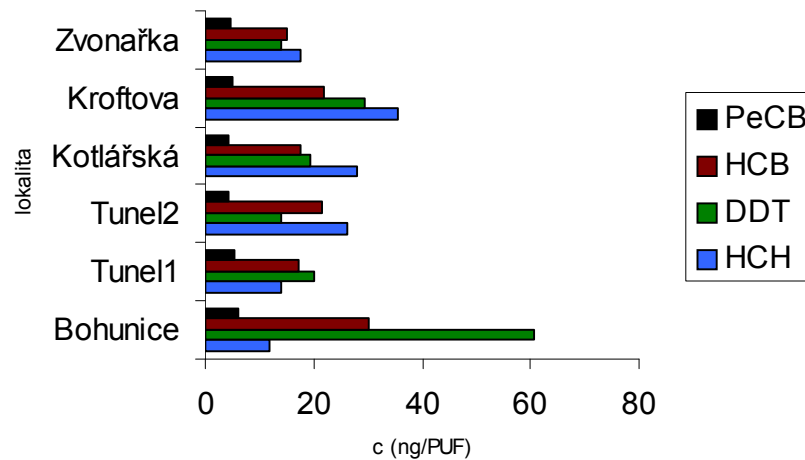



Odběrové lokality - pasivní vzorkování

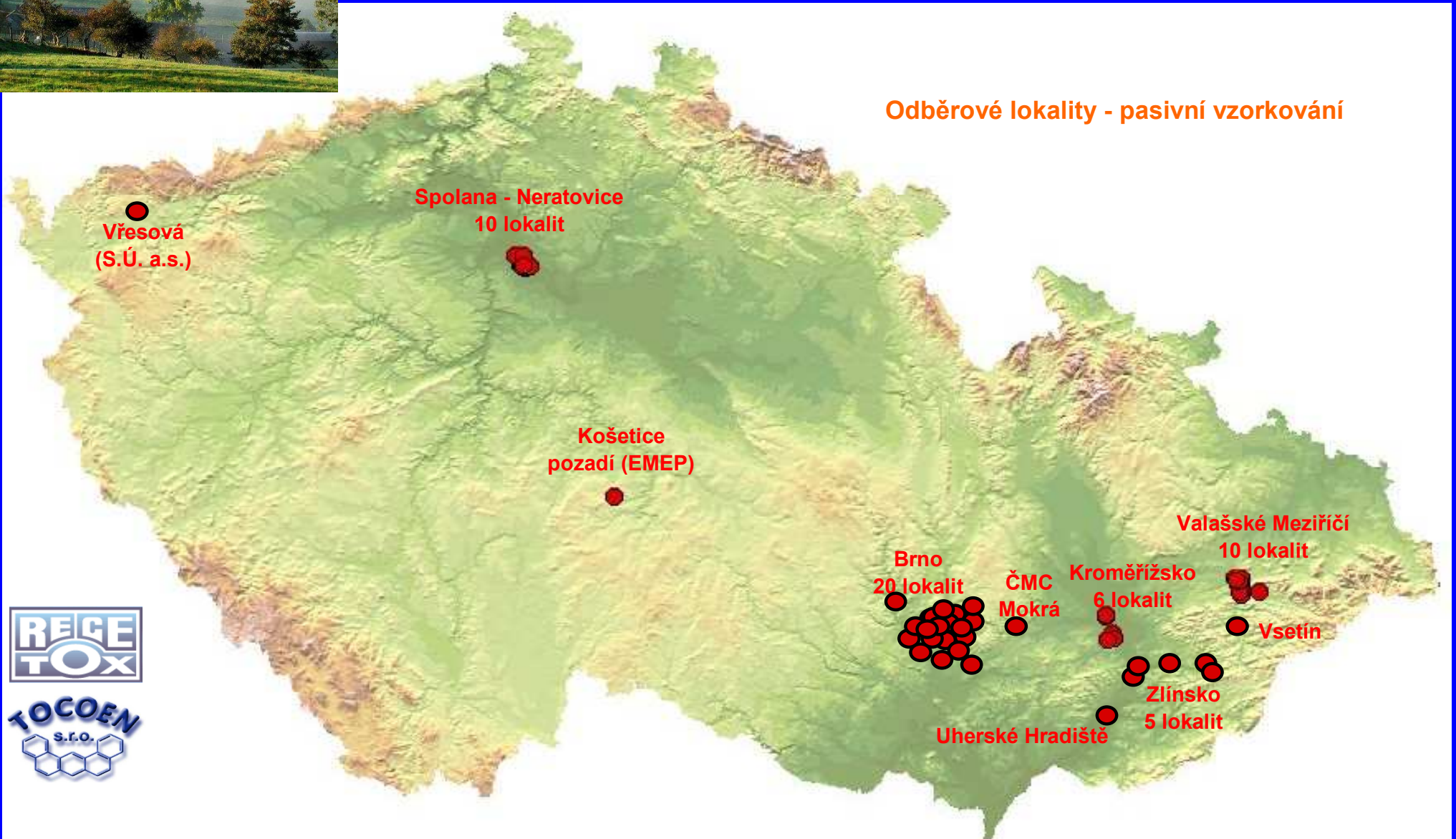

Atmosférická depozice

- mokrá (přenášena na zem srážkami, převládá v čistých oblastech)
- suchá (sedimentací velkých částic atmosférického prachu a vlivem znečišťujících plynů, převládá ve městech)

Odběr atmosférické depozice

- mokrá (odběr pouze srážek do automatických jímačů)
- suchá (funkce koncentrace složky v ovzduší a rychlosti depozice, sběrné nádoby)
- součet mokré a suché atmosférické depozice (sběrné nádoby, nálevky)

Vzorkování vod

- srážkové
- sběrné nádoby, nálevky
- pasivní jímače vody z ovzduší
- povrchové
- skleněné vzorkovnice
- podpovrchové
- skleněné vzorkovnice plněné čerpadlem

Vzorky vod jsou nestabilní, vytěkávají, precipitují, fotochemicky se rozkládají, mikrobiálně degradují, snadno se kontaminují.

Je třeba analyzovat co nejrychleji, konzervovat nebo sorbovat.

Passive sampling what is it and why?

- Time integrated accumulative “sorption”
- Non-mechanical
- Can overcome other problems with current techniques: filtration/volatilization/sorption losses
- Overcomes detection limit problems
- “Biomimetic”

Assumptions and “Sampling Rates”

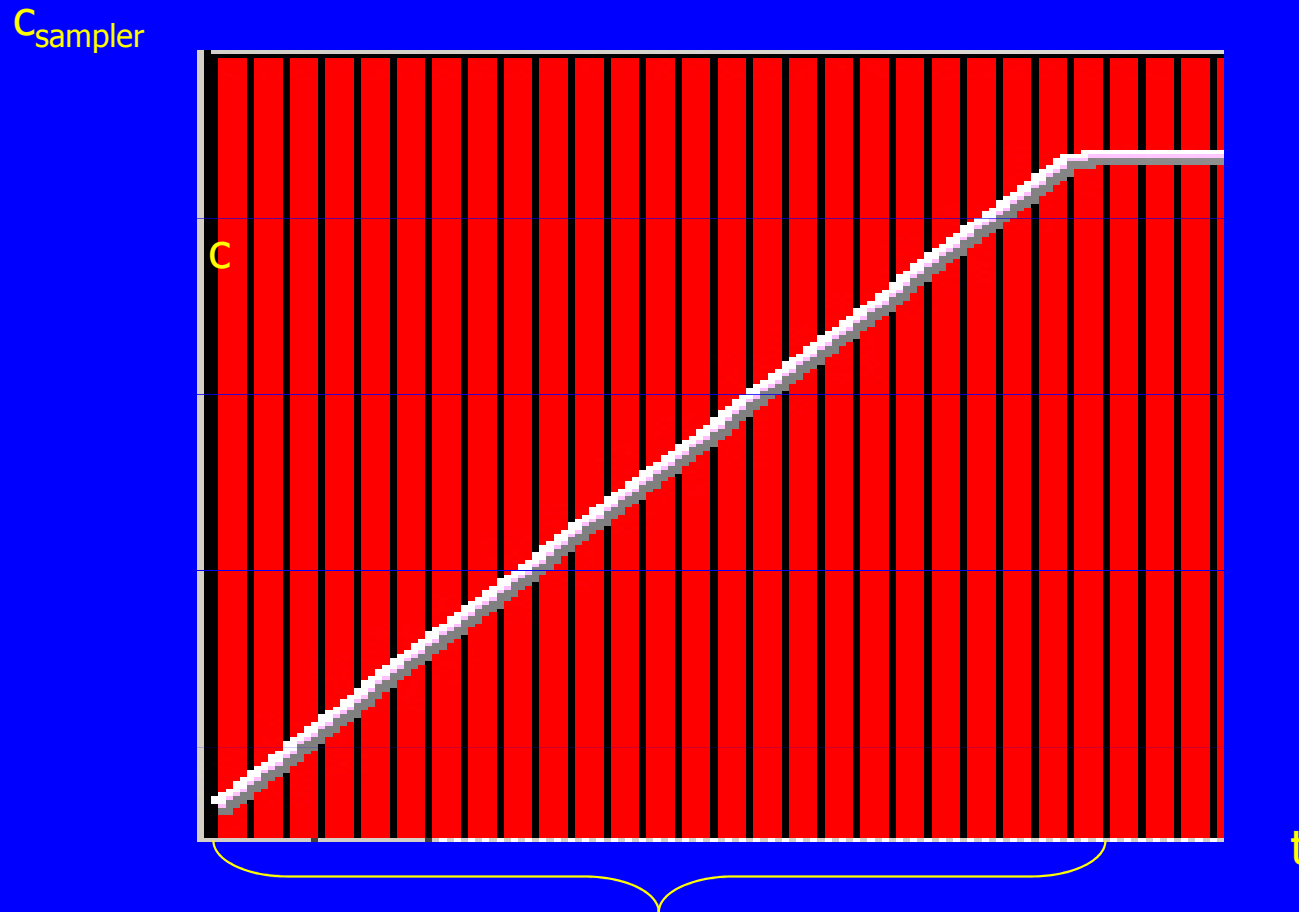

$$R = \frac{\Delta C_{\text{sampler}}}{\Delta C_{\text{water}} \cdot t} \quad \left[\frac{L / \text{sampler}}{\text{day}} \right]$$

Modern Aquatic Passive Samplers

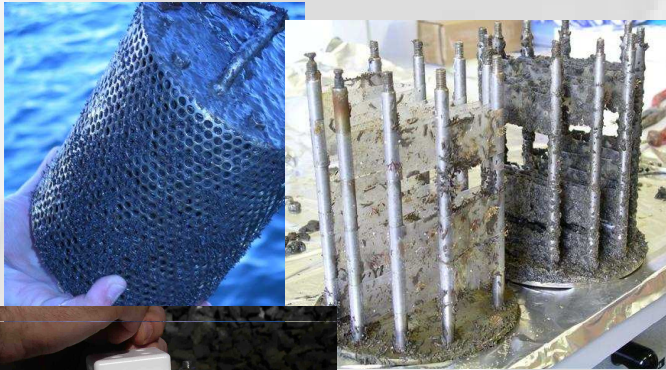

SPMD	Huckins.	Hydrophobic. Greatest application since 1990s.
POCIS	Alvarez.	Hydrophilic. Under development.
DGT	Davidson & Zhang	Metals. Well developed gel processing
SPME	Arthur, Pawliszyn <i>et al.</i>	<i>No extracation or cleanup!</i> Low capacity/duration

“Empore[®]?”

PTFE & silica-bound analytical grade sorbents – can we bring the laboratory to the field?

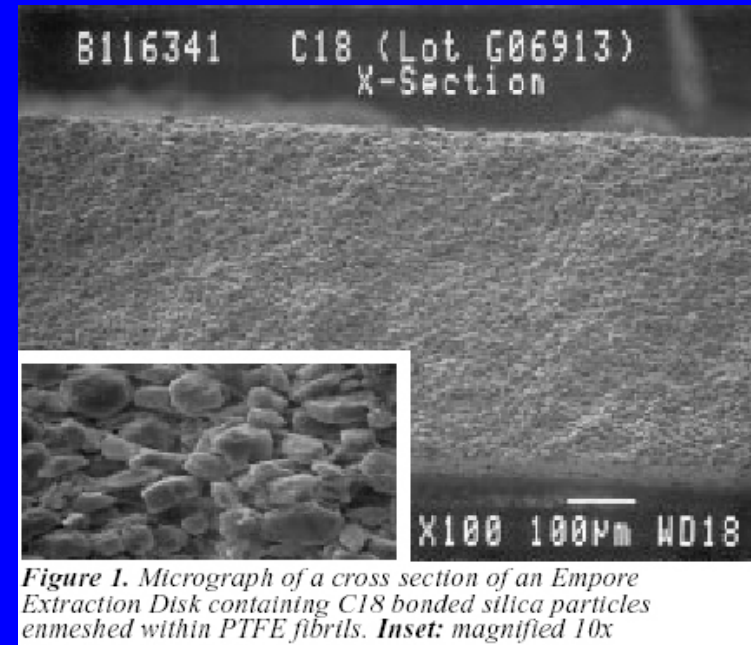
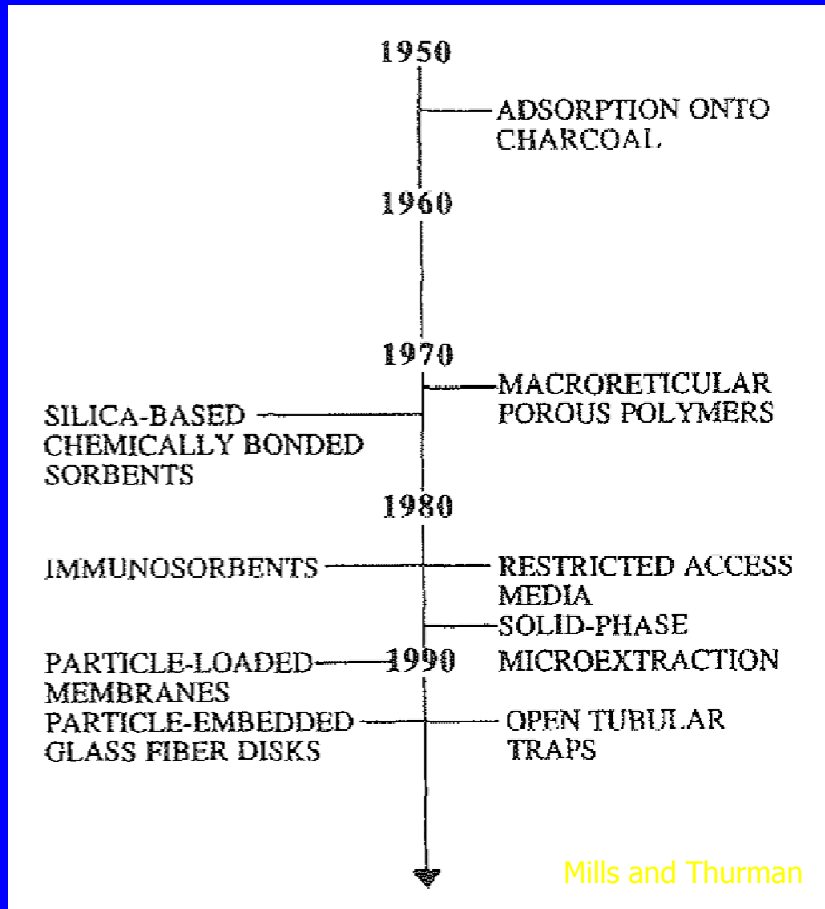

First study: Norman Creek

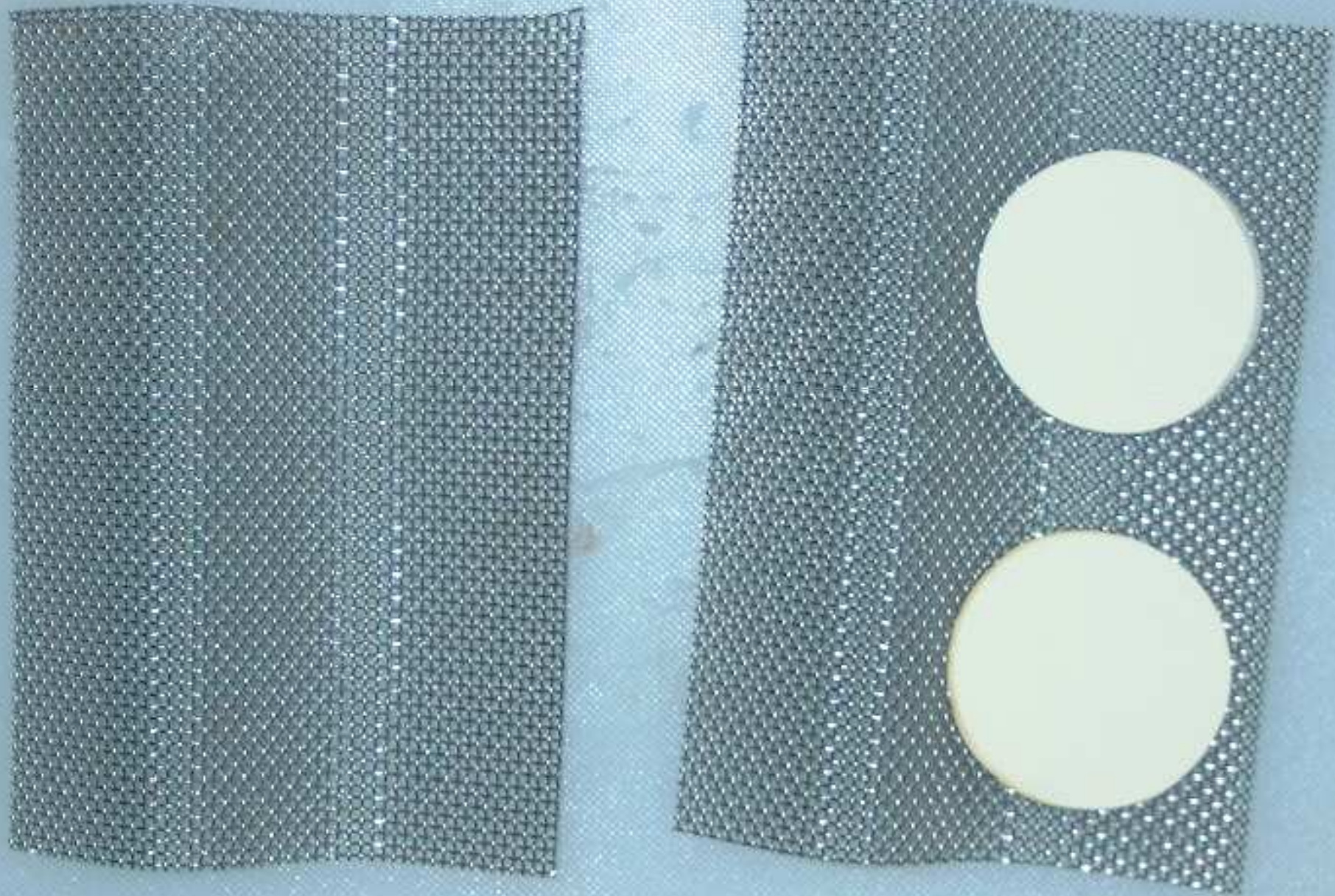

Extraction and Analysis

Ultrasonic bath



5 min 5mL Acetone

5 min 10mL $C_8H_{18} + C_4H_8O_2$

pipette

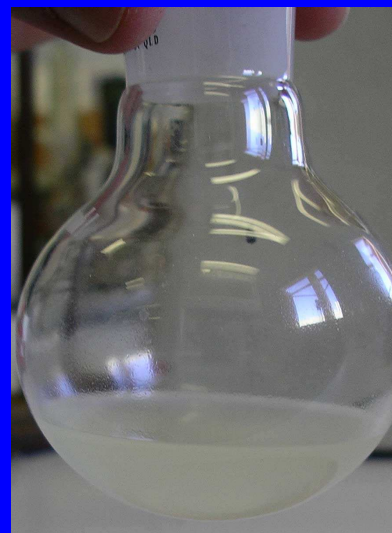

5-15 min

Rotary
Evap

N_2 blowdown

5-20 min

1mL analysed via
LCMS/MS



Herbicide (low K_{ow}) “Sampling Rates”

$$R = \frac{\Delta C_{sampler}}{\Delta C_{water} \cdot t}$$

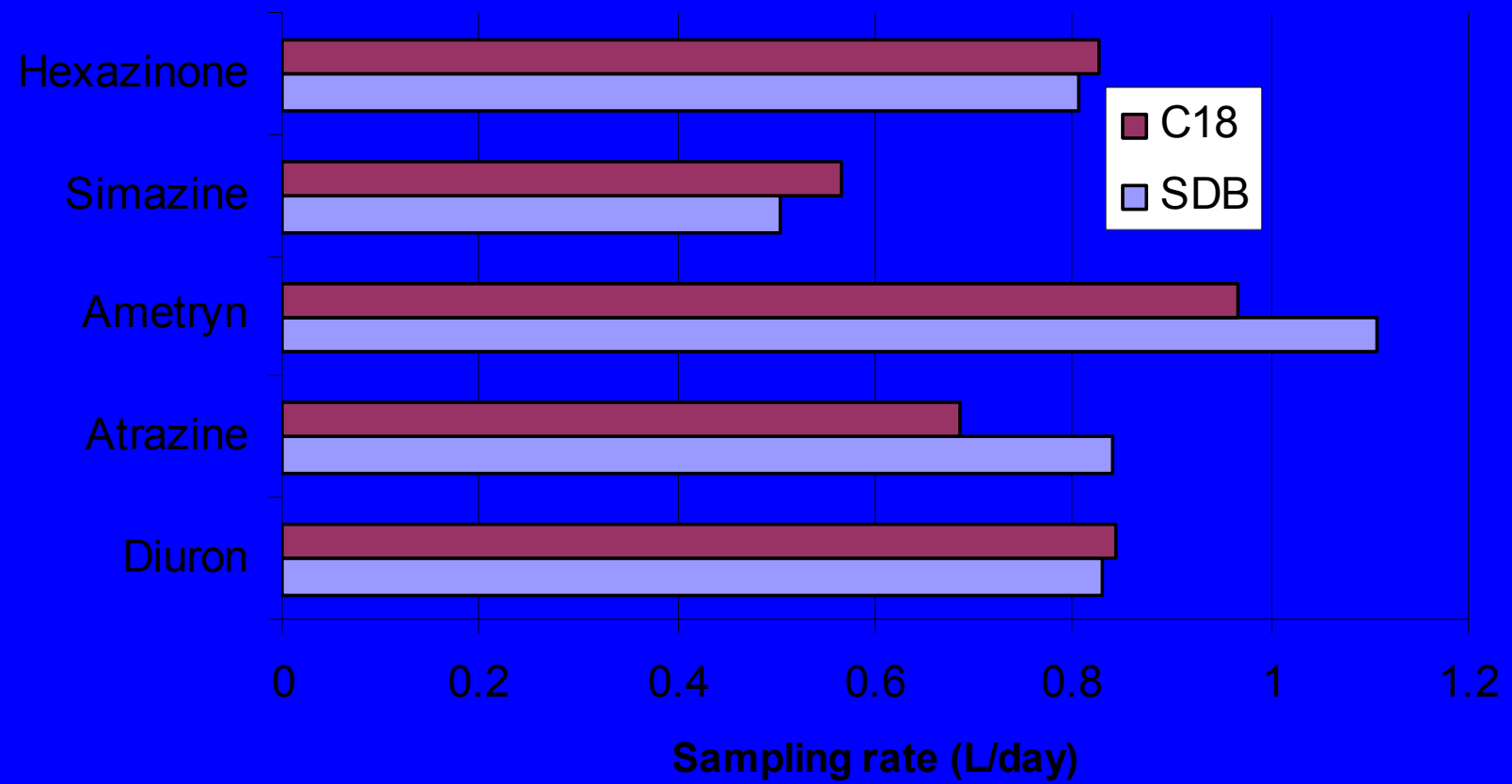

Data point from C18 day 1 excluded; means from duplicate samples

SPMD - Semipermeable membrane device

- selektivní vzorkovač organických polutantů
- dialyzní vak nebo membrána, lipidická náplň
- založeno na průniku látek polopropustnou membránou
- jde o integrativní pasivní vzorkovač
- selektivní pro lipofilní sloučeniny
- vzorkuje pouze biodostupnou frakci
- odhad distribuce mezi vodou a vzorkovačem: K_{ow}
- pro vzorkování vody, vzduchu, půd, kalů
- nevýhoda: vztah mezi celkovým a biodostupným množstvím polutantů

Semipermeable Membrane Device (SPMD)

(designed by Huckins *et al.*; U.S. Geological Survey)

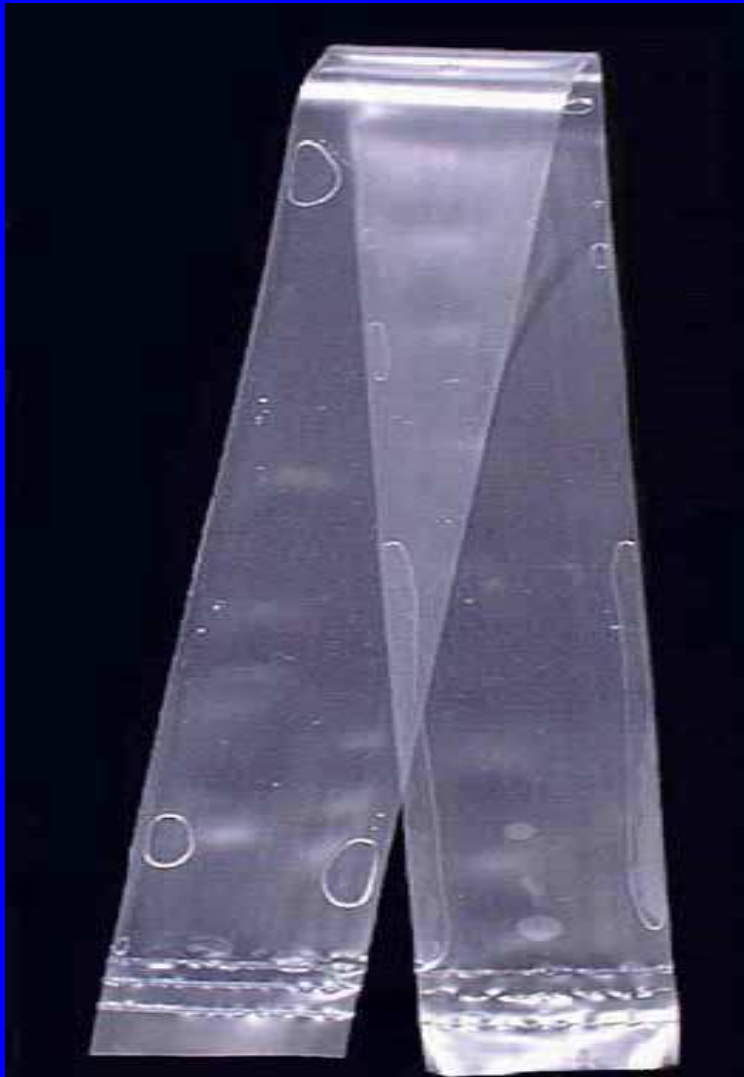

Thin film of triolein (“lipid phase”) encosed in a lay-flat LDPE membrane.

- *applicable for sampling of more hydrophobic POPs in water and air*
- *mimics uptake of dissolved contaminants by biota (estimation of bioaccumulation)*

Water monitoring using SPMDs



Membrane-enclosed SPME fibre for passive water sampling

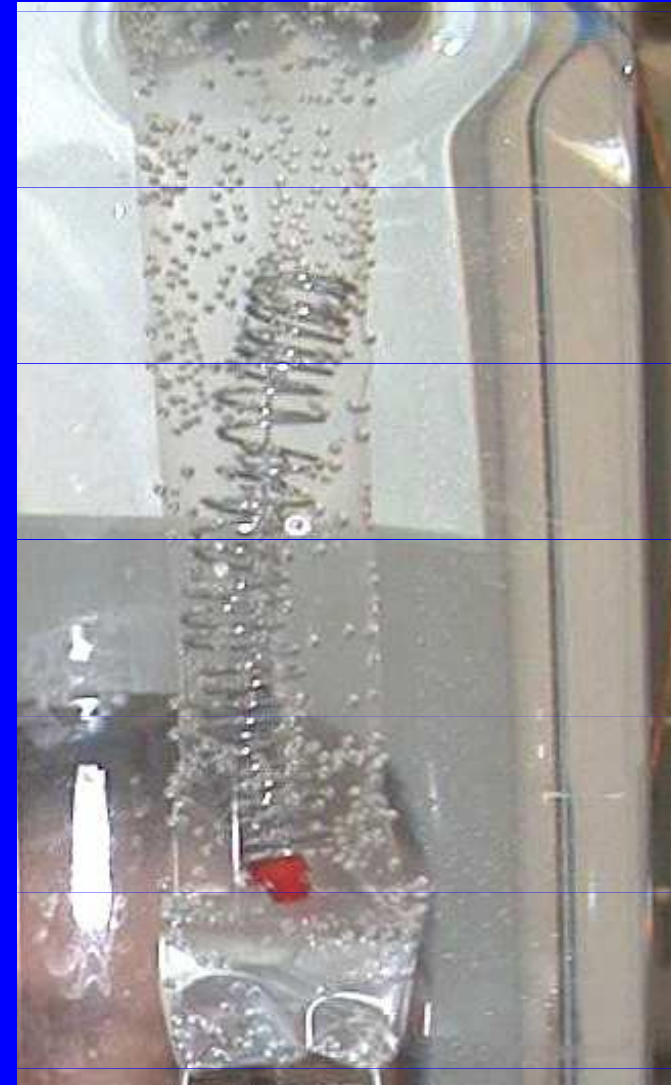
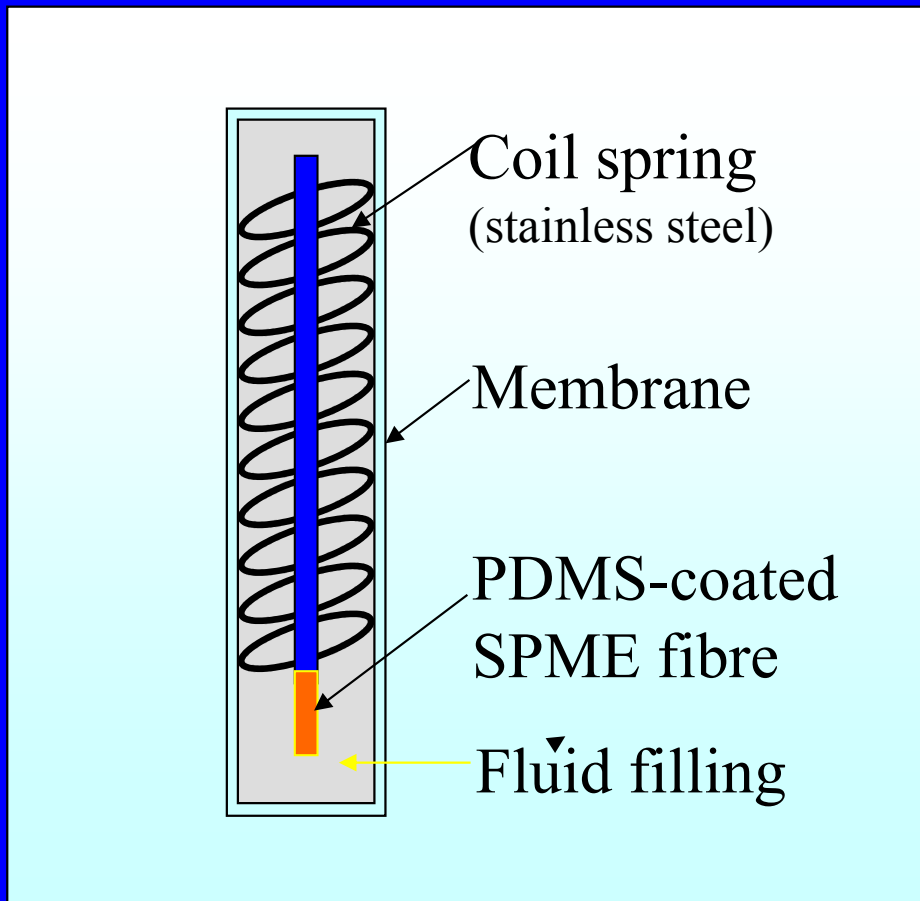

MESCO strips and bare silicone rods ...



...before and after field exposure



Comparison of TWA water concentrations (SPMDs vs. bare SRs)

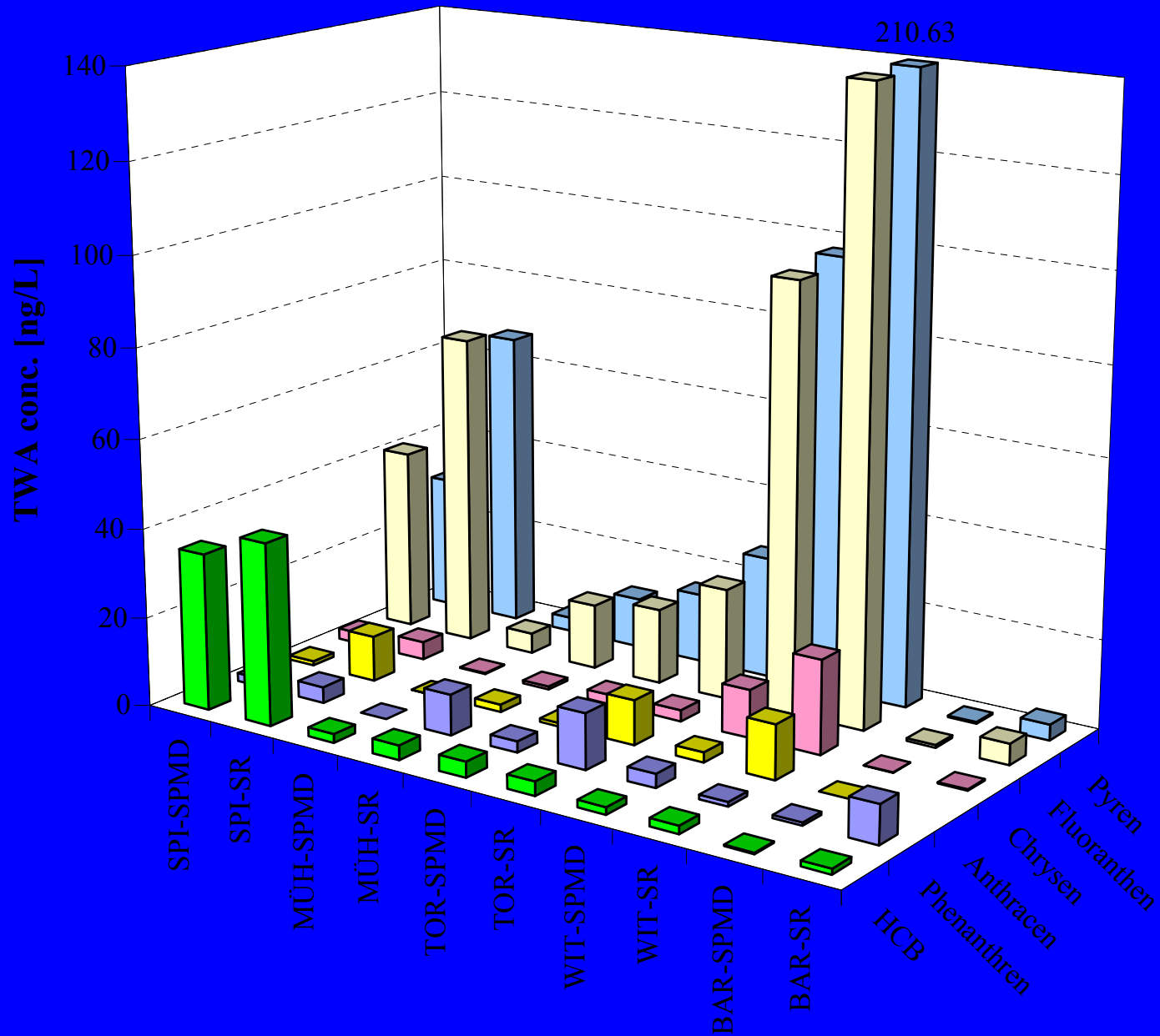

- To which extent biofouling and precipitation reduce the membrane permeability of the MESCO strips?
 - ← Evaluation of LDPE dialysates and of PRC elimination!
- Where is the lower lipophilicity limit for an effective enrichment of compounds in silicone tube/rod material?
 - ← Non-target analysis of additional rod specimen!
- Are the uptake kinetics in bare silicone rods flow-rate dependent (in the tested range of water flow)?
 - ← Additional analysis & statistical evaluation of data!

Problem

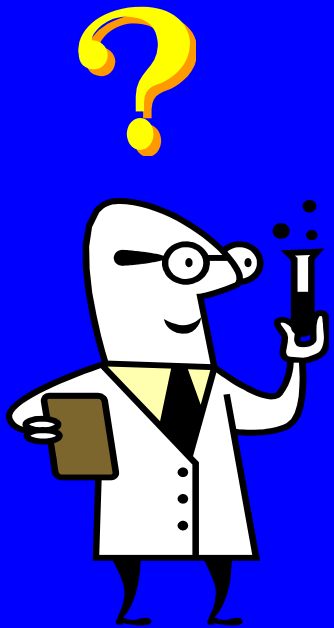

Can environmental aqueous concentrations of pollutants be calculated from the analyte levels accumulated in an integrative passive sampler?

Aims

- To develop national standard for passive sampling technology
- To develop low cost design of sampler appropriate for wide range of analytes
- To produce robust calibrations (with internal standardisation, and inter-laboratory QC) for a wide range of priority pollutants:
 - priority organic pollutants (polar and non-polar)
 - endocrine disruptors
 - surfactants
 - organo-metallic species
 - metals

Sampler construction

<i>Sampler</i>	<i>Non-polar</i>	<i>Polar</i>
Receiving phase	C18 Empore disc	C18 Empore disc
Diffusion limiting membrane	low density polyethylene	polyethersulfone
Priming of the receiving phase	octanol	water
Sample analysis	GC/MS	GC/MS

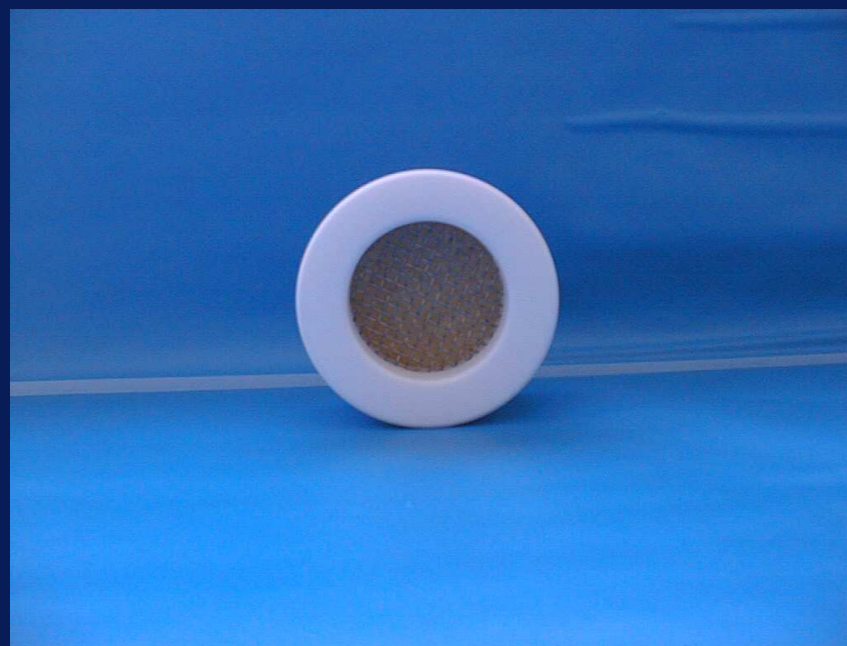

Samplers integrate pollutant concentration over time.

Functional principles of a passive sampler

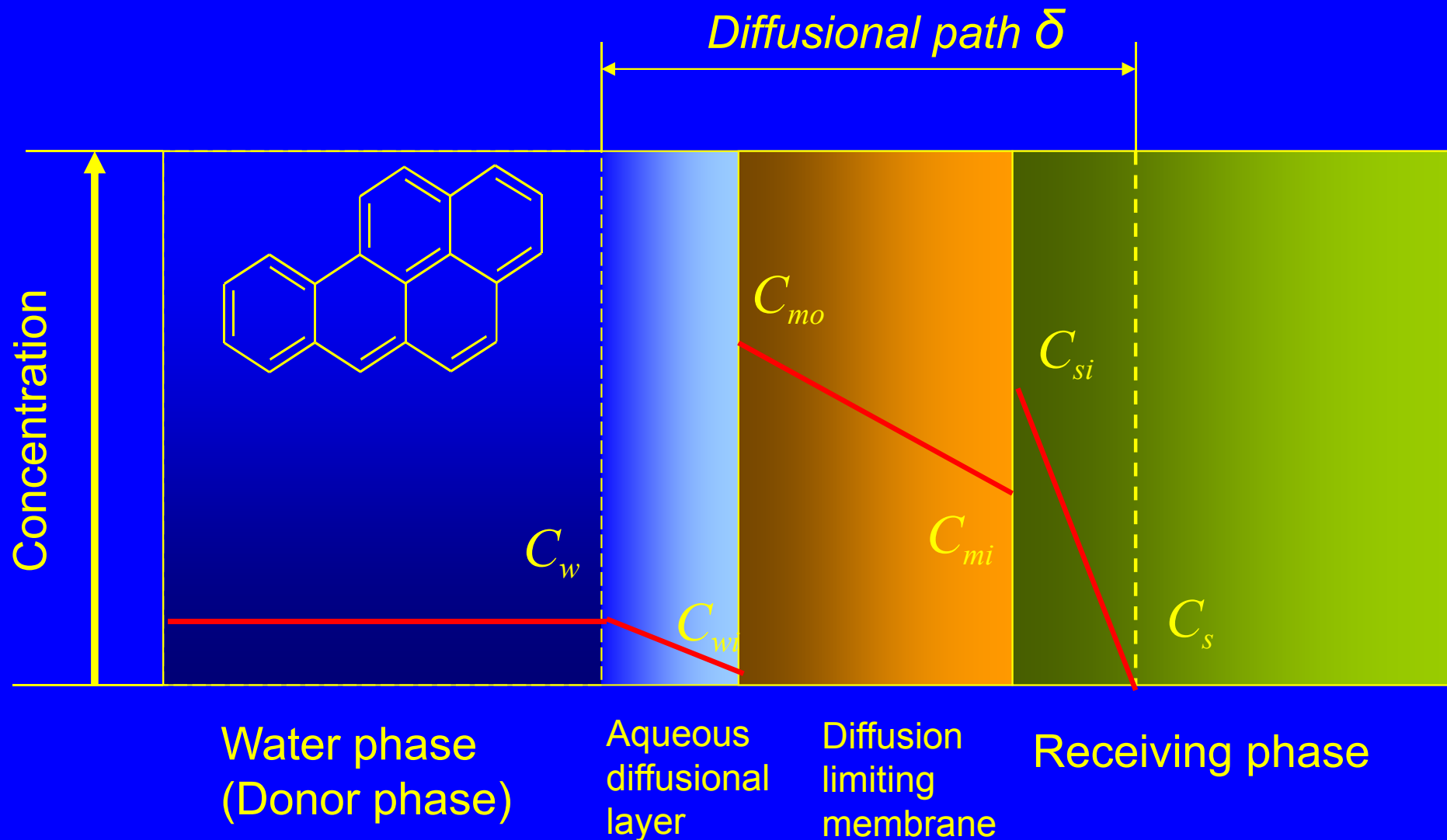

Three phases of passive sampler uptake

$$C_S(t) = C_{S0} + (C_W K_{SW} - C_{S0}) \left[1 - \exp\left(-\frac{k_{ov} A \alpha}{K_{SW} V_S} t\right) \right]$$

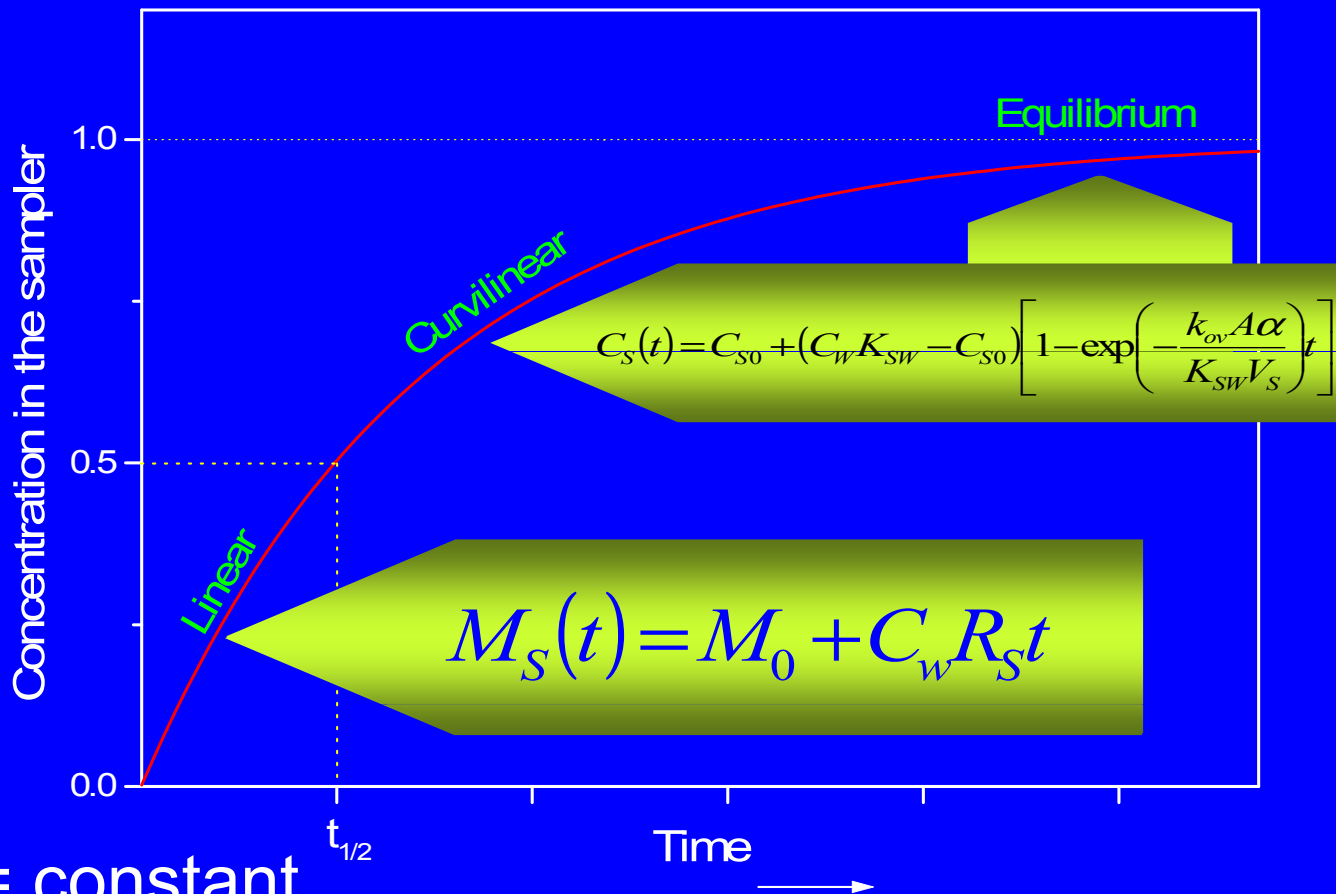

$C_W = \text{constant}$

Calibration of a passive sampler in a flow-through system

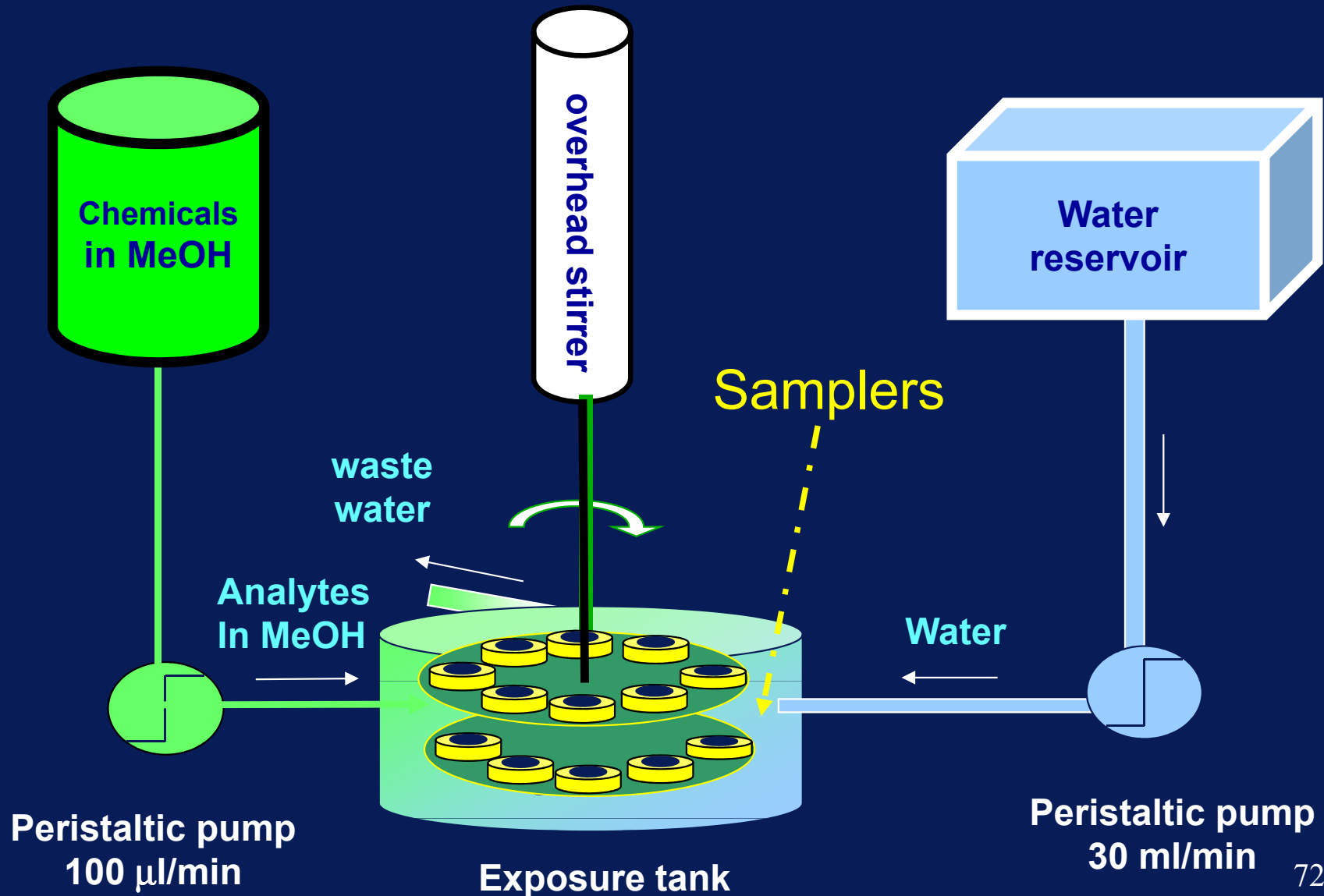

A standardised flow-through calibration system



Uptake kinetics of selected pollutants

Phenanthrene

Alachlor

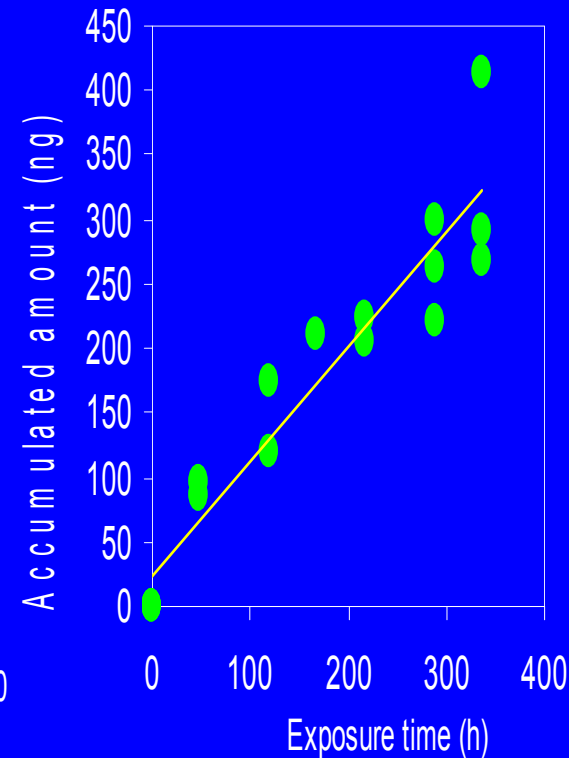
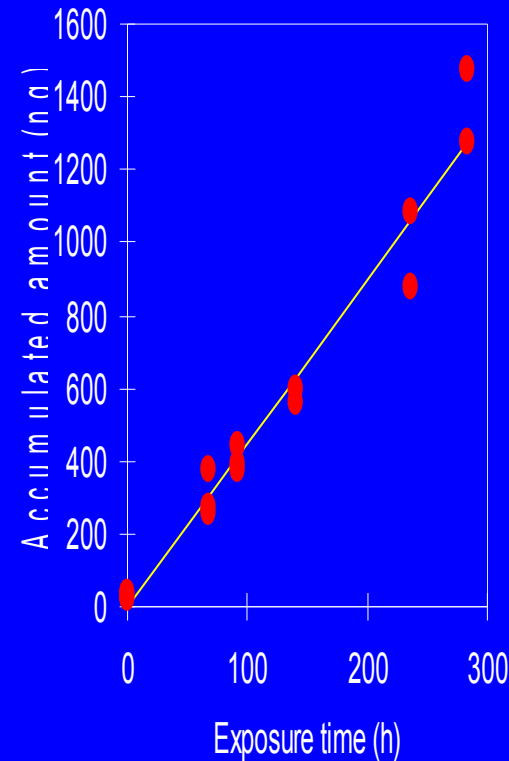

Non-polar sampler,
no stirring (•)

Polar sampler,
stirring at 40 rpm (•)

$$M_s(t) = M_0 + C_w R_s t$$

R_s = substance specific sampling rate (L/d)

Sampling rates of PAHs

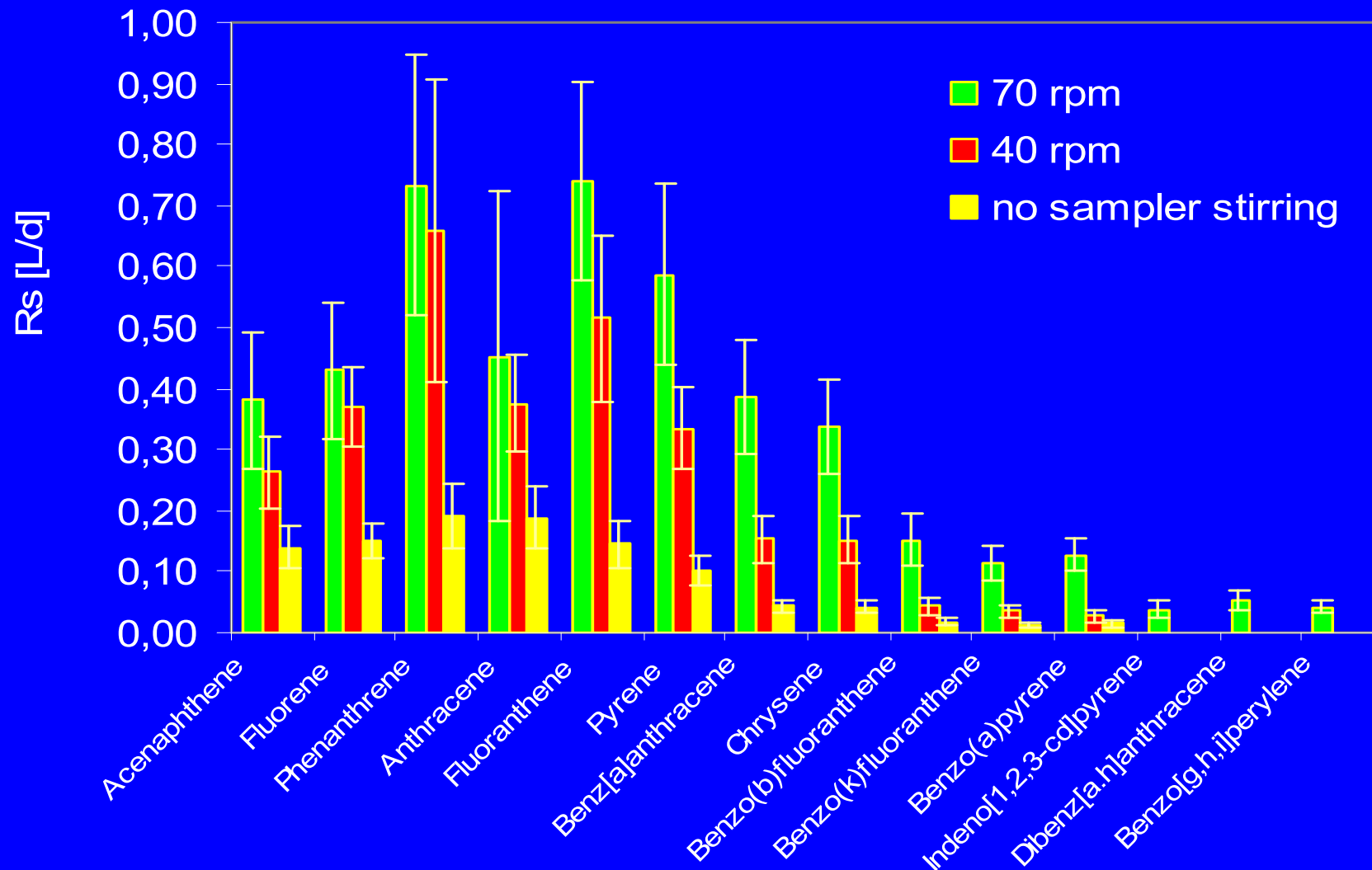

Temperature = 11°C

Use of calibration data

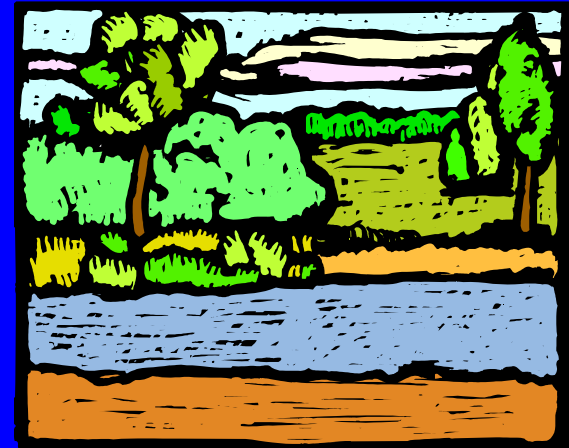
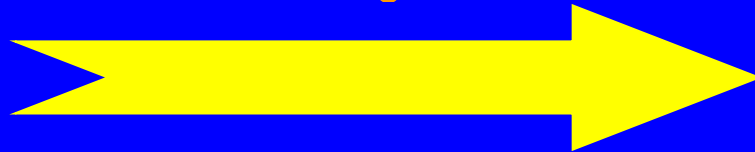
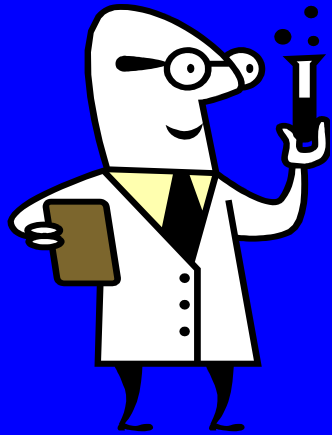

- ★ Calibration conditions should approximate field conditions unless
- ★ Performance Reference Compounds are used
- Use of calibration data for estimating analyte water concentration in the field is not straightforward.

Performance reference compounds

- PRCs are (analytically) non-interfering compounds added to the sampler prior to exposure.
- The use of PRCs - an in situ calibration/recalibration approach, where the rate of PRC loss during an exposure is related to the target compound uptake.
- This is accomplished by measuring PRC loss rates during calibration studies and field exposures.
- Concept was developed by Huckins, Booij et al. for SPMDs

Extraction manifold used for loading the sampler with PRCs

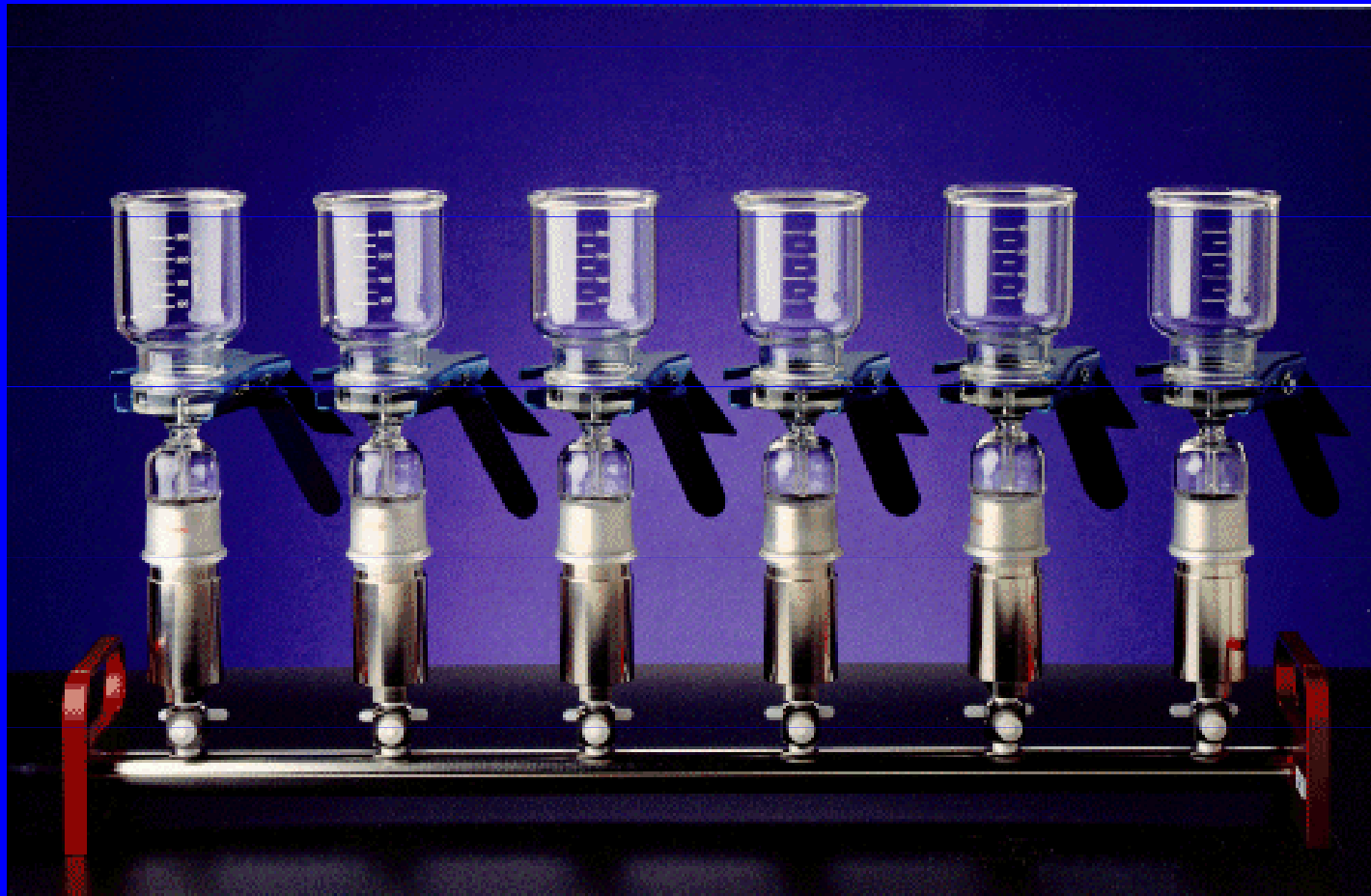

Use of performance reference compounds

$$C_{\text{SAMPLER}}(t) = C_{\text{SAMPLER}}(0) \exp(-k_e t)$$

$$\frac{C_{\text{SAMPLER}}(0) \neq 0}{0} \quad C_w =$$

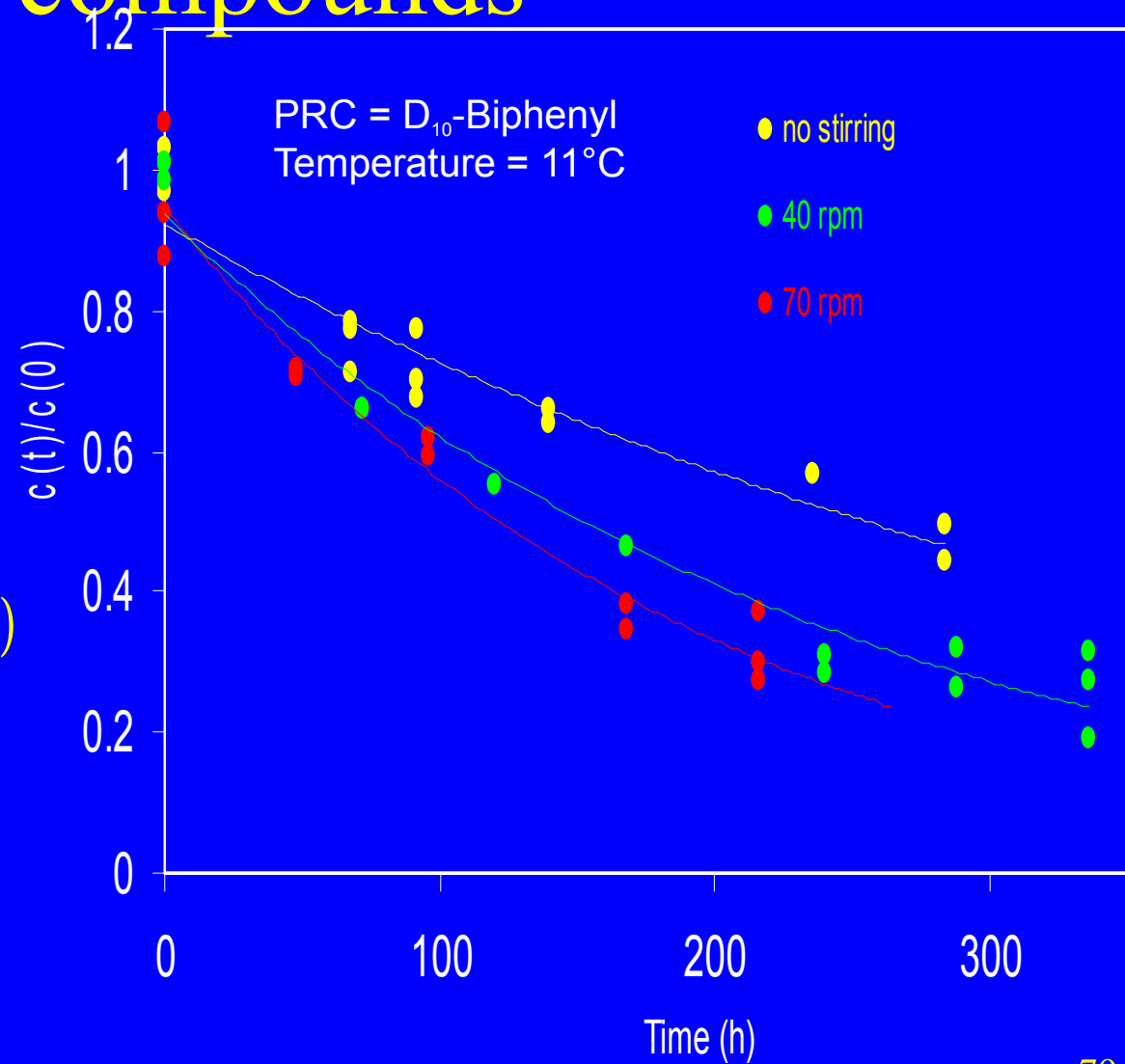

Correlation between offload of PRCs and uptake of target analytes

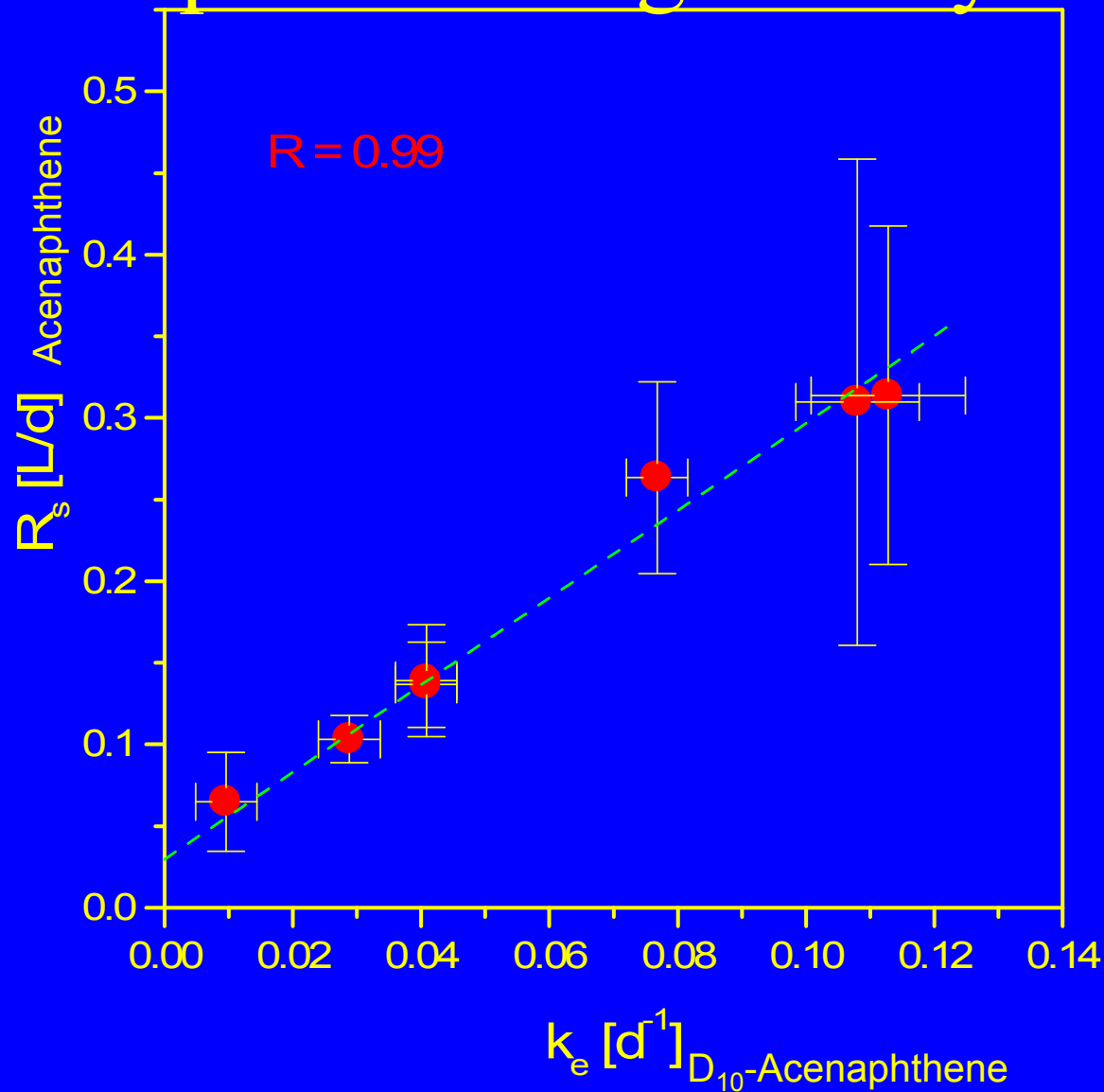

Distinguishing
between the availability and
the activity of organic
chemicals

Presence	Availability	Activity
Total mass	Fraction of total mass	Measure that drives diffusion and partitioning
How much is there?	How much is available for ... ?	How high is the diffusive pressure into other media?
Exhaustive Extraction	Depletive Extraction/ Sampling	Equilibrium Sampling Devices

The presence of contaminants do not determine risk

Presence:

- What is the total concentration in the soil?
 - How much enters the ground water?
 - Is the total concentration below a level of x mg/kg?
-
- Concentrations of PAHs in asphalt are very high, but these PAHs are generally not available
 - Concentrations of phthalates in plastic can be in the % range, but they are normally not available

General view on (bio)availability

- **only a fraction is available**
- **the remaining fraction is strongly bound**
 - **binding reduces risk**
 - **strongly bound pollution is difficult to remove**

How to measure (bio)availability?

many methods and concepts!

- 1) Determine contaminant uptake or effects**
- 2) Mild solvent extractions and supercritical fluid extractions**
- 3) Depletive sampling: Sorbent particles are added for the continuous trapping of available molecules**

Mixing of sorbent particles into soil to trap available molecules

e.g. Cornelissen et al. 2001

- **Mix sorbent particles into soil**
- **Available molecules are constantly trapped by the sorbent particles**
- **Separate sorbent from soil and measure what is bound to sorbent**

This method measures the quantity that can become available within a given period of time

- Availability **can** describe the amount that can be taken up by digestion
- Availability **can** describe the amount that can be degraded by micro-organism
- Availability **can** describe the amount that can be washed out
- Availability **can not** describe diffusion and partitioning processes

Activity (a) drives diffusion and partitioning: HIGH ∇ low

Activity is proportional to $C_{\text{freely dissolved}}$ and to fugacity (f)

Thermodynamic equilibrium:

$$a_{\text{sediment}} = a_{\text{interstitial water}} = a_{\text{worm}}$$

Equilibrium Sampling Devices

(Mayer et al., 2003)

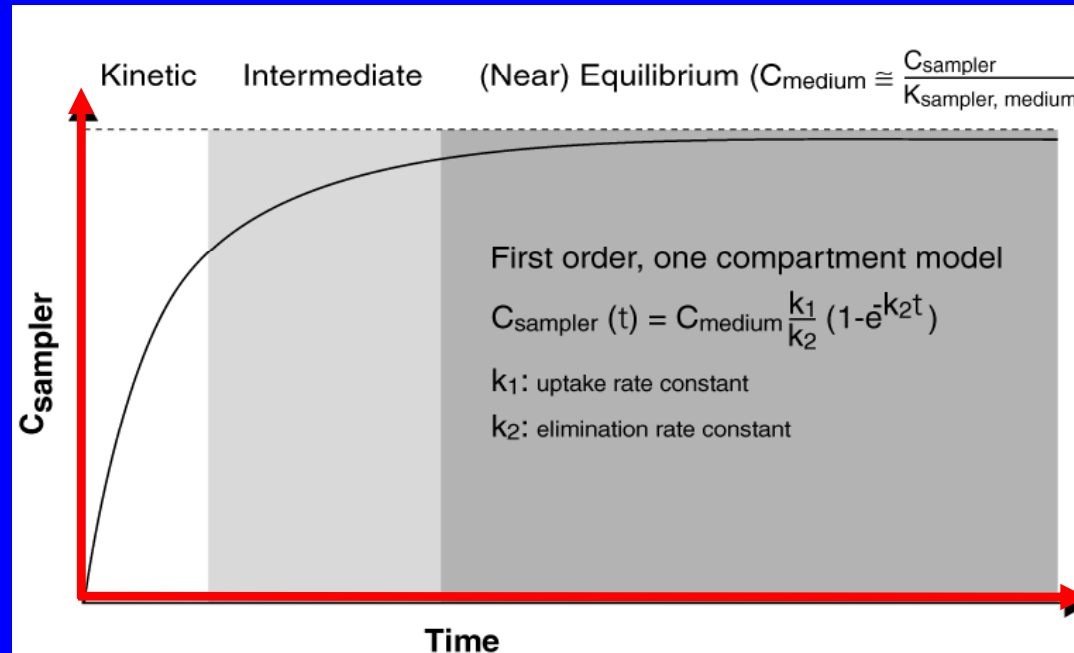

1. Bring (passive) sampler into equilibrium with surrounding medium ($a_{\text{sampler}} = a_{\text{medium}}$)
2. Measure concentration in sampler
3. Apply conversion factor to determine **activity**, fugacity or dissolved concentration

Measuring activity with Equilibrium sampling devices

	Thermometer	ESD
Equilibrium Sampling	Stable temperature indication after known response time	Stable concentrations in ESD after a known response time
Negligible impact by sampler	Heat capacity of thermometer is kept below that of the sample to avoid temperature change.	Sorption capacity of ESD is kept below that of sample in order to avoid depletion.
Response time	Thermometer needs to respond faster than fluctuations to be measured.	Response time of sampling device needs to be shorter than the fluctuations to be measured

ESD in sediment, soil and sludge: matrix-SPME

(Mayer et al. *ES&T*, 2000, V34: 5177-5183)

★ polymer coated fiber is equilibrated with sediment $\approx 1\mu\text{L}$ PDMS in 10 ml sediment

★ C_{PDMS} is measured by gas chromatography

Desorption at 275°C and trapping at 50°C

★ $C_{\text{dissolved}} = C_{\text{polymer}} / K_{\text{polymer,w}}$

$$f = \frac{C_{\text{polymer}}}{Z_{\text{polymer}}}$$

$$a = \frac{C_{\text{polymer}}}{S_{\text{polymer}}}$$

Equilibrium Sampling in sediment and soil (suspensions)



Injection and Measurement on GC

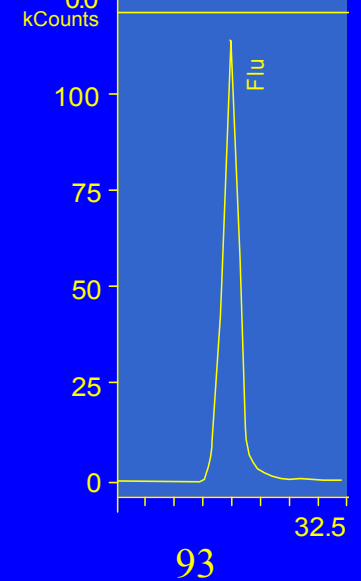
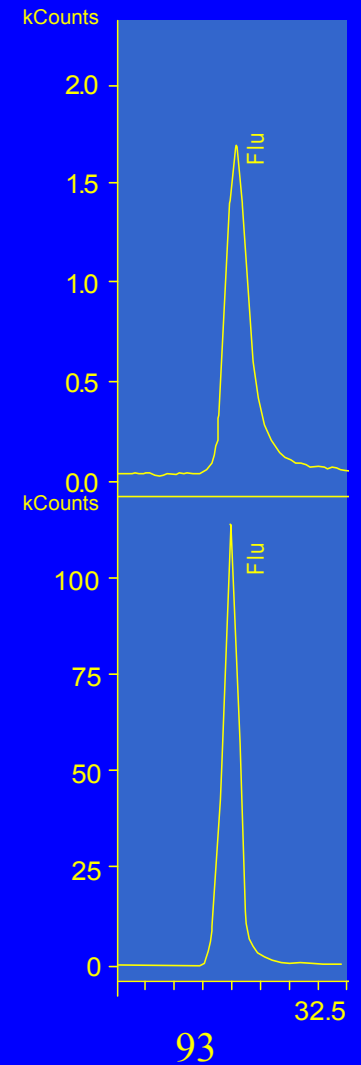
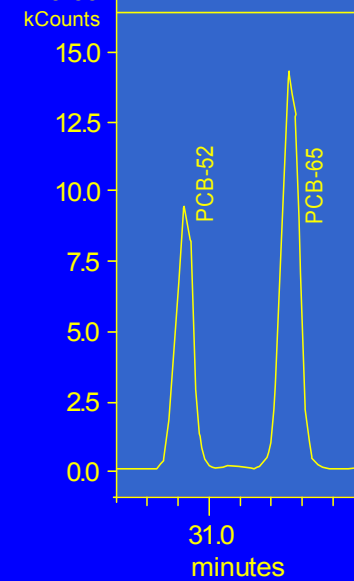
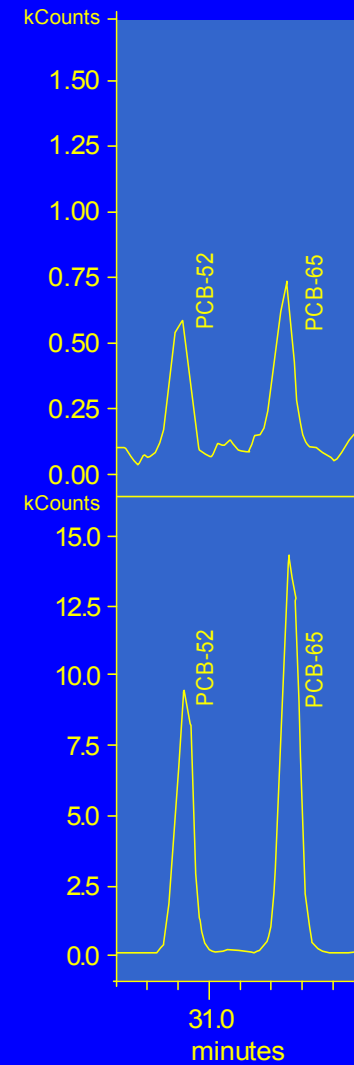
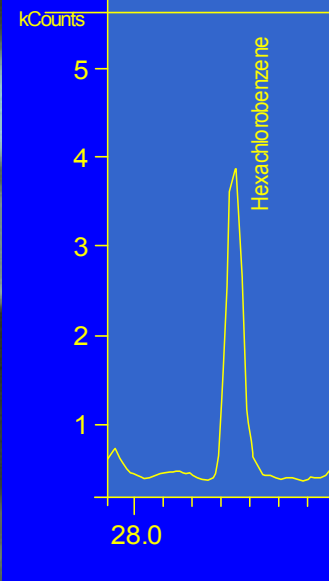
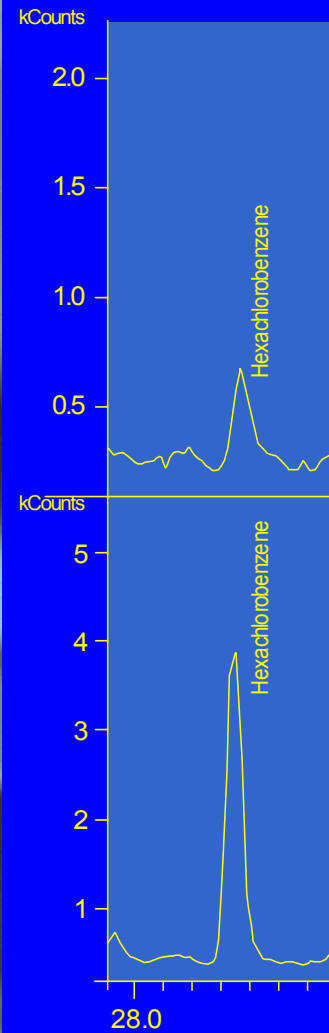
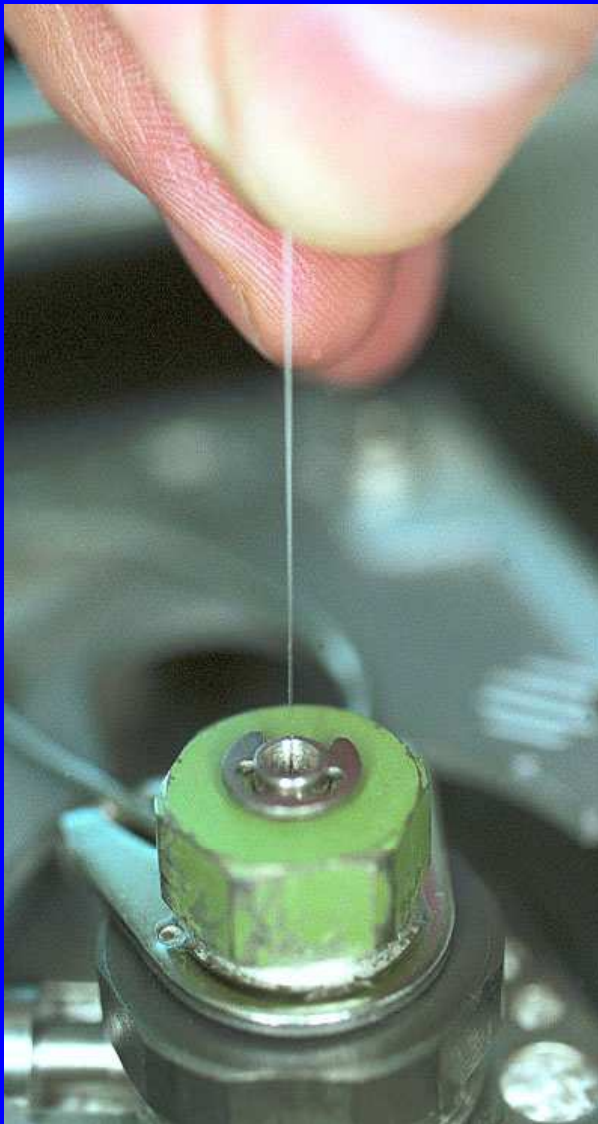

Activity in sediment

(Kraaij et al, ES&T, 2003, V37: 268-274)

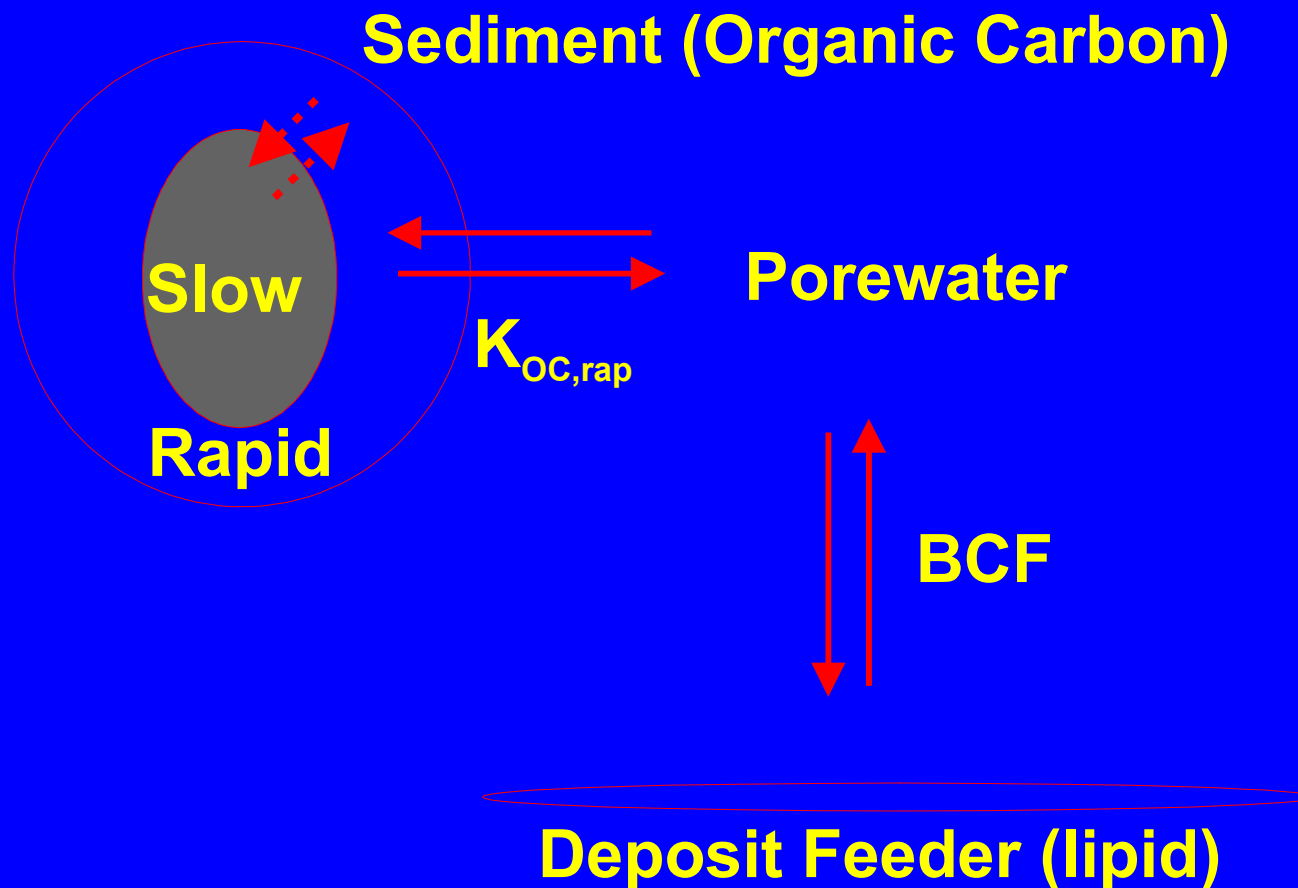

Effective concentration for biological uptake

(Kraaij et al, ES&T, 2003, V37: 268-274)

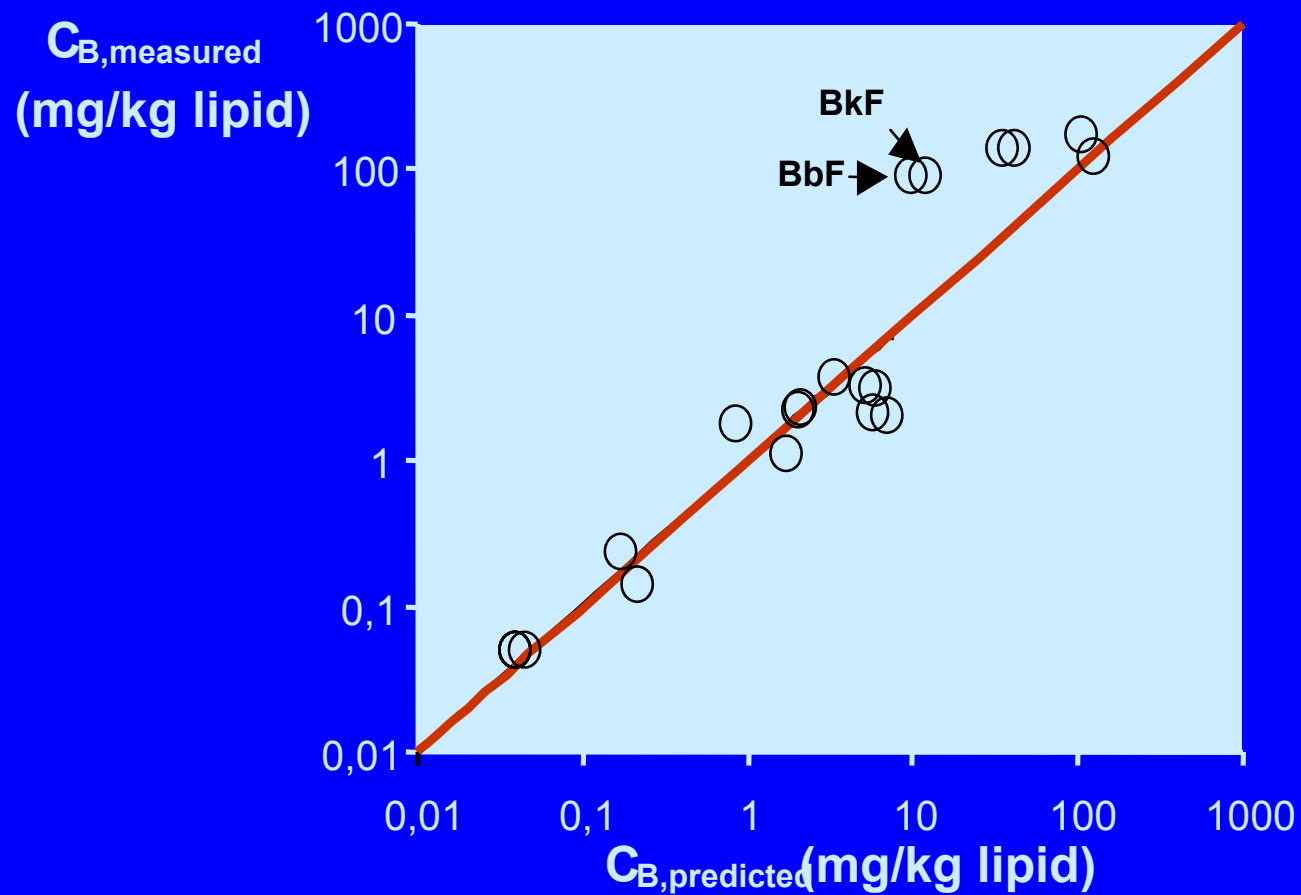

- Activity differences indicate the **direction** of diffusion between for instance sediment - water - air
- Activity measurements can be used to determine **exposure levels** in heterogeneous multimedia systems such as soil or sediment
- Activity **can not** describe amounts that are available for.....

Examples

Strong binding of PAHs to Soot

Danish Example: “Stuck soil”

- Soil with high soot content
- Initial degradation of PAHs
- Degradation stopped before reaching Danish threshold levels
- Likely reason: remaining PAH not available to degraders

Important questions:

- Does the remaining PAH represent any risk?
- Can it be made available for the degradation process?

PAHs in “stuck” soil (Denmark)

Presence: high

Availability: low

Activity: low

**Characterisation: low risk and
very limited possibilities for
remediation**

PCBs in aged sediment from Netherlands

Presence: medium

Availability: medium

Activity: low

**Characterisation: No acute risk,
but slow release possible.
Slow remediation possible.**

Conclusions

Pollution can be characterised based on presence, availability and activity
- all three parameters can be measured

Presence: how much is there?

Availability: amounts that might lead to risks and amounts that might be degraded

Activity: partitioning and diffusive pressure

Techniky přípravy environmentálního vzorku

Cílem je přenos analytu do jiné chemické fáze vhodné k analýze, odstranění interferentů a zakoncentrování.

Hlavní techniky:

- extrakce rozpouštědlem (Soxhlet, Soxtec, mikrovlnná a ultrazvuková extrakce, superkritická fluidní extrakce)
- extrakce a mikroextrakce na pevnou fázi (SPE, SPME)
- separace na semipermeabilní membráně
- analýza rovnovážné plynné fáze (head space)
- kolonová kapalinová chromatografie
- gelová permeační chromatografie

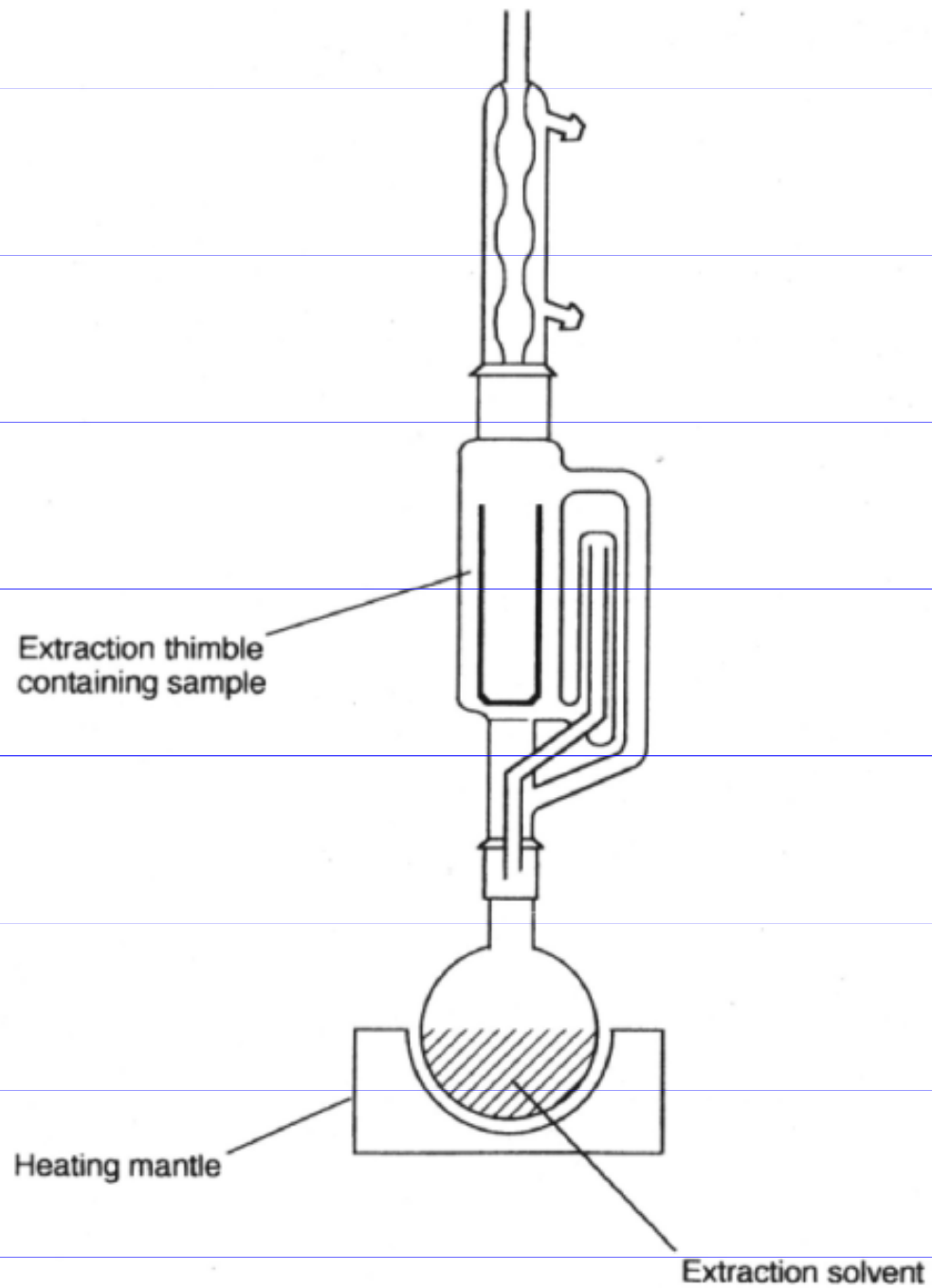

Figure 5.1 Schematic of a Soxhlet extraction system.

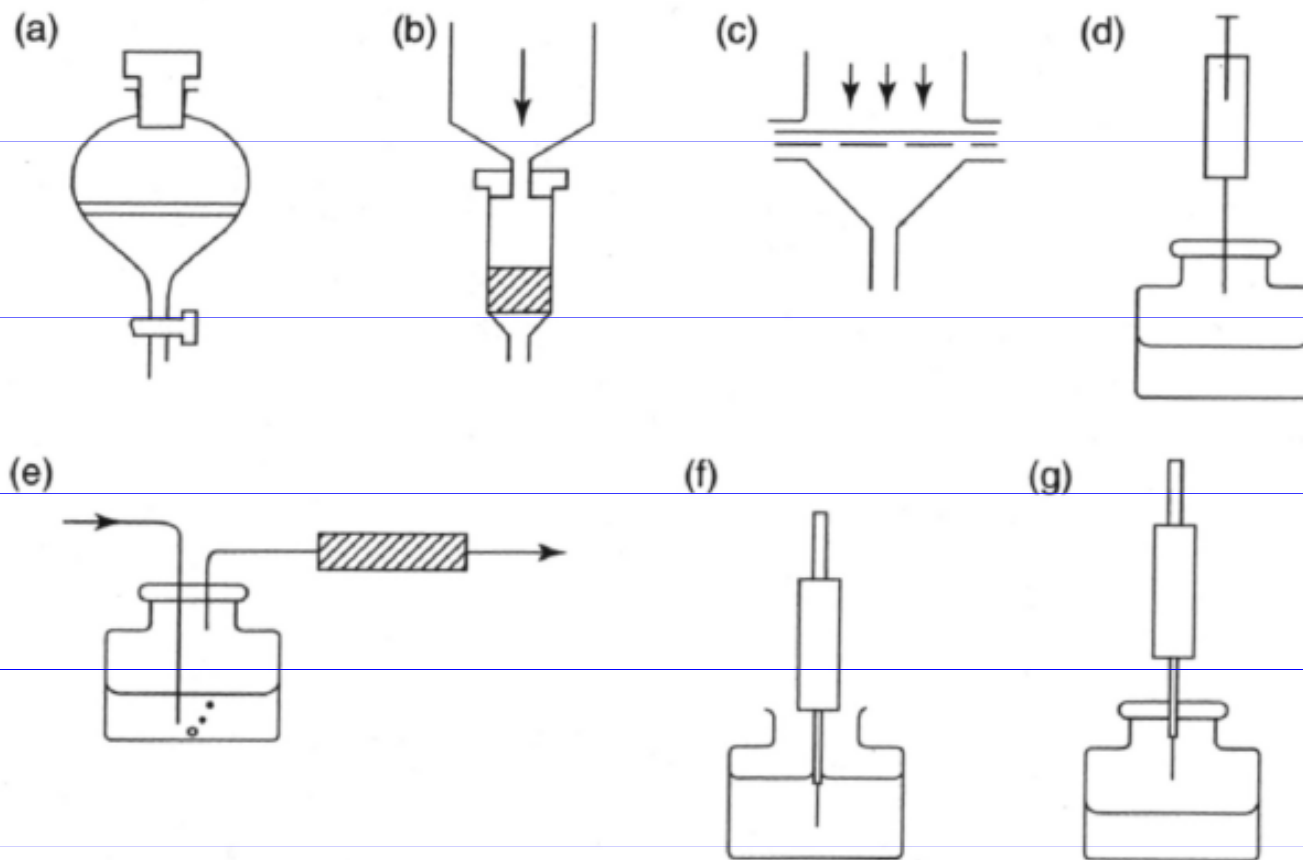

Figure 4.1 Summary of extraction methods: (a) solvent extraction; (b) solid-phase extraction – cartridge; (c) solid-phase extraction – disc; (d) head-space analysis; (e) purge and trap; (f) solid-phase microextraction – direct; (g) solid-phase microextraction – head-space.

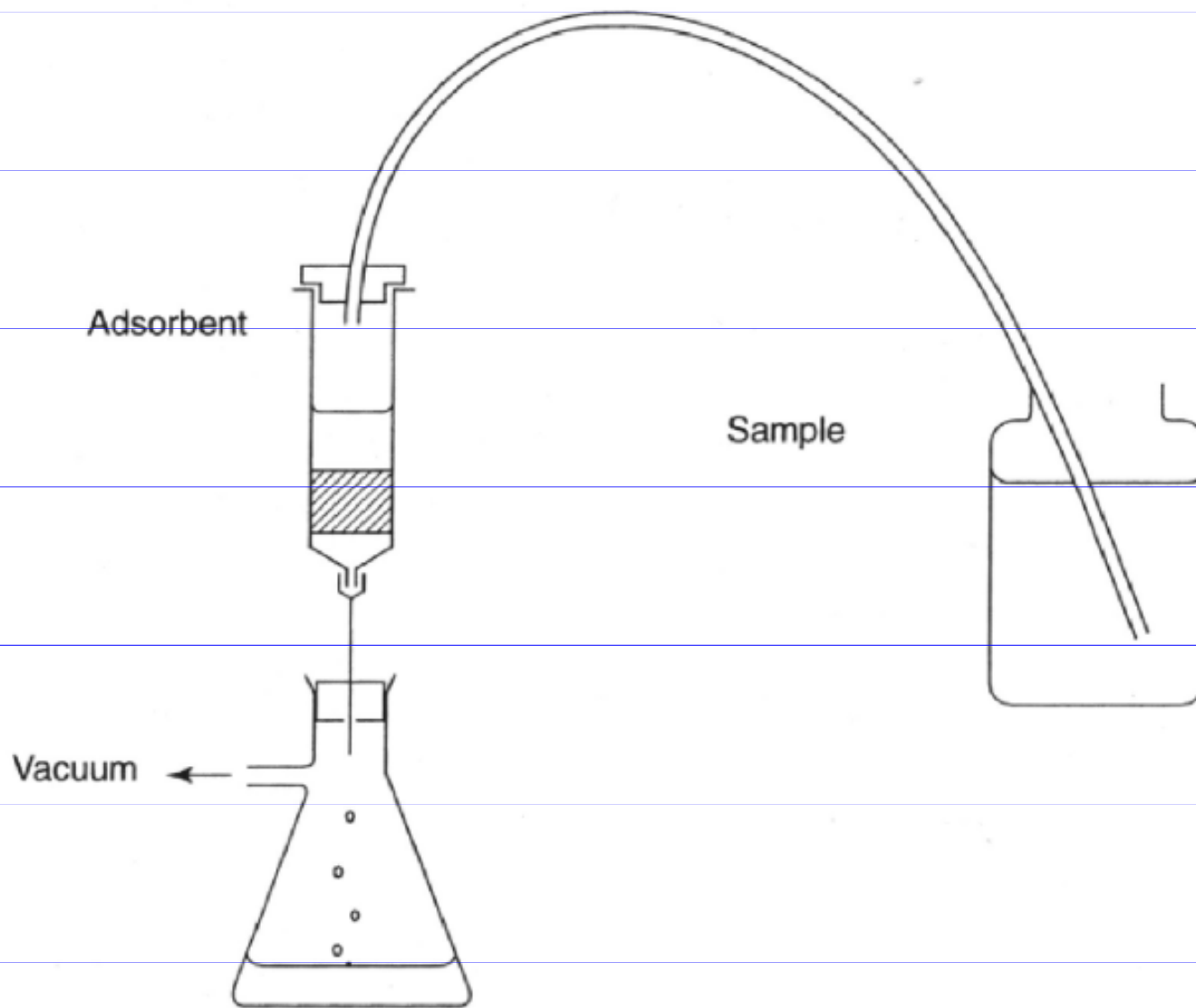

Figure 4.2 Solid-phase extraction with large sample volumes.

Outline

- **Why do we have to study particulate matter (PM)?
Toxicology versus chemical analysis.**
- **Hot pressurized water fractionation.**
- **Toxicity assays on PM fractions.**
- **Chemical characterization of PM fractions.**
- **Impacts on future work.**

What do we know about particulate matter (PM)?

Epidemiological and Inhalation Studies

- Adverse health effects of PM
- Particle size and chemical composition have impact
- Inorganics and nonpolar organics are linked to toxicity

How about polar organics??

Only nitroaromatics have been studied.

Toxicological Studies

- Organic solvent fractionation coupled with *in vitro* toxicity assays



Polar PM Fractions are Toxic

What do we know about PM?

Chemical Characterization of PM

- Inorganics well characterized
- Organics
 - **Mainly nonpolar species are identified.**
Organic solvent extraction followed by GC/MS analysis.
 - ADVANTAGE determination of hundreds of organics
 - DISADVANTAGE represents only 20%-50% of organic PM
 - **Polar organics are present in significant concentrations, but require specific analytical methods.**
They are ignored in toxicological studies.

Background

Chemical analysis



Toxicology

Polar species

Approach

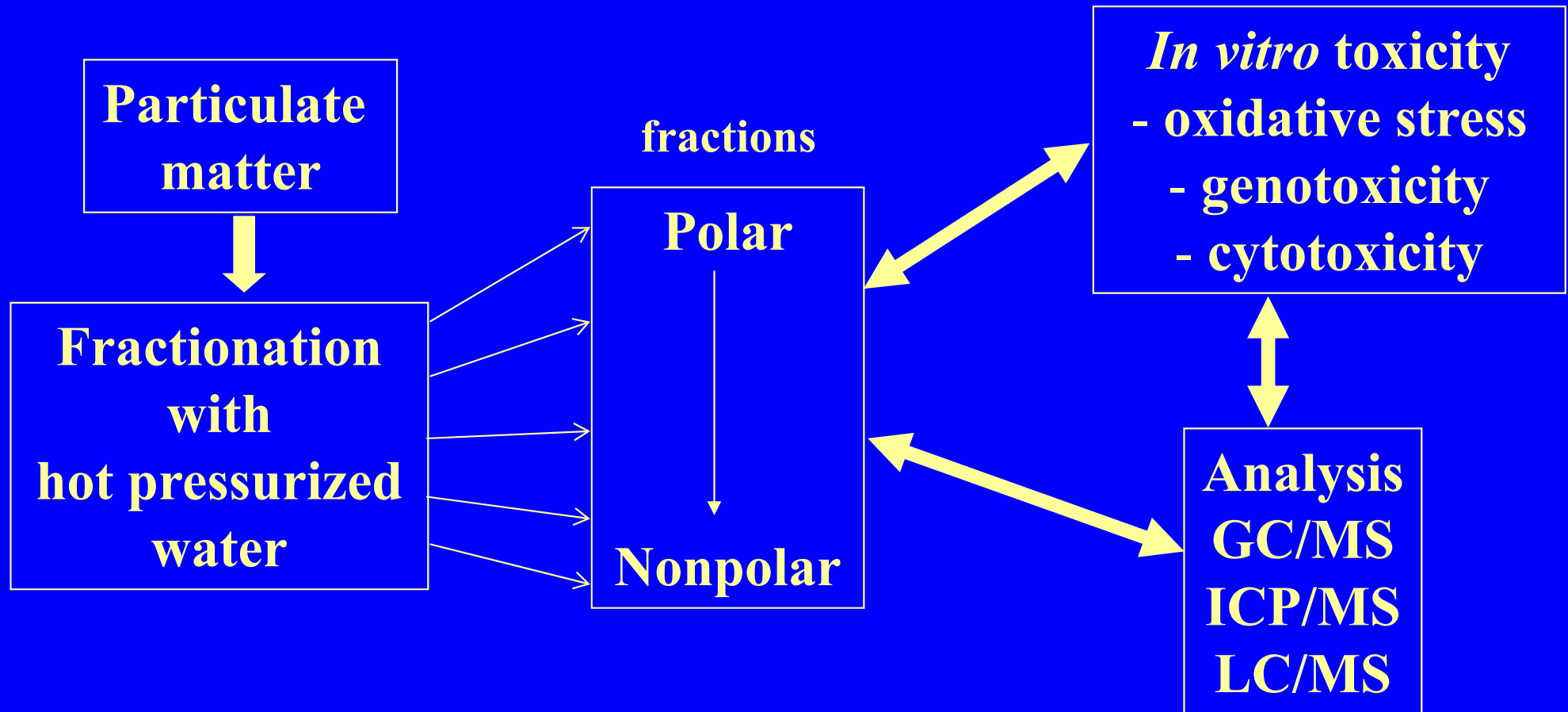

Why Hot Pressurized Water?

	25°C	300°C
dielectric constant (ϵ)	80	20
polarity	high	low
similar organic solvents	none	methanol, acetonitrile
compounds extracted	high polarity (e.g. strong organic acids)	low polarity (e.g. PCBs, PAHs)

- The polarity can be controlled with change of temperature.
- As the polarity of water is controlled, solubility is controlled.

Model PM Samples

- **Wood Smoke Particulate Matter (polar)**
 - lignin pyrolysis products
 - methoxy phenols
 - methoxy benzoic acids
 - benzaldehydes
- **Diesel Exhaust Particulate Matter (nonpolar)**
 - polycyclic aromatic hydrocarbons (PAHs)
 - unresolved complex matrix (UCM) = branched alkanes

Hot Pressurized Water Extracts of Diesel Exhaust PM



In vitro toxicity assays

- **Oxidative stress of PM** Depletion of glutathione (GSH)
Cell lines related to respiration system - Macrophages
RAW 264.7
- **Genotoxicity** Bacterial test SOS Chromotest
Based on the β -galactosidase synthesis
- **Cytotoxicity** Cell viability test (MTT assay)
Mammalian COS cells

Toxicity of Diesel Exhaust Particulate Matter

Depletion of glutathione (GSH)

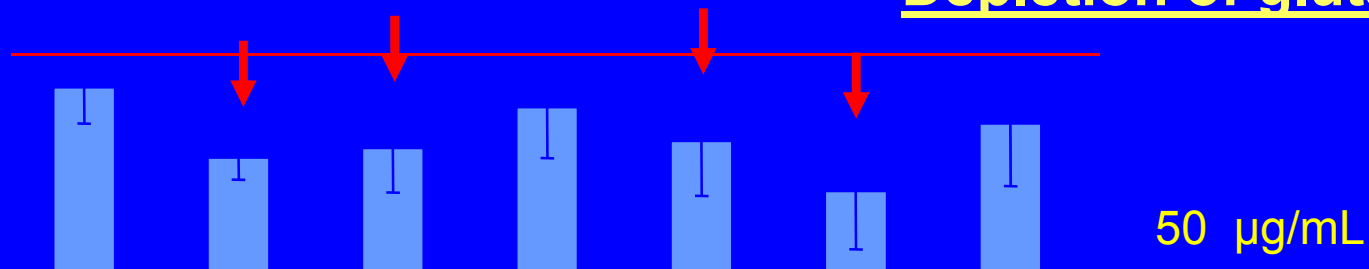

Genotoxicity

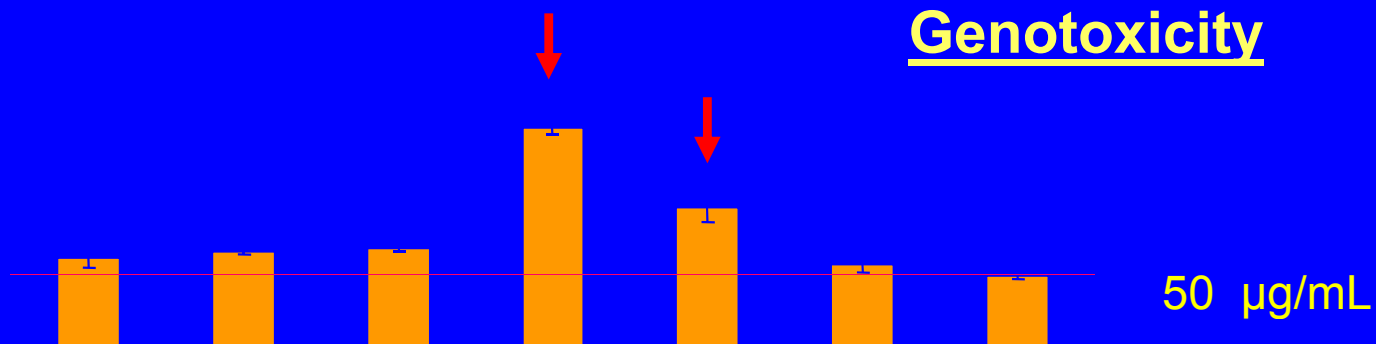

Cell viability test

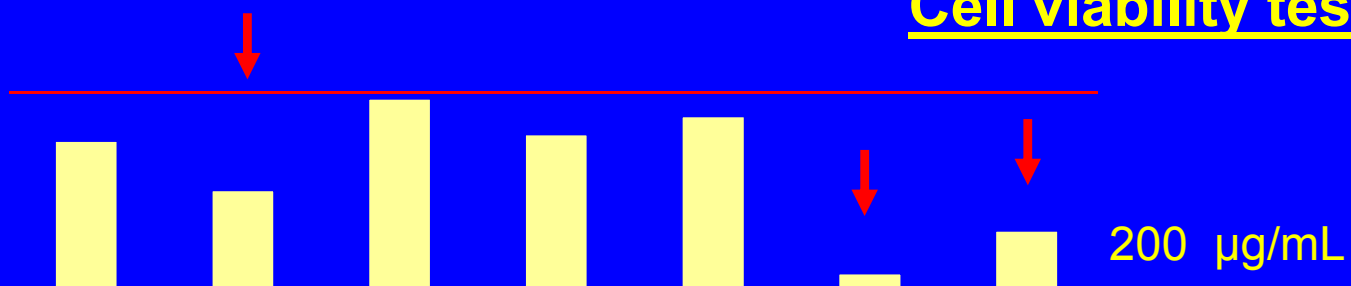

78

71

56

44

35

27

20

Dielectric constant, ϵ^{116}

Diesel Exhaust PM Toxicity versus Analysis

- **Polar 50°C Fraction** - **cytotoxic and depletes GSH**

possibly dicarboxylic acids and aldehydes

- **Midpolar Fractions (100°- 200°C)** - **genotoxic**

nitropyrene (representative of nitro polyaromatics) in 150°-200°C fractions

dinitro- or nitro-, and oxyaromatics in 100°C fraction?

- **Nonpolar fractions** - **cytotoxic and deplete GSH**

toxicity of 250°C > 300°C fractions

possibly species other than PAHs (oxy- and nitro- polyaromatics)

Toxicity of Wood Smoke Particulate Matter

Cell viability test

100 $\mu\text{g/mL}$

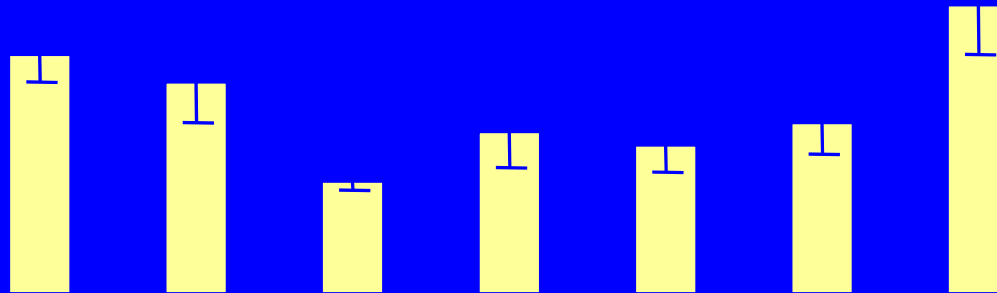

Depletion of glutathione (GSH)

50 $\mu\text{g/mL}$

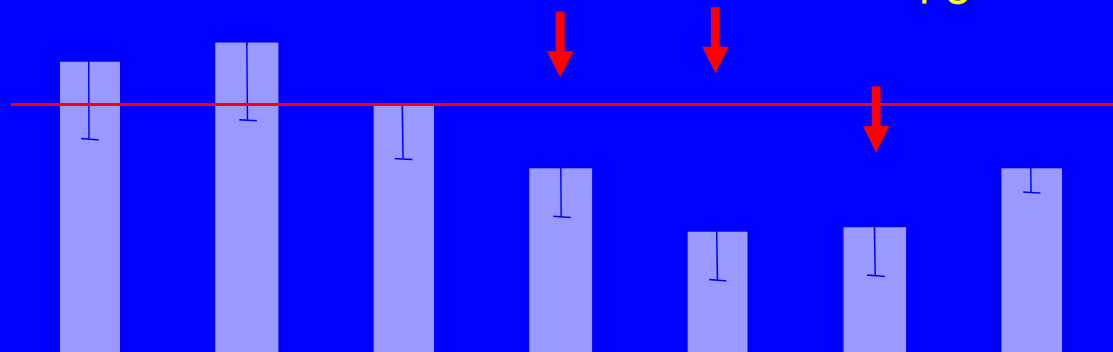

78

71

56

44

35

27

20

Dielectric constant, ϵ

Distribution of Organics in Wood Smoke Particulate Fractions Collected at Different Temperatures

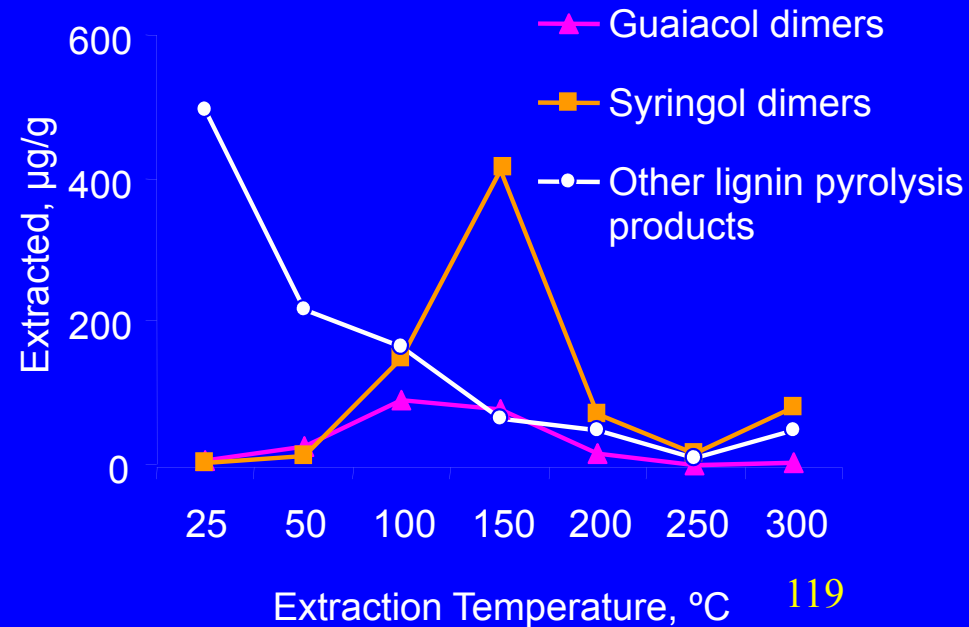
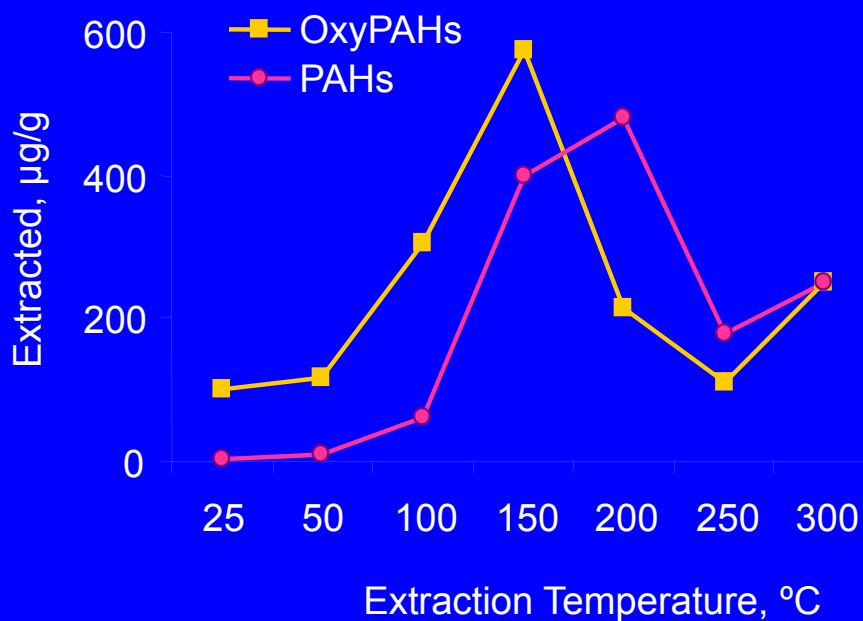
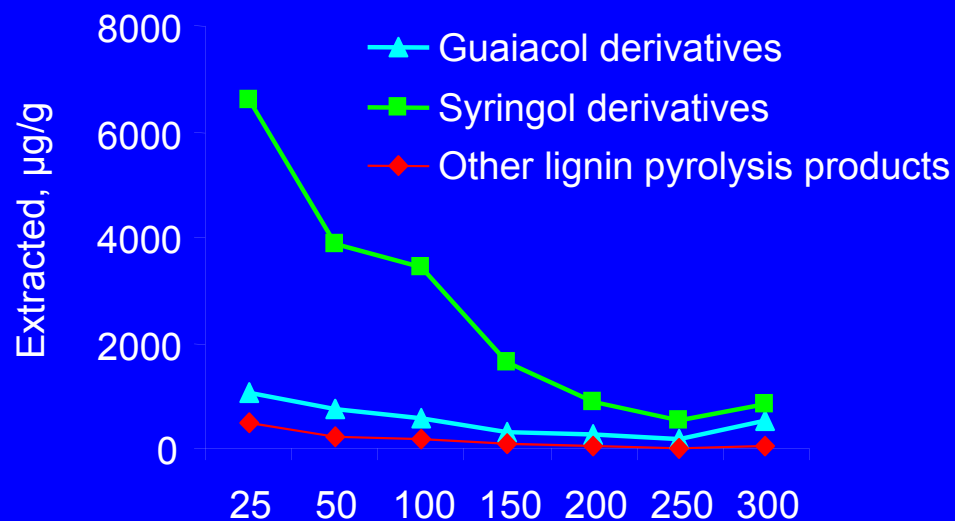
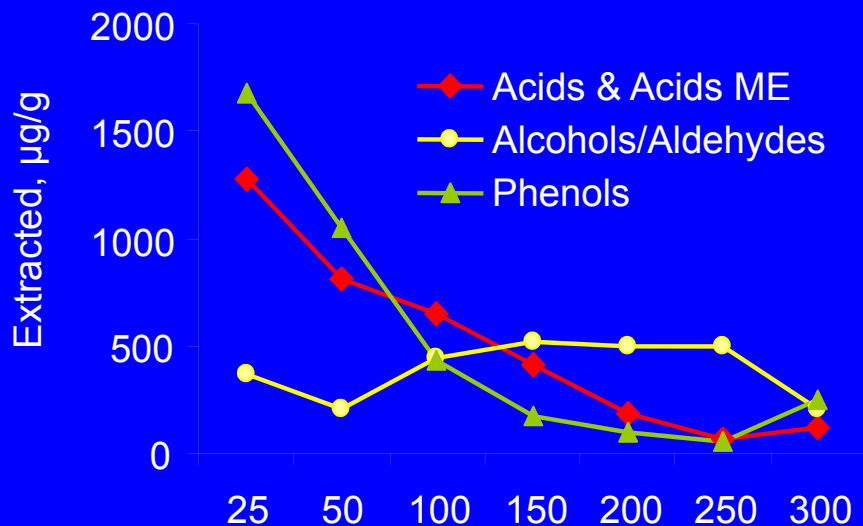

What is the Source of Oxidative Stress in Midpolar Fractions (100°-150°C)?

3-ring PAHs? OxyPAHs? Syringol dimers?

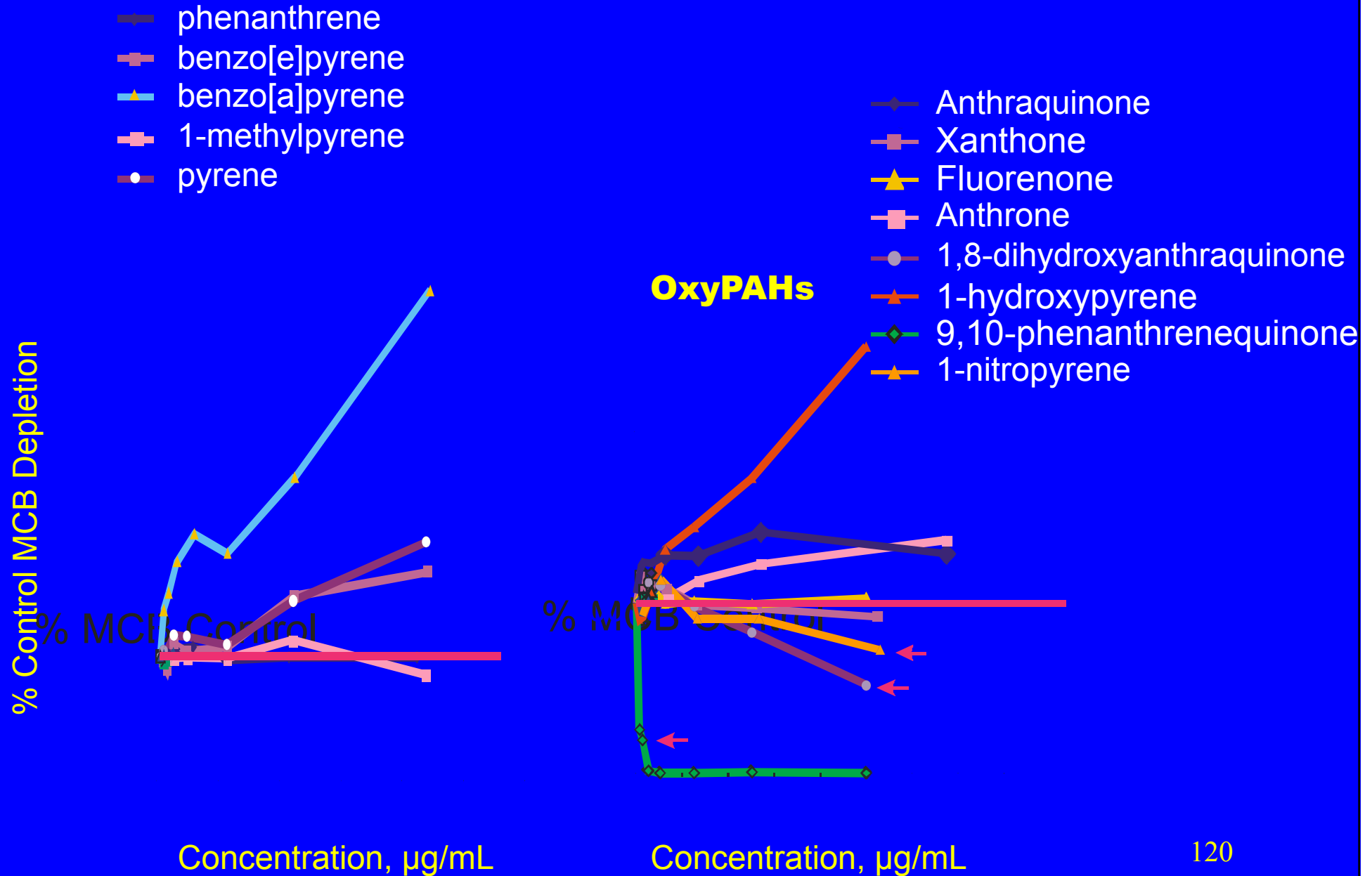

Wood Smoke PM

Toxicity versus Analysis

- **Both polar and nonpolar** fractions
 - **cytotoxic**
 - **deplete glutathione**

- **Midpolar fractions (150°-250°C) - deplete GSH (more)**
oxyPAHs, PAHs, syringol dimers?

- **No genotoxicity** - **before and after metabolic activation**

Conclusions

- Hot pressurized water can **selectively** extract organics.
- Significant **toxicity** was found **in the polar fractions** which are omitted by typical characterization of particulate matter.
- Hot pressurized water **can replace** polar and nonpolar **organic solvents**.
- Water is **suitable for toxicological tests**.

Hot Pressurized Water Extraction Apparatus



Polarity of Hot Pressurized Water Decreases with Temperature

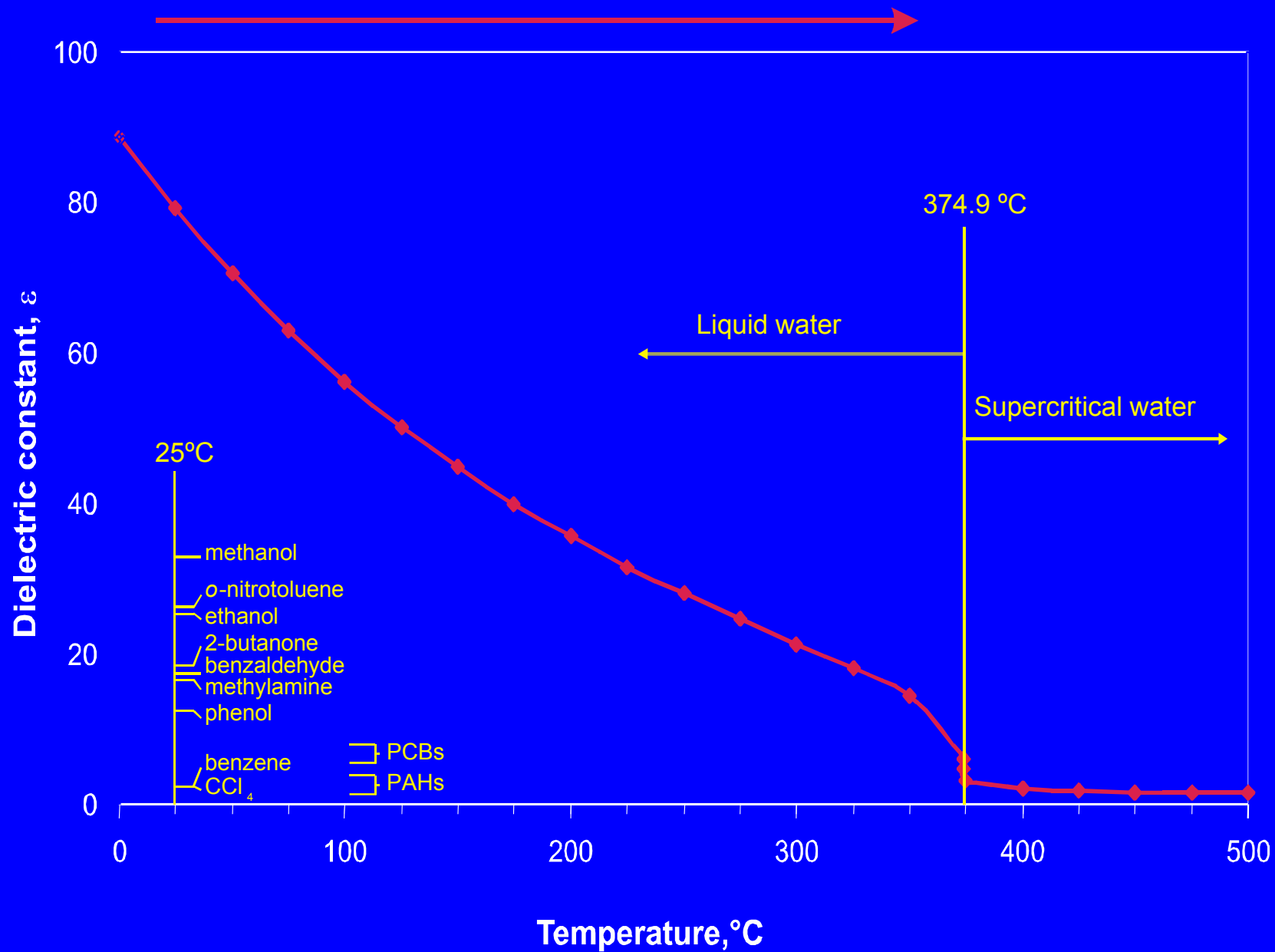

Majority of Extracted Mass from Wood Smoke Particulate Are Organics

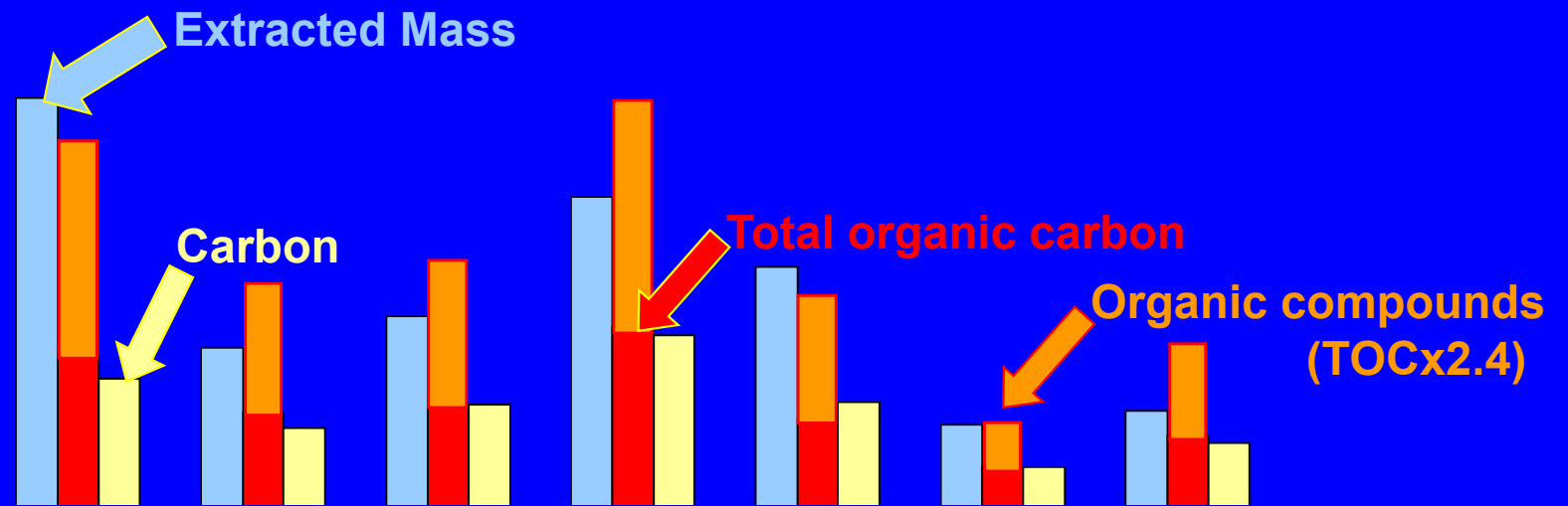

Inorganics are Present in Polar Fraction of Diesel Exhaust Particulate

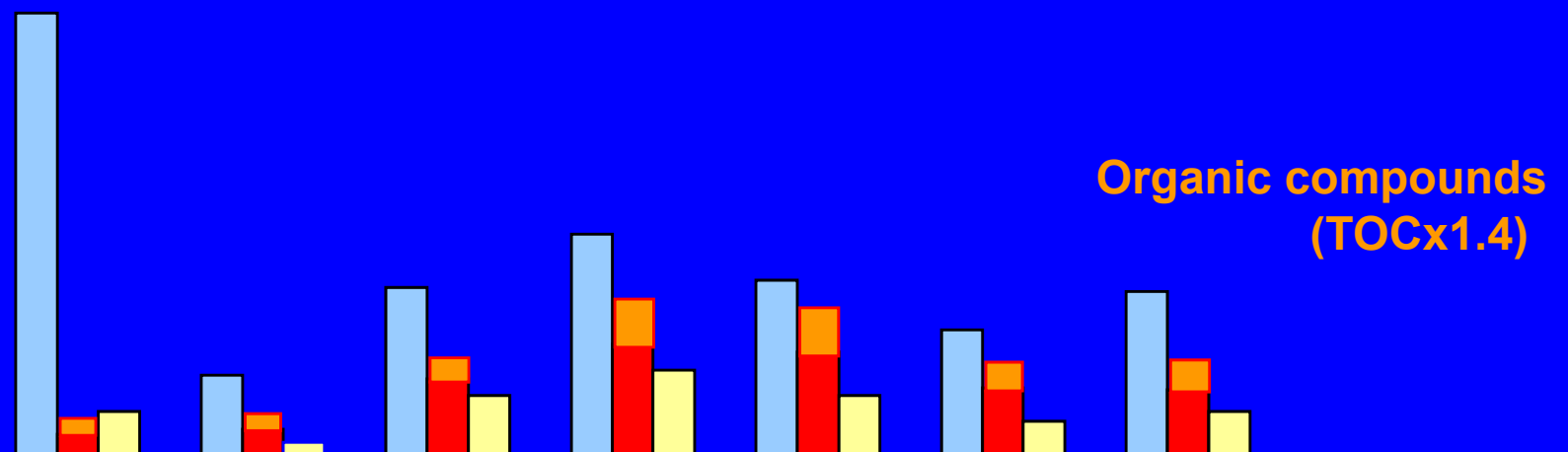

Approach:

*Evaluate the abilities of water desorption and mild **supercritical carbon dioxide extraction** (SFE) to predict bioavailability of PAHs from abandoned manufactured gas plant soils, soots, and sediments.*

PAHs are regulated on based on their total concentrations, but earthworm toxicity and soil PAH concentrations are not necessarily related.

Soil Sample	Earthworm Mortality	Total PAH Concentration mg/Kg
CG-12	100% alive	3800
CG-3	100% dead	4100

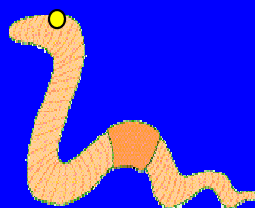

What is SFE (Supercritical Fluid Extraction)?

- High pressure CO₂ is pumped through a sample, and extracted organics are collected in a suitable solvent for GC analysis.
- Typical SFE conditions:
 - 100 to 400 bar (density of ca. 0.4 to 0.9 g/mL)
 - 40 to 150 °C
 - 1 mL/min with a 1 to 10-gram sample

Why use supercritical carbon dioxide?

- 1. CO₂ is a lipophilic solvent much like biological lipids in polarity*
- 2. PAH solubilities in CO₂ are proportional to those in water, but ca. 10⁴ higher.*

How do we evaluate “Environmentally-Relevant” extractions?

>> Compare “selective” SFE extraction methods to:

- * Bacterial bioremediation at one field site*
- * Earthworm uptake and/or toxicity (Cornell)*
- * Long-term water desorption (U. of Texas, Austin)*

>> Seven oil gas and seven coal gas sites.

Test Case #1: Bioremediation of PAHs on an MGP Soil

Site: Soccer-sized field, ca. 50 cm deep

*Treatment: Bioremediation with tillage and
nutrients for one year.*

*PAHs: 2 to 6 ring (MW from 128 to 278),
7000 mg/kg*

*Approach: Compare selective SFE behavior to
remediation progress.*

SFE rates (single condition) mimic bioremediation (1 min SFE=10 days bioremediation)

Bioremediation (1 year
min.)

SFE (40
min.)

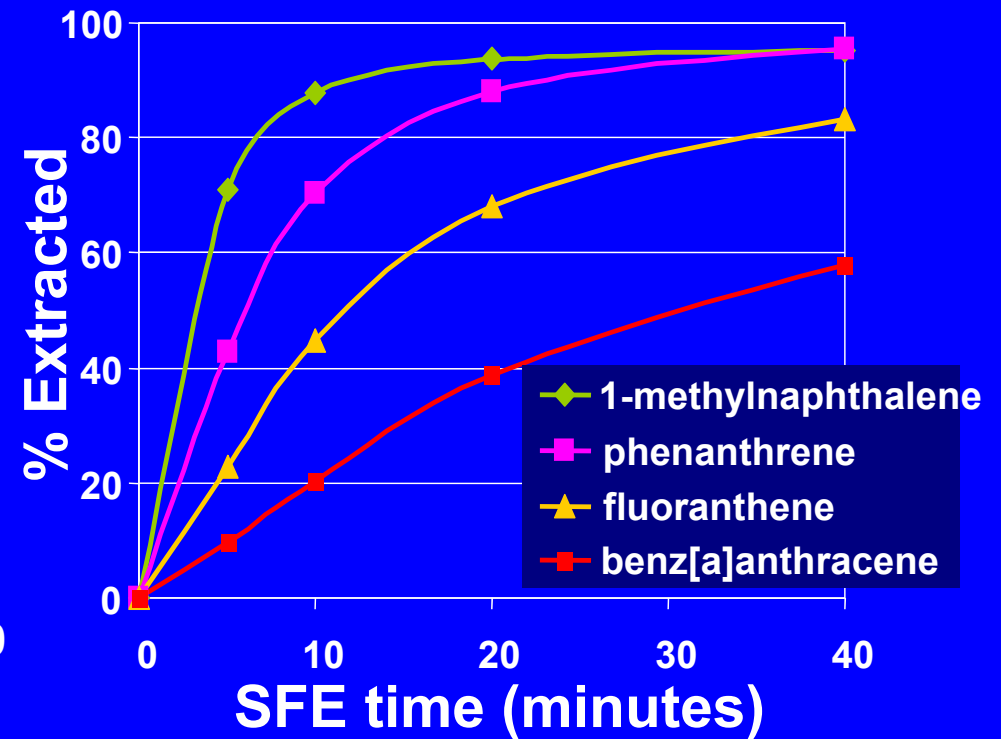
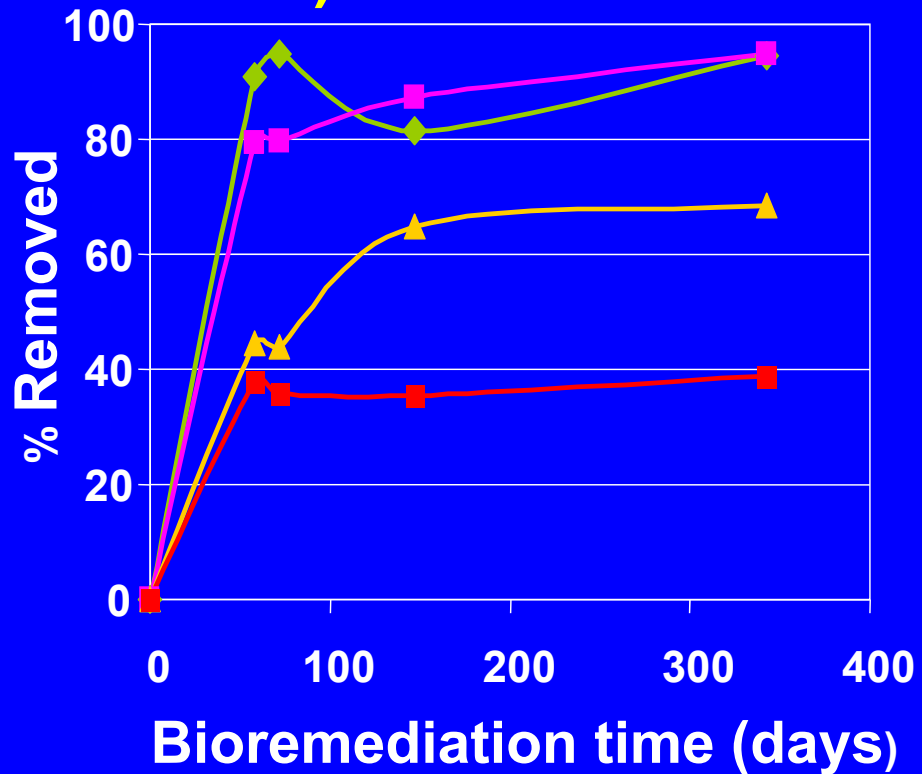

Samples provided by GTI and MidAmerican Energy

SFE rates (single condition) mimic bioremediation (1 min SFE=10 days bioremediation)

Bioremediation (1 year)

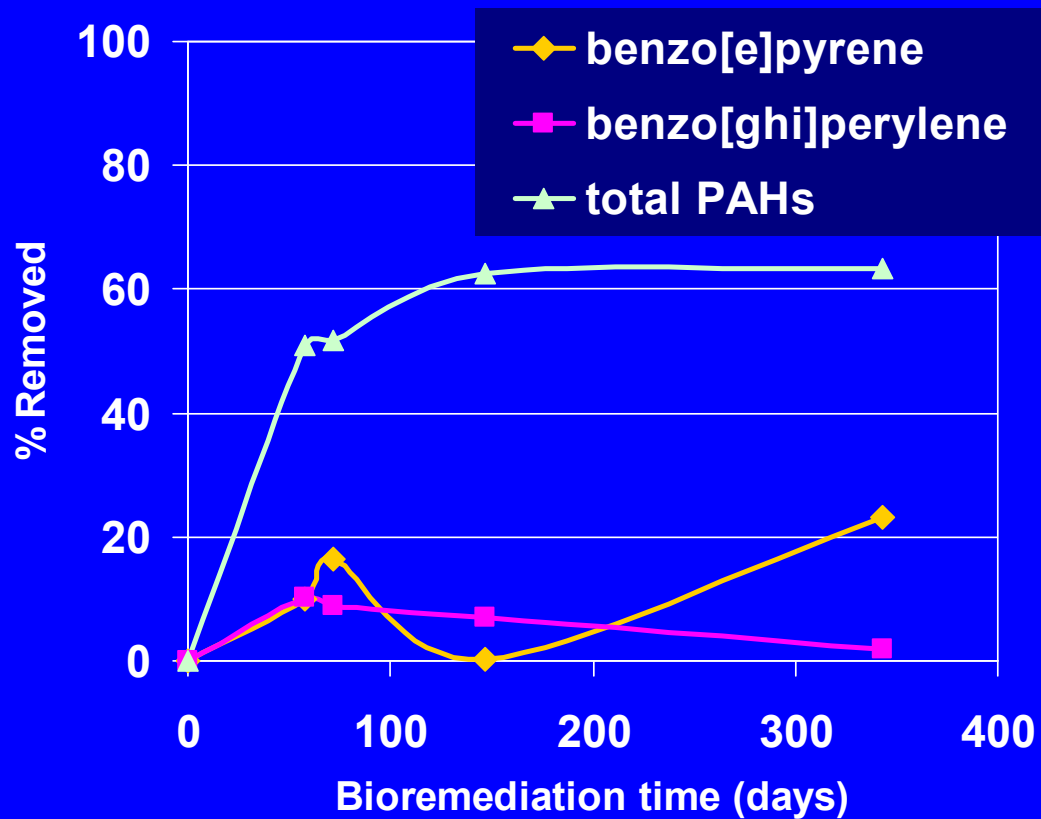

SFE (40 min)

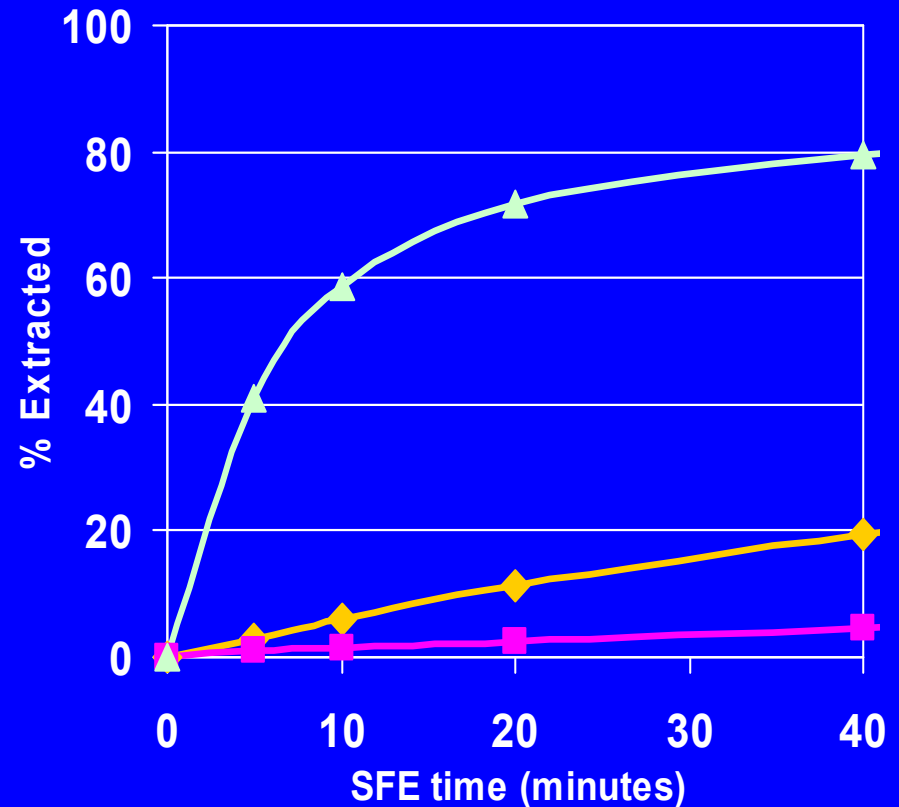

SFE conditions were developed on samples from the field bioremediation studies described earlier.

These “magic” conditions were tested with 7 oil gas and 7 coal gas sites by comparing SFE (120 minutes) and water desorption (120 days) rates.

1 Samples Used Are from “Real” Sites Typically Abandoned 50 Years Ago

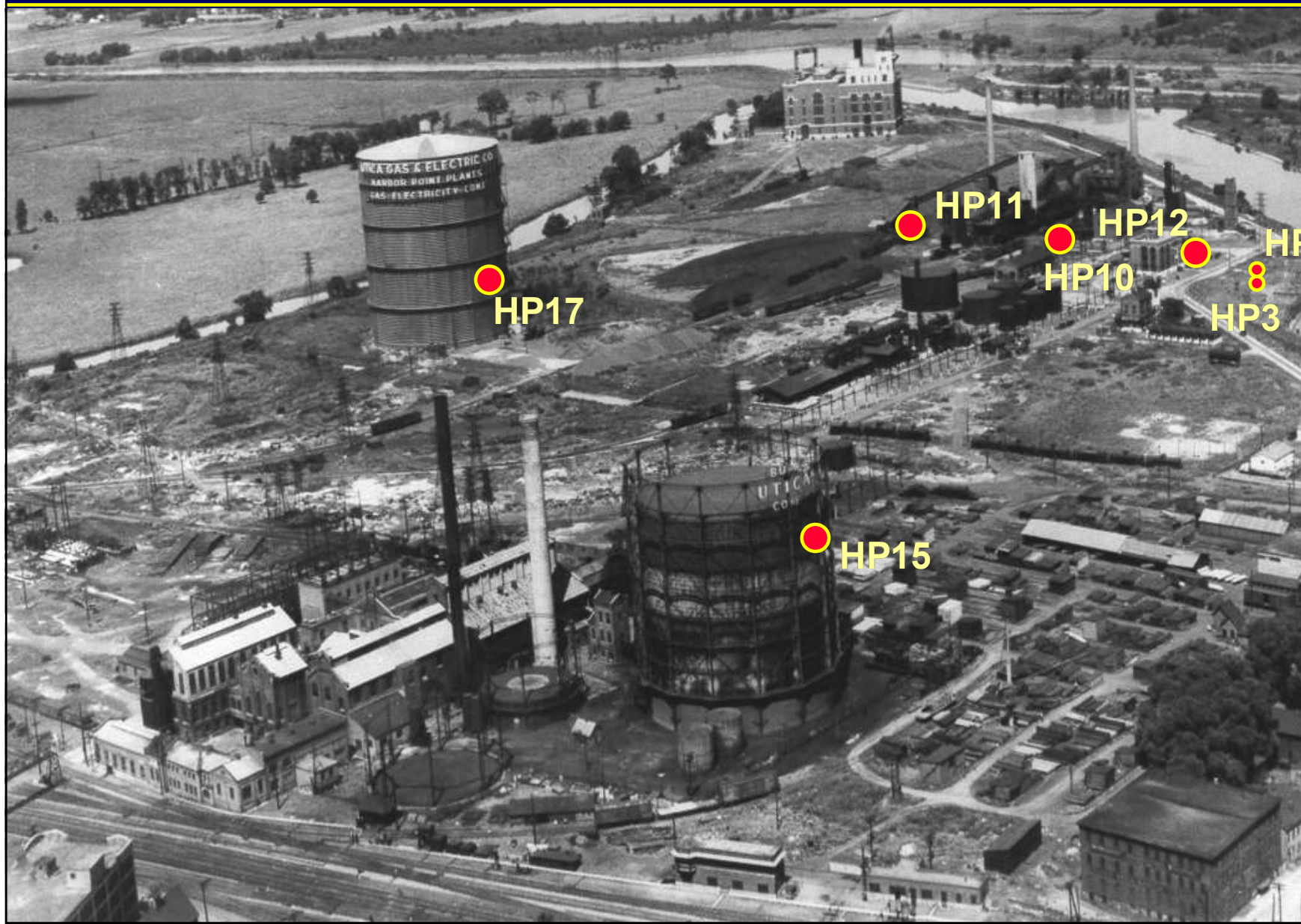

Oil gas samples are pure soot, or soot diluted with soil.

Total EPA PAHs: 150 to 40000 mg/kg

Carbon contents from 3 to 87 wt.%

HIGHLY aromatic (poly “chicken wire”)--very high C/H ratio and “fixed” carbon.

Coal gas samples are coal tars mixed with soil.

Total EPA PAHs: 300 to 15000 mg/kg

Carbon contents from 3 to 29 wt.%

Carbon type more similar to normal soils (lower C/H ratio, and “fixed” carbon.

Minutes of SFE Desorption Mimic Days of Water Desorption

Supercritical CO₂

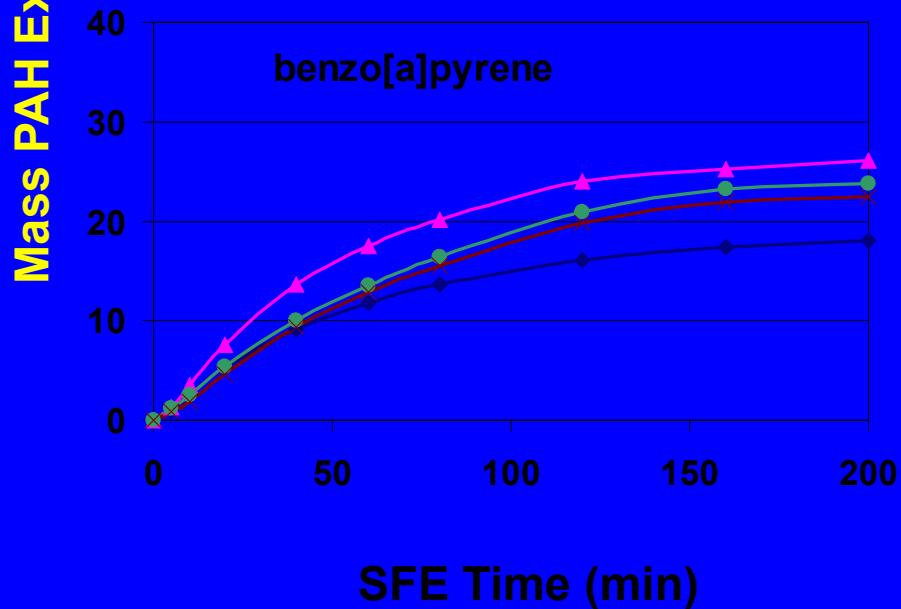
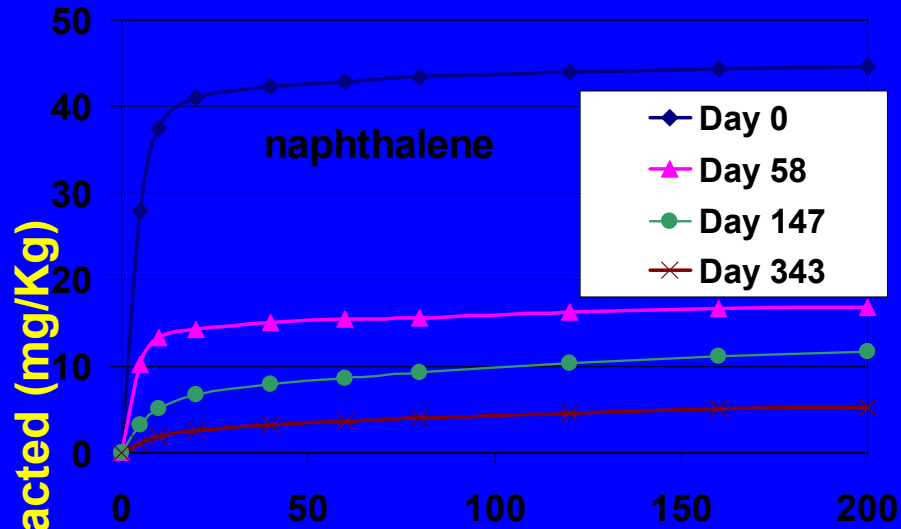

Water Desorption

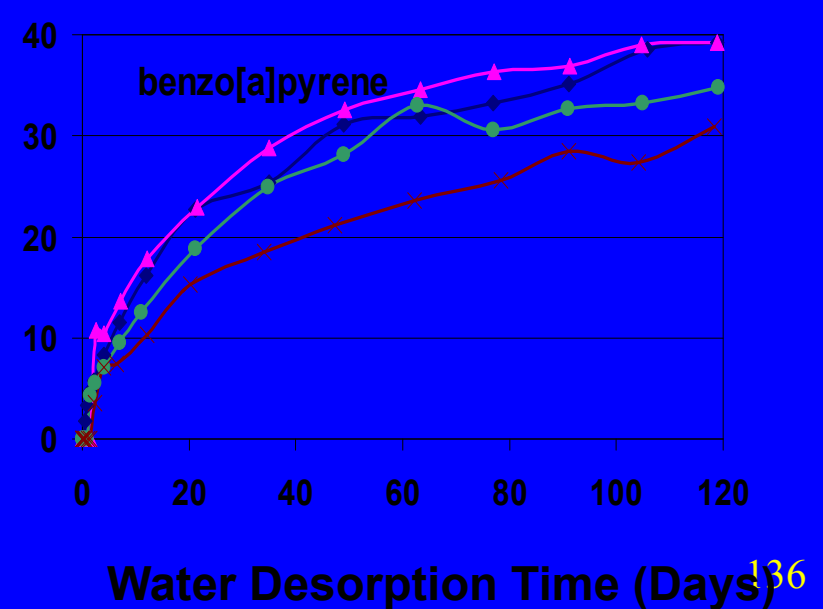
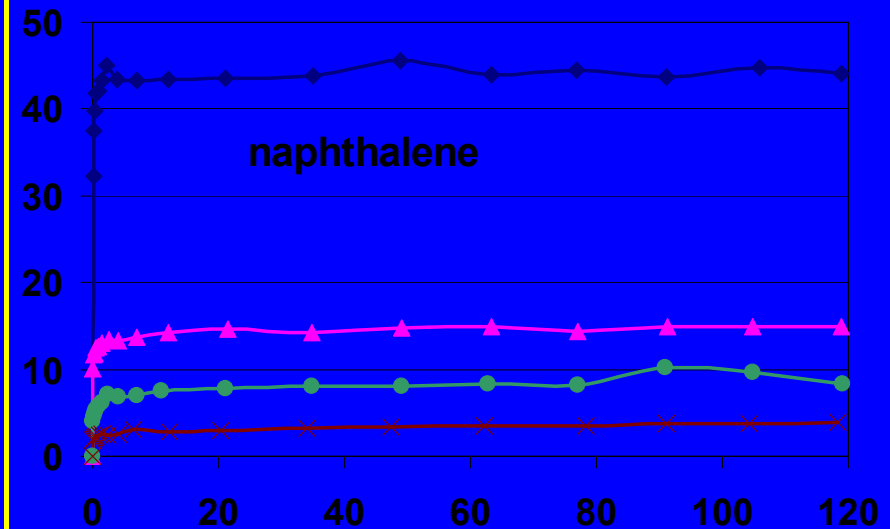

Earthworm Mortality Depends on Available PAHs (measured by SFE), Not on Total PAH Concentrations

Soil	Total PAH (ug/g soil)	Available Fraction (SFE)	Available Total PAH (ug/g C)	% Mortality
CG15	1020	0.25	1040	0
OG14	168	0.46	2720	0
CG11	15600	0.06	3280	0
CG12	3790	0.16	7880	0
OG17	17200	0.27	9720	0
OG5	1870	0.41	11100	0
OG10	42100	0.33	16300	0
CG3	4100	0.83	45700	100
OG18	17300	0.74	50100	100

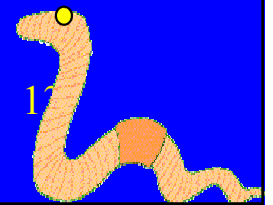

Conclusions

- SFE mimicked bioremediation for a one-year field treatment
 - 1 min. SFE = ca. 10 days bioremediation
- SFE “mobile PAHs” correlate with water desorption for 15 oil and coal gas sites (1 min. SFE = ca. 1 day water desorption)
- Chemical measures of PAH availability improve predictions of bioavailability to worms
- Mortality was related to “available” PAHs, not “total” PAHs

**Nejčastější techniky stanovení organických látek
v environmentálních vzorcích jsou chromatografické:**

- GC**
- HPLC**
- HRGC**
- GC-MS, LC-MS**

Chromatografie

je fyzikální metoda separace, při které jsou separované sloučeniny distribuovány mezi dvěma fázemi, z nichž jedna je stacionární a druhá mobilní.

Chromatografický proces probíhá díky opakované sorpci a desorpci sloučenin ve vzorku během kontaktu se stacionární fází.

Separace sloučenin je způsobena rozdílností distribučních konstant jednotlivých sloučenin v daném separačním systému.

Výsledkem tohoto procesu je rozdílná migrace chromatografovaných sloučenin.

Klasifikace chromatografických technik podle:

- skupenství mobilní fáze (GC, LC)
- tvaru chromatografického lože (plošné, kolonové)
- polarity chromatografického systému (normální, reverzní)
- změny experimentálních podmínek (izokratické, gradient)
- separačního děje (adsorpční, rozdělovací, iontoměničová, gelová, afinitní)
- použití (analytická, preparativní)

Plynová chromatografie

- mobilní fází je plyn (inertní a dostatečně čistý, např. He)
- stacionární fází je adsorbent s velkým povrchem nebo kapalina zakotvená na povrchu inertního nosiče
- chromatografický děj probíhá na koloně
(kolony náplňové a kapilární, různého průměru)
- náplňové - modifikovaná stacionární fáze
- kapilární kolony - úprava vnitřního povrchu křemenné kapiláry, deaktivace, chemická modifikace, smočení, imobilizace, síťování

Instrumentace

- zdroj nosného plynu (tlakové láhve, filtry)
- pneumatický systém (regulátory tlaku a průtoku)
- injektor (split, splitless, vyhřívání)
- termostat kolony (gradientové programování teploty)
- detektory - univerzální a selektivní
 - destruktivní a nedestruktivní
 - koncentrační a hmotové

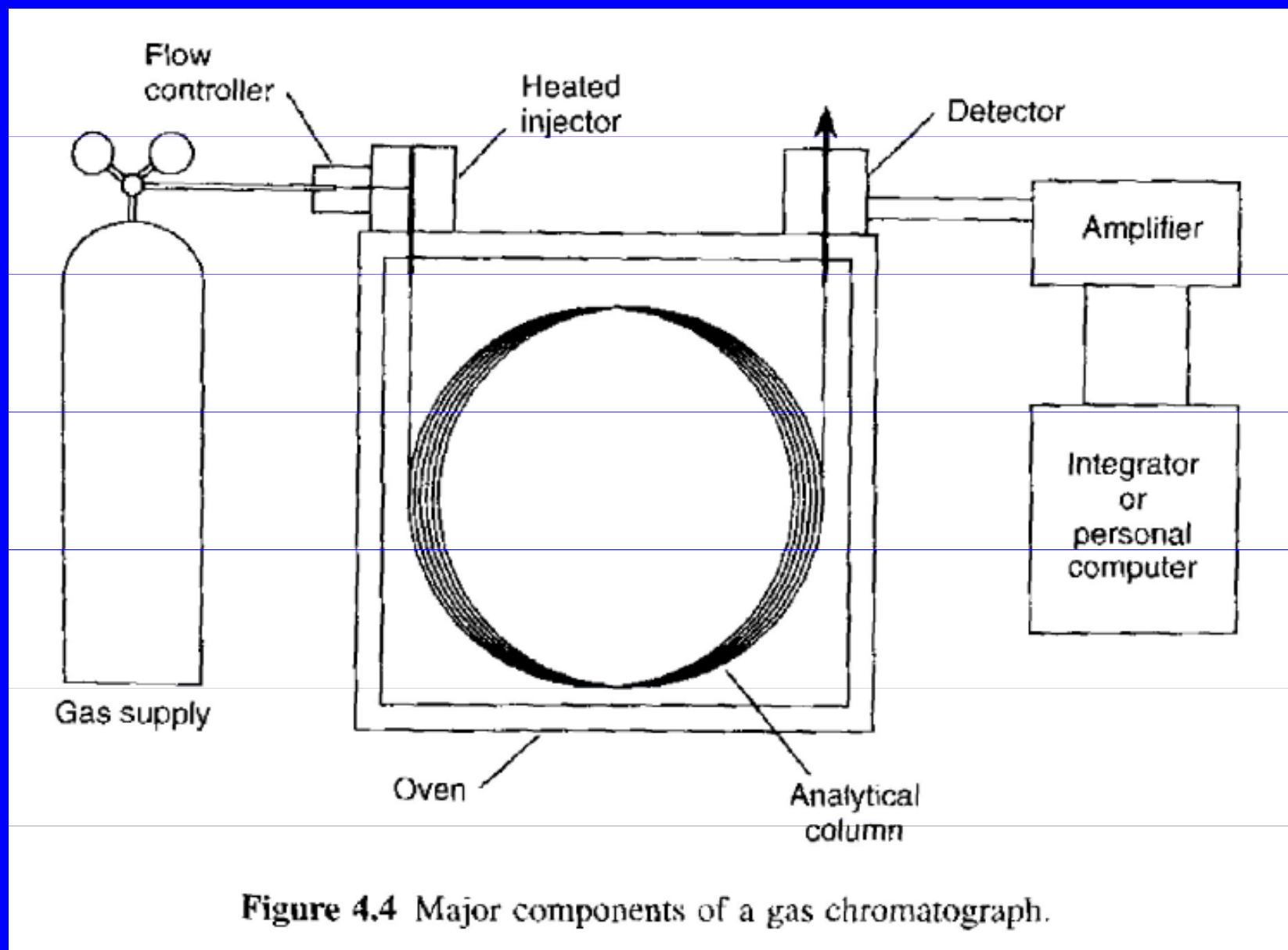
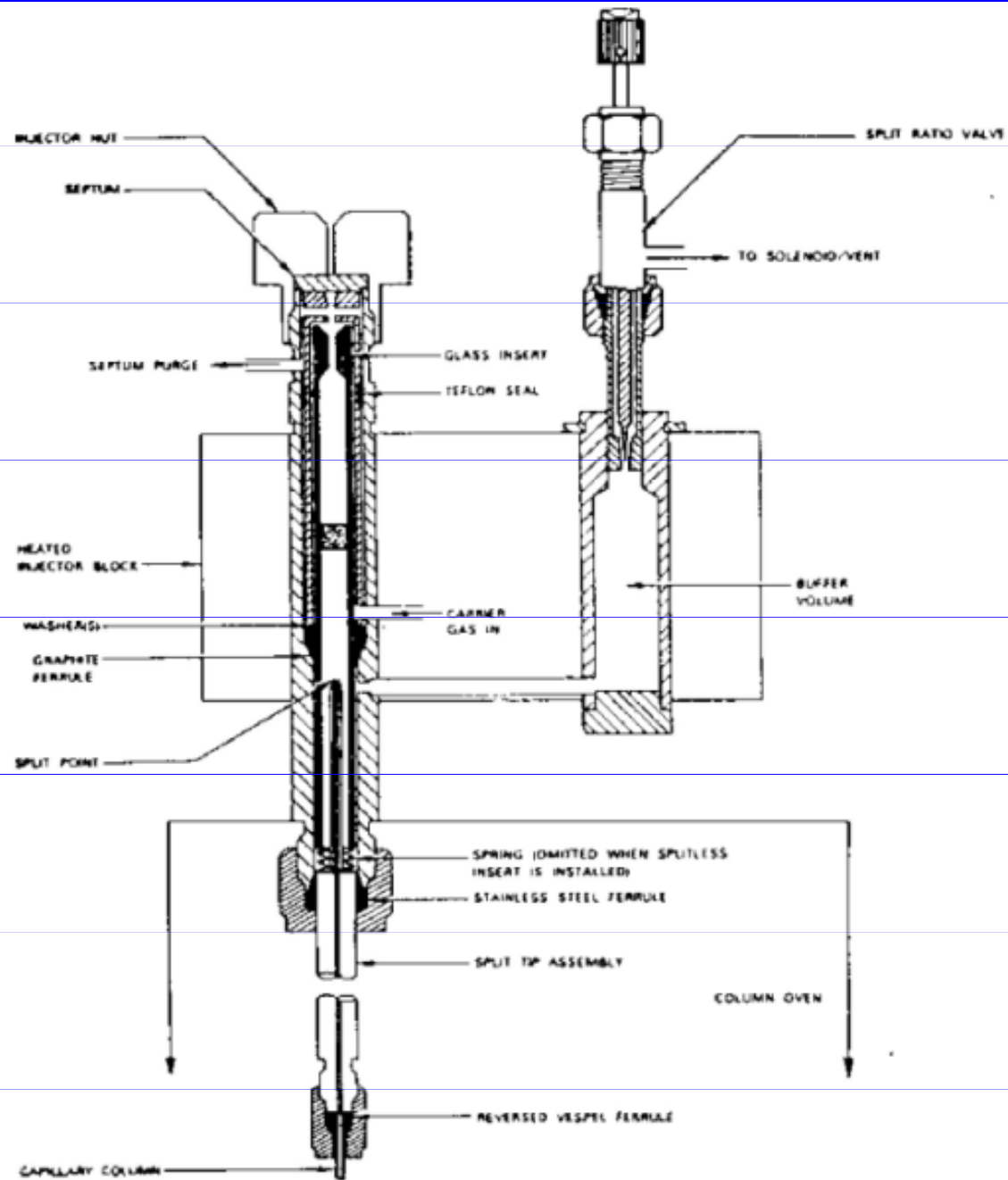

Figure 4.4 Major components of a gas chromatograph.



Cross-sectional view of a split-splitless injection assembly. (Reproduced with permission from Varian Associates).

Typy GC detektorů

- plamenový ionizační FID (hořící plamínek, elektrody)
- selektivní na dusík a fosfor NPD (alkalický kov)
- elektronového záchytu ECD (radioaktivní izotop, kolize)
- tepelně vodivostní TCD, katarometr (žhavené vlákno)
- plamenový fotometrický FPD
- atomový emisní AED
- fotoionizační PID
- elektrický vodivostní ELCD

Plamenový ionizační detektor

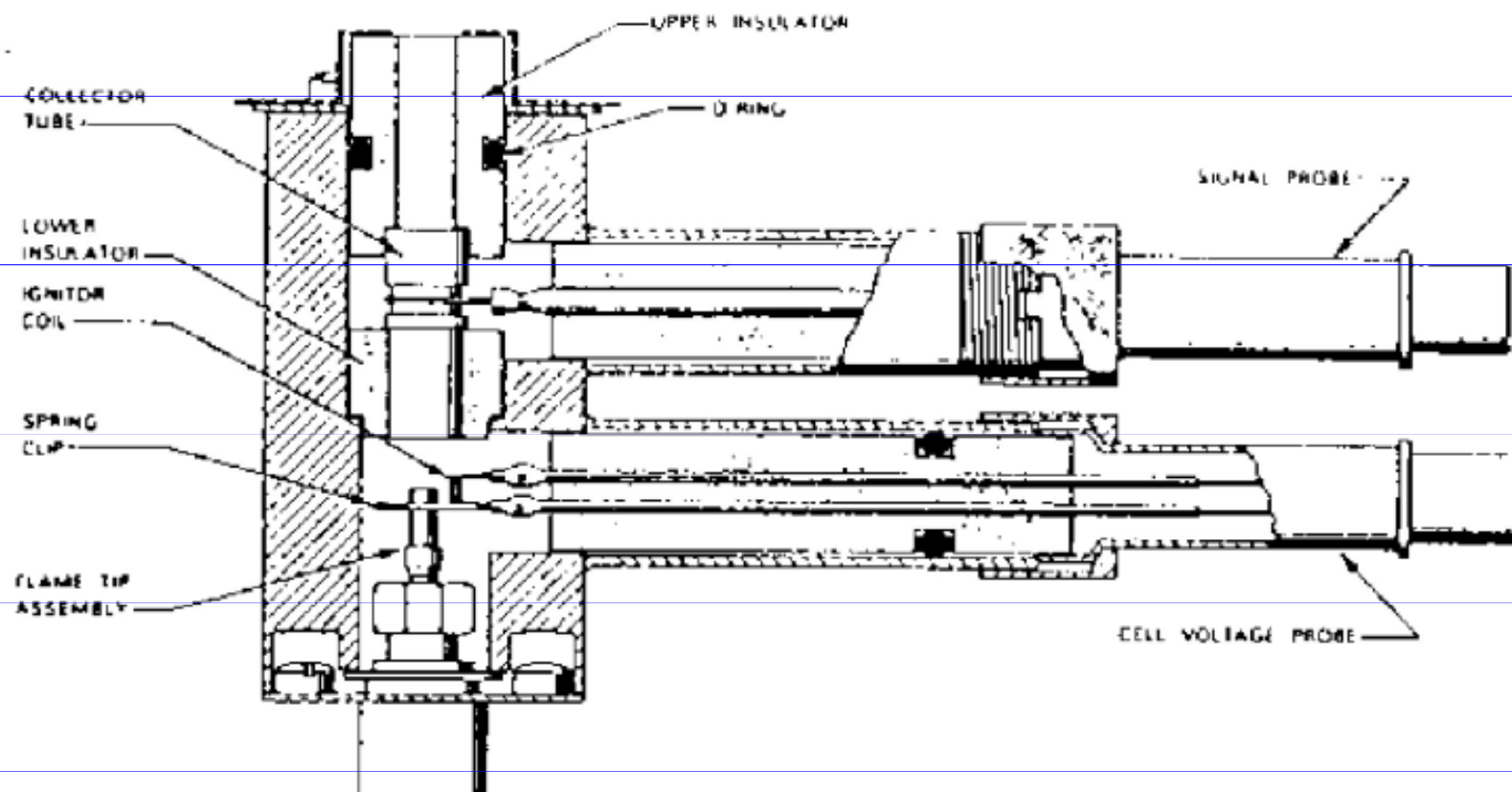

Detektor záchytu elektronů - koaxiální a asymetrické uspořádání

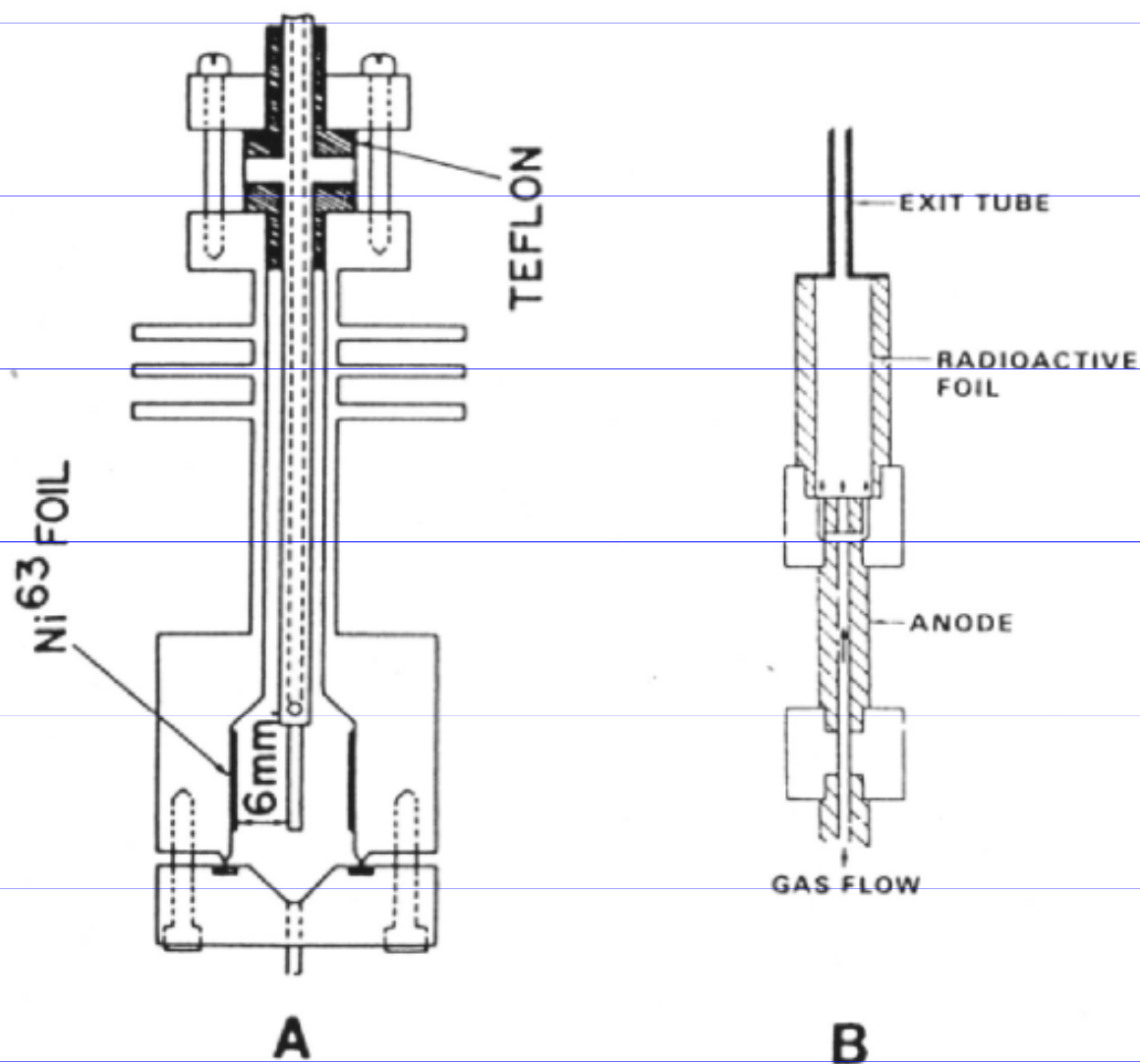

Schematic diagram of the coaxial cylinder, A, and the asymmetric (displaced coaxial cylinder), B, design.

Spojení GC s jinými technikami

- GC-MS
- GC-AES
- GC-FTIR
- vícerozměrná chromatografie (GC-GC)
- vícemodální chromatografie (GC-LC)

Dvourozměrná plynová chromatografie

je jeden z nejúčinnějších nástrojů v analýze komplexních matric.

Je založena na kontinuálním sběru efluentu z GC kolony a periodickém nástřiku do druhé kolony odlišných vlastností, čímž se zachová separace z první kolony a přidá nová.

Jádrem systému je rozhraní, které obe kolony spojuje.

Bez něj by nemusela zůstat zachována separace z první kolony:

Modulátory - termální

- kryogenní (chlazený CO_2 nebo N_2)
- ventilový

Využití:

- lepší separace a citlivost
- vzorky environmentálních matric
- potraviny, léčiva, kosmetika
- analýza ropy
- odpady a odpadní vody

Kapalinová chromatografie

- mobilní fází je kapalina, často směs různých rozpouštědel
- stacionární fází je sorbent (nejčastěji chemicky modifikovaný silikagel, alumina, polymer, uhlík)
- chromatografický děj probíhá na koloně
- normální a reverzní uspořádání
- eluce izokratická nebo gradientová
- změna teploty, tlaku, složení mobilní fáze

Instrumentace

- filtrace a odplynění mobilní fáze
- čerpadla mobilní fáze (regulátory tlaku a průtoku)
- automatické dávkovače a injektory
- termostat kolony
- detektory

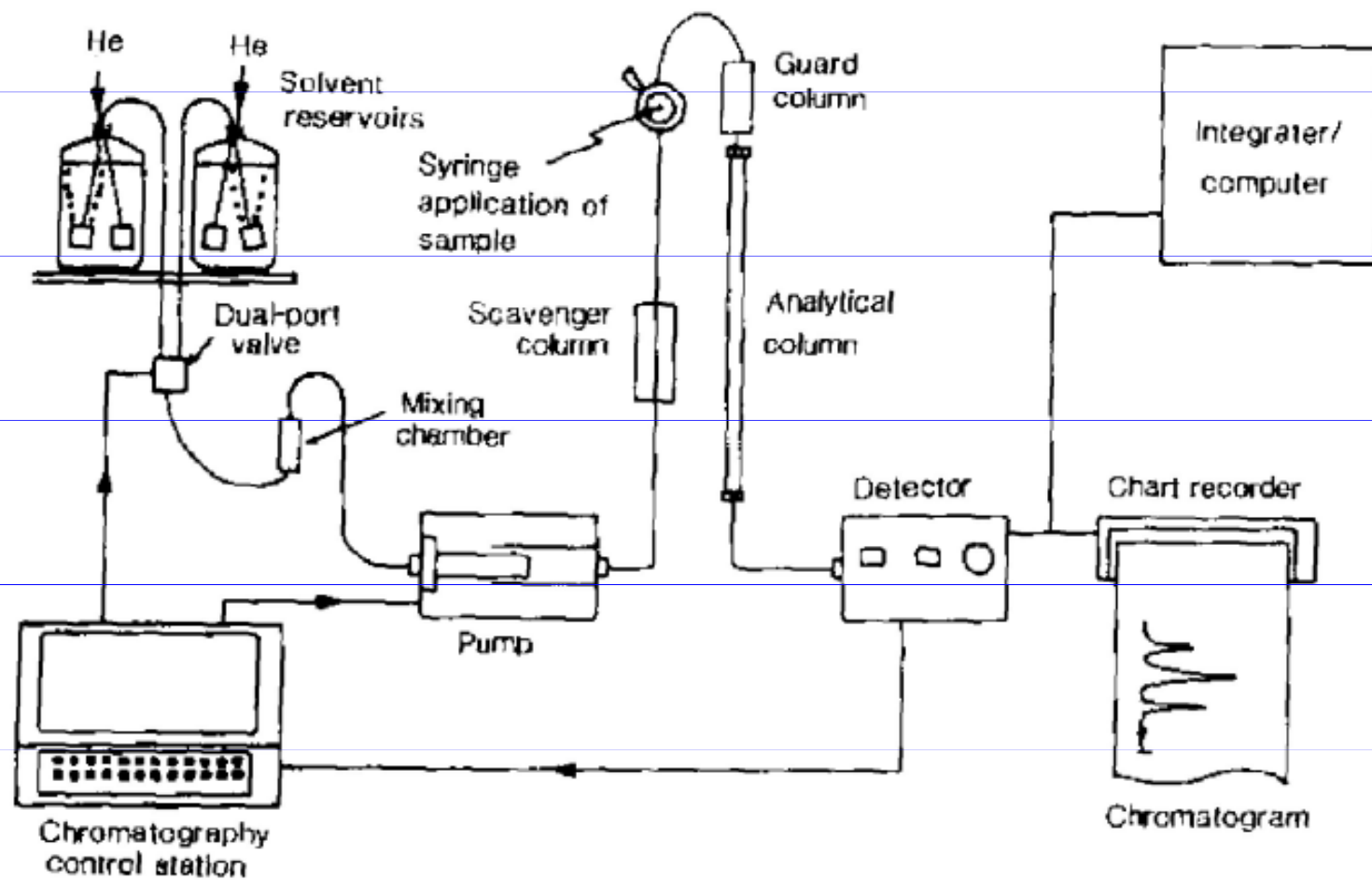

5.7 Schematic diagram of a binary (two-solvent) HPLC system. Source: Fifield, F.W. Kealey, D. (1995) *Principles and Practice of Analytical Chemistry*, 4th edition, Blackie Academic & Professional, Glasgow.

Typy detektorů

- fotometrické (měří se absorbance, UV, DAD)
- luminiscenční (emise světla při přechodu molekuly z excitovaného do základního stavu, fluorescence a fosforescence)
- elektrochemické (konduktometrické, amperometrické, coulometrické)
- refraktometrické
- hmotnostně spektrometrické

Aplikace kapalinové chromatografie





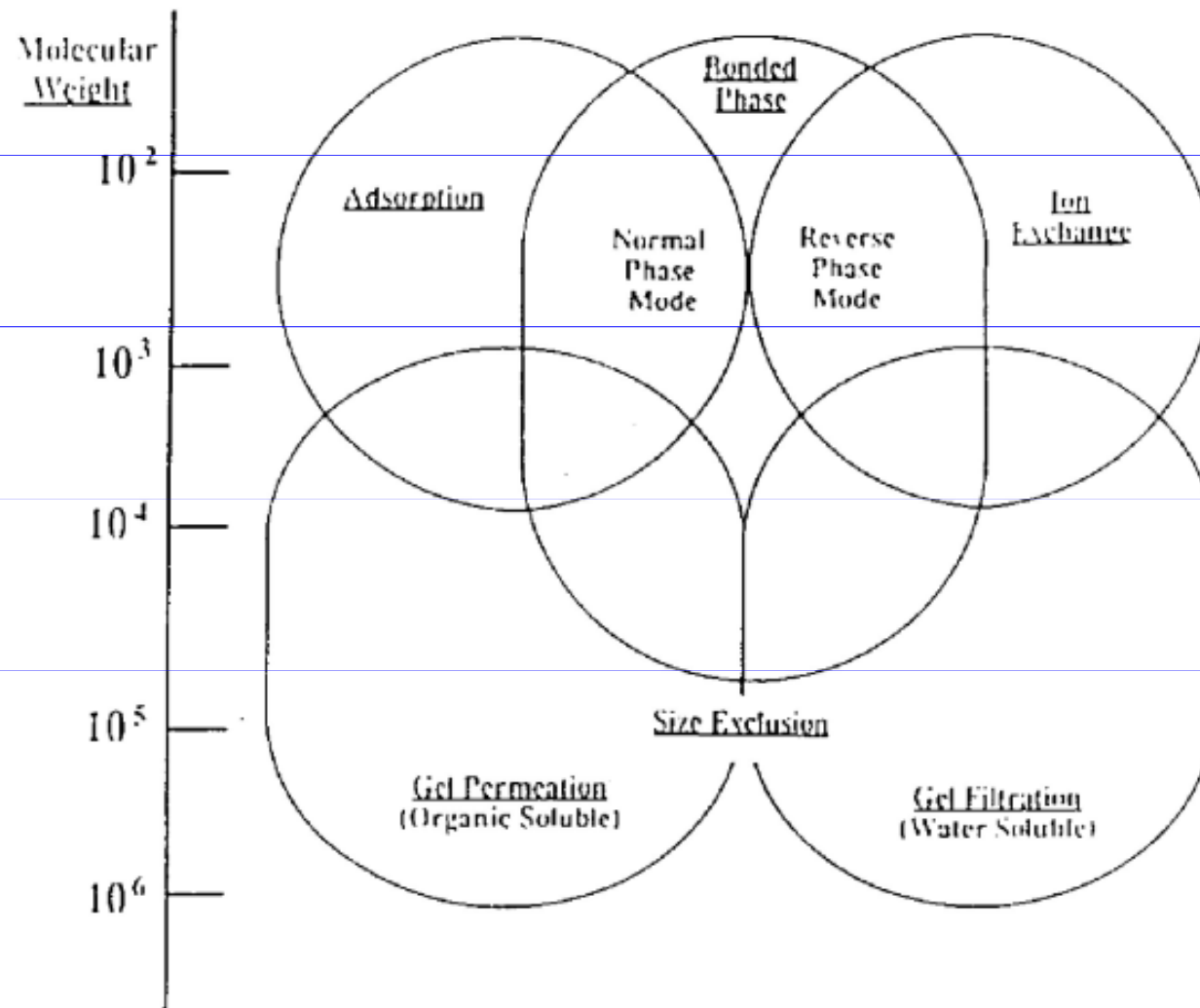
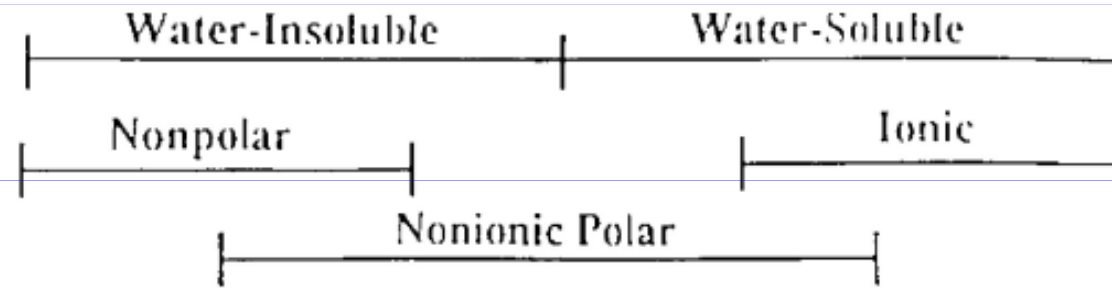

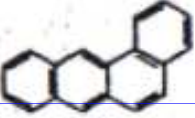

- podle použití
 - analytická
 - preparativní
- podle fáze
 - normální
 - reverzní
- podle interakcí
 - adsorpční
 - iontově výměnná (ionexy)
 - exkluzní (GPC- separace molekul na základě jejich velikosti a tvaru)
- spojení s dalšími technikami
 - LC-MS
 - LC- NMR

Increasing Polarity →

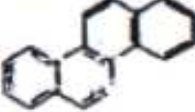
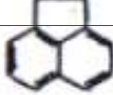
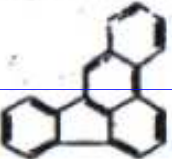

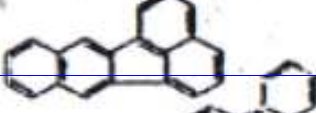
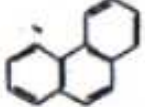
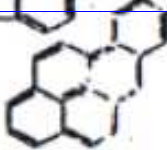
Výběr sledovaných polutantů

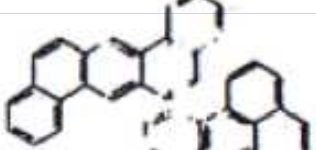
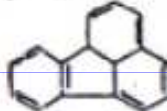
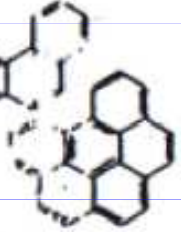
16 prioritních PAHs podle US EPA

1. Naphthalene	128		9. Benzo(a)anthracene	228	
2. Acenaphthylene	152		10. Chrysene	228	
3. Acenaphthene	154		11. Benzo(b)fluoranthene	228	
4. Fluorene	166		12. Benzo(k)fluoranthene	252	
5. Phenanthrene	178		13. Benzo(a)pyrene	252	
6. Anthracene	178		14. Dibenzo(a,h)anthracene	278	
7. Fluoranthene	202		15. Benzo(g,h,i)perylene	276	
8. Pyrene	202		16. Indeno(1,2,3-cd)pyrene	276	

IUPAC numbering and substitution pattern of PCB congeners

No.	Structure	No.	Structure	No.	Structure	No.	Structure
	<u>Monochlorobiphenyls</u>		<u>Tetrachlorobiphenyls</u>		<u>Pentachlorobiphenyls</u>		<u>Hexachlorobiphenyls</u>
1	2	52	2,2',5',5'	105	2,3,3',4,4'	161	2,3,3',4,5',6
2	3	53	2,2',5',6'	106	2,3,3',4,5	162	2,3,3',4',5,5'
3	4	54	2,2',6',6'	107	2,3,3',4',5	163	2,3,3',4',5,6
	<u>Dichlorobiphenyls</u>	55	2,3,3',4	108	2,3,3',4,5'	164	2,3,3',4',5',6
		56	2,3,3',4'	109	2,3,3',4,6	165	2,3,3',5,5',6
4	2,2'	57	2,3,3',5	110	2,3,3',4,6	166	2,3,4,4',5,6
5	2,3	58	2,3,3',5'	111	2,3,3',5,5'	167	2,3',4,4',5,5'
6	2,3'	59	2,3,3',6	112	2,3,3',5,6	168	2,3',4,4',5,6
7	2,4	60	2,3,4,4'	113	2,3,3',5,6	169	3,3',4,4',5,5'
8	2,4'	61	2,3,4,5	114	2,3,4,4',5		<u>Heptachlorobiphenyls</u>
9	2,5	62	2,3,4,6	115	2,3,4,4,6	170	2,2',3,3',4,4',5
10	2,6	63	2,3,4,5	116	2,3,4,5,6	171	2,2',3,3',4,4',6
11	3,3'	64	2,3,4,6	117	2,3,4',5,6	172	2,2',3,3',4,4,5,5'
12	3,4	65	2,3,5,6	118	2,3',4,4',5	173	2,2',3,3',4,5,6
13	3,4'	66	2,3',4,4'	119	2,3',4,4',6	174	2,2',3,3',4,5,6'
14	3,5	67	2,3',4,5	120	2,3',4,5,5'	175	2,2',3,3',4,5',6
15	4,4'	68	2,3',4,5'	121	2,3',4,5',6	176	2,2',3,3',4,6,6'
	<u>Trichlorobiphenyls</u>	69	2,3',4,6	122	2',3,3',4,5	177	2,2',3,3',4',5,6
		70	2,3',4',5	123	2',3,4,4',5	178	2,2',3,3',5,5',6
16	2,2',3	71	2,3',4',6	124	2',3,4,5,5'	179	2,2',3,3',5,6,6'
17	2,2',4	72	2,3',5,5'	125	2',3,4,5,6'	180	2,2',3,4,4',5,5'
18	2,2',5	73	2,3',5,6	126	3,3',4,4',5	181	2,2',3,4,4',5,6
19	2,2',6	74	2,4,4',5	127	3,3',4,5,5'	182	2,2',3,4,4',5,6'
20	2,3,3'	75	2,4,4',6		<u>Hexachlorobiphenyls</u>	183	2,2',3,4,4',5,6
21	2,3,4	76	2',3,4,5	128	2,2',3,3',4,4'	184	2,2',3,4,4',6,6'
22	2,3,4'	77	3,3',4,4'	129	2,2',3,3',4,5	185	2,2',3,4,5,5',6
23	2,3,5	78	3,3',4,5	130	2,2',3,3',4,5'	186	2,2',3,4,5,6,6'
24	2,3,6	79	3,3',4,5'	131	2,2',3,3',4,6	187	2,2',3,4',5,5',6
25	2,3',4	80	3,3',5,5'	132	2,2',3,3',4,6'	188	2,2',3,4',5,6,6'
26	2,3',5	81	3,4,4',5	133	2,2',3,3',5,5'	189	2,3,3',4,4',5,5'
27	2,3',6		<u>Pentachlorobiphenyls</u>	134	2,2',3,3',5,6	190	2,3,3',4,4',5,6
28	2,4,4'			135	2,2',3,3',5,6'	191	2,3,3',4,4',5,6
29	2,4,5	82	2,2',3,3',4	136	2,2',3,3',6,6'	192	2,3,3',4,5,5',6
30	2,4,6	83	2,2',3,3',5	137	2,2',3,4,4',5	193	2,3,3',4',5,5',6
31	2,4',5	84	2,2',3,3',6	138	2,2',3,4,4',5'		<u>Octachlorobiphenyls</u>
32	2,4',6	85	2,2',3,4,4'	139	2,2',3,4,4',6	194	2,2',3,3',4,4',5,5'
33	2',3,4	86	2,2',3,4,5	140	2,2',3,4,4',6'	195	2,2',3,3',4,4',5,6
34	2',3,5	87	2,2',3,4,5'	141	2,2',3,4,5,5'	196	2,2',3,3',4,4',5,6'
35	3,3',4	88	2,2',3,4,6	142	2,2',3,4,5,6	197	2,2',3,3',4,4',6,6'
36	3,3',5	89	2,2',3,4,6'	143	2,2',3,4,5,6'	198	2,2',3,3',4,5,5',6
37	3,4,4'	90	2,2',3,4,5	144	2,2',3,4,5',6	199	2,2',3,3',4,5,6,6'
38	3,4,5'	91	2,2',3,4,6	145	2,2',3,4,6,6'	200	2,2',3,3',4,5',6,6'
39	3,4',5	92	2,2',3,5,5'	146	2,2',3,4',5,5'	201	2,2',3,3',4,5,5',6'
	<u>Tetrachlorobiphenyls</u>	93	2,2',3,5,6	147	2,2',3,4',5,6	202	2,2',3,3',5,5',6,6'
		94	2,2',3,5,6'	148	2,2',3,4',5,6'	203	2,2',3,4,4',5,5',6
40	2,2',3,3'	95	2,2',3,5,6	149	2,2',3,4',5,6	204	2,2',3,4,4',5,6,6'
41	2,2',3,4	96	2,2',3,6,6'	150	2,2',3,4,6,6'	205	2,3,3',4,4',5,5',6
42	2,2',3,4'	97	2,2',3',4,5	151	2,2',3,5,5',6		<u>Nonachlorobiphenyls</u>
43	2,2',3,5	98	2,2',3',4,6	152	2,2',3,5,6,6'	206	2,2',3,3',4,4',5,5',6
44	2,2',3,5'	99	2,2',4,4',5	153	2,2',4,4',5,5'	207	2,2',3,3',4,4',5,6,6'
45	2,2',3,6	100	2,2',4,4',6	154	2,2',4,4',5,6'	208	2,2',3,3',4,5,5',6,6'
46	2,2',3,6'	101	2,2',4,5,5'	155	2,2',4,4',6,6'		<u>Decachlorobiphenyl</u>
47	2,2',4,4'	102	2,2',4,5,6'	156	2,3,3',4,4',5	209	2,2',3,3',4,4',5,5',6,6'
48	2,2',4,5	103	2,2',4,5,6	157	2,3,3',4,4',5'		
49	2,2',4,5'	104	2,2',4,6,6'	158	2,3,3',4,4',6		
50	2,2',4,6			159	2,3,3',4,5,5'		
51	2,2',4,6'			160	2,3,3',4,5,6		

Organochlorové pesticidy

DDT

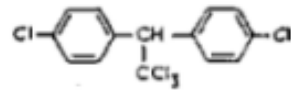

Aldrin

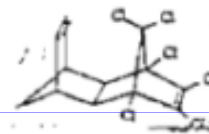

Hexachlorbenzen

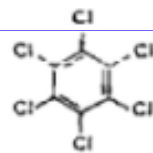

Dieldrin

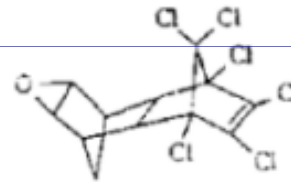

Lindan

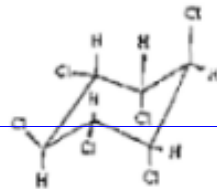

Endrin

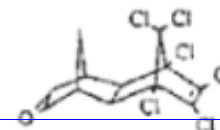

Toxafen (Camphechlor)

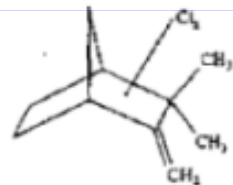

Endosulfan

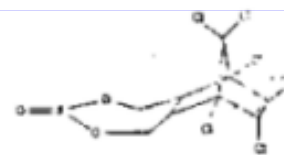

Chlordan

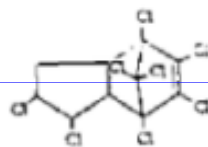

Heptachlor

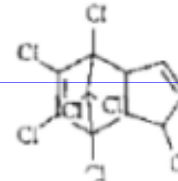

Základy hmotnostní spektrometrie

- MS a NMR jsou dvě rozhodující techniky ve strukturní analýze
- MS má výhodu jednoduchého spojení se separačními technikami
- MS je destruktivní technika, molekuly jsou ionizovány odtržením elektronu (nevratný proces), vzniklý molekulární ion má hmotnost m a náboj z (měříme poměr m/z), je nestabilní a dále fragmentuje
- ve spektru sledujeme molekulární ion i fragmenty

Princip metody

- separace ionizovaných molekul analyzované látky a jejích fragmentů podle velikosti poměru m/z (podle hmotnosti)
- identifikace na základě distribuce hmotností molekulového ionu a vzniklých fragmentů
- techniky - scan
 - SIM

Instrumentace hmotnostní spektrometrie

- iontový zdroj - pro ionizaci nárazem elektronu (tvrdá)
 - záchytem elektronu (negativní ion)
 - chemická ionizace (ionizuje se ionizační médium, např. methan, měkká technika)
- analyzátor
 - kvadrupólový
 - iontová past (trojrozměrný hyperbolický Q)
 - jednoduchá nebo vícenásobná fokusace
 - elektrické nebo magnetické pole
- detektor
 - elektronový násobič
 - fotonásobič

Kvadrupólový analyzátor (Q)

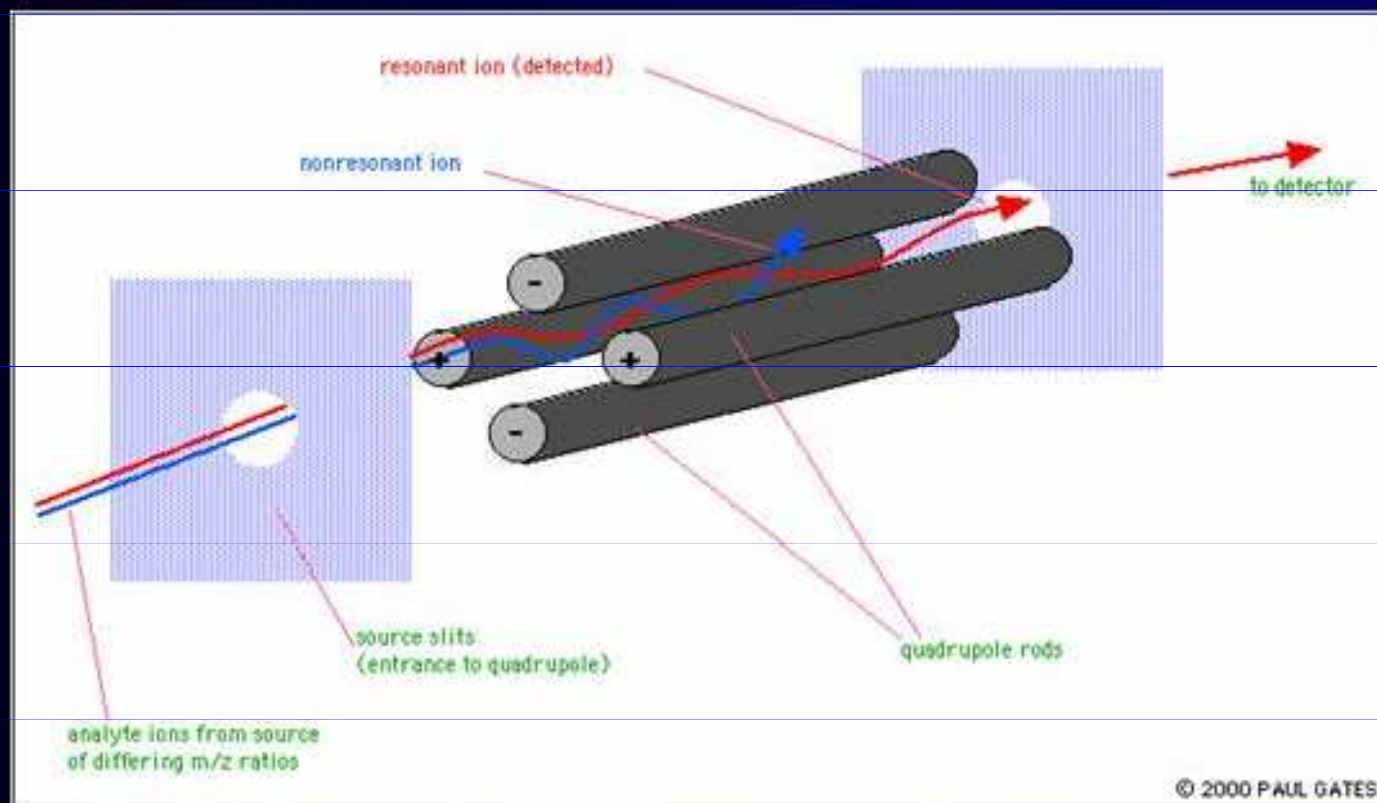

Iontová past (IT)

Vlákno

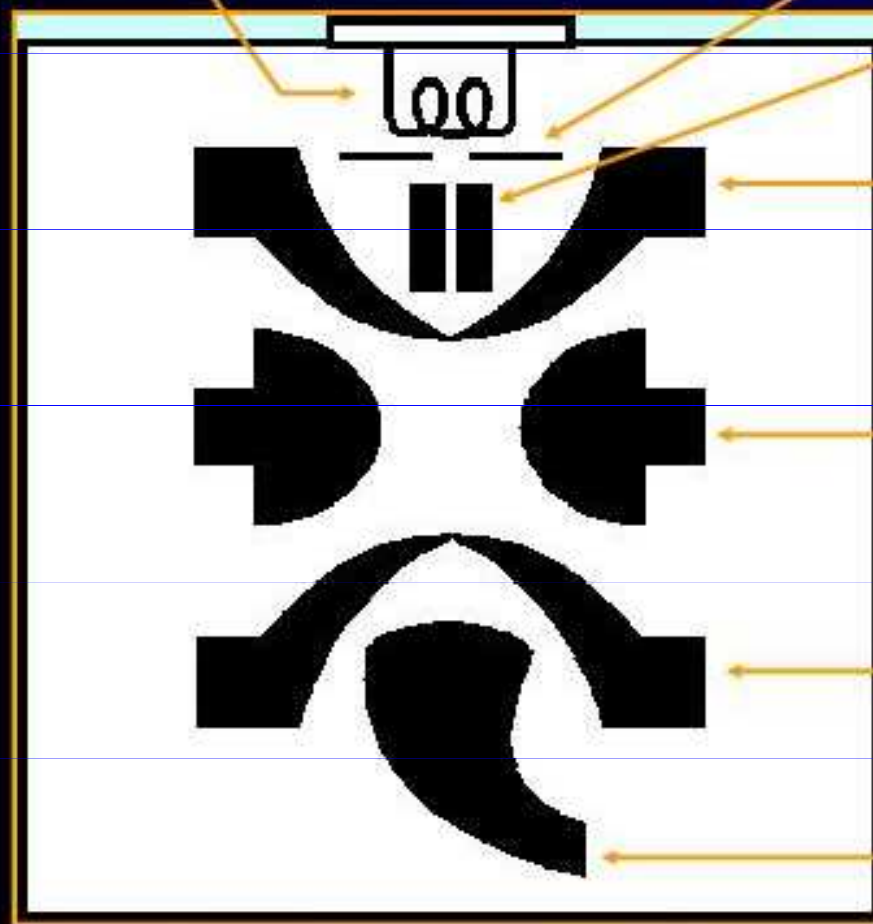

Fokuzace
elektronů

Vstupní brána
elektronů

Horní koncová
elektroda

Střední kruhová
elektroda

Dolní koncová
elektroda

Elektronový
násobič

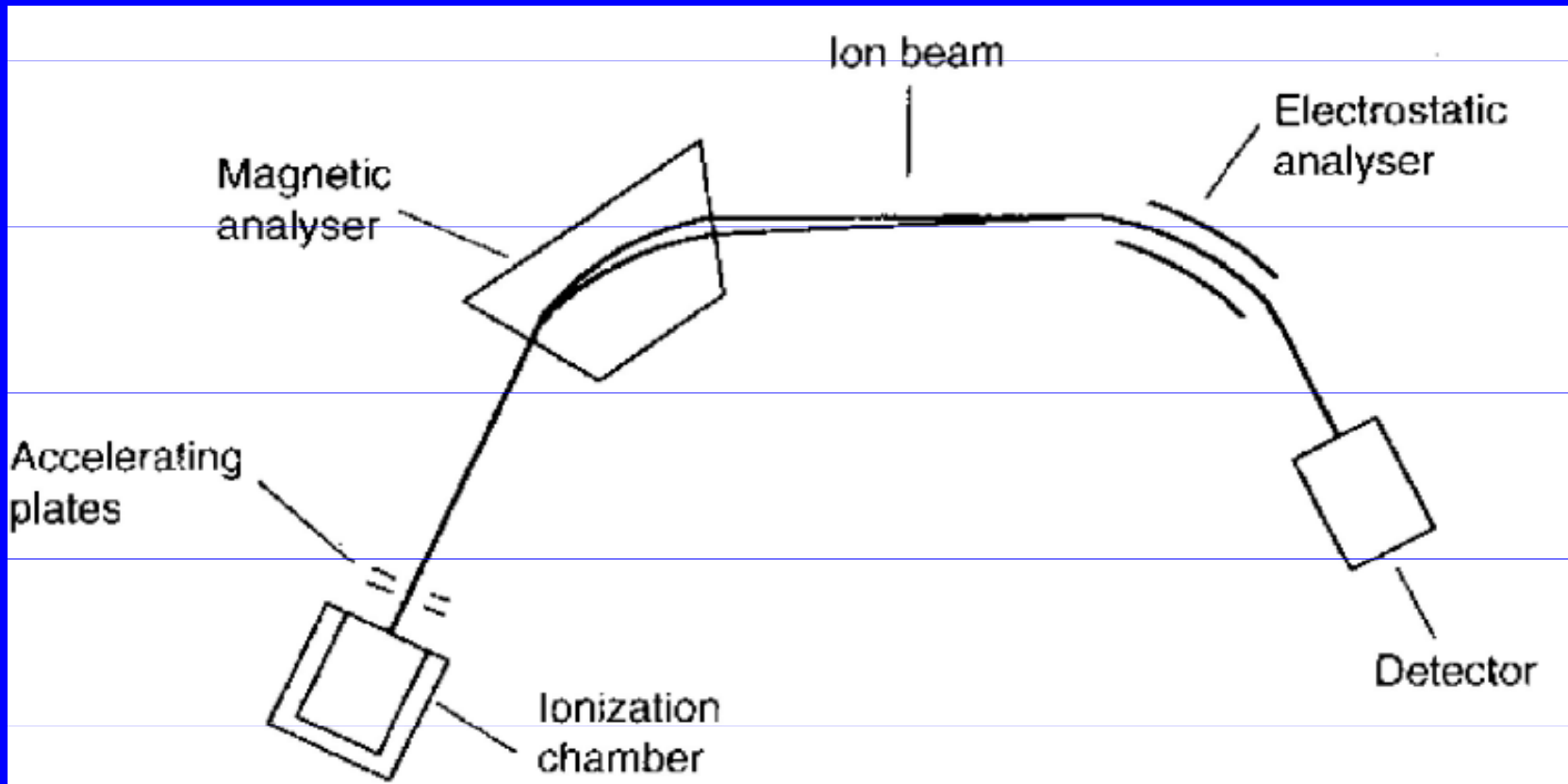

Figure 8.3 Schematic of a high-resolution mass spectrometer.

Spojení MS se separačními technikami

- GC může být připojena přímo,
kapilární kolona je vedena do iontového zdroje
- u LC a CE je třeba odstranit nadbytek mobilní fáze,
HPLC a MS musí být spojeno přes interface:
 - particle beam (PB,tryskový separátor těžších molekul)
 - thermospray (TSl,ionizace při vypařování ionů,měkká)
 - electrospray (ESI,)
 - APCI (ionty z mobilní fáze působí jako reakční plyn)

HPLC-NMR, HPLC-MS, HPLC-NMR-MS

- analýza environmentálních vzorků s neznámými polutanty, bez cílových sloučenin
- analýza nebezpečných odpadů a odpadních vod
- směsi látek s rozdílnou polaritou, koncentrací, těkavostí
- produkty transformací chemických, fotochemických, mikrobiologických

Spojení HPLC-NMR

vyžaduje - průtokovou celu

- odstranění nadbytku solventu

Lze pracovat v průtokovém, právě tak jako ve stopped flow módu.

Citlivost NMR je o několik řádů než u MS, ale NMR dává nenahraditelné informace o struktuře látek.

Výhody

- strukturní informace

- vhodné pro široké spektrum analytů (labilní, netěkavé, polární)

- nedestruktivní metoda

HPLC-MS

- tlak na vývoj nových systémů rozhraní, tvorby vakua, ionizace
- umožňuje stanovení molekulární hmotnosti a prvkového složení, což není možné NMR.
- jedná se o komplementární metody

HPLC-NMR-MS

effluent se rozdělí: 95% NMR, 5% MS

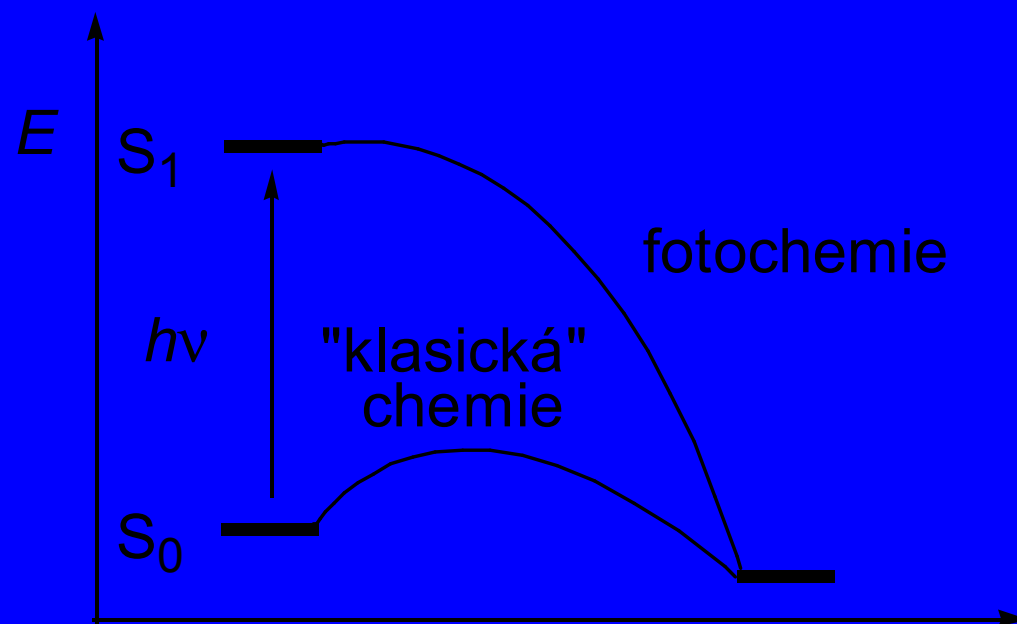

Klasická chemie zahrnuje reakce látek v základním (nejnižším) energetickém stavu (S_0). Fotochemie se zabývá reaktivitou stavů o vyšší energii – stavů *excitovaných* (např. S_1).

Jablonskiho diagram

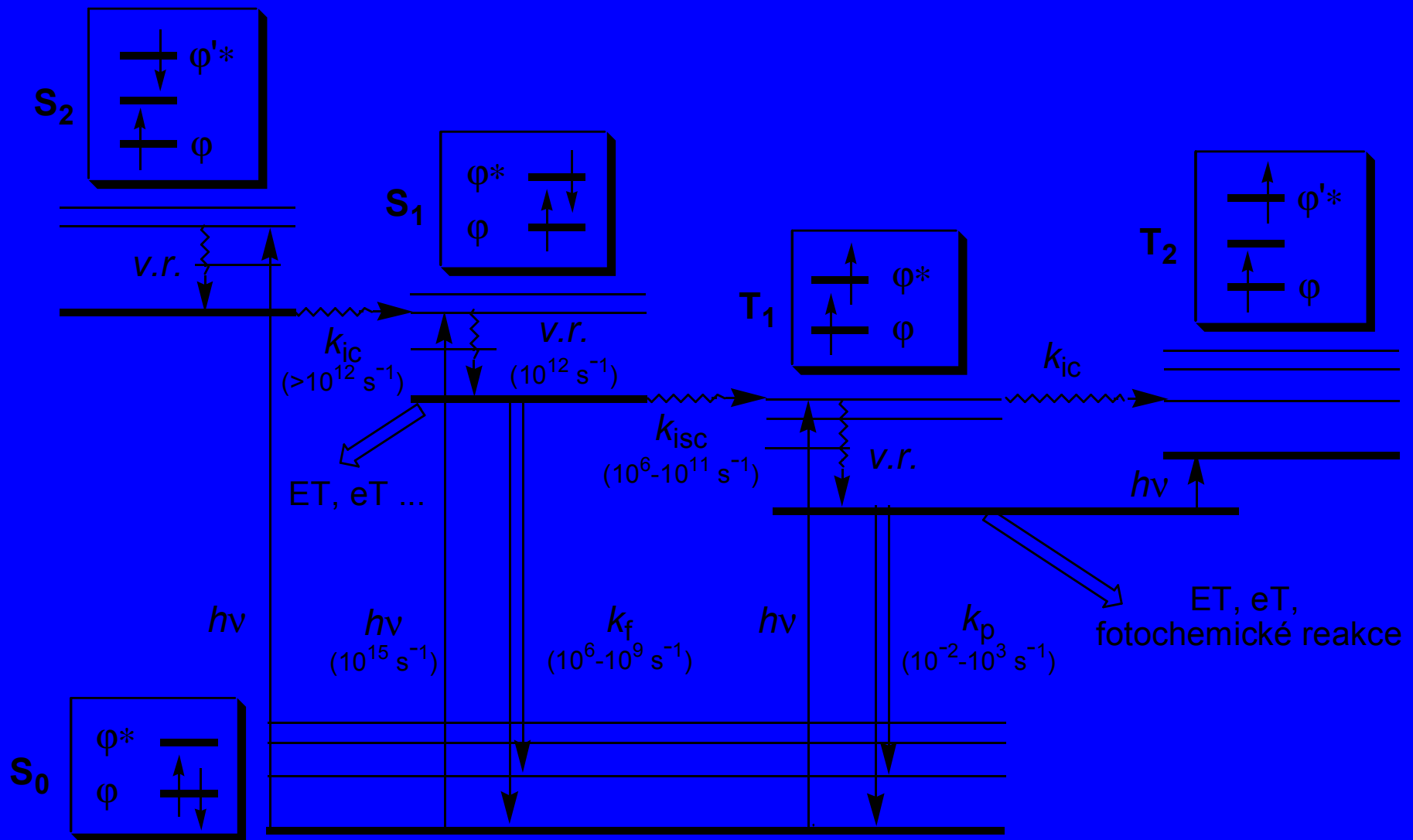

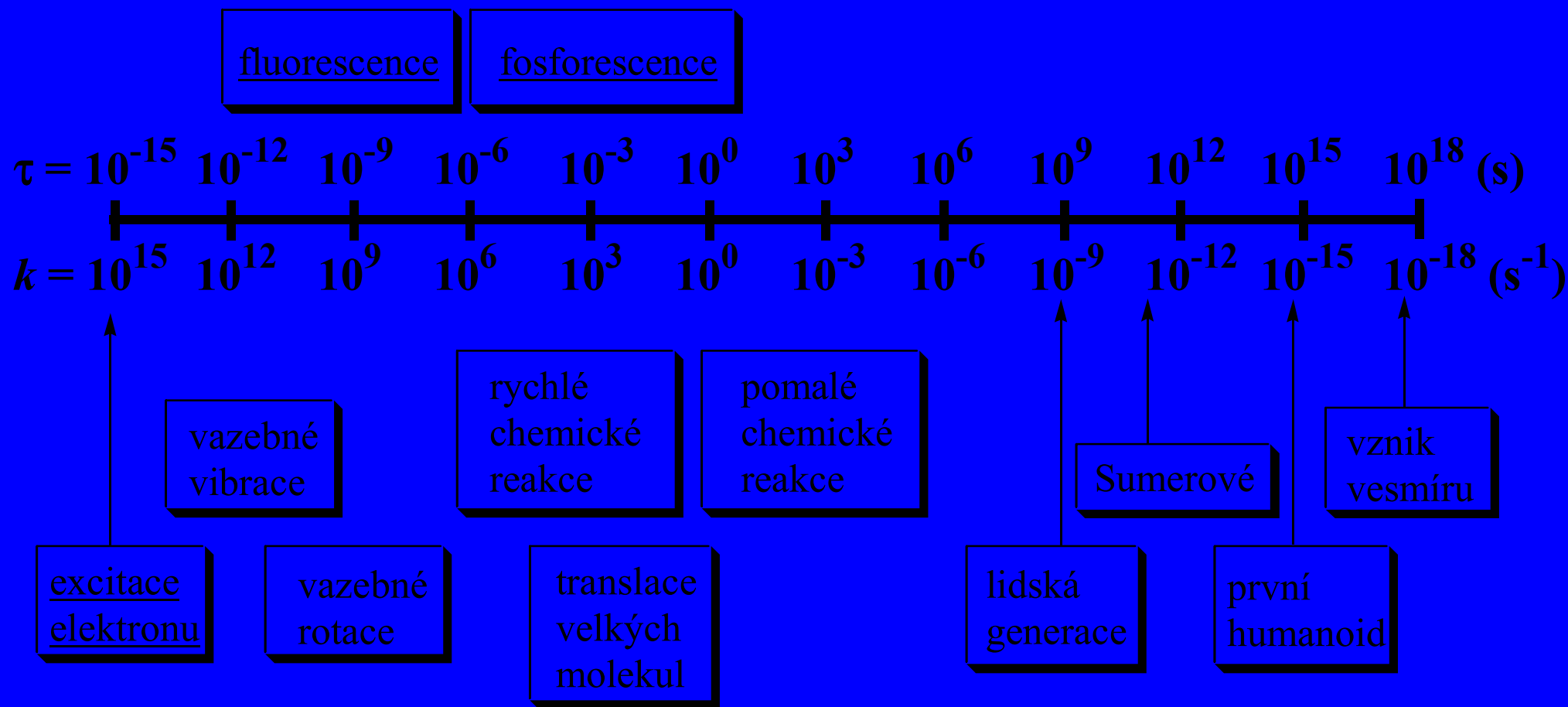

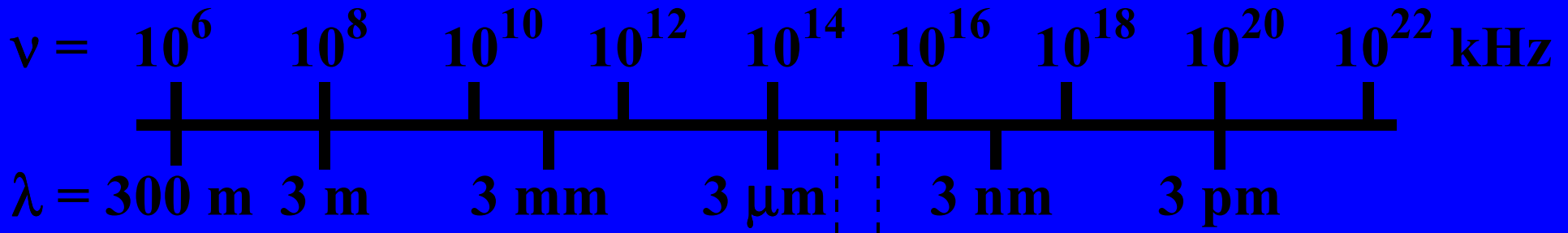
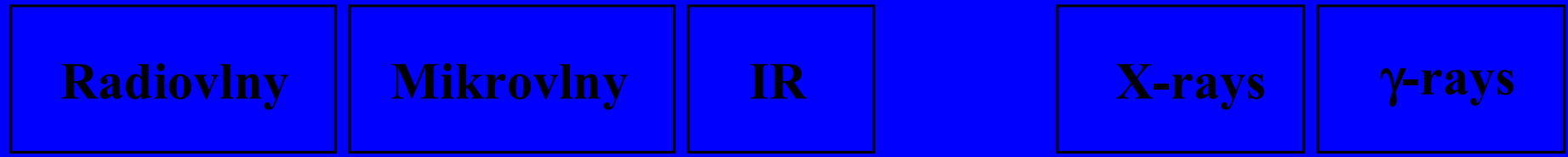

R Y G B V

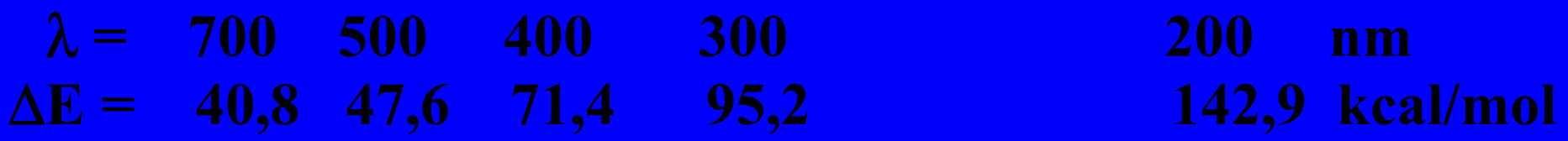
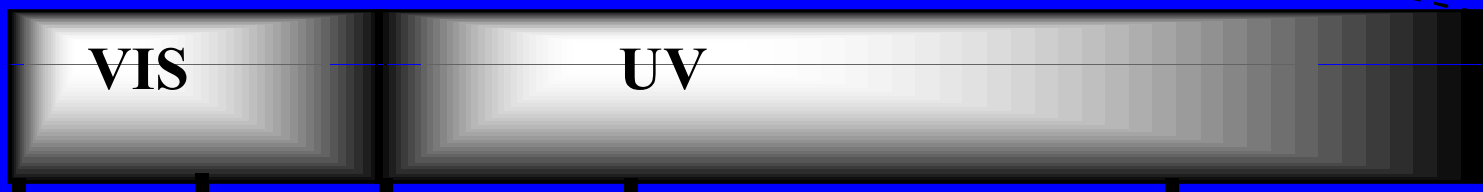

Cesty vedoucí ke ztrátě excitace

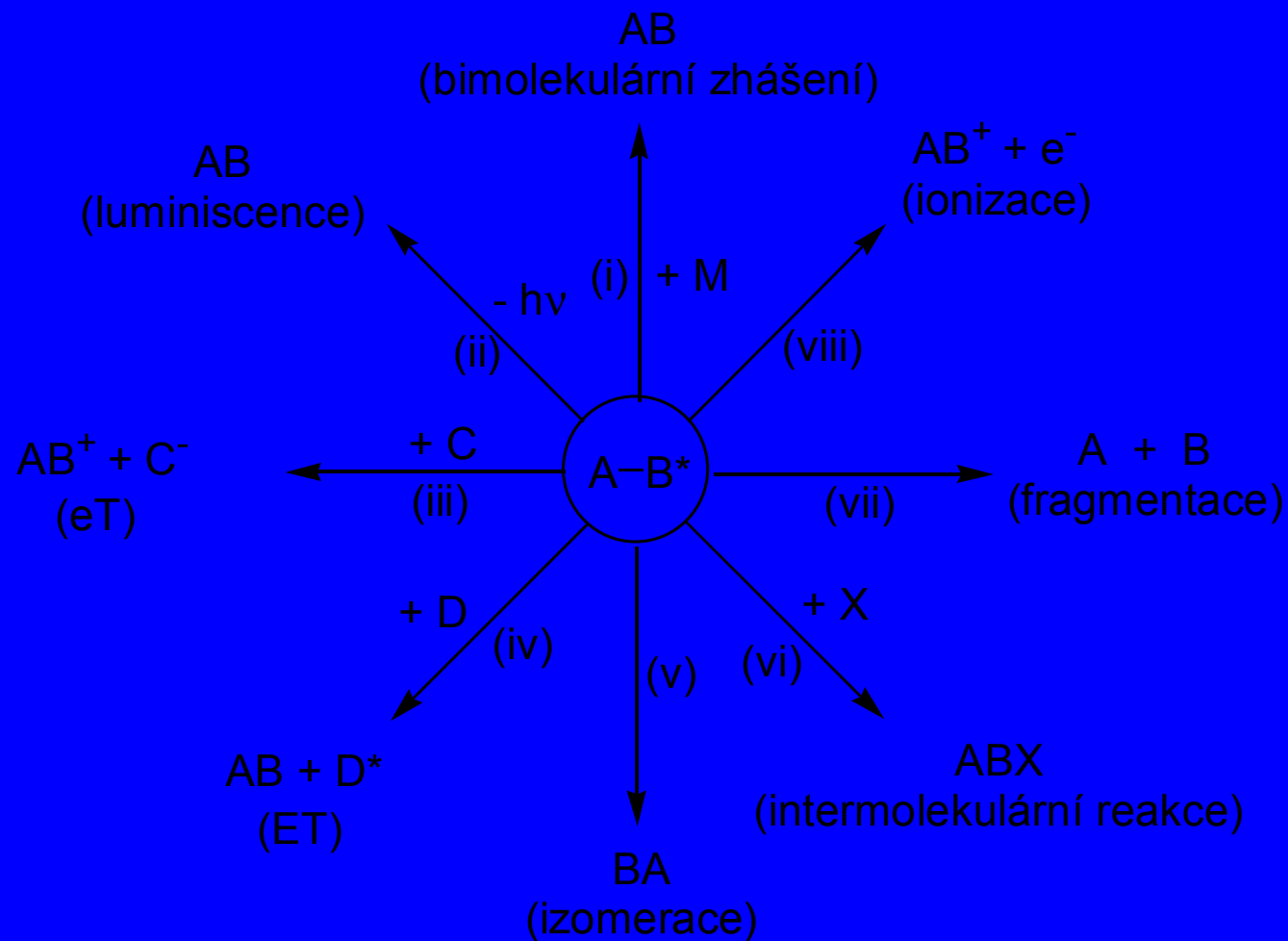

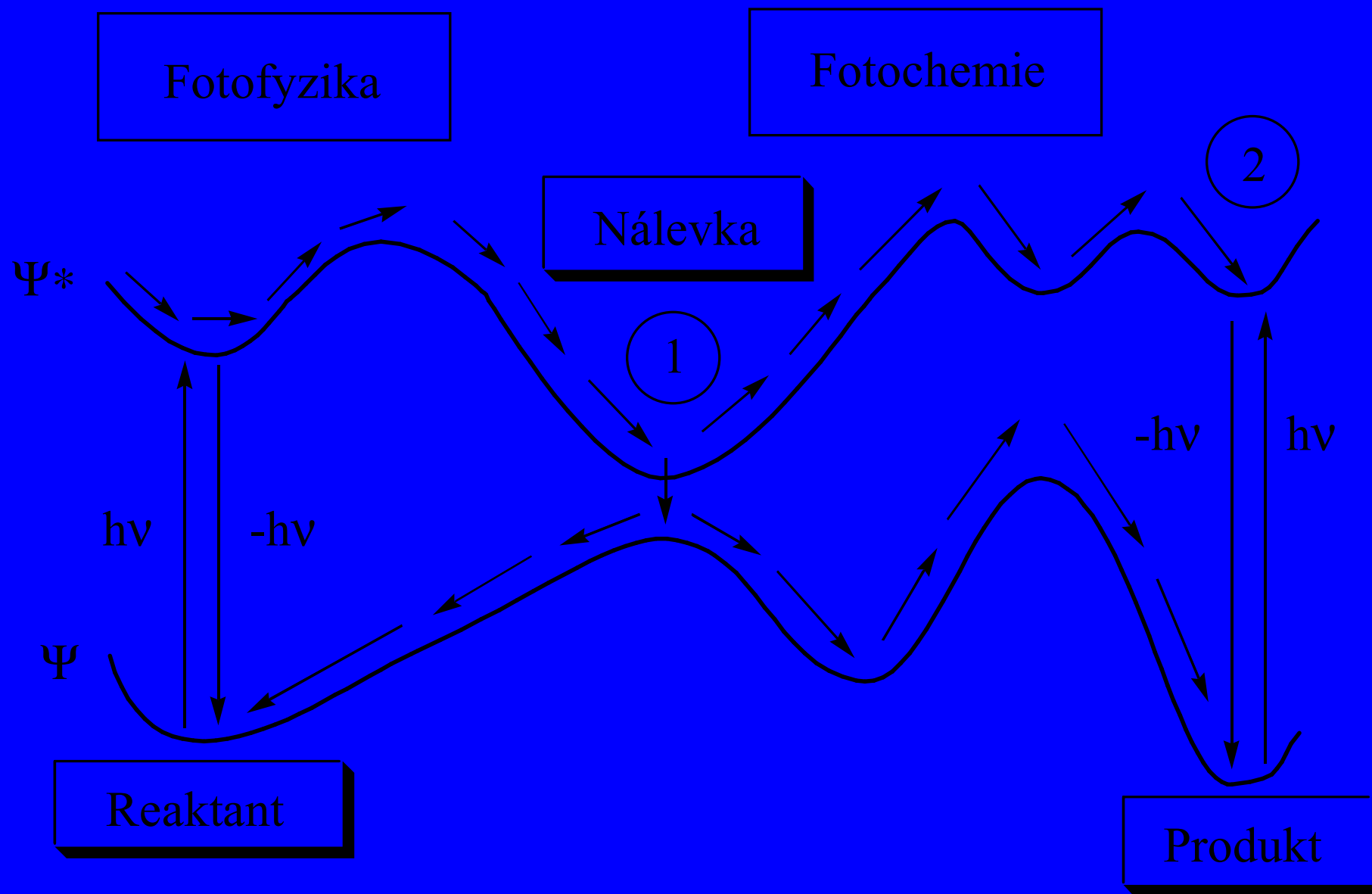

Absorption Data of Some Chromophores

chromophore	λ_{\max} [nm]	ϵ_{\max} [$\text{l mol}^{-1} \text{cm}^{-1}$]	transition
C-C	<180	1000	$\sigma \rightarrow \sigma^*$
C-H	<180	1000	$\sigma \rightarrow \sigma^*$
C=C	180	10000	$\pi \rightarrow \pi^*$
C=C-C=C	220	20000	$\pi \rightarrow \pi^*$
benzene	260	200	$\pi \rightarrow \pi^*$
naphthalen	310	200	$\pi \rightarrow \pi^*$
anthracene	380	10000	$\pi \rightarrow \pi^*$
C=O	280	20	$n \rightarrow \pi^*$
N=N	350	100	$n \rightarrow \pi^*$
N=O	660	200	$n \rightarrow \pi^*$
C=C-C=O	350	30	$n \rightarrow \pi^*$
C=C-C=O	220	20000	$\pi \rightarrow \pi^*$

„Time-resolved“ experimenty

Záblesková fotolýza

<i>doba trvání záblesku</i>	<i>studovaný jev</i>
• 10^{-3} s	bimolekulární reakce
• 10^{-6} s	bimolekulární reakce
• 10^{-9} s	fluorescence, mezisystémový přechod
• 10^{-12} s	rekombinace radikálů, přenos energie, vibrační relaxace, vnitřní přeměna, izomerační reakce
• 10^{-15} s	elementární fotofyzikální pochody (např. excitace elektronu)

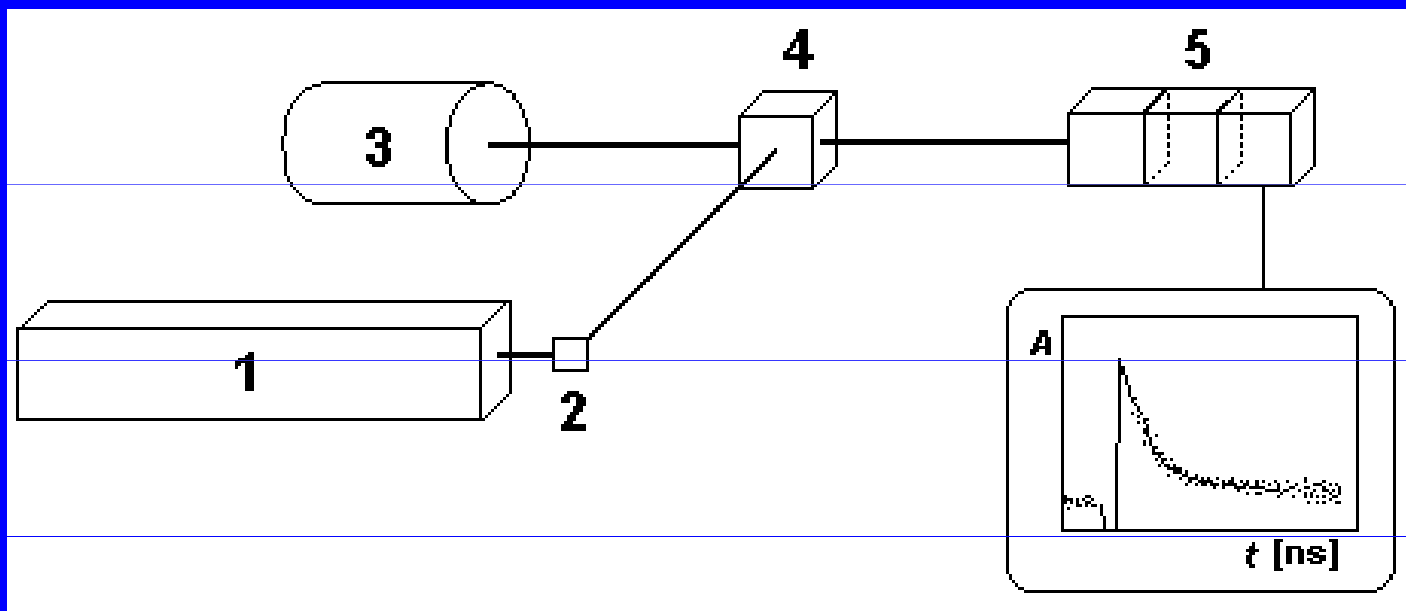

Nanosekundová laserová záblesková fotolýza: 1 - laser; 2 - optická clona; 3 - zdroj UV záření; 4 - kyveta se vzorkem; 5 - monochromátor, fotodetektor a osciloskop.

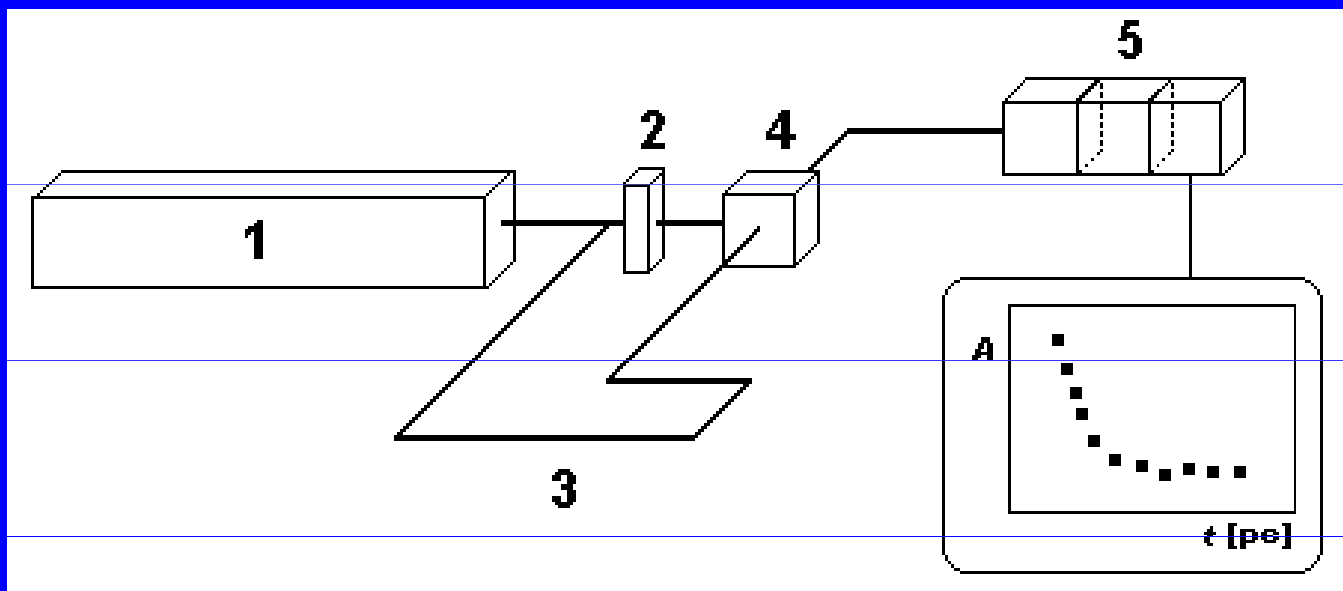

Pikosekundová laserová záblesková fotolýza: 1 - laser; 2 - optická clona; 3 - optická cesta určující zpoždění pulzu; 4 - kyveta se vzorkem; 5 - monochromátor, fotodetektor a osciloskop.

PAHs in Ambient Air - Košetice 1988-2002

Gas Phase

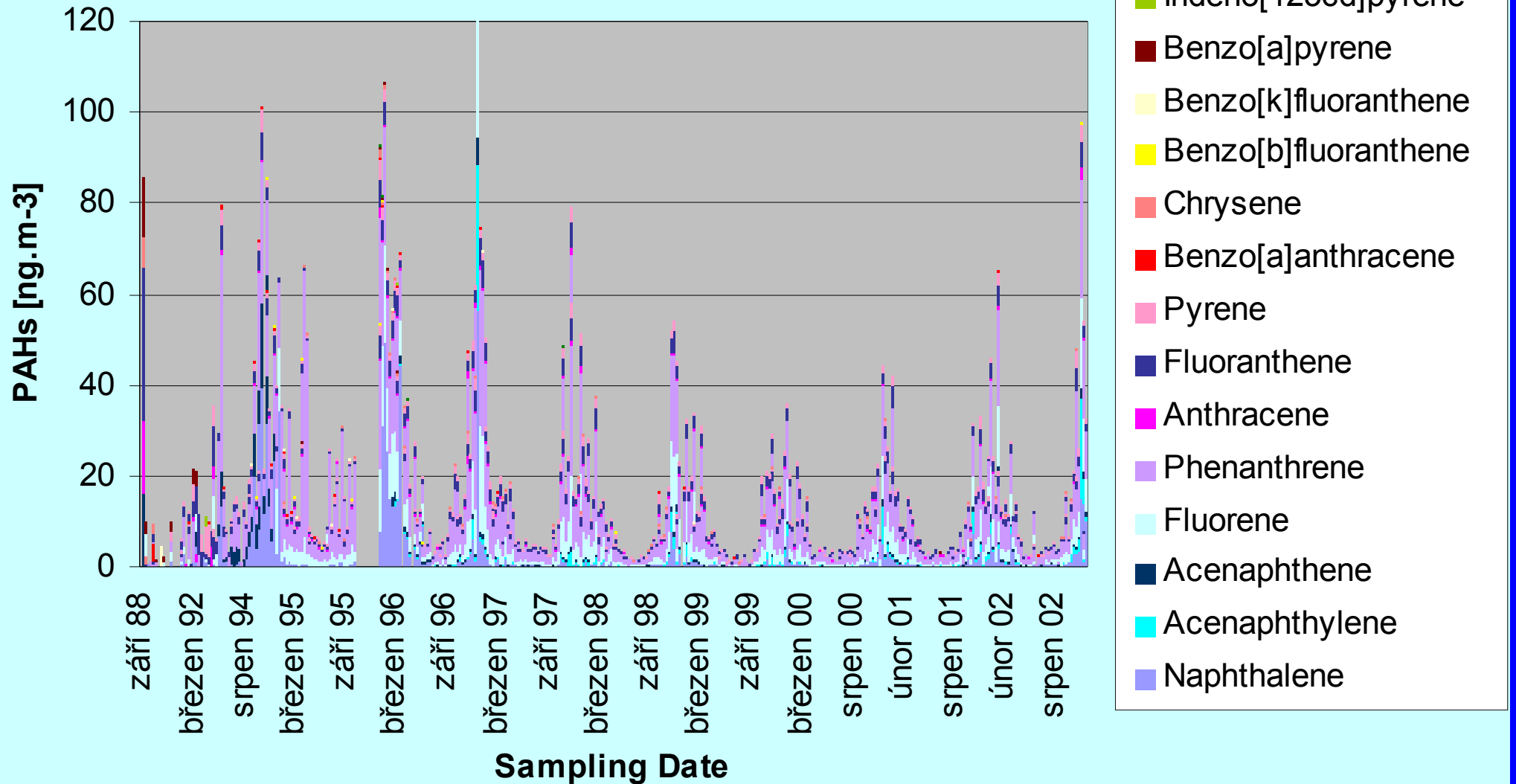

CI-pesticide Concentration in Soil on Locality Košetice 3.11

