

Mass Spectrometry in the analysis of Persistent Organic Pollutants



Anton Kočan, Jana Klánová

Tools for determining chemical structure

- IR
- UV-VIS
- X-ray crystallography
- NMR
- Mass spectrometry (MS)



Kurt Wuthrich a **John B. Fenn (1/4) + Koichi Tanaka (1/4)** shared the Nobel Price in chemistry for 2002.

The latter two for the development of soft desorption ionization methods for **mass spectrometric** analyses of biological macromolecules

Altogether, 5 scientists have been awarded the Nobel Price in connection with mass spectrometry – Joseph Thompson in 1906, Francis Aston in 1922, Wolfgang Paul in 1989, and J. Fenn and K. Tanaka in 2002

Advantages of Mass Spectrometry

- **A small amount of substance is sufficient**
- **Mixtures can be analyzed**

Disadvantages of Mass Spectrometry

- **It is a destructive method**
- **The evaluation of mass spectra is demanding**

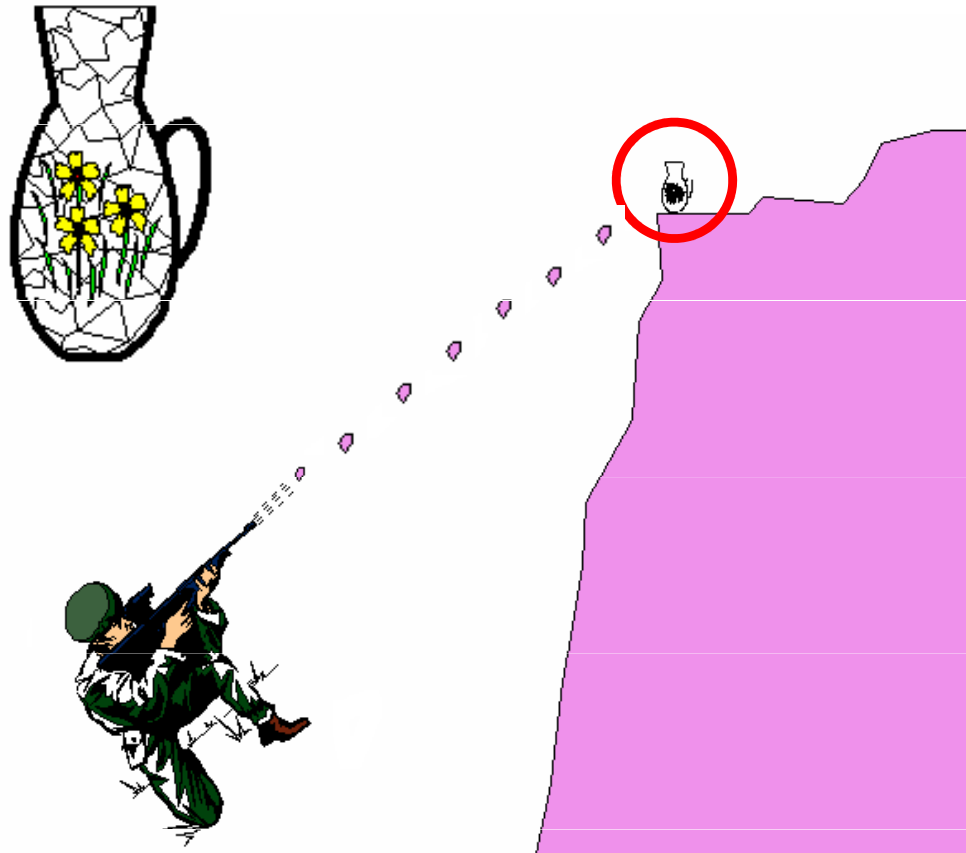

Mass Spectrometer

- All the MS systems compose of the following parts:

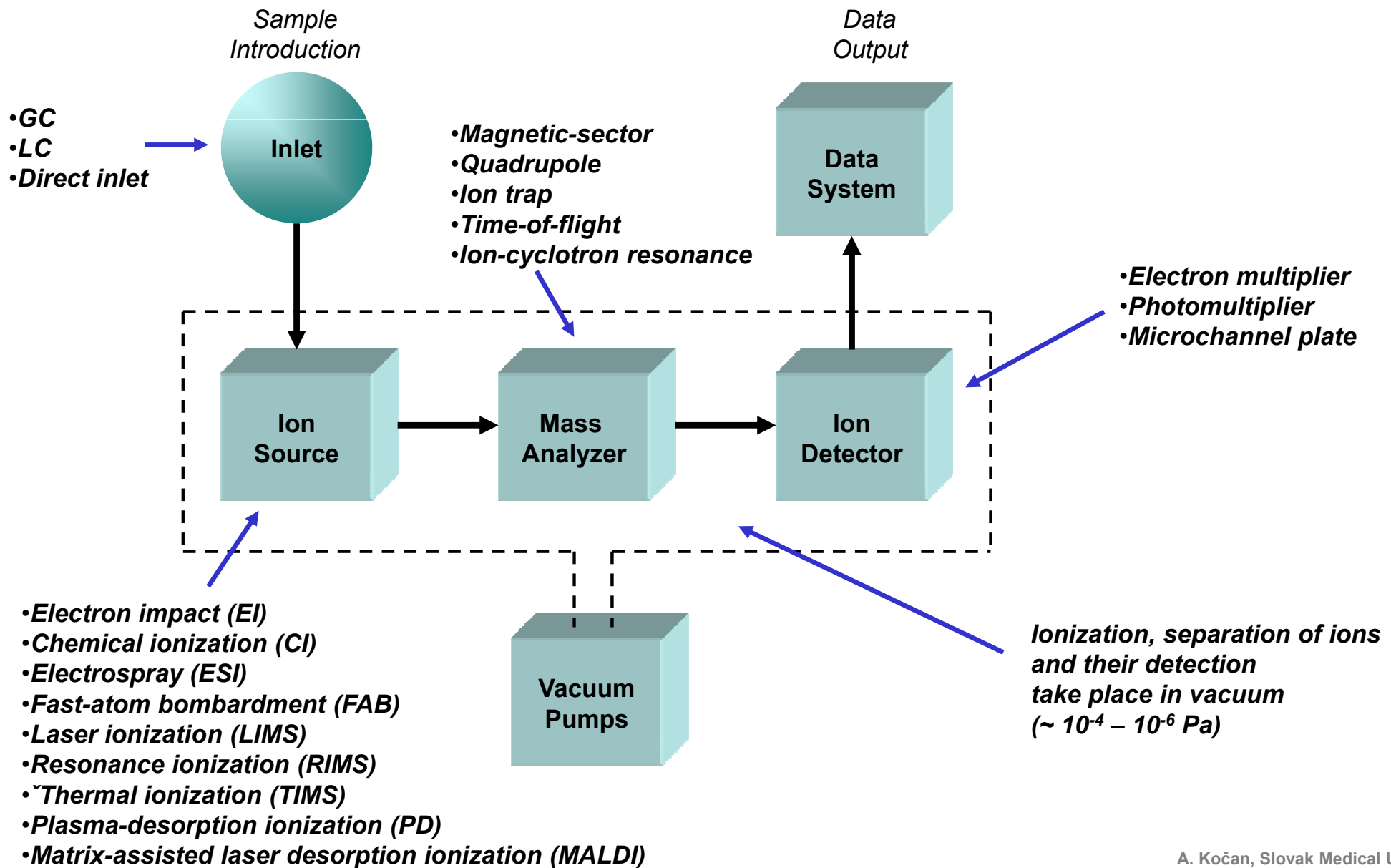

Sample Introduction

- **Direct inlet to the ion source**
 - Introduction of the gaseous sample
 - Introduction of the liquid or solid sample after their vaporization
- **Outlet from the chromatographic column**
 - Gas chromatography – packed column (a carrier gas separator is needed)
 - capillary column (directly to the ion source)
 - Liquid chromatography (the separation of the mobile phase is essential)

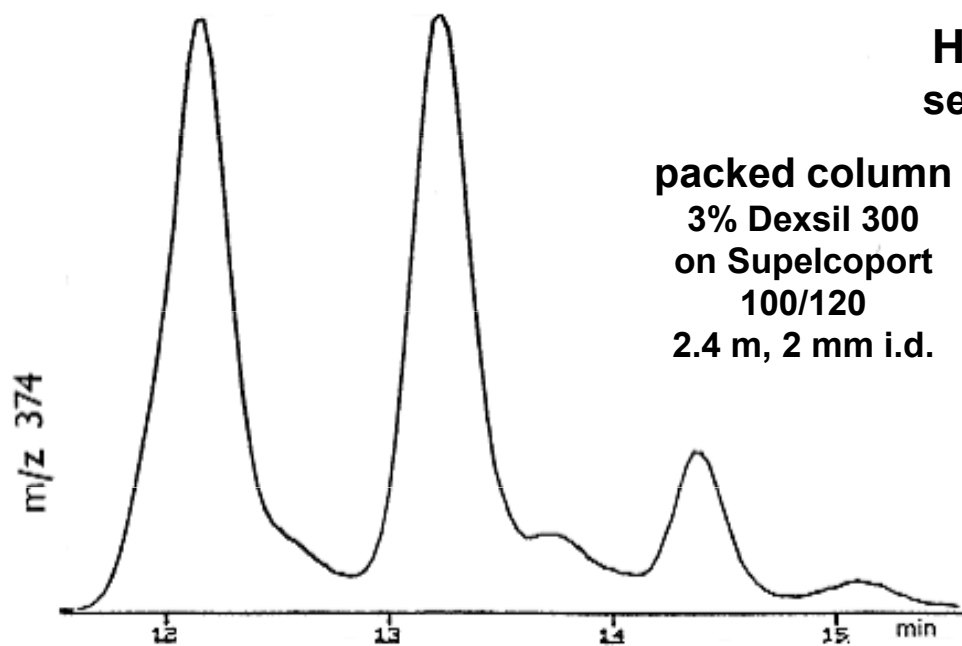

HexaCDFs
separated by

packed column
3% Dexsil 300
on Supelcoport
100/120
2.4 m, 2 mm i.d.

capillary
column
SP-2331
60 m
0.25 mm i.d.
0.2 μ m

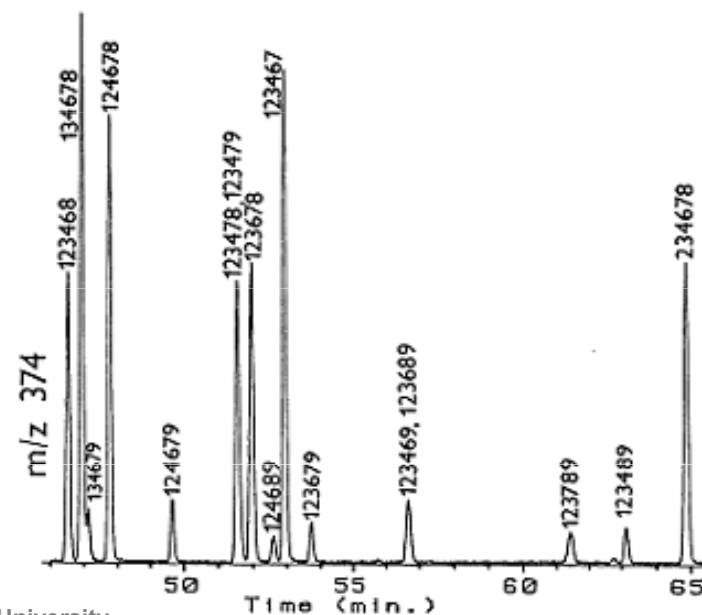

Electron Impact Ionization Source

The molecules are bombarded by electrons (e^-) emitted by a heated filament (W or Re) in vacuum ($\sim 10^{-5} - 10^{-6}$ mbar)

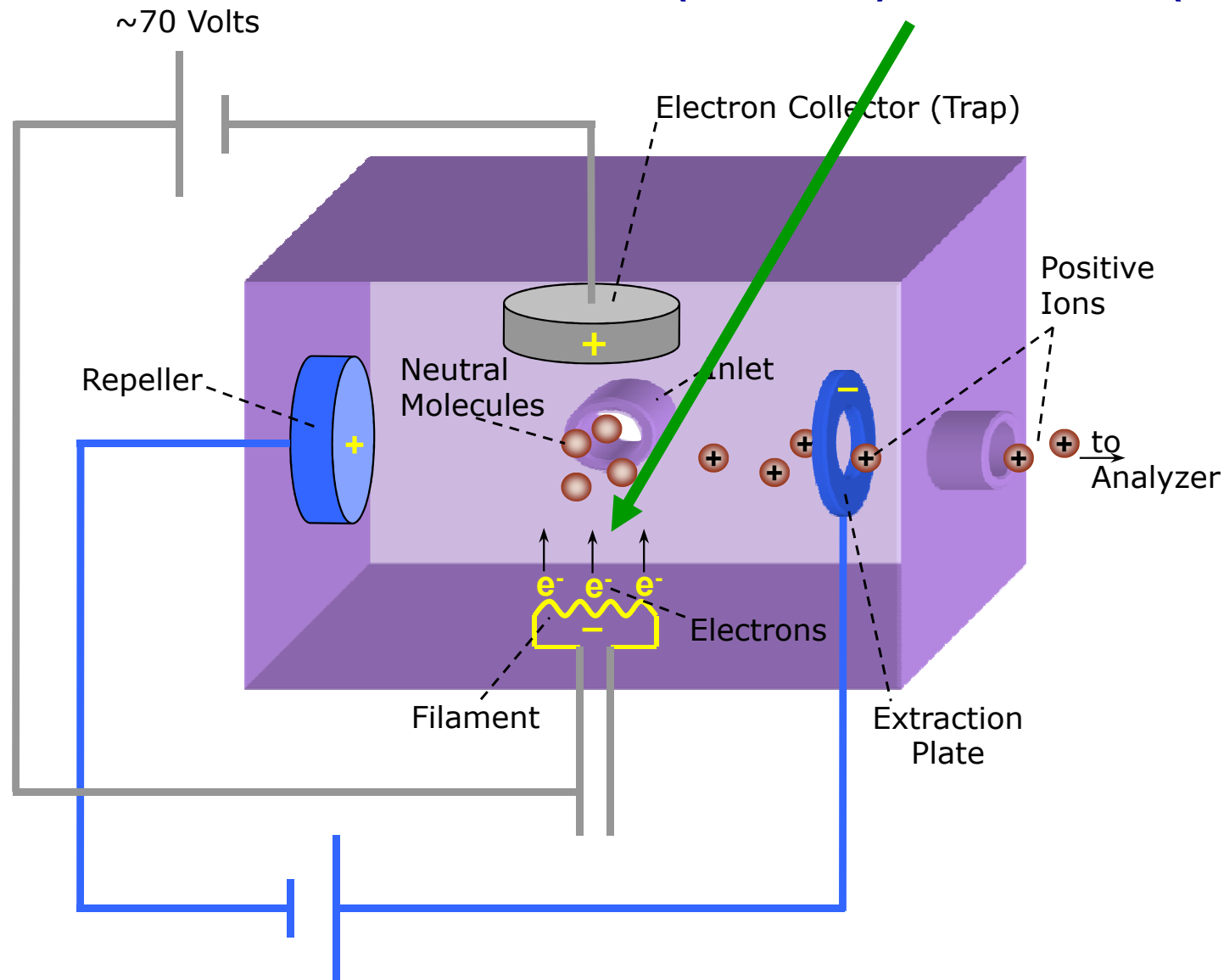

Electron Impact Ionization Source

The electrons are accelerated towards an anode (electron trap)

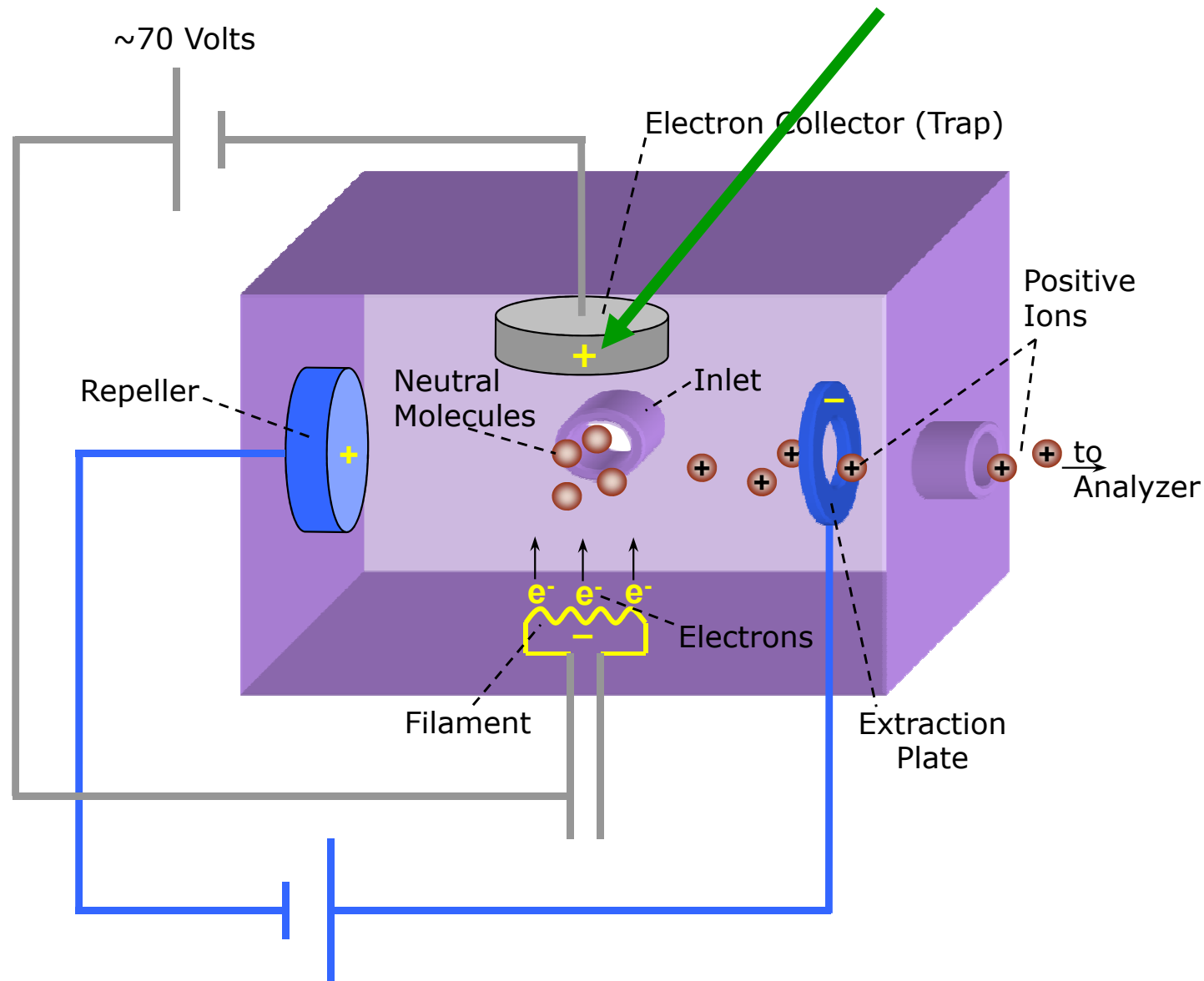

Electron Impact Ionization Source

Energy of e^- : 15 to 100 eV;
70 eV is usually used for scanning
mass spectra

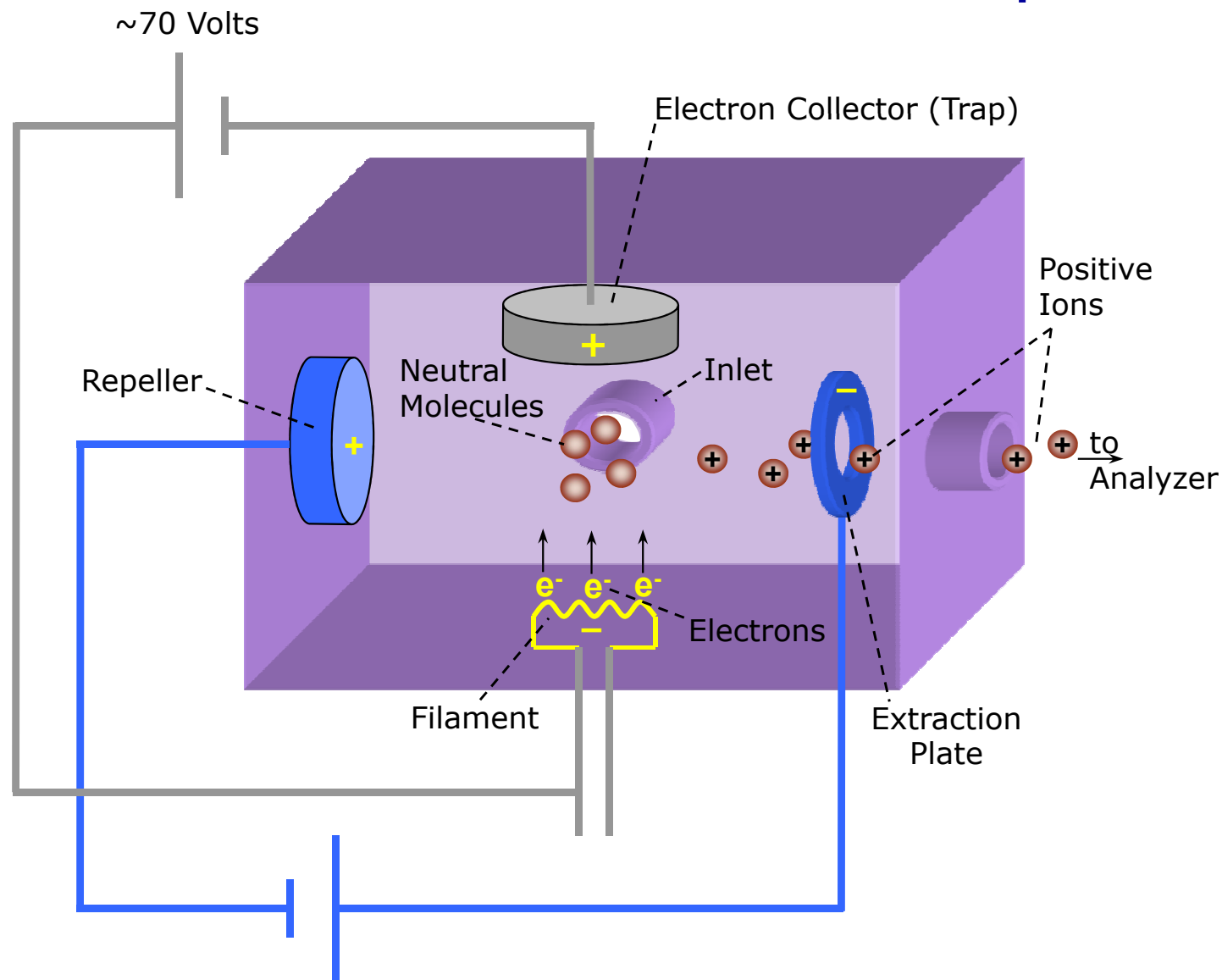

Electron Impact Ionization Source

On their path they collide with gaseous molecules injected into the ion source or eluted from a GC/LC column

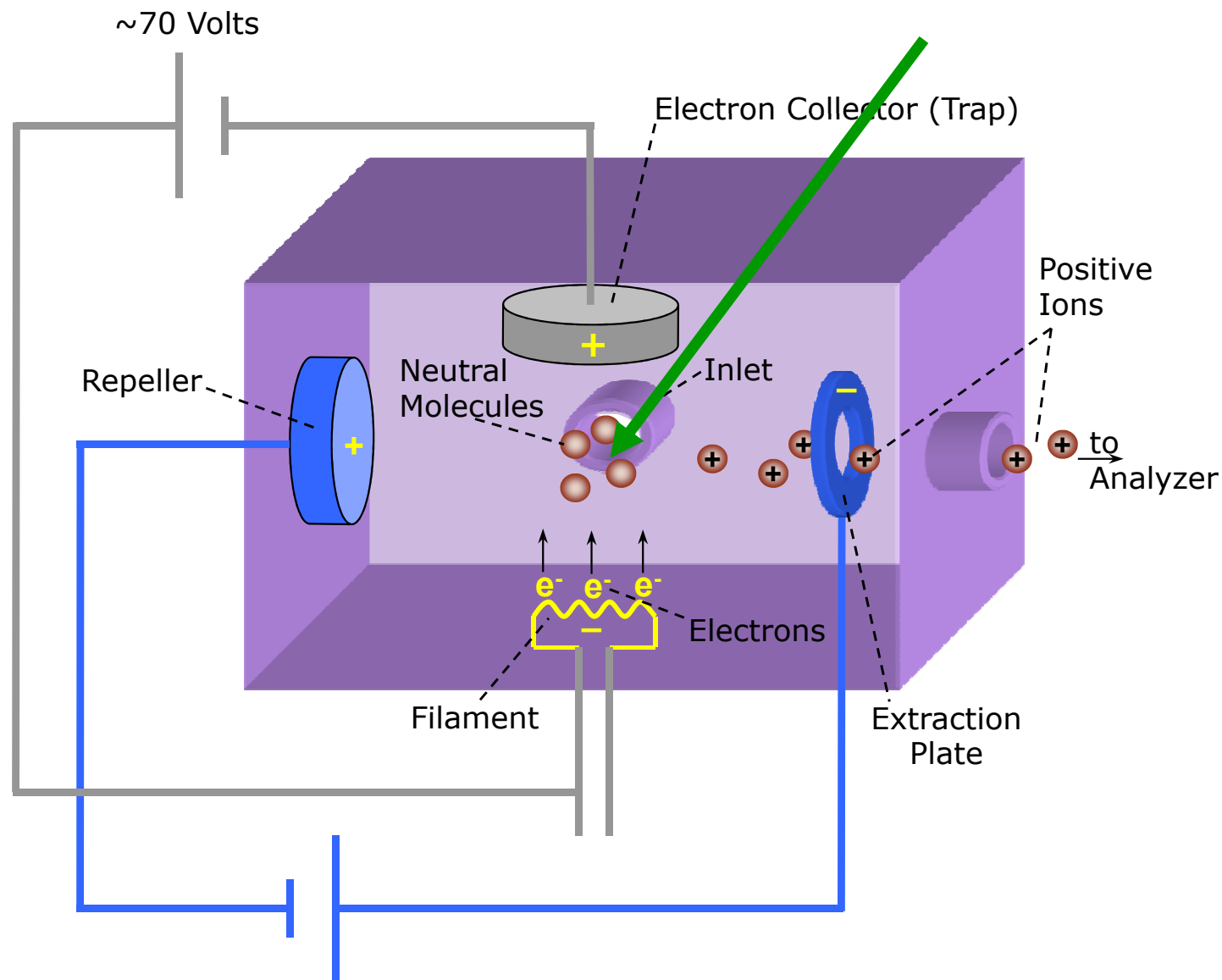

On average, one ion is produced for 1000 molecules entering the ion source at 70 eV

Electron Impact Ionization Source

10 to 20 eV out of those 70 eV are transferred to the molecules during the ionization process;

Since ~ 10 eV are enough to ionize most organic molecules the excess energy leads to extensive fragmentation;

Hence EI is classified as a „hard“ ionization technique

The fragmentation gives structural information

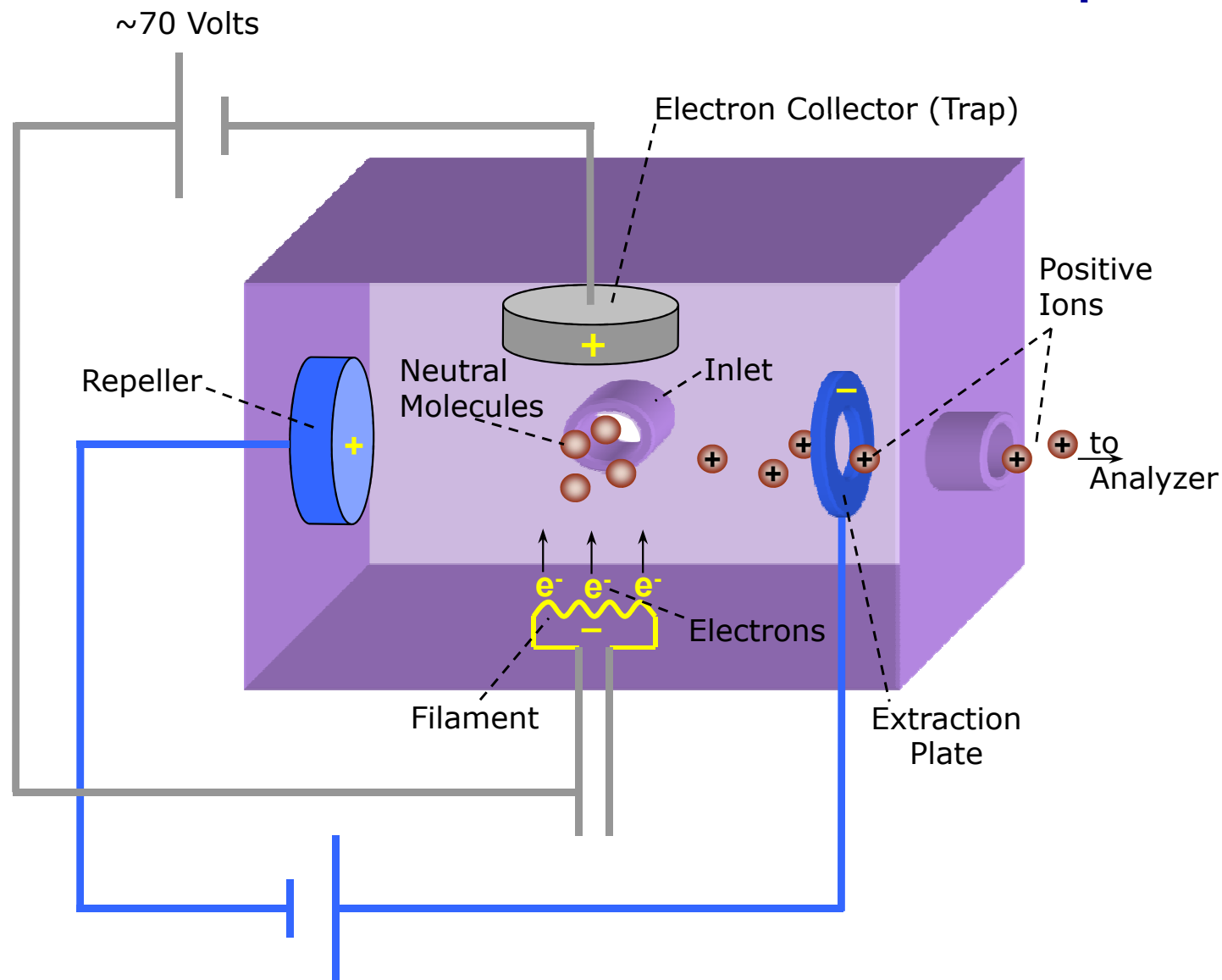

Electron Ionization

- One of the oldest and simplest methods (1930 – 1950)
- Applicable for vaporizable samples only, e.g. compounds with low molecular weight (< 1000 Da), less polar organic molecules
- Advantages:
 - Unimolecular fragmentation (ions spend 1 μs in EI source)
 - Reproducible technique
- Disadvantages:
 - Sometimes M^+ is not observed due to fragmentation
 - Almost impossible distinguish between isomers (GC separation needed)
 - Some compounds can undergo thermal decomposition before ionization because of high temperatures used to vaporize the sample
 - Inappropriate to too involatile compounds

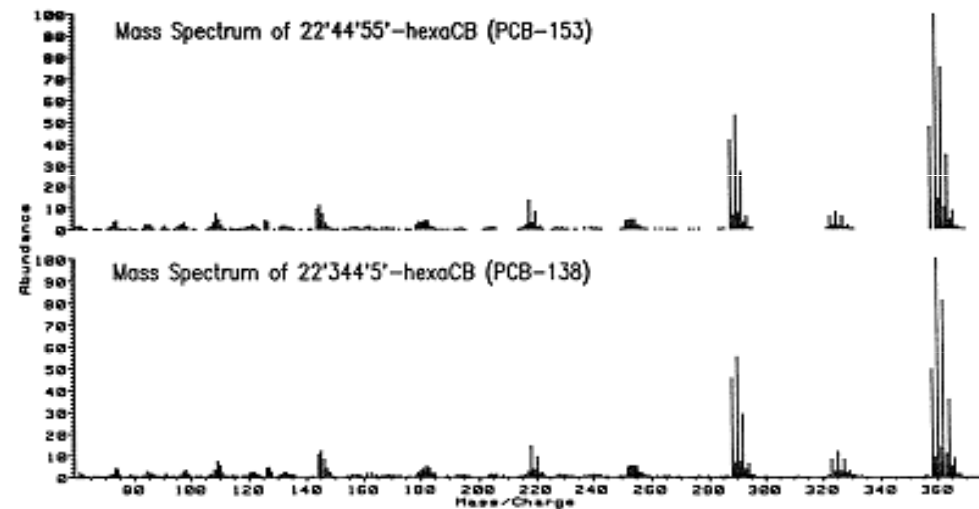

Schematic of Electron Ionization

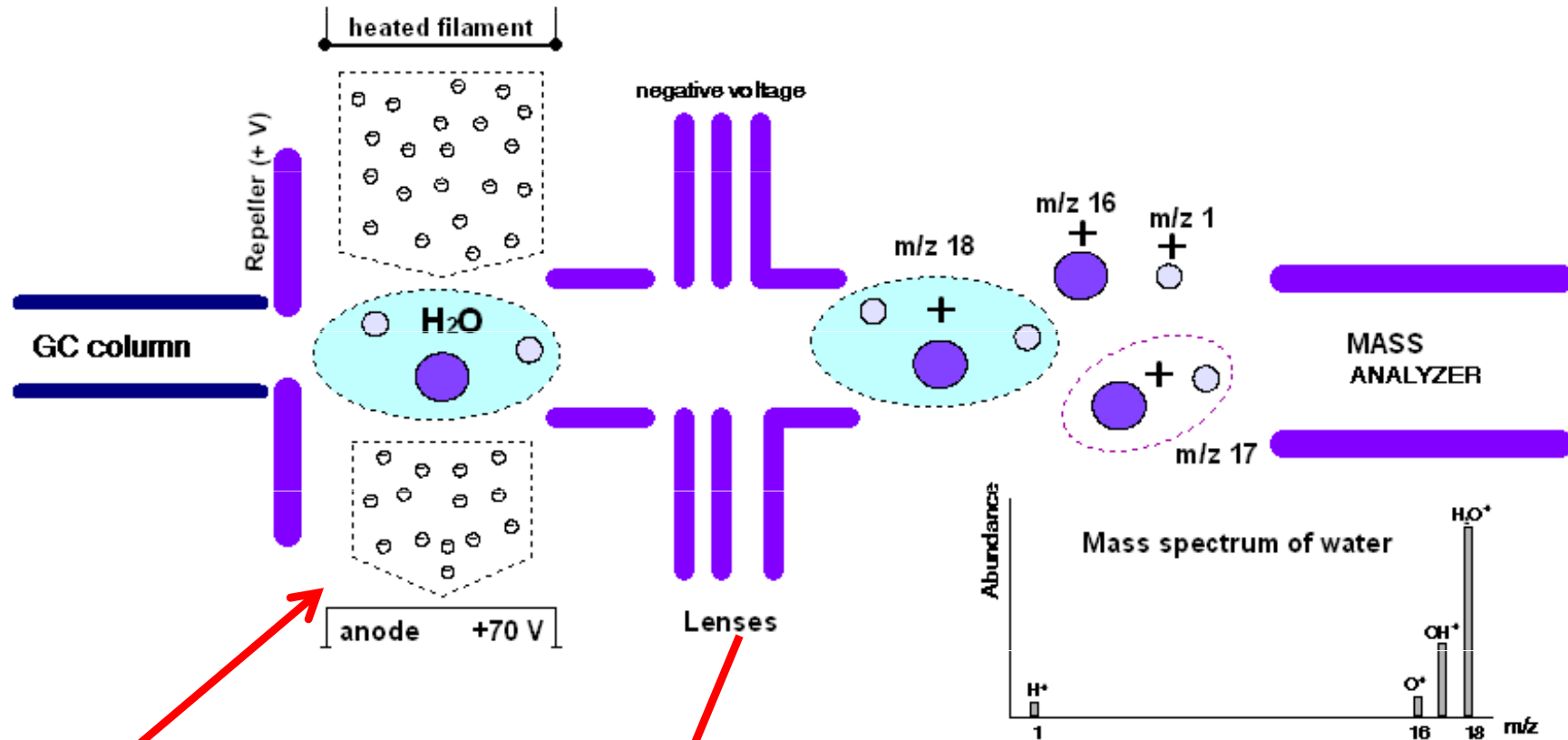

Ionization chamber

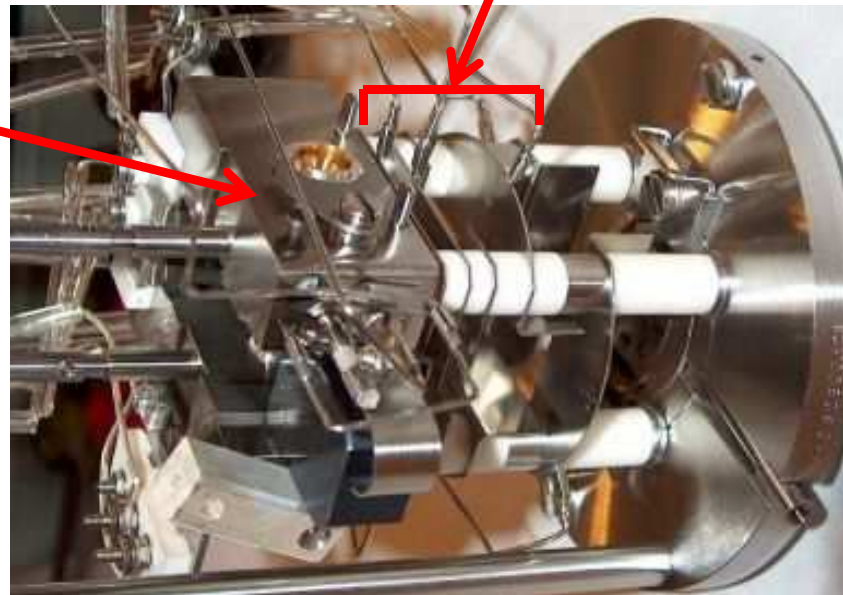

Positive Chemical Ionization

- Developed in the 1960s.
- Gaseous ions such as CH_5^+ , C_2H_5^+ , C_4H_9^+ , NH_4^+ , H_3^+ generated by electron impact from a large excess of a reagent gas, such as CH_4 , NH_3 , H_2 , or $i\text{-C}_4\text{H}_{10}$, interact with neutral molecules that may ionize.
- Generally, the amount of fragments is much less than in EI since little internal energy is imparted on the ionized molecule; Thus, the important molecular ion can be determined.
- Hence, CI is termed as „soft“ ionization technique.

Electrospray

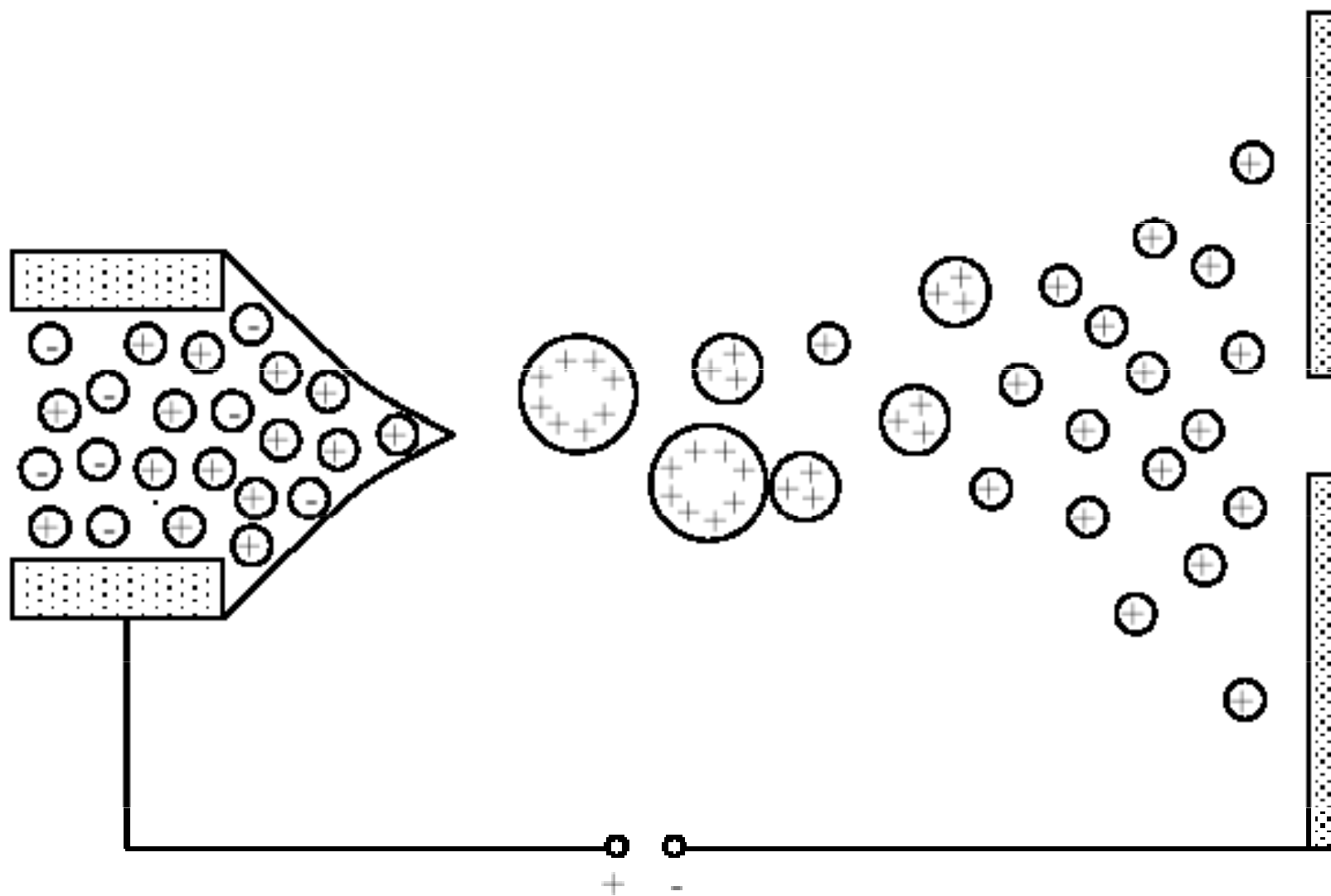

MALDI

Matrix-assisted Laser Desorption/Ionization (MALDI)

Sample embedded in light-absorbing matrix



LASER-excitation of matrix molecules

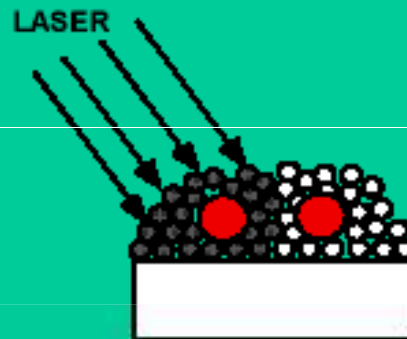

Sample desorption and protonation



BRUKER
DALTONICS[®]

Enabling Life Science Tools Based on Mass Spectrometry™

Magnetic Sector Mass Analyzer

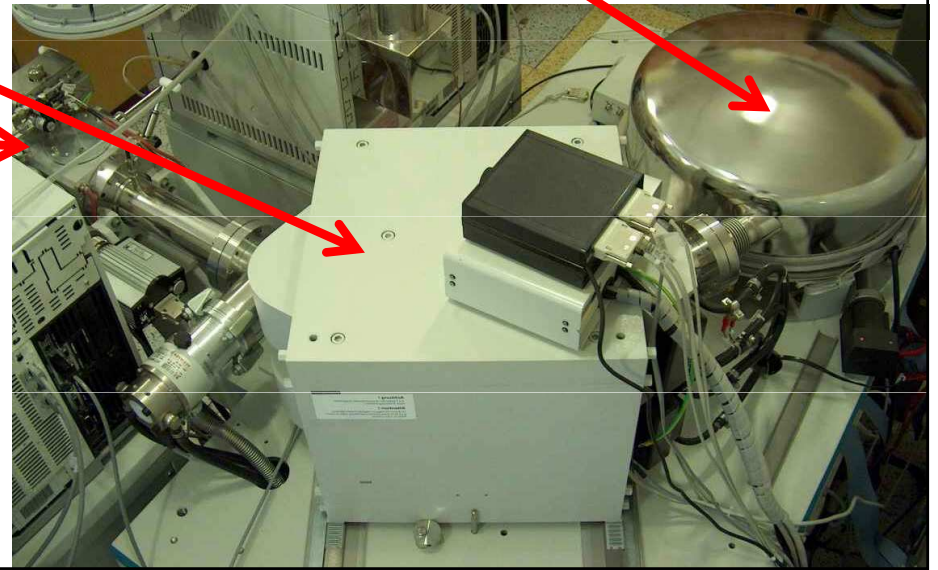
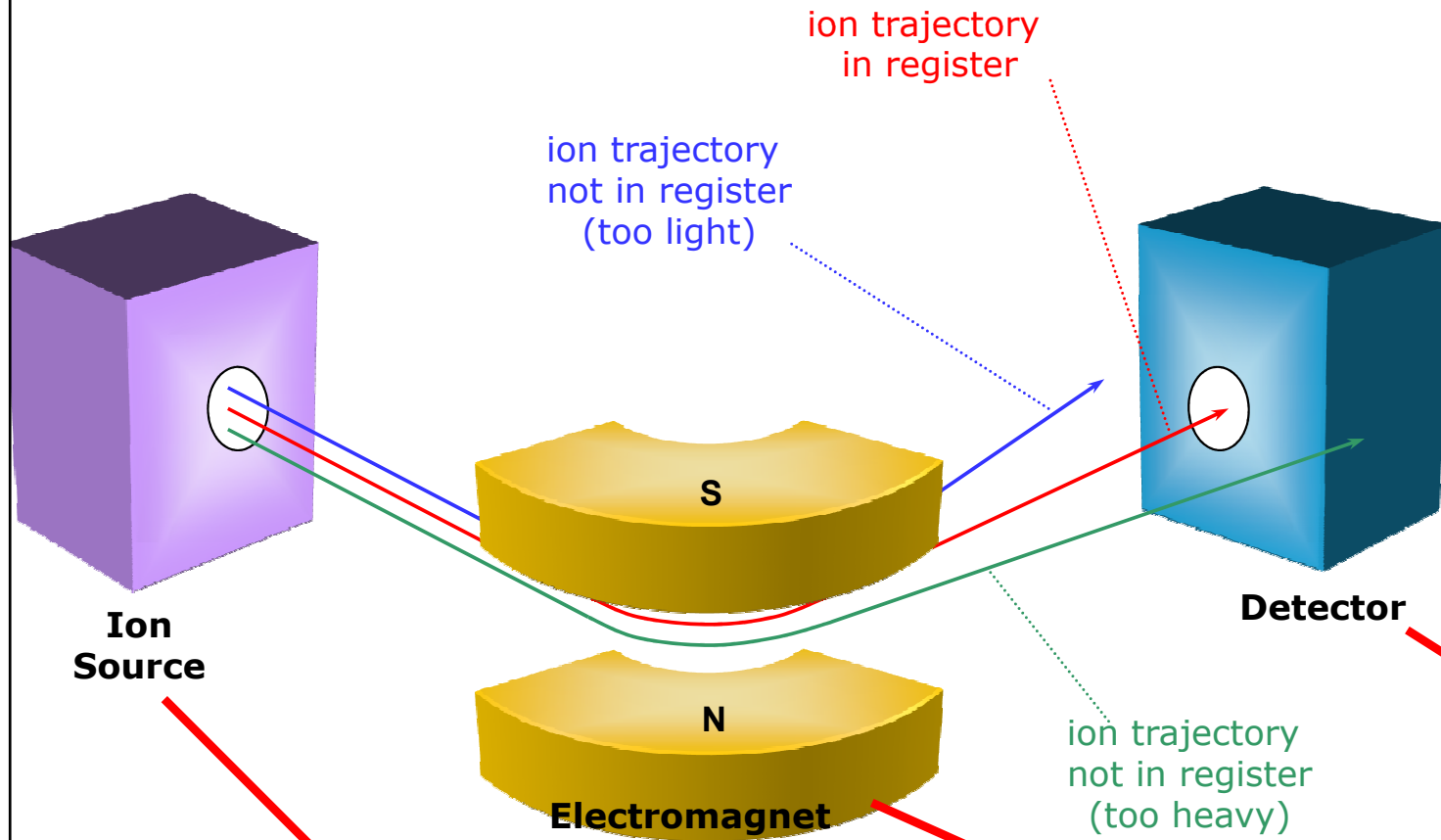

High Resolutionn MS Autospec-Ultima

- 3-sector instrument (2 electrostatic sectors, 1 magnetic sector)
- Mattauch-Herzog geometry

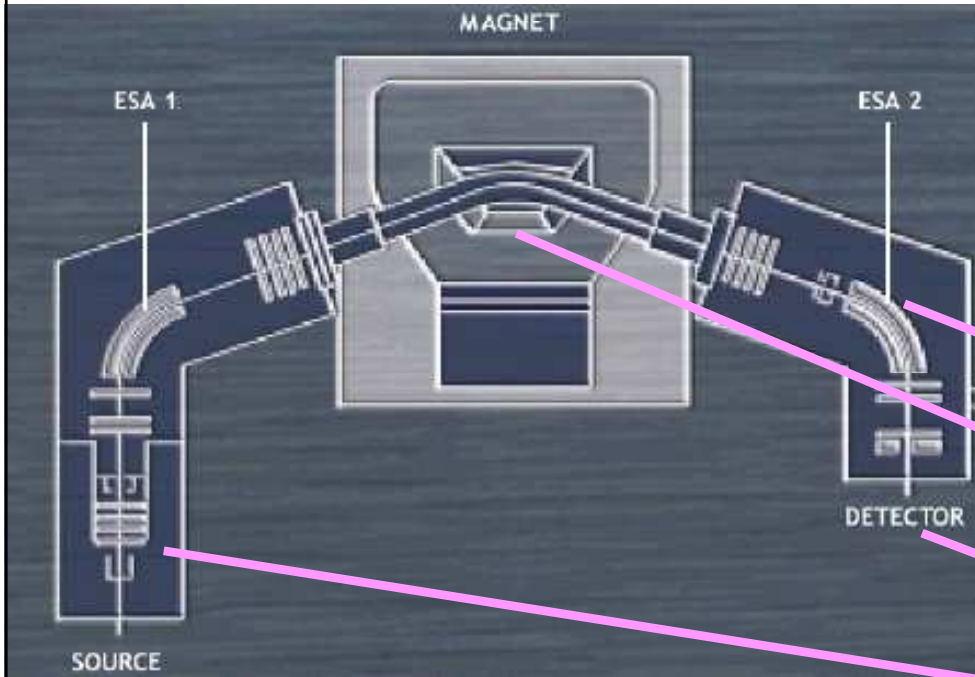

Dual HRGC / HRMS System

Rtx-2330

DB5-ms

MAT 95 XL

ThermoQuest
ANALYTICAL

Quadrupole Mass Filter

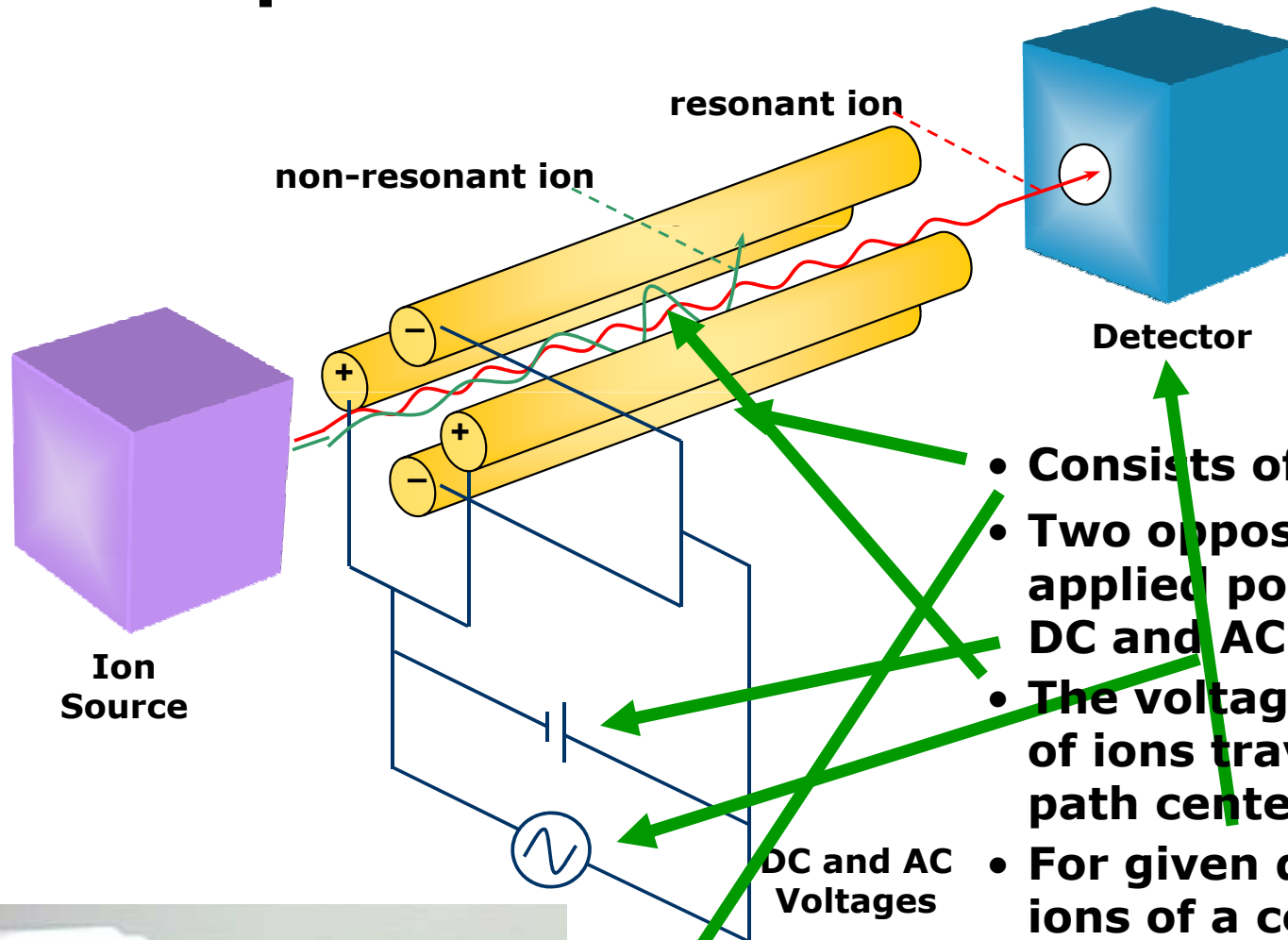

- Consists of 4 parallel metal rods.
- Two opposite rods have an applied potential combined from DC and AC voltages.
- The voltages affect the trajectory of ions traveling down the flight path centered between the rods.
- For given dc and ac voltages, only ions of a certain mass-to-charge ratio pass through the filter and all other ions are thrown out of their original path.
- A mass spectrum is obtained by monitoring the ions passing through the quadrupole filter as the voltages or frequency on the rods are varied.



Time-Of-Flight Mass Spectrometry (TOFMS)

- It uses differences in transit time through a drift region to separate ions of different masses
- An electric field accelerates all ions into a field-free drift region with the same initial kinetic energy for all the ions produced
- It operates in a pulsed mode so ions must be produced or extracted in pulses
- Since the ion kinetic energy is $0.5mv^2$, lighter ions have a higher velocity than heavier ions and reach the detector sooner (e.g., ions of m/z 500 arrive in $\sim 15 \mu s$ and m/z 50 in $\sim 4.6 \mu s$)
- By TOF-MS, up to 50 000 full spectra can be measured in a second
- Since full spectra are available, peak deconvolution software enabling to differentiate non-separated GC peaks may be applied
- The TOF ultra-fast scanning is suitable for fast GC where peak widths can be much less than a second

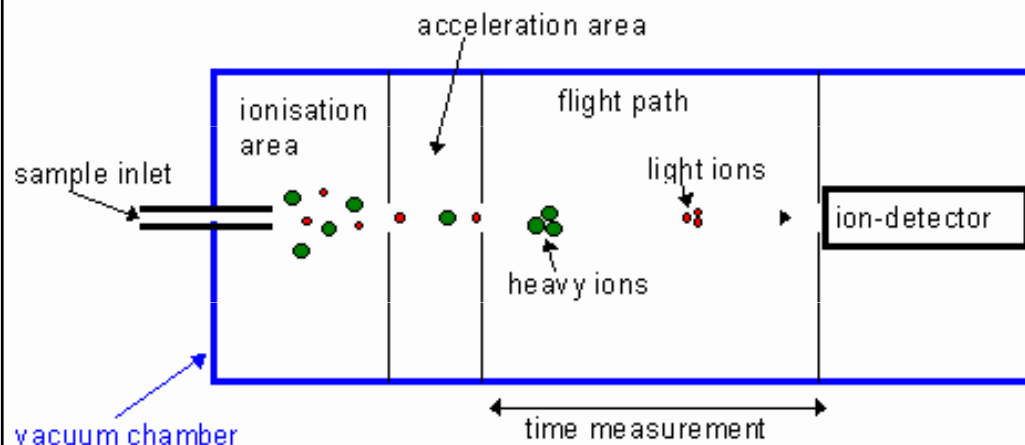
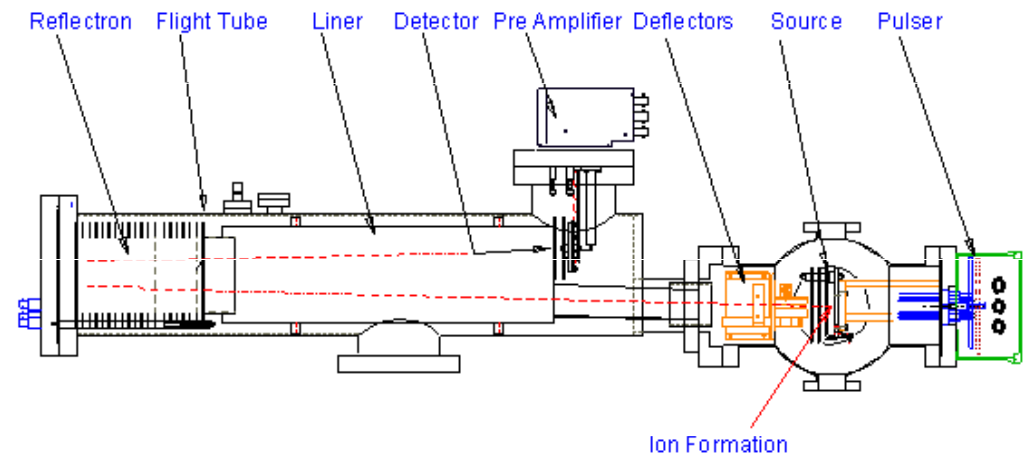

Ion Trap Mass Spectrometry

- The ion-trap analyzer consists of 3 electrodes with hyperbolic surfaces to trap ions in a small volume – the central ring electrode and 2 adjacent endcap electrodes. A mass spectrum is obtained by changing the electrode voltages to eject the ions from the trap.
- The advantages of the ion-trap mass spectrometer include compact size, and the ability to trap and accumulate ions to increase the signal-to-noise ratio of a measurement.
- This technique can be used easily in the MS/MS (MS^n) mode



Wolfgang Paul
1989 Nobel Prize
for Physics „for
the development
of the ion trap
technique“

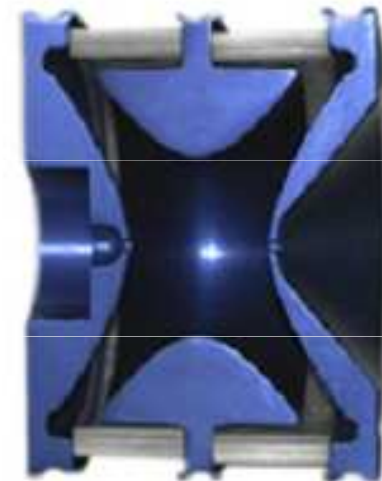
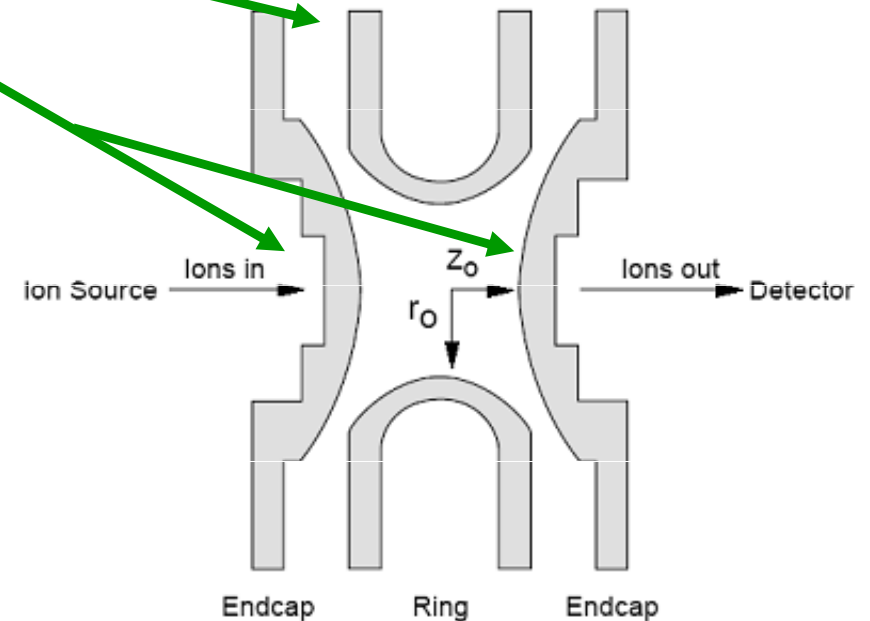

Electron Multiplier

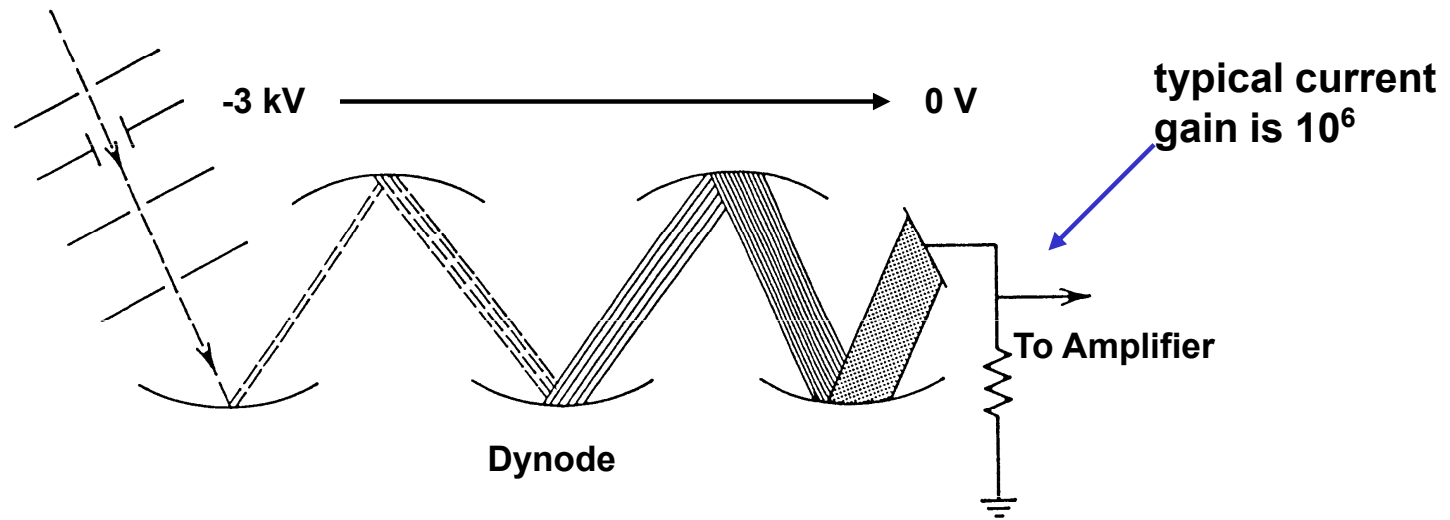

Discrete-dynode electron multiplier



Continuous-dynode electron multiplier

Vacuum System

Why needed?

- Mean free path of molecules
- Ion-molecular reactions
- Interferences in mass spectra
- Contamination of the ion source
- Glowing/sparking in the high-voltage area
- Burning of the filament

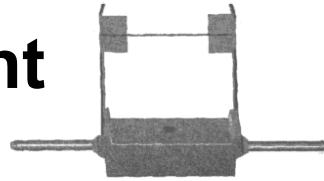

✓ Rough pumps



✓ Diffusion pumps



✓ Turbomolecular pumps

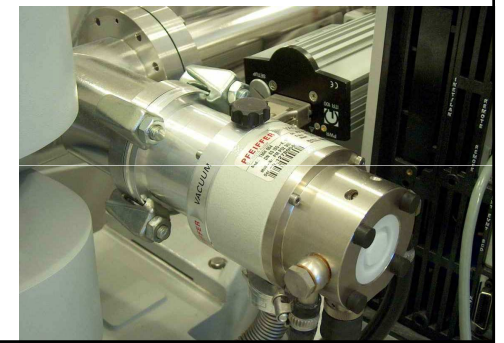

Mass Spectrum

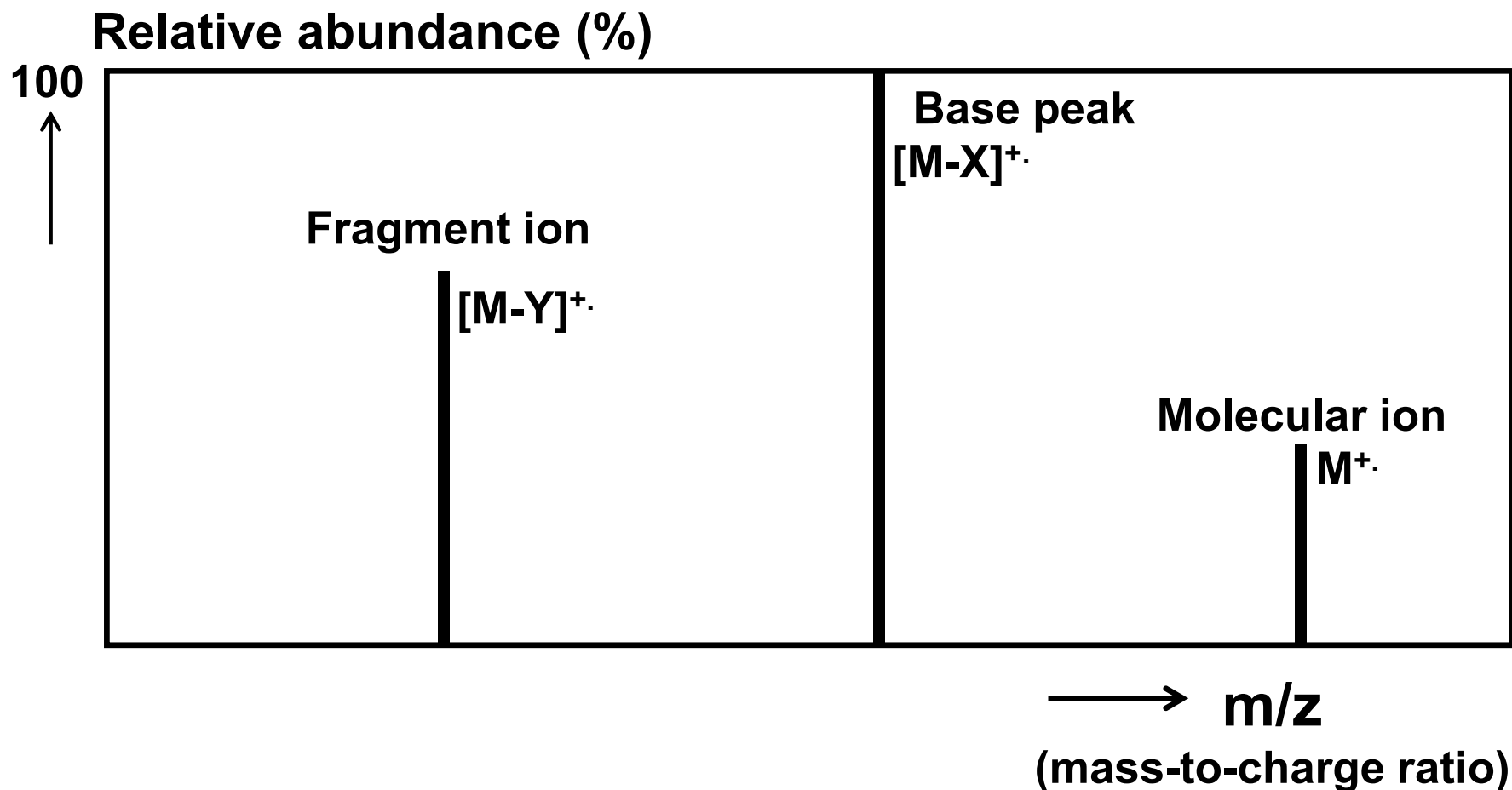

There are now Internet-accessible databases containing mass spectra of thousands of compounds, e.g.:

<http://www.aist.go.jp/RIODB/SDBS/menu-e.html>

<http://webbook.nist.gov>

Segment of the Real Signal (not computer-processed) of a Mass Spectrum (n-cethyl amine – $C_{16}H_{33}NH_2$)

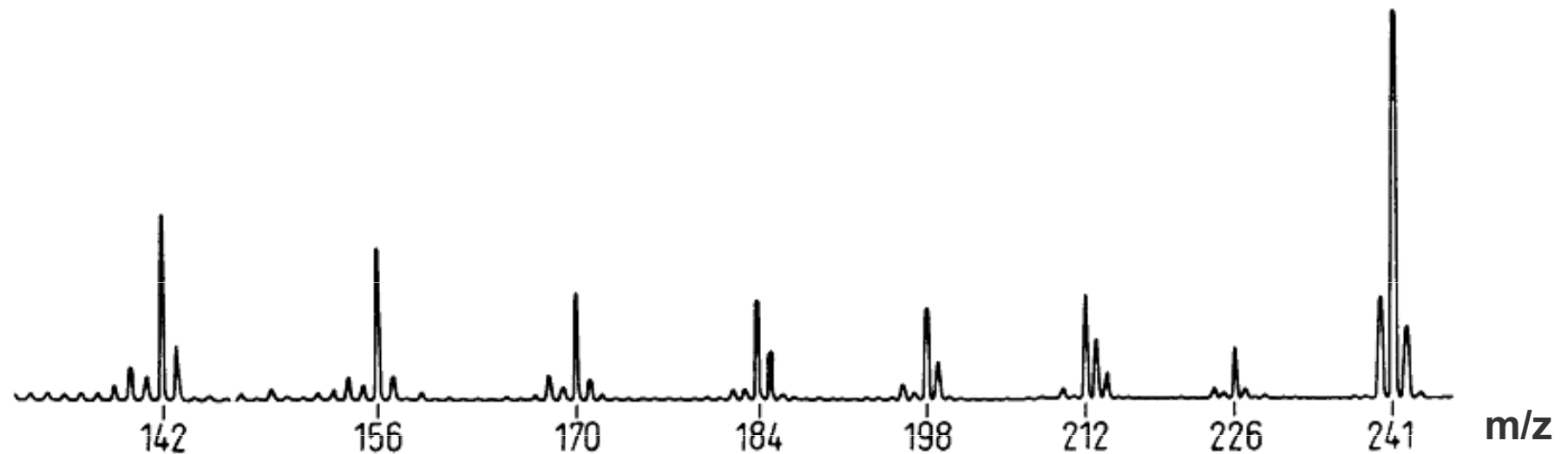

- Such a Gauss-shaped peaks are processed by a computer program to be converted to the line spectrum

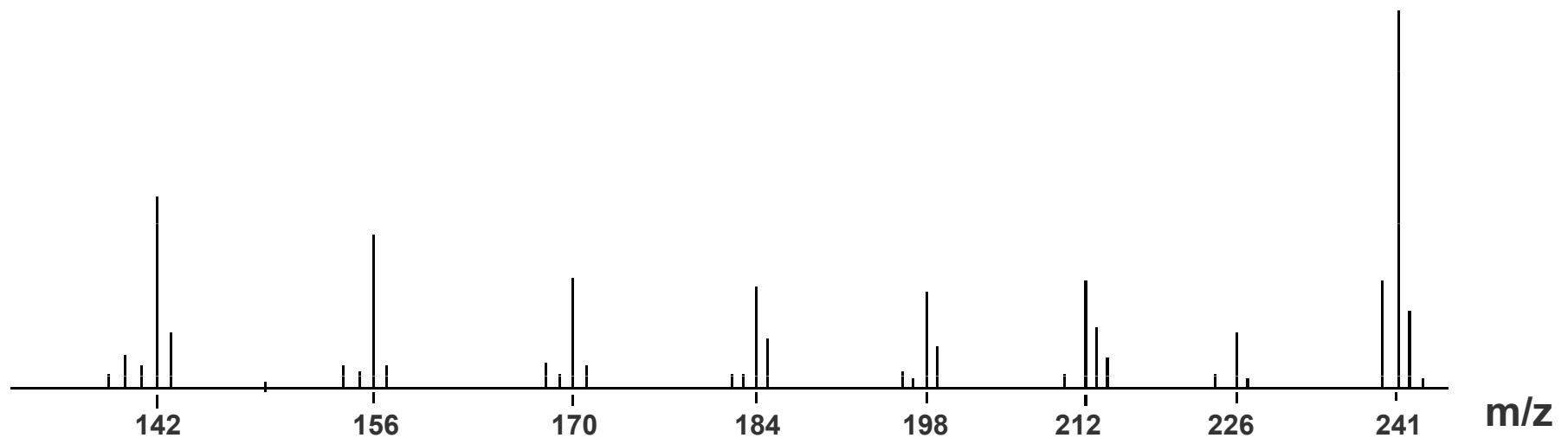

GC-MS Uses

- **Identification and quantification of volatile and semivolatile organic compounds in complex mixtures**
- **Determination of molecular weights and (sometimes) elemental composition of unknown organic compounds in complex mixtures**
- **Structural determination of unknown organic compounds in complex mixtures both by matching their mass spectra with reference spectra and by a priori spectral interpretation**

When to Use HRMS ?

- **For the determination of the exact masses of ions in spectra (peak matching) – suitable for the determination of elemental composition**
- **Decreasing interferences caused by the ions of co-extracted compounds or by GC column bleeding and thus, to improve considerably the signal-to-noise ratio**

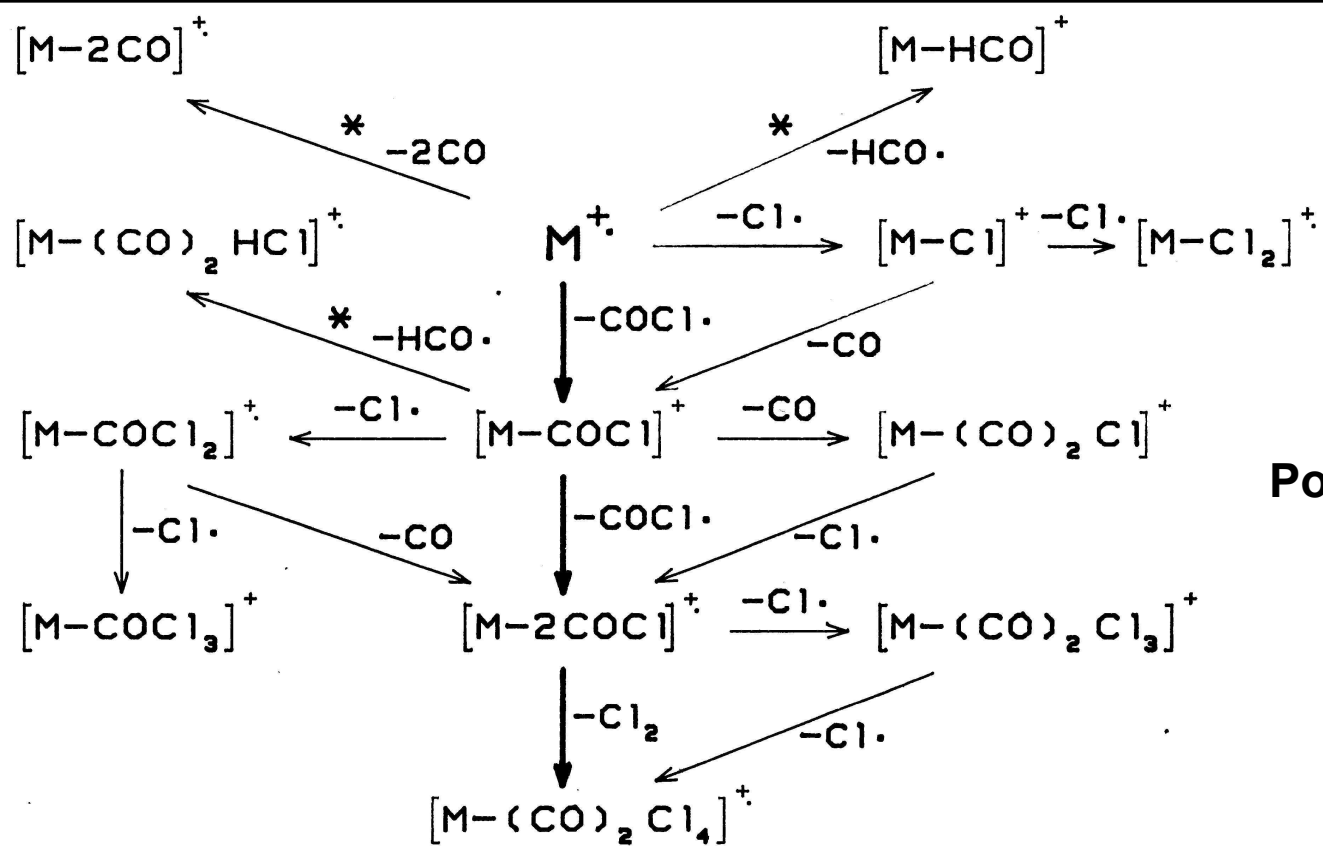

* fragmentation for lower chlorinated congeners

Polychlorinated dibenzofurans

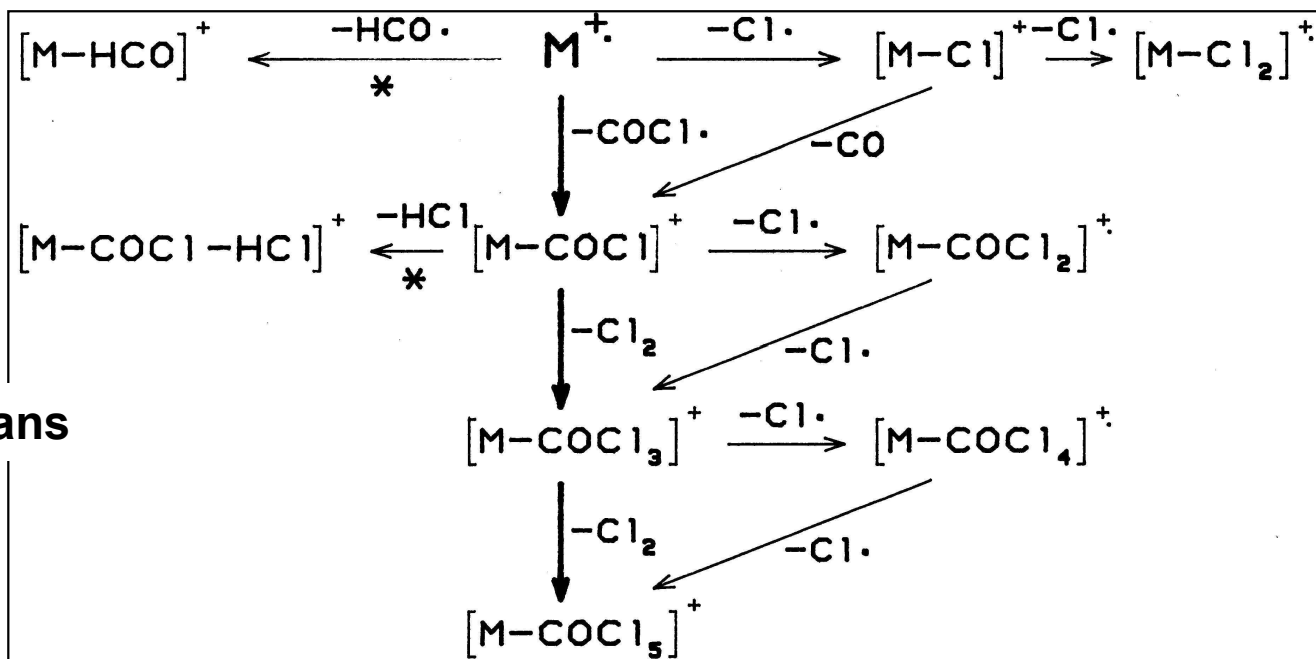

Demonstration of Mass Spectrometric Resolution (10% Valley Definition)

$$R_{10\%} = m / \Delta m$$

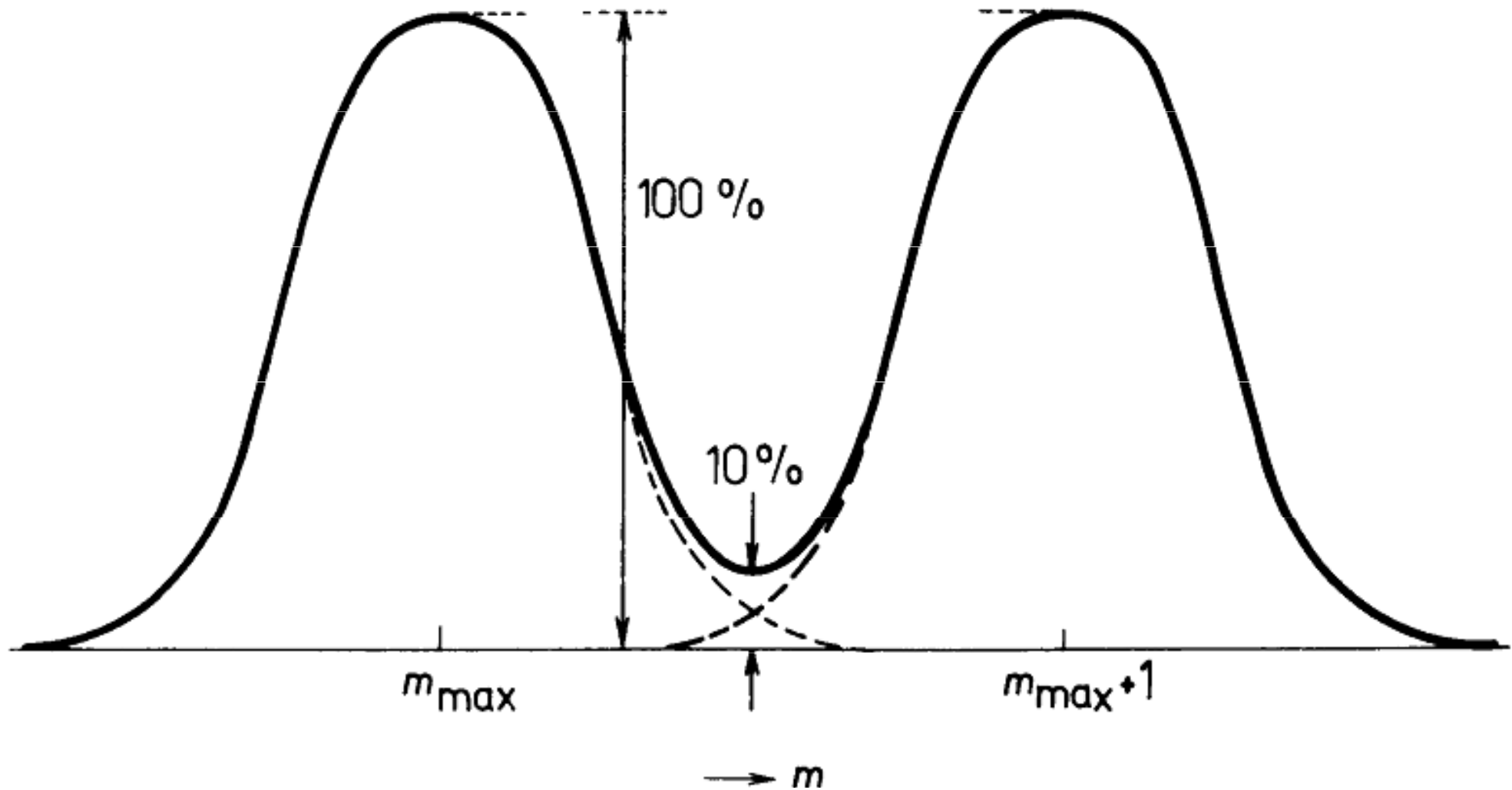

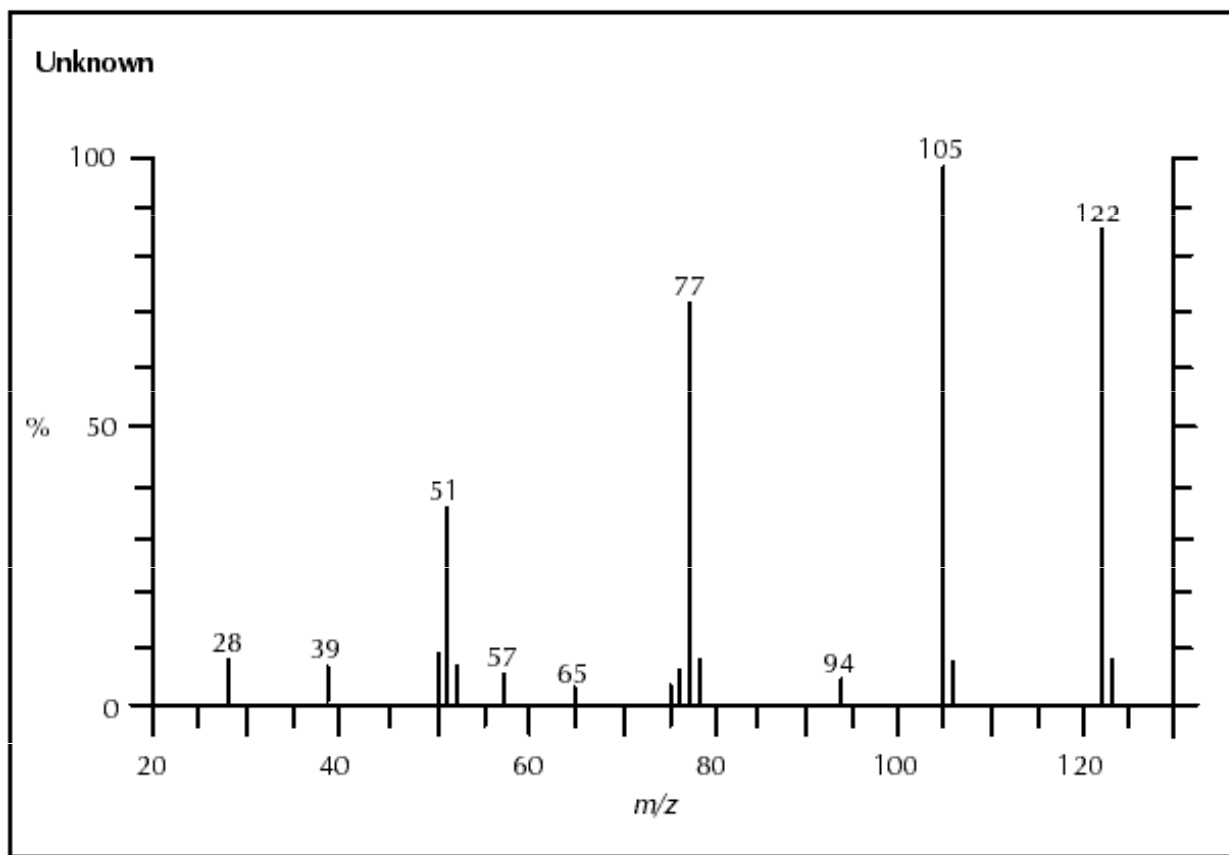

Some formulae corresponding to nominal $m/z = 122$

Formulae	Actual mass
$C_4H_4N_5$	122.046668
$C_4H_{10}O_4$	122.057903
$C_6H_4NO_2$	122.024201
$C_6H_6N_2O$	122.048010
$C_6H_8N_3$	122.071819
$C_7H_6O_2$	122.036776
C_7H_8NO	122.060585
$C_7H_{10}N_2$	122.084394
$C_8H_{10}O$	122.073161
$C_8H_{12}N$	122.096970
C_9H_{14}	122.109545

These are based on the following relative atomic masses:

C =	12.0000000
H =	1.0078246
N =	14.0030738
O =	15.9949141

- In general, more ions have the same nominal mass
- To distinguish between them certain MS resolution is needed

- For example, to separate these 2 ions we need a resolution of 5 124

$$R = (122.060585 - 122.036776) / 122 = 5\ 124$$

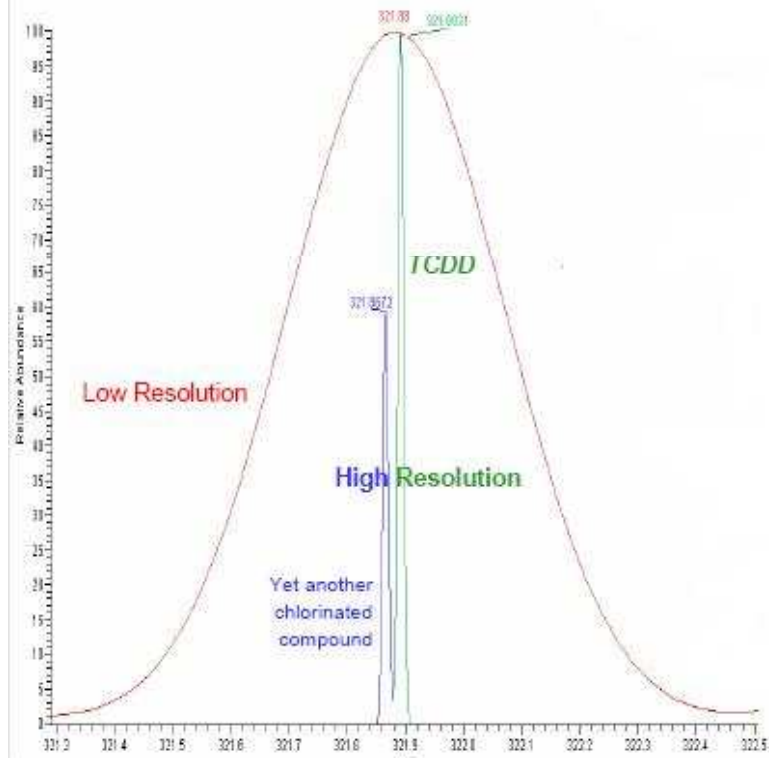

Low Resolution (Quadrupol)

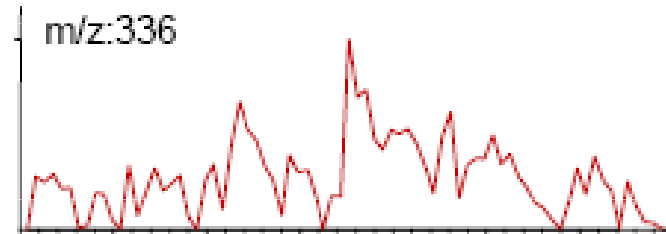
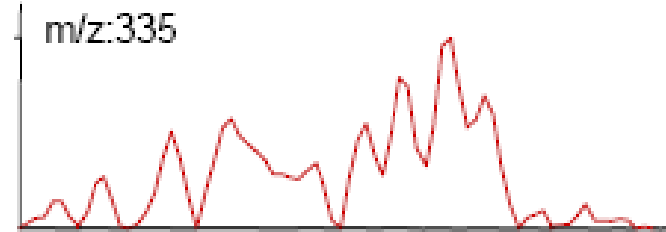

3:10 3:15 3:20 3:25 3:30 3:35

High Resolution

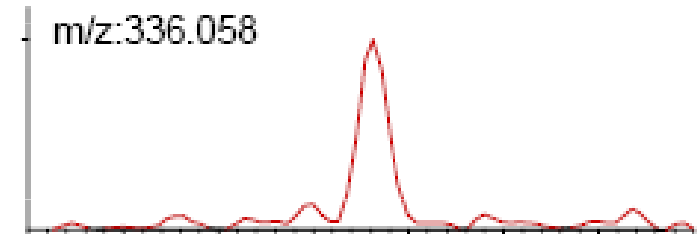
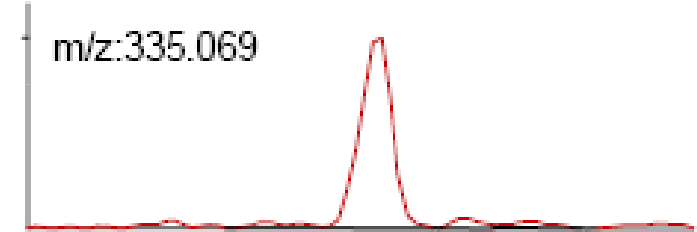

3:10 3:15 3:20 3:25 3:30 3:35

Prvek	“M”		“M+1”		“M+2”		Typ prvku
	m/z	%	m/z	%	m/z	%	
H	1	100	2	0.015	-	-	“M”
C	12	100	13	1.1	-	-	“M+1”
N	14	100	15	0.37	-	-	“M+1”
O	16	100	17	0.04	18	0.2	“M+2”
F	19	100	-	-	-	-	“M”
Si	28	100	29	5.1	30	3.4	“M+2”
P	31	100	-	-	-	-	“M”
S	32	100	33	0.79	34	4.4	“M+2”
Cl	35	100	-	-	37	32	“M+2”
Br	79	100	-	-	81	97.3	“M+2”
I	127	100	-	-	-	-	“M”

<u>m/z</u>	<u>Int.</u>
35	12.0
36	100.0
37	4.1
38	33.0

HCl

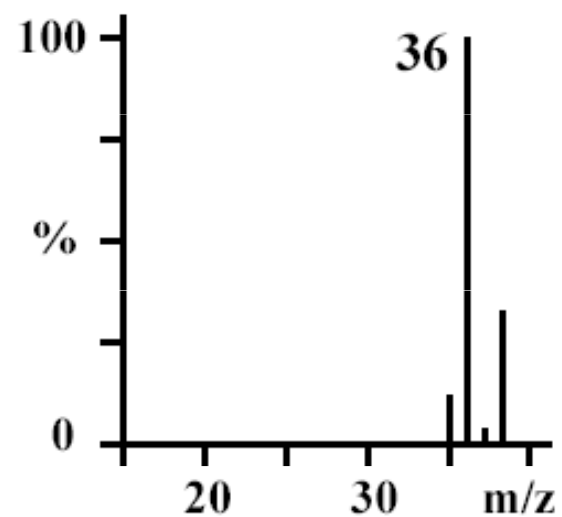

<u>m/z</u>	<u>Int.</u>
94	100.0
95	1.1
96	96.0
97	1.1

CH₃Br

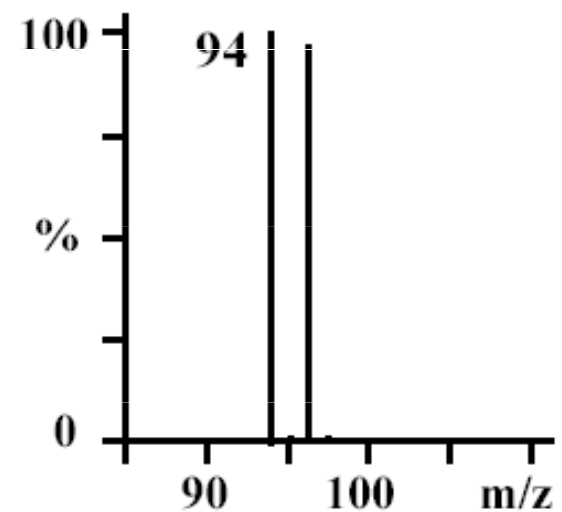

No. 1

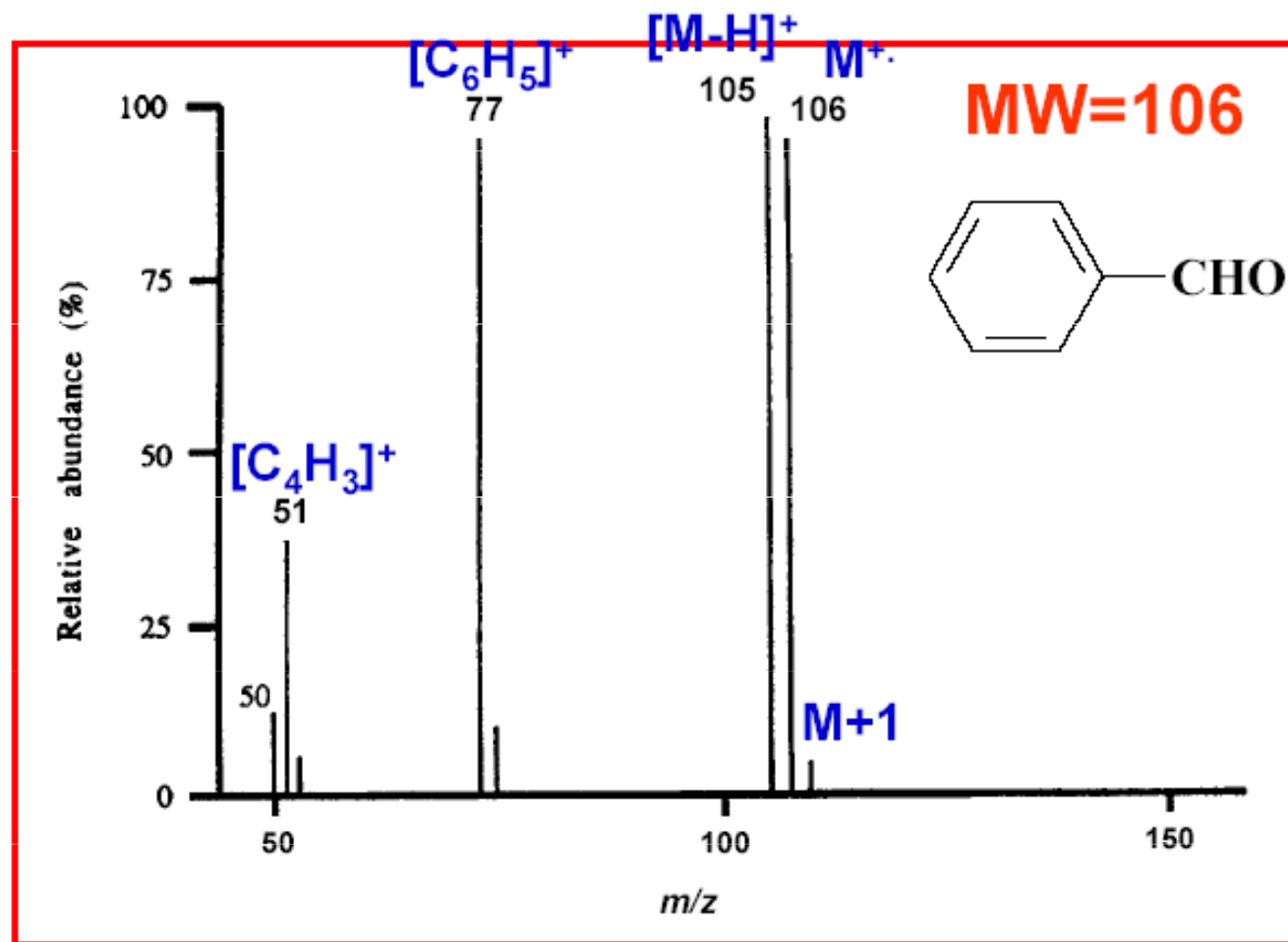

No. 2

$$M+1 = 4.2 / 64.1 * 100 = 6.6\% : 1.1 = 6 * C$$

$$M+2 = 63.7 / 64.1 * 100 = 99.4\% = Br$$

<i>m/z</i>	% Relative abundance
50	17.2
51	38.9
74	3.2
75	5.7
76	5.7
77	100.0
78	7.8
156	64.1
157	4.2
158	63.7
159	3.8

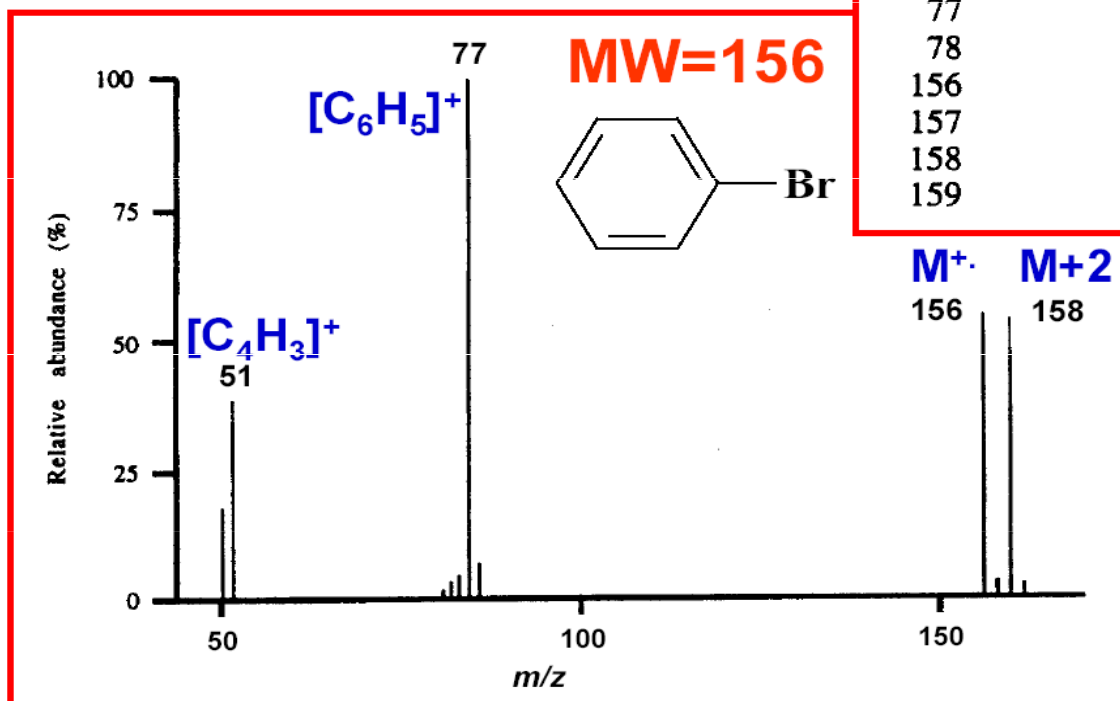

No. 3

m/z	%	m/z	%
14	1.4	44	2.6
15	10.2	50	1.3
26	6.4	51	1.8
27	56.9	53	2.5
28	16.1	55	8.0
29	61.2	56	44.8
30	1.3	57	100.0
39	27.3	58	4.5
40	4.2	71	5.2
42	38.8	86	14.0
43	78.0	87	0.9

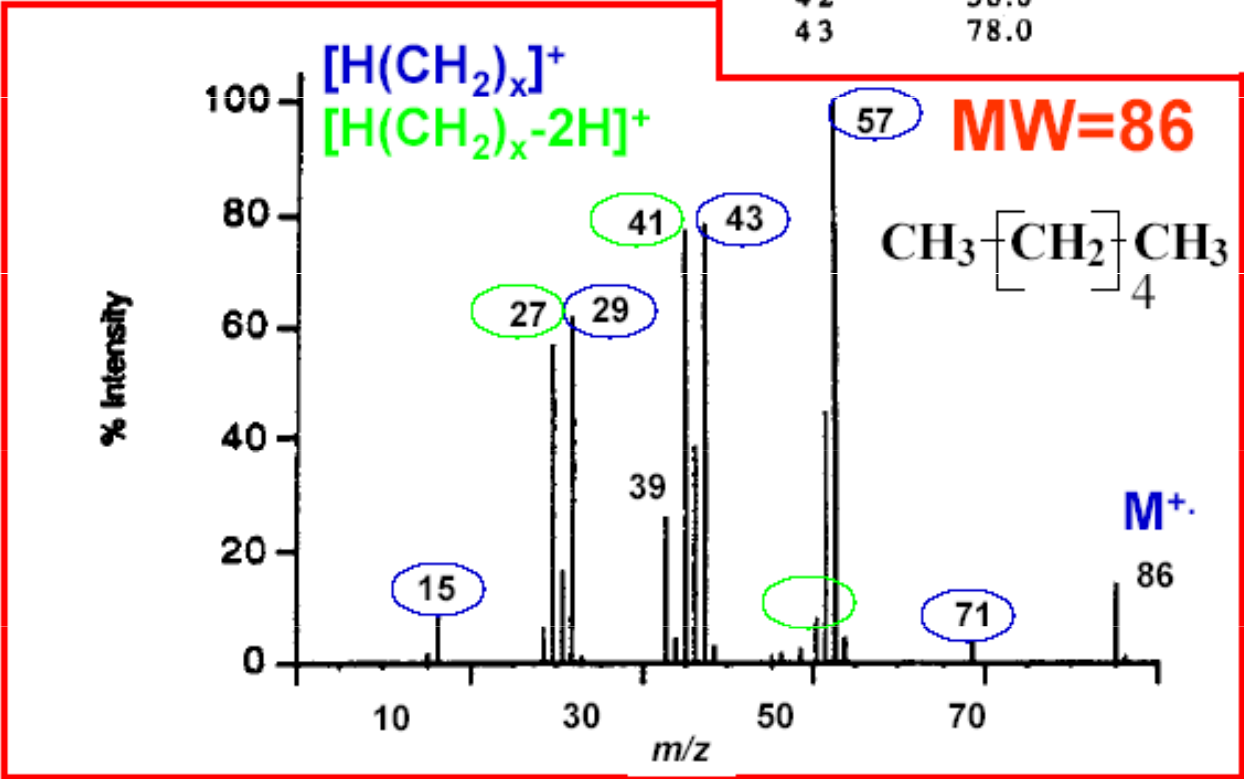

Relative Abundances of the Combinations of Halogen Isotopes

- Fluorine and iodine are monoisotopic
- However, chlorine is present in the nature as ^{35}Cl (75.8%) and ^{37}Cl (24.2%), and bromine as ^{79}Br (50.5%) and ^{81}Br (49.5%)
- Therefore molecular ions (or fragment ions) containing various numbers of Cl and/or Br atoms give rise to typical patterns spaced 2 amu apart based on a combination of $(a+b)^n$; for Cl a is 75.8%, b 24.2% and n is the number of chlorine substituents in a molecule

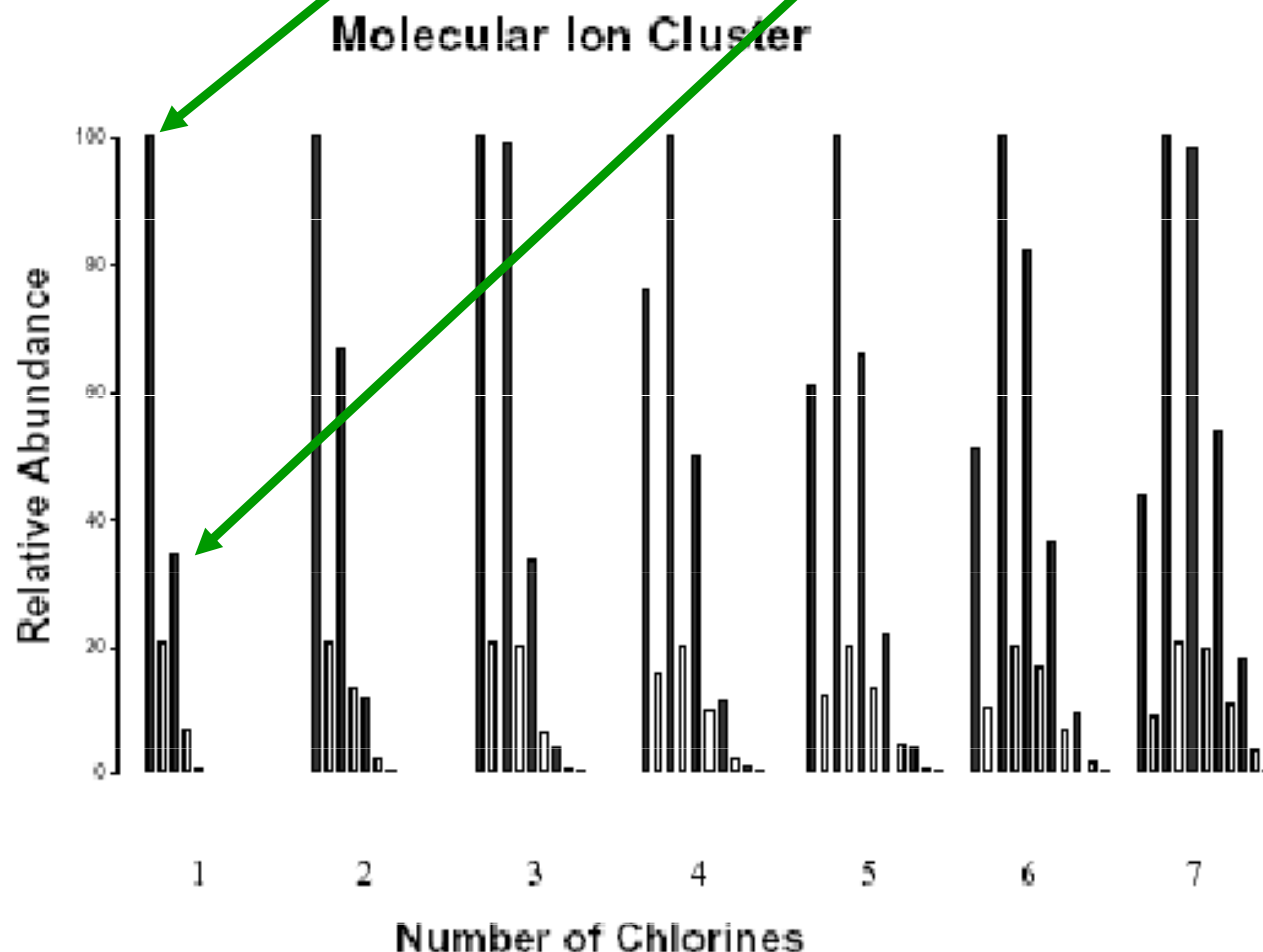

Upper Segment of 2378-TCDD Mass Spectrum

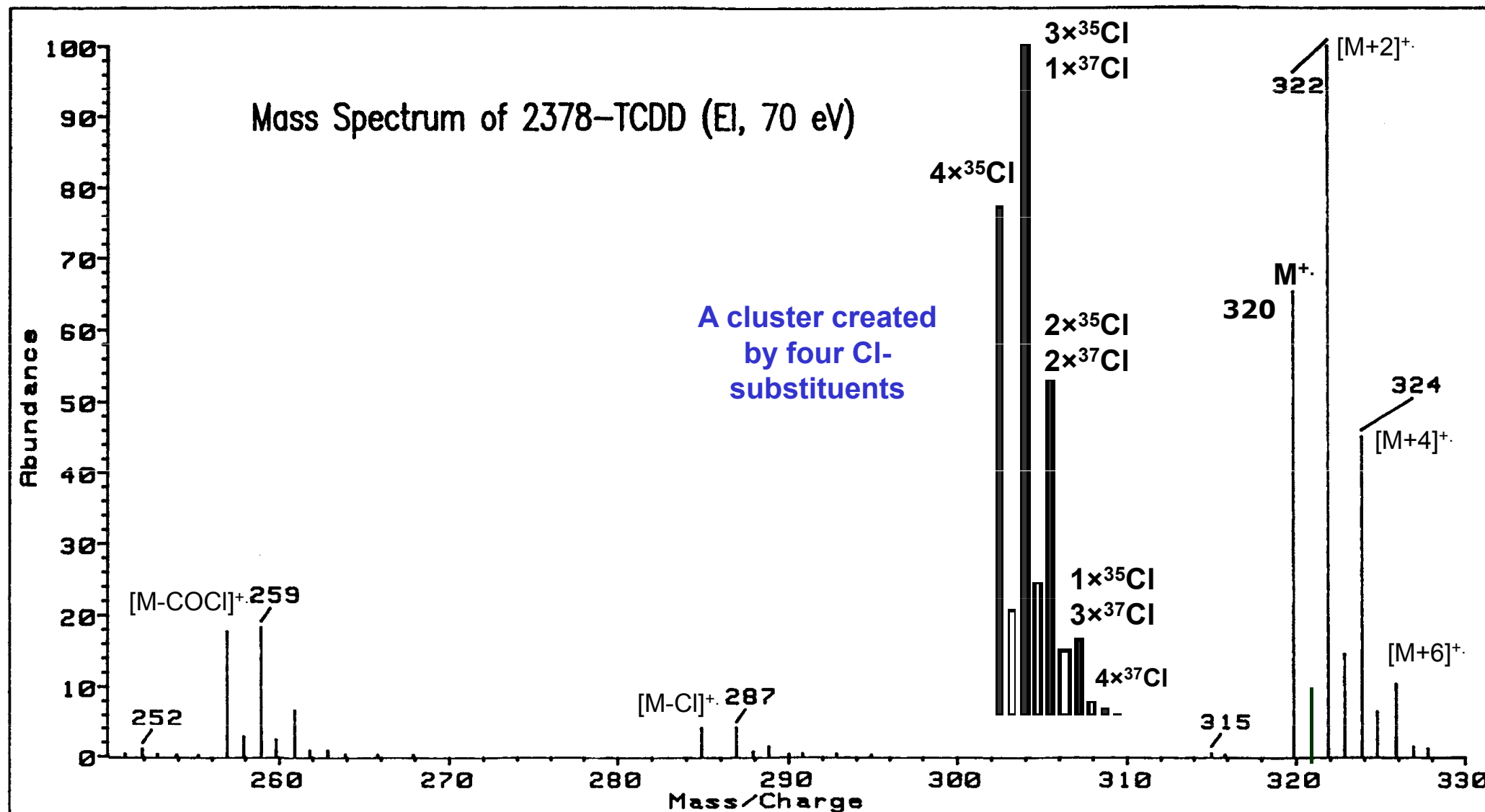

What is the SCAN Mode in Mass Spectrometry ?

- The **scanning** mode provides mass spectra. They are recorded (scanned) at regular intervals (typically 0.5 – 1 /s; much faster if TOFMS is used) during the GC separation and stored in the instrument data system for subsequent qualitative or quantitative evaluation.
- From mass spectra, it is often possible to deduce structural features (mass spectral interpretation) but this requires experience and can be very time-consuming, particularly as a complex mixture might contain hundreds of components.

- The spectra can also be compared with those stored in mass spectral libraries. Although library searching is a very useful and timesaving technique, it is important to remember that such searches do not identify compounds – analysts do!

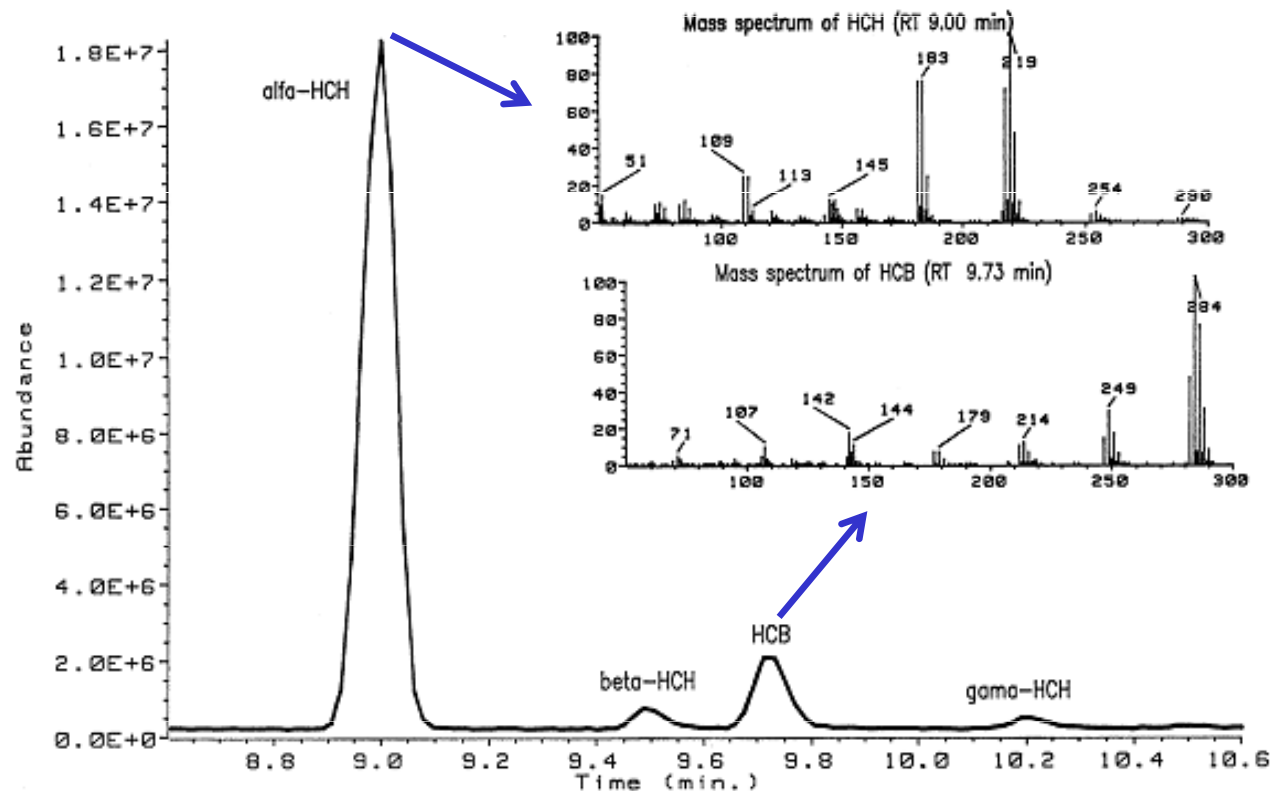

What is the SIM (or MID) Mode in Mass Spectrometry ?

- SIM (Selected Ion Monitoring) or MID (Multiple Ion Detection) is much more sensitive technique suitable for trace quantitative analysis. Here, instead of scanning a whole spectrum, only a few ions (generally, the most abundant but characteristic selected from the mass spectrum) are detected during the GC run.
- This can result in as much as a 500-fold increase in sensitivity, at the expense of selectivity. Depending on the analyte, low picogram to even low femtogram amounts can be measured using this powerful technique.
- Stable isotope-labeled internal standards can be employed.

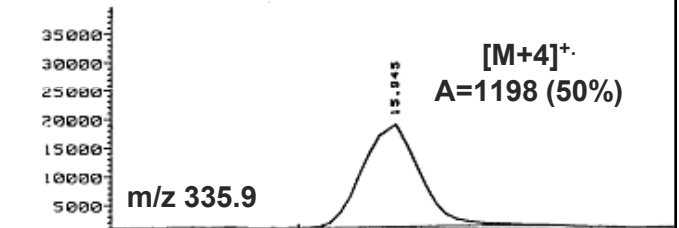
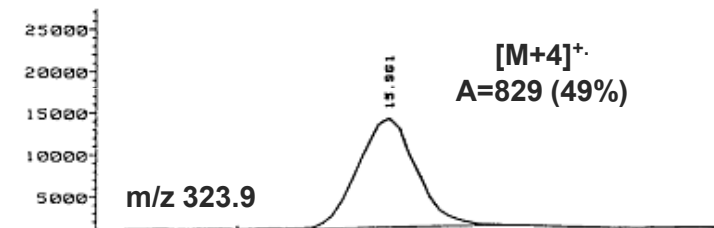
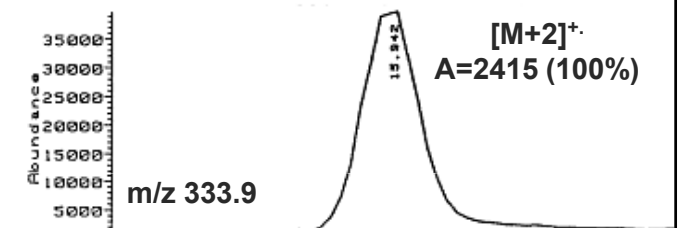
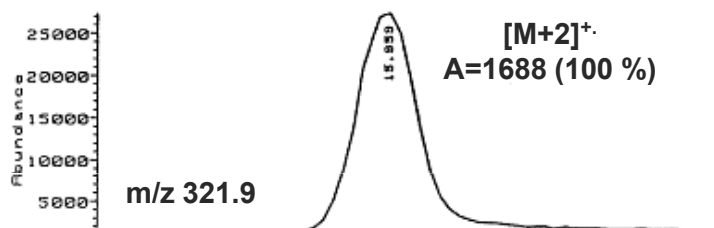
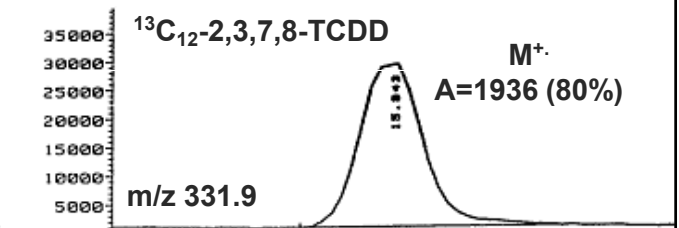
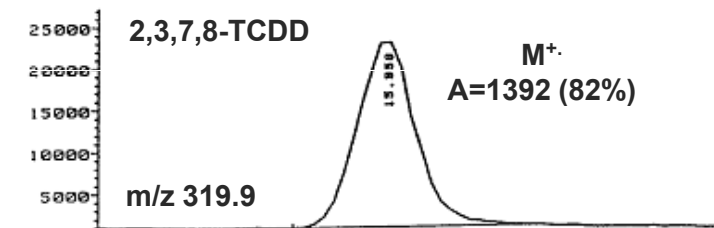
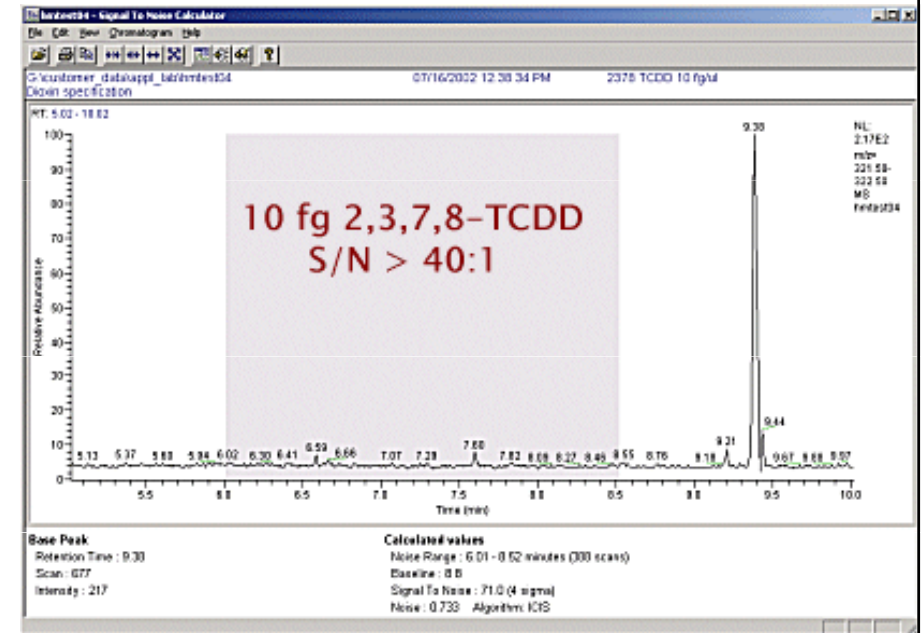

HRMS/LRMS-SIM chromatogram from the analysis of 2378-TCDD in a soil extract by the isotope dilution method

The Use of the Isotope Dilution HRGC/HRMS in the SIM Mode

CHRO: 1613-dB5-1-t0013 09-Apr-02 Elapse: 20:30.5 1
 Samp: Vial 4 T0014.flyash.DIOX fr.pr.0026 Start: 17:19:15 2587
 Conn: DB5ms#29, 5.04g, 250ulES(1-2), 20ulDS(1)
 Mode: EI +VE +LMR ESCAN LR NRM Study: 7th Intercalibratio
 Oper: AK, c.a.891 Client: van Bavel Inlet: GC Vial 4

CHRO: 1613-dB5-1-t0015 10-Apr-02 Elapse: 20:30.6 1
 Samp: Vial 7 T0015.ryba.DIOX fr.pr.0045 Start: 12:21:34 2587
 Conn: DB5ms#29, 0.26893, 5.12299, 100ulES(1-2), 20ulDS(1)
 Mode: EI +VE +LMR ESCAN LR NRM Study: 7th Intercalibratio
 Oper: AK, c.a.806 Client: van Bavel Inlet: GC Vial 7

TetraCDDs

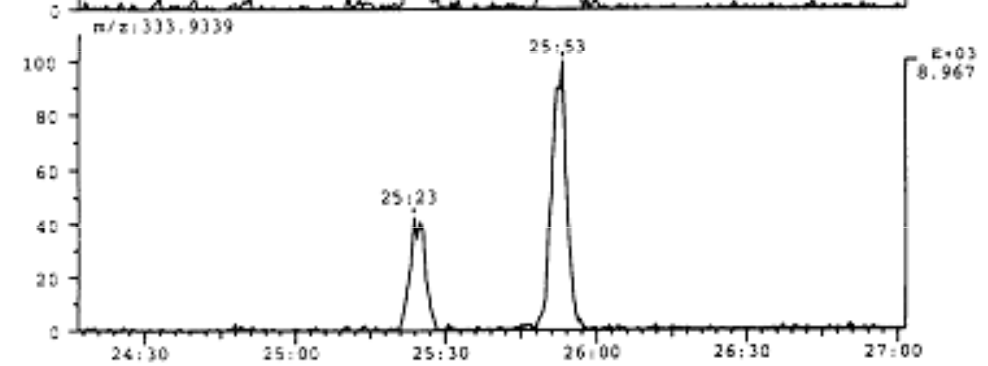
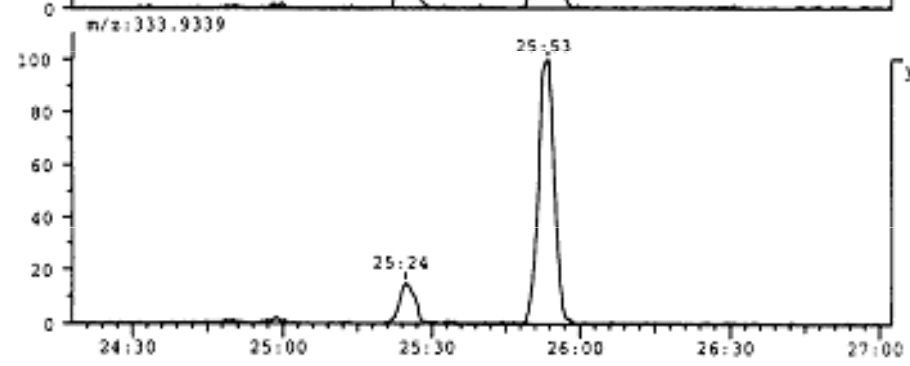
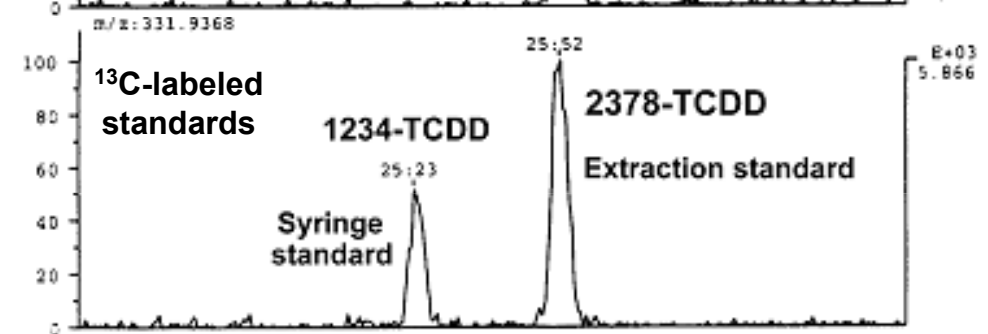
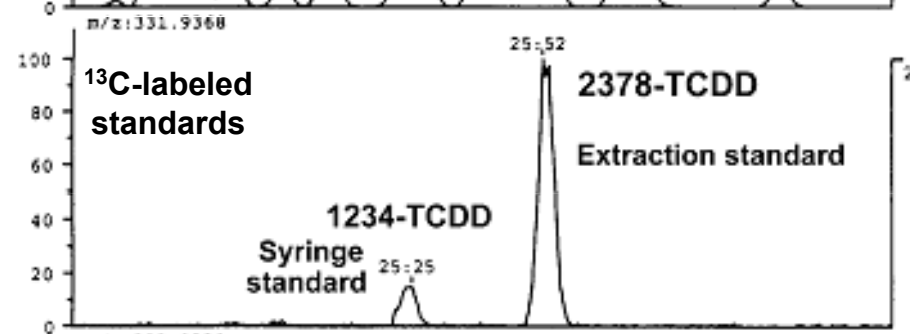
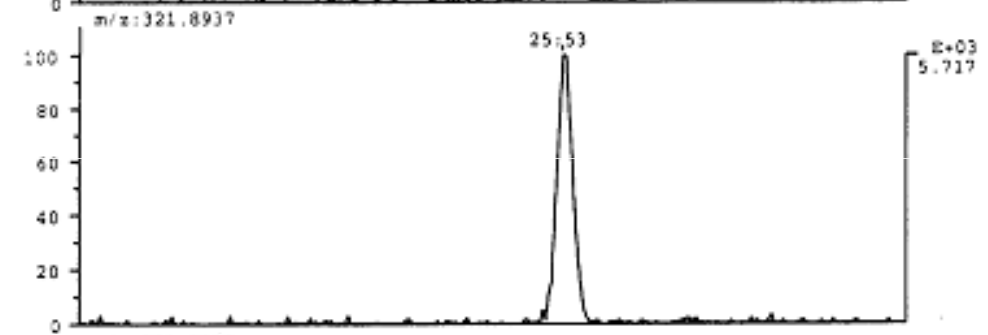
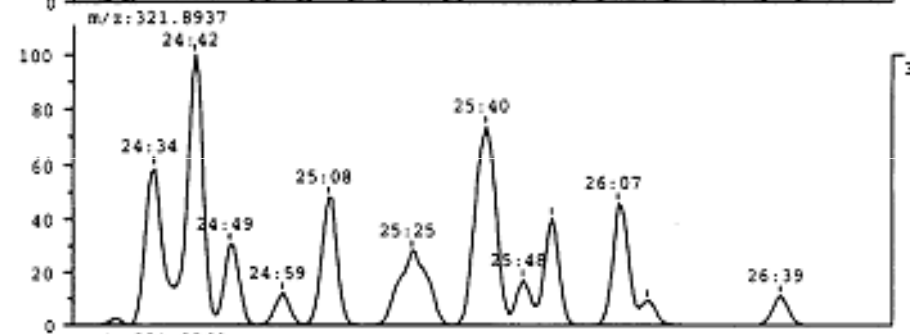
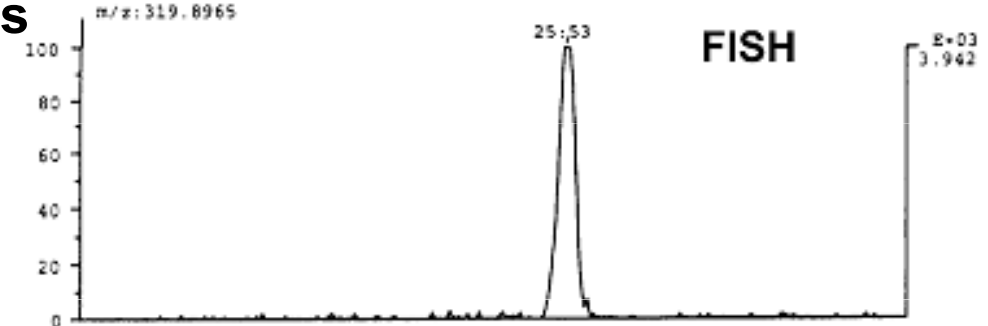
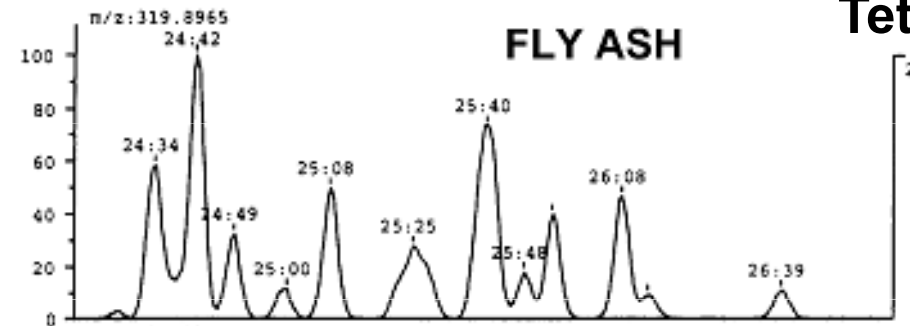

CHRO: 1613-db5-1-t0013
Samp: Vial 4 T0014, flyash, DIOX fr, pr.0026
Comm: DB5ms#29, 5.04g, 250ulES(1-2), 20ulDS(1)
Mode: EI +VE +LMR ESCAN LR NRM
Oper: AK, c.a.803 Client: van Bavel

09-Apr-02 Elapse: 29:25.8 934
Start : 17:19:15 2587
Study : 7th Intercalibratio
Inlet : GC Vial 4

Fly ash PentaCDFs

DB5ms, 60 m

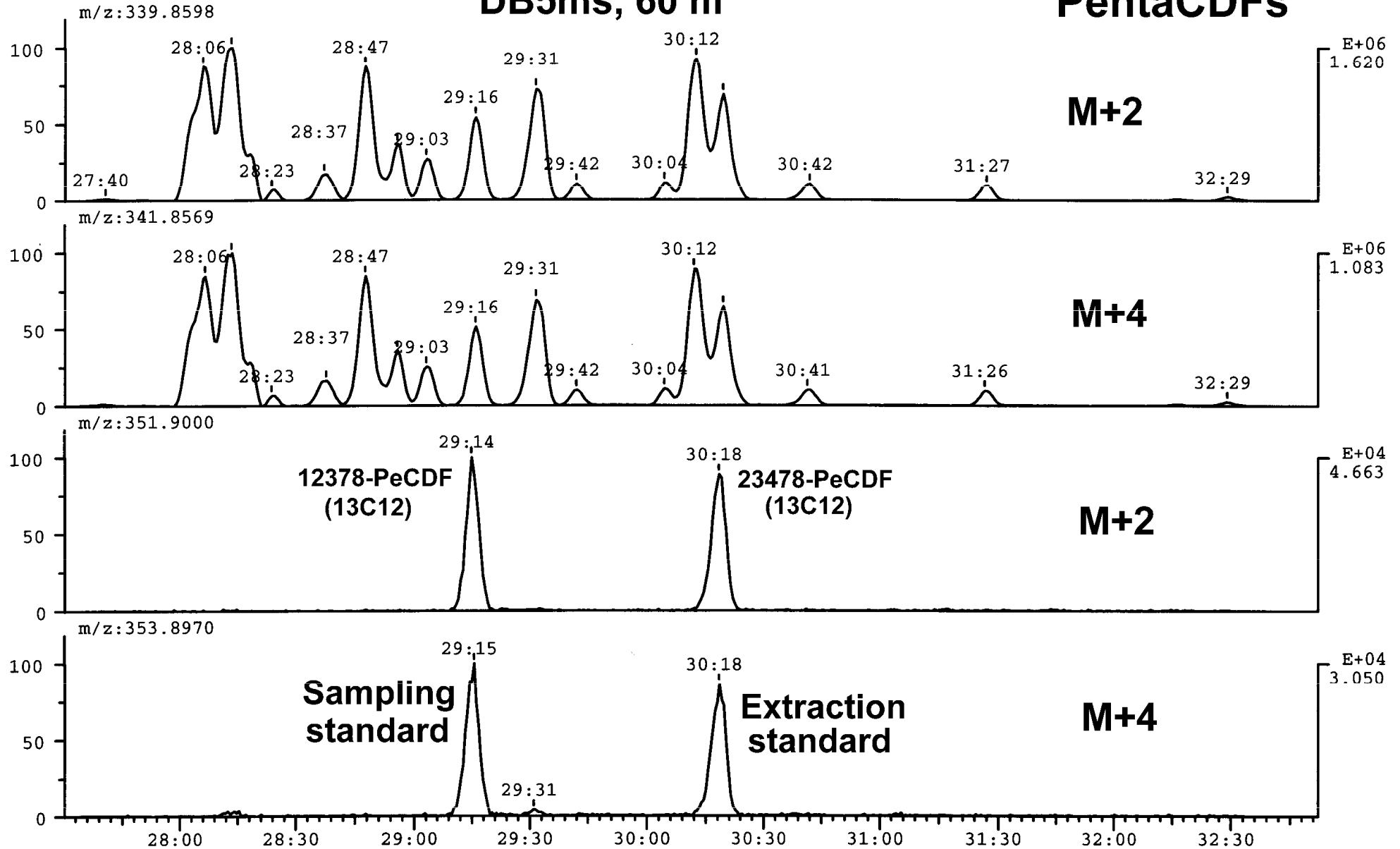

Dioxins and Related Compounds Analysis (1)

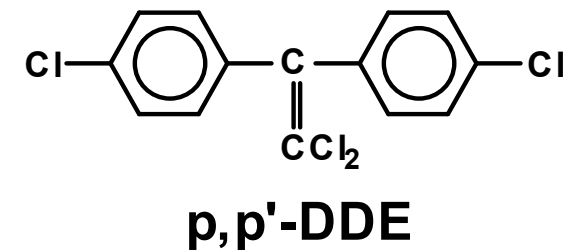
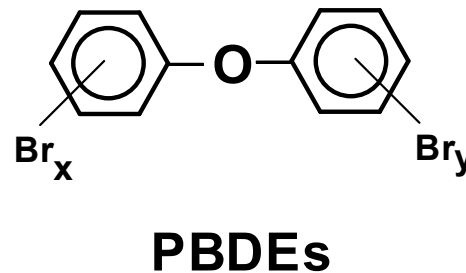
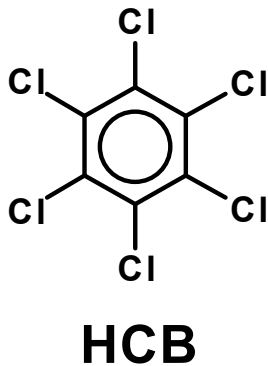
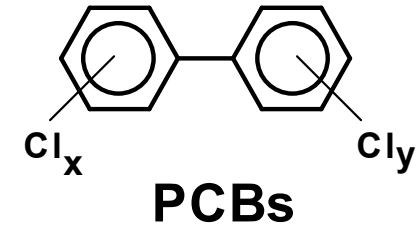
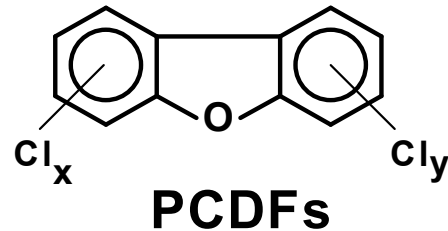
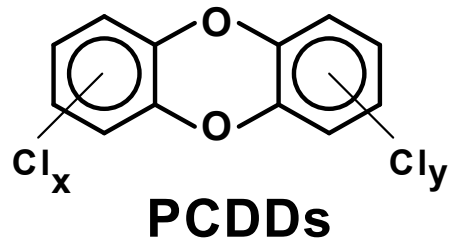

Types of samples:

- Emissions from combustion processes (stack aerosol, flyash)
- Wastes (obsolete chemicals, disposal sites)
- Environmental samples (air, soil, water sediment, biota)
- Foods (meat, fish, milk, eggs, oils)
- Human biological material (milk, blood, adipose tissue)

Flow chart of a clean-up procedure for stack emission samples

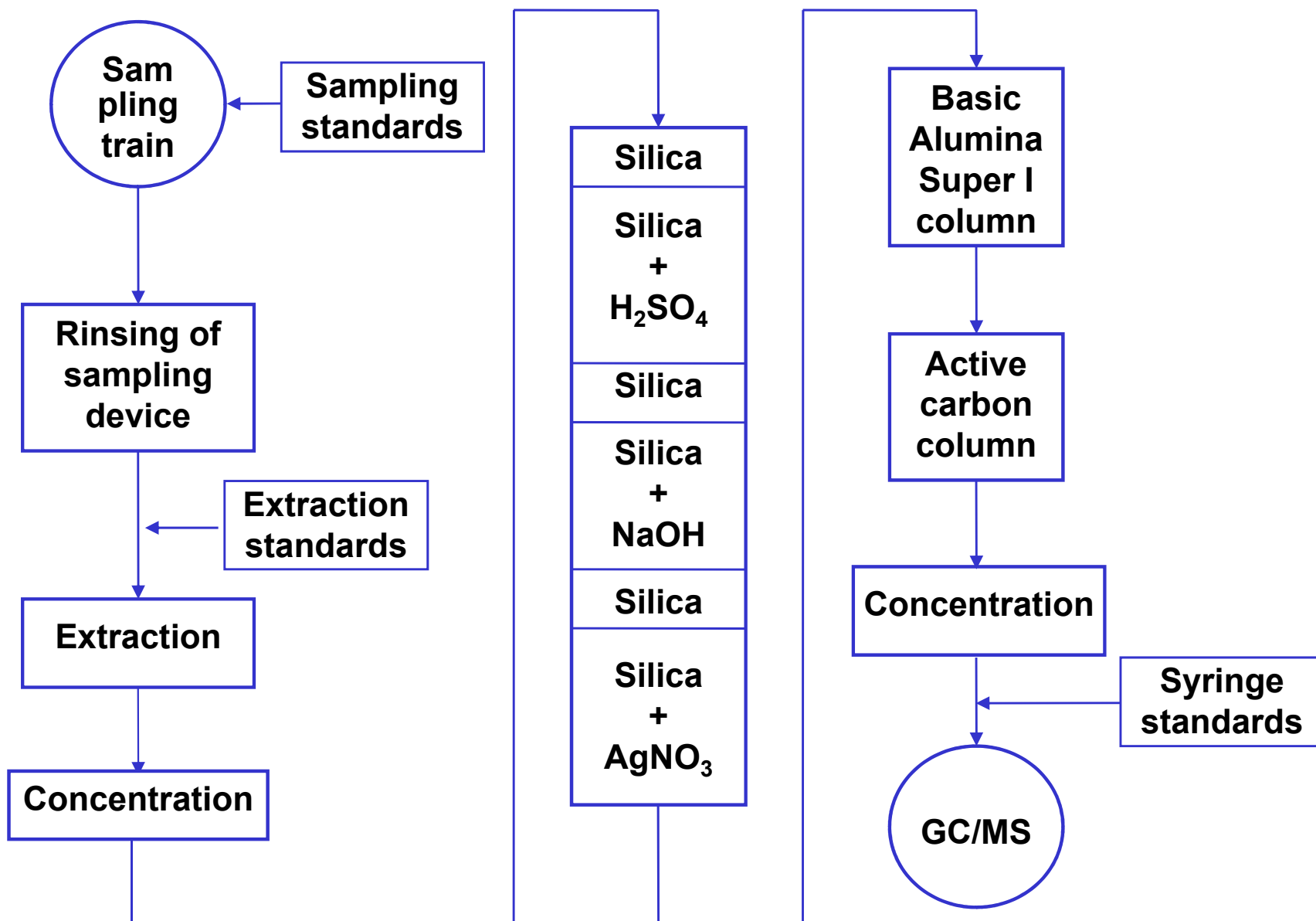

Sampling:

- **The collection of samples should represent the situation, process or the species studied**
- **Attention must be paid to the appropriate timing of collections of samples, their frequency and site layout**
- **Sampling media, particularly those for air and emission sampling should be spiked before sampling with selected isotope labeled surrogates (^{13}C -sampling standards) to make corrections of losses of analytes during the sampling**



Sampling extraction & cleanup:

- Addition of isotope labeled standards (^{13}C) before extraction
- Solvent extraction (Soxhlet, ASE, ultrasonic, SPE, SFE, MASE)
- Removal of matrix substances (lipids, oils, etc.) – H_2SO_4 , GPC, SPM dialysis

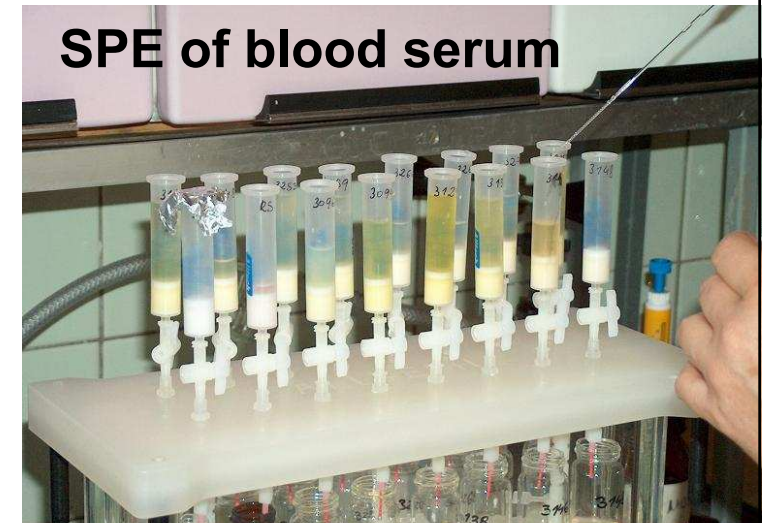

- Removal of interfering coextracted compounds (PCBs, PCDFEs, etc.) – acid/base modified silica, alumina, active carbon, semi-preparative HPLC)
- Concentration of the analytes

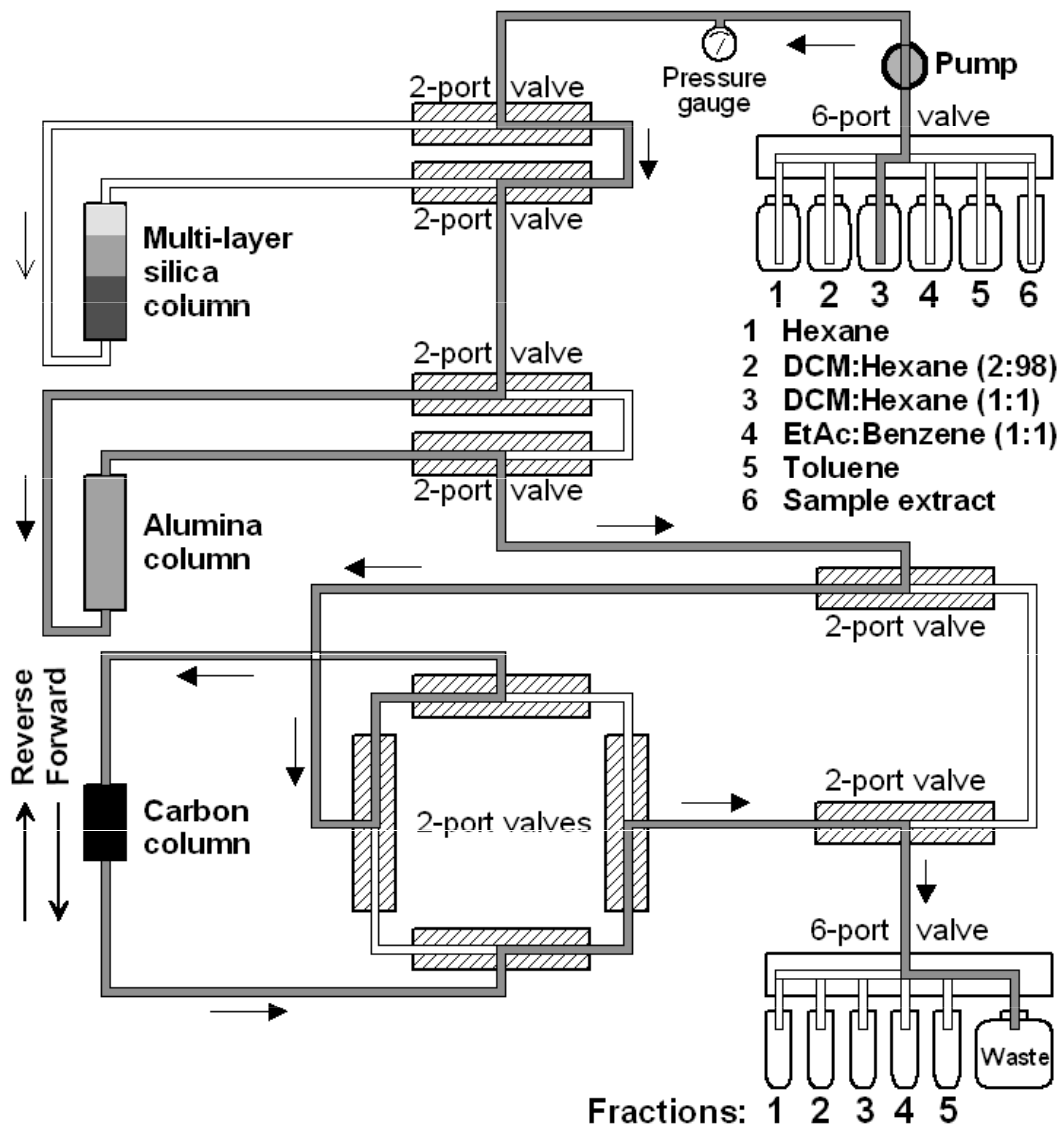

Schematic of a semi-automatic equipment for sample cleanup

Semi-automated clean-up equipment



GC separation:

- **Non-polar stationary phase (e.g. DB-5)** – used for the samples of animal origin and higher chlorinated congeners
- **Polar phase (e.g. SP-2330)** – used for environmental samples (good separation but shorter lifetime)
- **Splitless, on-column or large-volume injection**
- **Direct connection of the column to the ion source**

*out of
splitless
injector*

*to mass
spectrometer*

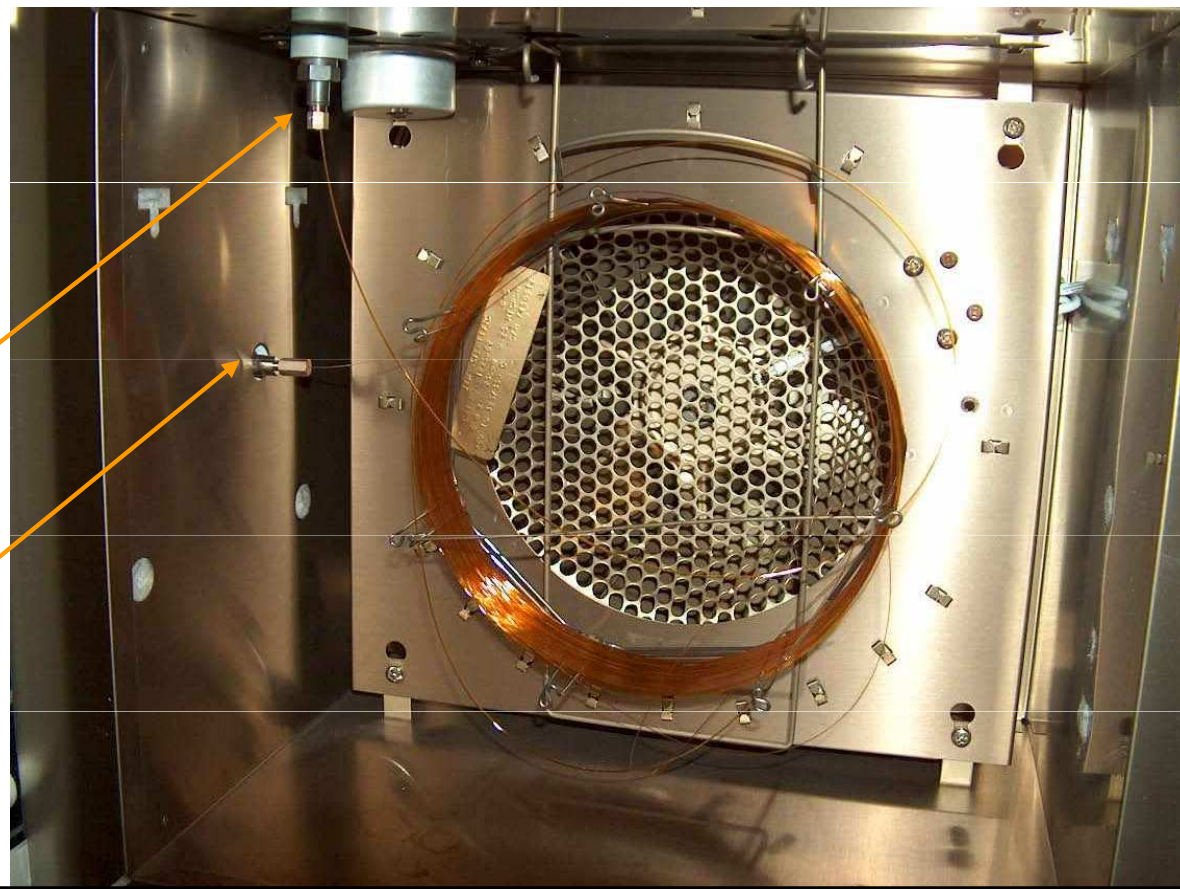

Dioxins and Related Compounds Analysis (5)

Identification Criteria (according to the EN 1948 Standard)

- The isotope ratio between the ions monitored shall match the theoretical value within $\pm 20\%$
- The retention time of a native 2,3,7,8-isomer shall be within a time window of (0s;+3s) based on the retention time of the corresponding $^{13}\text{C}_{12}$ -labelled isomer in the sample. For hepta- and octachlorocongeners deviations of (-2s;+3s) are acceptable
- The GC column shall separate 2,3,7,8-congeners from interfering congeners with a 90% valley relative to the highest peak. 2,3,7,8-TCDF shall be separated from all other interfering isomers within a 25% valley

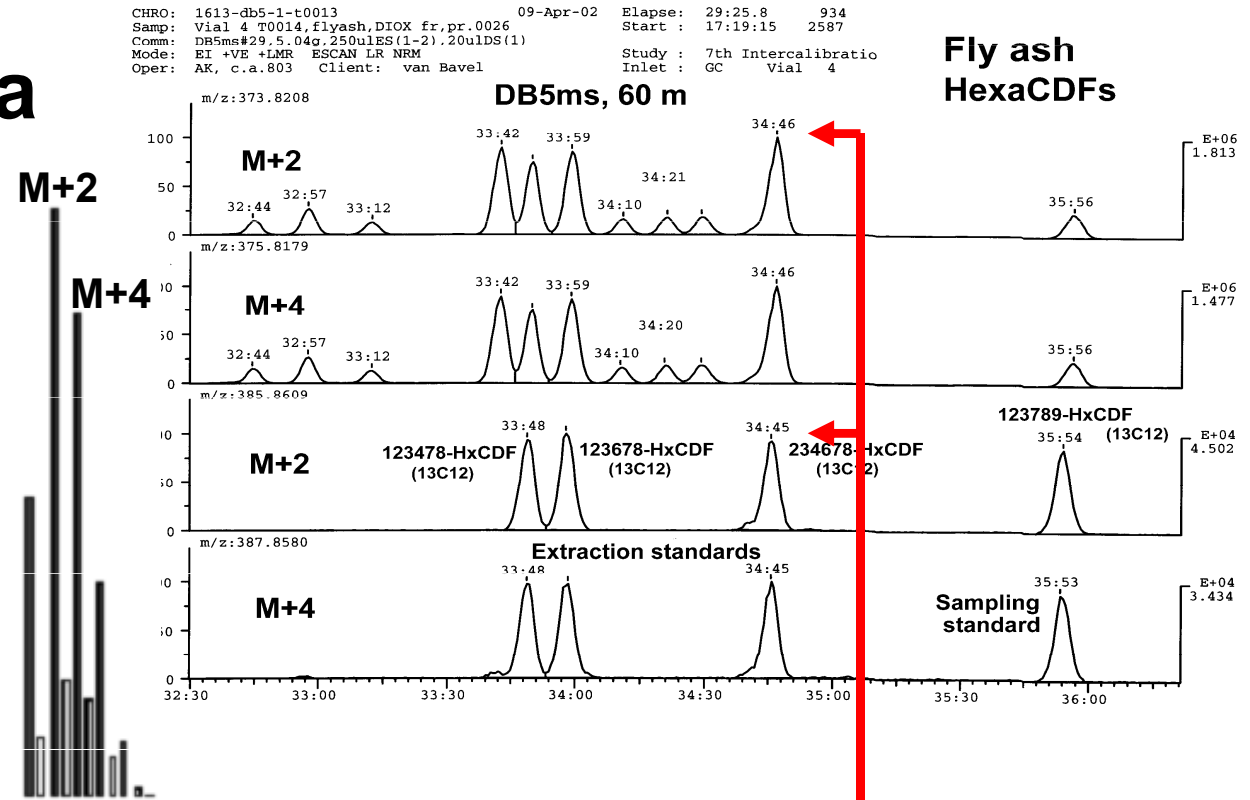

Mass of ions monitored for tetra- to octaCDDs/Fs when HRMS is applied

Group	Ion	% Abundance	Natives	¹³ C ₁₂ -labelled
TetraCDFs	[M]⁺	77.55	303.9016	315.9418
	[M+2]⁺	100	305.8987	317.9390
TetraCDDs	[M]⁺	77.55	319.8965	331.9398
	[M+2]⁺	100	321.8935	333.9338
PentaCDFs	[M+2] ⁺	100	339.8597	351.9000
	[M+4] ⁺	64.15	341.8567	353.8970
PentaCDDs	[M+2] ⁺	100	355.8546	367.8948
	[M+4] ⁺	64.15	357.8516	369.8918
HexaCDFs	[M+2] ⁺	100	373.8208	385.8610
	[M+4] ⁺	80.54	375.8178	387.8581
HexaCDDs	[M+2] ⁺	100	389.8156	401.8558
	[M+4] ⁺	80.54	391.8126	403.8528
HeptaCDFs	[M+2] ⁺	100	407.7818	419.8220
	[M+4] ⁺	96.52	409.7789	421.8192
HeptaCDDs	[M+2] ⁺	100	423.7766	435.8169
	[M+4] ⁺	96.52	425.7737	437.8140
OctaCDF	[M+2] ⁺	88.89	441.7428	453.7830
	[M+4] ⁺	100	443.7398	455.7801
OctaCDD	[M+2] ⁺	88.89	457.7377	469.7779
	[M+4] ⁺	100	459.7348	471.7750

Mass of ions monitored for tetra- to octaCDDs/Fs when HRMS is applied

Group	Ion	% Abundance	Natives	¹³ C ₁₂ -labelled
TetraCDFs	[M] ⁺	77.55	303.9016	315.9418
	[M+2] ⁺	100	305.8987	317.9390
TetraCDDs	[M] ⁺	77.55	319.8965	331.9398
	[M+2] ⁺	100	321.8935	333.9338
PentaCDFs	[M+2]⁺	100	339.8597	351.9000
	[M+4]⁺	64.15	341.8567	353.8970
PentaCDDs	[M+2]⁺	100	355.8546	367.8948
	[M+4]⁺	64.15	357.8516	369.8918
HexaCDFs	[M+2] ⁺	100	373.8208	385.8610
	[M+4] ⁺	80.54	375.8178	387.8581
HexaCDDs	[M+2] ⁺	100	389.8156	401.8558
	[M+4] ⁺	80.54	391.8126	403.8528
HeptaCDFs	[M+2] ⁺	100	407.7818	419.8220
	[M+4] ⁺	96.52	409.7789	421.8192
HeptaCDDs	[M+2] ⁺	100	423.7766	435.8169
	[M+4] ⁺	96.52	425.7737	437.8140
OctaCDF	[M+2] ⁺	88.89	441.7428	453.7830
	[M+4] ⁺	100	443.7398	455.7801
OctaCDD	[M+2] ⁺	88.89	457.7377	469.7779
	[M+4] ⁺	100	459.7348	471.7750

Mass of ions monitored for tetra- to octaCDDs/Fs when HRMS is applied

Group	Ion	% Abundance	Natives	¹³ C ₁₂ -labelled
TetraCDFs	[M] ⁺	77.55	303.9016	315.9418
	[M+2] ⁺	100	305.8987	317.9390
TetraCDDs	[M] ⁺	77.55	319.8965	331.9398
	[M+2] ⁺	100	321.8935	333.9338
PentaCDFs	[M+2] ⁺	100	339.8597	351.9000
PentaCDDs	[M+4] ⁺	64.15	341.8567	353.8970
	[M+2] ⁺	100	355.8546	367.8948
HexaCDFs	[M+4] ⁺	64.15	357.8516	369.8918
	[M+2] ⁺	100	373.8208	385.8610
HexaCDDs	[M+4] ⁺	80.54	375.8178	387.8581
	[M+2] ⁺	100	389.8156	401.8558
HeptaCDFs	[M+4] ⁺	80.54	391.8126	403.8528
	[M+2] ⁺	100	407.7818	419.8220
HeptaCDDs	[M+4] ⁺	96.52	409.7789	421.8192
	[M+2] ⁺	100	423.7766	435.8169
OctaCDF	[M+4] ⁺	96.52	425.7737	437.8140
	[M+2] ⁺	88.89	441.7428	453.7830
OctaCDD	[M+4] ⁺	100	443.7398	455.7801
	[M+2] ⁺	88.89	457.7377	469.7779
	[M+4] ⁺	100	459.7348	471.7750

Mass of ions monitored for tetra- to octaCDDs/Fs when HRMS is applied

Group	Ion	% Abundance	Natives	¹³ C ₁₂ -labelled
TetraCDFs	[M] ⁺	77.55	303.9016	315.9418
	[M+2] ⁺	100	305.8987	317.9390
TetraCDDs	[M] ⁺	77.55	319.8965	331.9398
	[M+2] ⁺	100	321.8935	333.9338
PentaCDFs	[M+2] ⁺	100	339.8597	351.9000
PentaCDDs	[M+4] ⁺	64.15	341.8567	353.8970
	[M+2] ⁺	100	355.8546	367.8948
HexaCDFs	[M+4] ⁺	64.15	357.8516	369.8918
	[M+2] ⁺	100	373.8208	385.8610
HexaCDDs	[M+4] ⁺	80.54	375.8178	387.8581
	[M+2] ⁺	100	389.8156	401.8558
HeptaCDFs	[M+4] ⁺	80.54	391.8126	403.8528
	[M+2] ⁺	100	407.7818	419.8220
HeptaCDDs	[M+4] ⁺	96.52	409.7789	421.8192
	[M+2] ⁺	100	423.7766	435.8169
OctaCDF	[M+4] ⁺	96.52	425.7737	437.8140
	[M+2] ⁺	88.89	441.7428	453.7830
OctaCDD	[M+4] ⁺	100	443.7398	455.7801
	[M+2] ⁺	88.89	457.7377	469.7779
	[M+4] ⁺	100	459.7348	471.7750

Mass of ions monitored for tetra- to octaCDDs/Fs when HRMS is applied

Group	Ion	% Abundance	Natives	¹³ C ₁₂ -labelled
TetraCDFs	[M] ⁺	77.55	303.9016	315.9418
	[M+2] ⁺	100	305.8987	317.9390
TetraCDDs	[M] ⁺	77.55	319.8965	331.9398
	[M+2] ⁺	100	321.8935	333.9338
PentaCDFs	[M+2] ⁺	100	339.8597	351.9000
PentaCDDs	[M+4] ⁺	64.15	341.8567	353.8970
	[M+2] ⁺	100	355.8546	367.8948
HexaCDFs	[M+4] ⁺	64.15	357.8516	369.8918
	[M+2] ⁺	100	373.8208	385.8610
HexaCDDs	[M+4] ⁺	80.54	375.8178	387.8581
	[M+2] ⁺	100	389.8156	401.8558
HeptaCDFs	[M+4] ⁺	80.54	391.8126	403.8528
	[M+2] ⁺	100	407.7818	419.8220
HeptaCDDs	[M+4] ⁺	96.52	409.7789	421.8192
	[M+2] ⁺	100	423.7766	435.8169
OctaCDF	[M+4] ⁺	96.52	425.7737	437.8140
	[M+2] ⁺	88.89	441.7428	453.7830
OctaCDD	[M+4] ⁺	100	443.7398	455.7801
	[M+2] ⁺	88.89	457.7377	469.7779
	[M+4] ⁺	100	459.7348	471.7750

Quantification criteria

(according to the EN 1948 Standard)

- **The S/N ratio of the raw data shall be at least 3:1 for the signal used for quantification**
- **The calibration is carried out with at least 5 calibration solutions**
- **The measuring range shall be linear**
- **Daily calibration checks shall be run**
- **HRMS at 6000 to 10000 resolution can be used if the absence of interferences is documented**
- **Other techniques can be used if show meeting the criteria**

Conversion of Analytical Results into the Toxic Equivalent (TEQ)

- This conversion is based on the assumption that all the 2,3,7,8-substituted PCDDs and PCDFs (17 cong.), as well as the dioxin-like PCBs (12 cong.), bind to the same receptor, the Ah receptor, and show comparable qualitative (toxic) effects, but with different potencies
- These differences in toxicity are expressed in the toxic equivalency factors (TEFs)
- TEF of the most toxic 2378-TCDD = 1

Congener	I-TEF	WHO-TEF	Congener	I-TEF	WHO-TEF
2378-TCDD	1	1	2378-TCDF	0.1	0.1
12378-PeCDD	0.5	1	23478-PeCDF	0.5	0.5
123478-HxCDD	0.1	0.1	12378-PeCDF	0.05	0.05
123678-HxCDD	0.1	0.1	123478-HxCDF	0.1	0.1
123789-HxCDD	0.1	0.1	123789-HxCDF	0.1	0.1
1234678-HpCDD	0.01	0.01	123678-HxCDF	0.1	0.1
OCDD	0.001	0.0001	234678-HxCDF	0.1	0.1
			1234678-HpCDF	0.01	0.01
			1234789-HpCDF	0.01	0.01
			OCDF	0.001	0.0001

$$TEQ = (PCDD_i \times TEF_i) + (PCDF_i \times TEF_i) + (PCB_i \times TEF_i)$$

Calculations Regarding Dioxin Determination by the Isotope Dilution Method

Relative Response Factors

$$rrf_i = \frac{A_{i,12C}}{A_{i,13C}} \times \frac{Q_{i,13C}}{Q_{i,12C}}$$

Quantification

$$Q_{i,12C} = \frac{Q_{i,13C}}{rrf_i} \times \frac{A_{i,12C}}{A_{i,13C}}$$

$$C_i = Q_{i,12C} / V_{nr}$$

$$C_T = \Sigma (C_i \times I-TEF_i)$$

Extraction Standards Recovery

$$R_{i,e} = \frac{100}{Q_{i,e}} \times \frac{Q_{i,sy}}{rrf_i} \times \frac{A_{i,e}}{A_{i,sy}}$$

Sampling Standards Recovery

$$R_{i,sa} = \frac{100}{Q_{i,sa}} \times \frac{Q_{i,e}}{rrf_i} \times \frac{A_{i,sa}}{A_{i,e}}$$