

NAVRHOVÁNÍ VÝROBKŮ Z PLASTŮ

netkané textilie – DOPLNĚK 2

RNDr. Ladislav Pospíšil, CSc.

Nonwoven Products

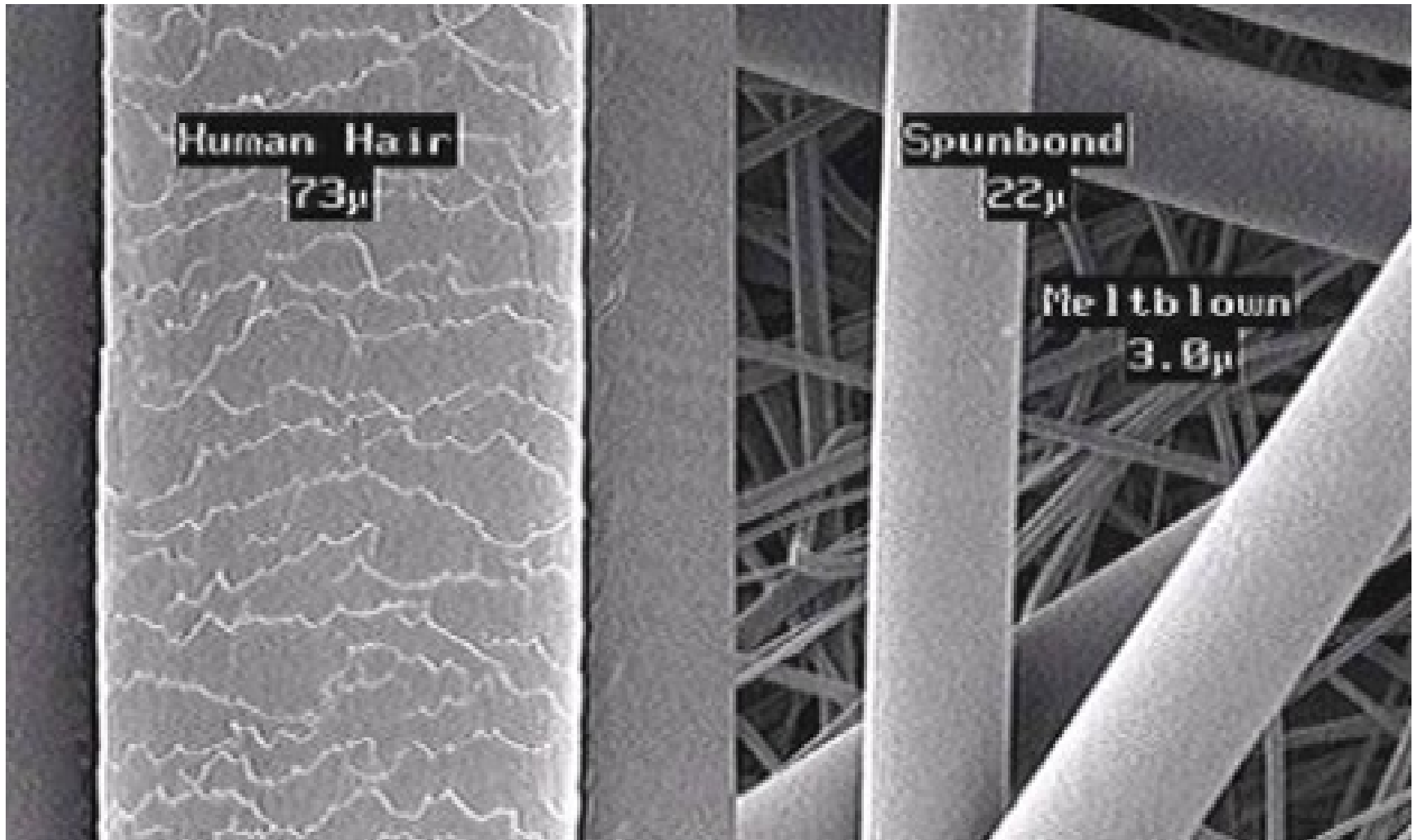

Bicomponents

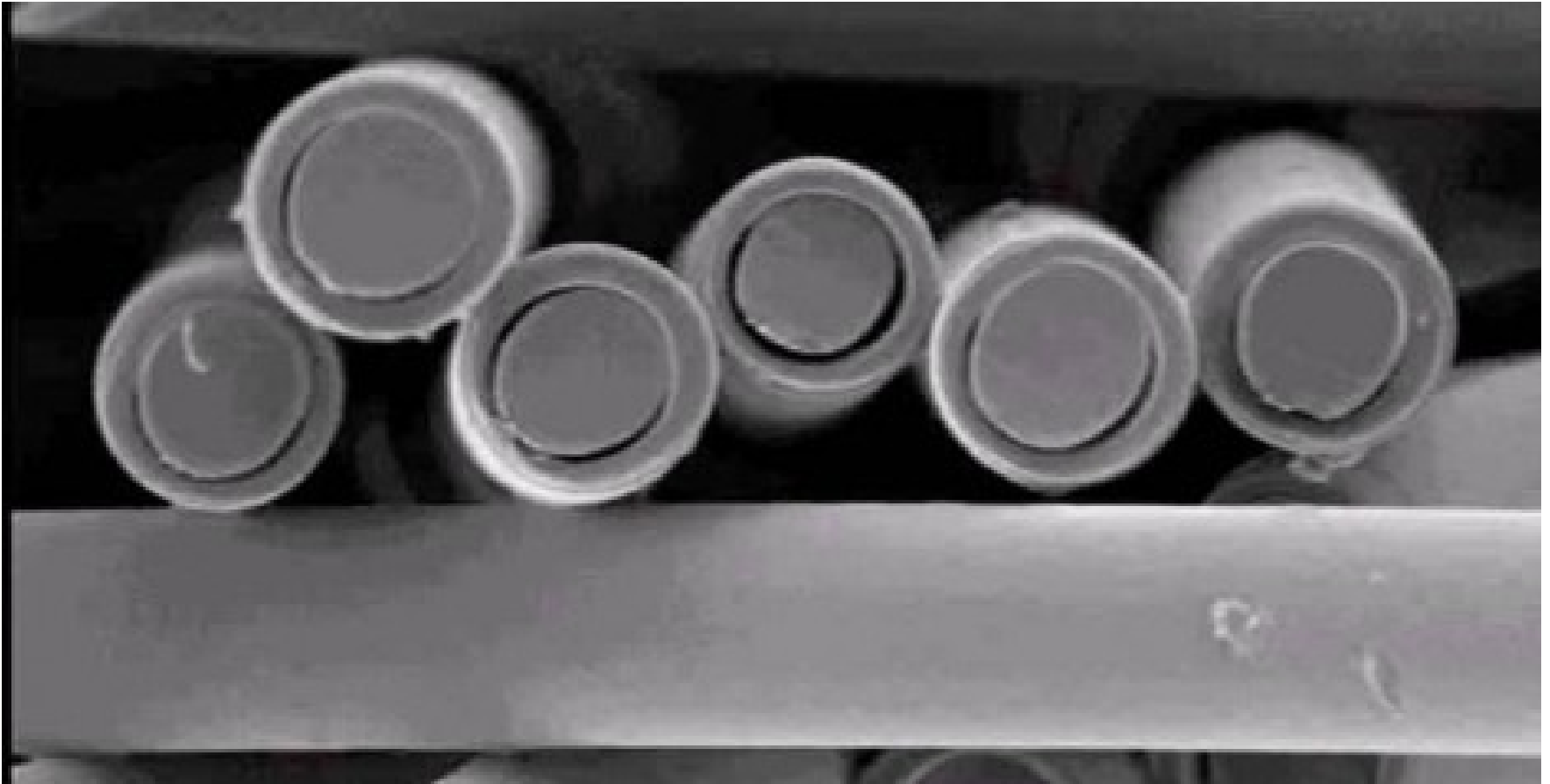

Spun Bond



Melt Blown Fasern mit ca. 0,1 dtex (1:500)

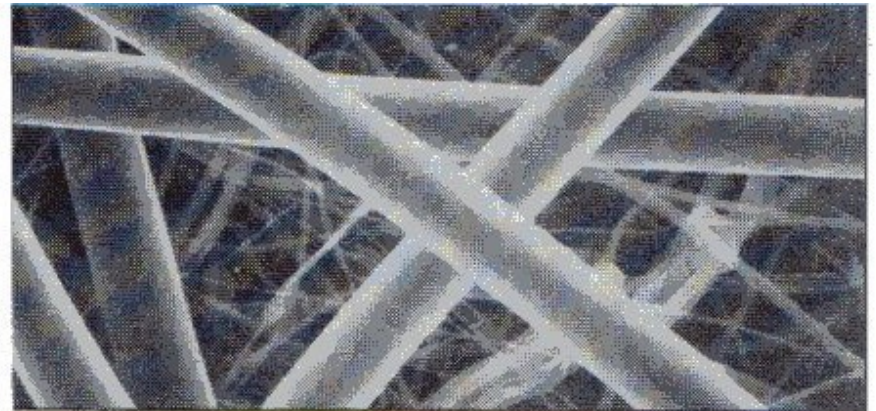

Spinnvlies Fasern mit ca. 3 dtex (1:500)

Spun Bond

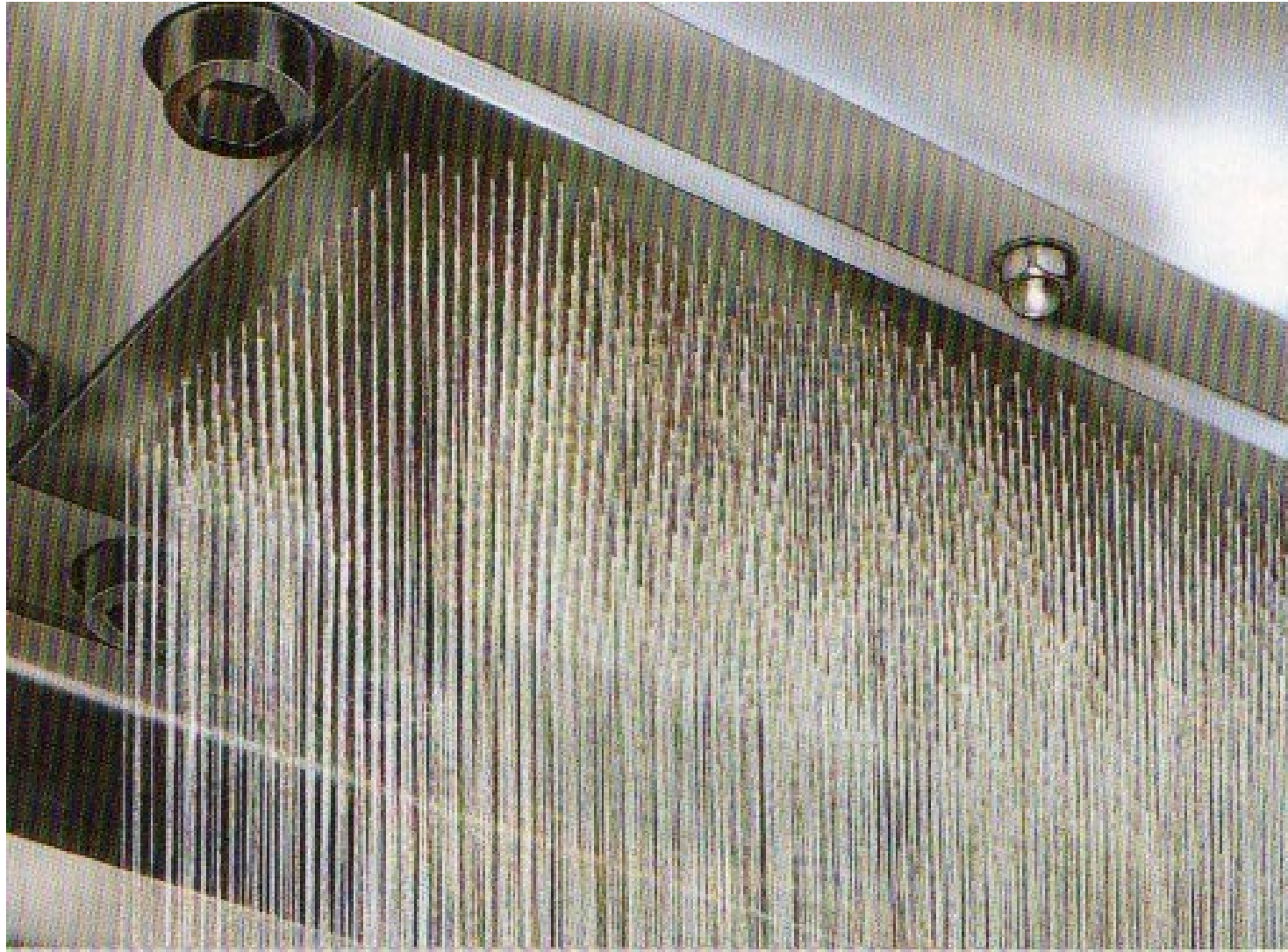

14. 4. 2014

NOSNÉ A VÁZACÍ
PROSTŘEDKY - DOPLNĚK 2

Spun Bond

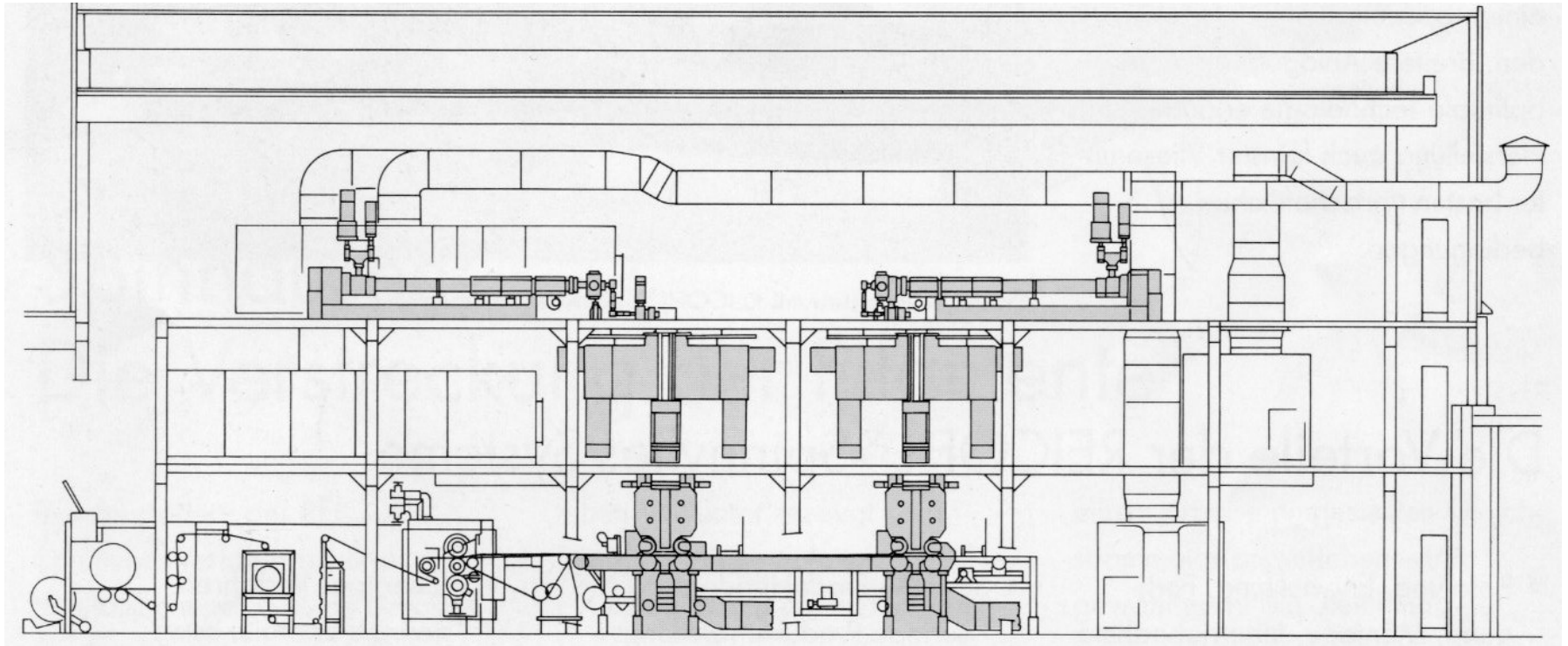

Spun Bond



14. 4. 2014

NOSNÉ A VÁZACÍ
PROSTŘEDKY - DOPLNĚK 2

Spun Bond

REICOFIL Melt Blown System – Produktionsdaten mit PP

Typ	Flächengewicht g/m ²	Produktbreite (netto) mm	Durchsatz kg/h
1000	3 - 500	1000	45 - 100
1600	3 - 500	1600	60 - 160
2400	3 - 500	2400	90 - 240
3200	3 - 500	3200	120 - 320
4200	3 - 500	4200	160 - 420

Melt Blown

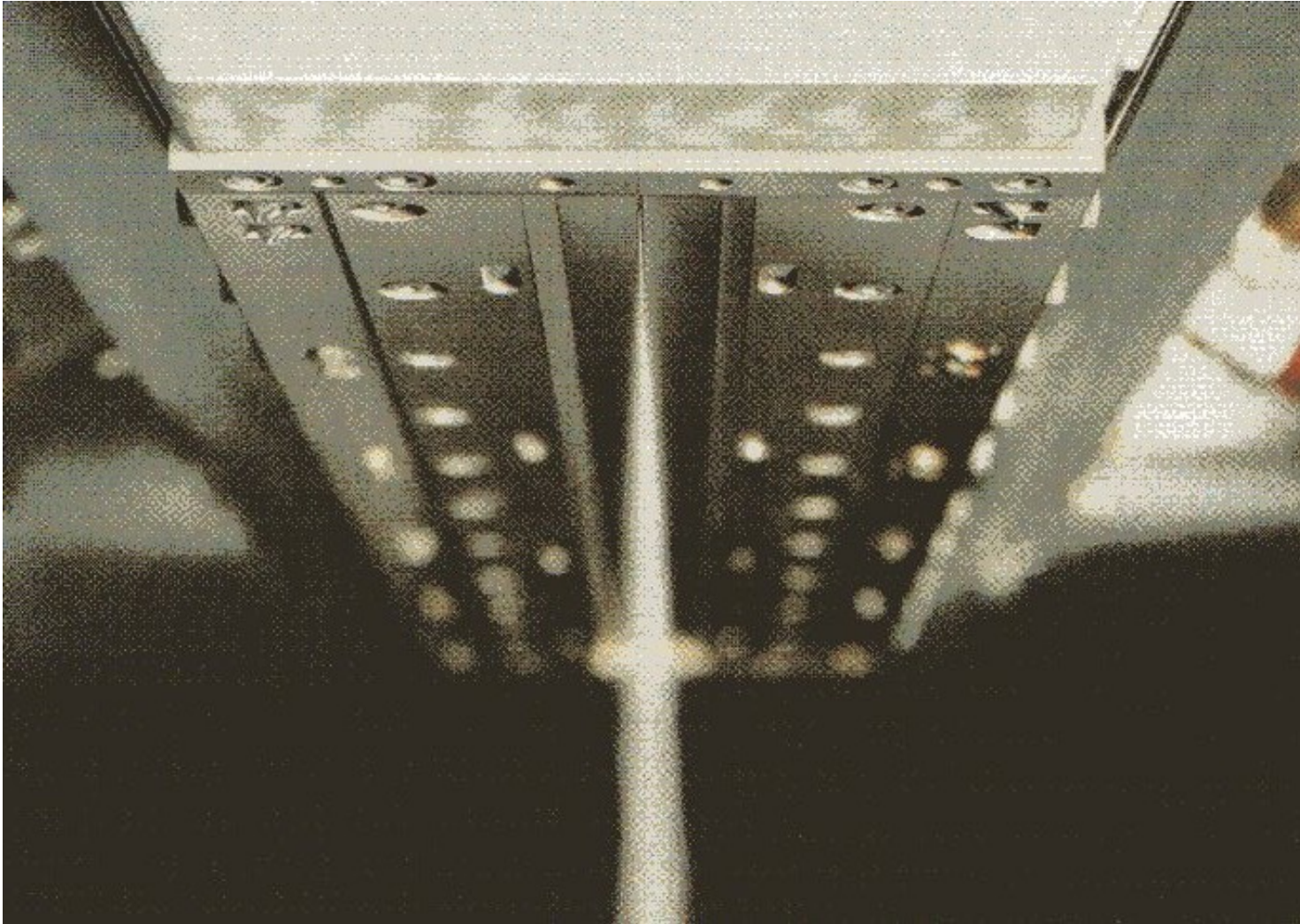

14. 4. 2014

NOSNÉ A VÁZACÍ
PROSTŘEDKY - DOPLNĚK 2

Melt Blown

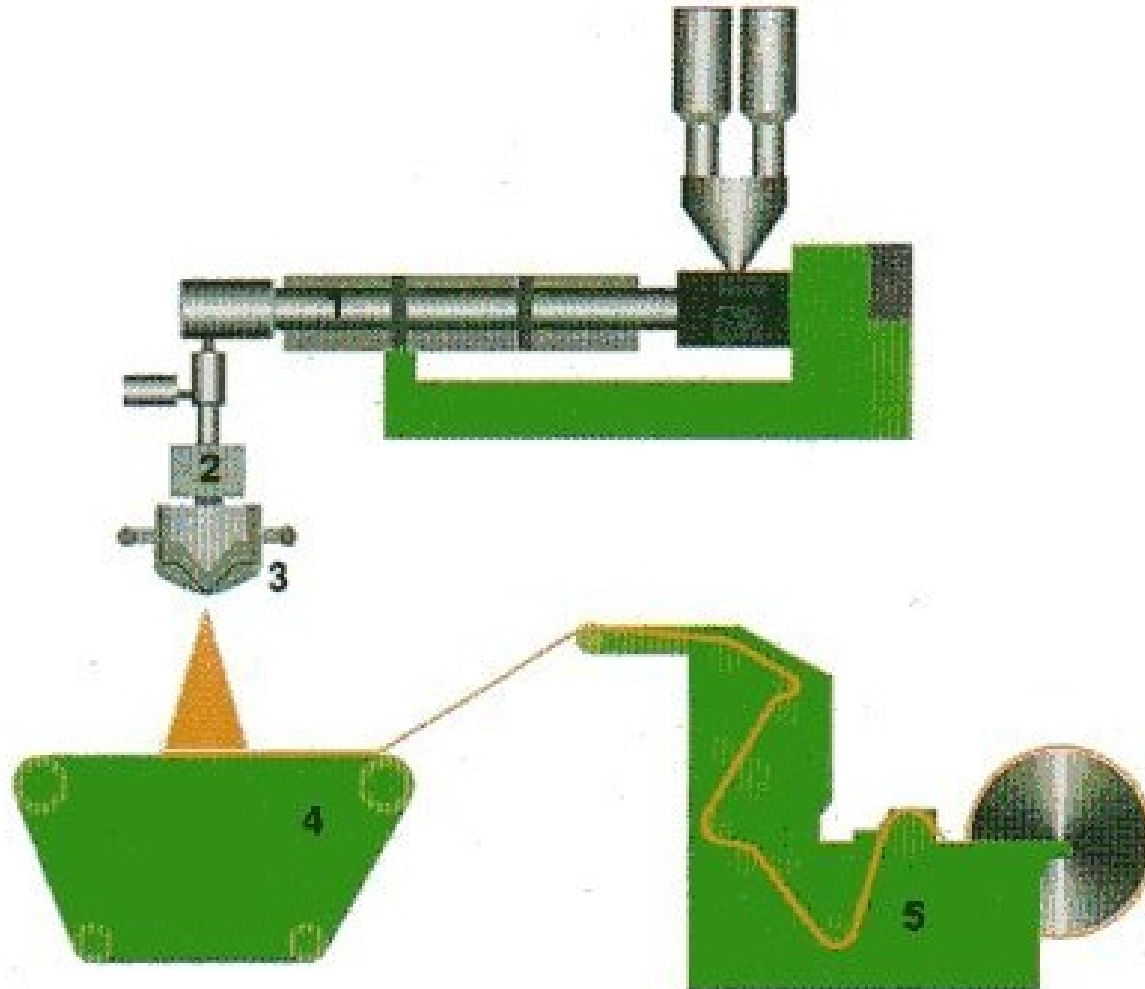

Melt Blown

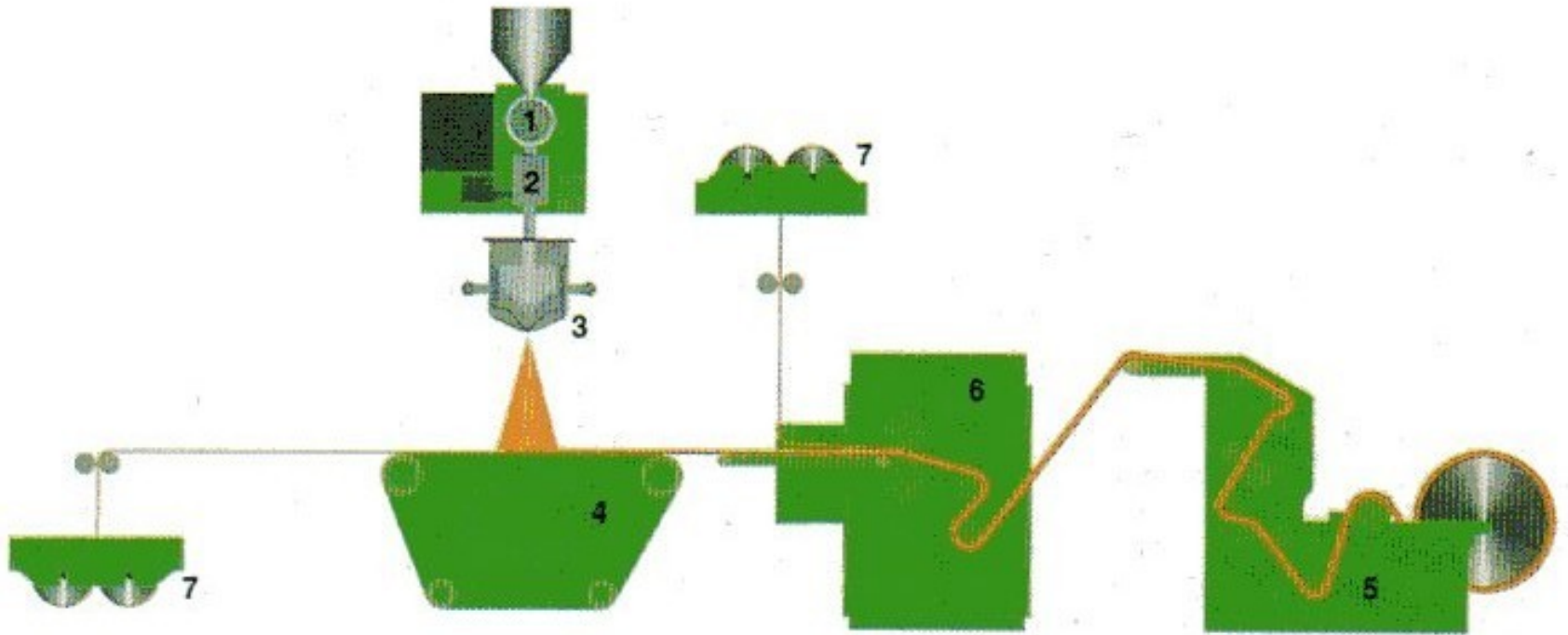

Melt Blown

