



CONTINUOUS PROCESSES, FLOW CHEMISTRY

Petr Beňovský

CONTINUOUS PROCESSES



BATCH PRODUCTION



CONTINUOUS PRODUCTION



CONTINUOUS PROCESSES

Typical Signals of Potential Problems on Scale-up

- **Change of mixing speed changes product yield;**
 - **Different mode of addition changes product yield;**
 - **The position of a feed stream changes product yield;**
 - **Scale up to a vessel with different geometry;**
 - **Different holding time before work up;**
 - **Poor heat transfer;**
 - **Stability of intermediates;**
 - **Different stirring**
- 

CONTINUOUS PROCESSES

Pros/Cons of Continuous Processing in Pharma Manufacturing

Factor	Pros	Cons
Processing	Increased knowledge of the process due to the data rich environment, which includes in-line, real-time process monitoring (known as "PAT" - Process Automation Technology)	Many processes are validated and licensed by the FDA, therefore modification from batch to continuous processing in existing operations requires a significant investment of money and time
Operating Cost	Operating costs are lower due to less handling of product throughout the process	None
Capital Cost	Less overall facility cost	New technology brings high cost for new equipment
Facility Integration	Vertical integrated with a small building footprint required	Most existing facilities are not vertical, so retrofitting is a challenge
Quality	Improved quality as process is monitored in real-time and product data collected	Increased data collection also means increased need for analysis, storage, etc.
Scale Up	Ability to scale up production by running continuous equipment longer; do not necessarily need to add production "lines"	Most developers do not have experience with the technology, need to find specialists to design and program the equipment
Other Factors		<ul style="list-style-type: none">• Current excess capacity in batch processing pharma facilities• Resistance to change from a traditional method• New skills required to support process technology• Current FDA regulations do not account for continuous processing implications just yet; will require interpretation of long-standing rules; most in "wait and see" mode

CONTINUOUS PROCESSES

Typical Elements of a Continuous process:

- Efficient mixing enables fine control of reaction temperature within the whole reactor

Static mixers

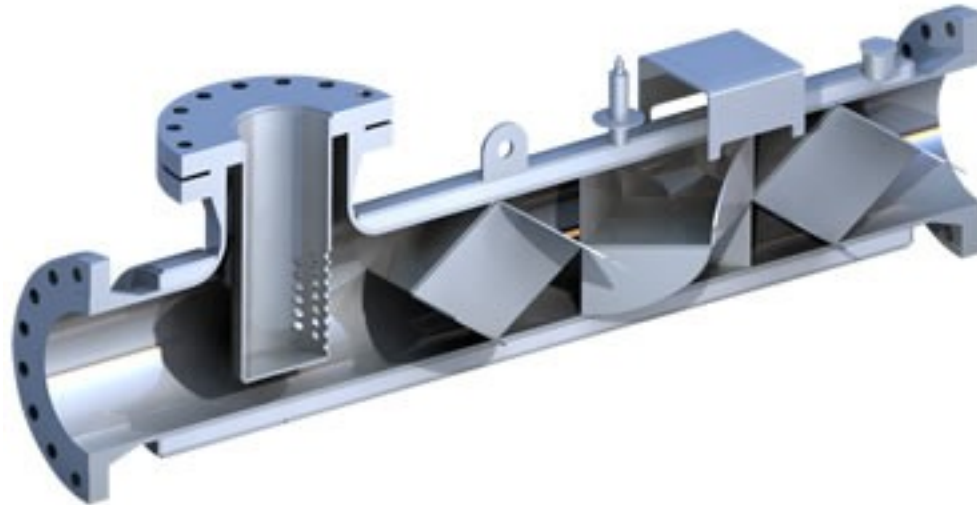

High Surface
area / Volume
Ratio



CONTINUOUS PROCESSES

Typical Elements of a Continuous process:

- Continuous operations can be applied for both cryogenic and high temperature processes;
 - Much broader range of temperatures;
 - Effective with respect to energy;
- 



CONTINUOUS PROCESSES

Typical Elements of a Continuous process:

- Reactive species can be separated thus minimizing side products (and raising yields);
- 



CONTINUOUS PROCESSES

Typical Elements of a Continuous process:

- Utilization of nontraditional techniques (photochemistry, sonochemical reactions, passing through a bed of a catalyst or immobilized enzyme)





CONTINUOUS PROCESSES

Typical Elements of a Continuous process:

- Enables much safer processes;
 - Only tiny portion of the reaction mixture is exposed to high temperature or exothermic reaction occurs only with very small amount of reactants;
 - Advantage working with highly toxic compounds (cyanides, phosgene, diazomethane, ozone)
- 



CONTINUOUS PROCESSES

Typical Elements of a Continuous process:

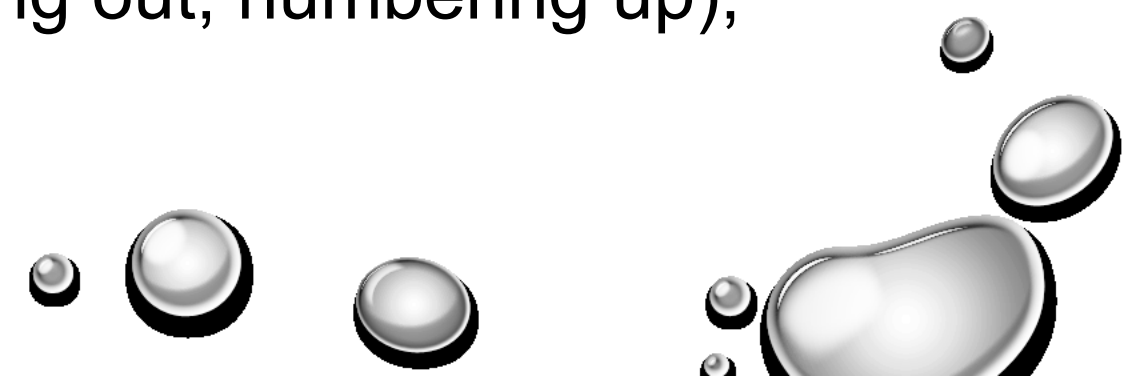
- Opportunity in the field of intellectual property;
 - Relatively easy monitoring in real time (PAT);
 - Variability according to a purpose;
 - Supported by authorities;
 - Fitting well into Quality by Design concept;
 - Sometimes untypically milder reaction conditions;
 - Increasing of productivity (scaling out, numbering up);
- 



CONTINUOUS PROCESSES

Typical Elements of a Continuous process:

- Need for efficient and robust pumps, inert tubings, vessels to collect products and store starting components, fittings, pressure gauges, pressure relief valves, static mixers, heat exchangers, separators
 - Residence time (average time needed for a molecule to pass through a reactor);
 - Flow rate (ml per min.);
- 

FLOW CHEMISTRY

Artemisinin continuous production

Used in the treatment of malaria

2015 – Nobel prize for its discovery (1972)

Extracted from plant *Artemisia annua*
(sweet wormwood)

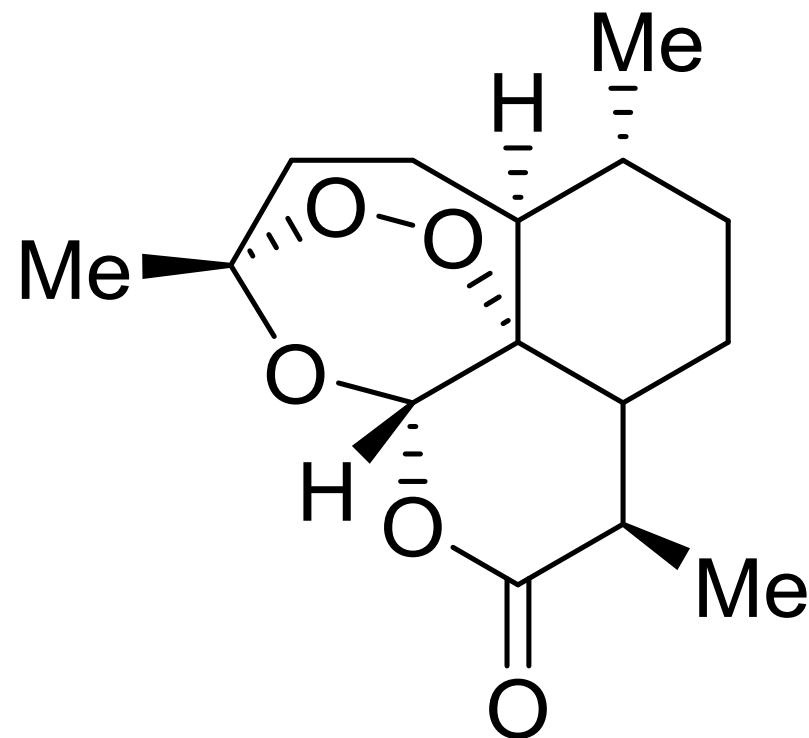

FLOW CHEMISTRY

Artemisinin continuous production

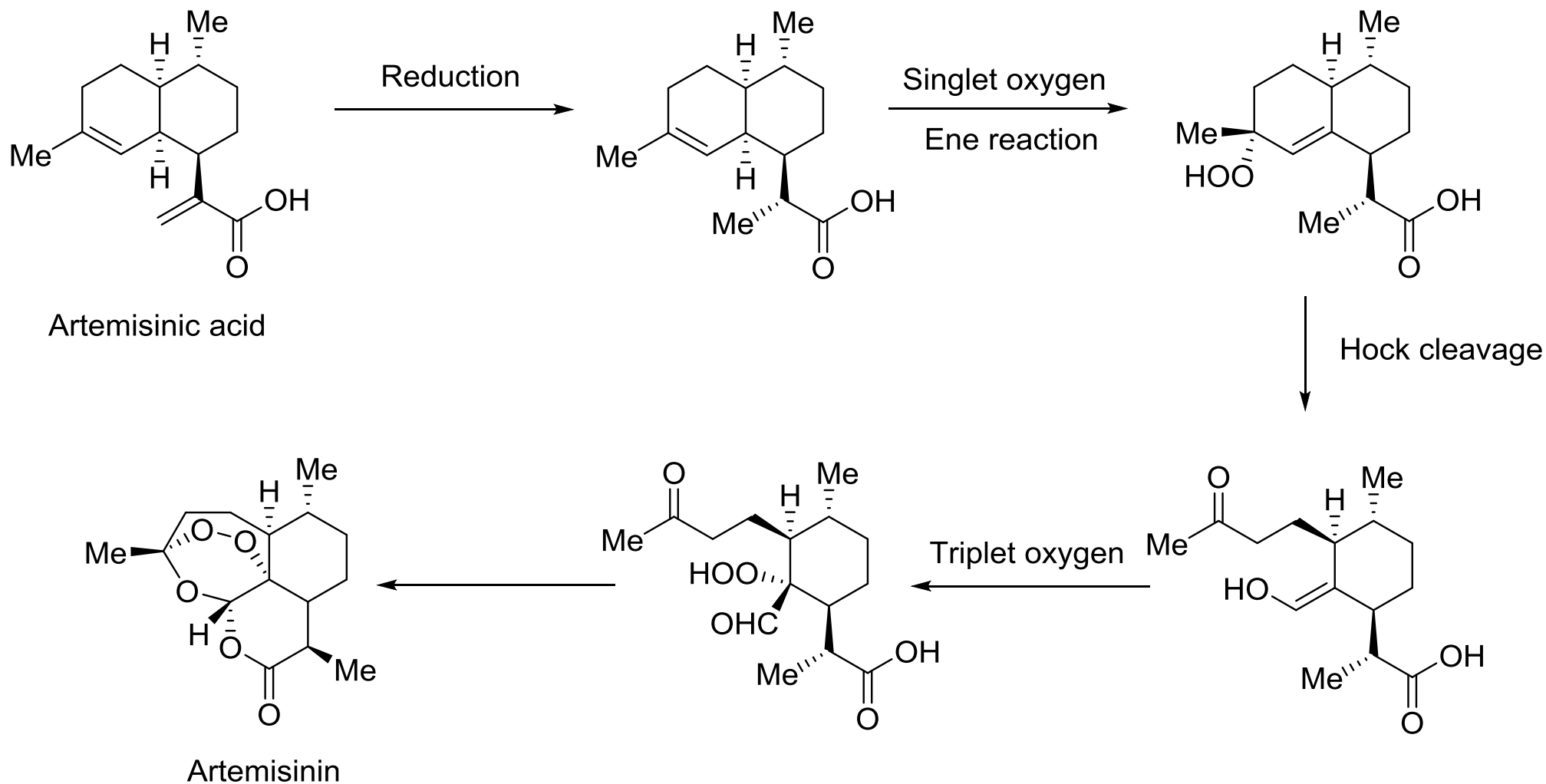

FLOW CHEMISTRY

Artemisinin continuous production

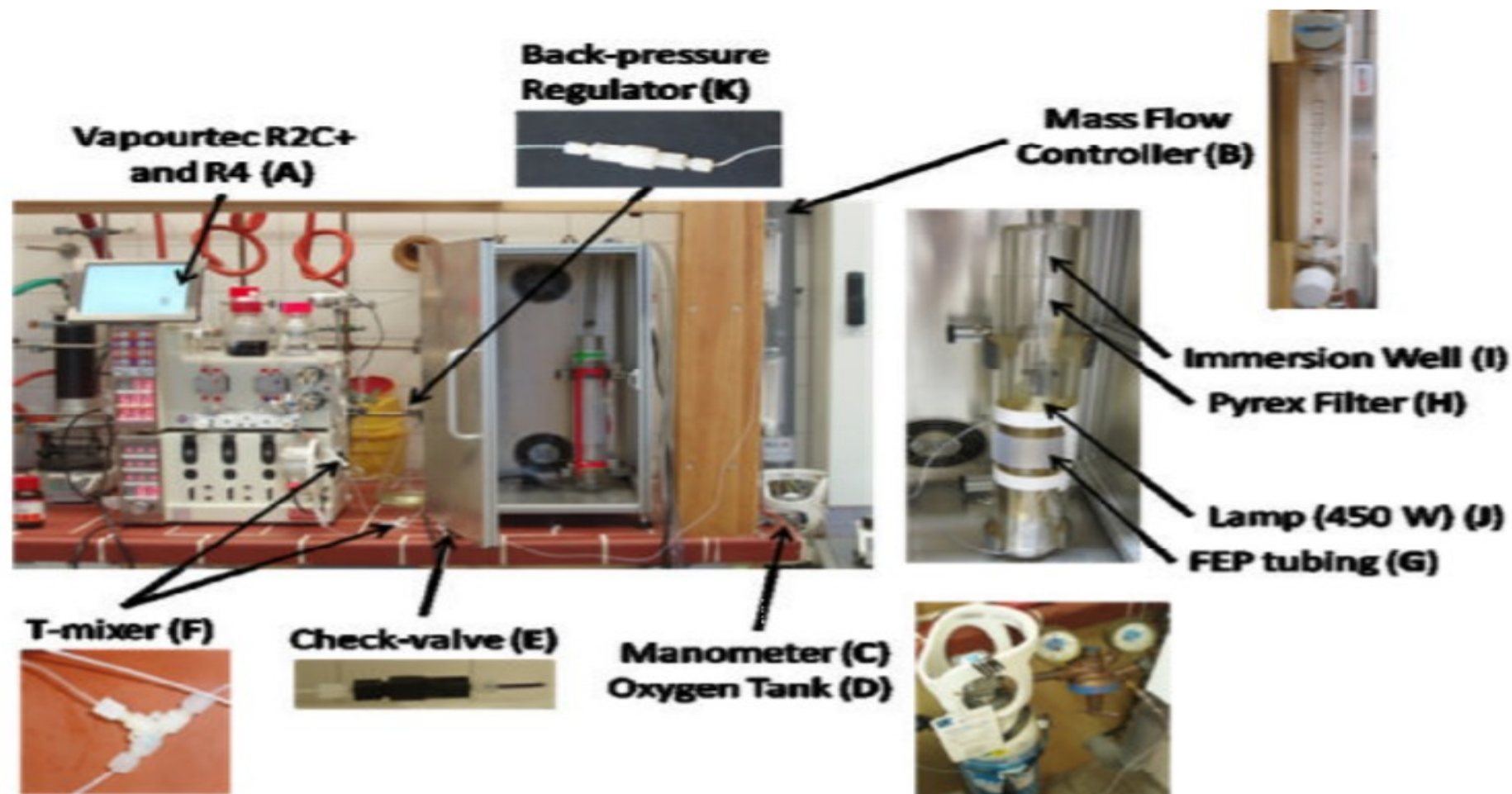

Lévesque, F.; Seeberger, P.H. *Angew.Chem. Int. Ed.* 51, 1706 (2012)

FLOW CHEMISTRY

Artemisinin continuous production

1500 simple photoreactors (each 200 g of artemisinin a day) would be sufficient to cover demand for roughly 225 million doses necessary for the malaria treatment (2009 WHO estimate)

Lévesque, F.; Seeberger, P.H. *Angew.Chem. Int. Ed.* 51, 1706 (2012)

FLOW CHEMISTRY

Microreactors

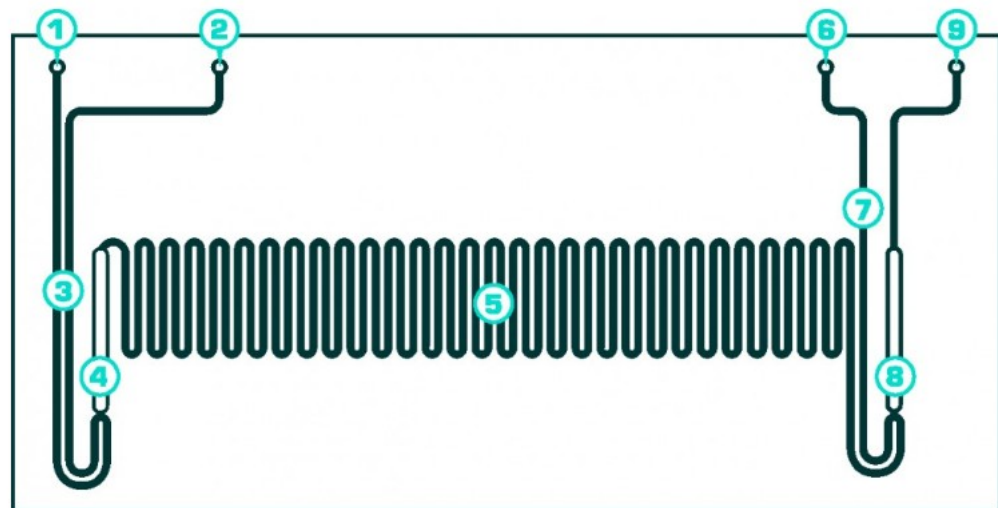

- | | | |
|----------------------------|----------------------|---------------------------|
| 1 Reactant A input | 4 SOR mixer, A&B mix | 7 Quench pre-heating |
| 2 Reactant B input | 5 Residence time | 8 SOR mixer, quench mixes |
| 3 Reactant A&B pre-heating | 6 Quench input | 9 Product output |

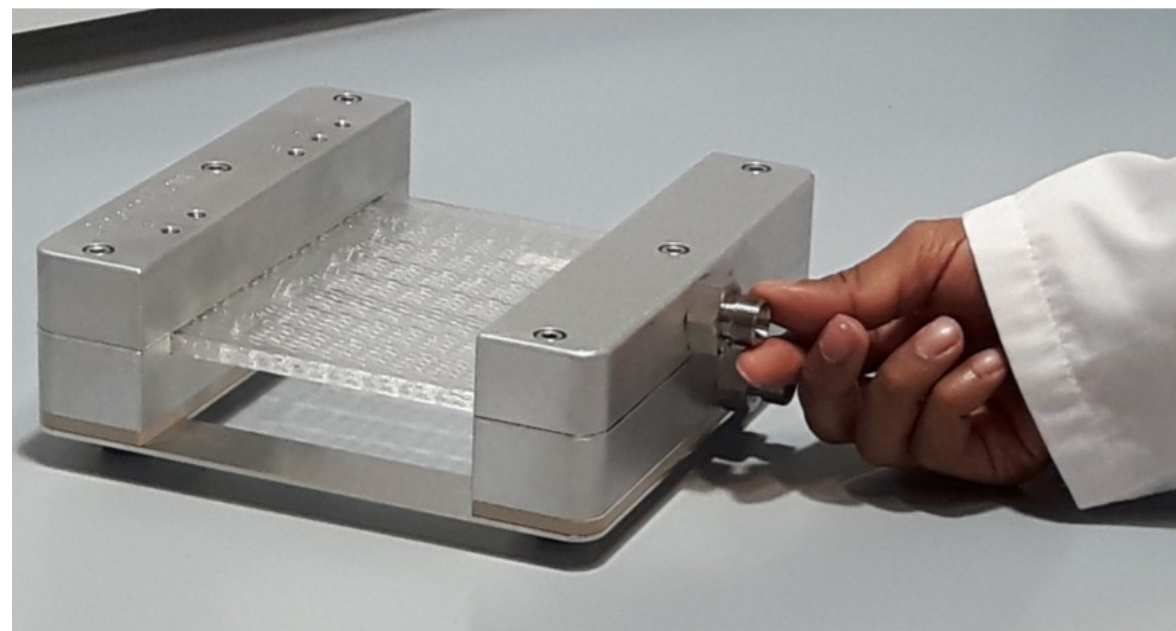

Chemtrix company microreactor

FLOW CHEMISTRY

Microreactors

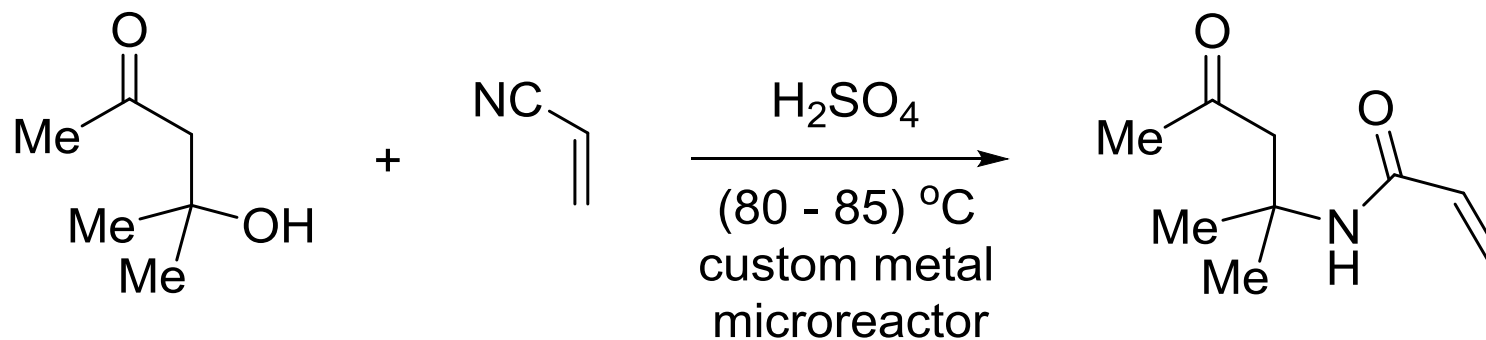

DSM company, control of the exothermic Ritter reaction on very large scale (40 tons a day);

Decreased decomposition

Yield was increased by 15%

Waste was decreased by 15%

Ondrey, G. *Chem. Eng.* 118, 17 (2011)

FLOW CHEMISTRY

DSM company

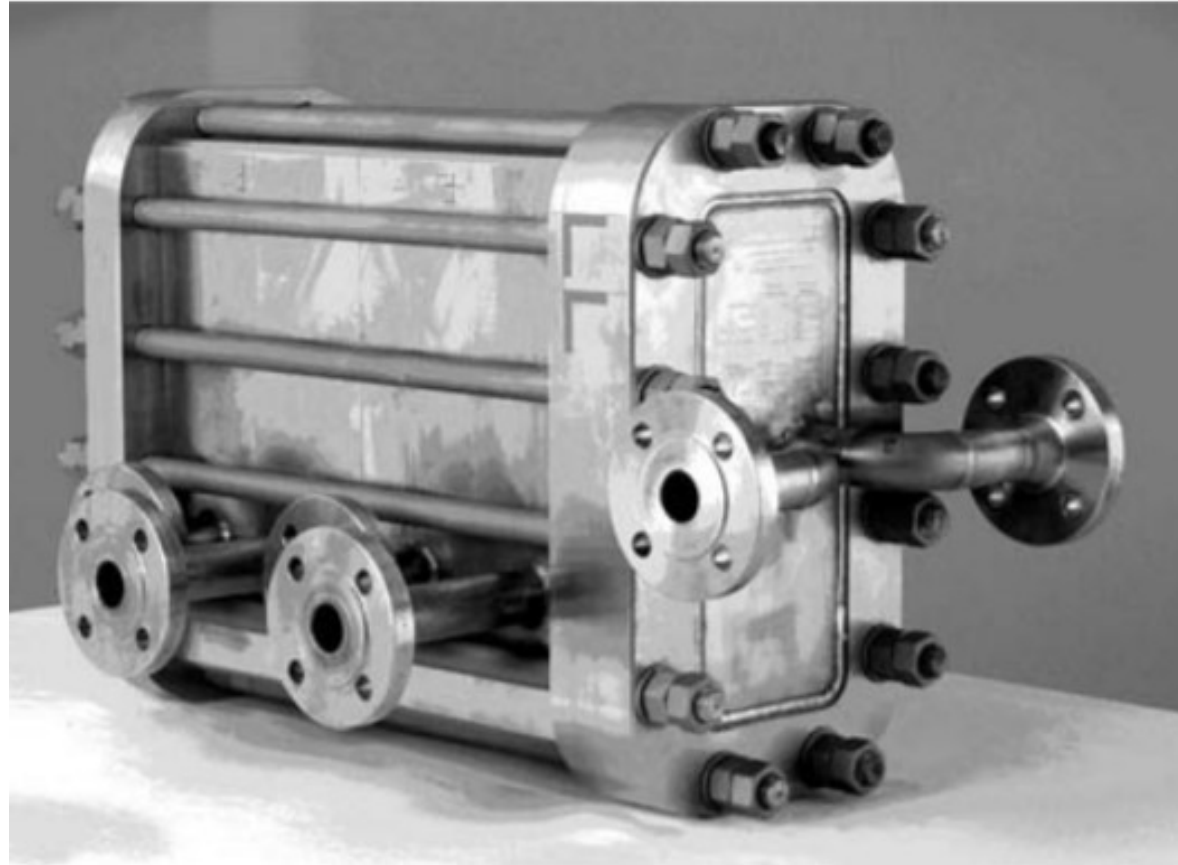

The microstructured flow reactor for throughput at 1700 kg per hour

FLOW CHEMISTRY

Microreactors

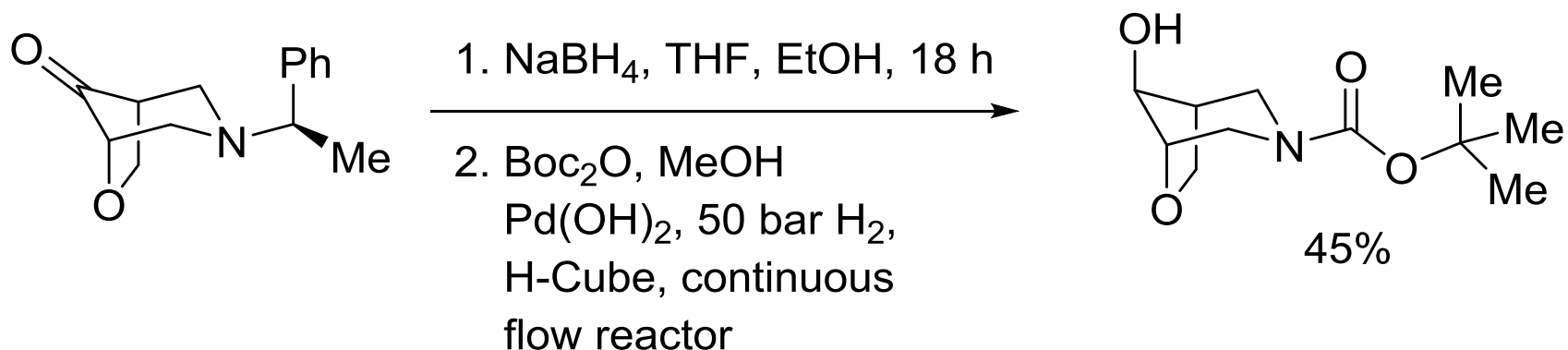

ThalesNano company
Spadoni, C. *et al Chim. Oggi* 38 (2006)



FLOW CHEMISTRY

Microreactors

Uniqsys (GB)

Run small scale reactions using sample loops or scale up using bottles

Interchange reactors in minutes. Option to wind your own coils

Run superheated chemistry routinely up to +260°C

Active pressure monitoring for unattended operation

Easy, intuitive interface for reaction set up and control

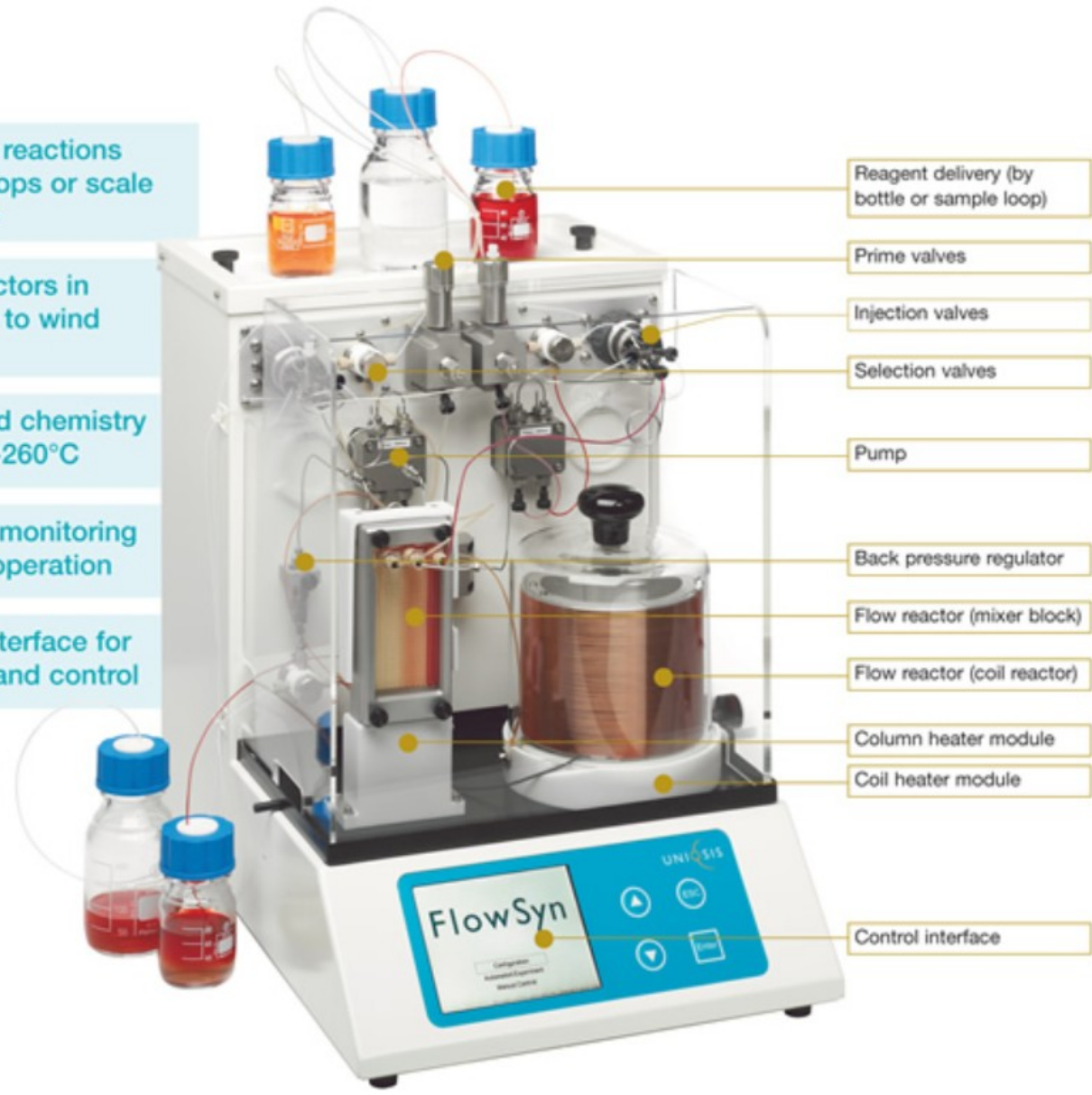

FLOW CHEMISTRY

Microreactors



Chemtrix



FLOW CHEMISTRY

Microreactors

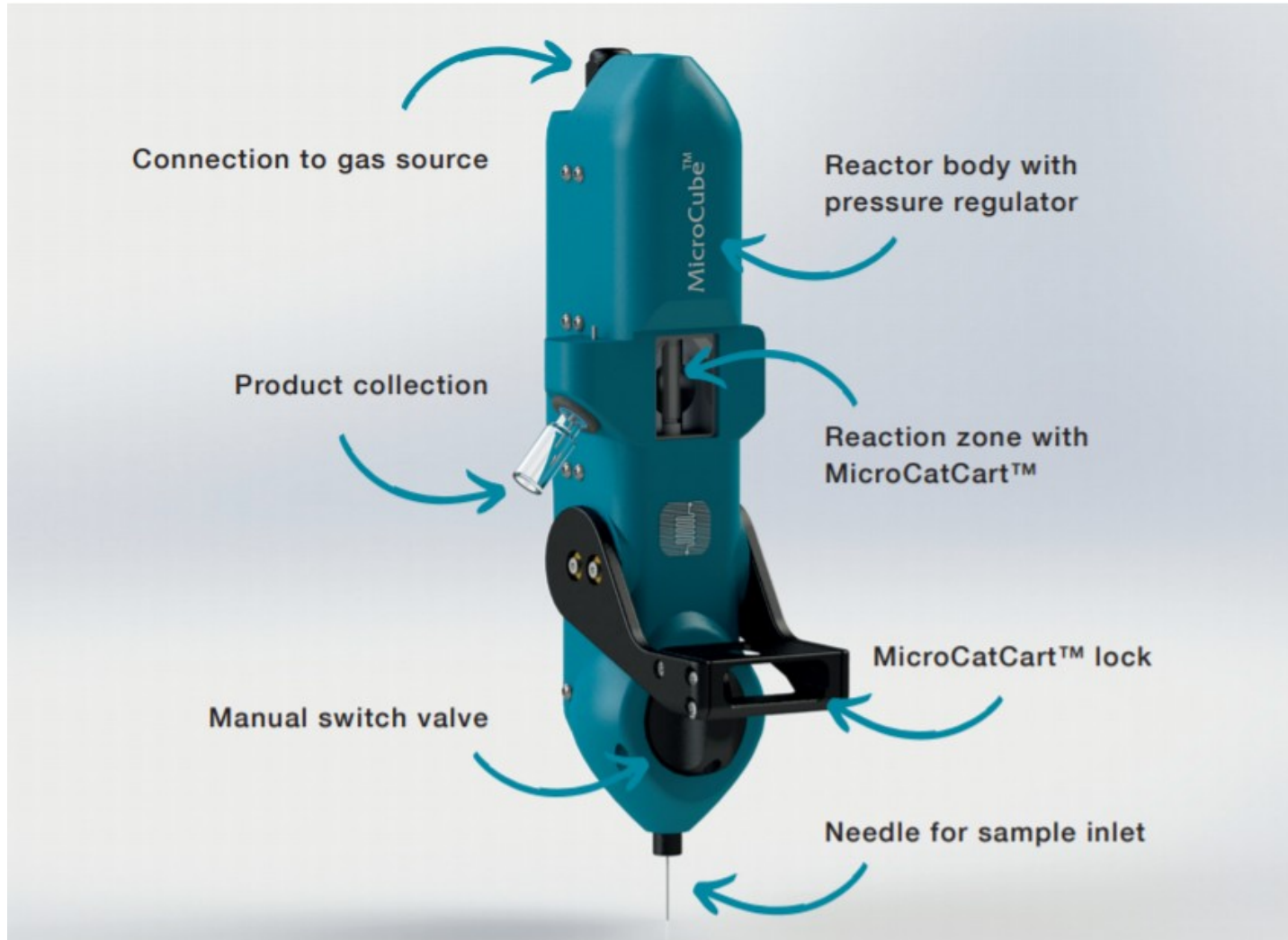

ThalesNano
1.Q 2020

MicroCube™

FLOW CHEMISTRY

Microreactors

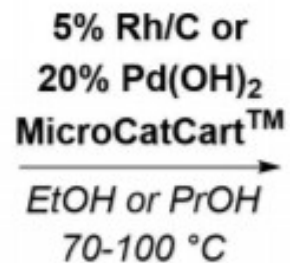
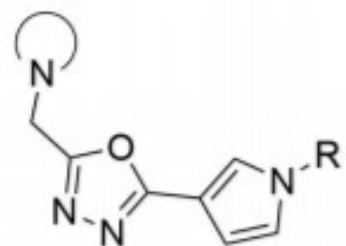

0.2 mg
5-27% conv.

10 bar H₂
1 min res. time

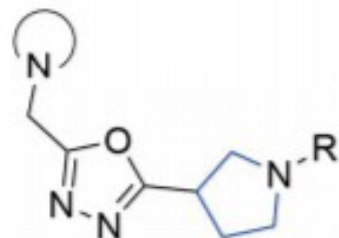

2 examples,
>99% sel.

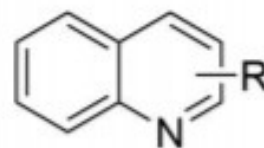

0.3 mg
37-70% conv.

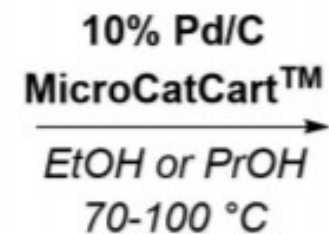

10 bar H₂
1 min res. time

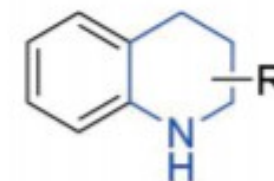

3 examples,
16-99% sel.

ThalesNano product brochure

CONTINUOUS PROCESSING

- Eli Lilly, new production unit utilizing continuous processes in Kinsale, Ireland;
Prexasertib monolactate monohydrate

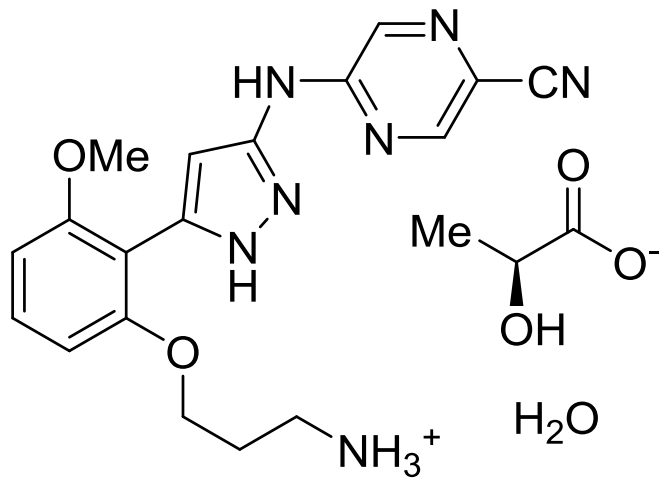

8 continuous process step, including using hydrazine;

Designated production unit, the product is cytotoxic → extensive cleaning measures, only 24 kg needed;

Small flow set up could be after each lot discarded;

Halford, B. *C&EN Global Enterprise* 95, 23 (2017)

CONTINUOUS PROCESSING

Continuous Operations Using Larger Reactors

Spinning Disk Reactor

- Thin films of reactant solution permitting rapid heat exchange;
- Solutions applied to the center of a spinning disk are driven to the edges by centrifugal forces;
- The contact time with the disk is inversely proportional to the angular velocity;
- Preferred for fast reactions;

Org. Process Res. Dev. 15, 997 (2011)

<https://www.youtube.com/watch?v=p42pCoQJ5sc>

CONTINUOUS PROCESSING

Continuous Operations Using Larger Reactors

Spinning Disk Reactor

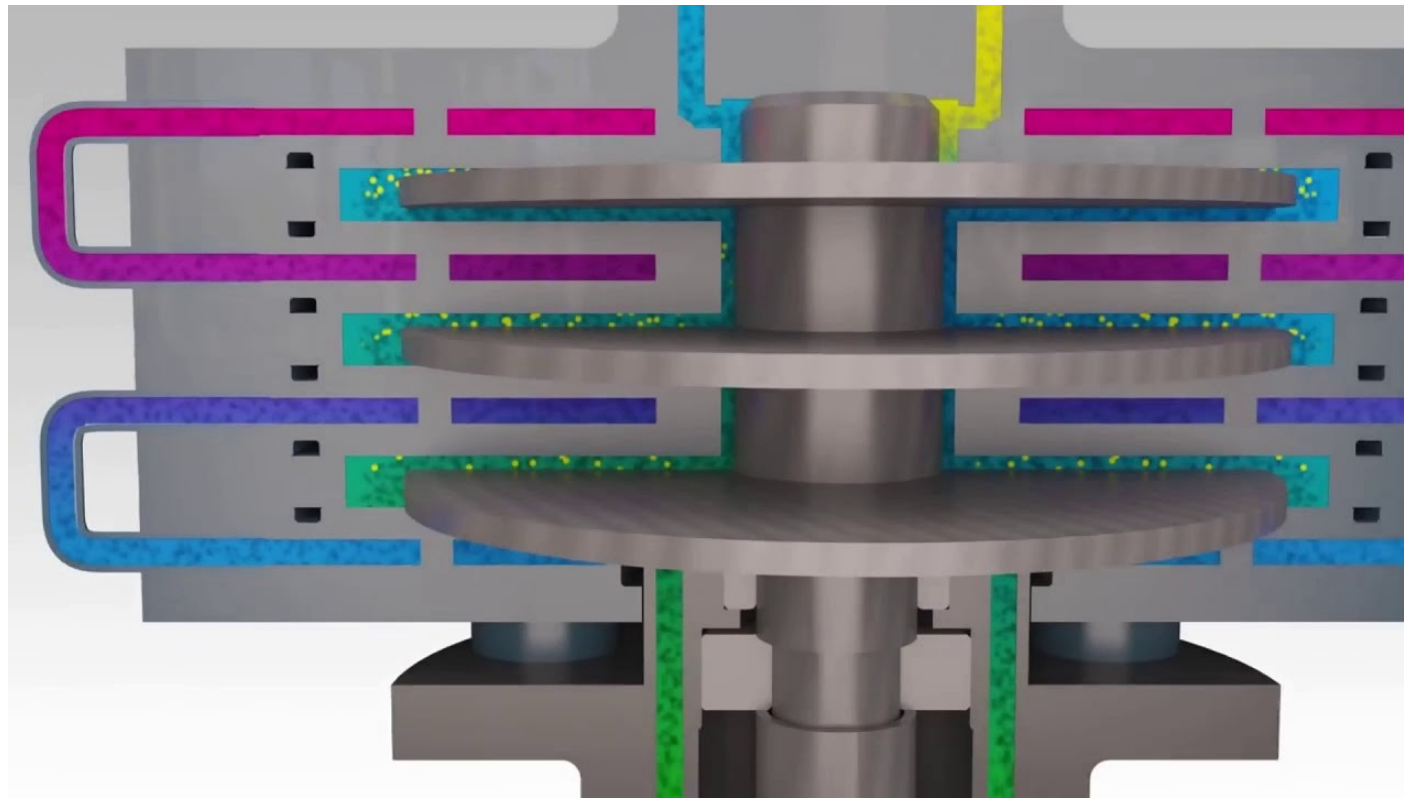

CONTINUOUS PROCESSING

Continuous Operations Using Larger Reactors

Spinning Tube-in-Tube Reactor

- Reactor of this type increases reaction rates by improving mixing through high shear rate, which is independent of the residence time and dependent upon the angular velocity and the gap between the spinning internal tube and the stationary external tube
- Gonzales, M.A. *et al Org. Process Res. Dev.* 13, 64 (2009)
- OPRD 12, 946 (2008)

CONTINUOUS PROCESSING

Continuous Operations Using Larger Reactors

Spinning Tube-in-Tube Reactor

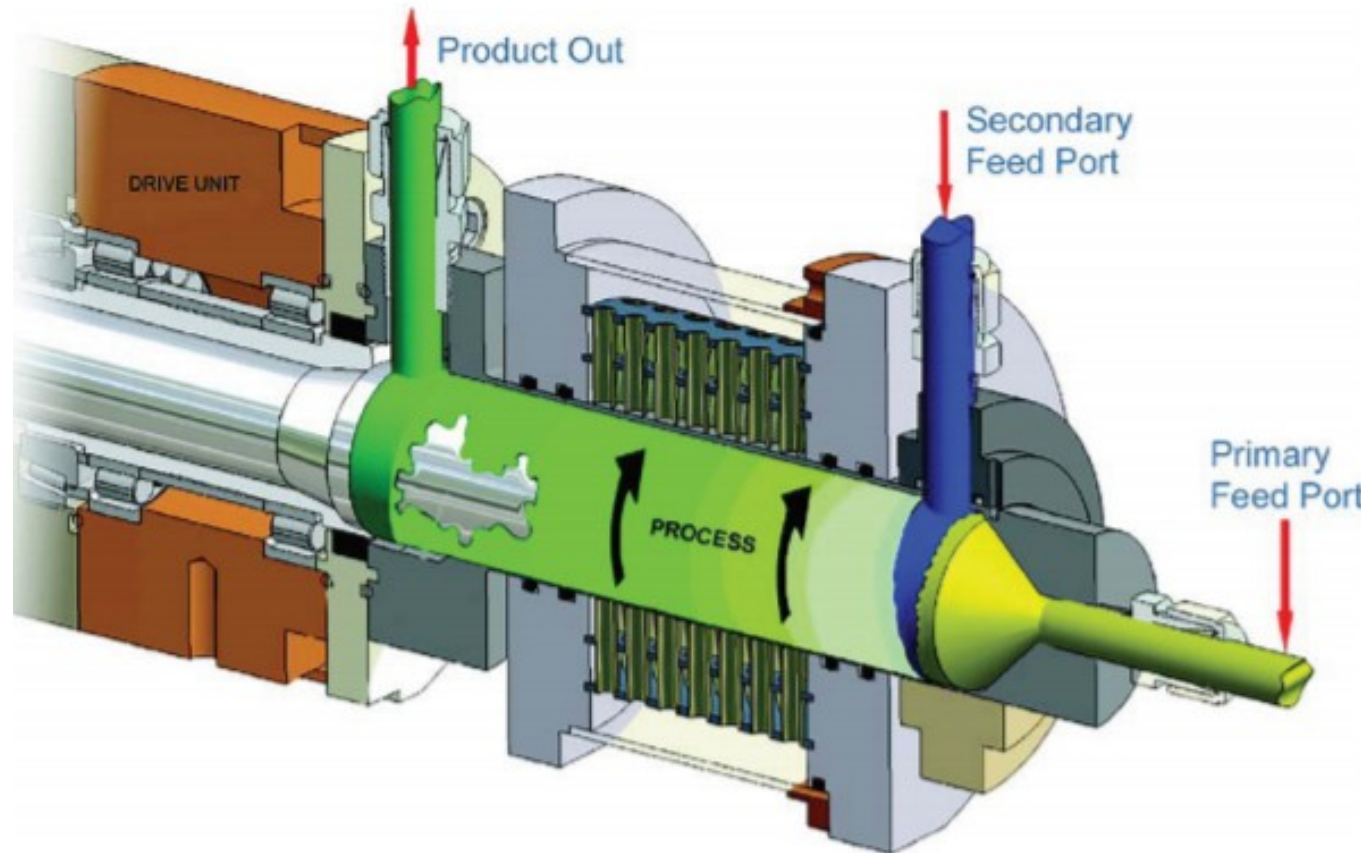



CONTINUOUS PROCESSING

Continuous Operations Using Larger Reactors

Plug Flow Reactors

- Reactants mix in thin discs (plugs) moving away from the entry point (theoretical assumption);
 - Mixing in radial direction, no mixing in axial direction;
 - The composition changes until a plug of product emerges from the reactor;
 - Turbulence can be amplified by the presence of static mixers
- 

CONTINUOUS PROCESSING

Continuous Operations Using Larger Reactors

Plug Flow Reactors

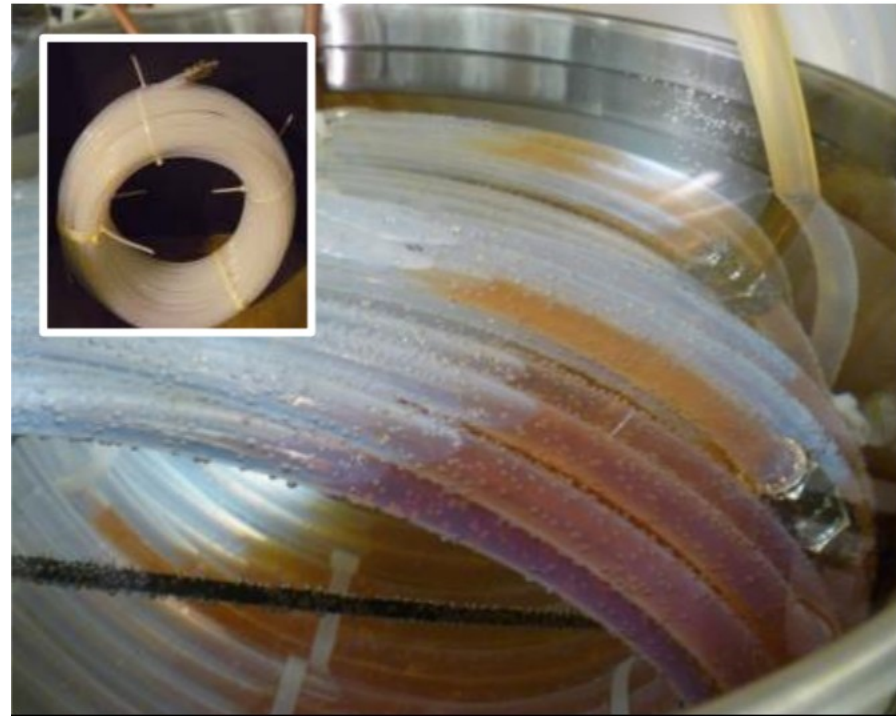

CONTINUOUS PROCESSING

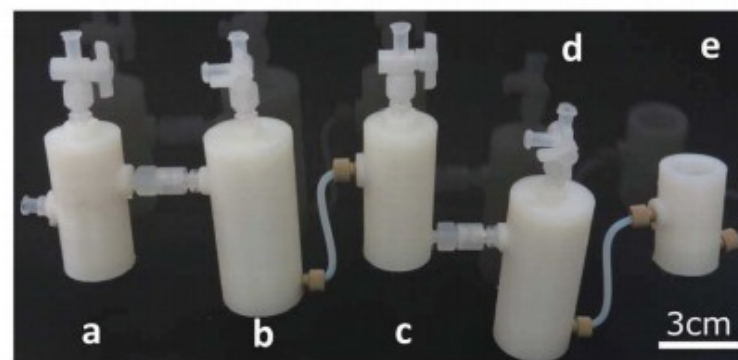
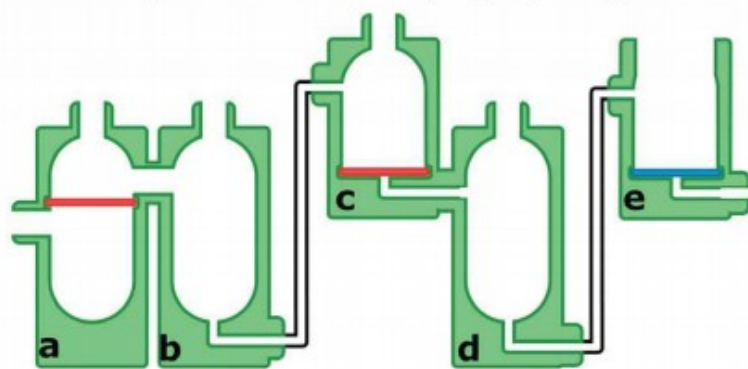
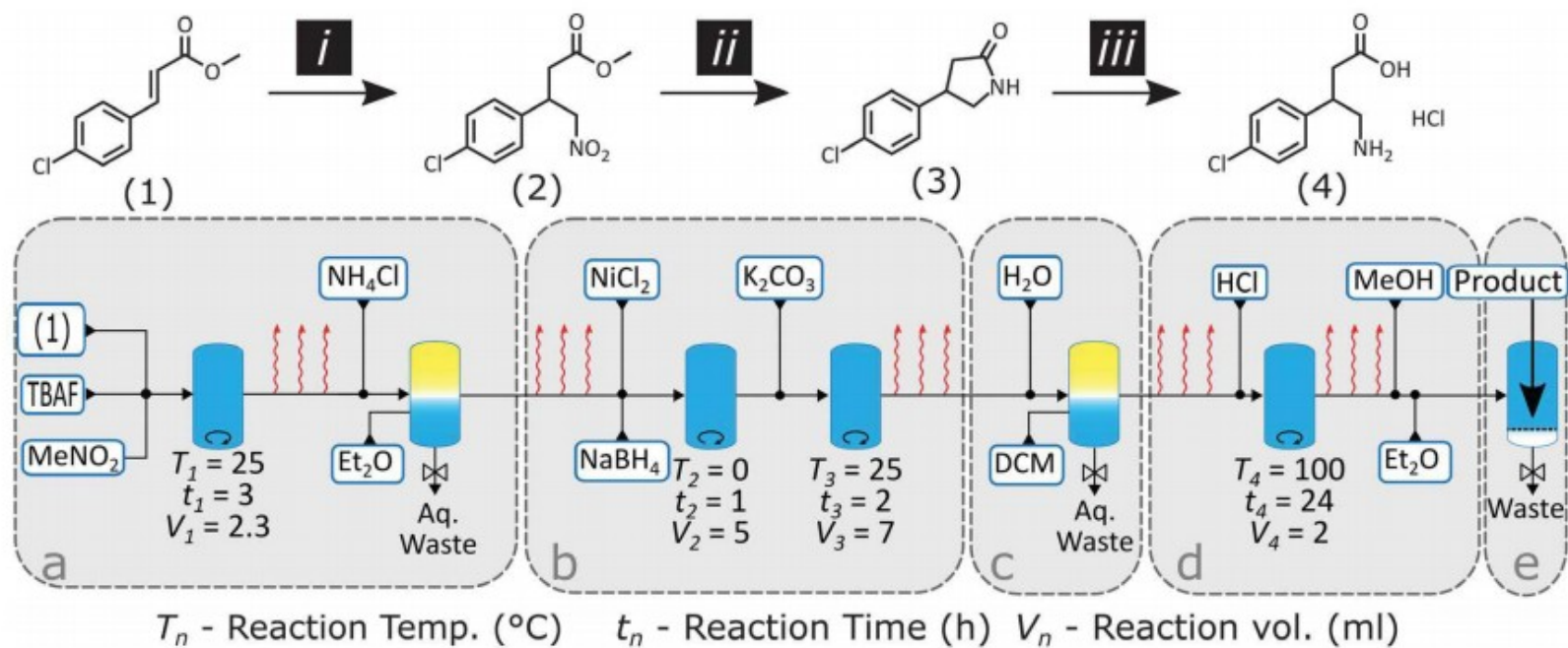



CONTINUOUS PROCESSING AND FLOW CHEMISTRY

Summary

- Used for decades in petrochemical and food industry;
 - Start to attract attention even in conservative pharmaceutical industry;
 - Going commercial – new already established companies offering service, expertise, solutions and products;
 - Boom of new materials – microreactors (glass, ceramic, metal), pumps, tubings, mixers, fittings, valves, prepacked columns);
 - Disadvantage – clogging, corrosion,
 - Lack of common experience and expertise;
 - Continuous processes are not suitable for all reactions
- 