

F4280 Technology of thin film deposition and surface treatment

5. Chemical Vaport Deposition

Lenka Zajíčková

Faculty of Science, Masaryk University, Brno &
Central European Institute of Technology - CEITEC

lenkaz@physics.muni.cz

spring semester 2021



CEITEC

Central European Institute of Technology
BRNO | CZECH REPUBLIC



Outline

- Chemical Vapor Deposition
 - 5.1 Gaseous Sources
 - 5.2 Chemical Vapor Deposition Scheme
 - 5.3 Typical Chemical Reactions in CVD
 - 5.4 Variants of CVD
 - 5.5 CVD Precursors & Gas Supply
 - 5.5.1 Precursor Requirements
 - 5.5.2 Precursor Volatility
 - 5.5.3 Gas Supply Set-up
 - 5.5.4 Contamination
 - 5.6 Chemical Reactors
 - 5.7 Understanding the Overall Reaction
 - 5.7.1 Gas-phase and surface reactions
 - 5.8 APCVD versus LPCVD
 - 5.9 MOCVD
 - 5.10 Atomic Layer Deposition
 - 5.11 Thermal Forming Processes

5.1 Gaseous Sources

Let's use practical distinguishment of gas and vapor: gas does not condense when held above room T and below 1-atm partial pressure.

Distinguishing the methods of delivery according to equilibrium vapor pressure p_v :

- ▶ sources species having $p_v < 10^{-2}$ Pa at the wall T of the deposition chamber must be “physically” evaporated (using heat or energy beams) \Rightarrow PVD processes (requiring low- p operation and “line-in-sight” geometry)
- ▶ materials with $p_v > 10^{-2}$ Pa at the wall T are used in CVD (can operate at atmospheric pressure or lower - fluid flow $K_n \ll 1$)

Most of elements, with exception of alkali metals and alkaline earths (group IA and IIA) can be converted to gases or to chemical vapors by reacting them with terminating radicals, e. g.

- ▶ H
- ▶ halogens F, Cl, Br, I
- ▶ carbonyl CO
- ▶ H-saturated organic radicals R such as methyl CH_3 and ethyl CH_2CH_3

5.2 Chemical Vapor Deposition Scheme

... constituents of the vapour phase react chemically on a substrate surface to form a solid product (**heterogeneous** reactions). Some gas-phase reactions are unavoidable due to high gas temperature. Undesirable **homogeneous** reactions in the gas phase nucleate particles that may form powdery deposits and lead to particle contamination.

Deposition Variables:

- ▶ temperature
- ▶ pressure (from low pressures, i.e., 10–1000 Pa - LPCVD, up to atmospheric pressures - APCVD)
- ▶ input concentration
- ▶ gas flow rates
- ▶ reactor geometry

Kinetics of the reactions may depend on such factors like substrate material, structure and orientation

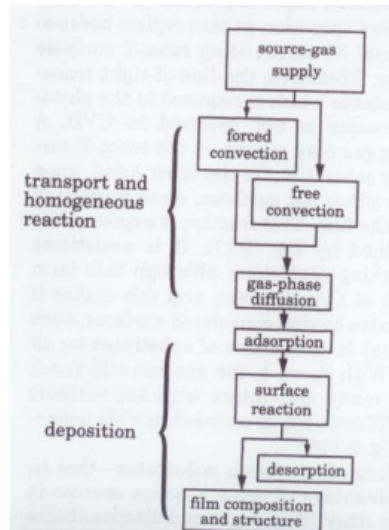

5.3 Typical Chemical Reactions in CVD

TABLE 7.1 Typical Overall Reactions Used in CVD

pyrolysis (thermal decomposition)	$\text{SiH}_4(\text{g}) \rightarrow \text{Si}(\text{c}) + 2\text{H}_2(\text{g})$
	$\text{SiH}_2\text{Cl}_2(\text{g}) \rightarrow \text{Si}(\text{c}) + 2\text{HCl}(\text{g})$
	$\text{CH}_4(\text{g}) \rightarrow \text{C}(\text{diamond or graphite}) + 2\text{H}_2(\text{g})$
	$\text{Ni}(\text{CO})_4(\text{g}) \rightarrow \text{Ni}(\text{c}) + 4\text{CO}(\text{g})$
oxidation	$\text{SiH}_4(\text{g}) + 2\text{O}_2(\text{g}) \rightarrow \text{SiO}_2(\text{c}) + 2\text{H}_2\text{O}(\text{g})$
	$3\text{SiH}_4(\text{g}) + 4\text{NH}_3(\text{g}) \rightarrow \text{Si}_3\text{N}_4(\text{c}) + 12\text{H}_2(\text{g})$
hydrolysis	$2\text{AlCl}_3(\text{g}) + 3\text{H}_2\text{O}(\text{g}) \rightarrow \text{Al}_2\text{O}_3(\text{c}) + 6\text{HCl}(\text{g})$
reduction	$\text{WF}_6(\text{g}) + 3\text{H}_2(\text{g}) \rightarrow \text{W}(\text{c}) + 6\text{HF}(\text{g})$
displacement	$\text{Ga}(\text{CH}_3)_3(\text{g}) + \text{AsH}_3(\text{g}) \rightarrow \text{GaAs}(\text{c}) + 3\text{CH}_4(\text{g})$
	$\text{ZnCl}_2(\text{g}) + \text{H}_2\text{S}(\text{g}) \rightarrow \text{ZnS}(\text{c}) + 2\text{HCl}(\text{g})$
	$2\text{TiCl}_4(\text{g}) + 2\text{NH}_3(\text{g}) + \text{H}_2(\text{g}) \rightarrow \text{TiN}(\text{c}) + 8\text{HCl}(\text{g})$

Overall CVD reactions consist of a series of steps, some in the gas phase and some on the surface.

Materials deposited at low temperatures (below 600 °C for silicon) are generally **amorphous**. Higher temperatures tend to lead to **polycrystalline** phases. Very high temperatures (typically 900–1100 °C in the case of silicon) are necessary for growing **single-crystal films**.

5.4 Variants of CVD

Most CVD reactions are thermodynamically endothermic \Rightarrow energy has to be supplied to the reacting system:

- ▶ **thermal CVD** - traditional method of energy input by a thermal energy input:
 - ▶ direct resistance heating of the substrate or substrate holder;
 - ▶ rf induction of the substrate holder or susceptor;
 - ▶ thermal radiation heating;
 - ▶ photoradiation heating.
- ▶ **hot filament CVD (HFCVD)** - electrons
- ▶ **photo-assisted CVD** - higher frequency radiation such as UV
- ▶ **plasma enhanced CVD (PECVD)** - plasma (*chapter 7*)

Other variants of CVD:

- ▶ **low pressure and atmospheric pressure CVD (LPCVD, APCVD)** - traditionally used for the deposition of polycrystalline or amorphous materials like polysilicon, silicon oxide SiO_2 , silicon nitride Si_3N_4 .
- ▶ **metal-organic chemical vapour deposition (MOCVD)** - utilizes metal-organic precursors, traditionally used for III-V compound semiconductors like AlAs, GaAs.
- ▶ **atomic layer deposition (ALD)** - gaseous precursors are introduced alternately to the reaction chamber, where they reach a saturated adsorption level on the substrate surface
- ▶ **epitaxial methods** related to CVD (*chapter 6*) - CVD epitaxy or vapour-phase epitaxy (VPE), metal-organic vapor phase epitaxy (MOVPE), chemical beam epitaxy (CBE), metal-organic molecular beam epitaxy (MOMBE), atomic layer epitaxy (ALE / ALEp)

5.5 CVD Precursors & Gas Supply

5.5.1 Precursor Requirements

Whatever form a CVD process takes, the same precursor requirements generally apply. The characteristics of an “ideal” CVD precursor can be summarised as follows:

- ▶ Adequate volatility to achieve acceptable growth rates at moderate evaporation temperatures.
- ▶ Stability so that decomposition does not occur during evaporation.
- ▶ A sufficiently large temperature “window” between evaporation and decomposition for film deposition.
- ▶ High chemical purity.
- ▶ Clean decomposition without the incorporation of residual impurities.
- ▶ Good compatibility with co-precursors during the growth of complex materials.
- ▶ Long shelf-life with indefinite stability under ambient conditions, i.e. unaffected by air or moisture.
- ▶ Readily manufactured in high yield at low cost.
- ▶ Non-hazardous or with a low hazard risk.

Although these features are common for most CVD precursors, sometimes the precise precursor requirements can depend on the specific nature of the CVD process.

A. C. Jones, M. L. Hitchman, Overview of Chemical Vapour Deposition in Chemical Vapour Deposition: Precursors, Processes and Applications, Eds A. C. Jones and M. L. Hitchman, Royal Society of Chemistry 2009

5.5 CVD Precursors & Gas Supply

5.5.2 Precursor Volatility

Adequate volatility necessary - With precursors that occur naturally in a gaseous state (e.g. silane, diborane, ammonia, etc.) this is not a problem. However, for precursors that are liquids or solids, volatility has to be studied.

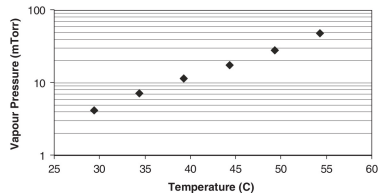
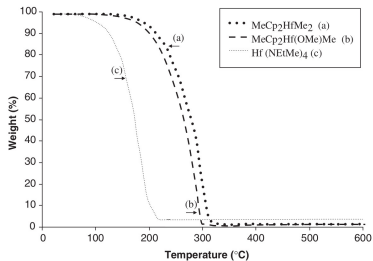

Vapour pressure data for Ta(NMe₂)₅

Thermogravimetric analysis of different Hf precursors

5.5 CVD Precursors & Gas Supply

5.5.3 Gas Supply Set-up

Schematic of a typical MOCVD reactor used for the deposition of III-V semiconductor films.

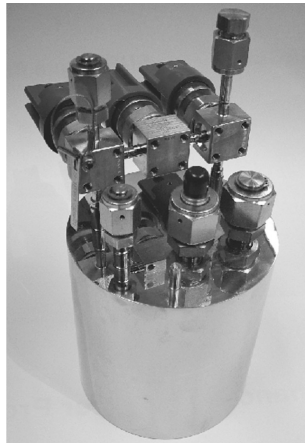
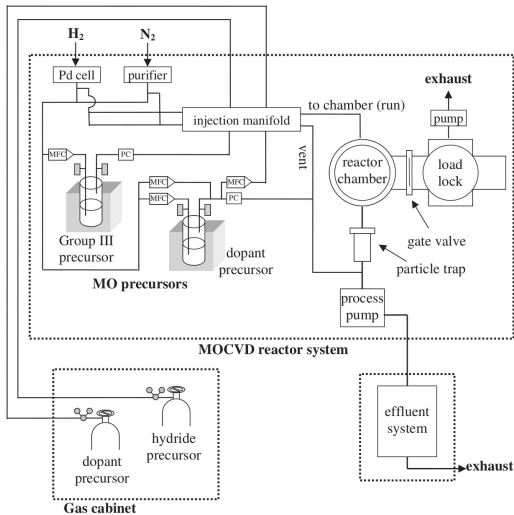

A commercial "bubbler" used to evaporate metal-organic compounds for MOCVD.

5.5 CVD Precursors & Gas Supply

General gas supply set-up ensuring the safety (D. Smith, Figure 7.2)

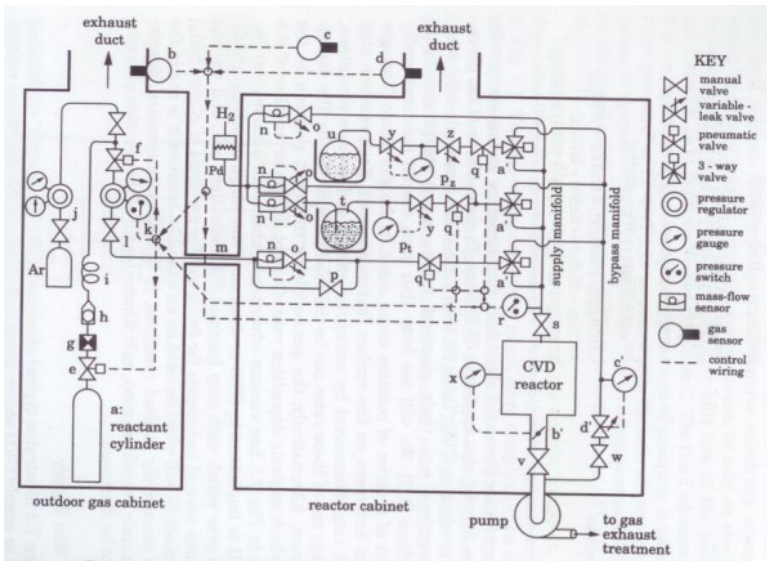

Flow control

thermal mass-flow controller schematic

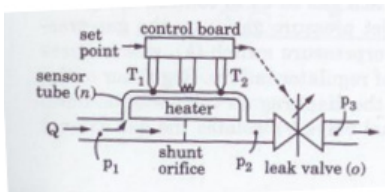

Determination of flow from change of pressure in the closed chamber:

$$Q = \frac{\Delta p}{\Delta t} \frac{V}{p_{atm}}$$

[Q]=sccm for [V]=cm³ and [Δt]=min

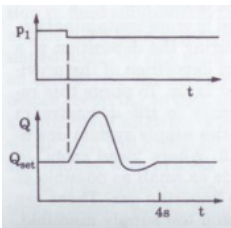

5.5 CVD Precursors & Gas Supply

5.5.4 Contamination

Impurities can occur in the gas or liquid **as supplied by the manufacturer**. Carrier gases are available in very high purity but final purification at the reactor may still be desired

- ▶ for H_2 - diffusing through hot Pd foil (blocks other gases)
- ▶ inter gases (e.g. Ar) - passing through “getters” (contain reactive surface that chemisorbs reactive impurities)
- ▶ water and O_2 can be removed by bubbling through Ga-In-Al alloy (liquid at room T)

Impurities can also intrude during vapor transport

- ▶ cleaning of reactor

- until outgassing stops. It is pressure dependent only if the partial pressure of the outgassing species begins to approach its p_v . Either pumping to low pressure (low pressure systems) or purging with carrier gas (atmospheric pressure systems). Beware of contamination from backstreaming of pump oil (for low pressure systems).

- ▶ cross-contamination

due to switching during the deposition of multilayers - gas remaining upstream from the deposition of the previous layer becomes contaminant for the next layer → purging (high downstream gas velocity for quick process), problem of “dead spots“

5.6 Chemical Reactors

Chemical reactors must provide several basic functions:

- ▶ transport of the reactant and diluent gases to the reaction site,
- ▶ provide activation energy to the reactants (heat, radiation, plasma),
- ▶ maintain a specific system pressure and temperature,
- ▶ allow the chemical processes for thin film deposition to proceed optimally,
- ▶ remove the by-product gases and vapours.

Reactor geometries in the view of laminar flow

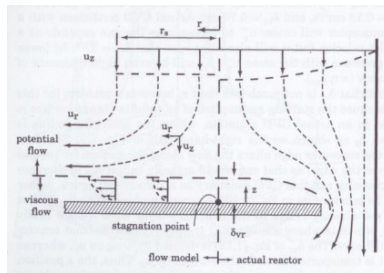
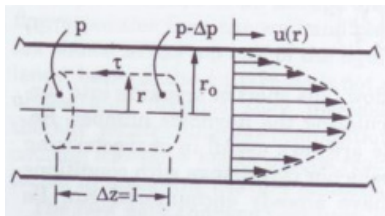
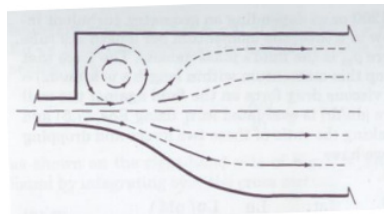
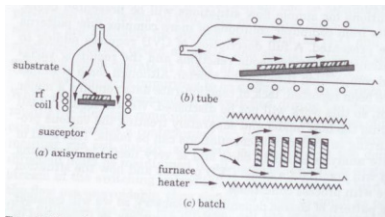

Reactor geometries in the view of gas mixing

Reactor geometry affects the gas flow characteristics which, in turn affect the properties of the deposited layer. Two basic flow type reactors:

- ▶ Displacement or **plug flow reactor** in which the entering gas displaces the gas already present with no intermixing of successive fluid elements. Plug flow is a simplified and idealized picture of the motion of a fluid, whereby all the fluid elements move with a uniform velocity along parallel streamlines. Mass balance for reactant A involved in a single reaction is very simple: $F_A - (F_A + dF_A) = r_A dV$.
- ▶ **Perfectly mixed flow reactor** is the opposite extreme from the plug flow reactor. To approach the ideal mixing pattern, the feed has to be intimately mixed with the contents of the reactor in a time interval that is very small compared to the mean residence time of the fluid flowing through the vessel. The essential feature is the assumption of complete uniformity of concentration and temperature throughout the reactor.

5.7 Understanding the Overall Reaction

Chemical equilibrium

Gibbs free energies of formation for selected gaseous and solid (c) compounds at 10^5 Pa:

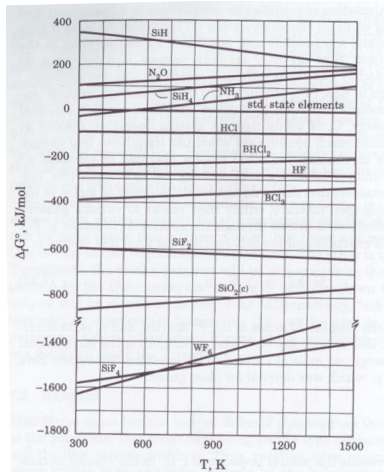

Calculated equilibrium CVD phase diagram for deposition of Si borides from $\text{BCl}_3 + \text{SiH}_4$

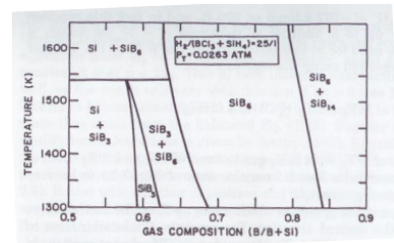

5.7 Understanding the Overall Reaction

5.7.1 Gas-phase and surface reactions

assumed to be important in the thermal deposition of Si from SiH_4 gas (k_i reaction rate constant, M third body in a reactive collision, D_i gas diffusivities, S_{ci} sticking coefficients)

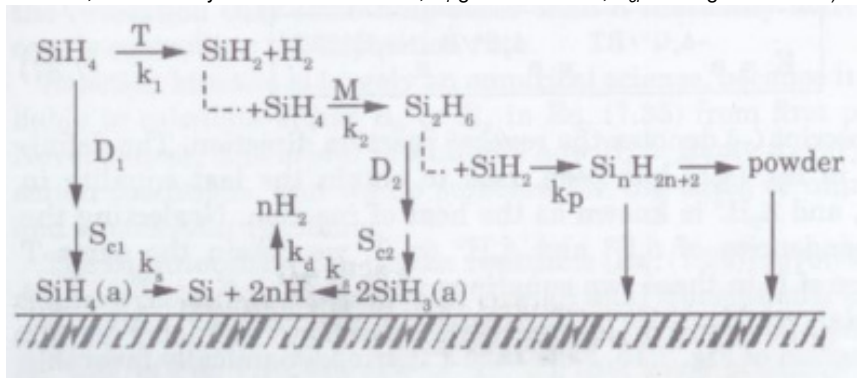

5.8 APCVD versus LPCVD

The deposition of thin films for semiconductor device manufacture by CVD at atmospheric pressure (APCVD) was a widely accepted process in 80ties.

In 1976 the equipment for low-pressure CVD (LPCVD) was introduced into the marketplace. At that time, the 3-inch wafer was the predominantly wafer size used in production with some residual presence of smaller wafers and the 4-inch wafer just being introduced into advanced lines.

In the next few years, the LPCVD process became the preferred method for chemical vapour deposition of thin films. The transformation to a new technology that required massive capital expenditure for new equipment took place at a rapid rate throughout the industry. The reason for this rapid change were:

- ▶ a superior film quality,
- ▶ a greatly reduced processing cost, and
- ▶ greatly increased throughput per unit of capital investment.

(Improved film quality increased yields and decreased unit costs in an industry that was becoming increasingly competitive.)

CVD of SiO₂

Initial techniques for depositing films of SiO₂ employed atmospheric pressure reactors (APCVD) using silane (SiH₄) and oxygen, injected as separate gases, the surface reaction on the heated wafer, typically at 400 °C, grew films in the 200 to 300 nm/min range.

Another approach to overcome APCVD SiH₄ limitations (gas phase decomposition, poor step coverage): tetraethoxysilane (TEOS) with ozone at moderate temperatures ⇒ growth of good oxide films at 400 °C with growth rates of 100 nm/min or more. The advantages provided by the TEOS/ozone based films are excellent step coverage resulting from the high surface mobility of the reactants prior to formation of SiO₂.

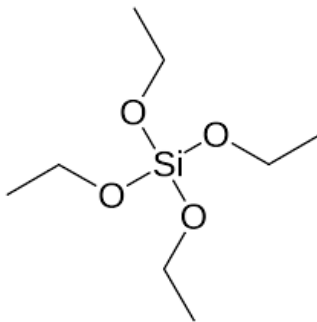

5.9 MOCVD

In the strictest sense a metal-organic (or organometallic) compound contains a direct metal-carbon bond (s or p) (e.g. metal alkyls, metal carbonyls). However, the definition of MOCVD has broadened to include precursors containing metal-oxygen bonds (e.g. metal-alkoxides, metal-b-diketonates) or metal-nitrogen bonds (e.g. metal alkylamides), and even metal hydrides (e.g. trimethylamine alane).

A very high thermal stability (e.g. as in metal halides) can be a severe disadvantage in MOCVD, especially in microelectronics applications where low deposition temperatures ($< 500\text{ }^{\circ}\text{C}$) are often required.

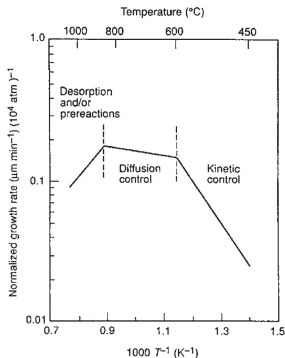

The dependence of film growth rate on substrate temperature is typified by the growth of GaAs by MOCVD using Me_3Ga and AsH_3 . Three regions are apparent.

At lower T the growth rate is controlled by the kinetics of chemical reactions occurring either in the gas-phase or on the substrate surface. This region is generally termed the region of kinetic growth control and the film growth rate increases exponentially with substrate temperature according to the Arrhenius equation.

As T increases, the growth rate becomes nearly independent of temperature and is controlled by the mass transport of reagents through the boundary layer to the growth surface, and this is termed the region of mass transport or diffusion-controlled growth.

5.10 Atomic Layer Deposition

General sketch of metal oxide ALD

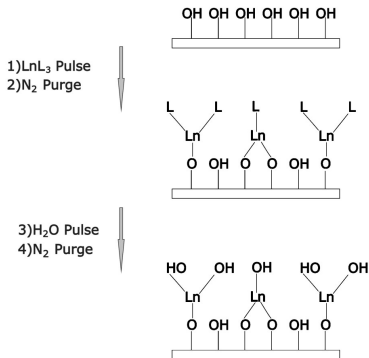

Example of other precursors with large ligands

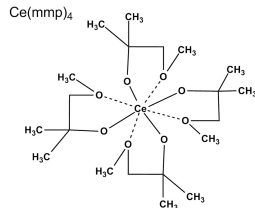
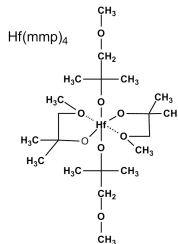

<https://www.youtube.com/watch?v=HUs0MnV65jk> This example shows the ALD chemistry for producing HfO_2 from gaseous precursors HfCl_4 (Cl=green) and H_2O (O=red). ALD allows a uniform coating to be applied to complex objects - such as the inside of the fibre optic cable shown here.

<https://www.youtube.com/watch?v=XMda8TXLIFk> Deposition of TiO_2 using TiCl_4 and H_2O .

5.10 Atomic Layer Deposition

A well-designed ALD precursor will demonstrate an experimental 'ALD window' in which its deposition is truly self-limiting.

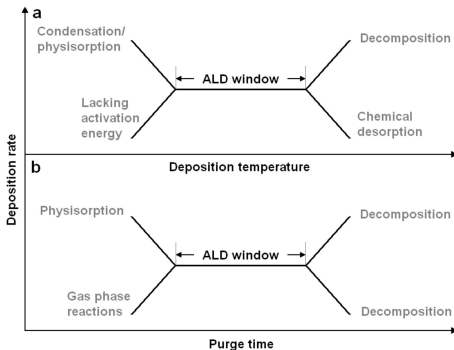

In Fig. a, the window is a plateau of growth over a range of temperatures:

For low T the process will demonstrate either low deposition rates from the reaction lacking the thermal energy necessary for chemisorption of the precursor on the substrate surface or too high a rate owing to condensation and physisorption of semi-reacted precursor material on the surface.

In the steady plateau the ALD process is demonstrating self-limiting deposition for the temperature range.

Over a certain T there is the danger of precursor decomposition, the ligand structure protecting the target atom falling apart, or chemical desorption of the precursor before the second precursor has had chance to react with the resulting surface.

5.11 Thermal Forming Processes

In the gas phase, **thermal oxidation and nitridation** is a chemical thin-film forming process in which the **substrate itself provides the source for the metal or semiconductor constituent** of the oxide and nitride, respectively. This technique is obviously much more limited than CVD.

The **thermal oxidation**

- ▶ extremely important applications in Si device technology (very high purity oxide films with high quality Si/SiO₂ interface are required).
- ▶ **Thermal oxidation of silicon** surfaces produces glassy films of SiO₂ for protecting highly sensitive p-n junctions and for creating dielectric layers for MOS devices.
 - ▶ $T = 700 - 1200$ °C
 - ▶ dry oxygen or water vapour (steam) as the oxidant; steam oxidation proceeds at a much faster rate than dry oxidation
 - ▶ The oxidation rate is a function of the oxidant partial pressure and is controlled essentially by the rate of oxidant diffusion through the growing SiO₂ layer interface, resulting in a decrease of the growth rate with increased oxide thickness.
 - ▶ The process is frequently conducted in the presence of hydrochloric acid vapours or vapours of chlorine-containing organic compounds. The HCl vapour formed acts as an effective impurity getter, improving the Si/SiO₂ interface properties and stability.
 - ▶ **Si oxidation under elevated pressure** is of technological interest where the temperature must be minimized (VLSI devices): oxidation rate of silicon is $\approx p \Rightarrow$ higher product throughput and/or decreased temperatures. Oxidant: H₂O, p up to 10 atm, T usually 750–950 °C.

Gas-phase **oxidation of other materials** is of limited technical importance. Examples: metallic Ta films converted by thermal oxidation to tantalum pentoxide for use as antireflection coating in photovoltaic devices and as capacitor elements in microcircuits. Other metal oxides grown thermally: capacitor dielectrics in thin-film devices, improve the bonding with glass in glass-to metal seals, improve corrosion resistance.