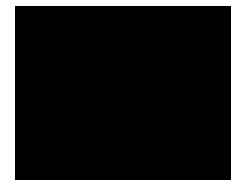
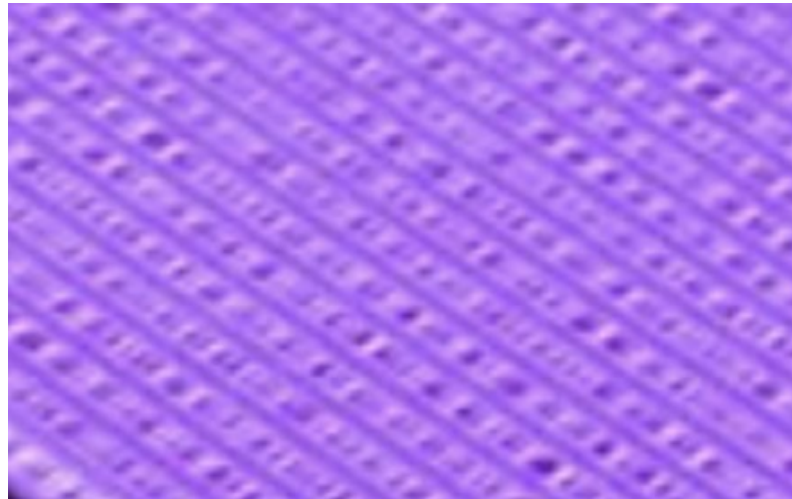


## Plasma Physics 2

---

### 6. Dielectric barrier discharge

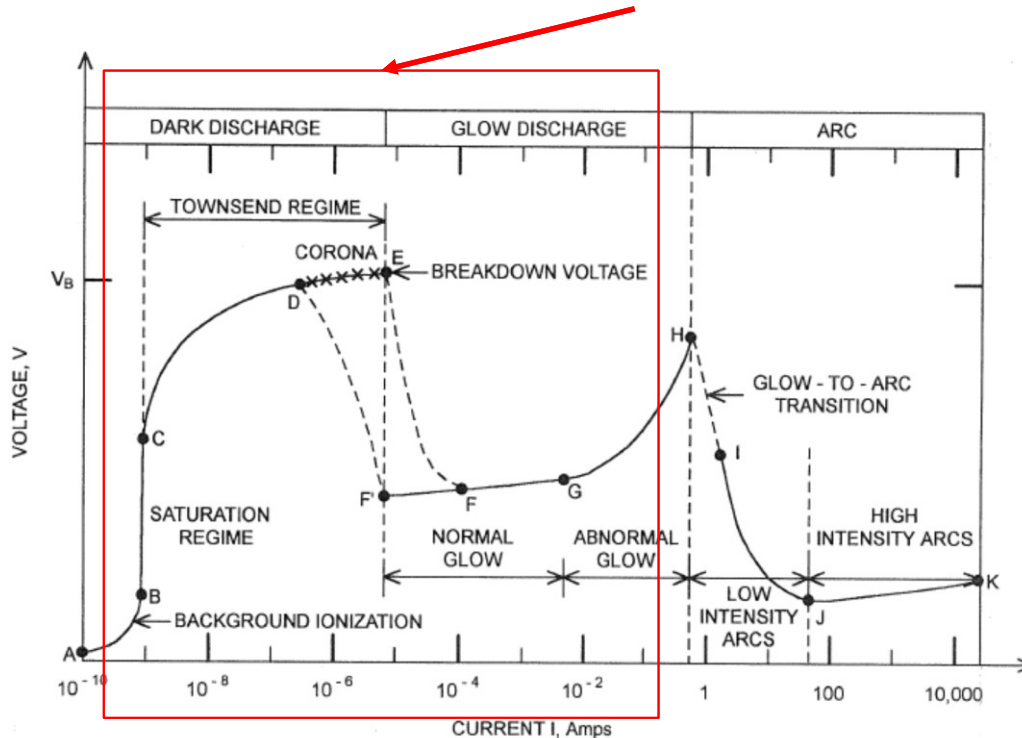


# Lecture series contents

1. Townsend breakdown theory, Paschen's law
2. Glow discharge
3. Electric arc at low and high pressures
4. Magnetized low-pressure plasmas and their role in material deposition methods.
5. Brief introduction to high-frequency discharges
6. Streamer breakdown theory, corona discharge, spark discharge
7. **Barrier discharges**
8. Leader discharge mechanism, ionization and discharges in planetary atmospheres
9. Discharges in liquids, complex and quantum plasmas
10. Thermonuclear fusion, Lawson criterion, magnetic confinement systems, plasma heating and inertial confinement fusion.

# Where are we in the IV chart?

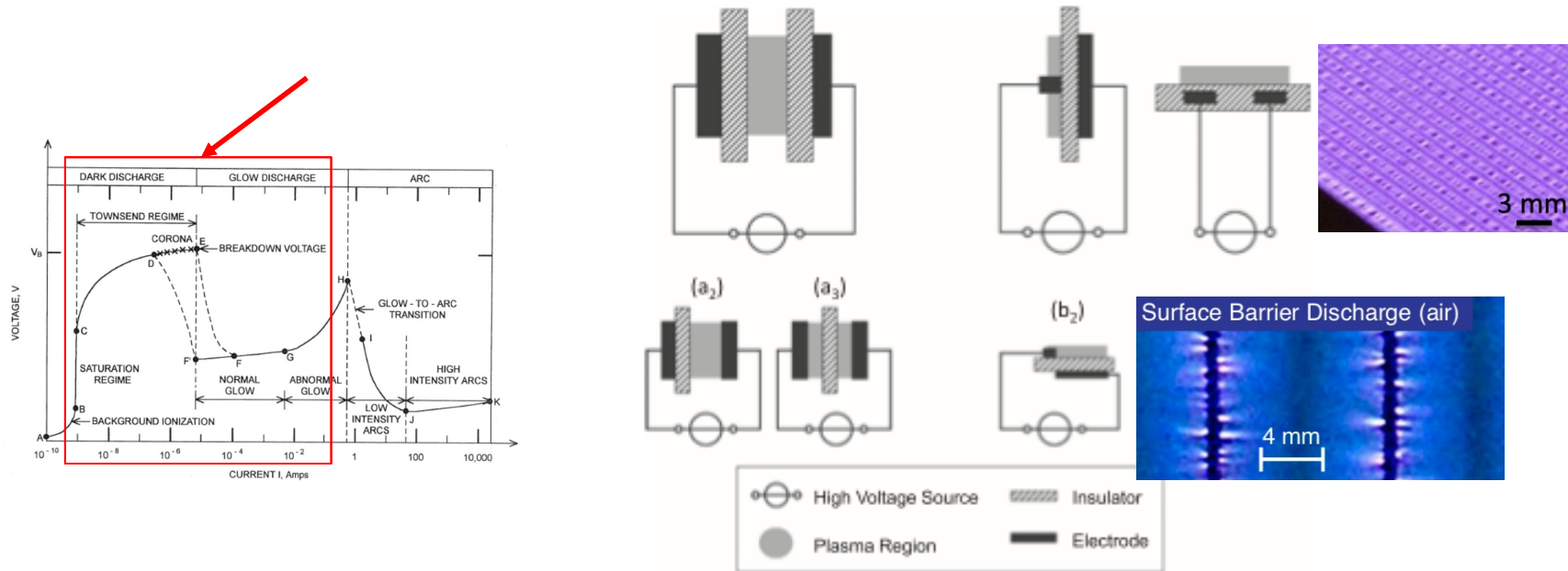
- We have seen last time that the deformation of the E field in various real-life scenarios leads to a formation of non-uniform discharge structures (streamers, arcs, coronas).
- Today, we are expanding further on those by analyzing DBDs which operate in Townsend/Glow part of the IV characteristic



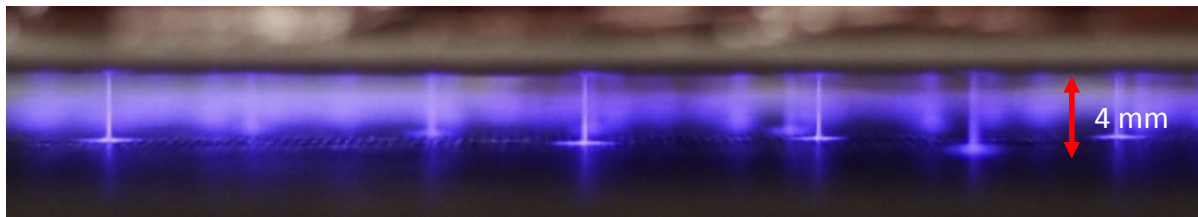
volt-ampérová charakteristika elektrických DC výbojů  
(vznik jednoho mikro-výboje bariérového výboje můžeme  
pro daný čas uvažovat jako DC)

# Barrier discharge fundamentals

- A barrier discharge is characterized by the fact that there is a dielectric between the electrodes, preventing the formation of a conductive channel – an electrical short cannot occur
- Some fundamental configs (Brandenburg 2017):

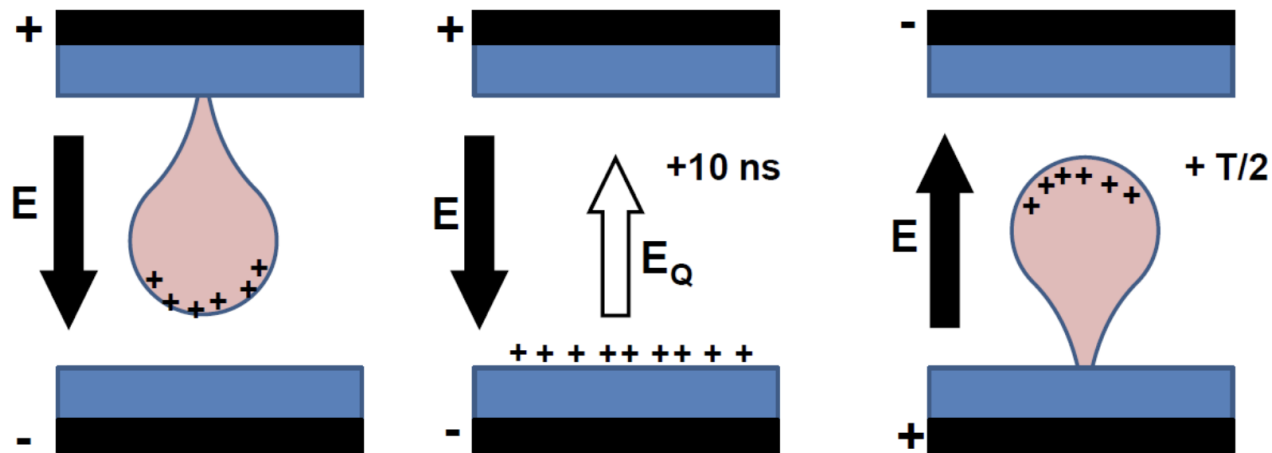


- Often filamentary, here is a glow discharge at the atm. pressure:



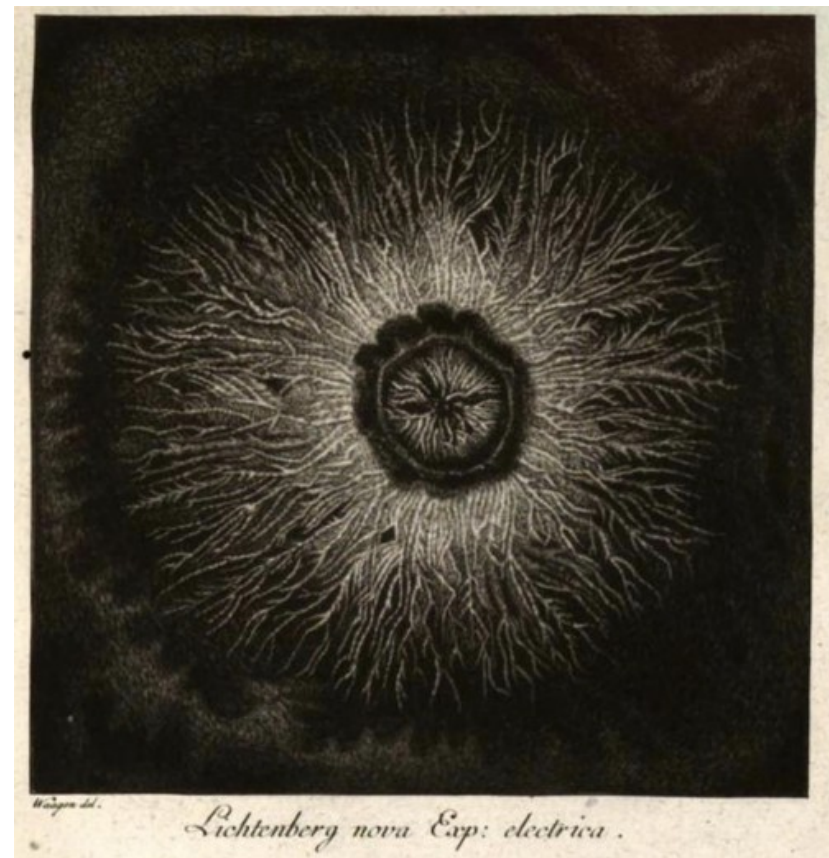
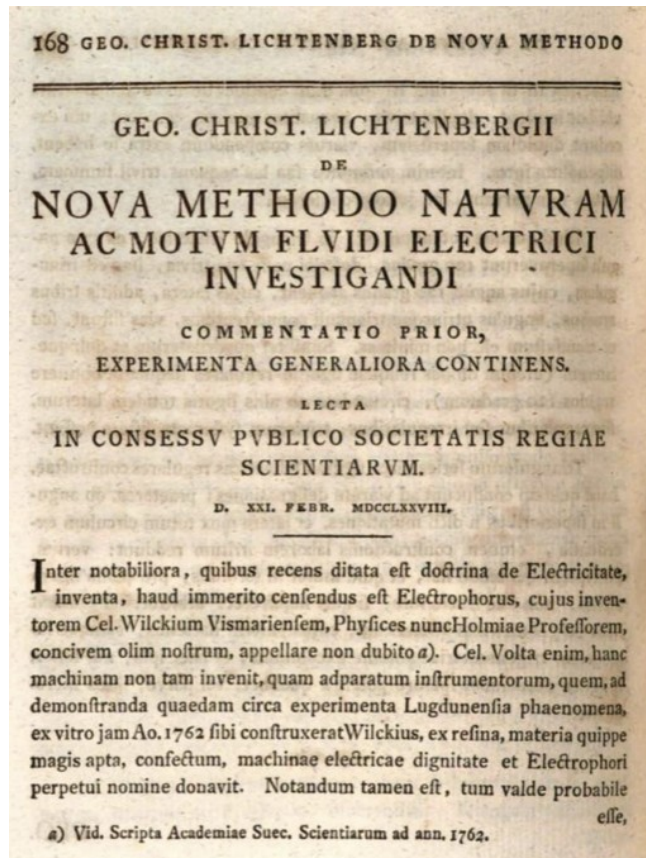
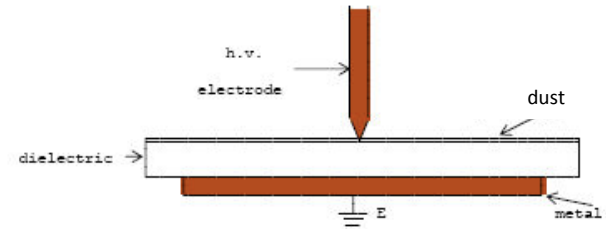
# General barrier discharge mechanism

- (Dielectric) barrier discharge occurs between electrodes, at least one of which is covered by a dielectric.
- An important driver for DBD formation is charge accumulation on the dielectric.
- When described by an equivalent circuit, it behaves like a capacitor.
- Due to the dielectric, it **always has to be driven by an AC field**



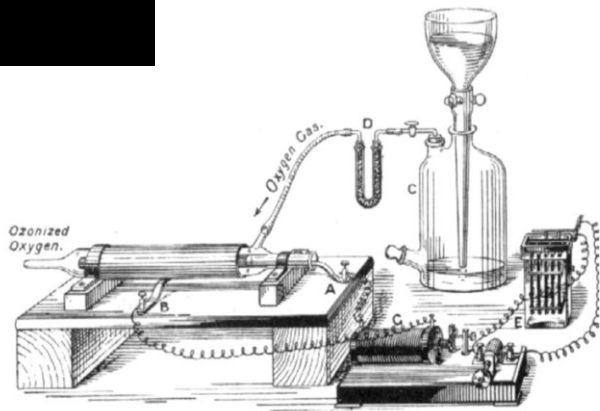
# Dielectric barrier discharge – ancient history

- Ancient history - G.C.Lichtenberg (1777):

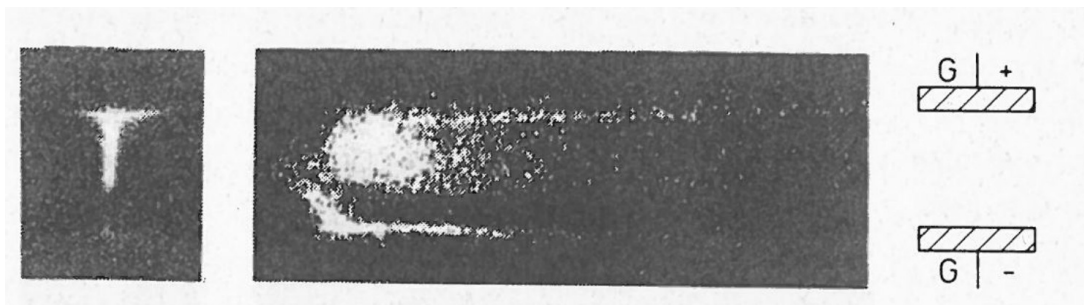
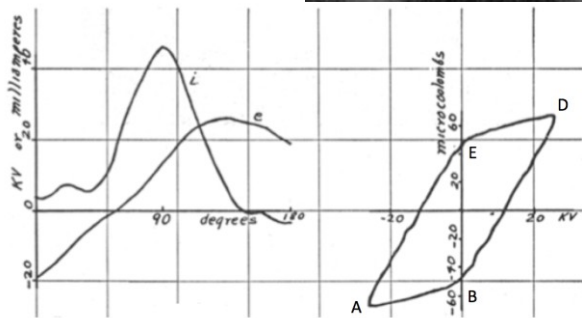
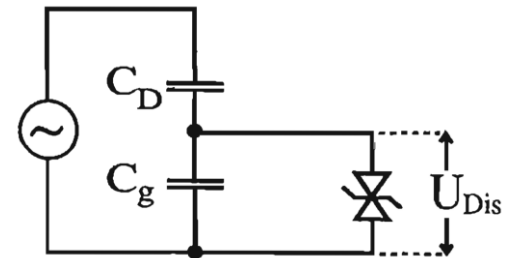
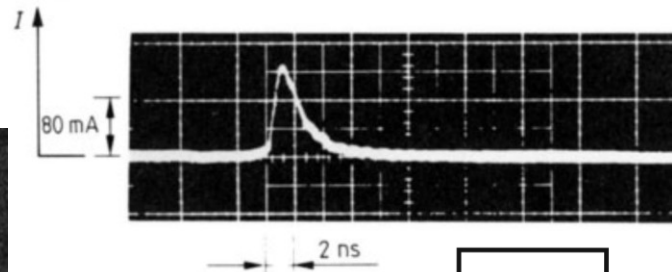
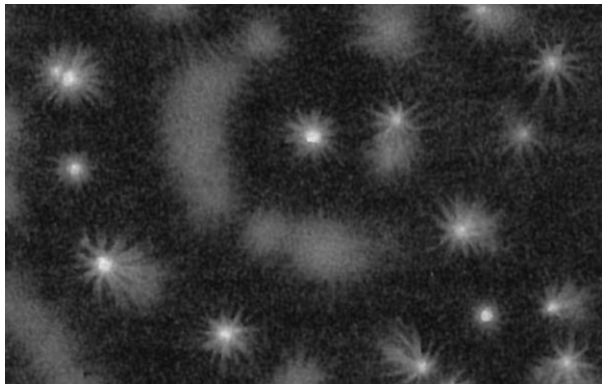




# Brief history of the dielectric barrier discharge



- Ozone generation, Lichtenberg figures, streak measurements.

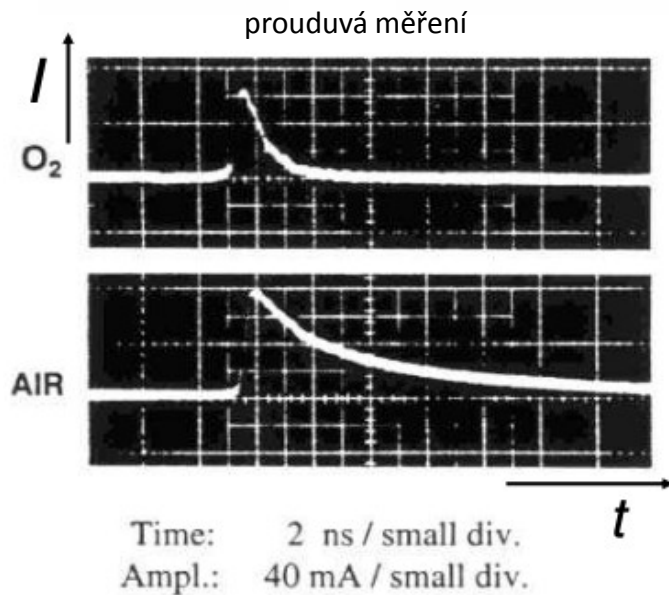
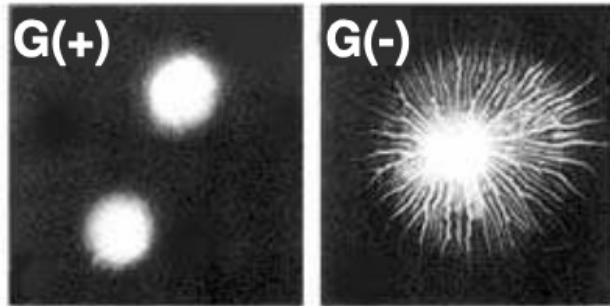


W. Siemens 1857 and Buss 1932, Klemenc 1937, Manley 1943, Samoilovich 1966, Gibalov 1981, Eliasson, Kogelschatz 1983, Heuser 1985, Okazaki 1993, Zhu, Hidaka 1996, Guikema 2000, Kozlov 2001, Wagner 2010

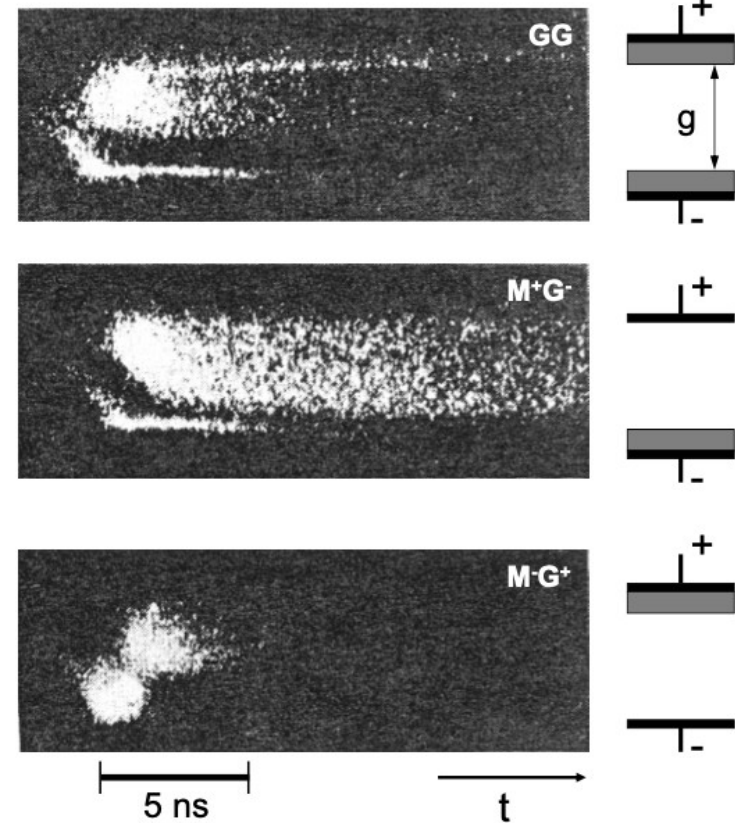
# Initial observations of DBD discharges

- Optical and electrical studies historically performed in Aachen (Pietsch, Heuser, Gibalov) and in ABB (Hirth, Kogelschatz, Eliasson):

Lichtenberg figures



Streak camera – pulsed barrier discharge

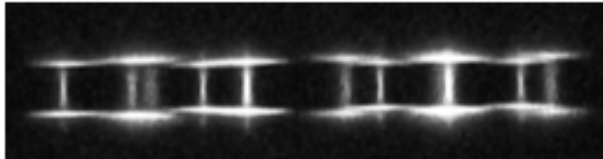




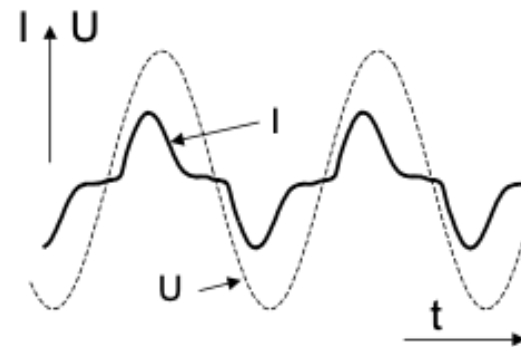
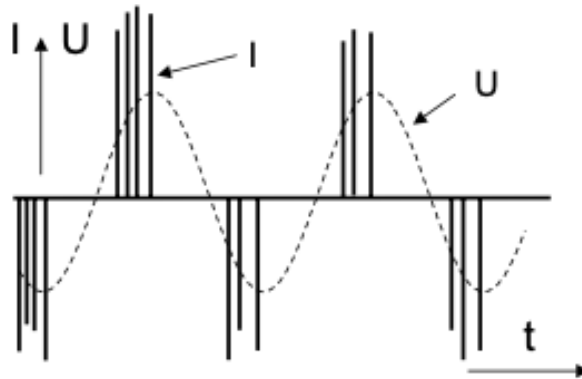
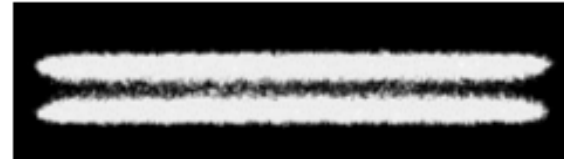
# General forms of the DBD discharge

- Basic modes of the DBD are filamentary and (Brandenburg 2004):

filamentary



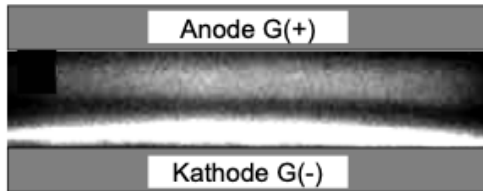
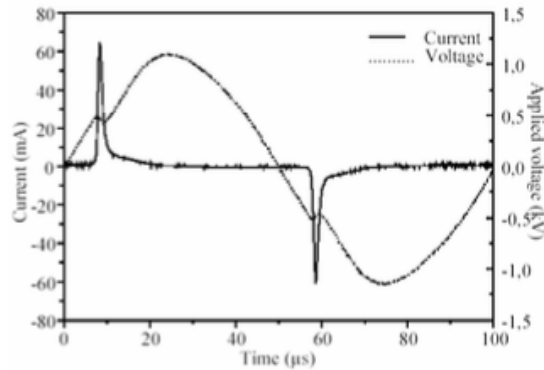
diffuse



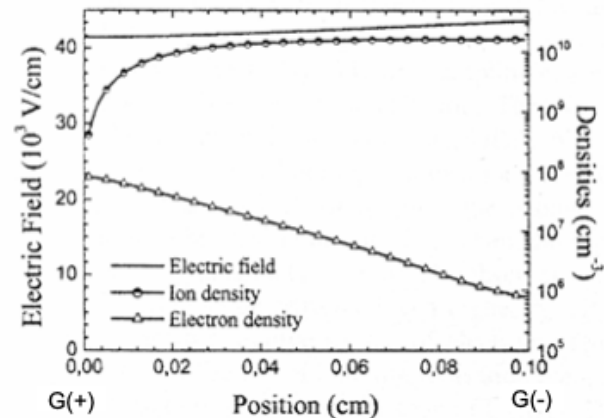
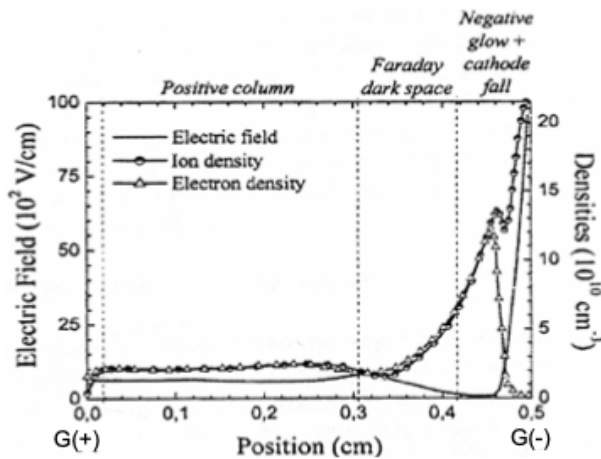
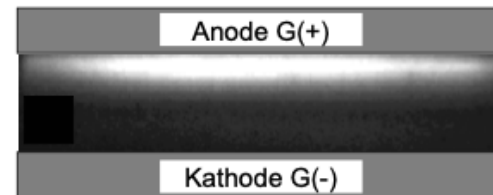
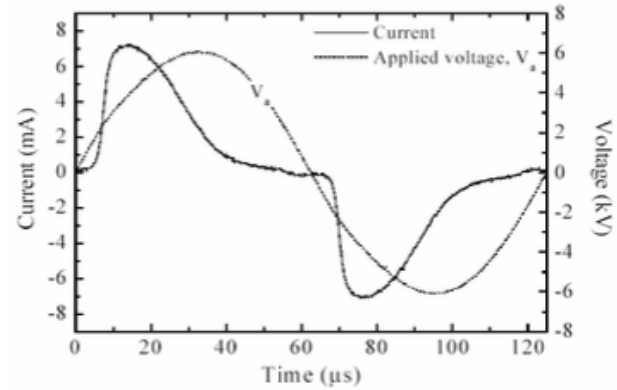
- In the filamentary mode, the filament diameter is sub-millimeter. Individual filaments take nanoseconds and the electric field is hundreds of Td owing to the streamer mechanism.
- In the diffuse mode, the discharge size is given by electrode width but the mode is not universally stable.
- **Penning ionization – one of phenomena contributing to the stability of the discharge**
- Diffuseness is important for various applications of the discharge. Note that even the filaments can be distributed uniformly and the discharge is pseudo-diffuse.

# Diffusion barrier discharges (Massines)

Diffusion barrier discharge in He



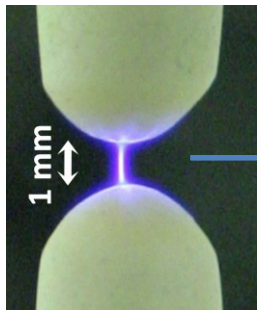
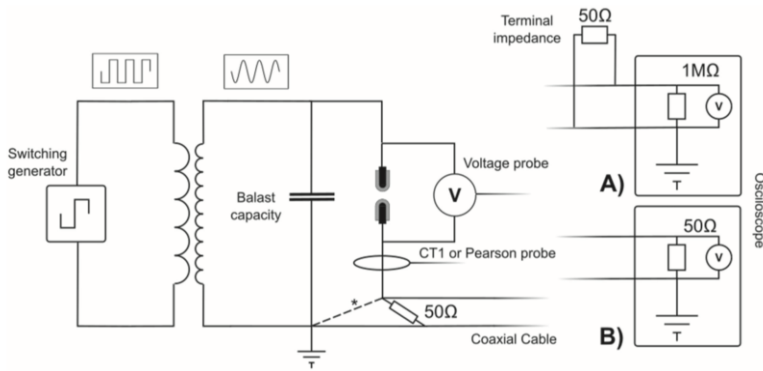
Diffusion barrier discharge in N2



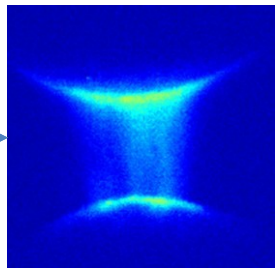
# **CURRENT IN DBD DISCHARGES**

# Measuring electrical current in a DBD discharge

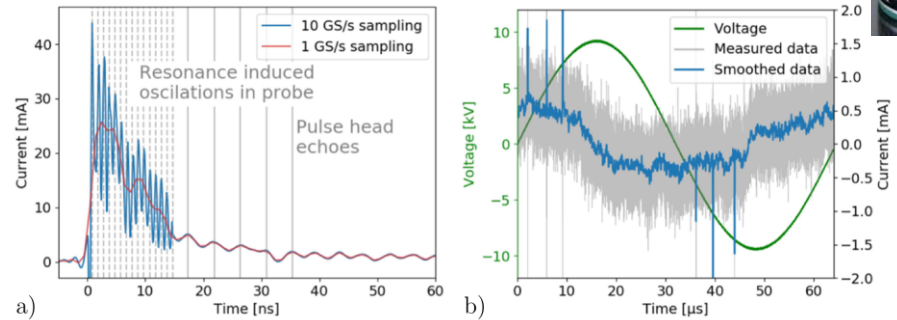
- You can either measure current using induction-based probes or by measuring voltage on a parallel resistor.
- Equivalent circuit for a single-filamentary discharge in air.



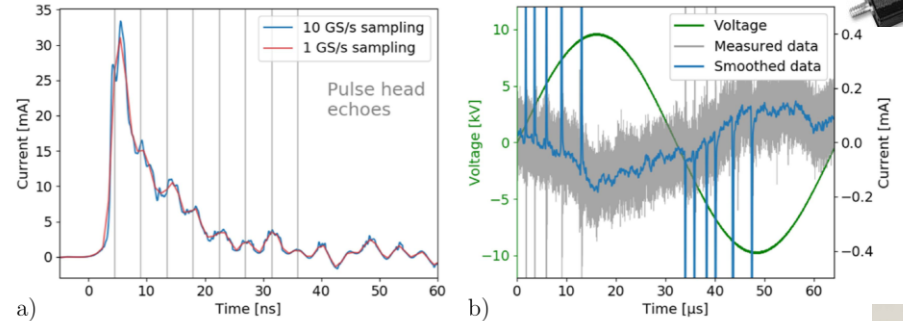
ICCD imaging:



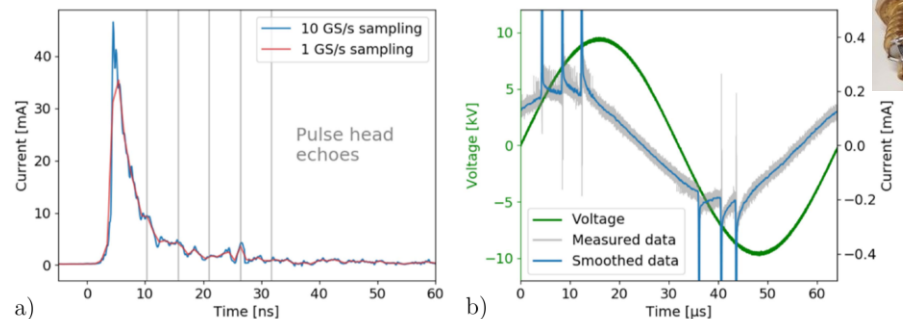
Pearson 2877, 300 Hz – 200 MHz



Tektronix CT-1, 25 kHz – 1 GHz

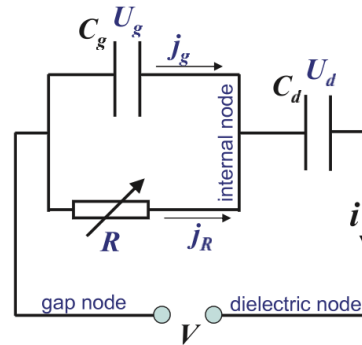
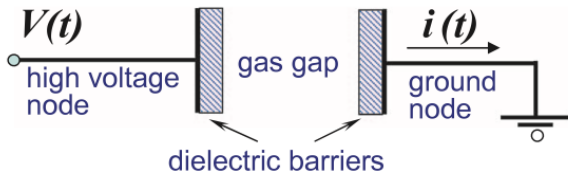


BNC sonda, 0 kHz – 2 GHz



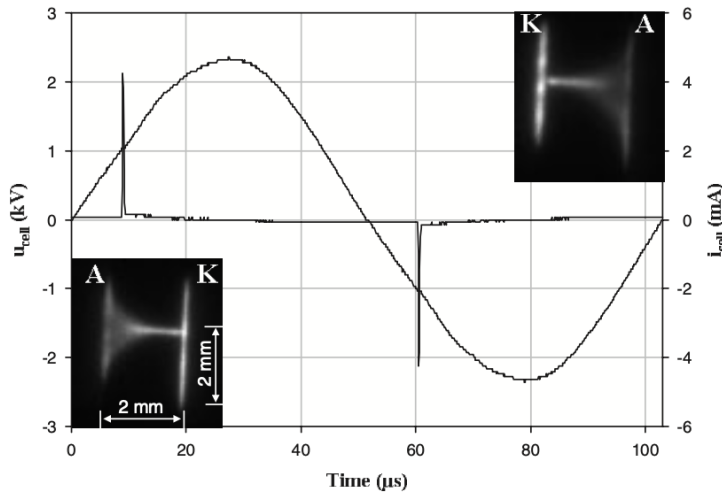
# Electrical characterization of a DBD discharge

- To measure the actual current is challenging, because the Maxwell translation current makes a major contribution.



- the gap voltage determines the effective electric field between the dielectrics  
 $E_{\text{eff}} = U_{\text{gap}}/g$
- $j_R$  is the pure discharge current
- $q$  is the charge transferred by a discharge
- The following factor is not negligible:

$$\left[ 1 + \frac{C_g}{C_d} \right]$$



**Figure 2.** Supply voltage, cell current, and 5- $\mu$ s time-integrated photographs of the discharge, in the visible range for  $P_{\text{Ar}} = 400$  Torr,  $f = 10$  kHz,  $g = 2$  mm,  $U_{\text{max}} = 2.36$  kV.

$$C_{\text{cell}} = \frac{C_d C_g}{C_d + C_g}$$

$$U_d(t) = \frac{Q(t)}{C_d},$$

$$U_g(t) = V(t) - U_d(t),$$

$$j_g(t) = C_g \frac{dU_g(t)}{dt},$$

$$j_R = i(t) - j_g(t),$$

$$U_g(t) = V(t) - \frac{Q(t)}{C_d}$$

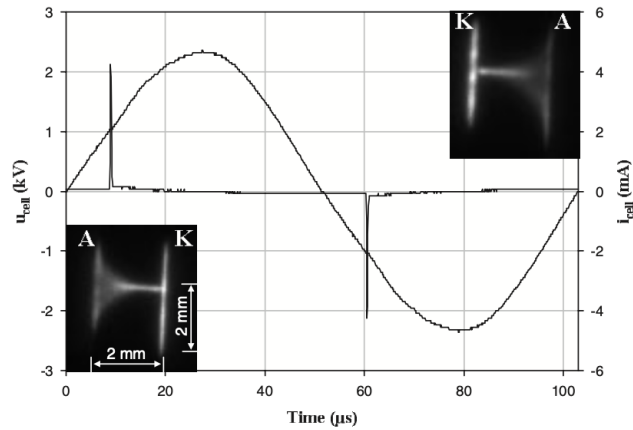
$$j_R(t) = \left[ 1 + \frac{C_g}{C_d} \right] i(t) - C_g \frac{dV(t)}{dt}$$

$$j_R(t) = \frac{1}{1 - \frac{C_{\text{cell}}}{C_d}} \left[ i(t) - C_{\text{cell}} \frac{dV(t)}{dt} \right]$$

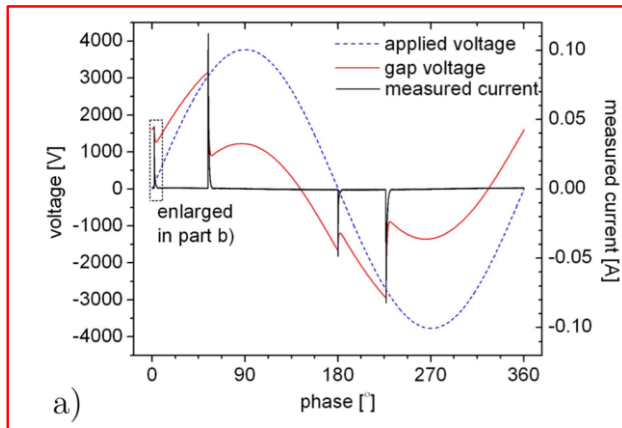
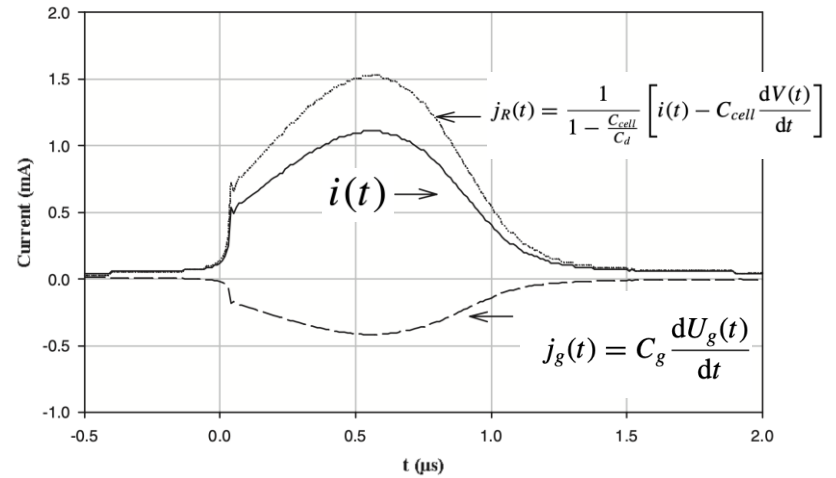
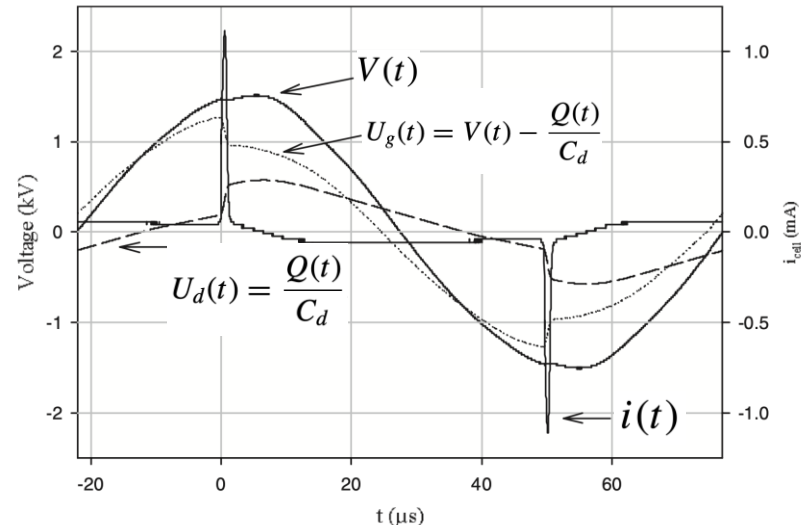
$$q(t) = \frac{1}{1 - \frac{C_{\text{cell}}}{C_d}} [Q(t) - C_{\text{cell}} V(t)] + q_0$$

# Analyzing electrical measurements

- Single-filamentary volume barrier discharge in atmospheric pressure argon.



**Figure 2.** Supply voltage, cell current, and 5- $\mu\text{s}$  time-integrated photographs of the discharge, in the visible range for  $P_{\text{Ar}} = 400 \text{ Torr}$ ,  $f = 10 \text{ kHz}$ ,  $g = 2 \text{ mm}$ ,  $U_{\text{max}} = 2.36 \text{ kV}$ .

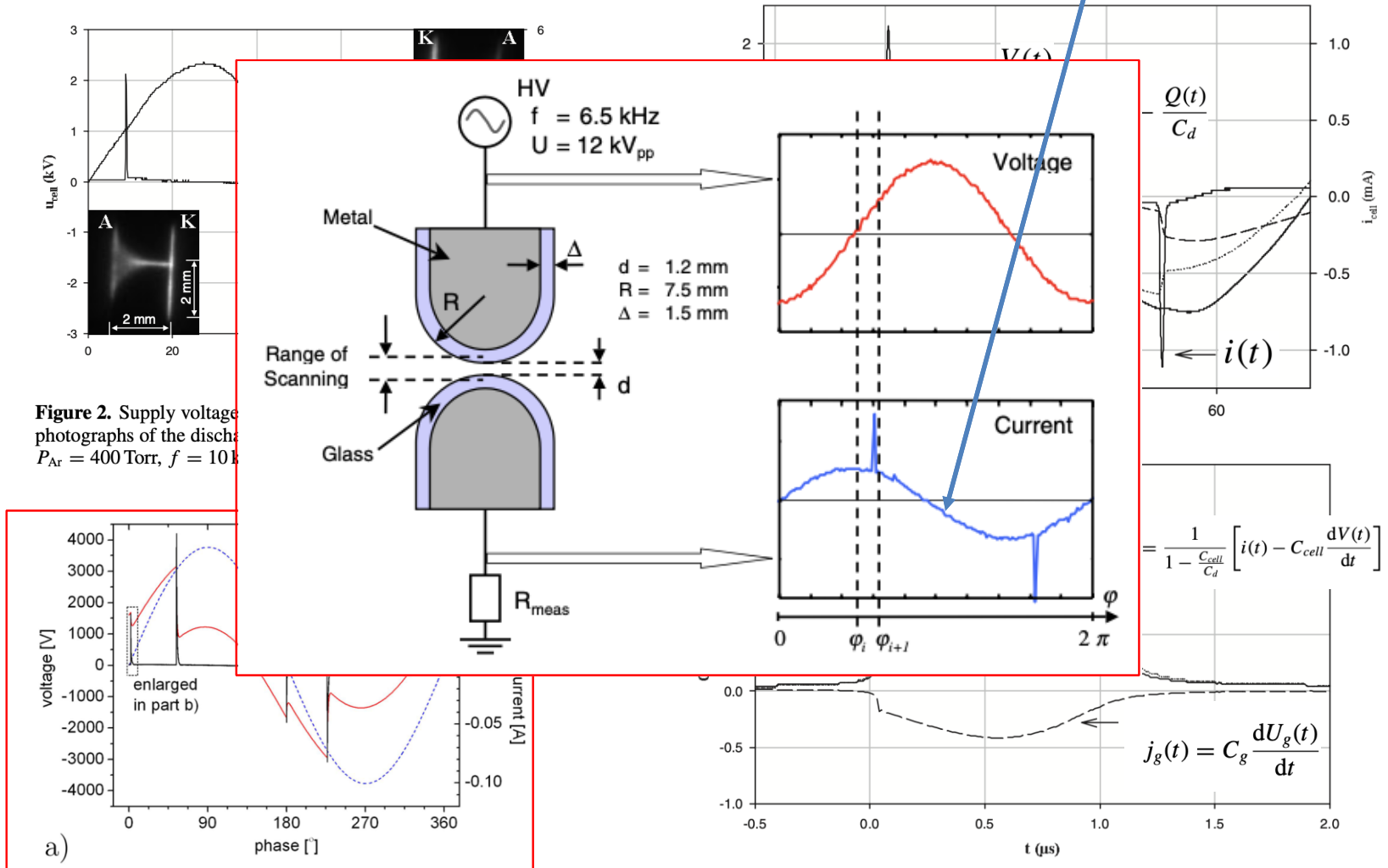




# Analyzing electrical measurements

You cannot simply subtract the sine component to get the correct current

- Single-filamentary volume barrier discharge in atmospheric pressure argon.



# An alternative method for obtaining $j_R$

- Let's start with the equation for the total current

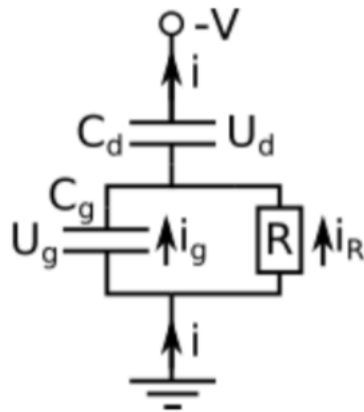
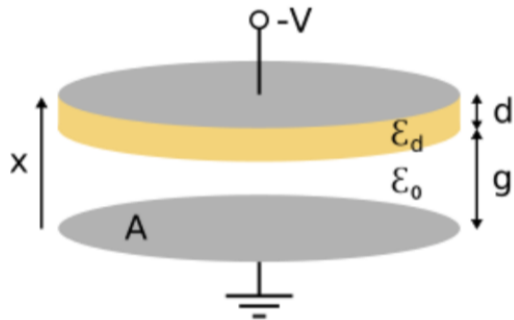


plate capacitor capacitance

$$C = \epsilon \frac{A}{d}$$

$$\epsilon = \epsilon_0 \epsilon_r$$

From Kirchhoff's laws

$$j_R(t) = \frac{1}{1 - \frac{C_{cell}}{C_d}} \left[ i(t) - C_{cell} \frac{dV(t)}{dt} \right]$$

Conduction current

Translational current

$$i_t(t) = i_c(x, t) + \epsilon(x) \epsilon_0 \frac{\partial E(x, t)}{\partial t}$$

$$= i(t)/A$$

Measured current density

$$i_c(x, t) = q[\Gamma_p(x, t) - \Gamma_e(x, t)]$$

$$\frac{i_t(t)}{\epsilon_0} \int_0^{d+g} \frac{dx}{\epsilon(x)} = \int_0^{d+g} \frac{i_c(x, t)}{\epsilon(x) \epsilon_0} dx + \frac{\partial}{\partial t} \int_0^{d+g} E(x, t) dx$$

$$j_t(t) \left( \frac{1}{C_d} + \frac{1}{C_g} \right) = \frac{1}{A \epsilon_0} \int_0^{d+g} \frac{j_c(x, t)}{\epsilon(x)} dx + \frac{dV(t)}{dt}$$

$$\epsilon(x \leq g) = 1$$

$$j_t(t) \left( \frac{1}{C_d} + \frac{1}{C_g} \right) = \frac{1}{C_g} j_c(t) + \frac{dV(t)}{dt}$$

$$j_R(t) = j_c(t) = \frac{1}{1 - \frac{C_{cell}}{C_d}} \left[ i(t) - C_{cell} \frac{dV(t)}{dt} \right]$$

## An alternative method for obtaining $j_R$

- If we take into account the deposited surface charge, then (Bonaventura 2020):

$$i_t(t) = i_c(x, t) + \varepsilon(x) \frac{\partial E_g(t)}{\partial t} = \varepsilon(x) \varepsilon_0 \frac{\partial E_d(t)}{\partial t} = i(t)/A$$

surface charge deposition

$$\frac{\partial \sigma}{\partial t} = i_c$$

step condition on the boundary of a dielectric (Tirpák)

$$E_g = \varepsilon_r E_d - \sigma / \varepsilon_0$$

after a few modifications:

$$\begin{aligned} \frac{j_t(t)}{A} &= \int_0^g j_c(x, t) dx + \left( \frac{\partial \sigma}{\partial t} \right) \left( \frac{dg(\varepsilon_r - 1)}{\varepsilon_r g + d} \right) - \frac{g + d}{\varepsilon_r g + d} \varepsilon_r \varepsilon_0 \frac{\partial V}{\partial t} \\ &= \frac{\partial \sigma}{\partial t} \left[ \frac{\varepsilon_r g(g + d)}{\varepsilon_r g + d} \right] + \frac{g + d}{\varepsilon_r g + d} \varepsilon_r \varepsilon_0 \frac{\partial V}{\partial t} \end{aligned}$$

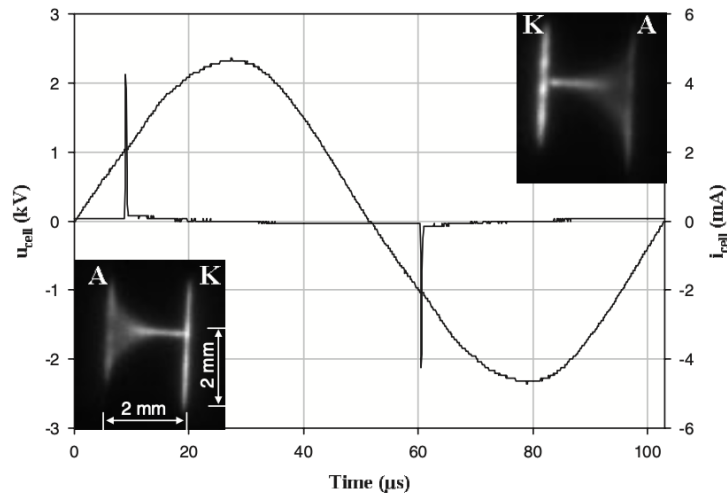


$$j_R(t) = j_c(t) = \frac{1}{1 - \frac{C_{cell}}{C_d}} \left[ i(t) - C_{cell} \frac{dV(t)}{dt} \right]$$

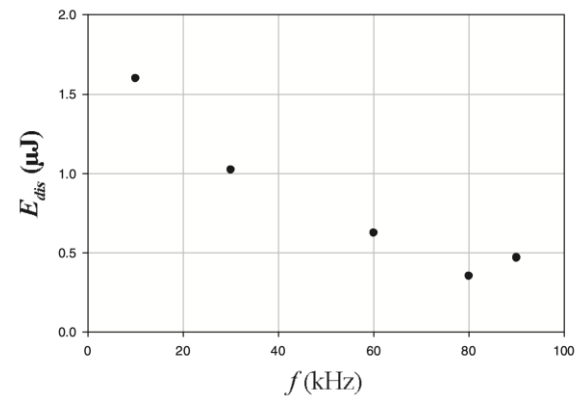
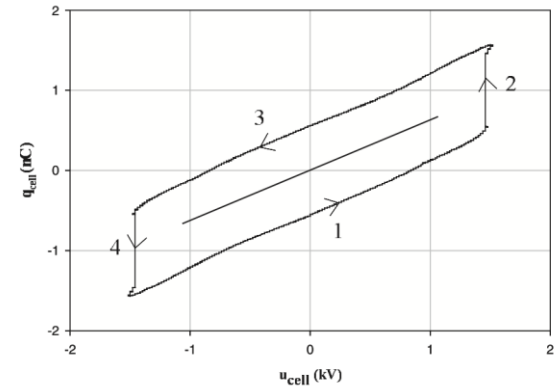
the calculated current  $j_R$  obtained from Kirchhoff laws is identical to conduction current  $j_c$

# QV diagrams of the DBD discharge

- Manley 1943 showed that the energy dissipated in a DBD can be obtained from Lissajouse figures, graphically.
- Today, these plots are called more accurately – QV plots/diagrams

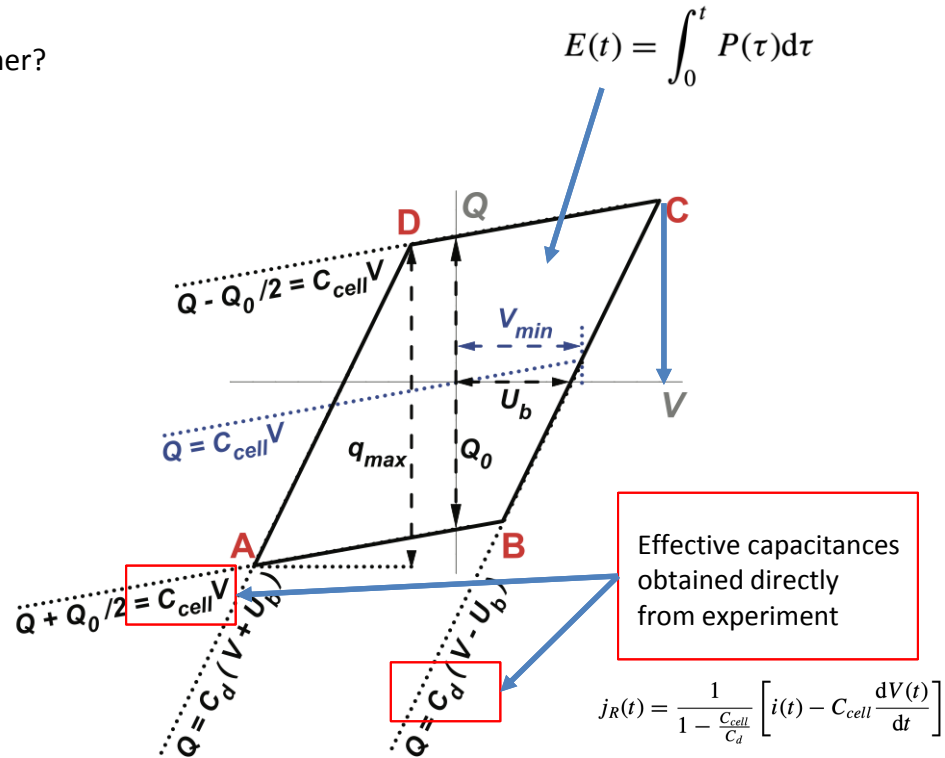
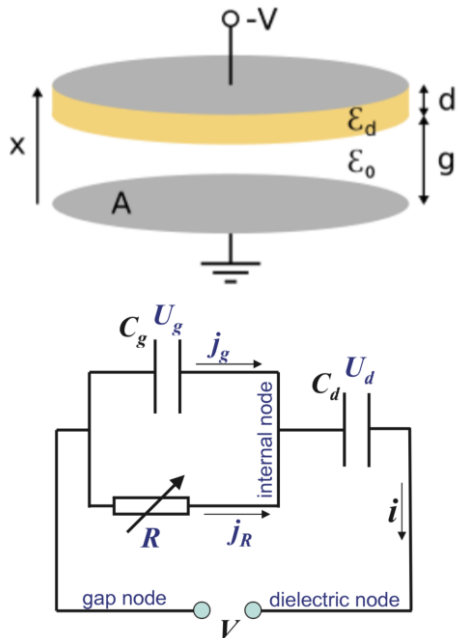


**Figure 2.** Supply voltage, cell current, and 5- $\mu$ s time-integrated photographs of the discharge, in the visible range for  $P_{Ar} = 400$  Torr,  $f = 1$  g Hz,  $d = 2$  mm,  $U_{max} = 2.36$  kV.



# QV diagrams of the DBD discharge

- So how do the equivalent circuit and QV plots play together?



- Power dissipated in the discharge can be obtained from current and voltage:  $P(t) = j_R(t)U_g(t)$

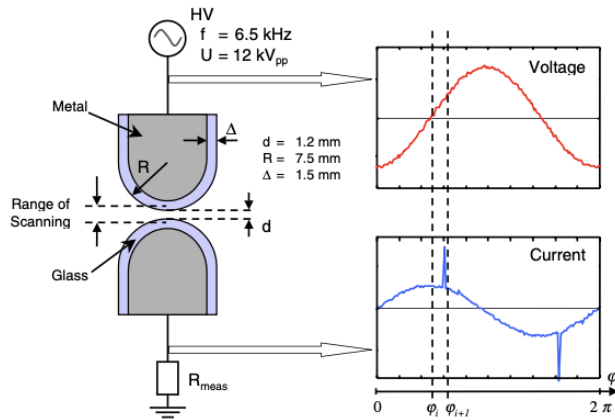
- And for total dissipated energy, it has to hold that:  $\int_0^T i(\tau)V(\tau)d\tau = \int_0^T j_R(\tau)U_g(\tau)d\tau$

# **VOLUME DIAGNOSTICS OF DBD PLASMAS**

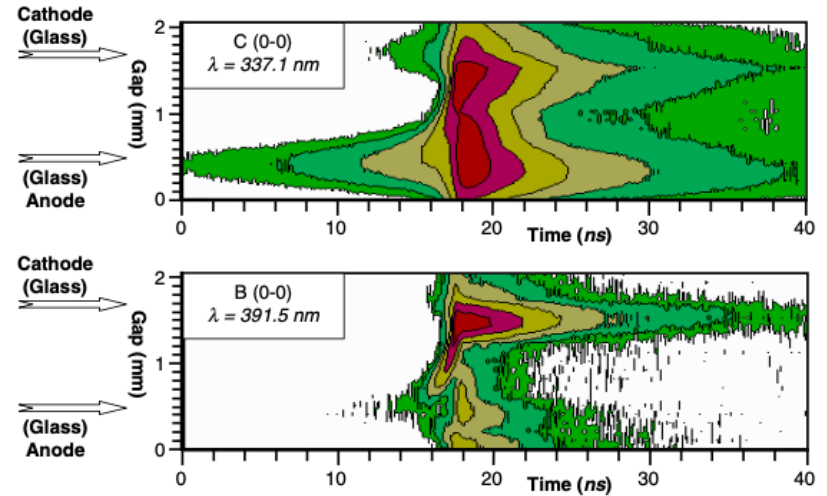


# Applying cross-correlation spectroscopy to understand DBDs (Kozlov 2001)

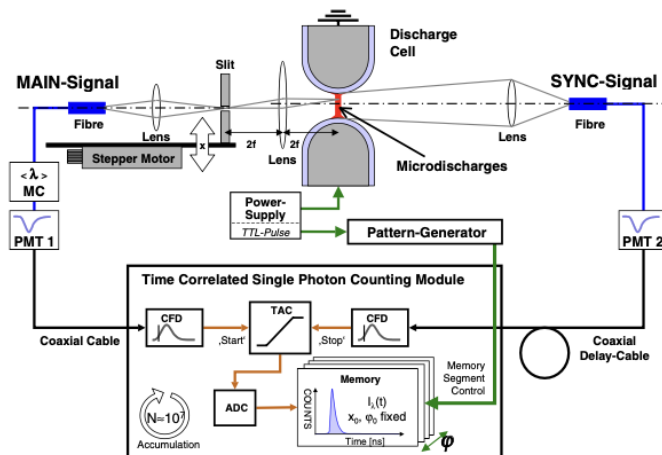
Symmetrical atm. pressure discharge



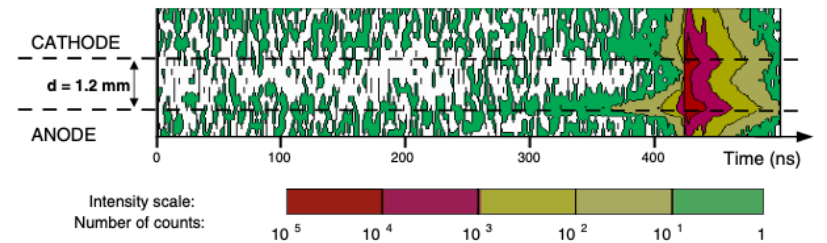
Light emission during the discharge



Time-correlated photon counting technique



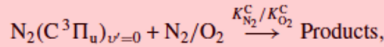
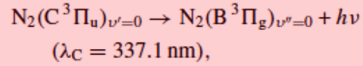
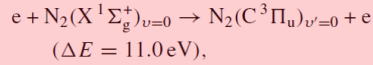
Light emission in the Townsend phase



# Measuring the electric field in DBDs

- Spectroscopic method based on nitrogen emission bands, developed by Kozlov in 2001

## SPS

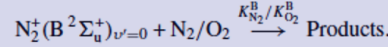
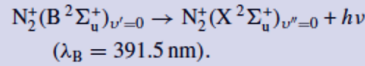
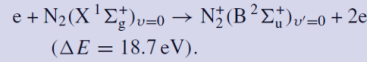


$$\frac{dn_C(r, t)}{dt} = k_C \left( \frac{E}{n} \right) n_{N_2} n_e(r, t) - \frac{n_C(r, t)}{\tau_{\text{eff}}^C}$$

$$\frac{1}{\tau_{\text{eff}}^C} = K_{N_2^C} n_{N_2} + K_{O_2^C} n_{O_2} + \frac{1}{\tau_0^C}$$

$$= K_{N_2^C} n_{N_2} + K_{O_2^C} n_{O_2} + \sum_{v''=0}^{\infty} \frac{1}{\tau_{0v''}^C}$$

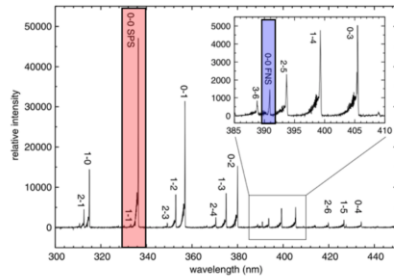
## FNS



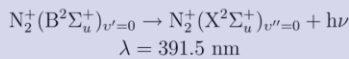
$$\frac{dn_B(r, t)}{dt} = k_B \left( \frac{E}{n} \right) n_{N_2} n_e(r, t) - \frac{n_B(r, t)}{\tau_{\text{eff}}^B}$$

$$\frac{1}{\tau_{\text{eff}}^B} = K_{N_2^B} n_{N_2} + K_{O_2^B} n_{O_2} + \frac{1}{\tau_0^B}$$

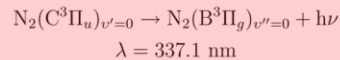
$$= K_{N_2^B} n_{N_2} + K_{O_2^B} n_{O_2} + \sum_{v''=0}^{\infty} \frac{1}{\tau_{0v''}^B}$$



FNS  
18.7eV

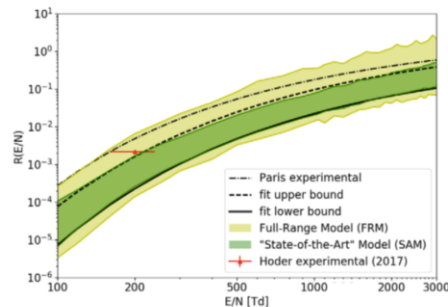


SPS  
11eV

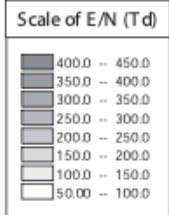
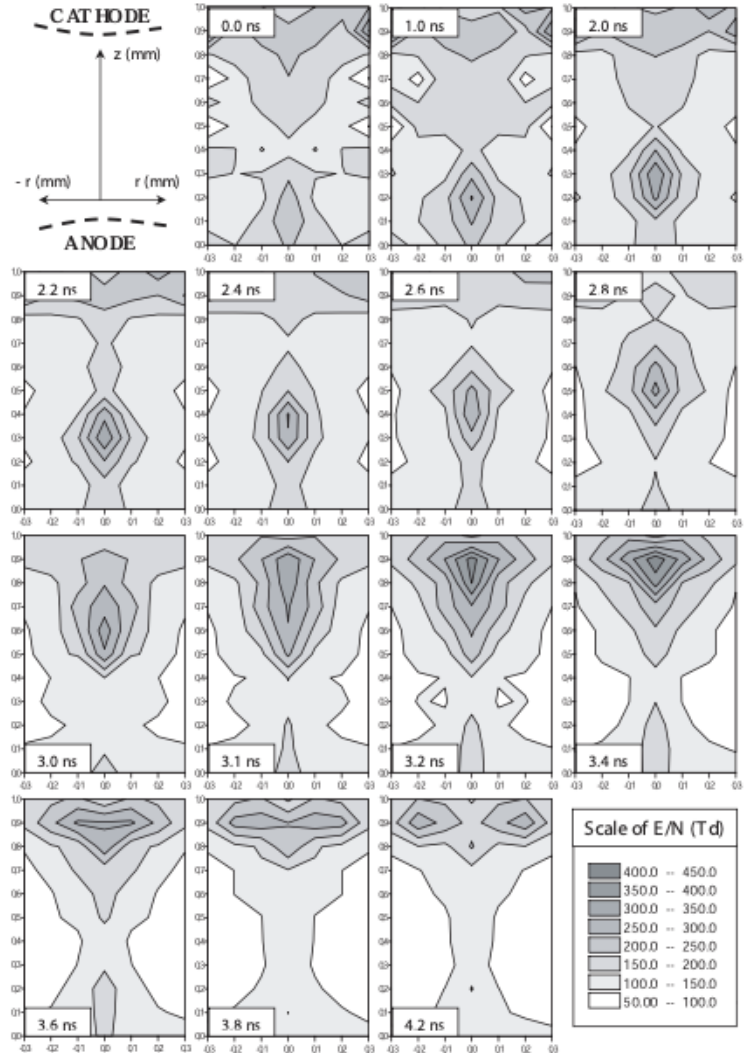


measured rate coefficients

$$\frac{\left( \frac{dI_{\text{FNS}}/dt + I_{\text{FNS}}/\tau_{\text{eff}}^{\text{FNS}}}{dI_{\text{SPS}}/dt + I_{\text{SPS}}/\tau_{\text{eff}}^{\text{SPS}}} \right) \frac{\tau_{\text{eff}}^{\text{FNS}}}{\tau_{\text{eff}}^{\text{SPS}}} = R_{\text{FNS/SPS}}(E/N)$$

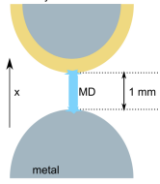


Paris et al. 2005 JPD  
Obrusnik et al. 2018 PSST  
Bilek et al. 2018 PSST

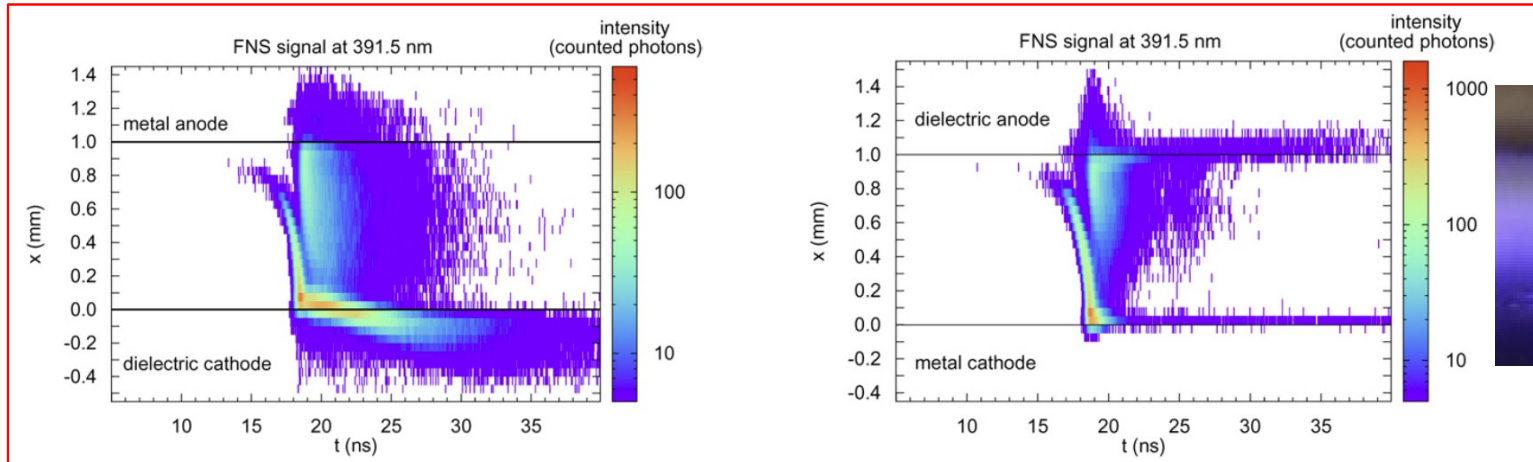


# Spatio-temporal evolution of DBDs

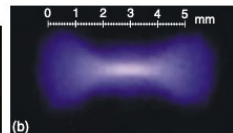
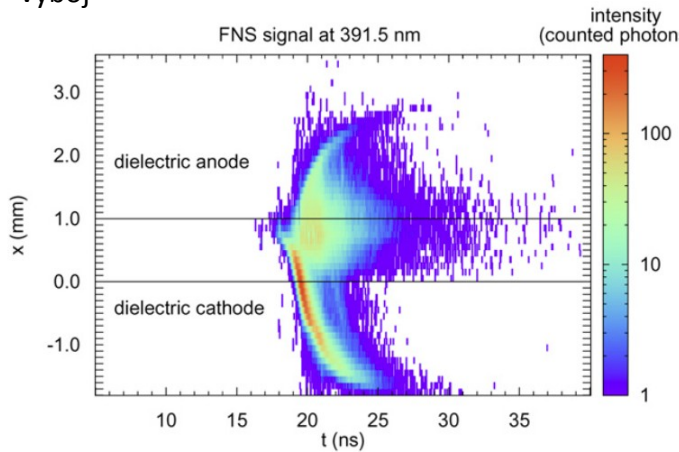
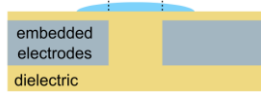
- Applicable to different types of DBDs



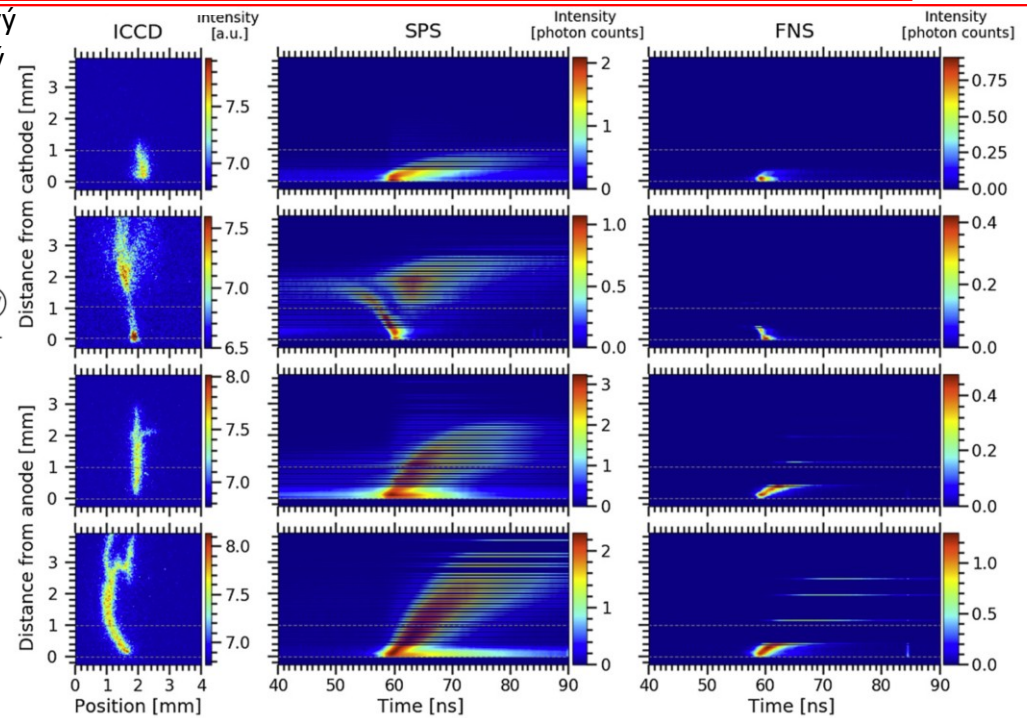
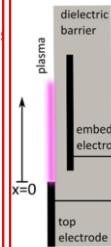
objemový bariérový výboj



koplanární bariérový výboj



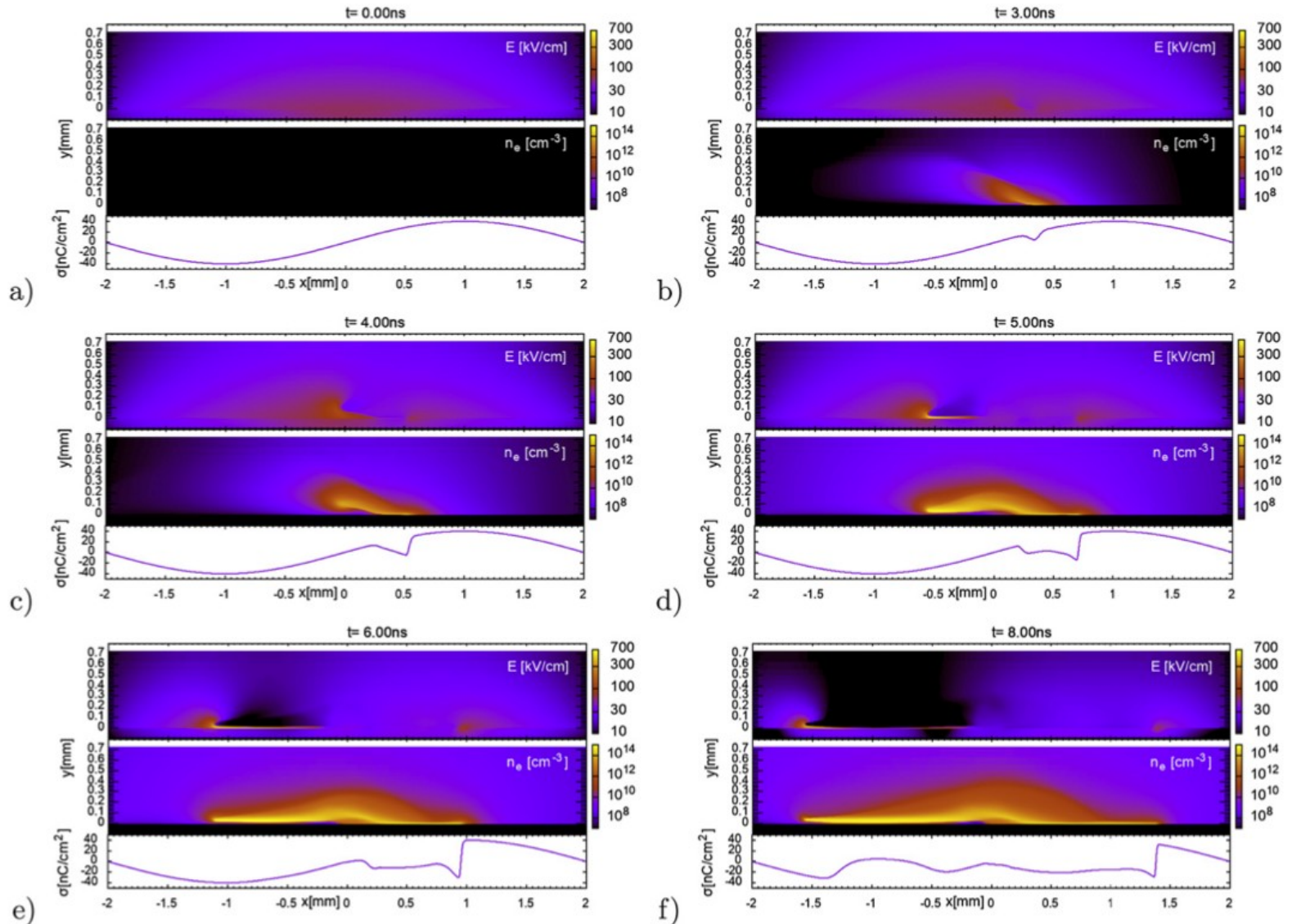
povrchový bariérový výboj





# Spatially resolved simulations of DBD discharges

- Simulating a co-planar DBD discharge, Jánský 2022



**Figure 6.** Two-dimensional side-view development of the discharge electric field strength (logarithmic scale), electron (logarithmic scale) and surface charge densities for coplanar discharge in atmospheric pressure air. Case for photoemission of  $5 \times 10^{-5}$ .

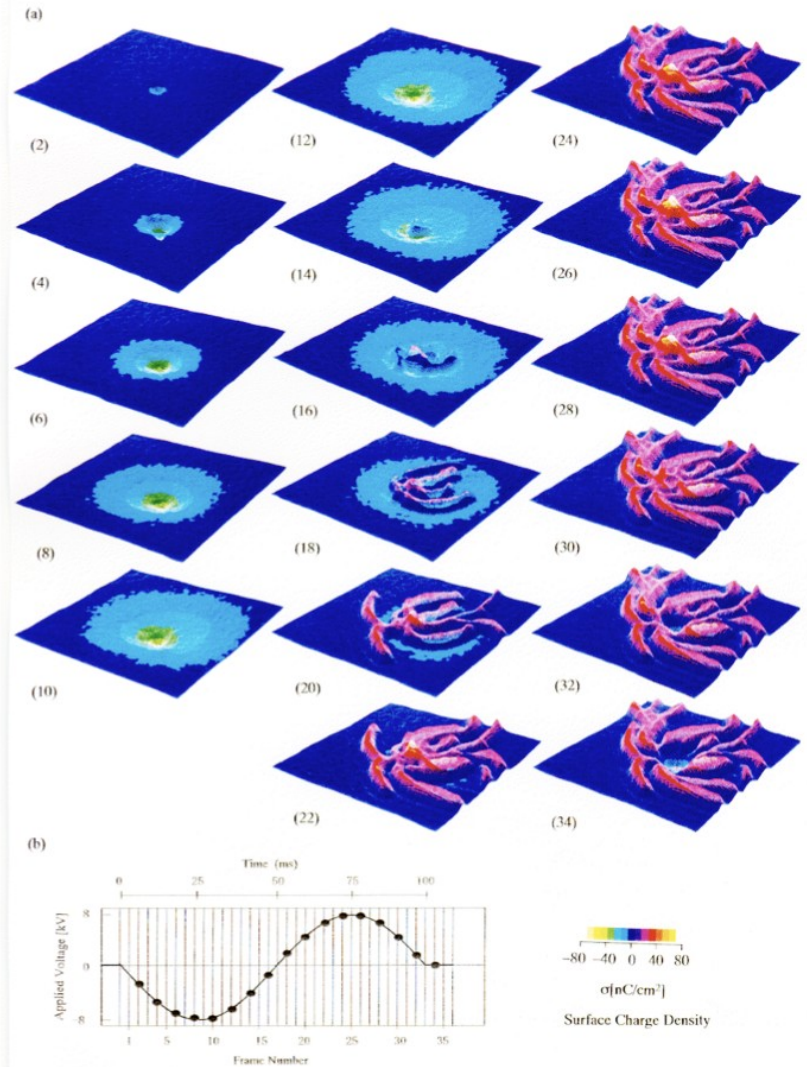
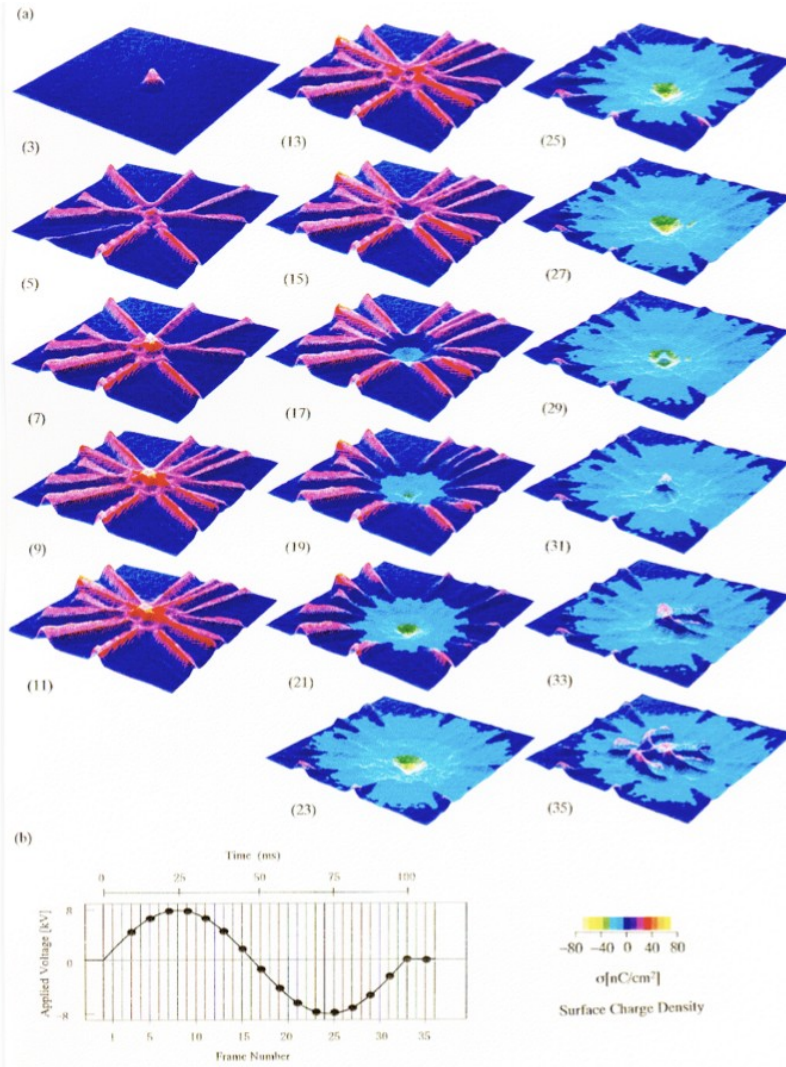
# **SURFACE CHARGE IN DBD DISCHARGES**

# Surface charge in DBDs

- Pockels effect has been used to measure surface charge (Zhu 1996), for a point-to-plane config

Positive tip transitioning to negative polarity

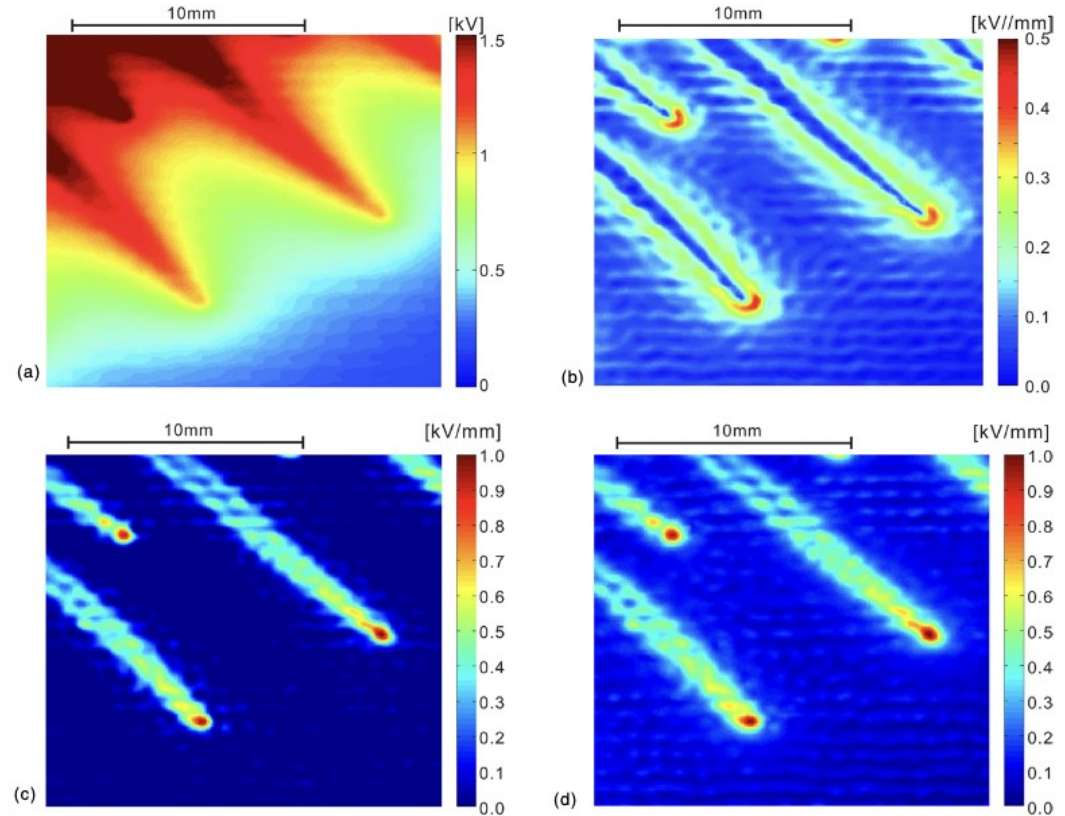
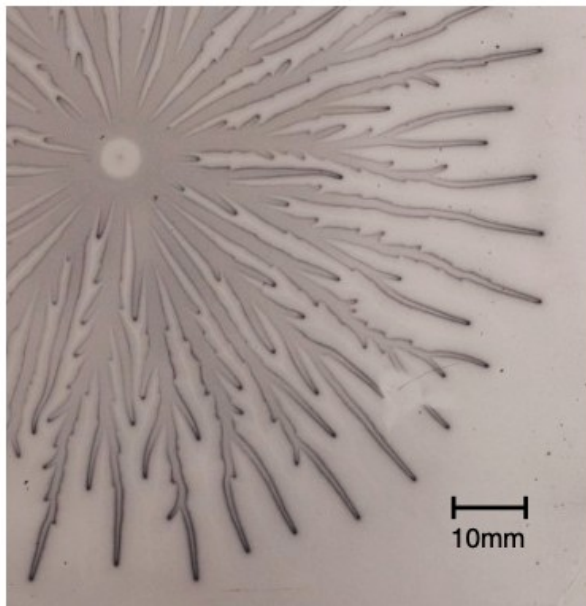
Negative tip transitioning to positive polarity





# Surface charge in DBDs

- There is a „surface streamer“ forming in point-to-plane DBDs (Kumada 2009)
- The electric field exceeded an equivalent of 30kV/cm at higher pressure (experiments done at low pressure)



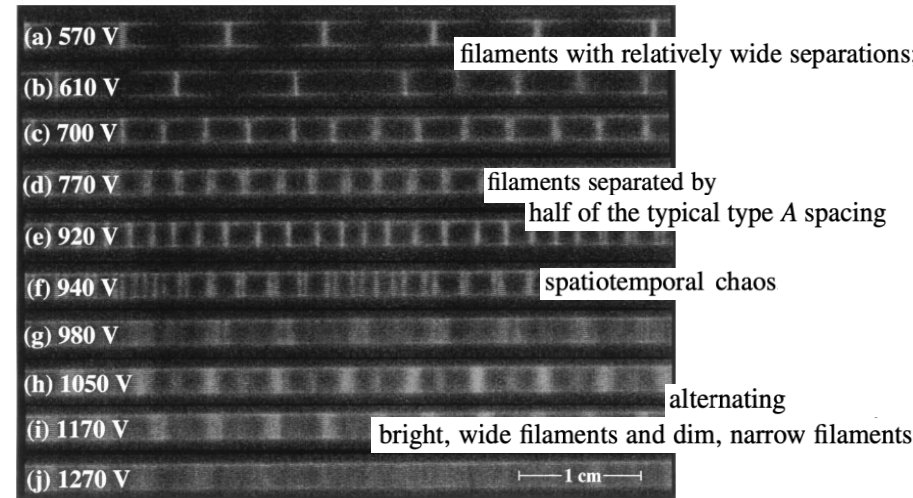
**Figure 14.** Computed results. Distribution of (a) potential  $V$ ; (b) horizontal component of electric field,  $\sqrt{E_x^2 + E_y^2}$ ; (c) perpendicular component of electric field,  $E_z$ ; (d) intensity of electric field,  $|\mathbf{E}|$ .

# **SELF ORGANIZATION OF FILAMENTARY DBD DISCHARGES**

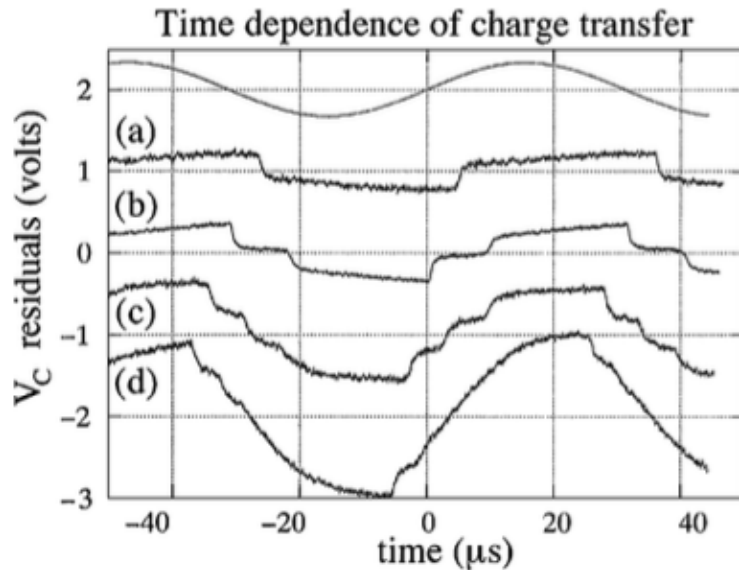
# Self organization of filamentary DBDs (Guikema 2000)

Localized filaments – they „prefer“ to ignite in discrete places, rather than randomly.

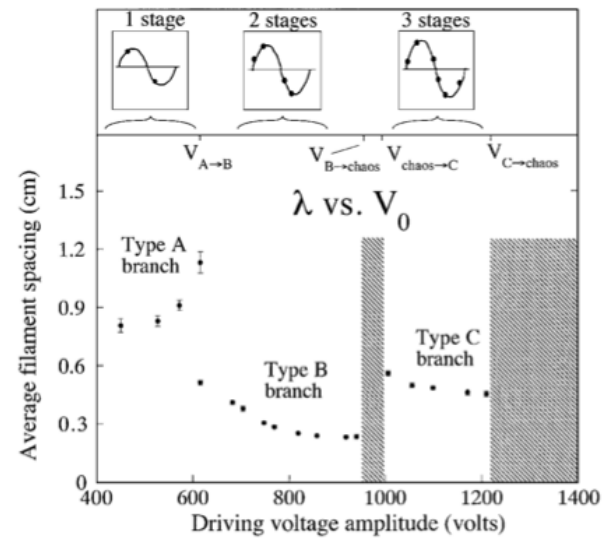
The decisive mechanism is the surface charge accumulation and the „dose“ of charge deposited by individual discharges.



přenos náboje skrze jednotlivé výboje

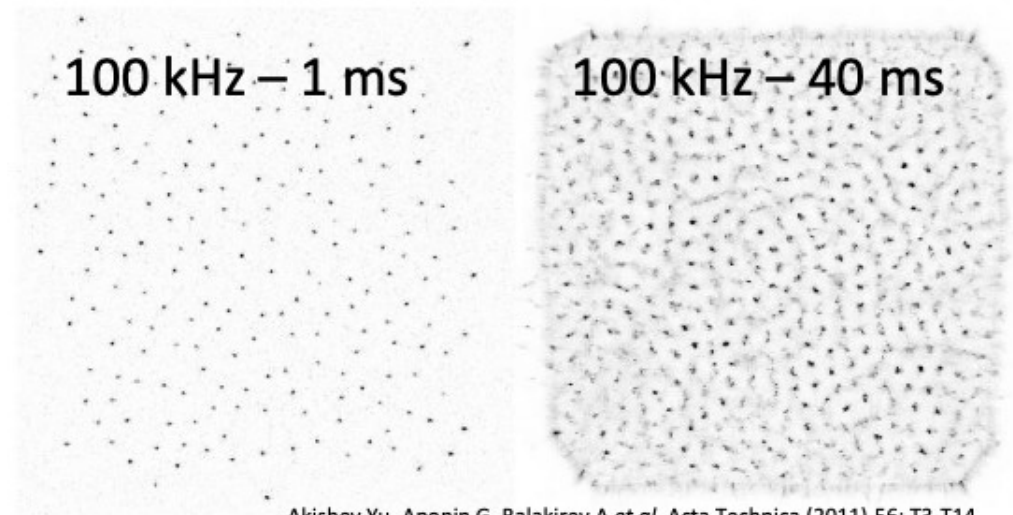


střední vzdálenost filamentů

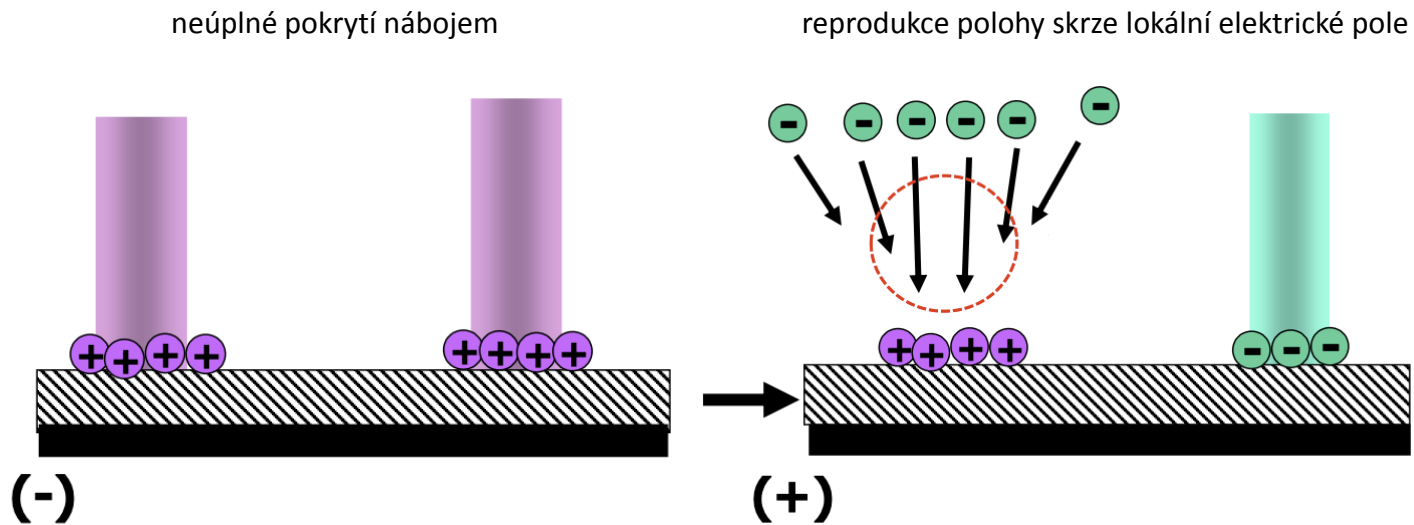


# Self organization of filamentary DBDs

Microscopic view of the charge acculation effect

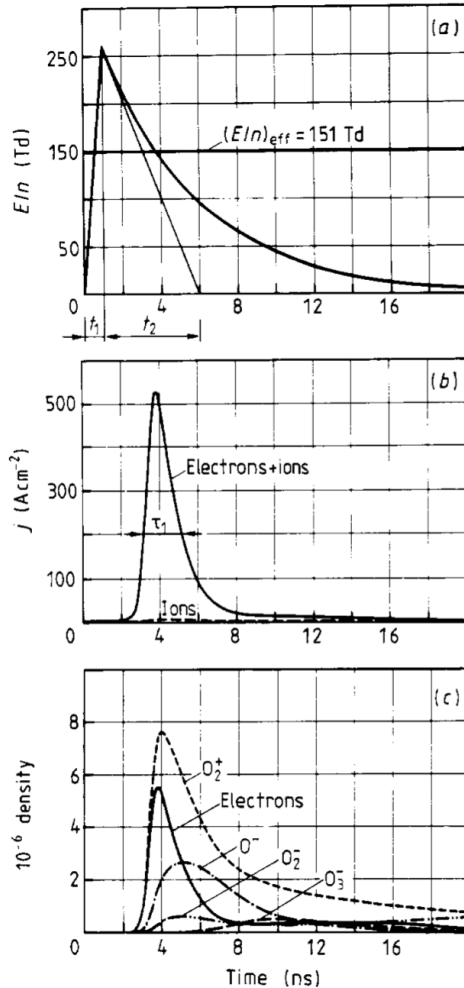


Akishev Yu, Aponin G, Balakirev A et al. Acta Technica (2011) 56: T3-T14



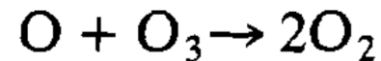
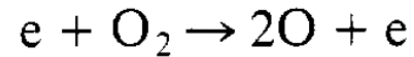
# **DBD APPLICATIONS**

# Ozone generation (Eliasson 1987)



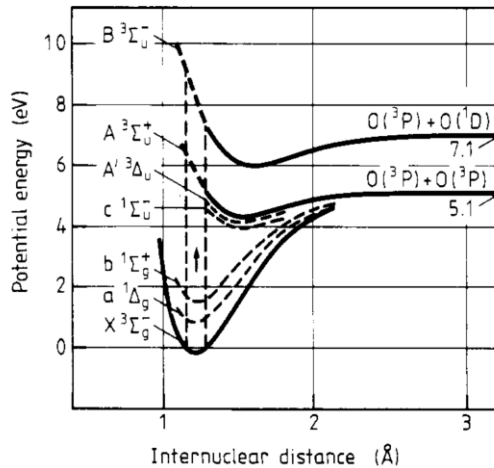
- Possibly oldest application of DBD discharges
- Motivated formulation of the first physical and chemical models.
- 1D model described the formation of a transient glow discharge at high pressure.
- Actual EEDF was calculated and from it, rate coefficients and transport properties were deduced.

The mechanism for ozone formation and potential ozone loss was identified as follows:

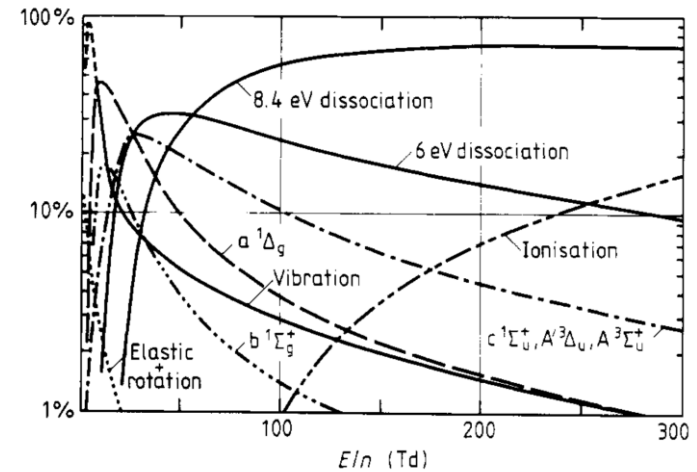
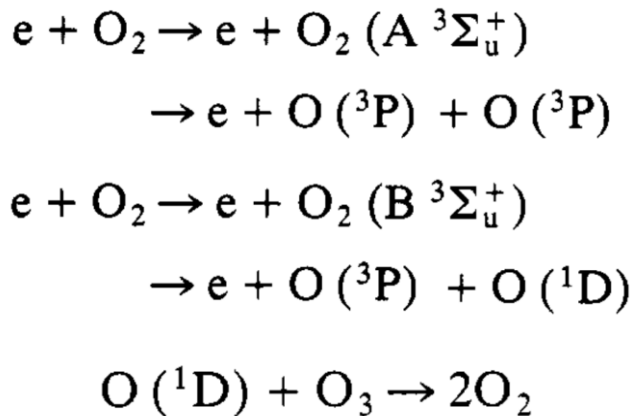




# Ozone production – oxygen dissociation

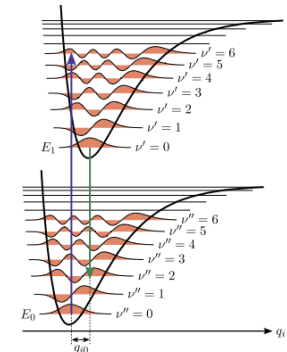


**Figure 6.** Simplified potential energy diagram of  $O_2$ . The arrow indicates the Franck–Condon region for excitation from the ground state.



**Figure 7.** Distribution of electron energy losses as a function of the reduced electric field; energy branching in oxygen.

Classically, the **Franck–Condon principle** is the approximation that an electronic transition is most likely to occur without changes in the positions of the nuclei in the molecular entity and its environment. The resulting state is called a Franck–Condon state, and the transition involved, a vibronic transition. The quantum mechanical formulation of this principle is that the intensity of a vibronic transition is proportional to the square of the overlap integral between the vibrational wavefunctions of the two states that are involved in the transition.



# Ozone production – effect of admixtures

In industrial production, gases that form metastable excited species are often added, further enhancing the dissociation rate of oxygen by plasma.

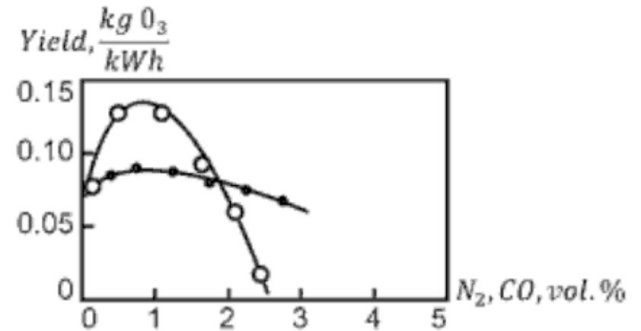
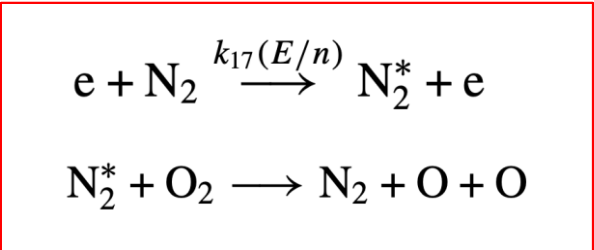
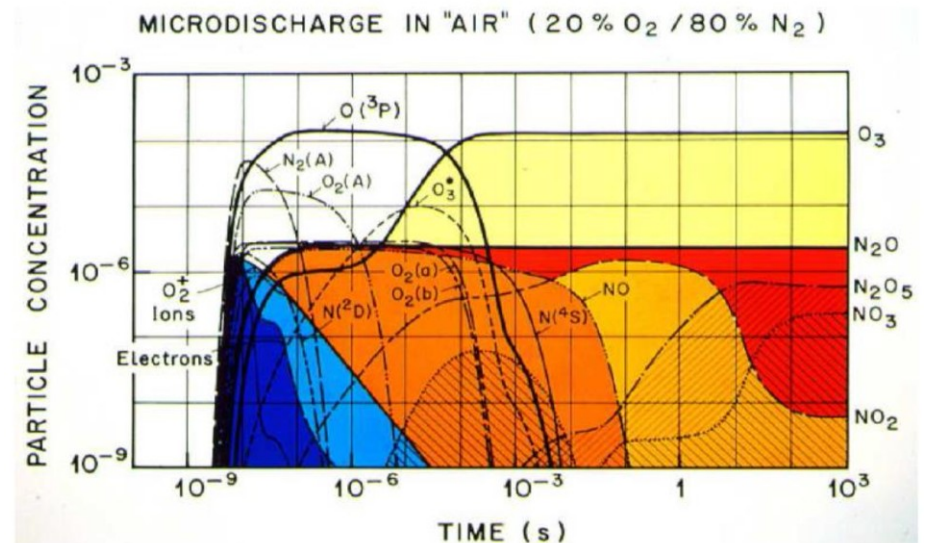
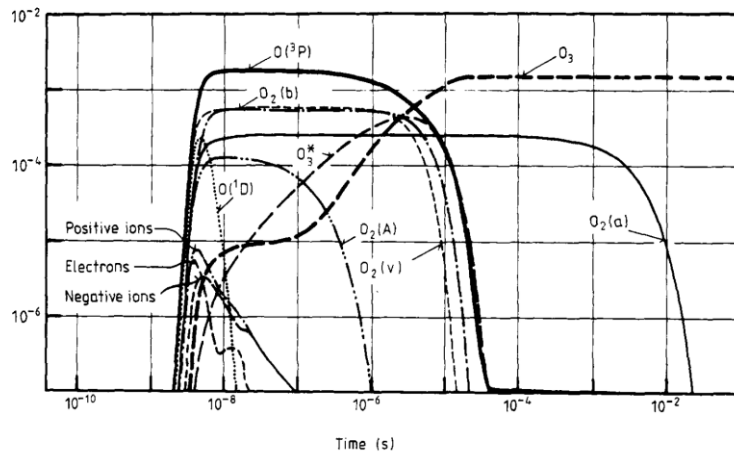
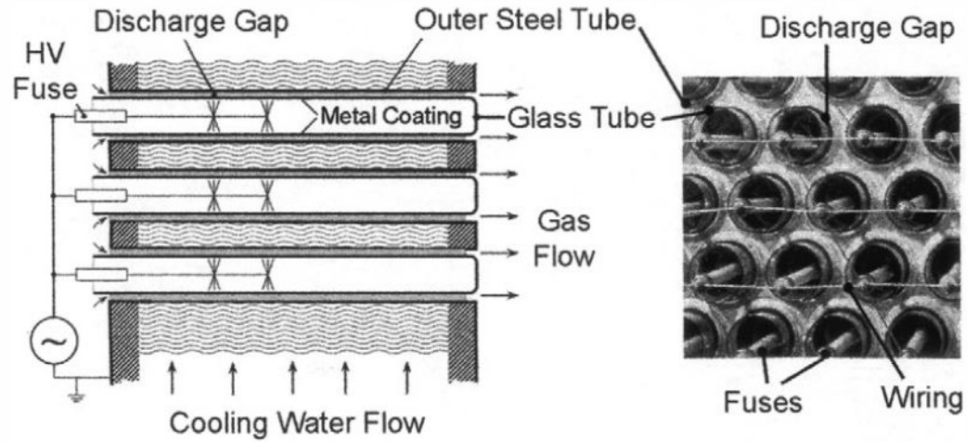


Figure 6-32. Influence of admixtures of N<sub>2</sub> and CO on ozone yield in a DBD in room-temperature oxygen: black circles correspond to molecular nitrogen, white circles correspond to carbon monoxide.

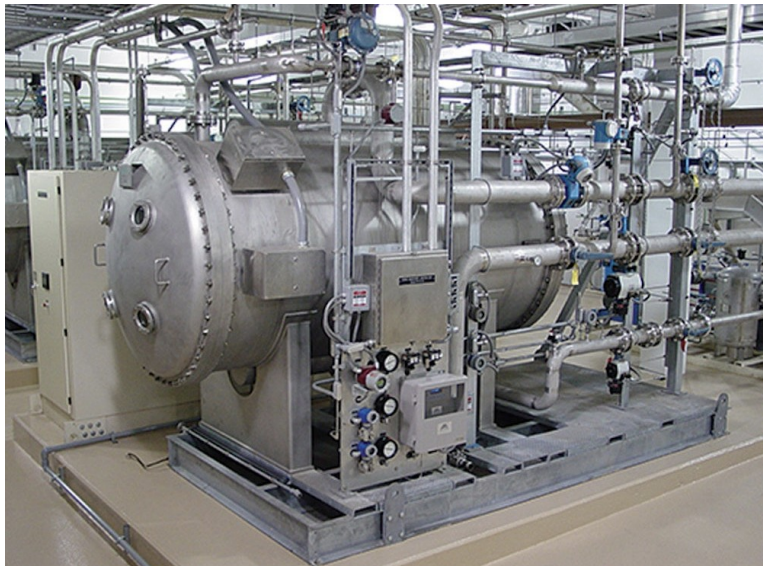
## Microdischarge in pure oxygen



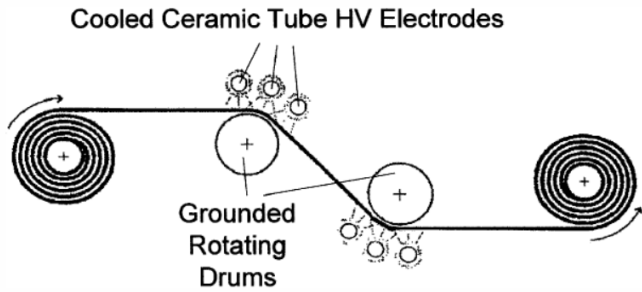
# Ozone production – an industrial setup



**OZONIA**



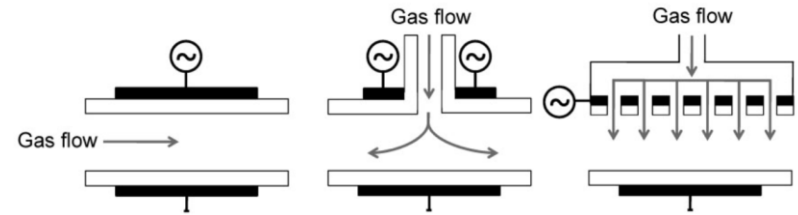
# Surface processing



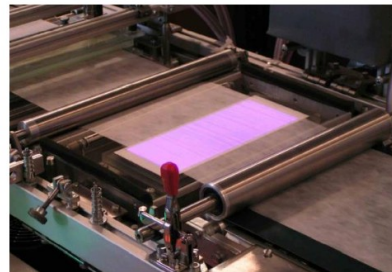
SOFTAL GmbH



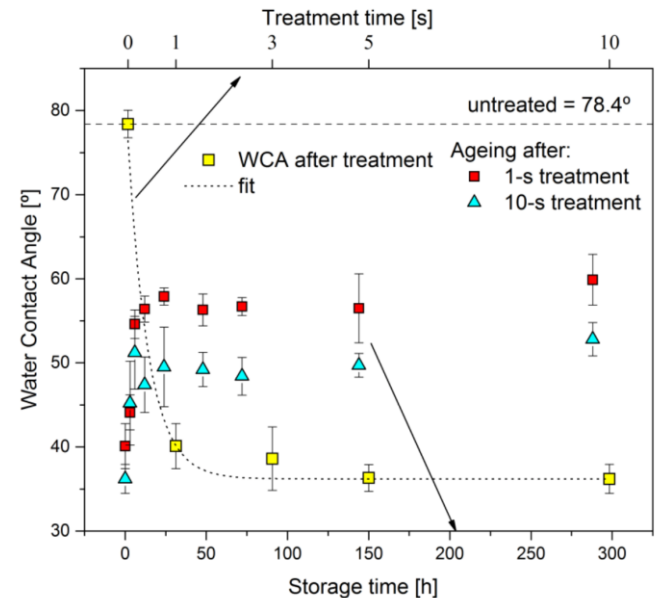
pro reaktivní plyny a depozice (Massines 2012)



DCSBD – in-line opracování, no-pinholing, i tepelně citlivé povrchy/vzorky

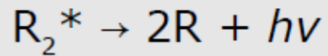
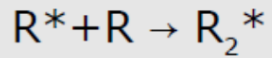


změna kontaktního úhlu, PET povrch, DCSBD (Homola 2017)





# Excimer light sources

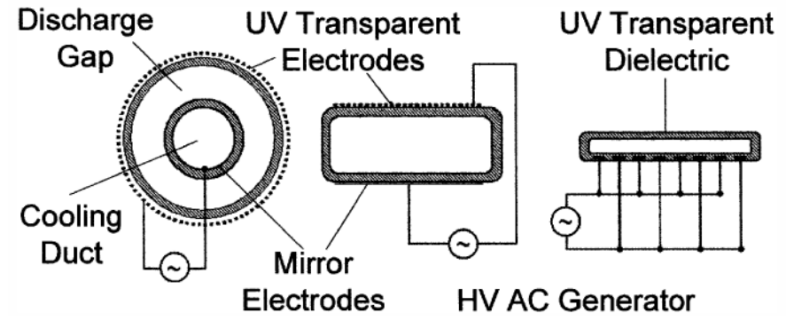
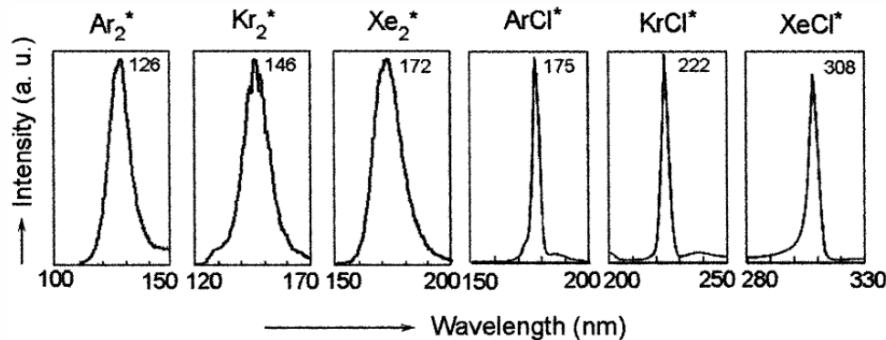


$R^*$  - excited atom

$R_2^*$  - excited dimer

( $AB^*$  = exciplex)

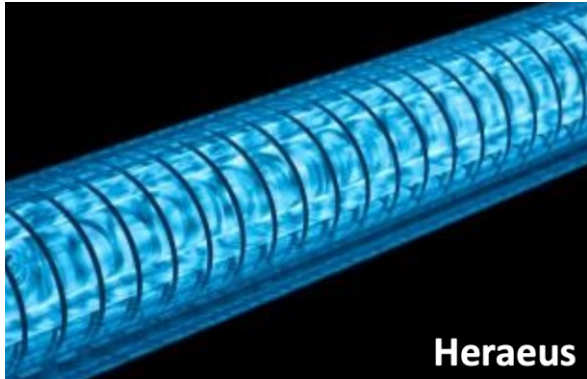
$Ar_2^*$	$Kr_2^*$	$F_2^*$	$Xe_2^*$	$ArCl^*$	$ArF^*$	$KrCl^*$	$KrF^*$	$XeI^*$	$Cl_2^*$	$XeBr^*$	$Br_2^*$	$XeCl^*$	$I_2^*$	$XeF^*$
126	146	157	172	175	193	222	248	253	259	282	289	308	342	354



Very intense UV light sources

- surface and water cleaning by UV
- UV curing and photopolymerization
- excimer lasers for semiconductor applications

# Excimer light sources



Quark technology



Very intense UV light sources

- surface and water cleaning by UV
- UV curing and photopolymerization
- excimer lasers for semiconductor applications



# Takeaways

- What is a DBD and what are its various arrangements
- Where is the voltage drop in DBDs, what are the methods for accurately measuring plasma power and voltage?
- What are some methods of DBD diagnostics.
- DBD applications