

# Αροπτόζα - αποπτοσίσ

# Apoptóza – historie výzkumu

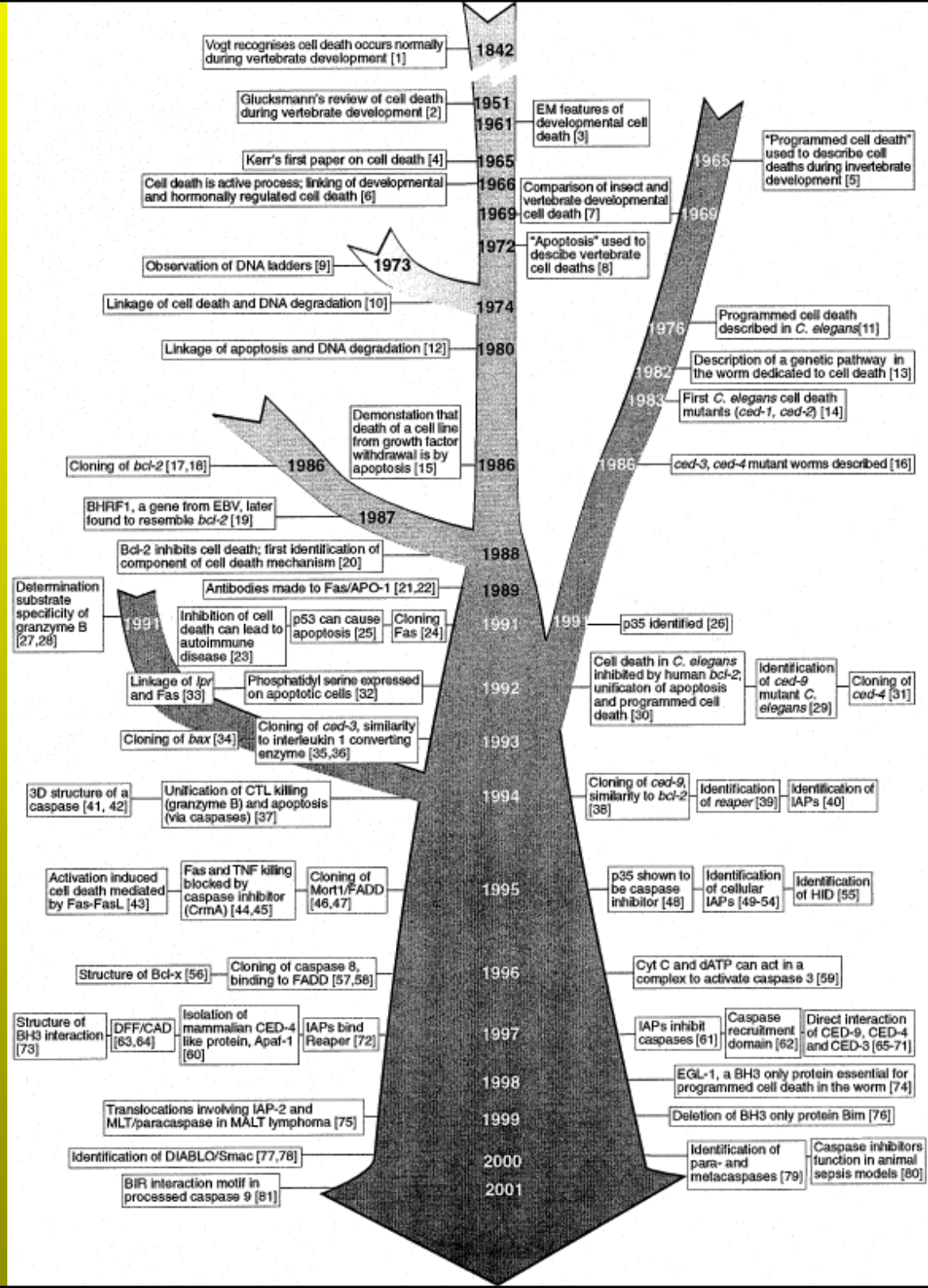

# Apoptóza a vývoj jedince

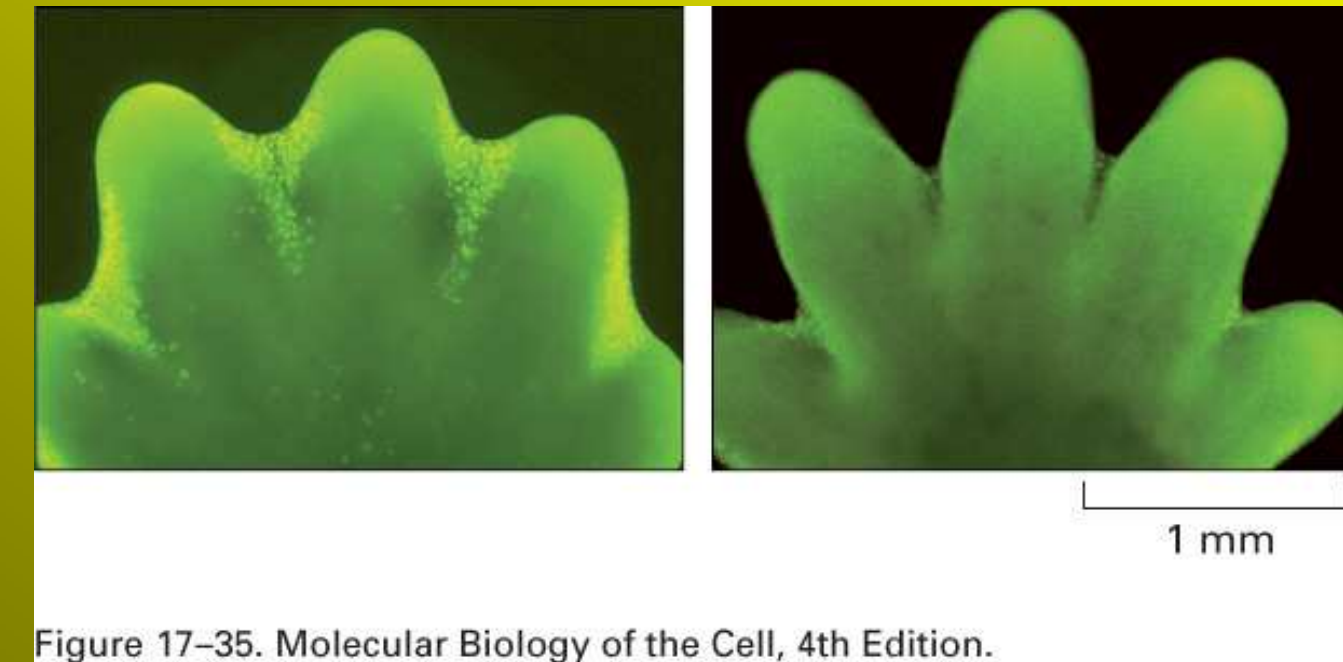
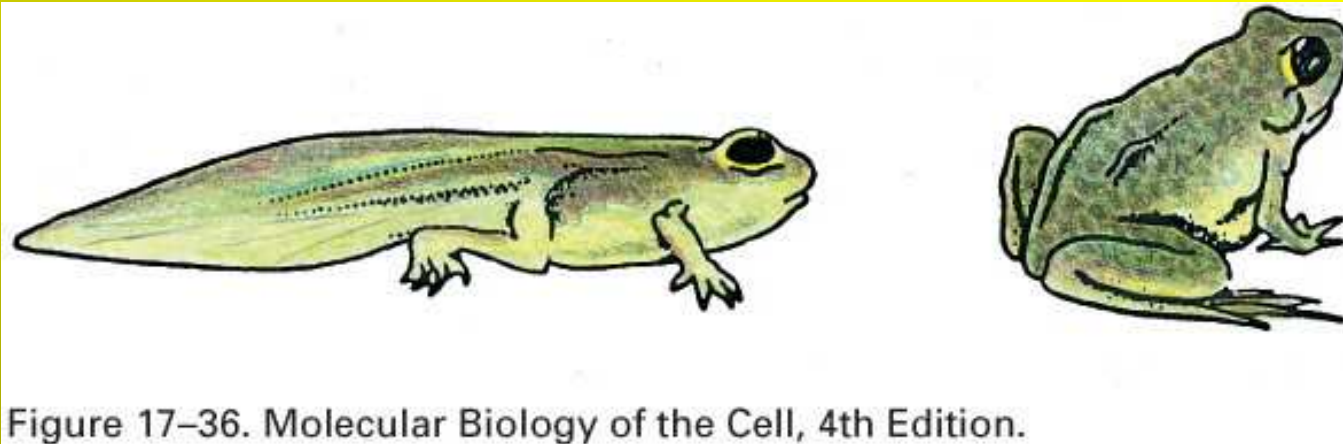

# Apoptóza a onemocnění

**Table 3.** Diseases with Dysregulated Apoptosis

Excessive Apoptosis	Deficient Apoptosis
Degenerative neurological diseases (Alzheimer's, Huntington's, Parkinson's)	Autoimmune lymphoproliferative syndrome (Canale-Smith syndrome)
Aplastic anemia	Graves' disease
Acquired immunodeficiency syndrome	Hypereosinophilia syndrome
Hashimoto's thyroiditis	Hashimoto's thyroiditis
Lupus erythematosus	Lupus erythematosus
Liver failure	Lymphoma
Multiple sclerosis	Leukemia
Myelodysplastic syndrome	Solid tumors
Type I diabetes mellitus	Type I diabetes mellitus
Ulcerative colitis	Osteoporosis
Wilson's disease	Developmental defects
Chronic neutropenia	
Developmental defects	

# Features of Apoptosis Vs Necrosis

1972 Kerr Wyllie Currie

## Apoptosis

- Chromatin condensation
- Cell Shrinkage
- Preservation of Organelles and cell membranes
- Rapid engulfment by neighboring cells preventing inflammation
- Biochemical Hallmark:  
DNA FRAGMENTATION

## Necrosis

- Nuclear swelling
- Cell Swelling
- Disruption of Organelles
- Rupture of cell and release of cellular contents
- Inflammatory response

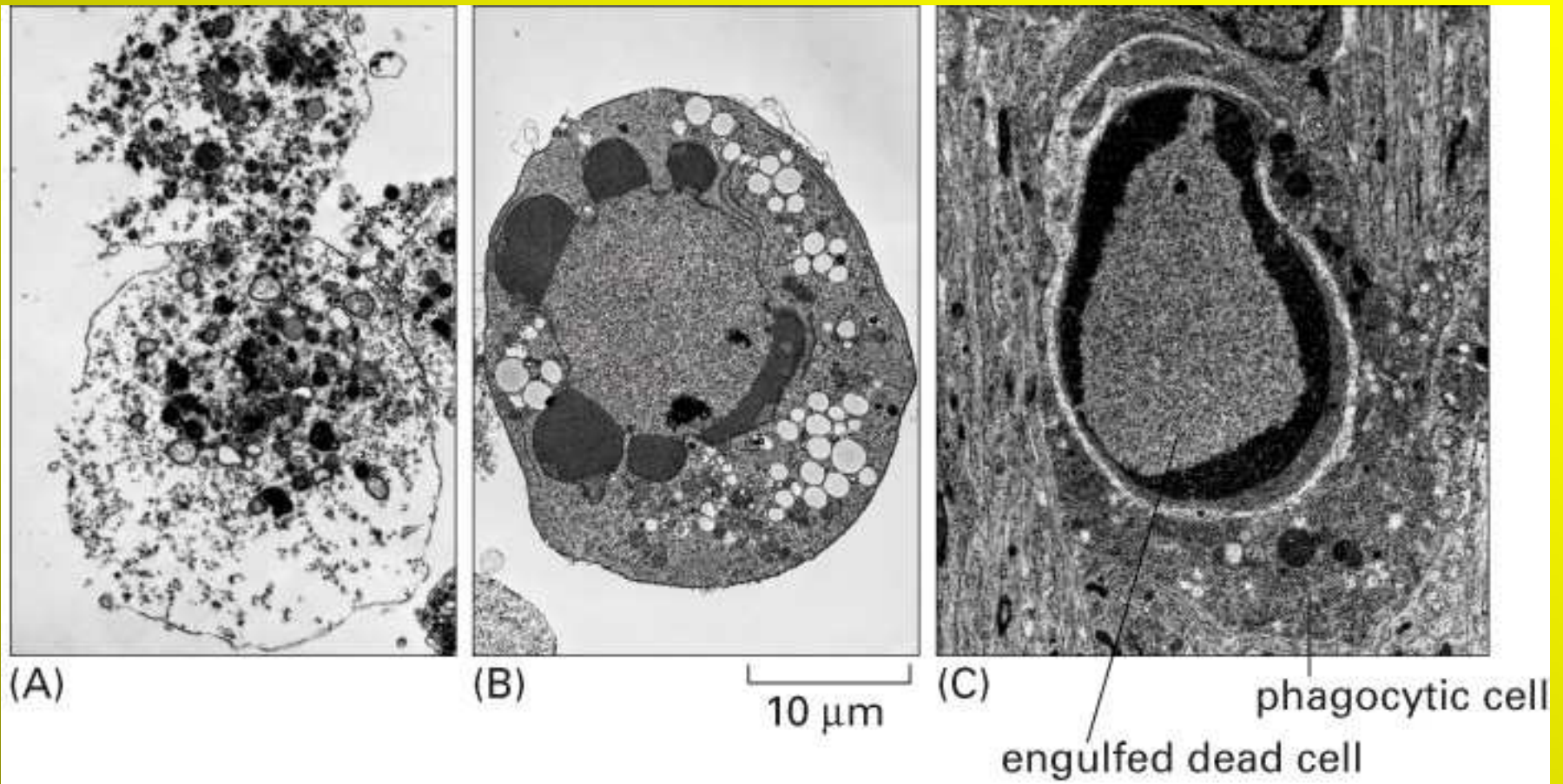
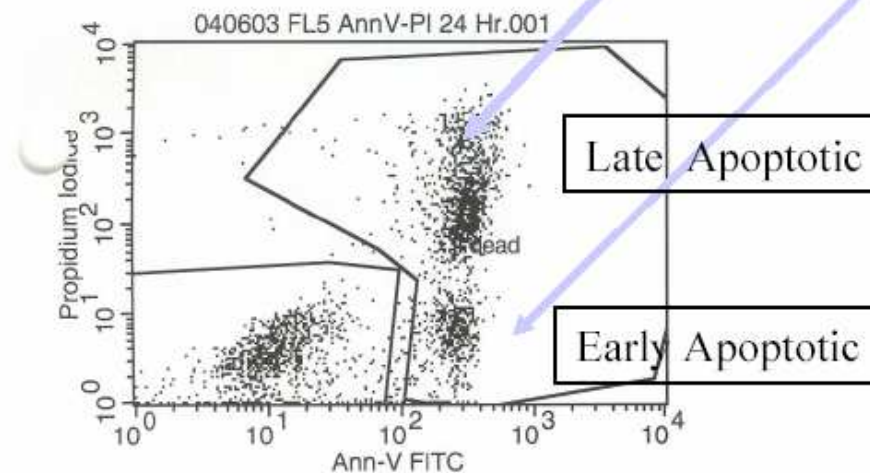
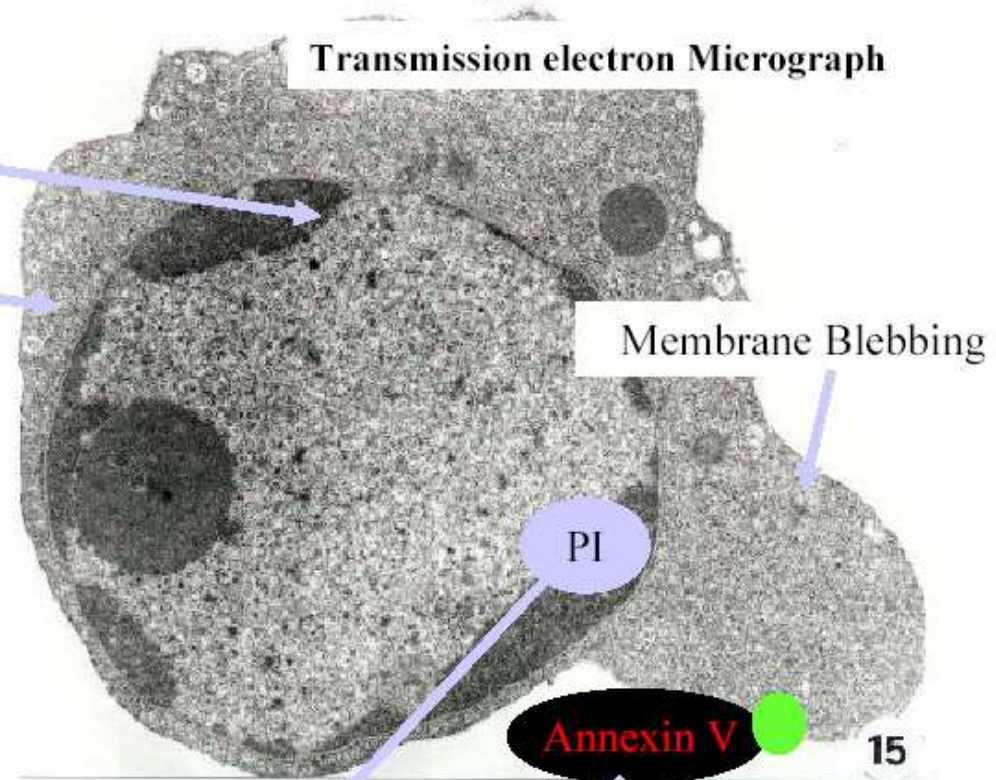

Figure 17–37. Molecular Biology of the Cell, 4th Edition.

# Apoptosis Assays

## Apoptosis

- Chromatin condensation
- Cell Shrinkage
- Preservation of Organelles and cell membranes
- Membrane Asymmetry lost and detected by Annexin V



## Fragmentace jader

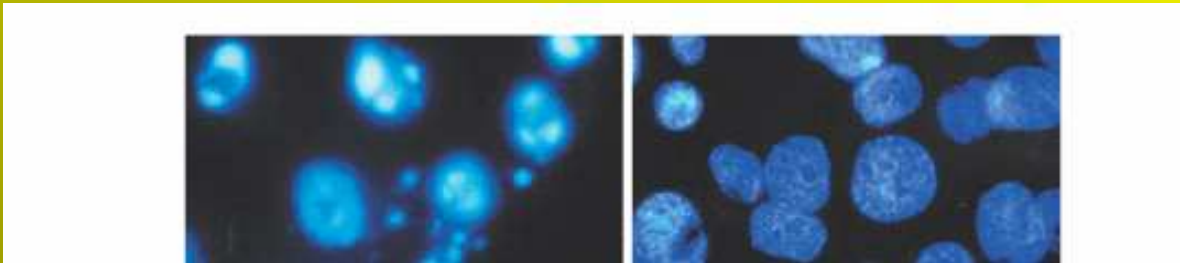

## Fragmentace cílových proteinů kaspázami

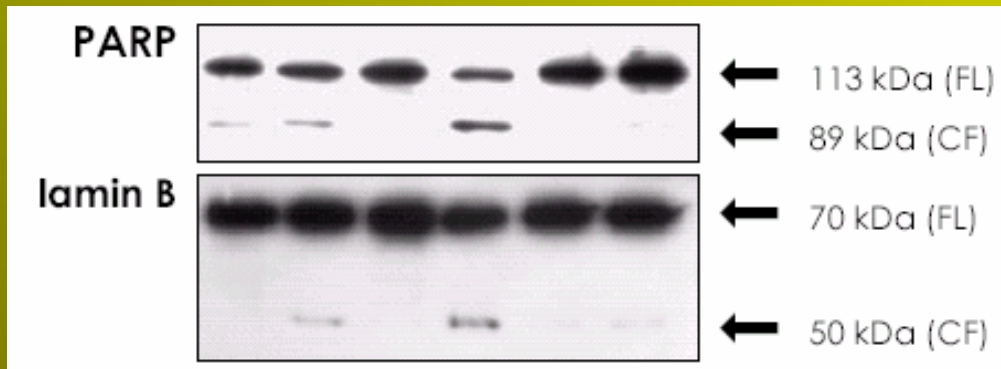

## Aktivace kaspáz

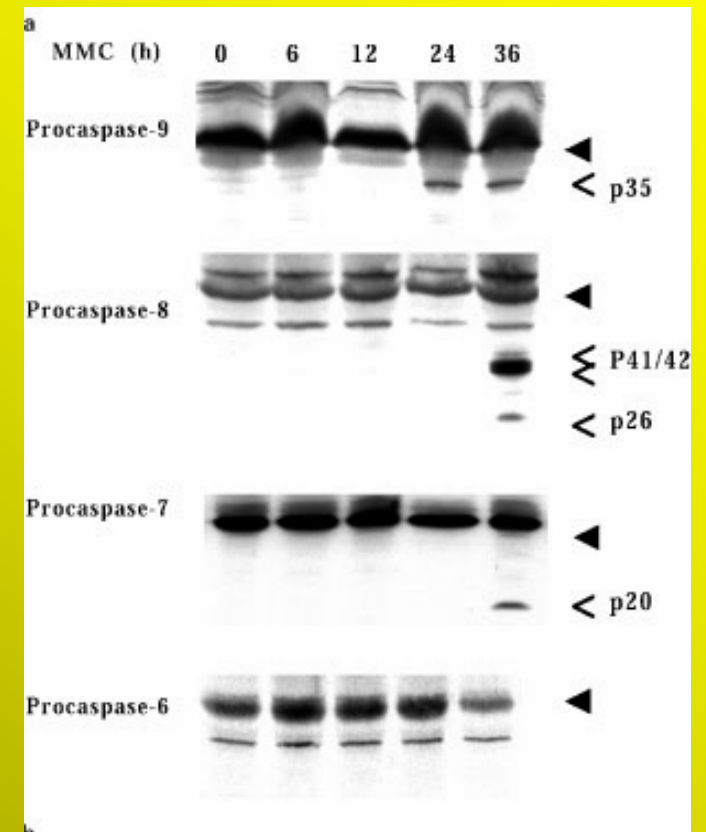



# Apoptosis –DNA fragmentation Assay

- DNA Fragmentation
- DNA content analysis by flow.

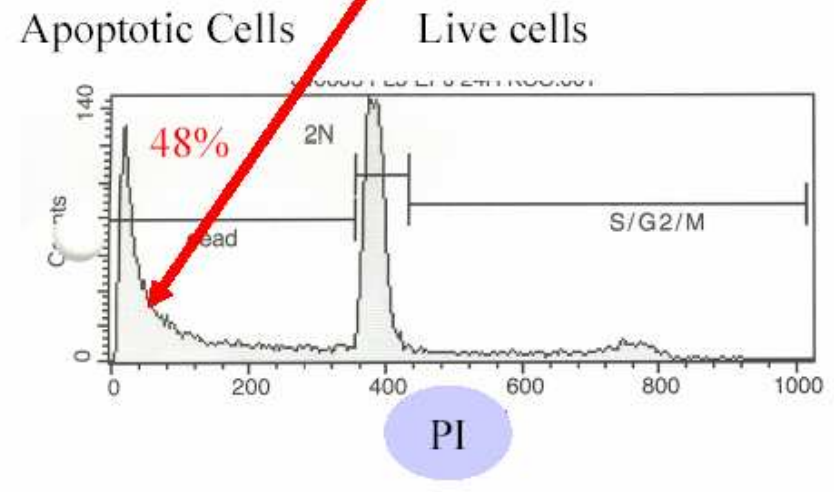
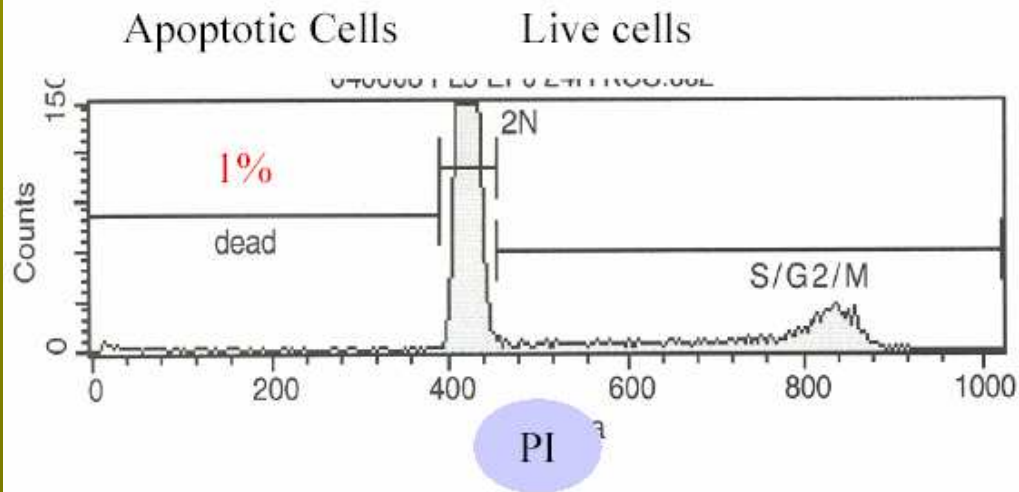
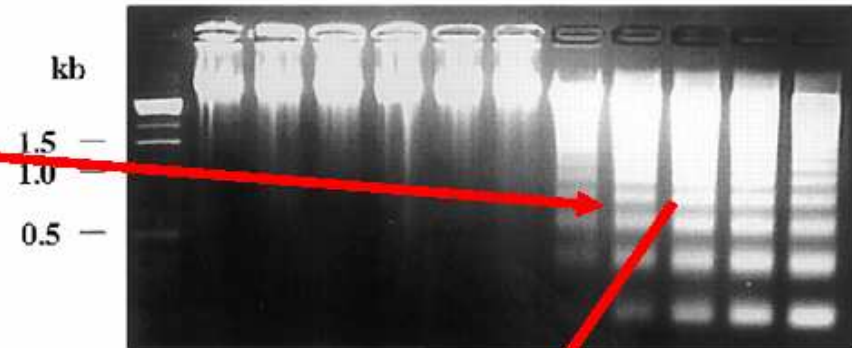

# Mitochondria and Apoptosis

## Membrane Potential( $\Psi$ )

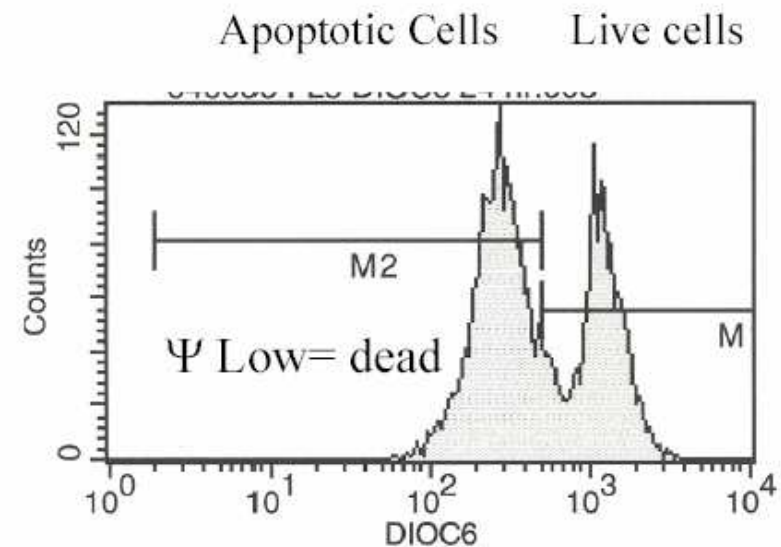
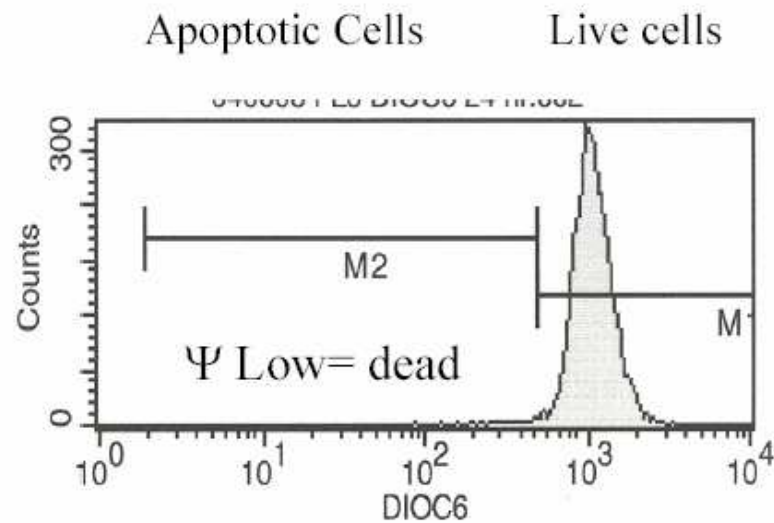

# Apoptóza –modely

Table 1. Evolutionary conservation of pro- and anti-apoptotic proteins<sup>a</sup>

<i>Caenorhabditis elegans</i>	<i>Drosophila melanogaster</i>	Mammalian	Function	Refs
CED-3	DREDD (DCP-2) (I), DRONC (I), Strica (Dream) (I) DCP-1 (II), Drice (II), DECAP (II), DAMM (II)	Caspases-2, -8, -9, -10, -12 (I) Caspases-3, -6, -7 (II)	Cysteine proteases are responsible for cleavage of cellular substrates; type I are initiator caspases and contain long prodomains whereas type II are effector caspases and contain short prodomains	3,64,65
-	DIAP-1 DIAP-2, Deterin	XIAP, ML-IAP, cIAP-1, cIAP-2 NAIP, survivin	Inhibitor of apoptosis proteins (IAPs) contain baculoviral IAP repeat (BIR) domains; DIAP-1, XIAP, ML-IAP, cIAP-1 and cIAP-2 inhibit caspases; survivin appears to regulate cell-cycle progression	5,66
-	Reaper (AVAF), HID (AVPF), Grim (AIAY)	SMAC (DIABLO) (AVPI)	Pro-apoptotic proteins prevent IAPs from inhibiting caspases	13,67
CED-4	DARK (DAPAF-1 or HAC-1)	APAF-1	Adapter proteins oligomerize, bind and activate cysteine proteases	18,64,68
CED-9	BCL-2 homolog?	BCL-2 (BH1-4), BCL-X <sub>L</sub> (BH1-4), BCL-W (BH1-4), MCL-1 (BH1-4), A1 (BH1-4), BOO (DIVA) (BH1,2,4)	Anti-apoptotic proteins: CED-9 directly inhibits CED-4; mammalian homologs contain multiple BCL-2 homology (BH) domains and prevent activation of APAF-1 by inhibiting the release of cytochrome c from mitochondria	64,69
EGL-1 ceBNIP-3 <sup>b</sup>	-	BIK (NBK) (BH3), BAD (BH3), BID (BH3), HRK (DP5) (BH3), BIM (BOD) (BH3), BLK (BH3), NIX (BH3), BNIP-3 <sup>b</sup> (BH3), NOXA (BH3)	Pro-apoptotic BH3-only proteins heterodimerize via the BH3 domain with anti-apoptotic CED-9 or BCL-2 proteins and inhibit their anti-apoptotic function	28,64
-	DEBCL (DROB-1, DBOK or DBORG-1)	BAX (BH1-3), BAK (BH1-3), BOK (MTD) (BH1-3), BCL-X <sub>S</sub> (BH3,4)	Pro-apoptotic BAX-like proteins promote cytochrome c release from mitochondria and activation of caspases	69-71
NUC-1	dCAD	DFF (CAD), DNase II, DNase-γ, NUC-18, NUC-70	Nucleases mediate DNA fragmentation; DFF40 or CAD appear to be the most important and are activated by caspase degradation of associated inhibitors, DFF45 or ICAD	72-74

<sup>a</sup>Abbreviations: APAF-1, apoptotic protease-activating factor 1; cIAP-1, cellular inhibitor of apoptosis protein 1; BH, BCL-2 homology domain; NAIP, neuronal apoptotic inhibitory protein; XIAP, X-linked IAP.  
<sup>b</sup>ceBNIP-3 contains a BH3 domain but dimerizes through alternate domains.

# Caenorhabditis Elegans

## Why study worms?

- Reproduce very rapidly. (3 week life span)
- Easy to induce mutations with ethyl methylsulfonate (EMS)
- Capable of reproducing as Hermaphrodites.
- Simple organism with only 1090 somatic cells .
- Development is invariant and has been mapped such that the fates of all cells are known.

# Caenorhabditis Elegans

## Apoptosis

- 131 of 1090 somatic cells normally undergo PCD.
- Death of these cells is not required for viability.
- Special optics can be used to observe abnormal deaths in living organisms.

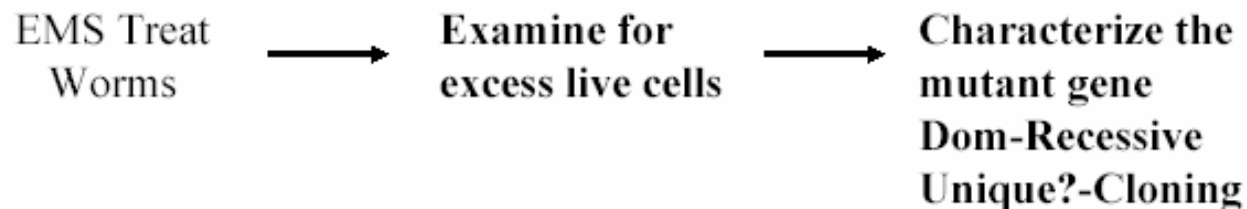

**These studies demonstrate “genetic”  
nature of PCD or apoptosis**

# Molecular regulation of Apoptosis: C. Elegans:

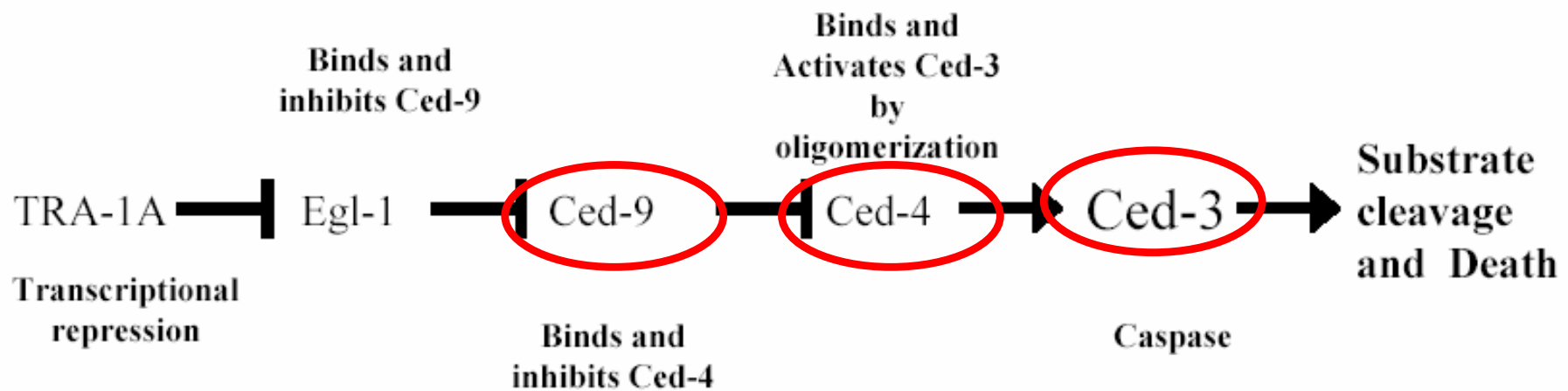

# Caspase's

JBC V 274 Pg 20049

- First identified as the enzyme which activates (converts) Interleukin 1 $\beta$  (ICE).
- Cysteine protease which cleaves after Aspartic Acid. (Asp)
- Activated by proteolysis (after Asp).
- Substrates include themselves and other Caspase's
- Thus amplification cascades are possible.
- Apoptosis substrates are numerous (~40 and rising) and include PARP, DFF(ICAD), BID.

# Caspase Structure and Regulation

## Box 1. General principles of caspase activation

Caspases are cysteine proteases that cleave substrates after specific aspartate residues. The specificity of target sites seems to be determined by a four-amino-acid recognition motif, as well as by other aspects of the three-dimensional structure of the target protein. Caspases are synthesized as proenzymes that are activated through cleavage at internal aspartate residues by other caspases (Fig. 1); however, caspases might also have weak catalytic activity in their unprocessed form. Proteins such as *C. elegans* CED-4 or its mammalian homolog Apaf-1 can bind to procaspases and can also multimerize. Multimerization might support cross-activation of adjacent caspase zymogens. Activated caspases consist of dimers of a large and a

small subunit that, together, form the active site of the enzyme. Structures obtained by X-ray crystallography suggest that these heterodimers themselves dimerize to form an enzyme with two active sites. Procaspases are often divided into two classes; those with long N-terminal domains are termed initiator caspases, and those with short N-terminal domains are called executor caspases. Long prodomains can bind to activator molecules, such as Apaf-1, or adaptor molecules associated with membrane receptors, such as Fas. It is thought that long prodomain caspases activate short prodomain caspases; however, this assertion is only supported by a limited number of experiments.

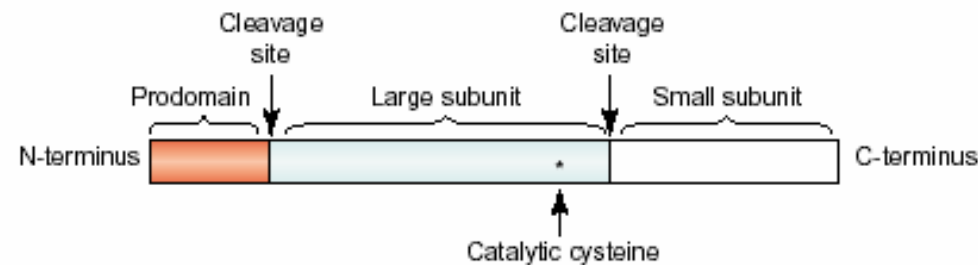

*TRENDS in Cell Biology*

Figure 1.



# Caspases

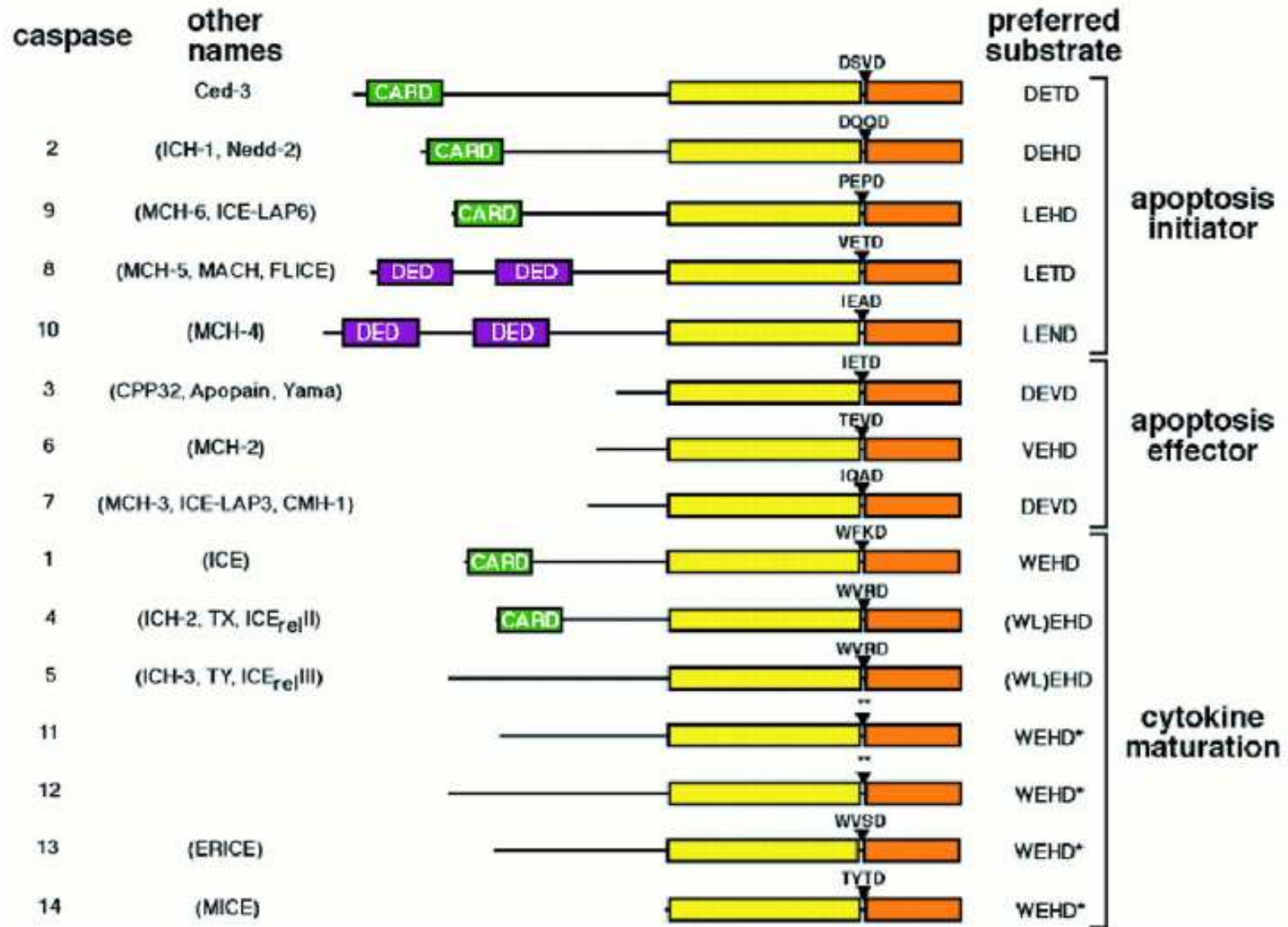

(A) procaspase activation

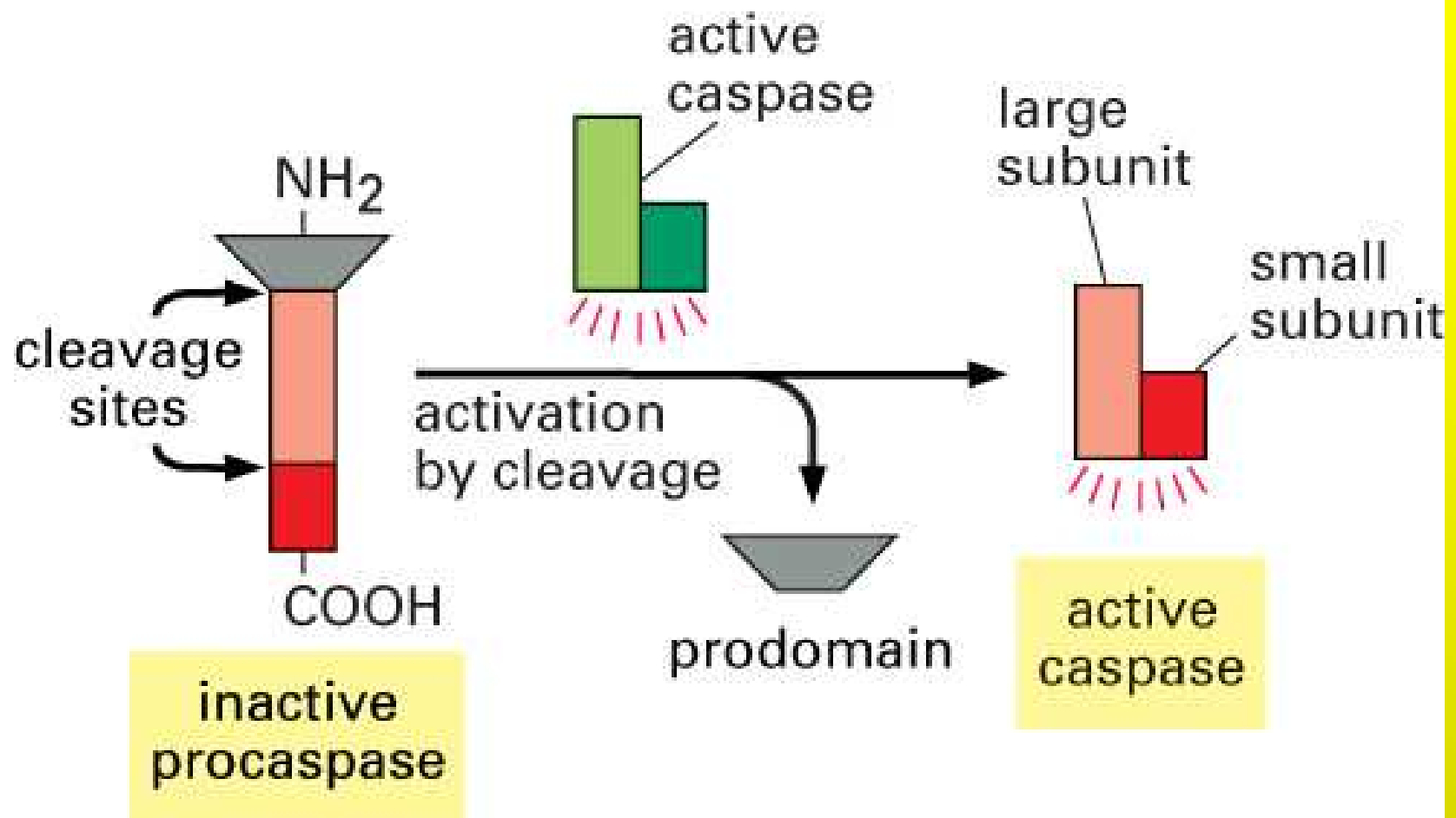

Figure 17-38 part 1 of 2. Molecular Biology of the Cell, 4th Edition.

---

**Table 2.** Target Proteins of Caspases

---

## Cytoskeletal proteins

Actin,  $\beta$ -catenin, fodrin, gelsolin, gas2, keratins

## Nuclear proteins

Lamins, Rb protein, Sp1, I $\kappa$ B- $\alpha$ , DNA-dependent protein kinase, poly(ADP)-ribosylating protein (PARP), Mdm2, U1-70 kD subunit of small nuclear ribonucleoprotein, topoisomerases I and II, histone H1, hnRP C1 and C2, differentiation specific element binding protein (DSEB)/ RF-C140, dentatorubral-pallidoluysian atrophy gene protein (DRPLA), sterol regulatory element binding protein (SREBP)

## Regulatory proteins

Procaspases, focal adhesion kinase (FAK), protein kinase c $\delta$ , presenilin 1 and 2, rabaptin-5, MAPK/ERK kinase kinase1 (MEKK1), PAK2/hPAK65, PITSLRE protein kinase, Huntington, D4-GDI (GDP dissociation inhibitor), phospholipase A2, DNA fragmentation factor (DFF-45) or inhibitor of caspase activated Dnase (ICAD), Bcl-2, Bcl-x<sub>L</sub>, p28 Bap31

---

# ICAD – příklad substrátu

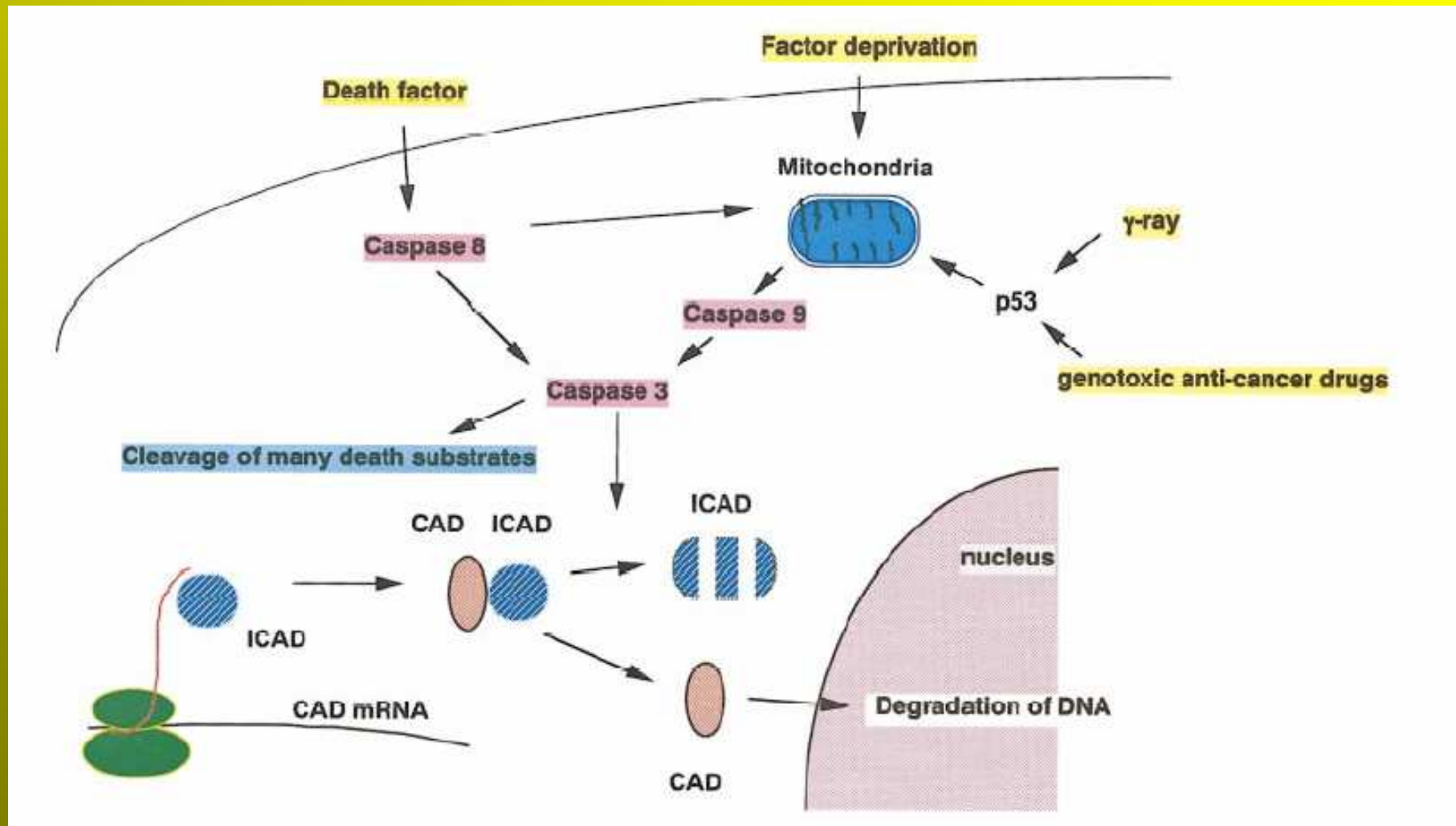

**Death receptor pathway**

**Mitochondrial pathway**

Chemotherapeutics  
DNA damaging agents  
irradiation  
growth-factor depletion

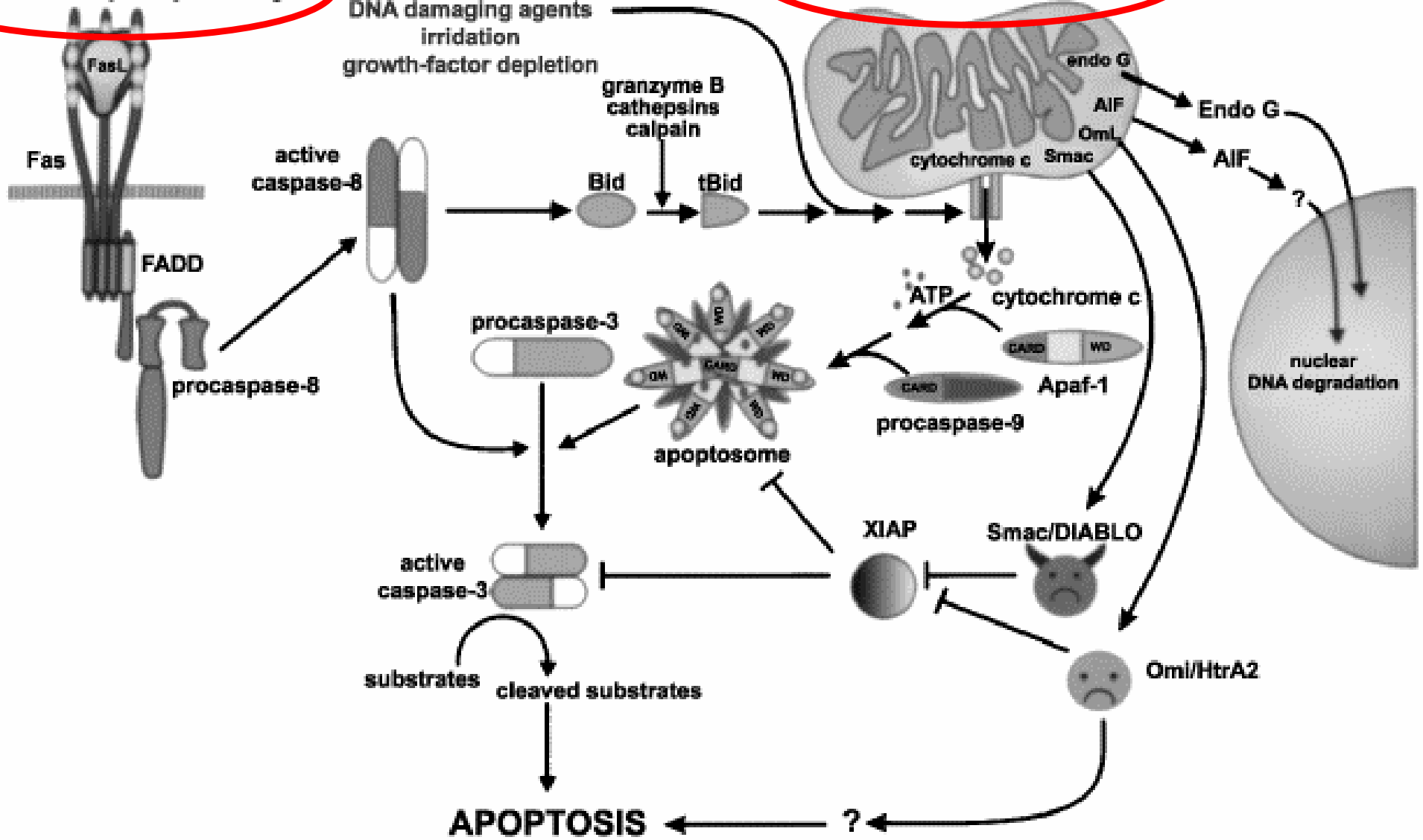

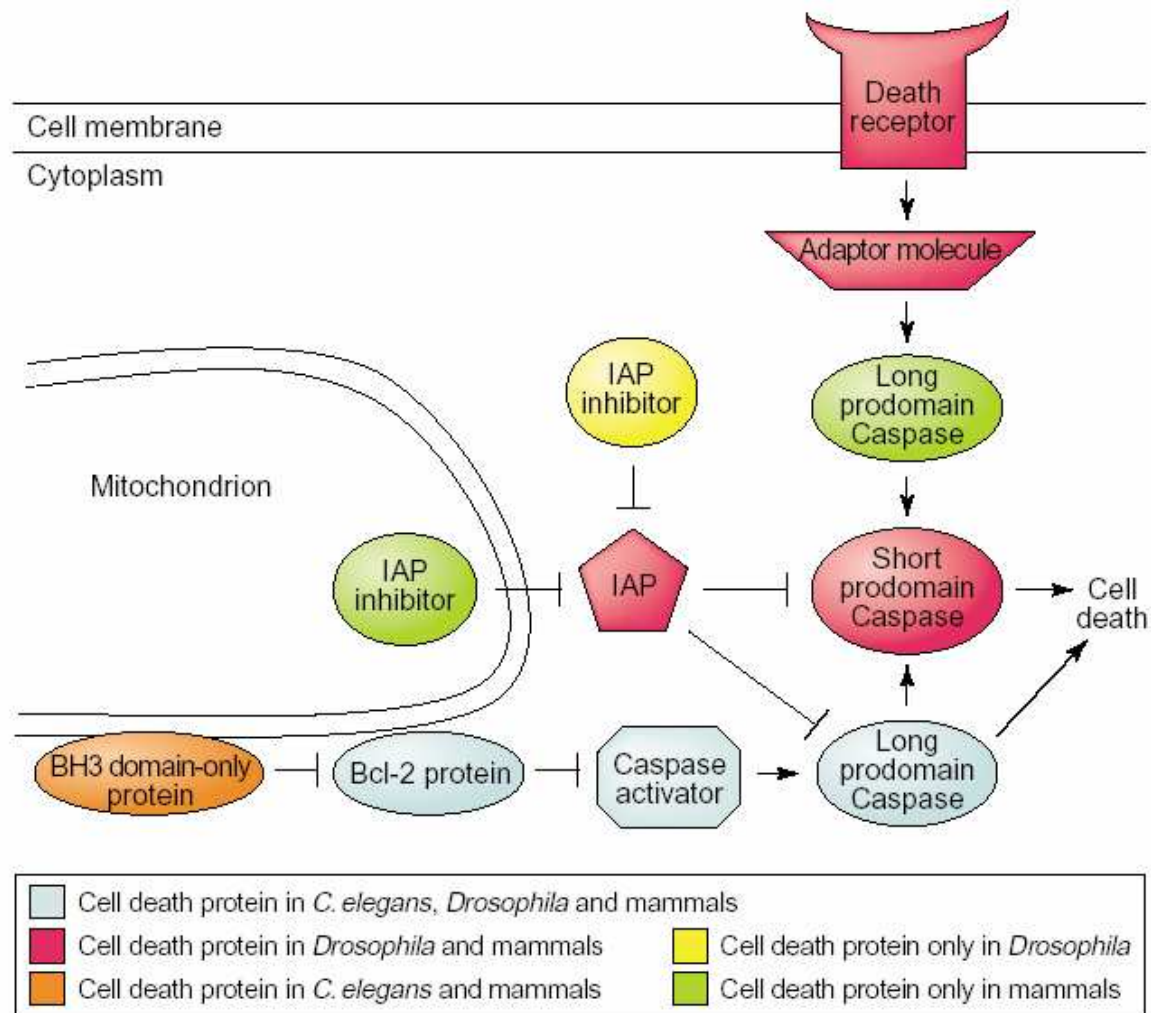

TRENDS in Cell Biology

**Figure 2.** Pathways that regulate caspases. This figure summarizes three major pathways leading to caspase activation as gleaned from studies in mammals, *Drosophila* and *C. elegans*. The evidence used to draw this figure comprises both genetic epistasis studies and biochemical experiments. Membrane receptor complexes, such as Fas or TNF receptor complexes, can activate caspases directly following receptor aggregation. Mitochondrial proteins, including members of the Bcl-2 family, control caspase activity by regulating caspase activators such as the *C. elegans* protein CED-4 or its mammalian homolog Apaf-1. CED-4 and Apaf-1 promote caspase activation by acting as scaffolds, thereby allowing cross-activation of adjacent caspase zymogens [6]. IAP (inhibitor of apoptosis) proteins inhibit apoptosis by binding to and inactivating mature caspases.

# Molecular regulation of Apoptosis:

## C. Elegans Vs Mammals

### Core pathway

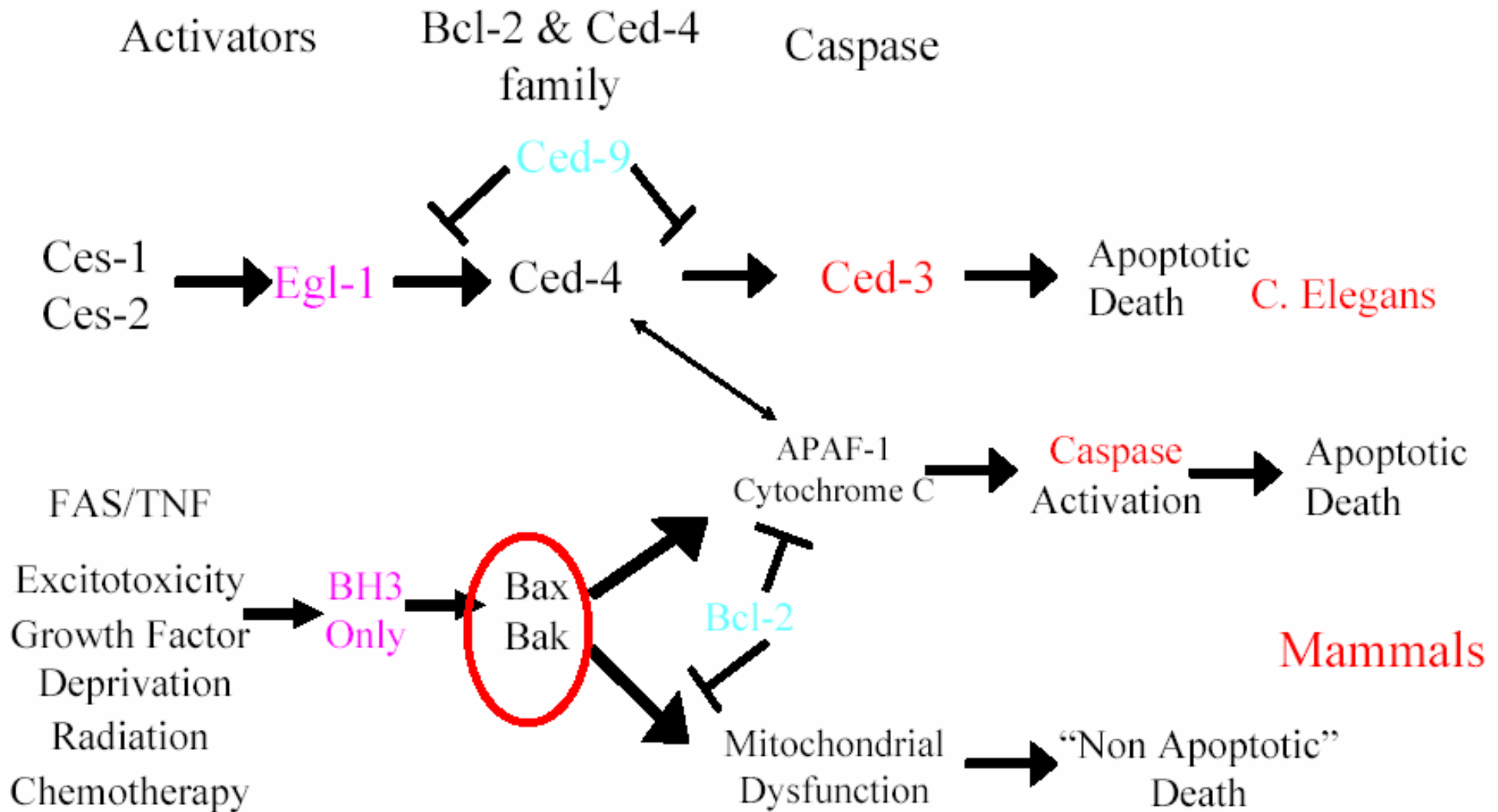

## Bcl-2: Structure and Function

- 1988: Bcl-2 acts by inhibiting apoptosis and synergistic with c-myc in cancer development.
- Has transmembrane domain which targets predominantly to Mitochondria.
- Shown to inhibit cell death with little or no stimulation of cell growth.



## Background: Overview of Bcl-2 Family Members

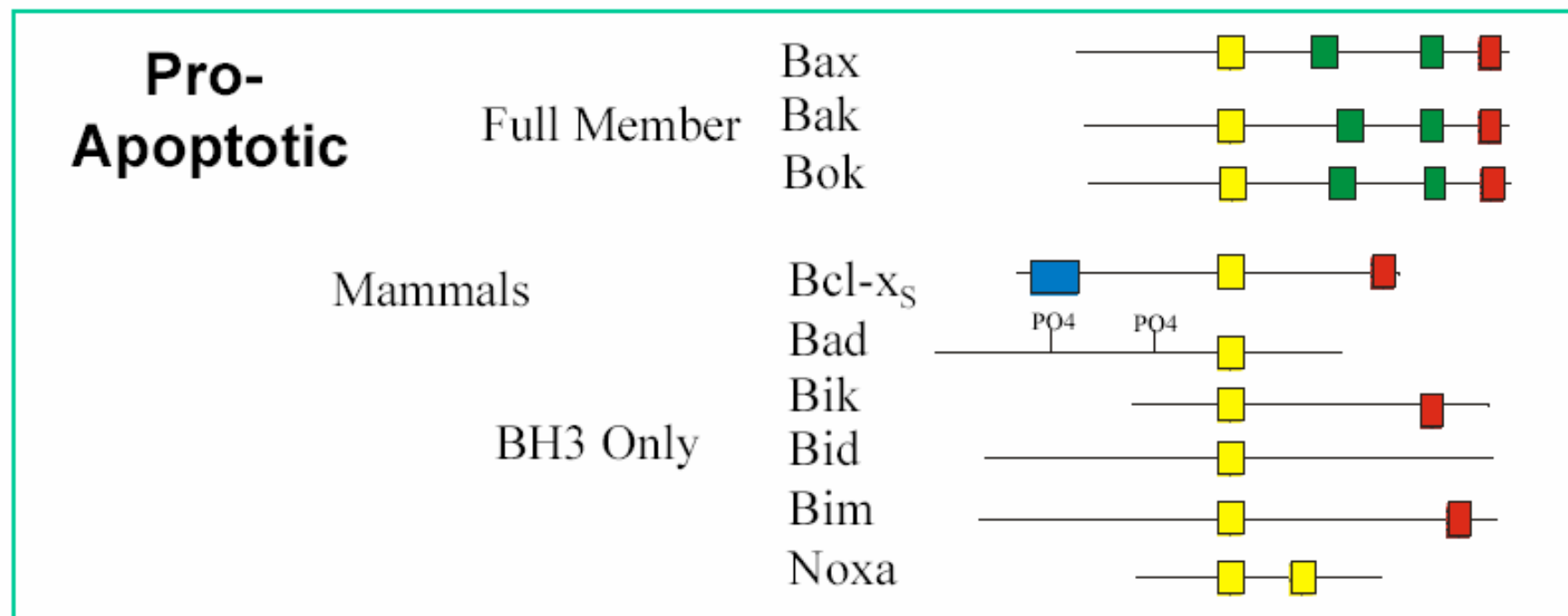
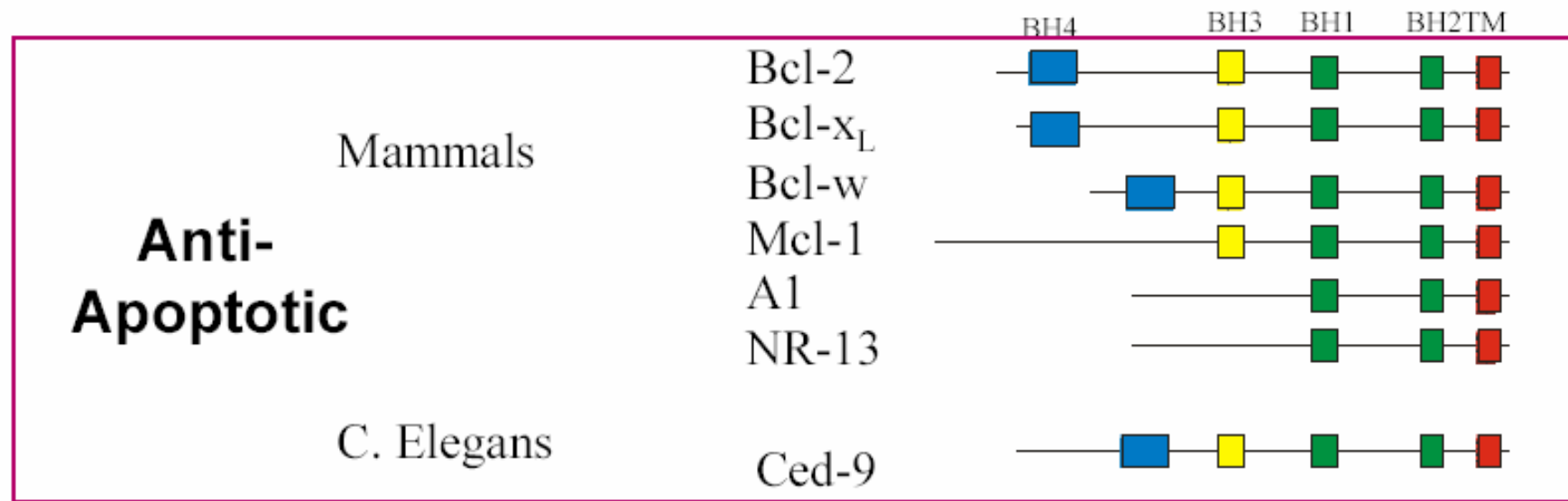

# Bcl-2 Homologue discovered

- 1993-Bcl-2 IP identified Binding Partner-Bax
- Bax Homologous to Bcl-2
- Had the opposite activity when overexpressed.

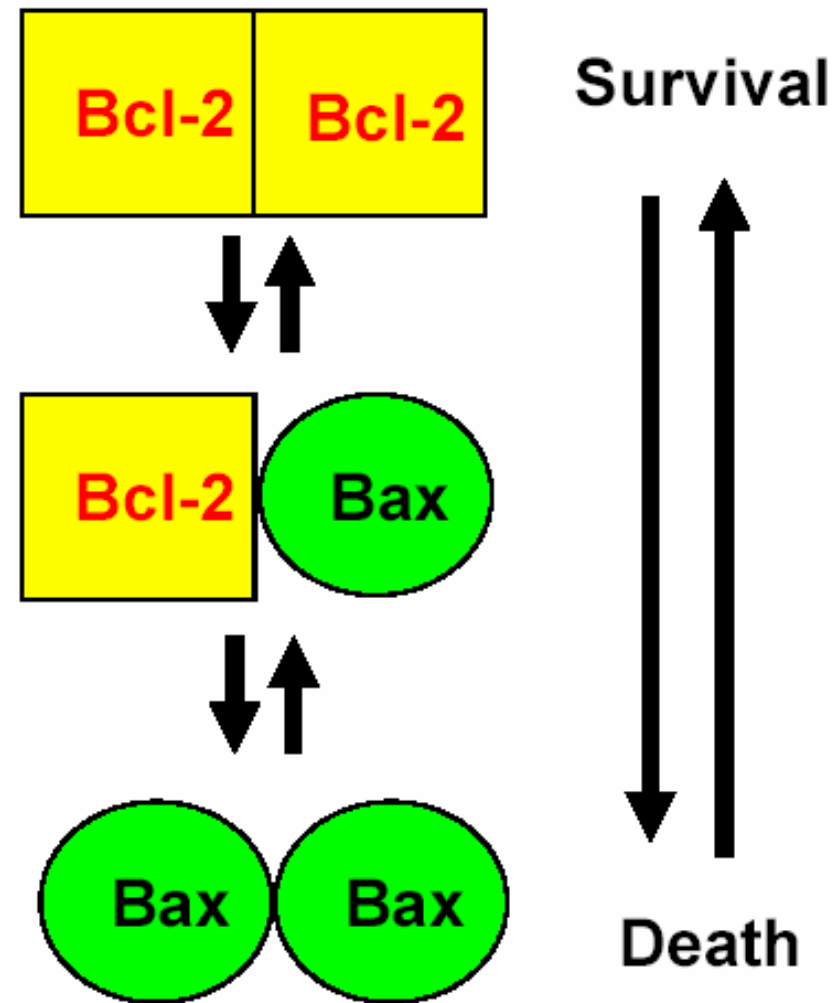

# Pro-apoptotic Bcl-2 Family members

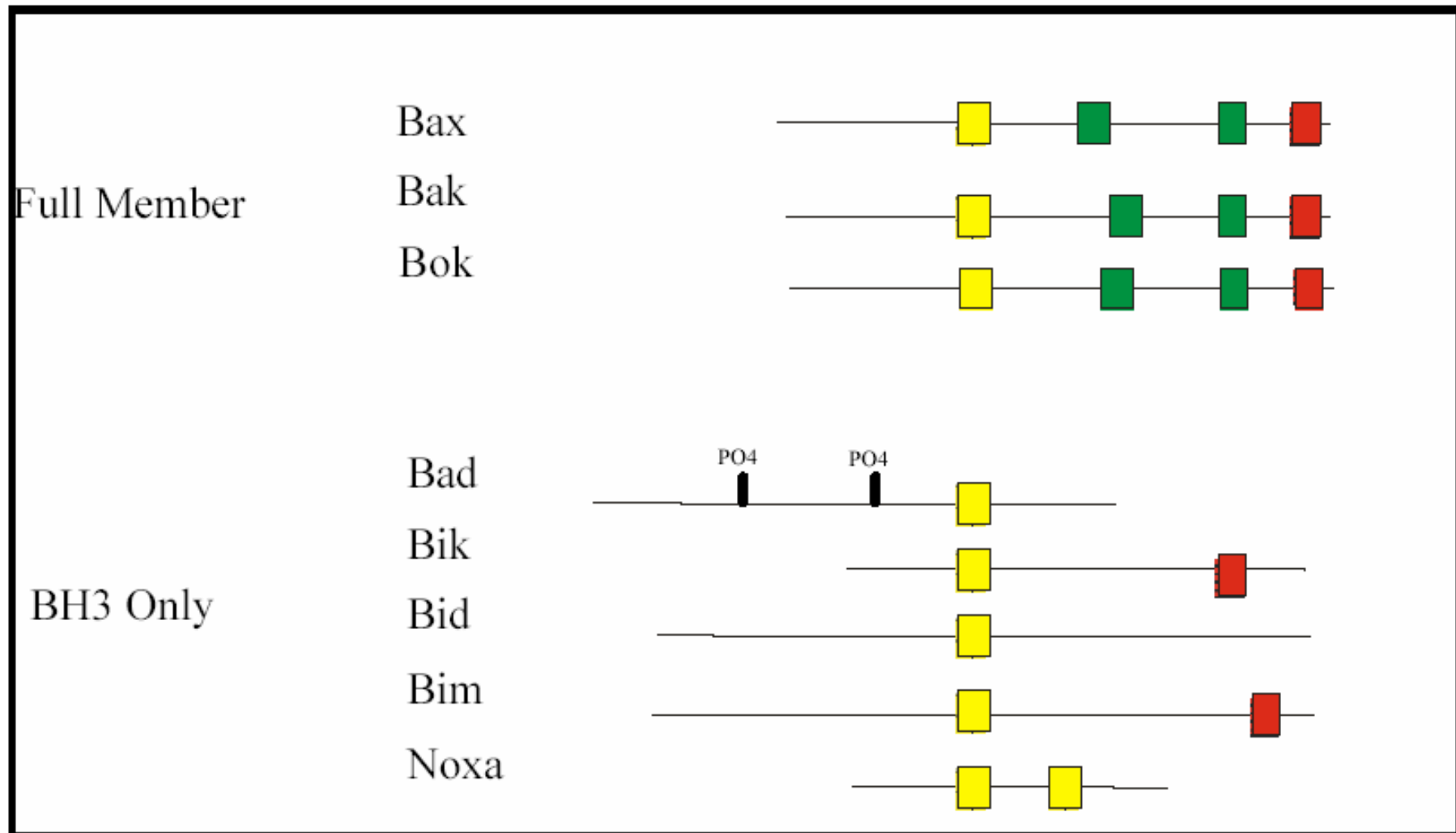

# Selective regulation of Pro-apoptotic Bcl-2 family members.

- Bax Dimerizes and Translocates to Mitochondria
- Bad is Phosphorylated and inactivated by 14-3-3 sequestration
- Bid is activated by caspase 8 cleavage and induces Cyto C release  
Bim interacts with cytoskeleton

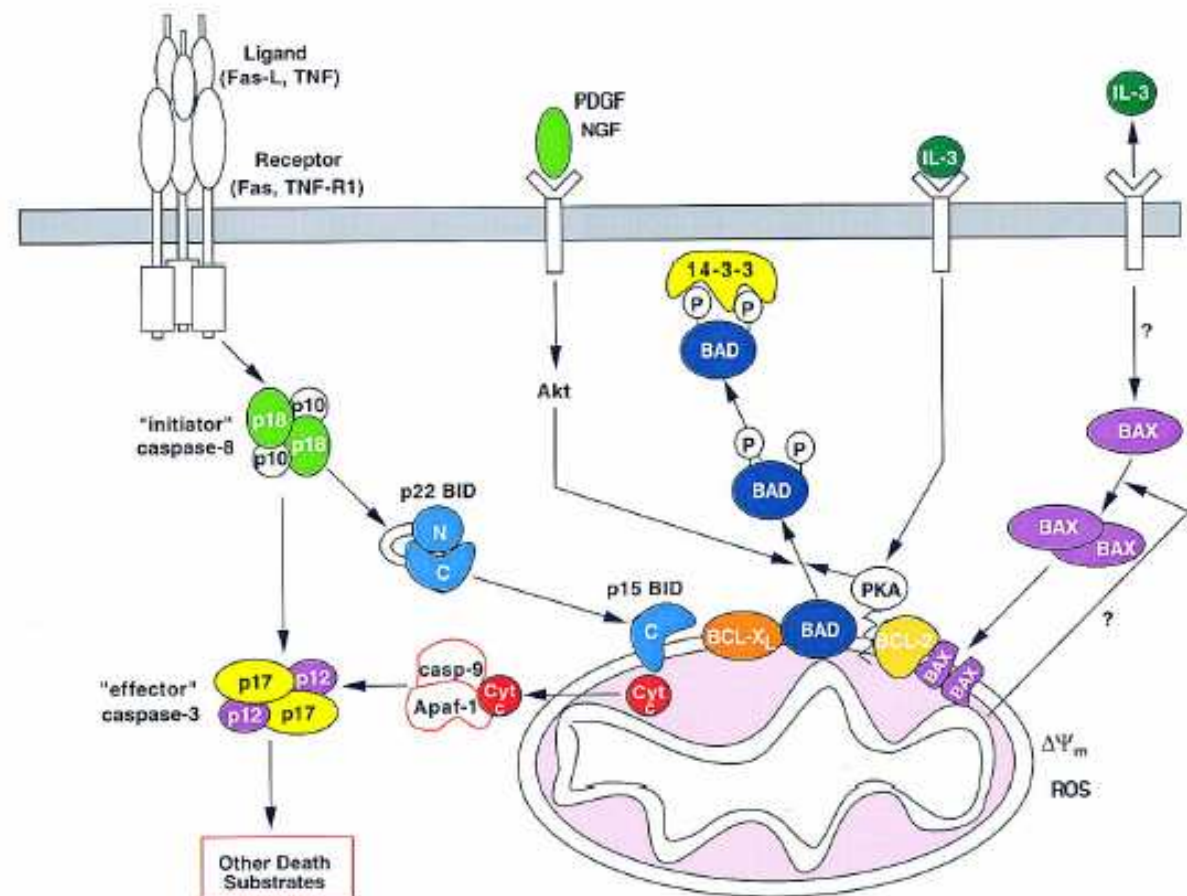

# Selective function of BH3 only family members

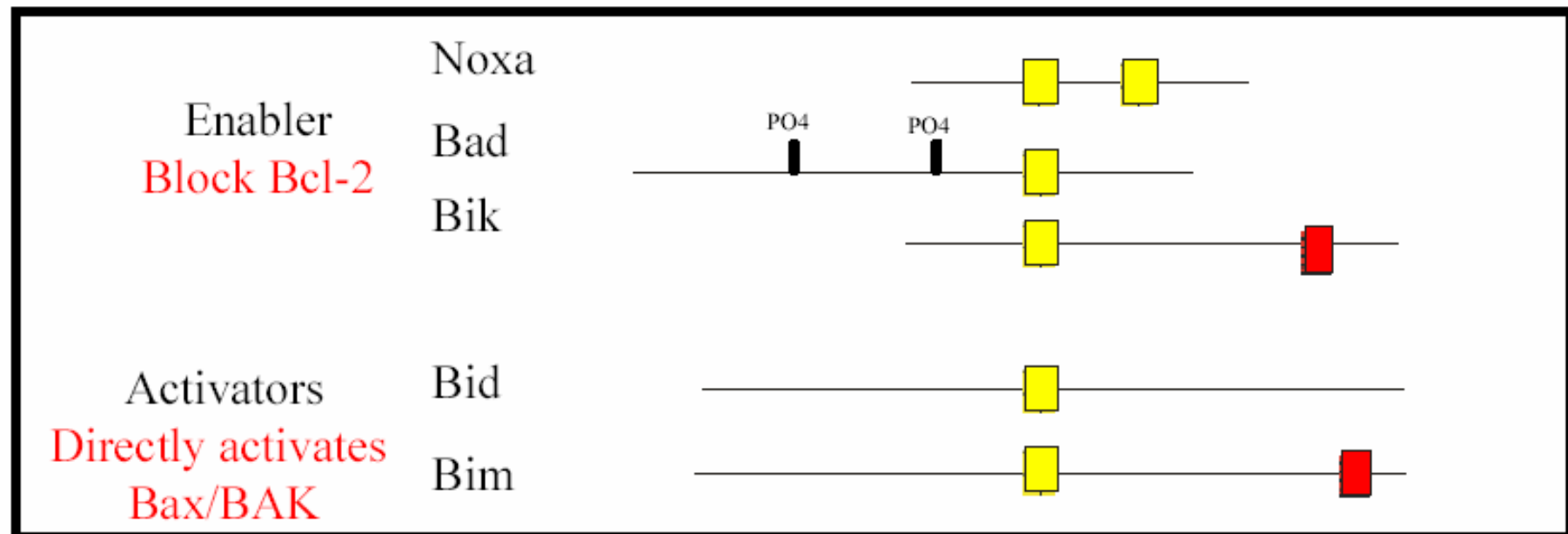

## Bcl-2: Proposed Mechanisms of Action

- Binds and inhibits Proapoptotic Family Members
- Regulates ion flux across the Mitochondria and stabilizes the membrane potential (PTP)
- **Regulates cytochrome C release.**
- Binds and inactivates APAF1
- ROS inhibition
- Many others: Ca Homeostasis, RAF1 interaction
- Regulates VDAC and thus ATP/ADP ratio

# Regulační síť proteinů Bcl-2 rodiny

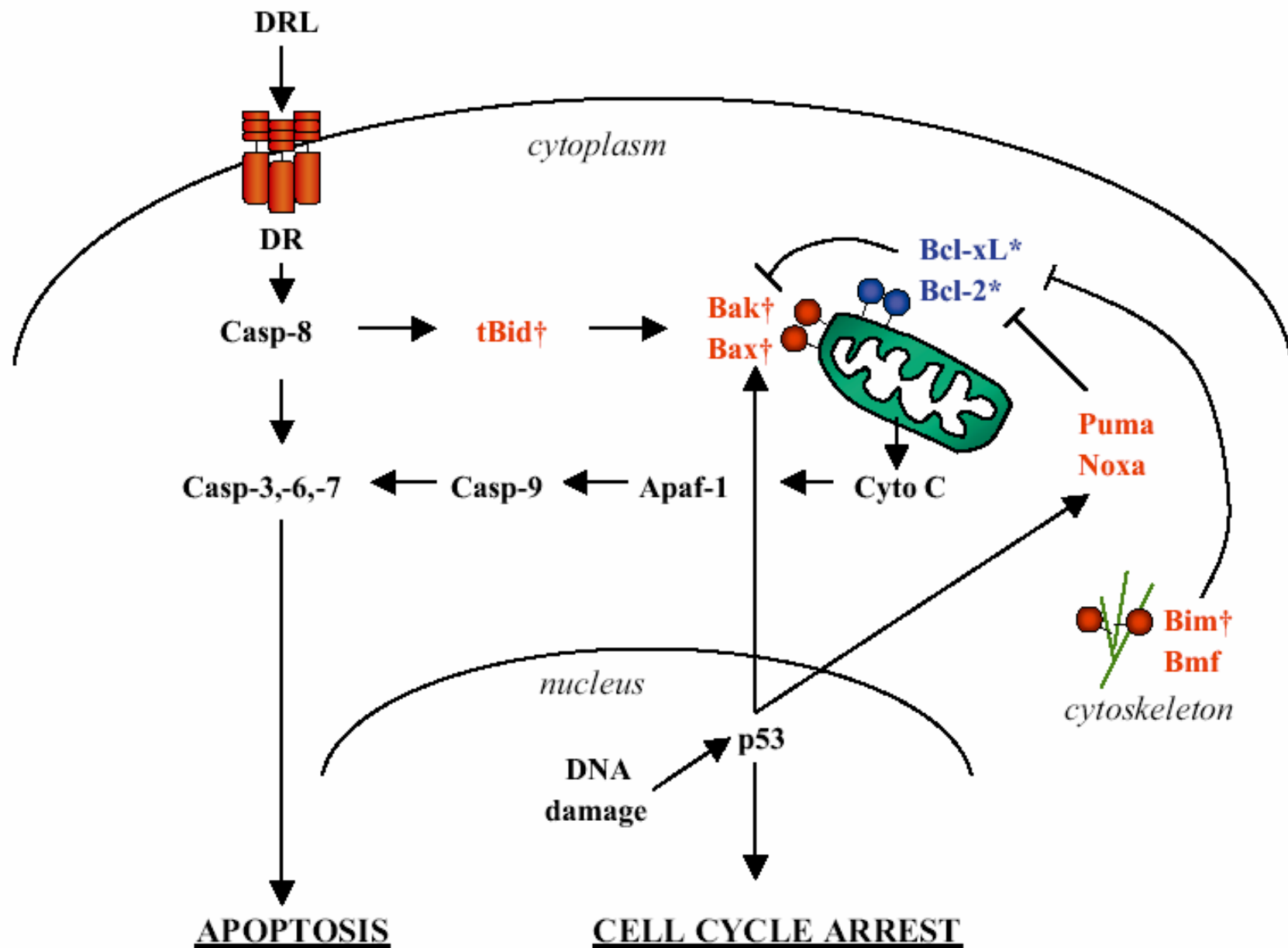

# Další proteiny podílející se na regulaci kaspáz a apoptóze

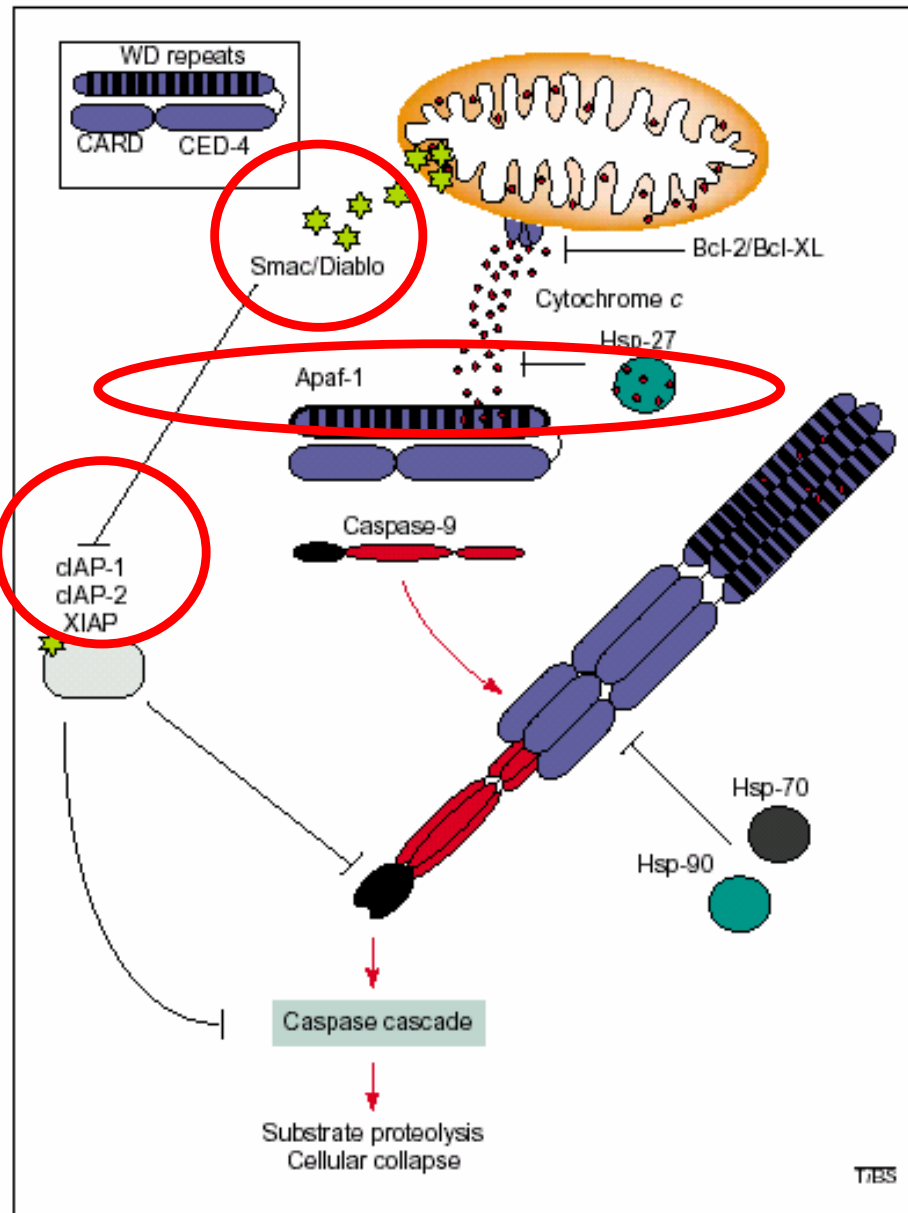

**Fig. 3.** Cytochrome *c* promotes assembly of the apoptosome. Binding of cytochrome *c* to Apaf-1 promotes oligomerization of the latter and recruitment of caspase-9 into a multimeric Apaf-1-caspase-9 complex that results in caspase-9 activation. Several heat-shock proteins (Hsps) might interfere with assembly of the apoptosome, either through interaction with cytochrome *c*, or through interaction with Apaf-1. Inhibitor of apoptosis proteins (IAPs) might interfere with caspase activation events downstream of apoptosome assembly by directly binding to certain caspases. Smac/Diablo, which is also released from mitochondria during apoptosis, might facilitate caspase activation in this pathway by neutralizing IAP function. The modular structure of Apaf-1 is indicated within the insert.



# IAPs – inhibitors of apoptosis

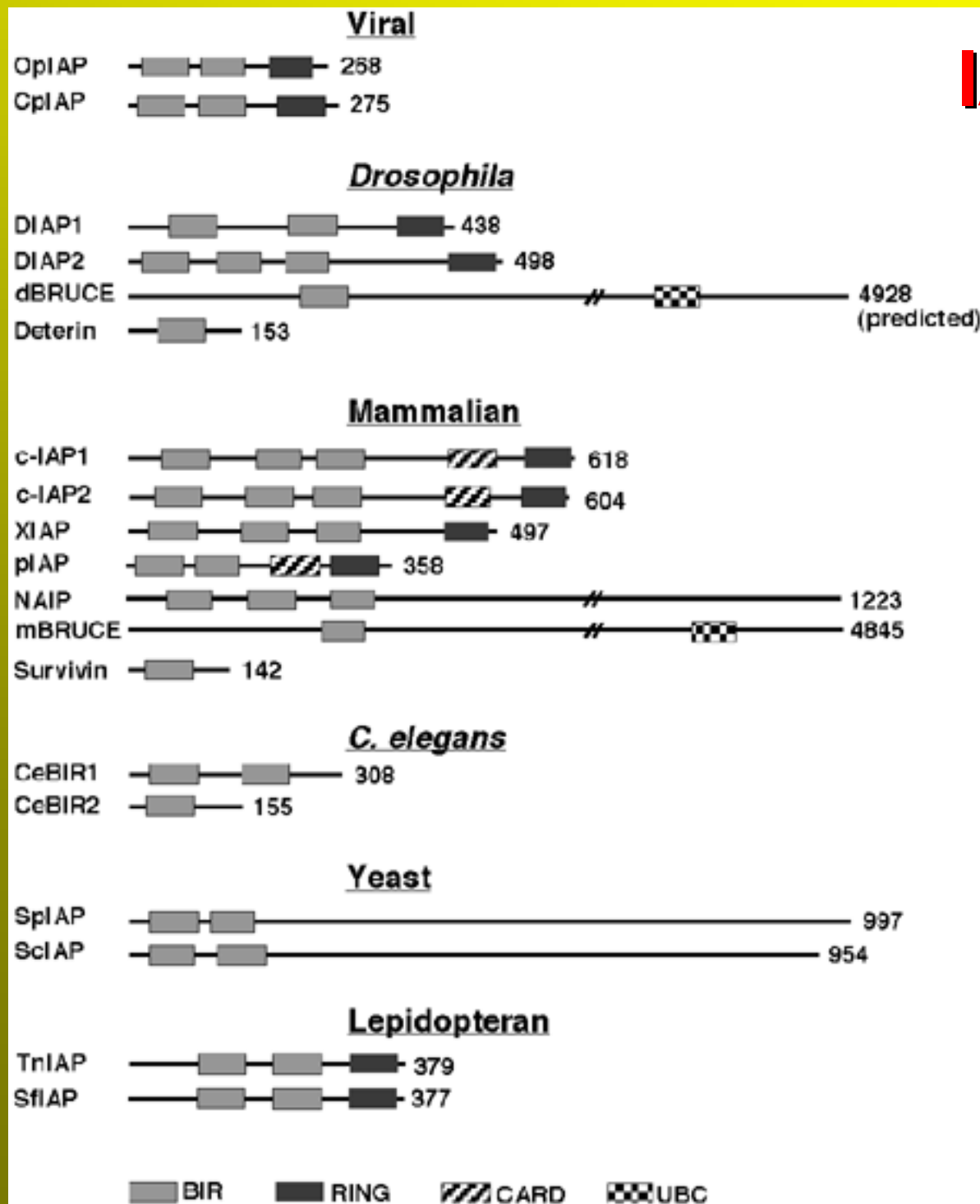

## Extrinsic pathway

## Intrinsic pathway

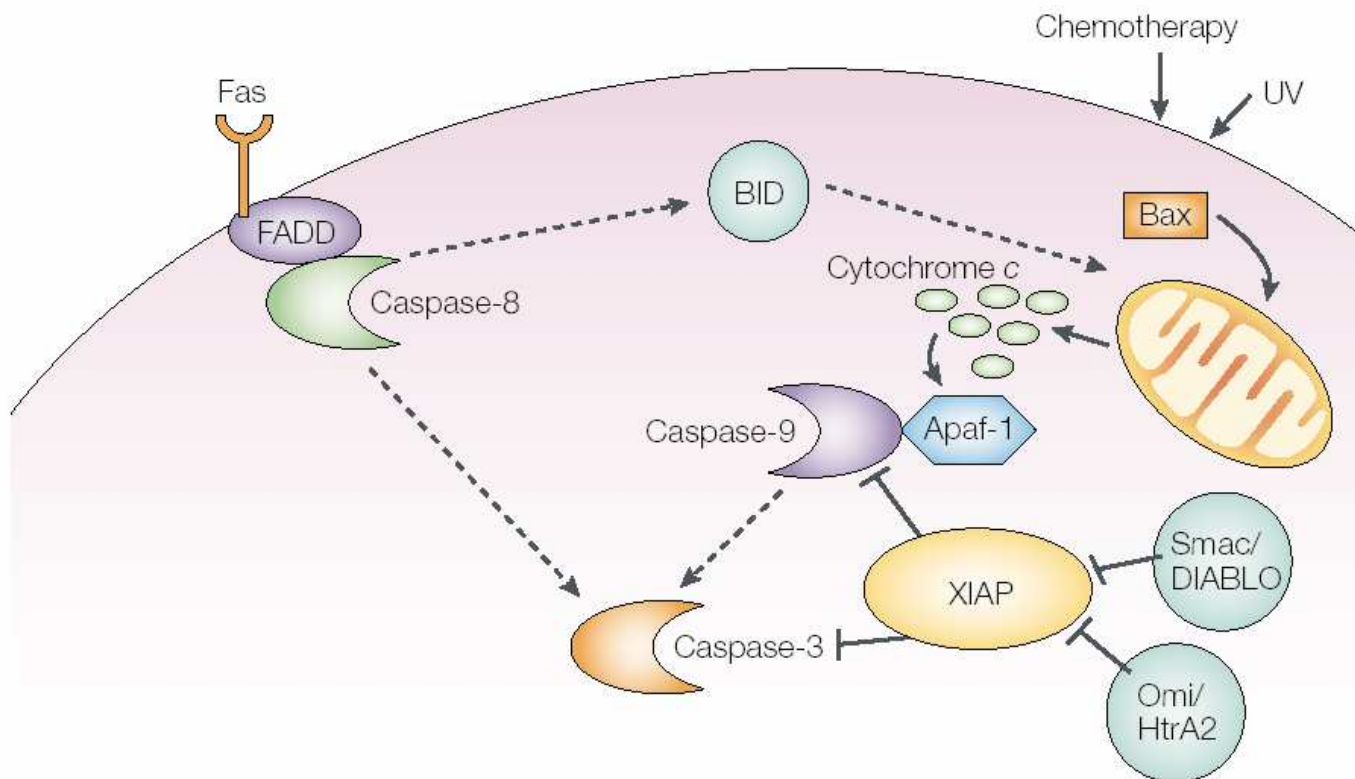
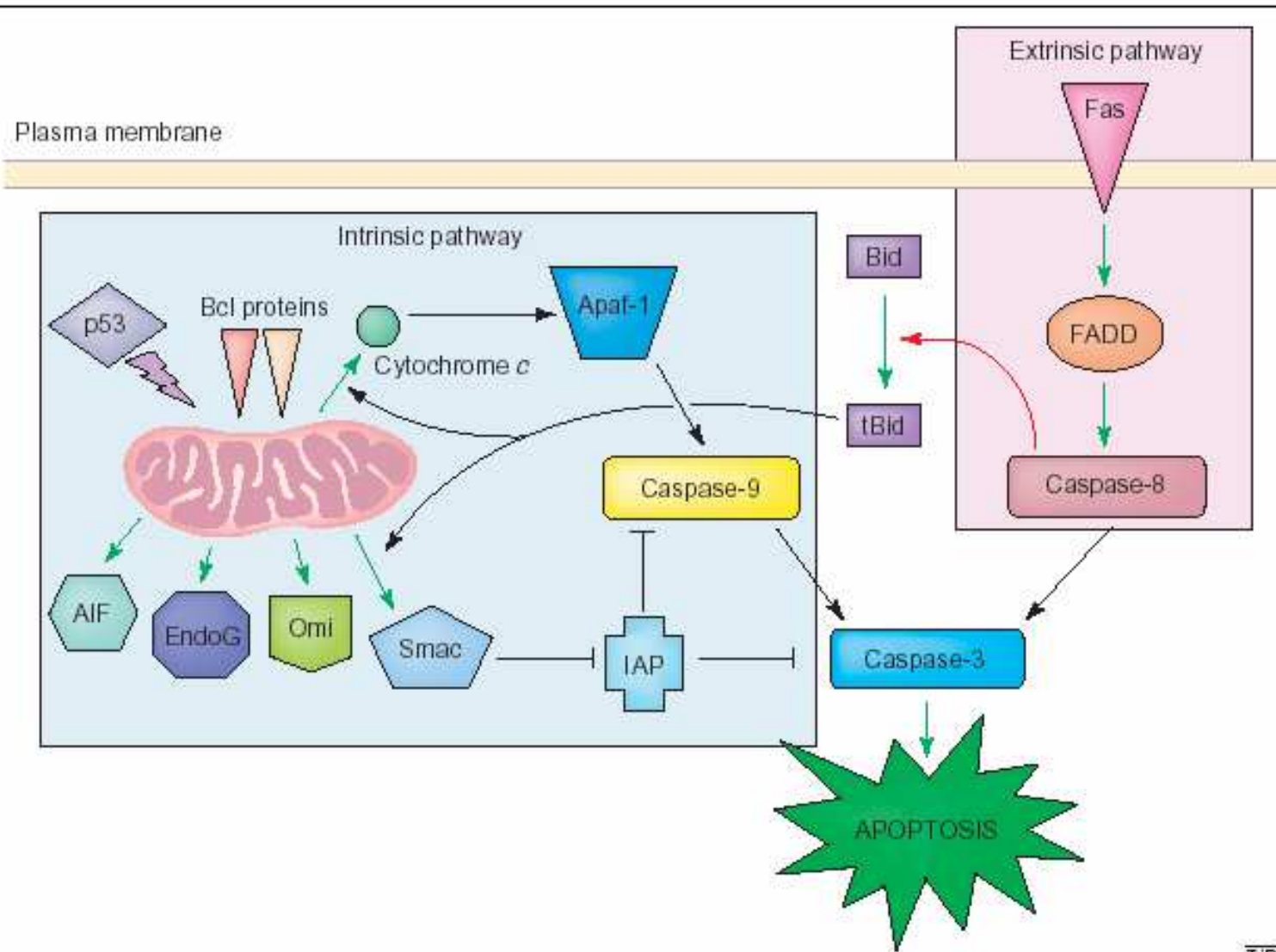

Figure 2 | **The intrinsic and extrinsic cell-death pathways.** In this simplified scheme, receptor-mediated apoptosis is initiated with the recruitment and activation of caspase-8. Caspase-8 can directly cleave caspase-3. The intrinsic pathway involves the translocation to mitochondria of pro-apoptotic Bcl-2 family members such as Bax, which results in the release of cytochrome c into the cytosol, oligomerization of Apaf-1 in a complex with caspase-9 (the apoptosome), and the subsequent activation of caspase-3. In some cases, receptor-initiated signals can be transduced through the mitochondrial pathway; for example, through the cleavage and activation of Bid. **FADD**, Fas-associated death domain protein; **UV**, ultraviolet light; **XIAP**, X-linked IAP.

# Smac/DIABLO



# Death receptors and adaptor proteins

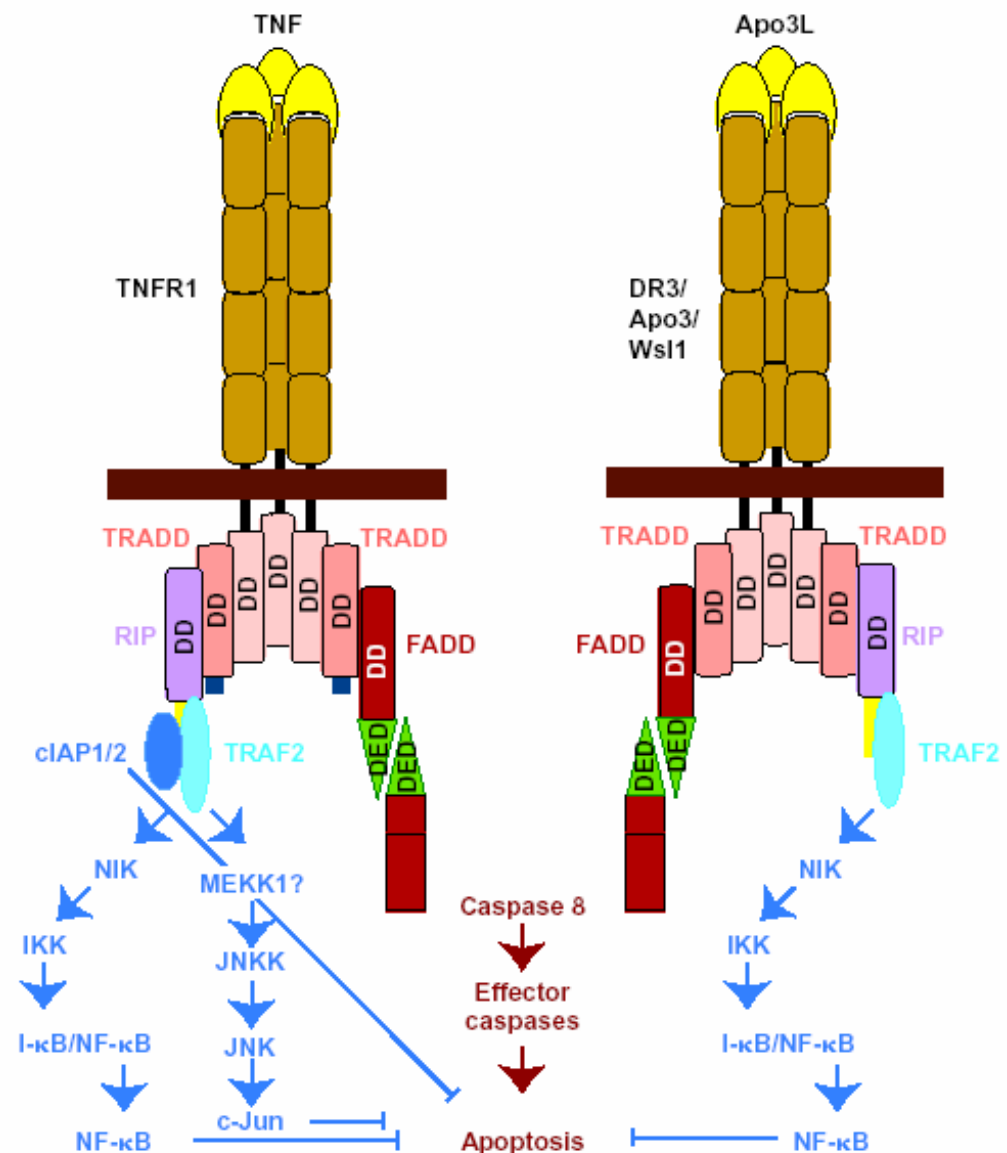
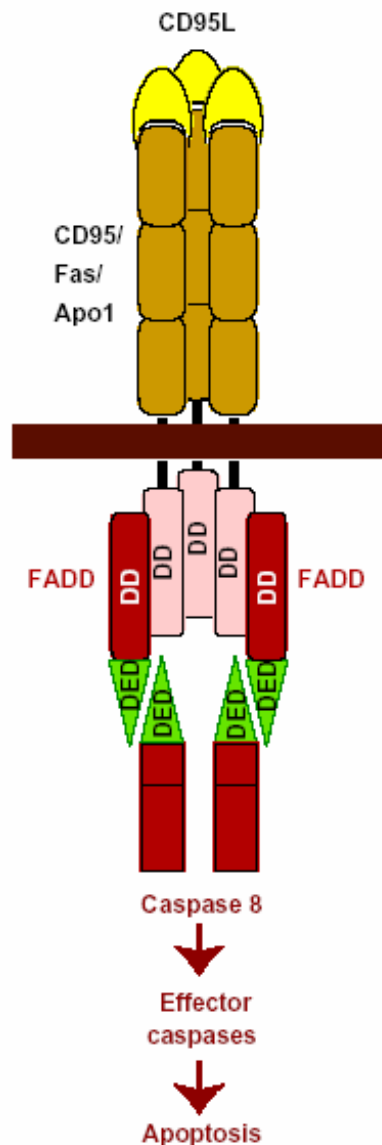

Fig. 1. Apoptosis signaling by CD95. DD, death domain; DED, death effector domain.

Fig. 2. Proapoptotic and antiapoptotic signaling by TNFR1 and DR3.

# FLIP

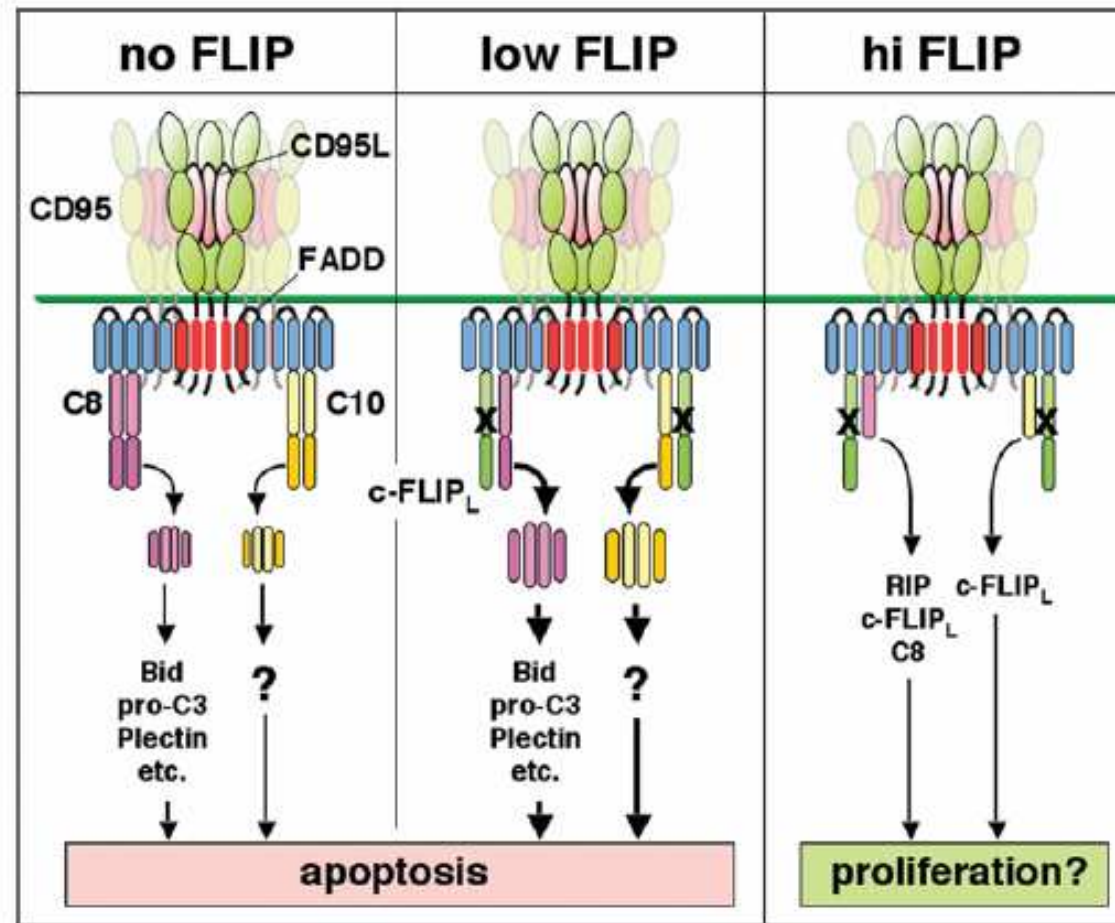
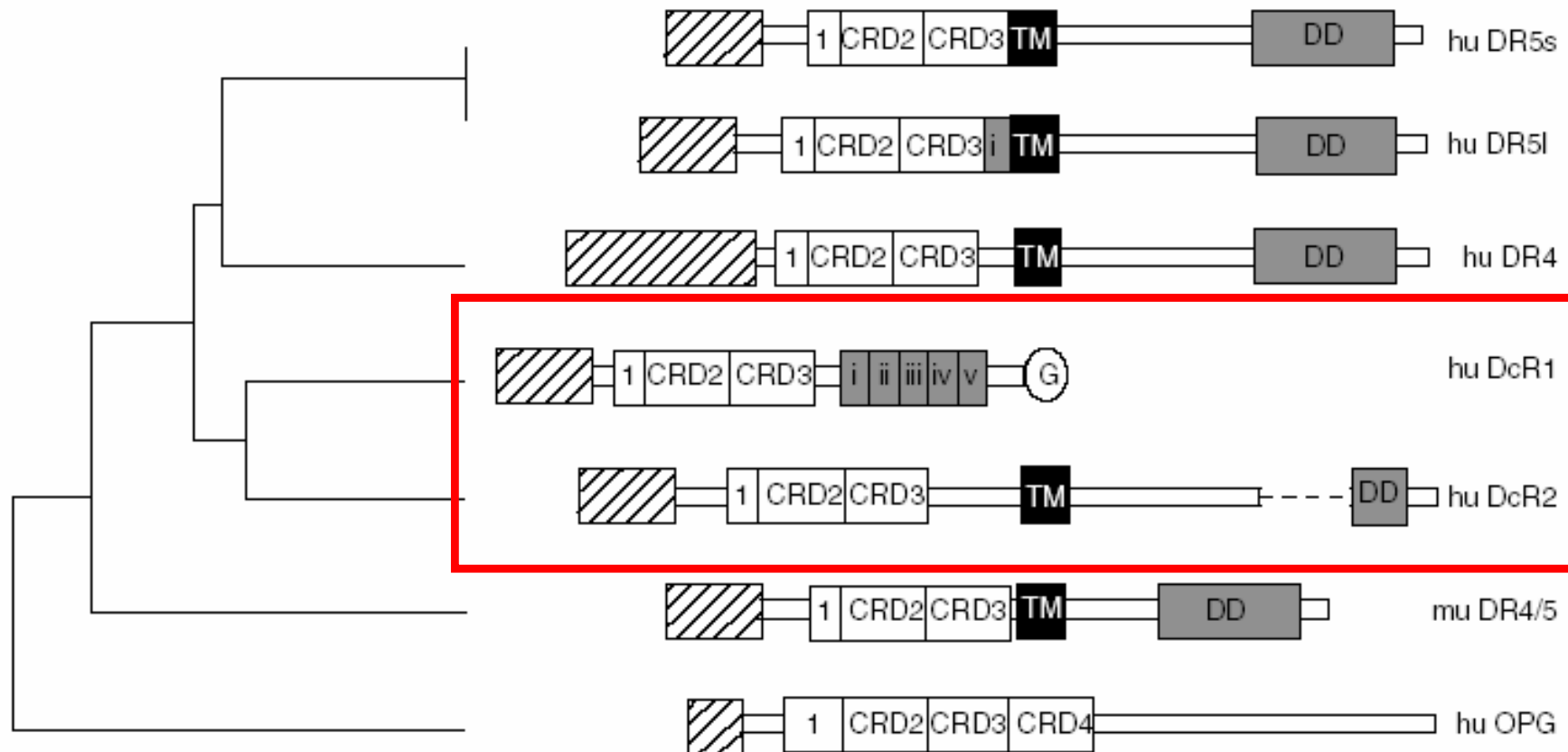

Figure 1 Model of the different functions of c-FLIP<sub>L</sub>

Shown is the CD95 DISC at different concentrations of c-FLIP<sub>L</sub>. In the absence of c-FLIP<sub>L</sub> (no FLIP), both procaspase-8 (C8) and procaspase-10 (C10) are recruited to the DISC through binding to the adaptor molecule FADD. This recruitment causes processing and activation of the initiator caspases through homodimerization, release of the active enzymes (heterotetrameric structures), subsequent cleavage of various intracellular caspase substrates and apoptosis. When c-FLIP<sub>L</sub> is expressed at low levels (low FLIP), activation of caspase-8/-10 is accelerated due to the ability of c-FLIP<sub>L</sub> to associate with caspase-8/-10 and its activity to form heterodimers more efficiently than caspases-8/-10 to form homodimers. At high concentrations of c-FLIP<sub>L</sub>, caspase-8/-10 are still activated, but are not released any longer from the DISC. According to the model, DISC-tethered caspase-8/-10 has the same substrate specificity as active caspase subunits released into the cytosol. However, owing to their DISC-proximal location, these incompletely processed, but fully active, caspases cleave a different set of substrates such as themselves, RIP and c-FLIP<sub>L</sub>. These cleavage events may be important in regulating apoptosis-independent processes such as proliferation. The inactive active site in the caspase domain of c-FLIP<sub>L</sub> is labelled X.

# Decoy receptors





**Death receptor pathway**

**Mitochondrial pathway**

Chemotherapeutics  
DNA damaging agents  
irradiation  
growth-factor depletion

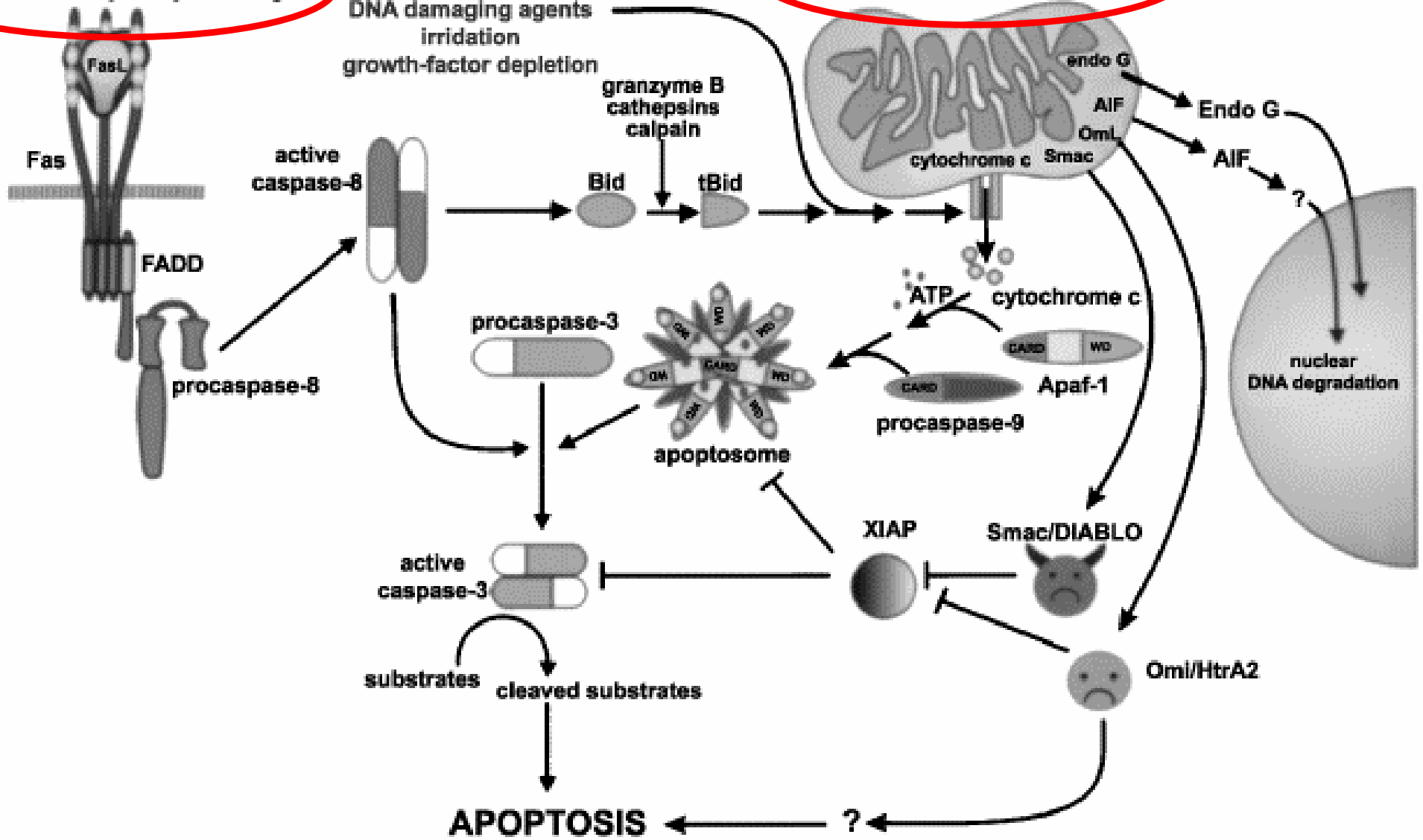



**Indukce apoptózy nebo přežití buňky je vždy důsledkem integrace mechanismů regulujících apoptózu, proliferaci a diferenciaci.**

**Rozhodující je působení vnějších signálů (ostatní buňky v populaci, buňky imunitního systému, ECM) a vnitřních kontrolních mechanismů buňky (kontrola integrity DNA, checkpointy apod.) nebo genetického programu v dané buň. populaci.**