

The saprotrophic food chain in terrestrial ecosystems

Outline / Osnova

- What is the saprotrophic food chain? Food chains, food webs, trophic pyramids, decomposition of dead organic matter and the decomposition subsystem (compartment) of (terrestrial) ecosystems.
Co je saprotrofní potravní řetězec? Potravní řetězce, potravní sítě, trofické pyramidy, rozklad odumřelé organické hmoty (dekompozice) a dekompoziční subsystém (kompartiment) ekosystémů (terestrických).
- Soil as the major component of the decomposition subsystem of terrestrial ecosystems (pedogenesis, major soil types, humus forms).
Půda jako hlavní součást dekompozičního subsystému suchozemských ekosystémů (pedogeneze, hlavní půdní typy, humusové formy).
- The effect of source (DOM) composition on decomposition processes.
Vliv složení zdroje (nekromasy) na procesy rozkladu.
- The effect of the abiotic (physical, chemical) factors on decomposition processes.
Vliv abiotických (fyzikálních, chemických) faktorů na procesy rozkladu.
- Soil communities of organisms (the edafon) – distribution in space and time, function, classification of soil fauna (size, trophic position).
Společenstva půdních organismů (edafon) – distribuce v prostoru a čase, funkce, členění půdní fauny (velikost, trofie).
- Major soil biological methods; traditional and modern research approaches.
Hlavní pedobiologické metody; tradiční i moderní zaměření výzkumu.
- Decomposition and saprotrophic food chains in the major biomes.
Dekompozice a saprotrofní potravní řetězce v hlavních biomech.
- Degradative succession. Degradative successions.
Degradační sukcese.
- Decomposition of dead wood. Rozklad odumřelého dřeva.
- Decomposing wood as a habitat of saproxylic communities of various successional stages.
Tlející dřevo jako životní prostředí saproxylických společenstev různých sukcesních stádií.
- Decomposition of faeces. Rozklad výkalů.
- Decomposition of carrion and carrion feeders / scavengers. Rozklad mršin a mrchožrouti.
- Decomposition in the paunch of ruminants. Rozklad v bachoru přežvýkavců.

Energy flow through a phytophage (herbivore) food chain



Abb. 1.5: Energiefluß in der Phytophagennahrungskette. Angaben in $\text{kJ} \cdot \text{m}^{-2} \cdot \text{d}^{-1}$. – Es bedeuten PwS = Photosynthetisch wirksame Strahlung (PhAR = photosynthetic active radiation) 400–700 nm; P = Produzenten (Primärproduzenten); K1 = Konsumenten 1. Ordnung; K2 = Konsumenten 2. Ordnung; K3 = Konsumenten 3. Ordnung.

Energy flow through a phytophage (herbivore) food chain

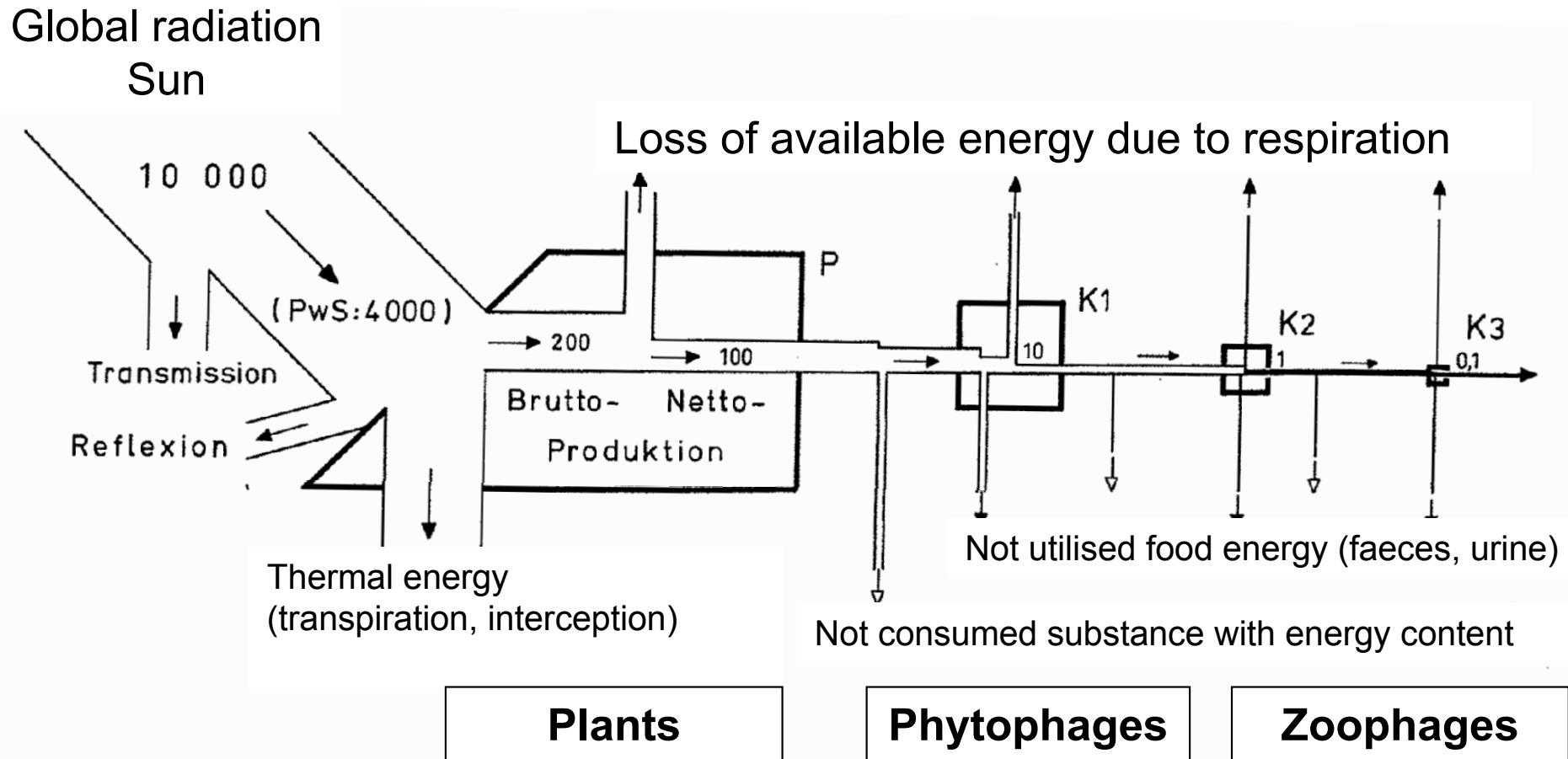

Abb. 1.5: Energiefluß in der Phytophagennahrungskette. Angaben in $\text{kJ} \cdot \text{m}^{-2} \cdot \text{d}^{-1}$. – Es bedeuten PwS = Photosynthetisch wirksame Strahlung (PhAR = photosynthetic active radiation) 400–700 nm; P = Produzenten (Primärproduzenten); K1 = Konsumenten 1. Ordnung; K2 = Konsumenten 2. Ordnung; K3 = Konsumenten 3. Ordnung.

The food web of an ecosystem

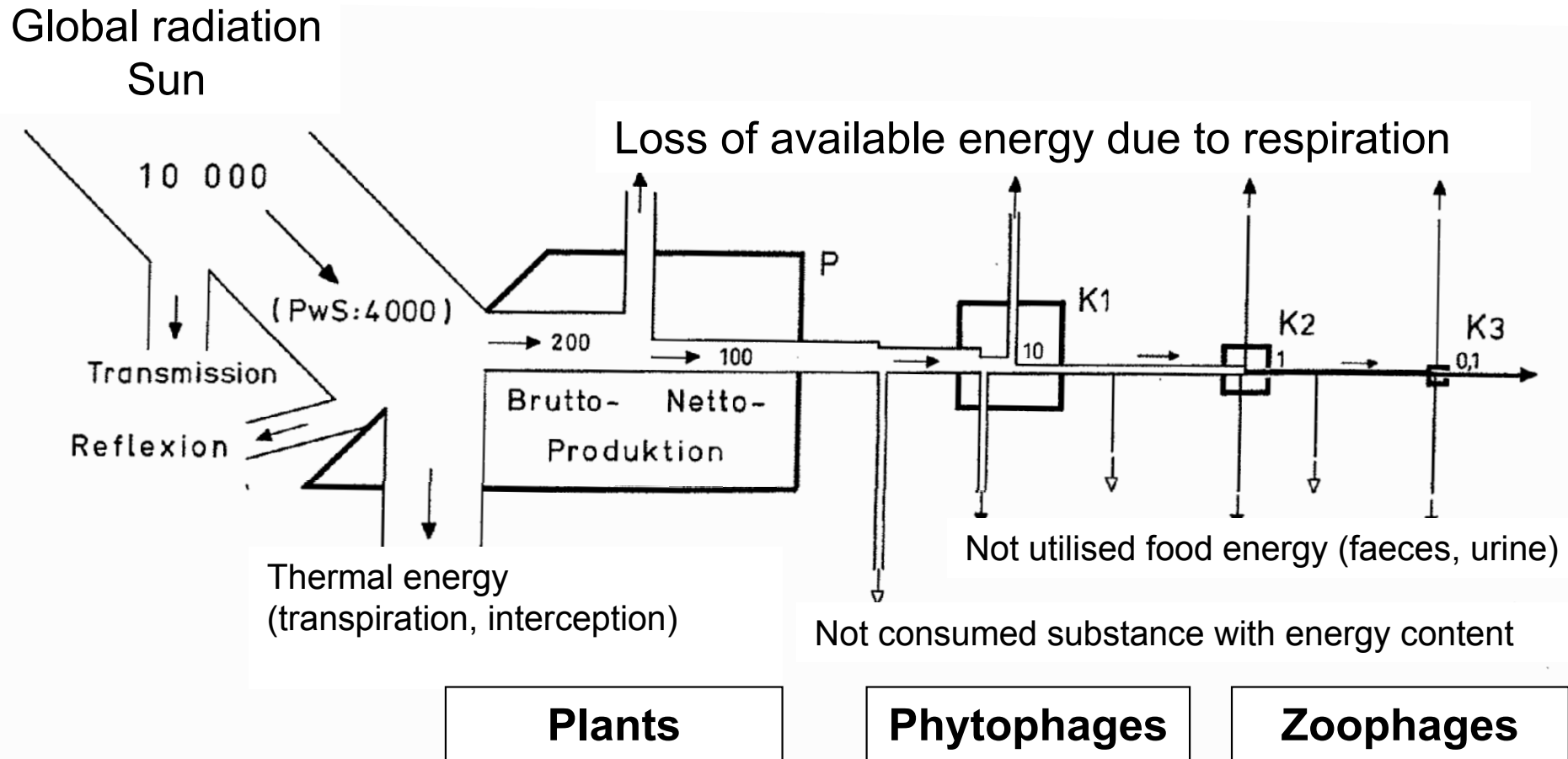

Abb. 1.9: Ausschnitt aus dem Nahrungskettengeflecht eines Ökosystems. Die Phytophagennahrungskette verläuft von den phototrophen Produzenten über Phytophage (F steht für Frischmaterial verzehrende Tiere) zu Räubern 1. und höherer Ordnung. Phytophage (F) entspricht Konsumenten 1. Ordnung, Räuber (1) Konsumenten 2. Ordnung usw. Die Destruenten- und Saprophagennahrungsketten nehmen vom Bestandsabfall ihren Ausgang. Eine weitere Teilnahrungskette beginnt bei den chemoautotrophen Produzenten, die ihren Energiegewinn aus Reduktions-Oxidations-Reaktionen (Redox-Vorgang) an anorganischen Substraten ziehen. – Pfeile symbolisieren die Weitergabe energiereicher organischer Substanz.

The food web in soil

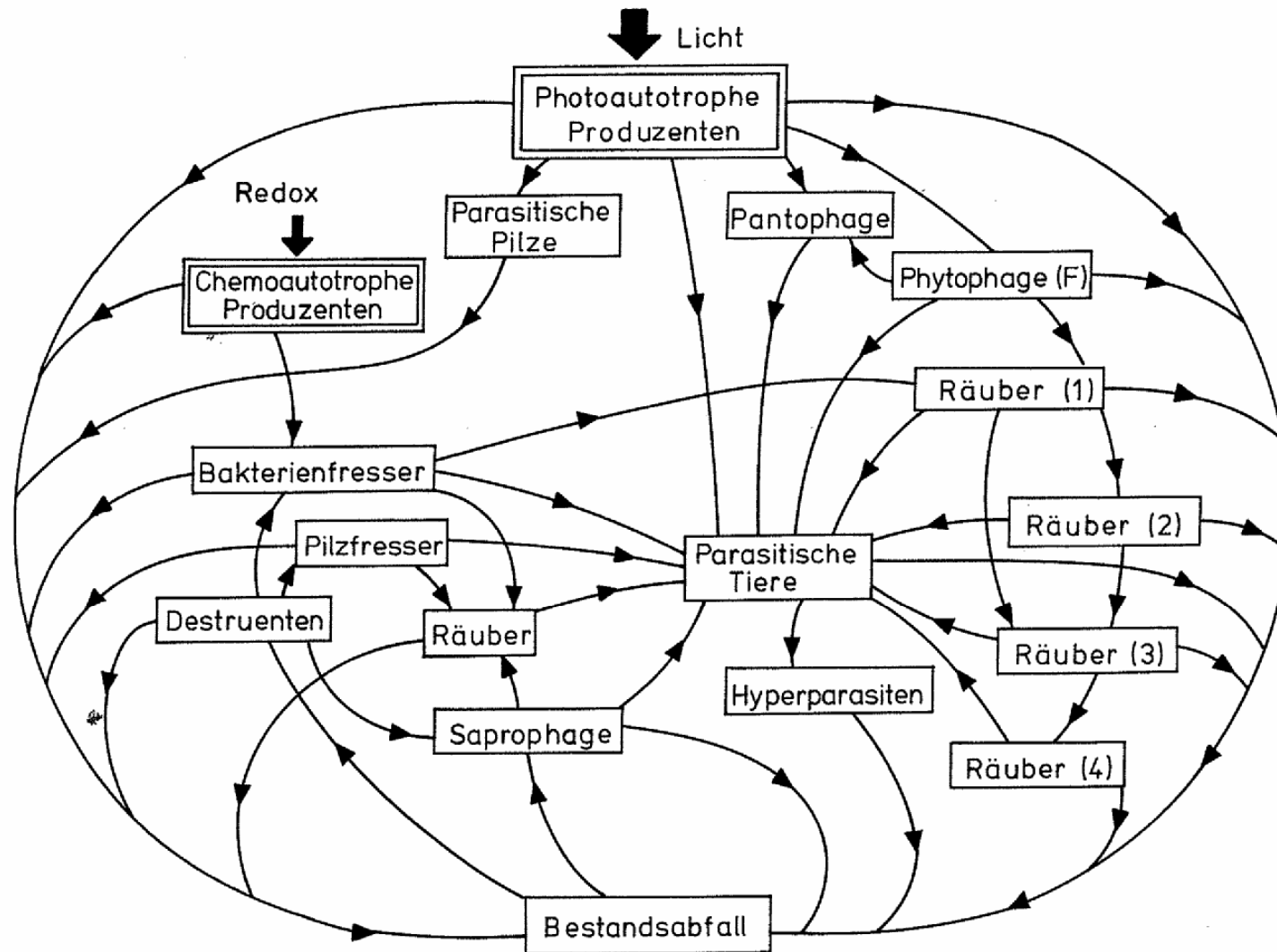
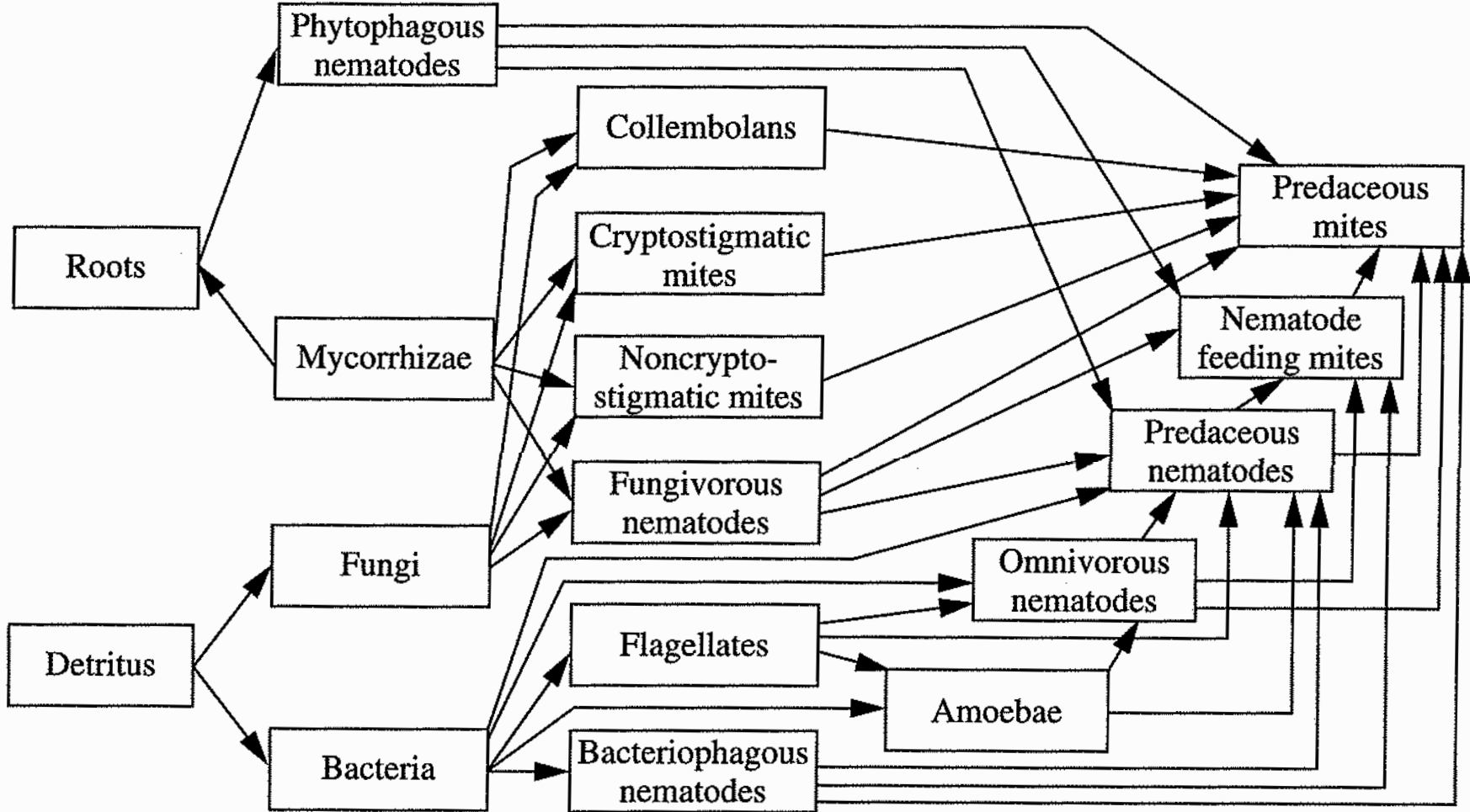
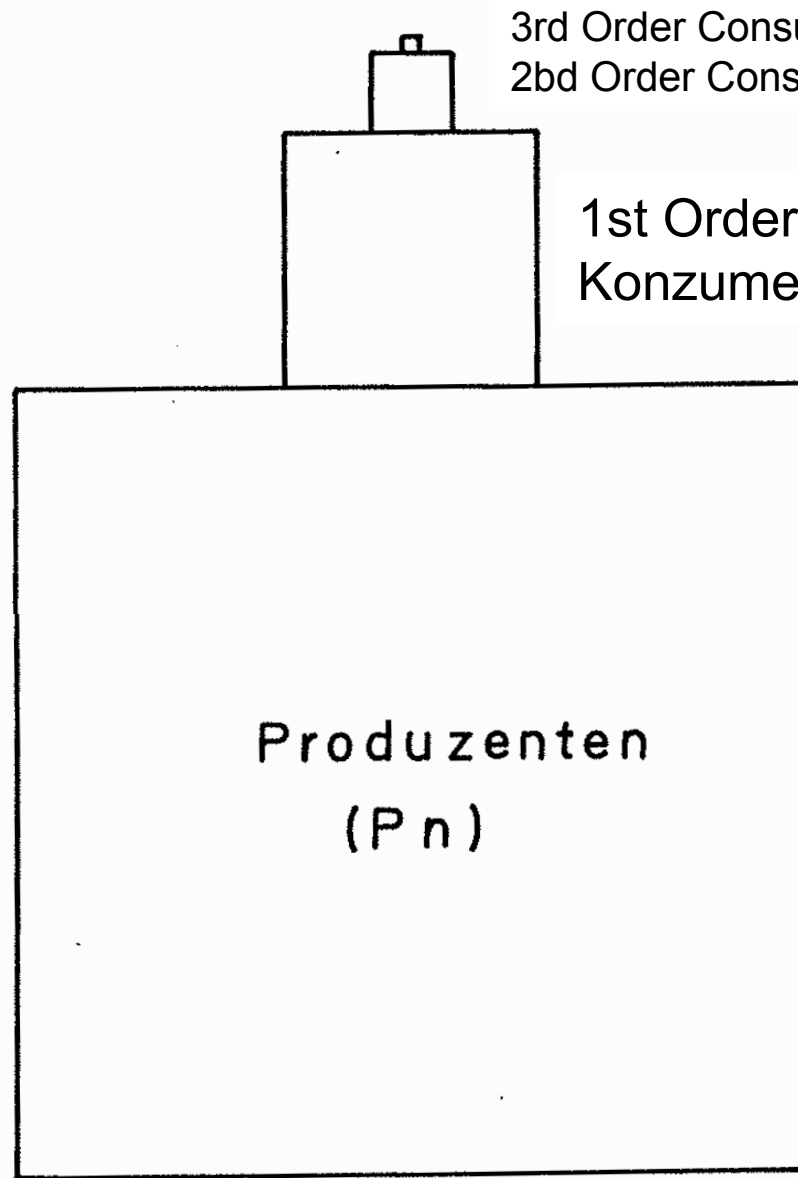

Fig. 2.2 Structure of the soil food web. (Adapted from de Ruiter et al. 1995)

Trophic Pyramid



Trophic (= food) pyramid (biomass)

3rd Order Consumers / Konsumenten 3. řádu
 2nd Order Consumers / Konsumenten 2. řádu
 1st Order Consumers
 Konsumenten 1. řádu

Trophische

Ebene

n+3

P_{n+3}

K3

n+2

P_{n+2}

K2

n+1

P_{n+1}

K1

n

P_n

PP



Abb. 1.10: Schematisierte Nahrungspyramide bestehend aus Primärproduzenten (PP) und Konsumenten 1.–3. Ordnung (K1–K3). Die Produktion ($P_n - P_{n+3}$) erfolgt auf den vier trophischen Ebenen n bis n + 3. Der ökotrophische Koeffizient gibt an, welchen Anteil (gerasterte Flächen, Konsum = C) der jeweils vorhergehenden trophischen Ebene eine Konsumentengruppe verzehrt («konsumiert»). Beispiel: ökotrophischer Koeffizient von K1 beträgt C_{n+1}/P_n .

Percentage consumed by next trophic level

Energy flow in food consumption and reproduction of an animal population

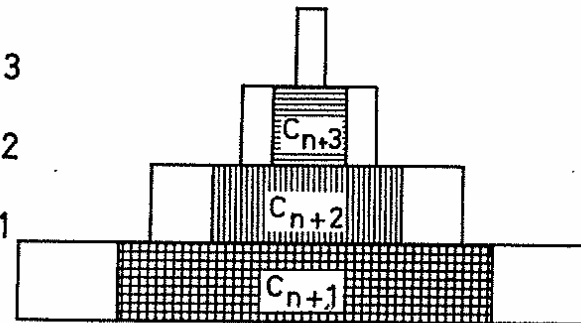

Abb. 1.7: Schema des Energieflusses bei Nahrungsverwertung und Produktion in einer Tierpopulation. (In Anlehnung an Petruszewicz u. Macfadyen 1970.) Erläuterungen im Text.

Differences and links between the herbivore and decomposition subsystem (food chains)

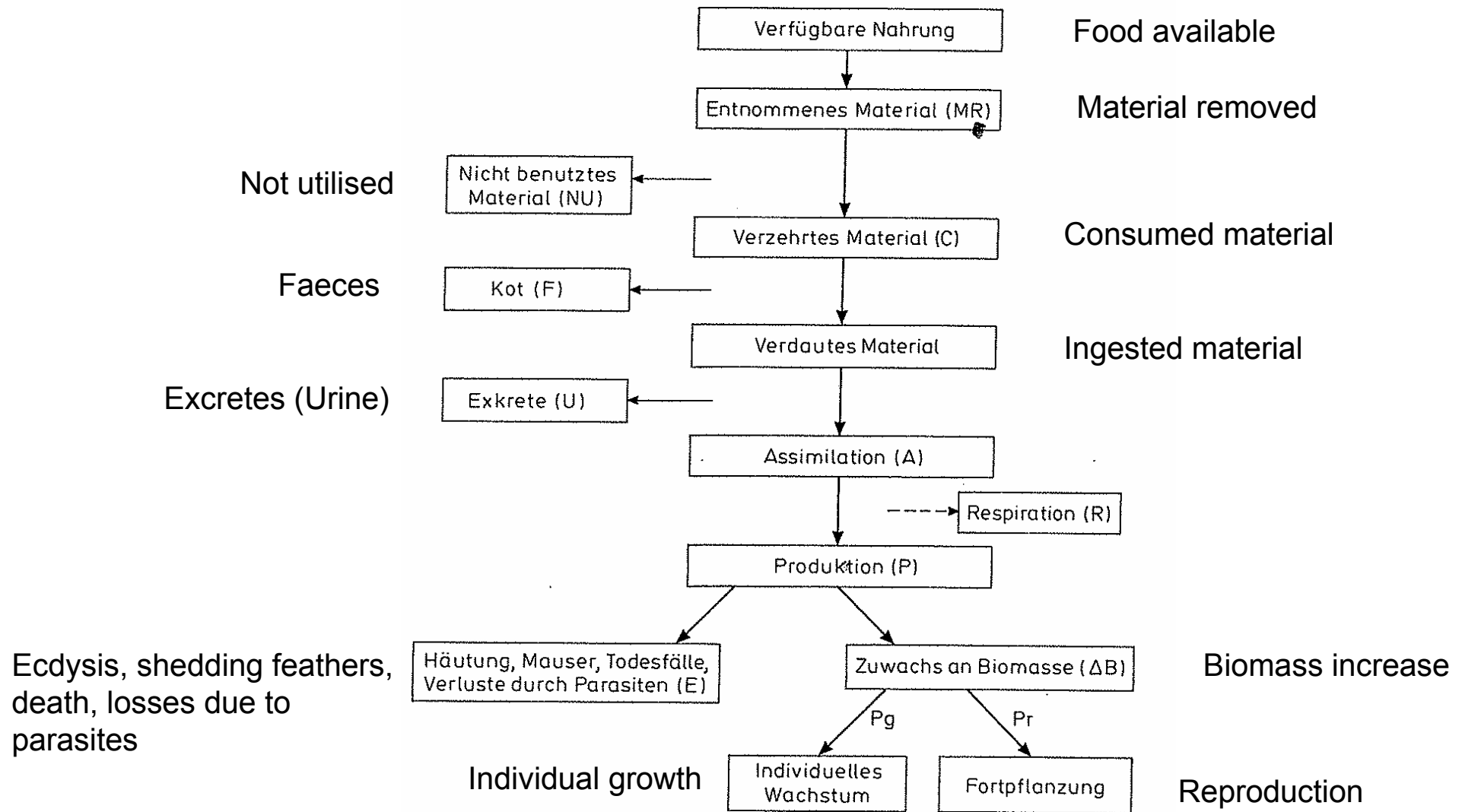
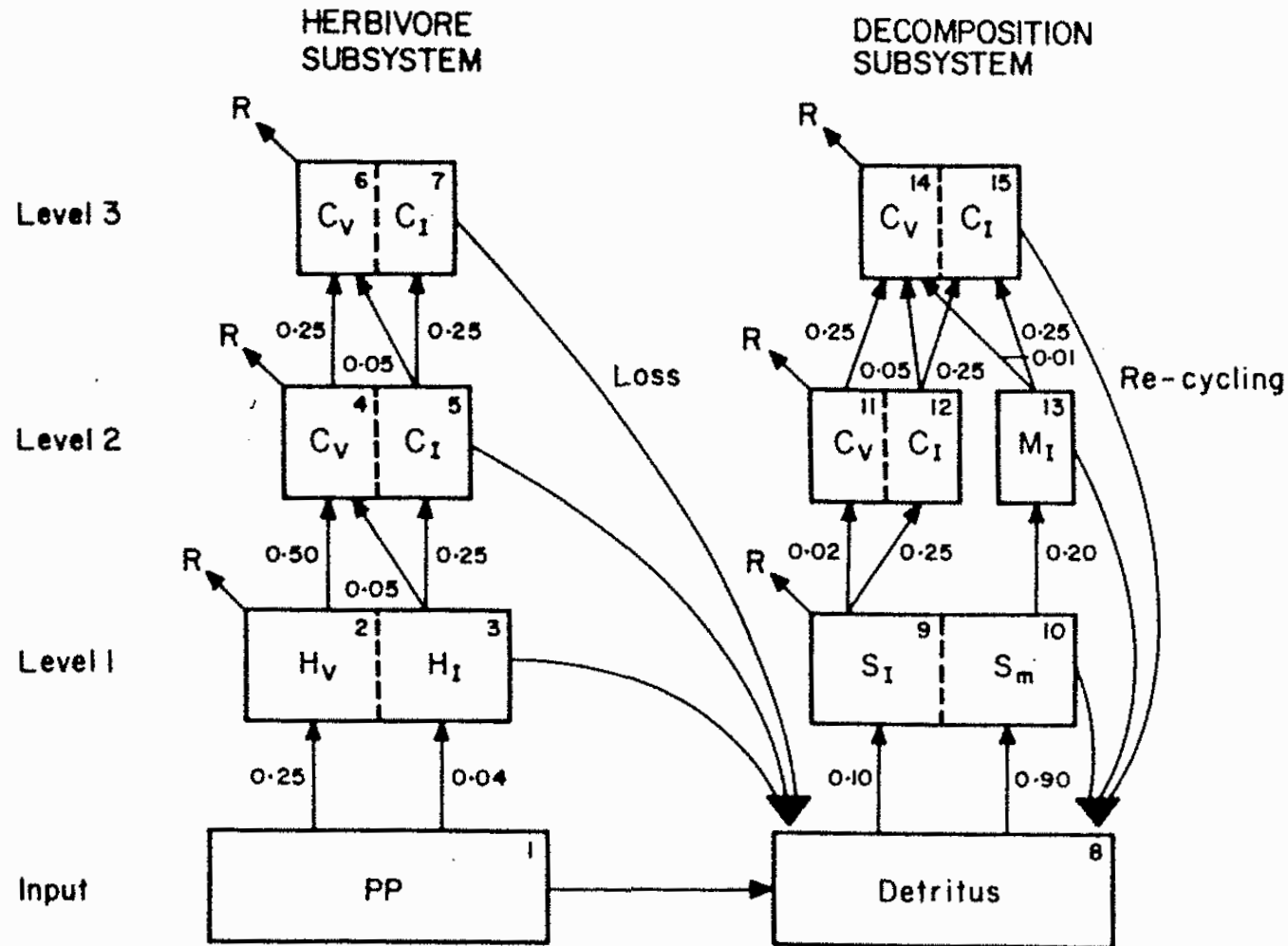

FIG. 1.4. A simple trophic model comparing the organisms of the herbivore and decomposition subsystems (after Heal & MacLean 1975). The symbols are those of the original paper: S = saprovores decomposers; M = microbivore; H = herbivore; C = carnivore; v = vertebrate; i = invertebrate; m = micro-organism; R = loss to respiration; PP = primary production. The transfers linking the compartments are the fractions transferred at any one linear run of the model.

Table 1.2. Calculated ingestion, production, respiration and egestion by heterotrophs ($\text{k cal m}^{-2} \text{ yr}^{-1}$) per 100 k cal m^{-2} net annual primary production in a grassland ecosystem. The efficiencies of consumption, assimilation and production shown in Fig. 1.4 were used in the calculation. Symbols as in Fig. 1.4 (modified from Heal & MacLean 1975).

	Ingestion	Production	Respiration	Egestion
Herbivore subsystem				
Herbivores				
Vertebrate (H_v)	25.000	0.250	12.250	12.500
Invertebrate (H_i)	4.000	0.640	0.960	2.400
Carnivores				
Vertebrate (C_v)	0.160	0.003	0.123	0.031
Invertebrate (C_i)	0.170	0.040	0.095	0.034
Decomposition subsystem				
Decomposers				
Invertebrate (S_i)	15.153	1.212	1.818	12.122
Microbial (S_m)	136.377	54.551	81.826	—
Microbivores				
Invertebrate (M_i)	10.910	1.309	1.964	7.637
Carnivores				
Vertebrate	0.041	0.001	0.032	0.008
Invertebrate	0.648	0.155	0.363	0.130
Total	192	58	99	35
% passing through				
Herbivore subsystem	15.2	1.6	13.5	42.9
Decomposition subsystem	84.8	98.4	86.5	57.1

The saprotrophic food chain in terrestrial ecosystems

Pozor na chybné definice / Beware of wrong definitions

Jakrlová, Pelikán (1999) – Ekologický slovník

Potravní řetězec dekompoziční: vede od odumřelé organické hmoty přes četné následné rozkladače (dekompozitory) až k mikroorganismům. Velikost se zmenšuje, početnost zvětšuje.

Decomposition food chain: leads from dead organic matter via numerous subsequent decomposers to microorganisms. The size decreases, the abundance increases.

Dekompoziční řetězec: přenos látek a energie v procesu dekompozice; rozklad odumřelých látek od počátečních (iniciálních) rozkladačů (dekompozitorů), přes návazné další články až ke konečným (finálním) dekompozitorům, uvolňujícím v konečné fázi dekompozice minerální látky. Dělbá práce (funkce) dekompozitorů, protože žádný druh organismu nemůže sám kompletně rozložit mrtvé tělo až na látky minarální.

Decomposition chain: transfer of matter and energy in the process of decomposition; decomposition of dead matter from initial decomposers via subsequent components towards the final decomposers, which release in the final phase of decomposition mineral substances. Division of labour (function) of decomposers as no single species of organism can completely decompose a dead body to mineral substances.

General model of ecosystem structure

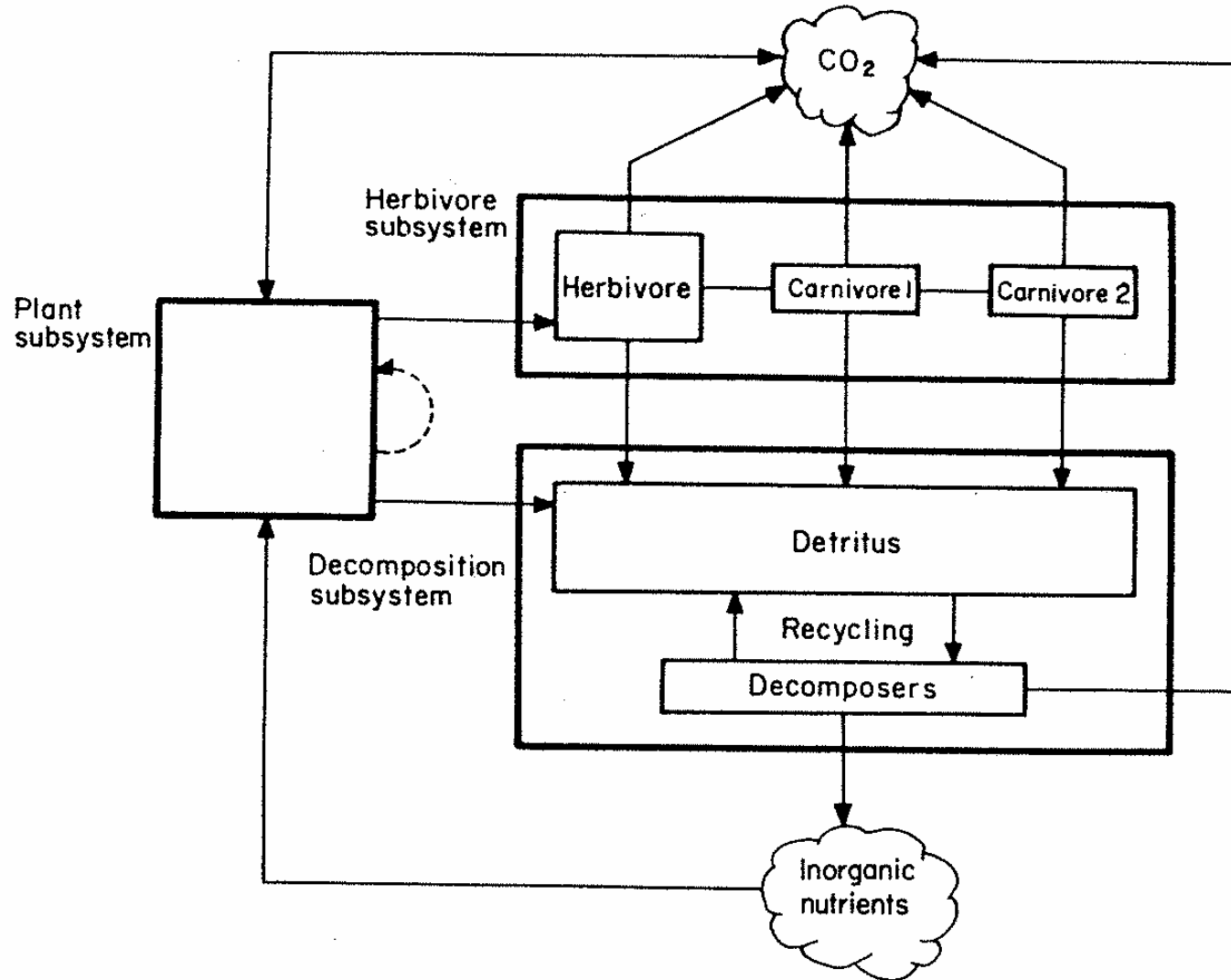

FIG. 1.3. A general model of ecosystem structure. The three subsystems are shown together with their main components. The major pathways of transfer of matter within the ecosystem are shown by the arrows. Organic matter pools are shown as rectangles, inorganic as 'clouds'. Note in particular the links between the herbivore and decomposition subsystems, the recycling of matter *within* the decomposition subsystem and the nett storage of matter that may occur within the plant subsystem (broken arrow).

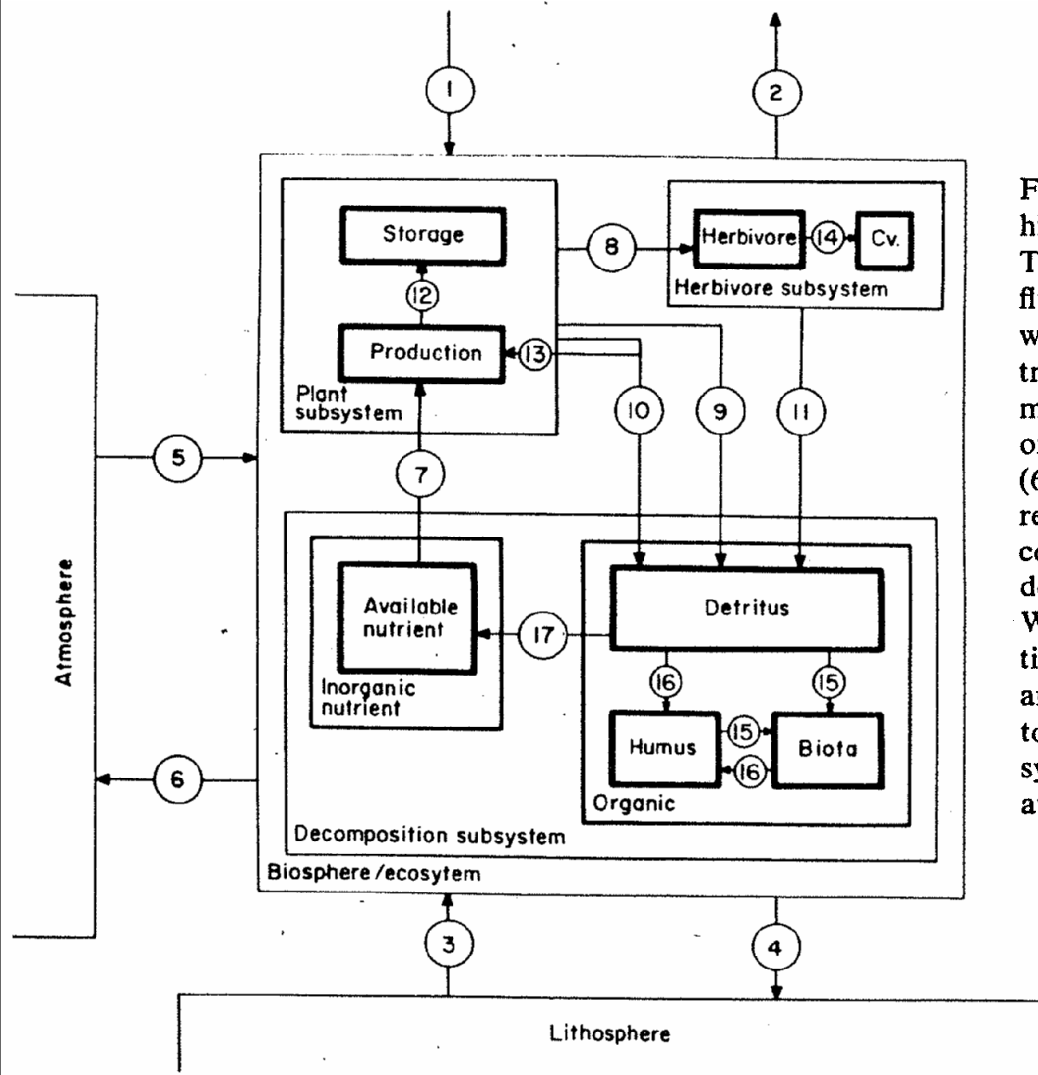

FIG. 1.10. Nutrient pools and fluxes within ecosystems. The model has a hierarchical structure of pools represented by the diminishing sizes of the boxes. The ecosystem is connected to other ecosystems by input (1) and output (2) fluxes which may be of material of either mineral or biological origin. Exchanges with the lithosphere and atmosphere are also pictured as extra-ecosystem transfers as explained in the text. These consist of the formation of secondary minerals (3) and their loss (4); the fixation of C and N by the plants or micro-organisms (5) and volatilisation of elements (e.g. as CO_2 , CH_4 , H_2S or N_2) (6). Within the ecosystem the three main subsystems are connected by fluxes representing uptake of nutrients by plants (7), losses from them by herbivore consumption (8), leaching (9) and litter production (10). The transfer to the decomposition subsystem from the herbivore subsystems is also shown (11). Within the plant subsystem the main fluxes shown are of storage in perennial tissues (12) and withdrawal from senescent leaves (13). Predation transfers (14) are shown in the herbivore subsystem. Immobilisation transfers from detritus to decomposers (15) or humus (16) are shown within the decomposition subsystem. Mineralisation (17) replenishes the inorganic pool and the pool of available nutrient in particular. Further details in the text.

Ecosystem with energy flow (full lines) and selected flows or cycles of matter



Abb. 1.12: Schematische Darstellung eines Ökosystems mit Energiefluß (durchgezogene Linien) und ausgewählten Stoffflüssen bzw. Stoffkreisläufen. R = Respiration (Atmung) bedeutet Verlust an verfügbarer Energie für das Ökosystem. Export und Import von organisch gebundener Energie kann auf allen Konsumentenebenen erfolgen (Aus- und Zuwanderung von Organismen).

Energy transfer in an ecosystem

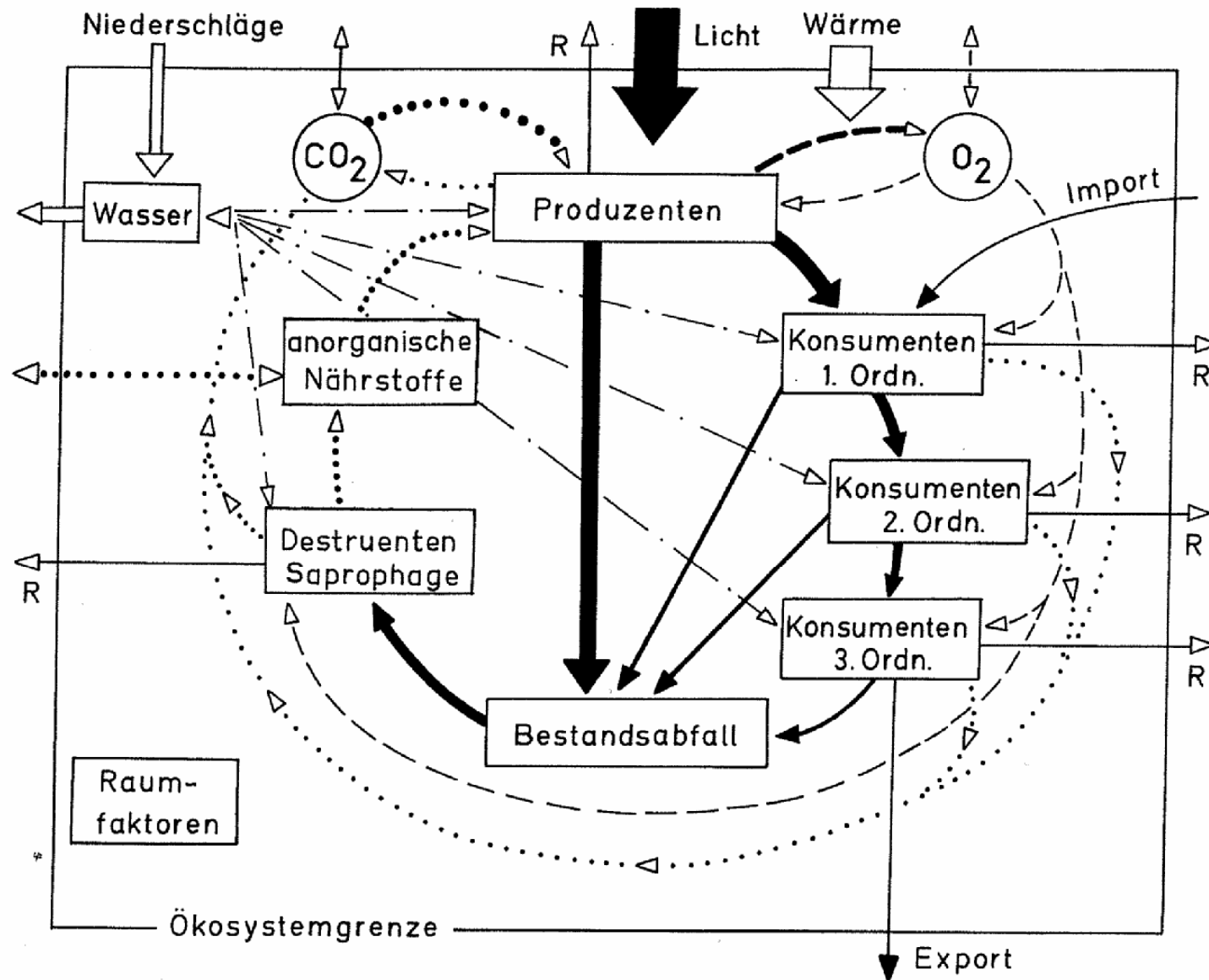

Abb. 1.8: Schema des Energietransfers in einem Ökosystem. Darstellung nicht maßstabsgerecht. Es bedeuten: Pb = Bruttoproduktion; Pn = Nettoproduktion; Bio = Biomasse; K1, K2, K3 = Konsumenten 1., 2., 3. Ordnung; B = Bestandsabfall; D = Destruentennahrungskette; S = Saprophagennahrungskette; R = Respiration.

V = Vertebraten
 I = Invertebraten
 S = Saprophagen
 M = Mikroorganismen
 Mf = Mikroorganismenfresser
 D = Destruenten

Phytophagen-

Destruenten-Saprophagen-

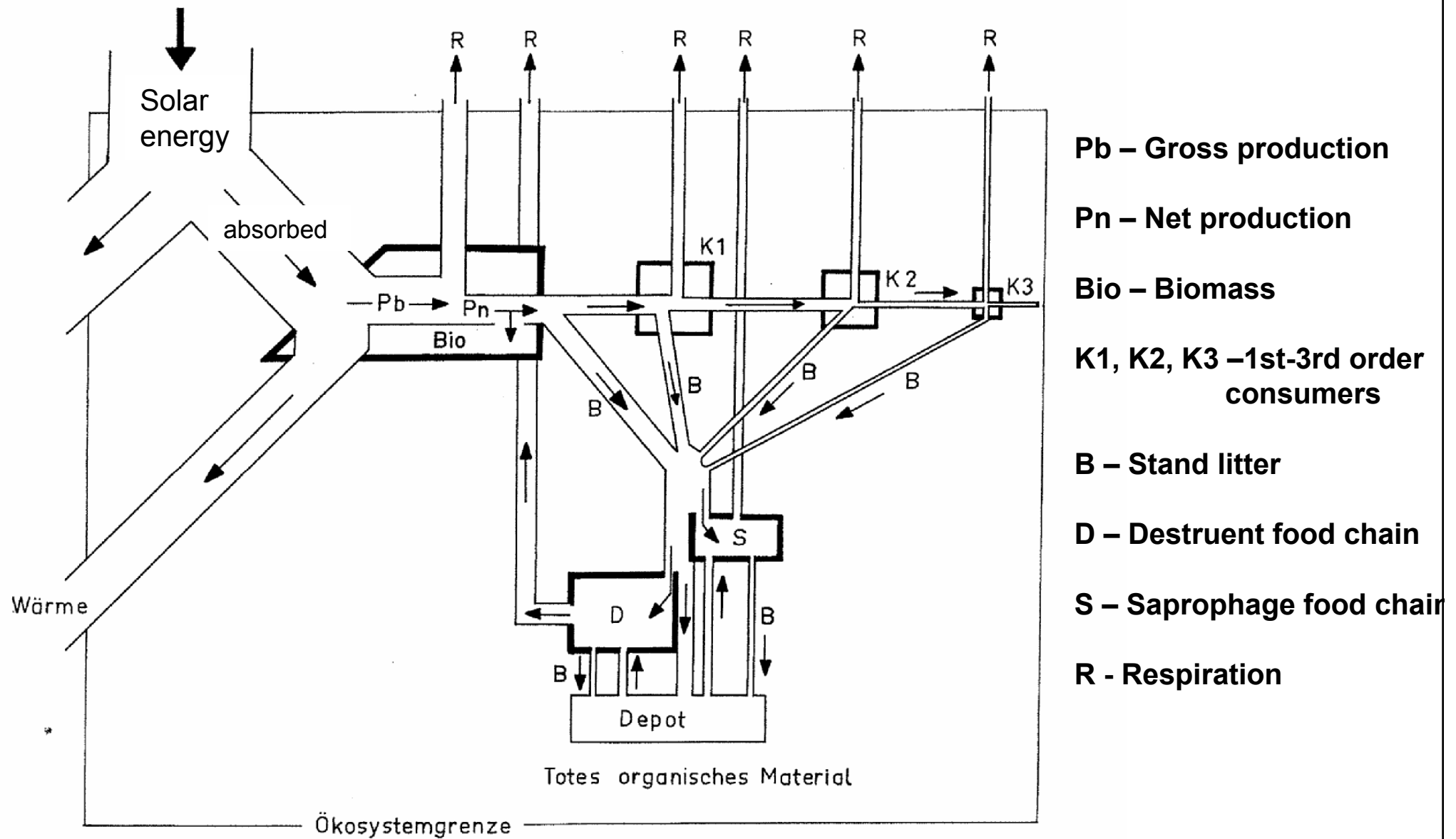
Nahrungskette

Konsumenten 3.

Konsumenten 2.

Konsumenten 1.



Abb. 1.11: Schematisierte Darstellung der trophischen Struktur eines Graslandökosystems mit zwei Nahrungskettensystemen. Die Zahlen geben den jeweiligen ökotrophischen Koeffizienten an, der aus der allgemeinen Formel C_{n+1}/P_n ermittelt wurde (vgl. Abb. 1.10). R = Respiration. (Nach Heal u. MacLean 1975, verändert).



Hypothetical mechanisms by which changes in plant species richness may affect decomposer-mediated processes. +, 0, and - indicate positive, neutral, and negative effects respectively. (Redrawn with permission from Oxford University Press; Wardle and Van der Putten 2002.)

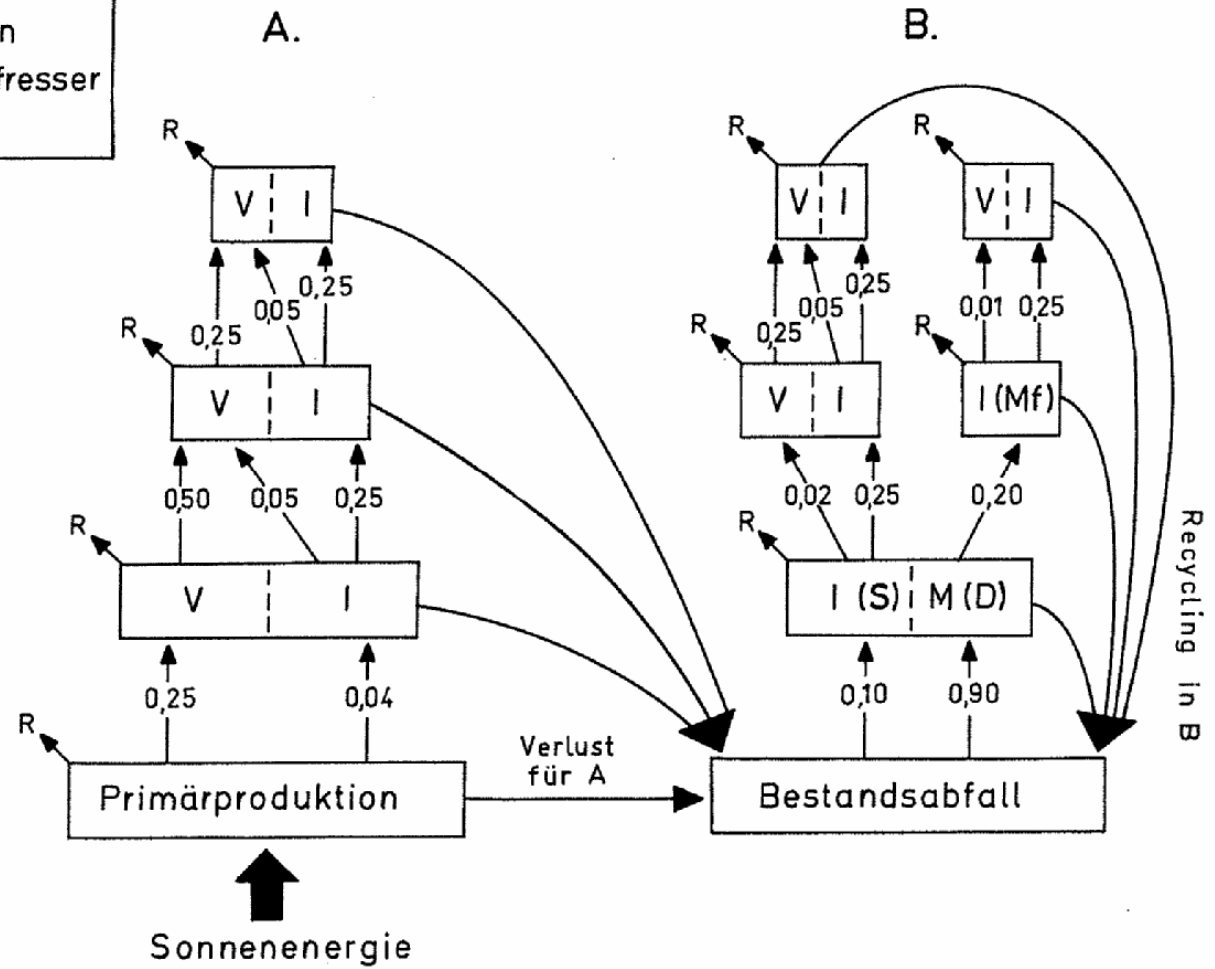
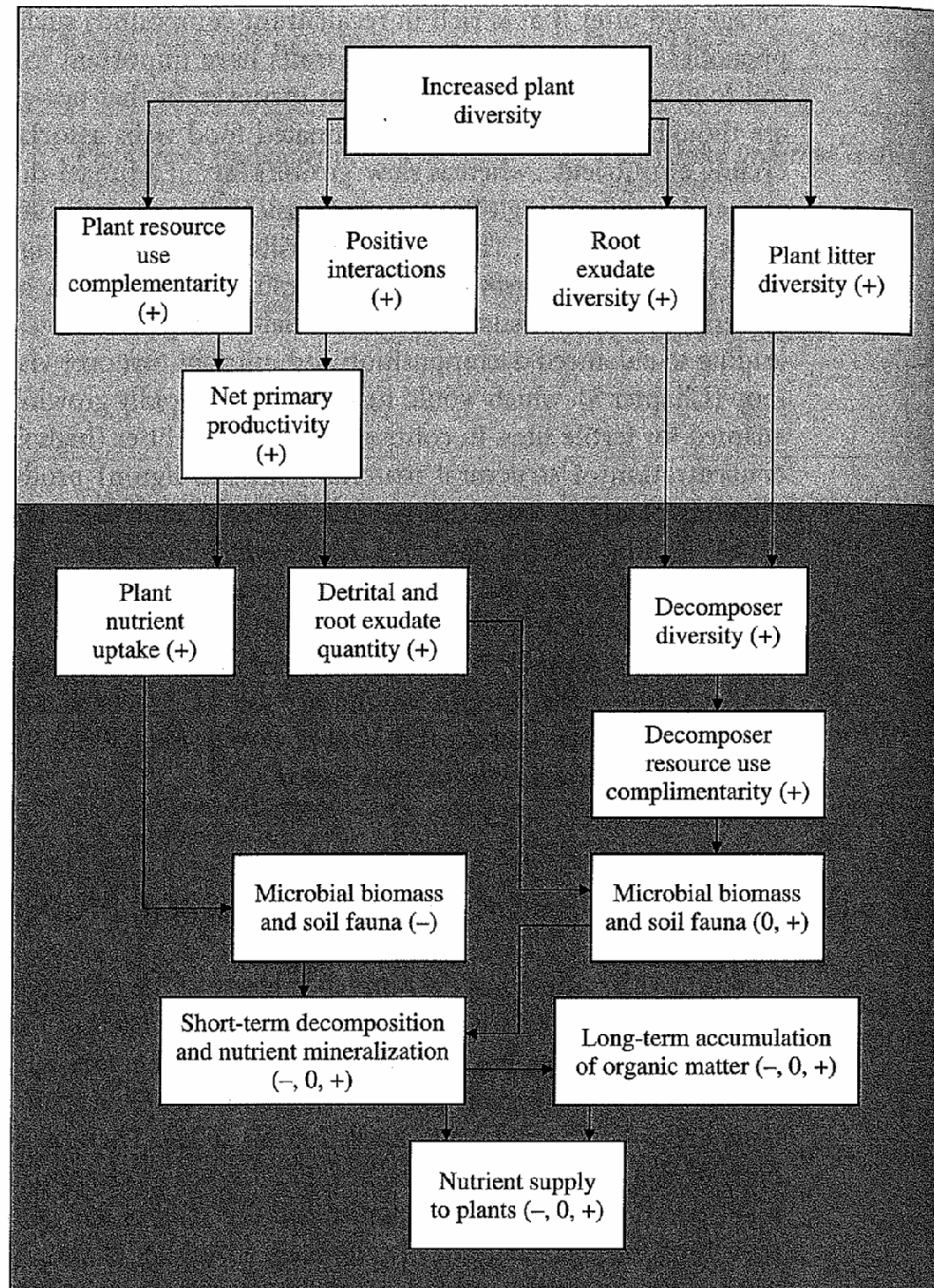
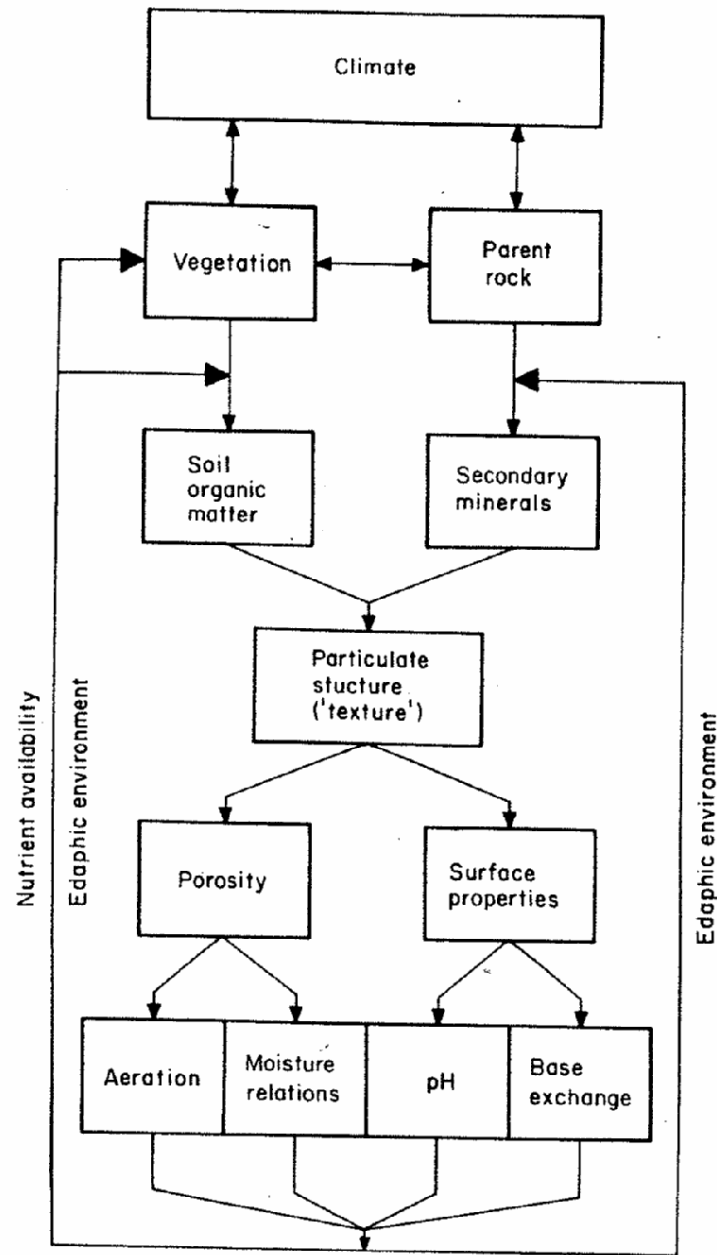

FIG. 1.7. Some processes of soil development. The primary effects of climate, parent materials and the vegetation which develops are shown to determine a number of soil characteristics (notably the nature of the particulate matrix). These properties have 'feed-back' effects on various aspects of soil formation, particularly in their effects on the formation of soil organic matter as is shown by the feed-back loops. This emphasises the integrated rather than linear mode of soil and community development.

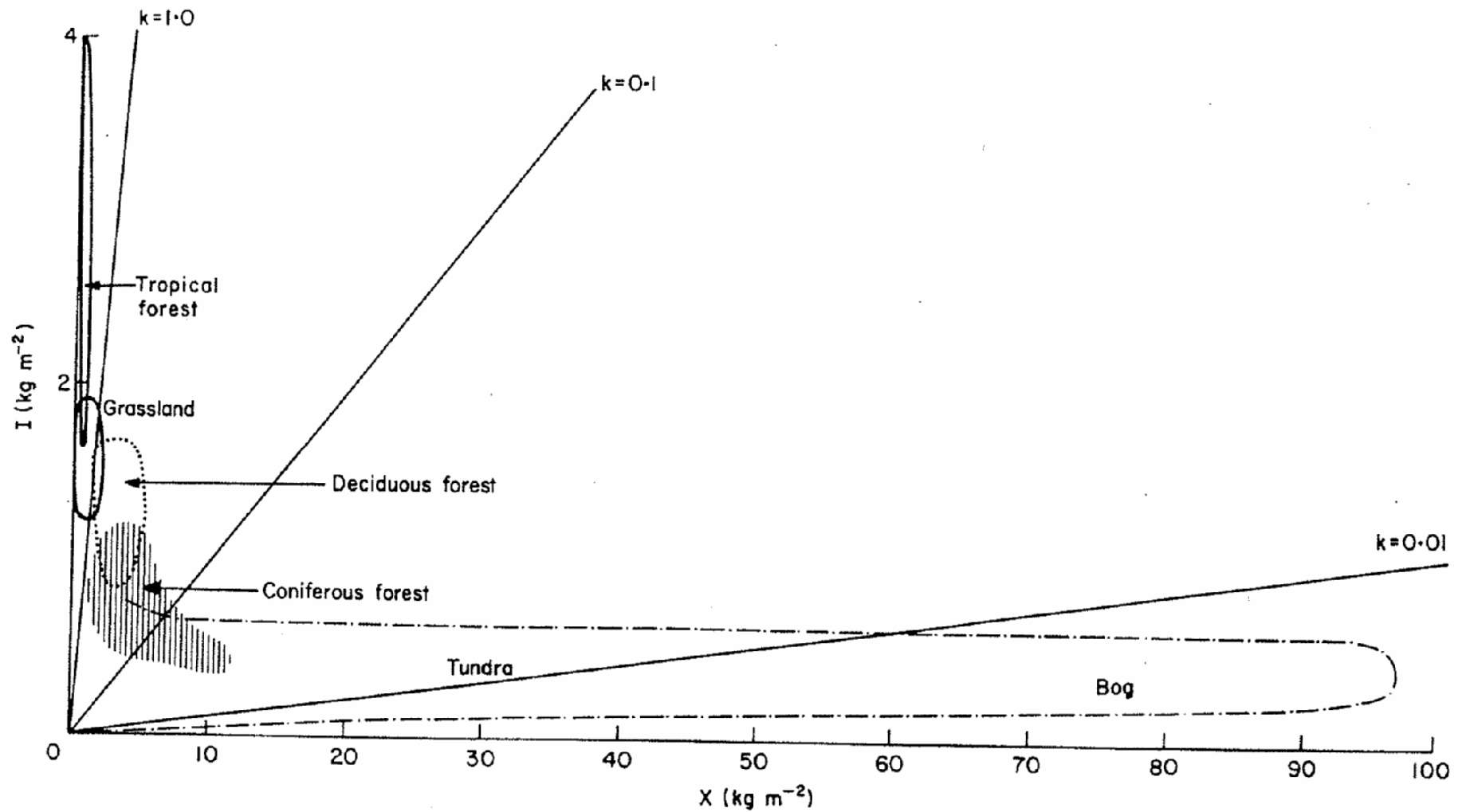

FIG. 1.6. Input (I) and accumulation (X) of organic matter in a number of biomes. Inputs are best estimates of total input from primary production in $\text{kg m}^{-2} \text{yr}^{-1}$ and accumulation is the total amount of organic matter in the soil (from Heal, Flanagan, French & MacLean in press).

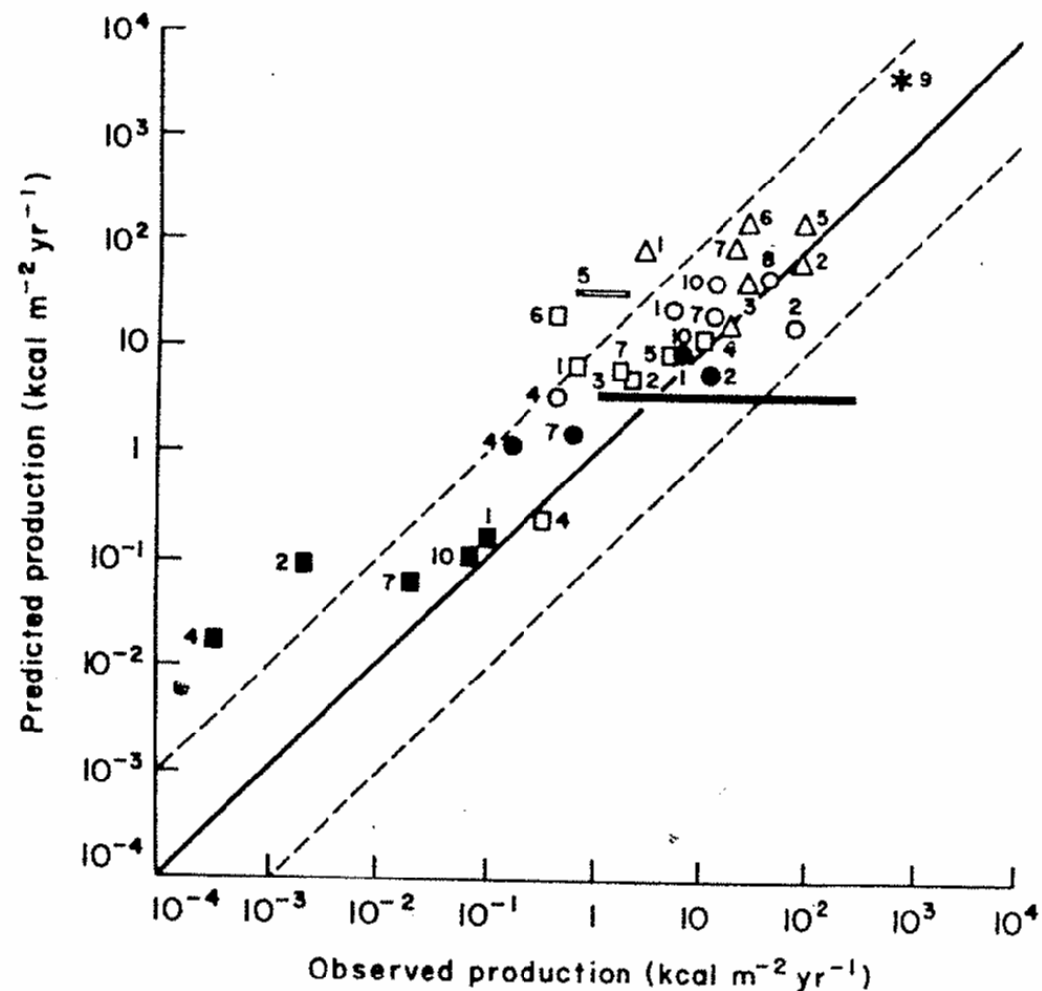

FIG. 1.5. Relationship between predicted and observed heterotroph production. The known NPP from ten sites were entered as inputs to the Heal and MacLean Model (Fig. 1.4) to predict the secondary production for various groups of heterotrophs: (○) invertebrate herbivores; (●) vertebrate herbivores; (■) vertebrate carnivores; (□) invertebrate carnivores; (△) invertebrate saprovores and microbivores; (*) microbial saprovores. The predicted values are shown plotted against those actually measured at the sites which range from Tundra (3 and 4), Cold Temperate Moorland (2 and 7), Temperate Grassland (1) to Temperate Deciduous Forests (5, 6, 8, 9 and 10) (see Heal & MacLean 1975, for further details).