

Continental characteristics

- 30–70 km thick
- Granitic-andesitic composition
- 1/3 of Earth surface
- Complex structures
- Up to 4.0 Ga old

Three basic structural components of continents

- Shields
- Stable platforms
- Folded mountain belts

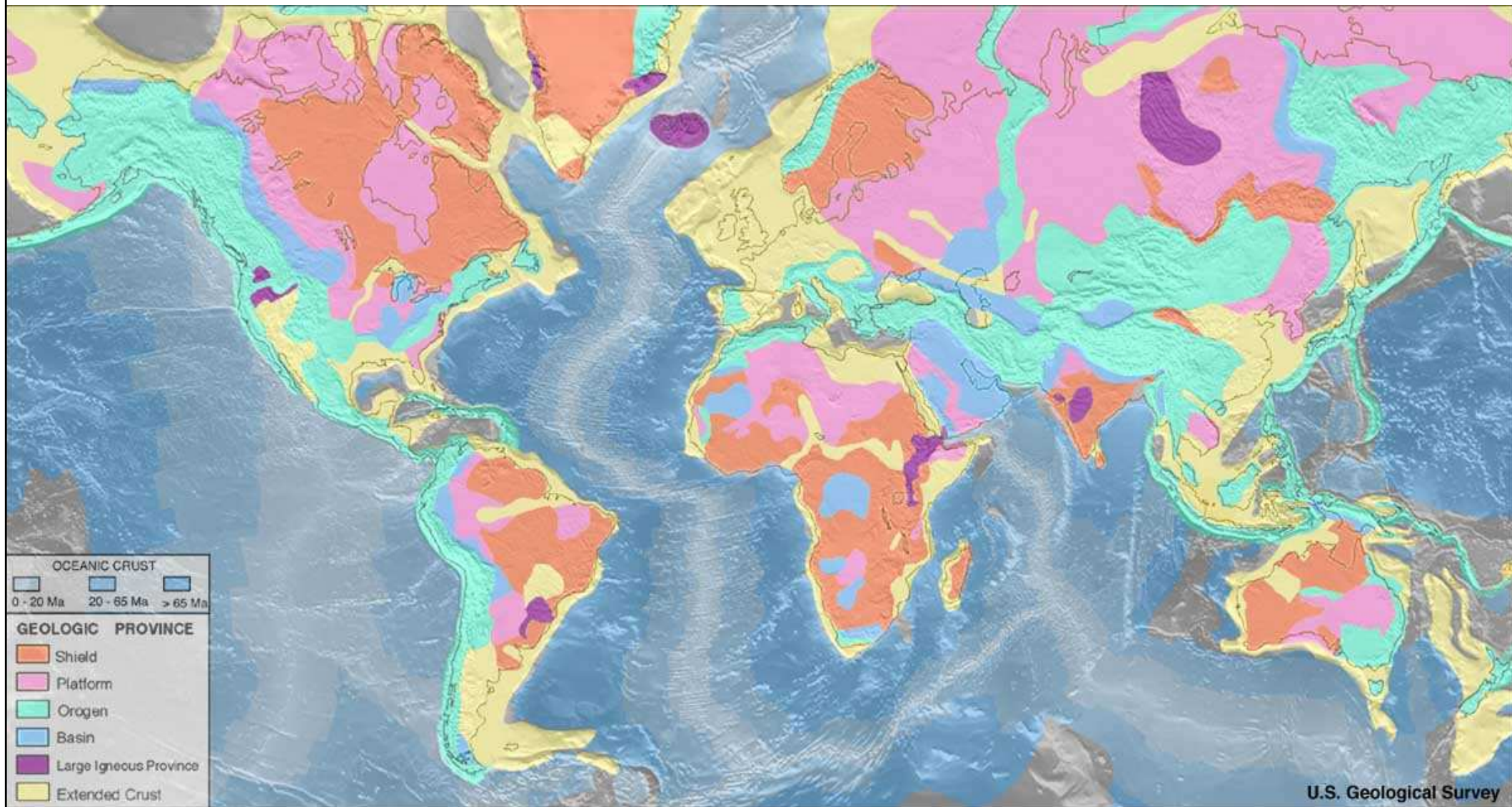

Age of the Continental Crust

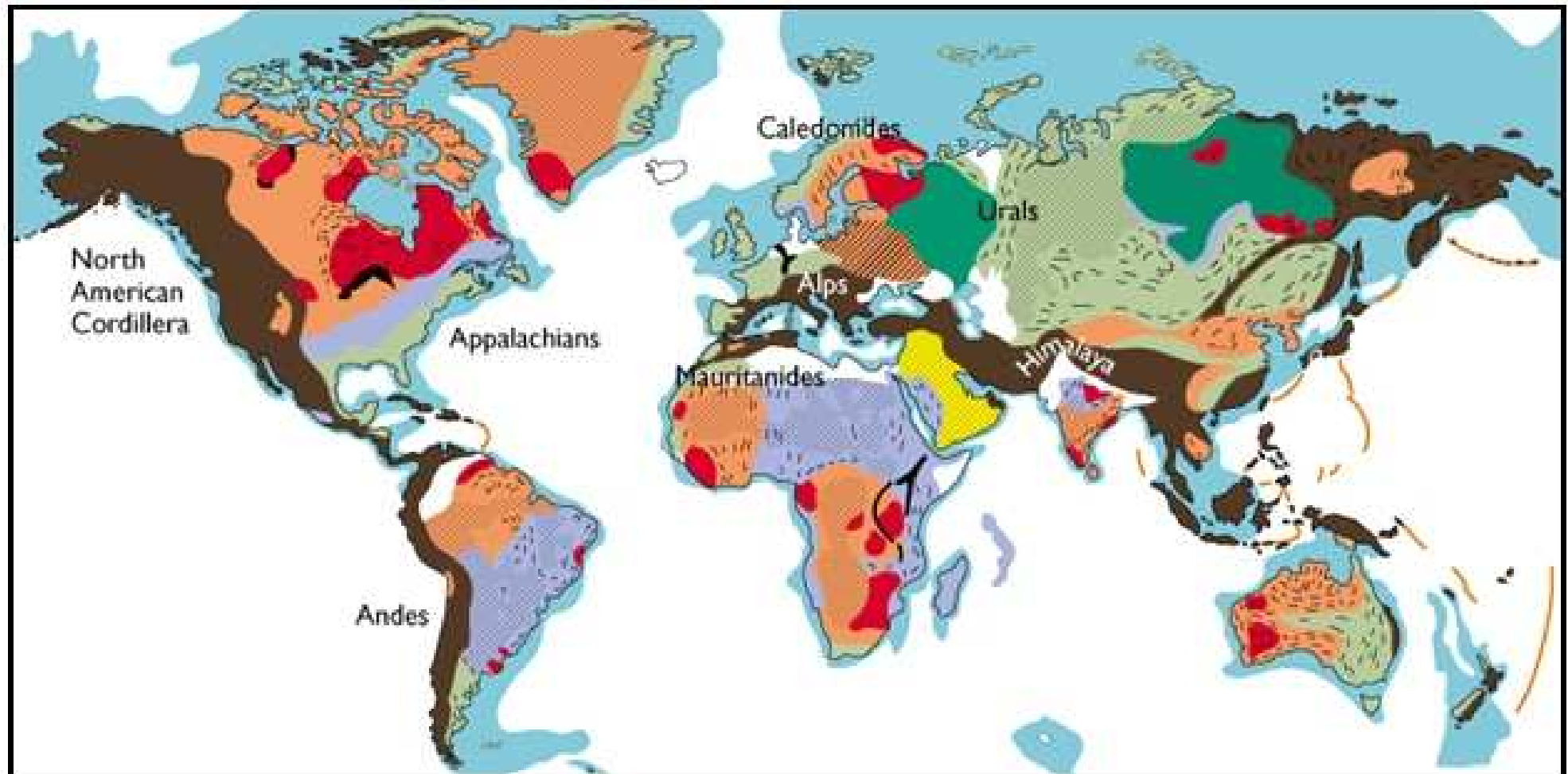

Blue areas mark continental crust
beneath the ocean

Fig.21.2

Geologie Evropy

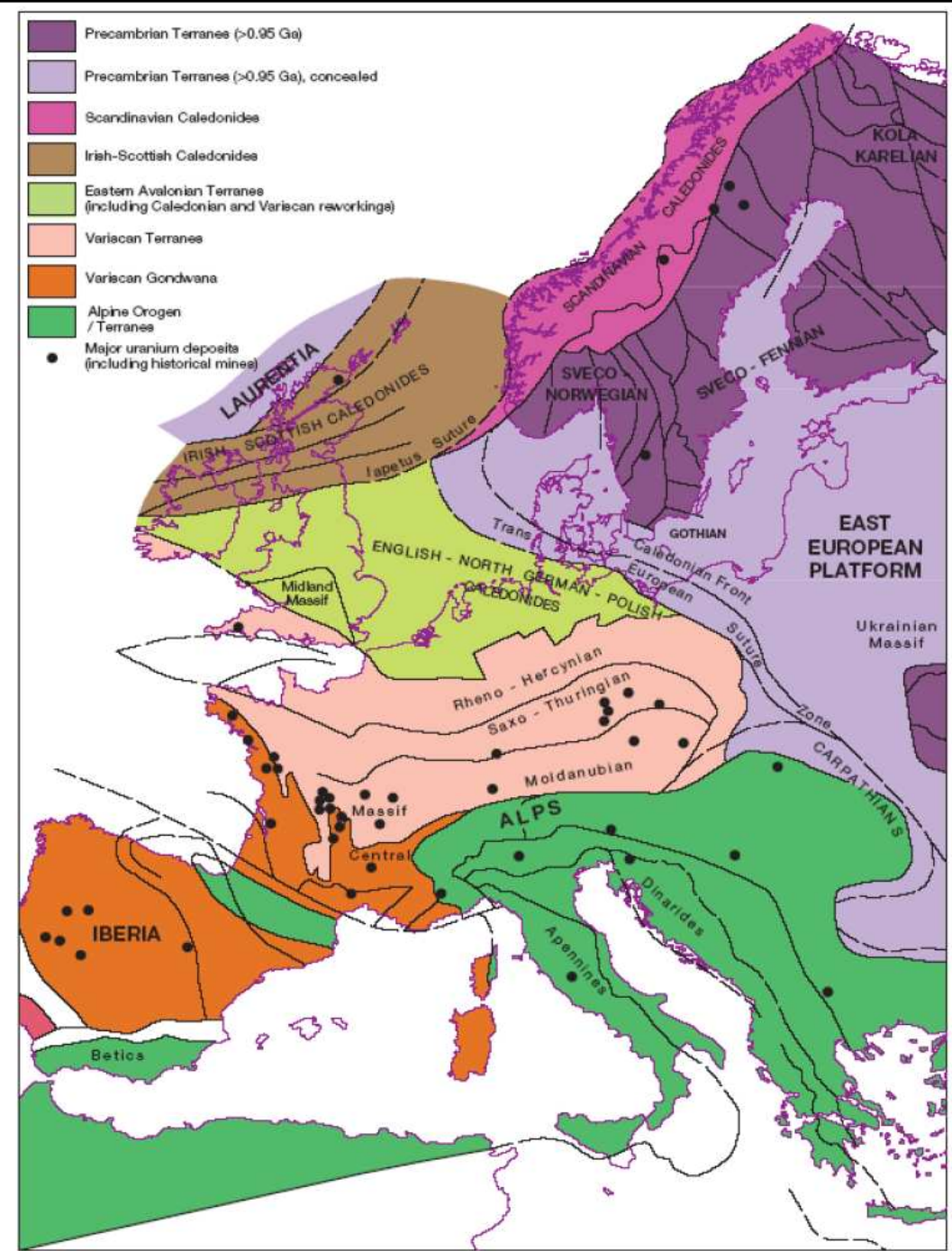
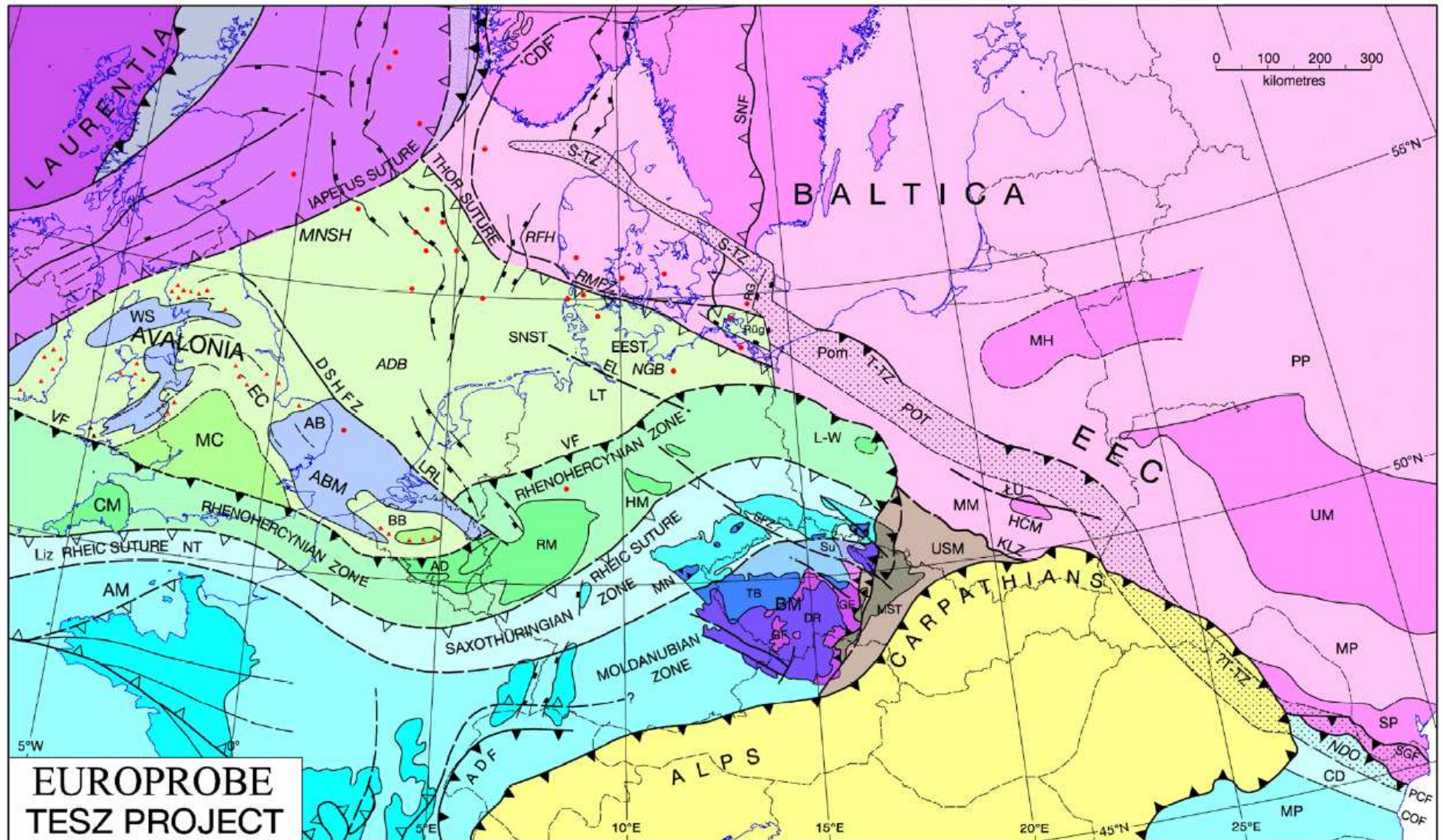

Figure 1. The 'terrane collage' of Precambrian and Phanerozoic Europe, a simplified sketch. Sutures and orogenic fronts are shown as bold lines, internal borders as thin or thin broken lines. Note that the size and shape of the terranes do not change significantly with time (approximate direction of younging is from north to south) (Reproduced with permission from Blundell *et al.* 1992, and Plant *et al.* 2003, Fig. 1, p. B229).

SVEKALAPKO





- PLATFORM SEDIMENTS:**
- GENOZOIC**
 - MESOZOIC**
 - PALEOZOIC**
- RIPHEAN SEDIMENTS**
- RIPHEAN SEDIMENTS**
 - RIPHEAN BASEMENT**
- PRECAMBRIAN BASEMENT**
- PRECAMBRIAN BASEMENT**

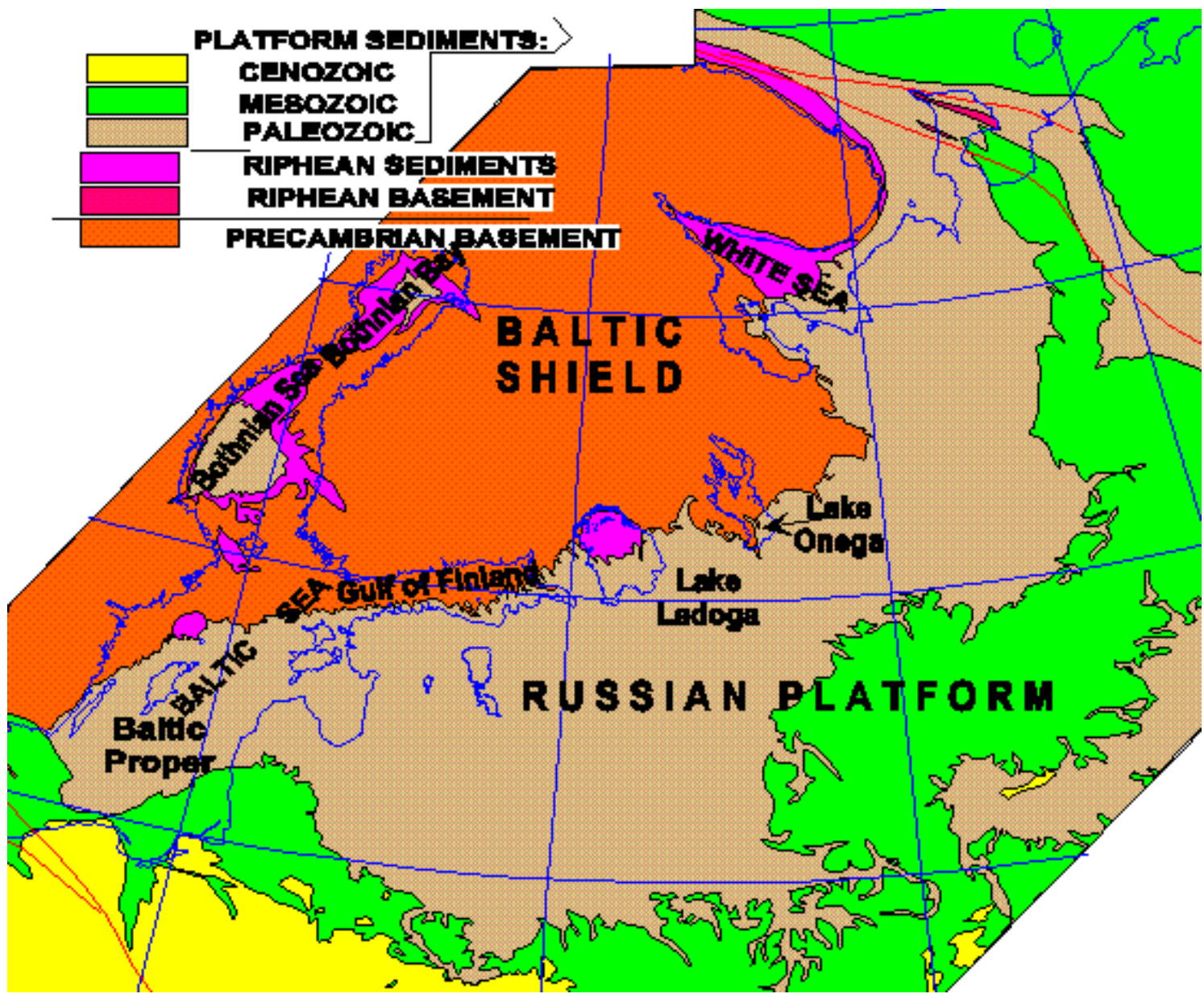

Východoevropský kraton se člení na

Fennoscandii – tvořena baltickým (fenoskandským) štítem a přilehlou platformou

Sarmatii

Volžsko-uralskou oblast

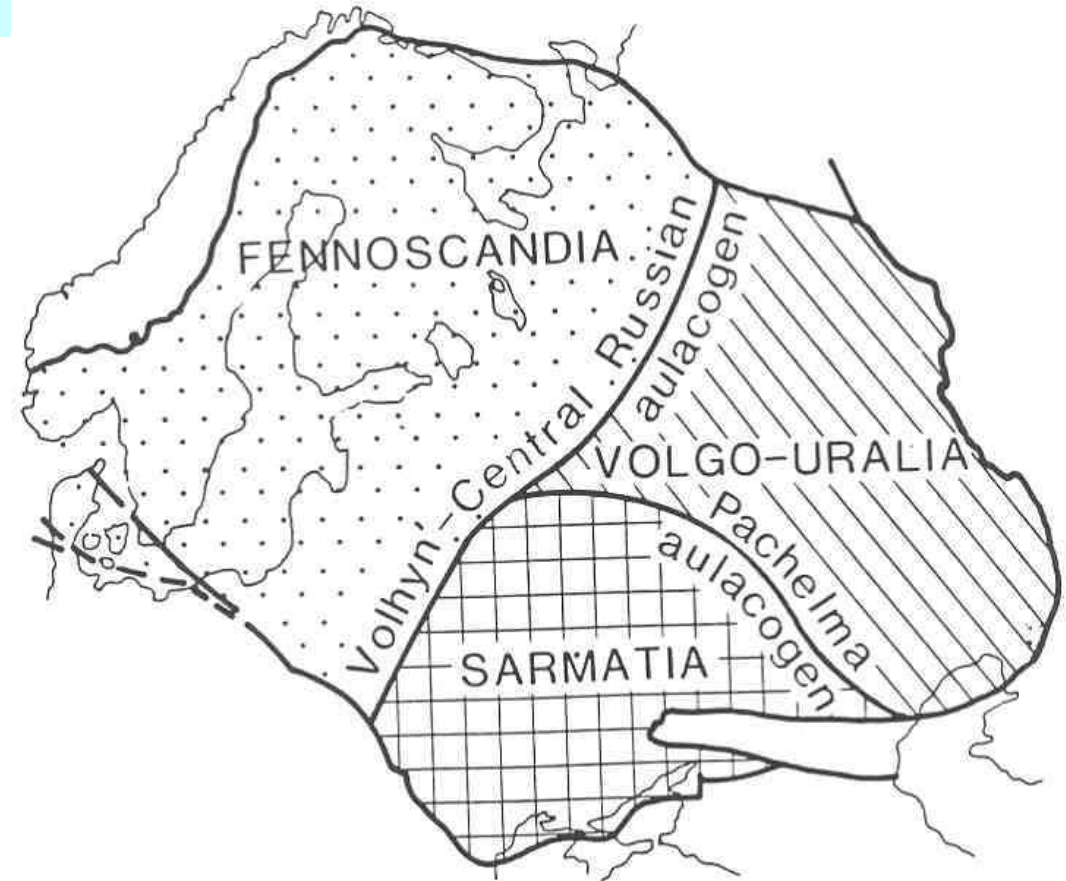

Fig. 2 Crustal segments of the East European Craton separated by Paleozoic rifts. Here, Fennoscandia applies to the Baltic Shield and its buried equivalent [Gorbatshev, 1993 #6].

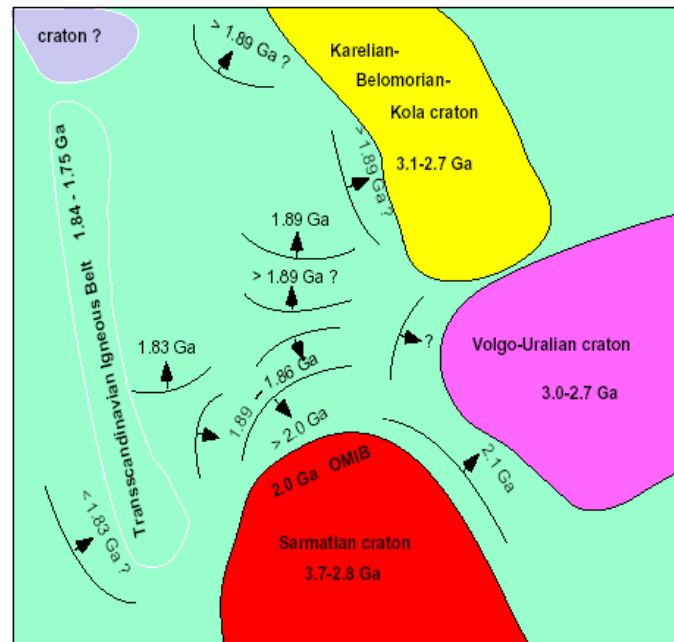
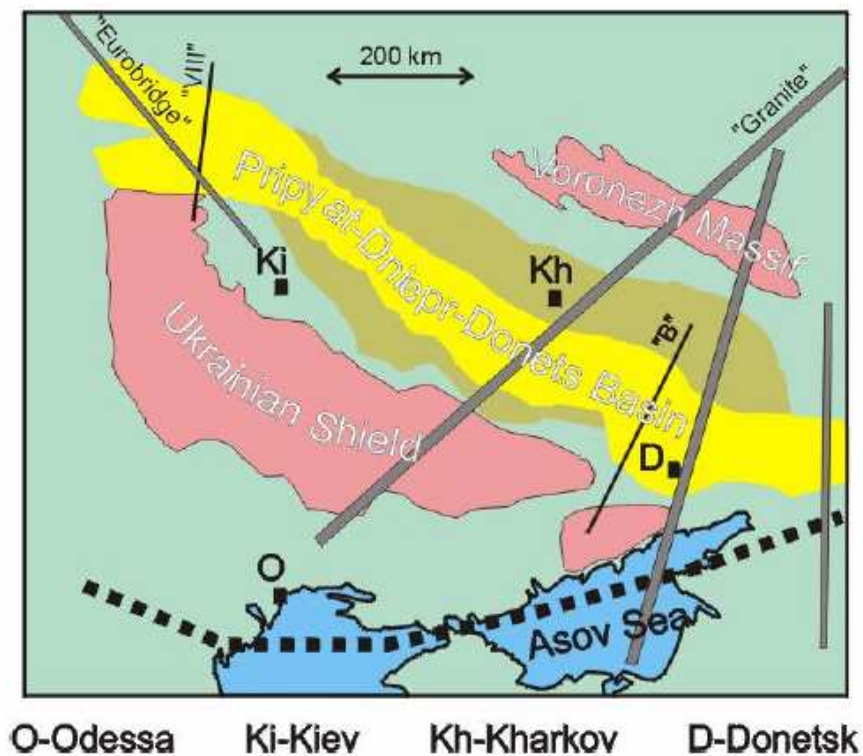

Figure 7.3: Sketch showing the axes of Svecofennian magmatic arcs and the times of Palaeoproterozoic accretion in the western part of the East-European Craton.



Hlavní povrchové výchozy prekambria v Sarmatii



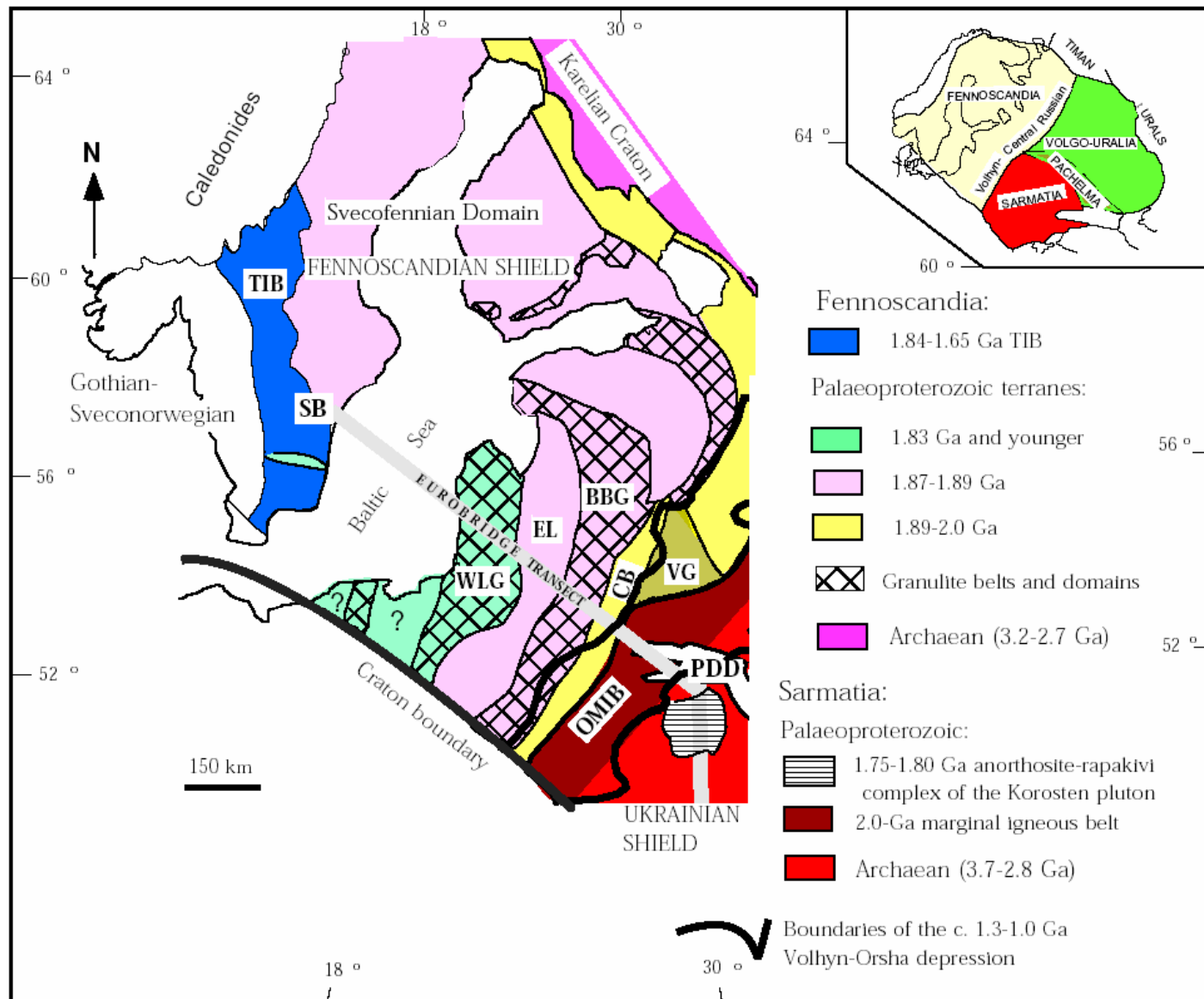

Figure 7.2a: Schematic map of the crustal structure in the EUROBRIDGE transect region (modified from Bogdanova et al., 1994, 1996). Letters are: BBG- Belarussian-Baltic Granulite Belt, CB- Central Belarussian Belt, EL- East Lithuanian-Latvian Belt, OMIB- Osnitsk-Mikashevichi Igneous Belt, PDD- Pripyat-Dniepr-Donets Palaeozoic Aulacogen, SB- South Baltic Domain, TIB- Transscandinavian Igneous Belt, VG- Vitebsk Granulite domain, WLG- West Lithuanian Granulite domain. The three-segment subdivision of the East-European Craton (inset) is according to Bogdanova et al. (1996).

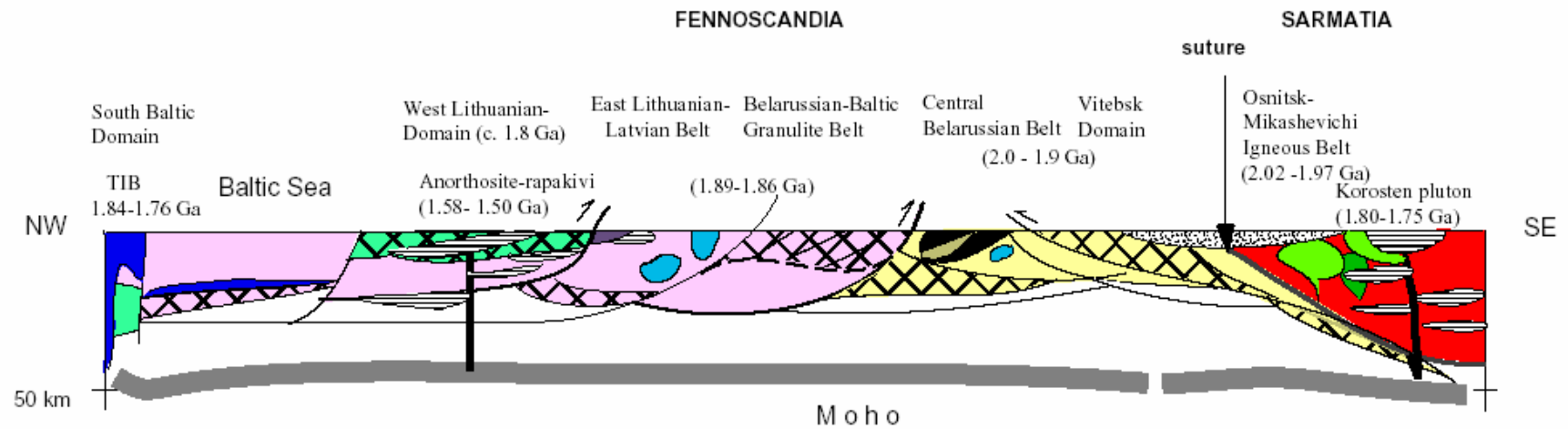

Figure 7.2b: Schematic profile of the crust along the EUROBRIDGE transect. The colours and symbols are the same as in Fig. 7.2a with some additions showing rapakivi-anorthositic intrusions in the western part of the transect (black-white stripes), intrusions of gabbro (light blue) in the East Lithuanian-Latvian Belt, the Okolovo volcanic unit in the Central Belarussian Belt (black), calc-alkaline intrusions in the Osnitsk-Mikashevichi Belt (green) and the sedimentary rocks of the Volhyn-Orsha depression (white dotted).

Členění baltického štítu

Kolská provincie – murmaňský blok a blok Sörvaranger - Kola

Belomorská provincie – belomorský blok a blok Inari

Karelská provincie - tvořena bloky Pudasjärvi, Iilsami a Kuhmo

**Sfekofenská provincie – vulkanická severosfekofenská, centrální sfekofenská,
vulkanická jihosfekofenská**

Sfekonorwegská provincie – značně provrásněné a metamorfované horniny

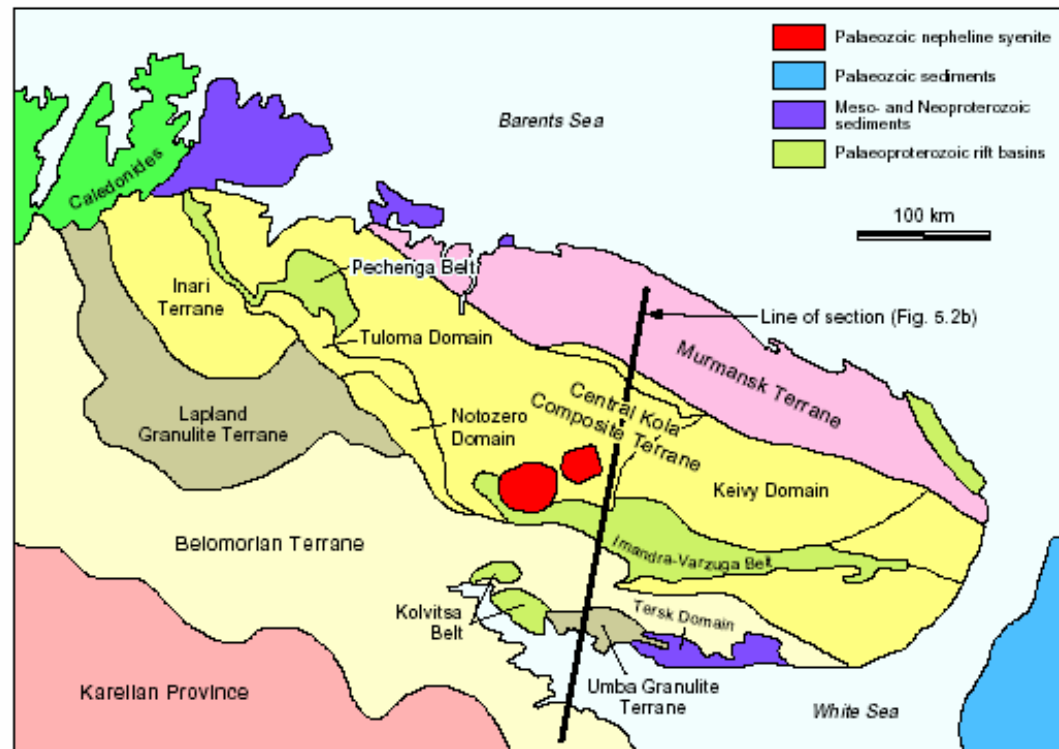

Figure 5.2a: Tectonostratigraphic terranes in the Lapland-Kola Orogen from Balagansky and Glaznev (pers. comm. 1994) and incorporating data from Marker (in Blundell et al., 1992).

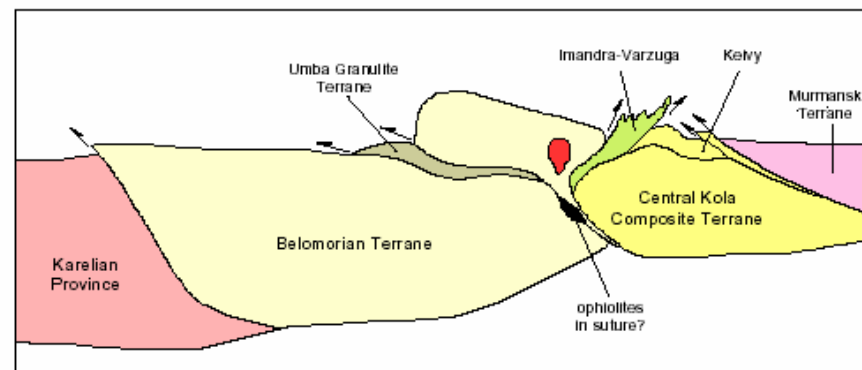

Figure 5.2b: Schematic cross-section along the line shown in Fig. 5.2a. Based on Marker (pers. comm., 1994) and Balagansky (pers. comm., 1994).

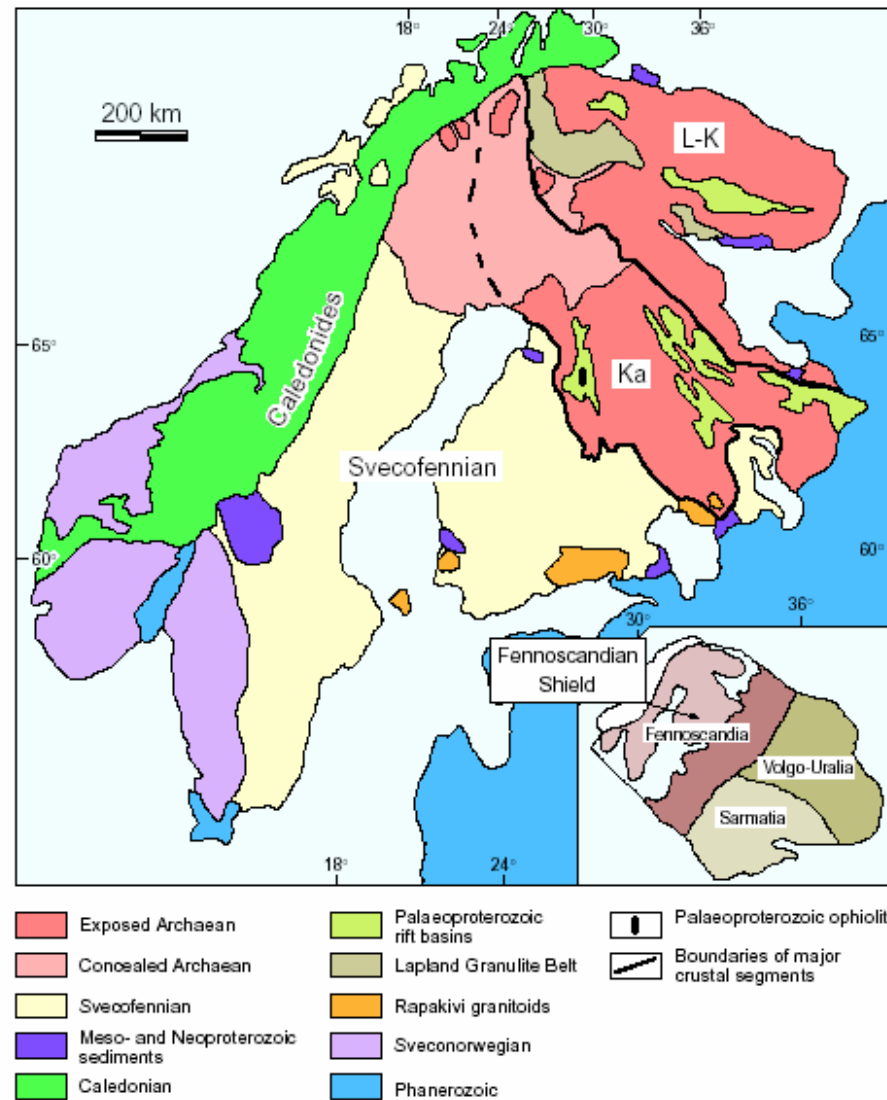

Figure 5.1: Simplified geological map of the Baltic Shield and surroundings (modified from Boyd et al., 1985 and Öhlander et al., in Gorbatshev, 1993; inset showing the subdivision of the East-European Craton from Gorbatshev and Bogdanova, in Gorbatshev, 1993). Generalized tectonic boundaries between the Lapland-Kola Orogen (L-K) and the Karelian Province (Ka) and between the latter and the Svecofennian Orogen are shown as heavy lines, dashed to indicate greater uncertainty. Proterozoic rift basins are omitted in the region labelled 'concealed Archaean'.

Saamská orogeneze	cca 3 Ga	kolize svekobaltského(SVK) a karelského kontinentu(KK)
-------------------	----------	---

Kuhmo-belomorská orogeneze	2,8 Ga	Wilsonův cyklus mezi SVK a KK
----------------------------	--------	-------------------------------

Sfekobaltská orogeneze	2,2 Ga	další Wilsonův cyklus mezi SVK a KK
------------------------	--------	-------------------------------------

Sfekofenská orogeneze	2,0 Ga	další Wilsonův cyklus mezi SVK a KK
-----------------------	--------	-------------------------------------

Gotská orogeneze	1,7-1,5	?? Akrece oblouků, mikrokontinentu, Amazonie
------------------	---------	---

Sfekonorvegská orogeneze	1,0	kolize s Laurentii
--------------------------	-----	--------------------

Saamská orogeneze

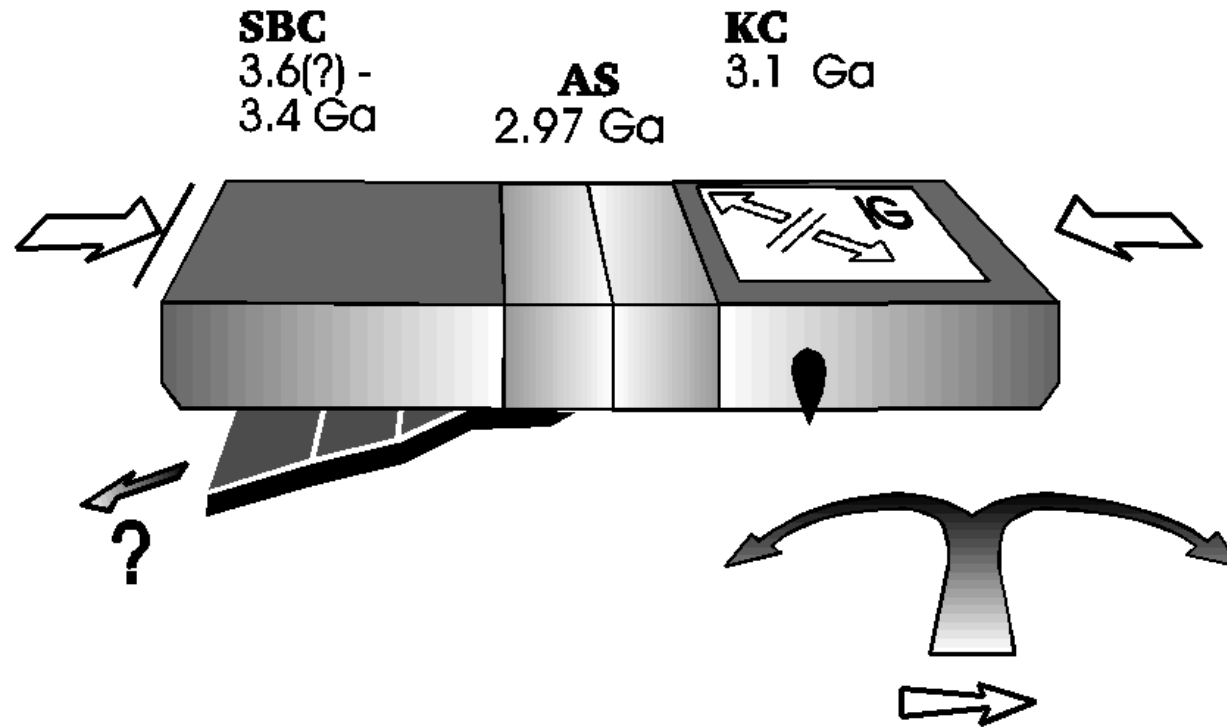

Fig. 2. Closing stage of the Archaean sea (AS; ca. 2.97 Ga). KC = Karelian continent and SBC = Svecobaltian continent. IG = intracontinental rifting and greenstone volcanism.

Počáteční stadium kuhmo-belomorské orogenetického cyklu

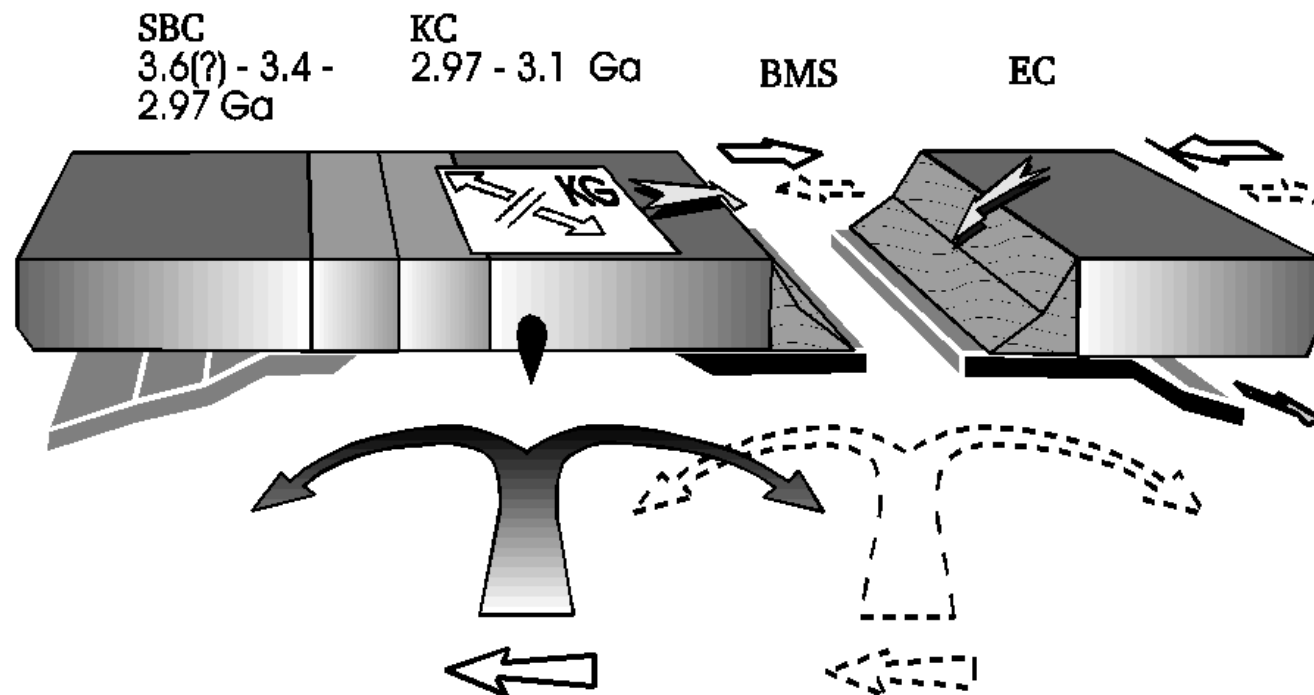

Fig. 3. Initial stage of Kuhmoan orogeny. Rifting of Karelían continent and intrusion of Kuhmo Greenstones (KG; ca. 2.79 Ga). The Belomorian sea (BMS) has begun to close, with convergence against the 'Eastern continent' (EC).

Kuhmo-belomorská orogeneze

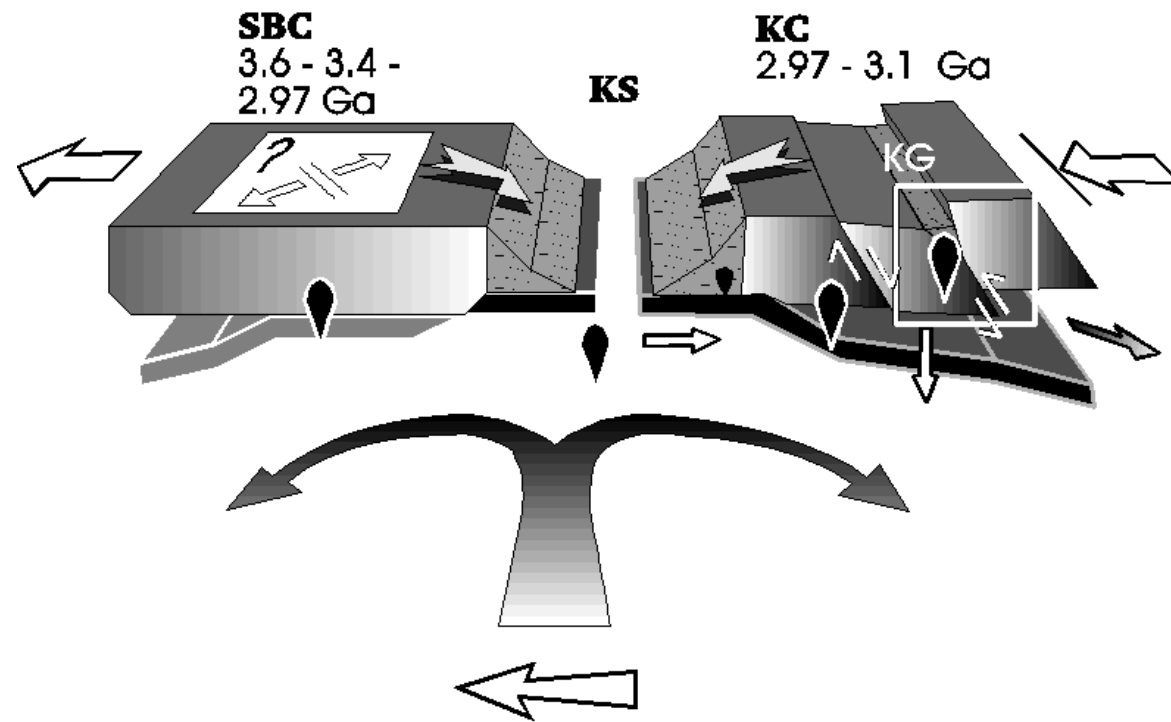

Fig. 4. Opening and subduction stage of the Karelian sea (KS), with compression and thrust faults in Karelian continent (ca. 2.74 - 2.7 Ga). The framed part of the figure has been adopted from Luukkonen (1992). The nearly simultaneous closing and collision stages of the Belomorian orogeny have been omitted from this figure.

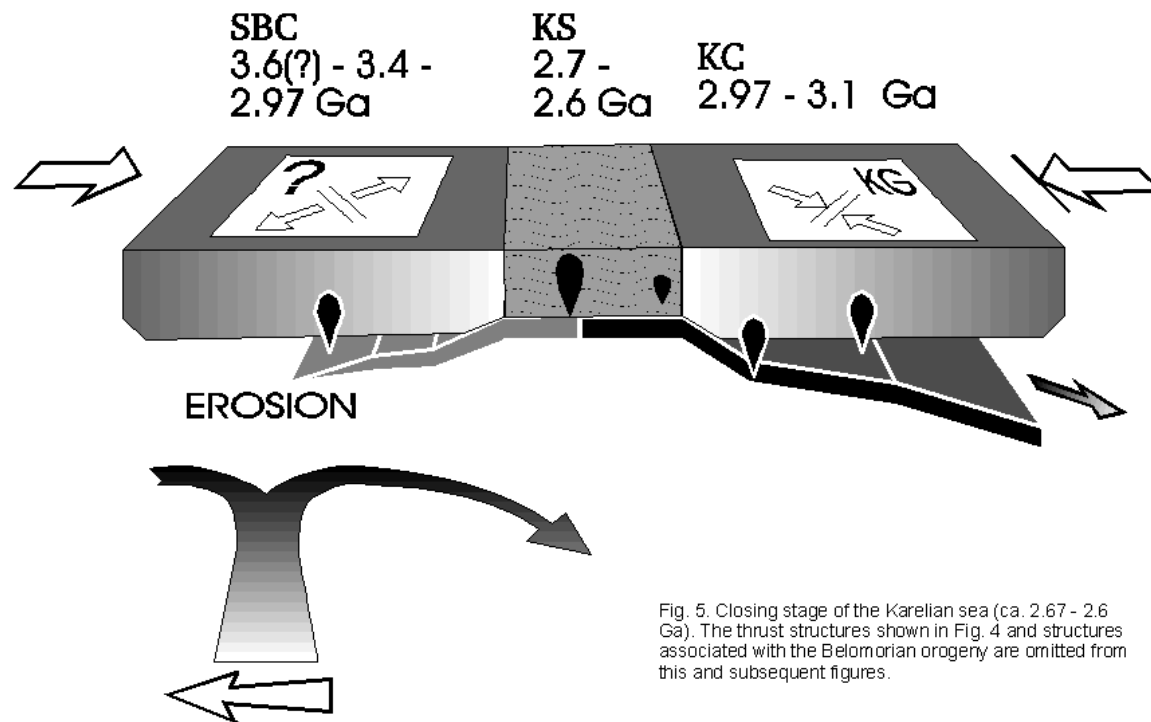
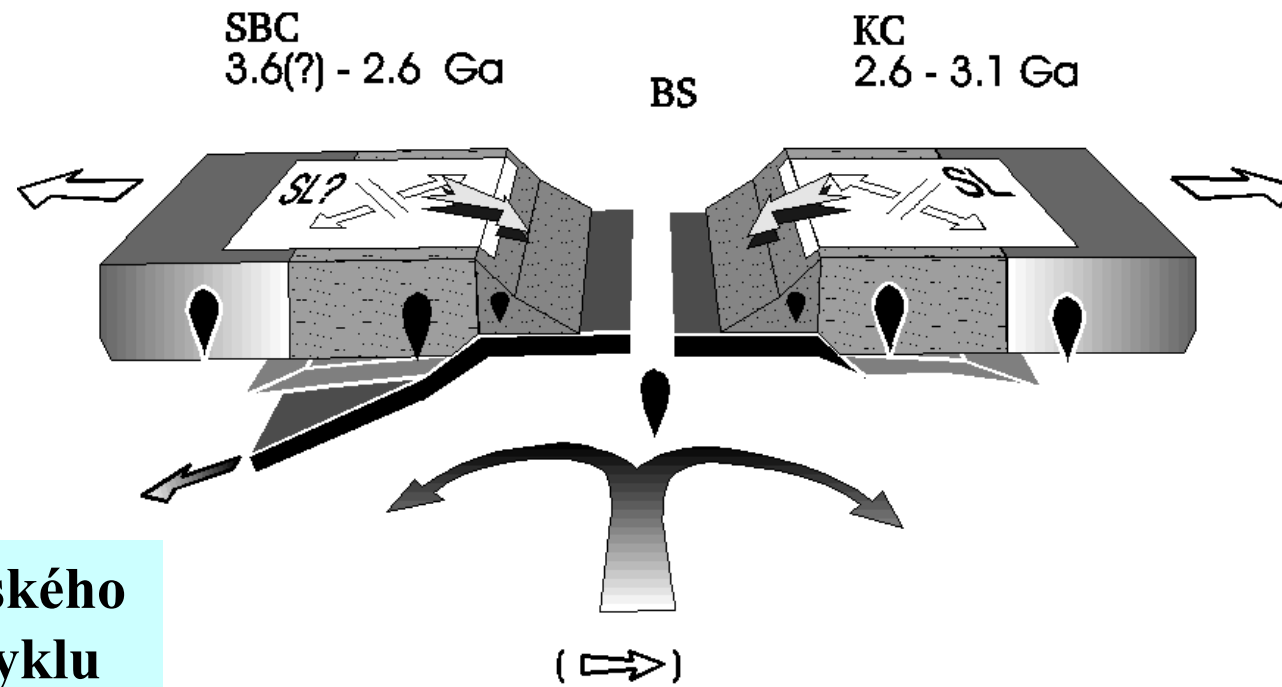

Fig. 5. Closing stage of the Karelian sea (ca. 2.67 - 2.6 Ga). The thrust structures shown in Fig. 4 and structures associated with the Belomorian orogeny are omitted from this and subsequent figures.



Začátek svekobaltského orogenetického cyklu

Fig. 6a. Opening stage of the Baltian sea (BS), intrusion of Karjalitic sills (SL), initiation of subduction (ca. 2.2 - 2.15 Ga).

ca. 2.2 Ga

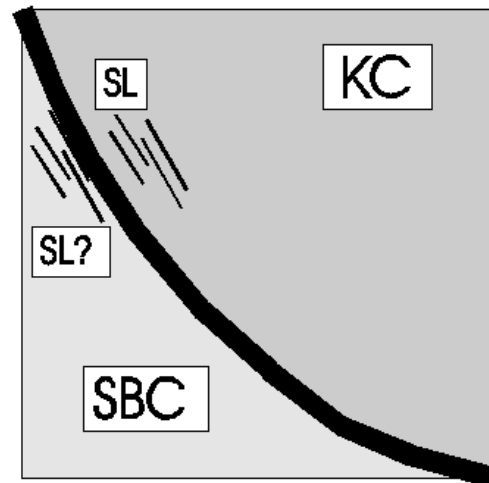

Fig. 6b. Plan view of the breakup of the Sveco-Baltian - Karelian continent (SBC and KC). Intrusion of Karjalitic sills (SL). The thick line refers to the boundary between convection cells.

ca. 2.15 Ga

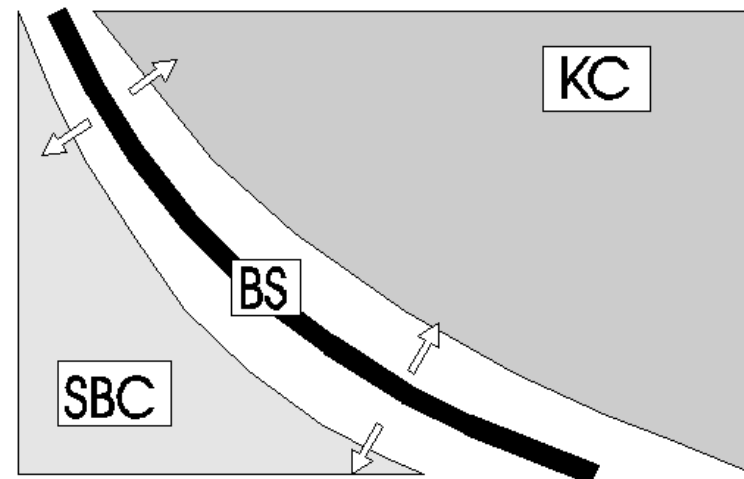
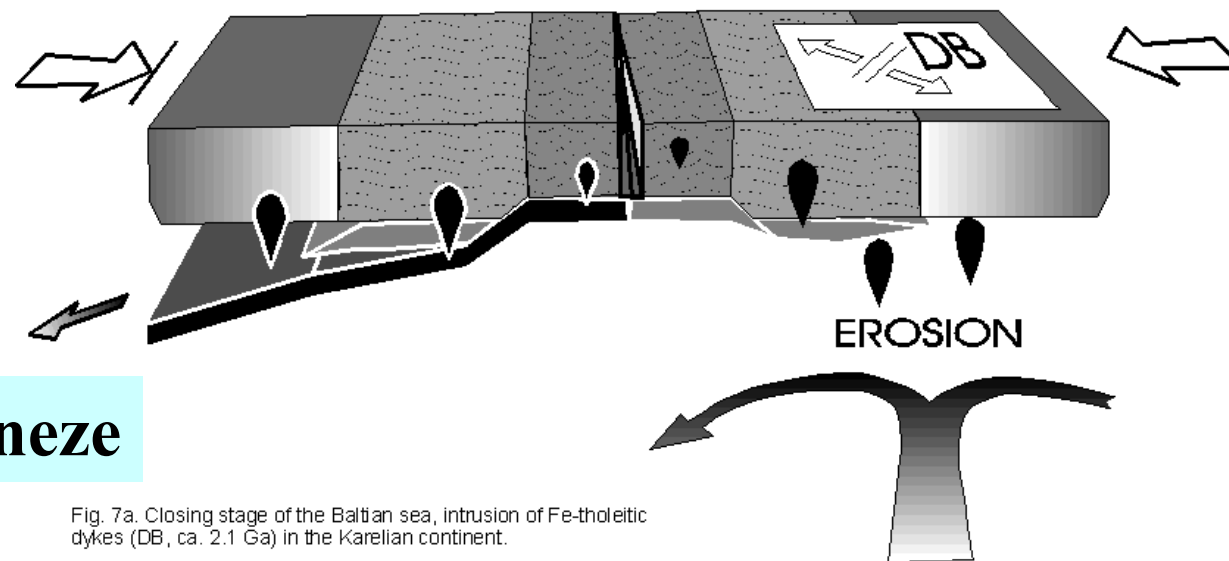

Fig. 6c. Plan view of the opening of the Baltian sea (BS).

SBC
3.6(?) - 2.6 Ga

BS
2.1 -
2.0 Ga

KC
2.6 - 3.1 Ga



Svekobaltská orogeneze

Fig. 7a. Closing stage of the Baltian sea, intrusion of Fe-tholeiitic dykes (DB, ca. 2.1 Ga) in the Karelian continent.

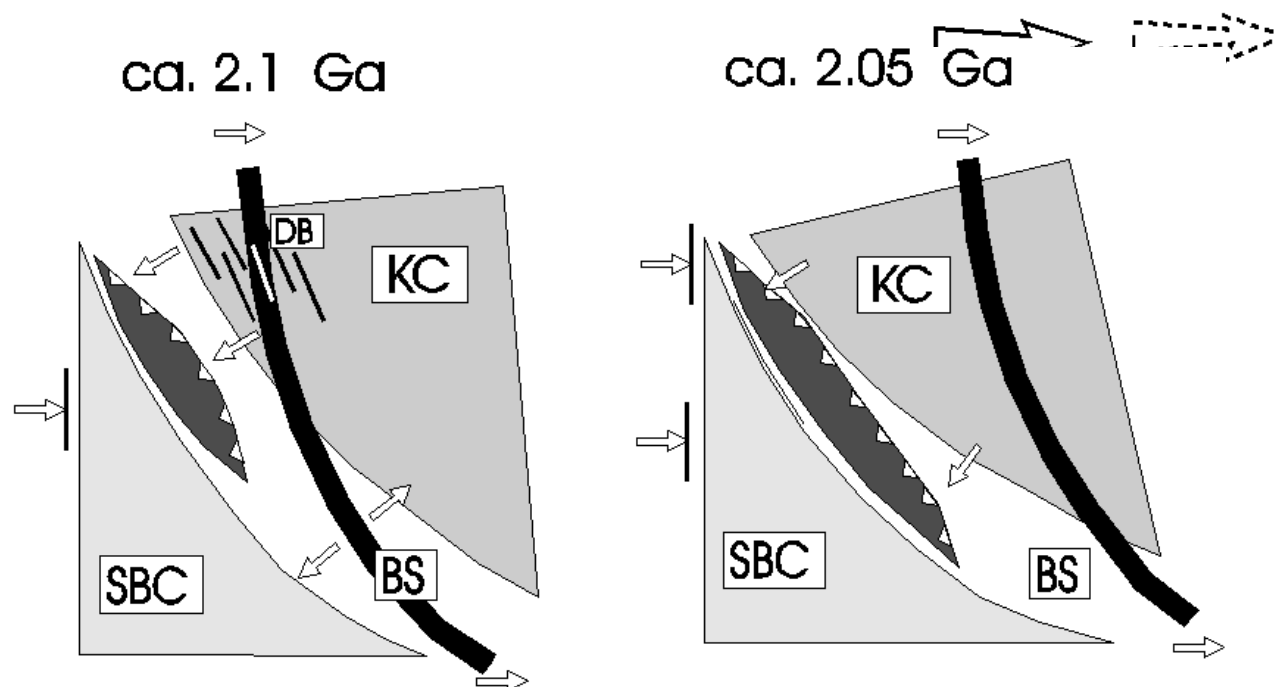
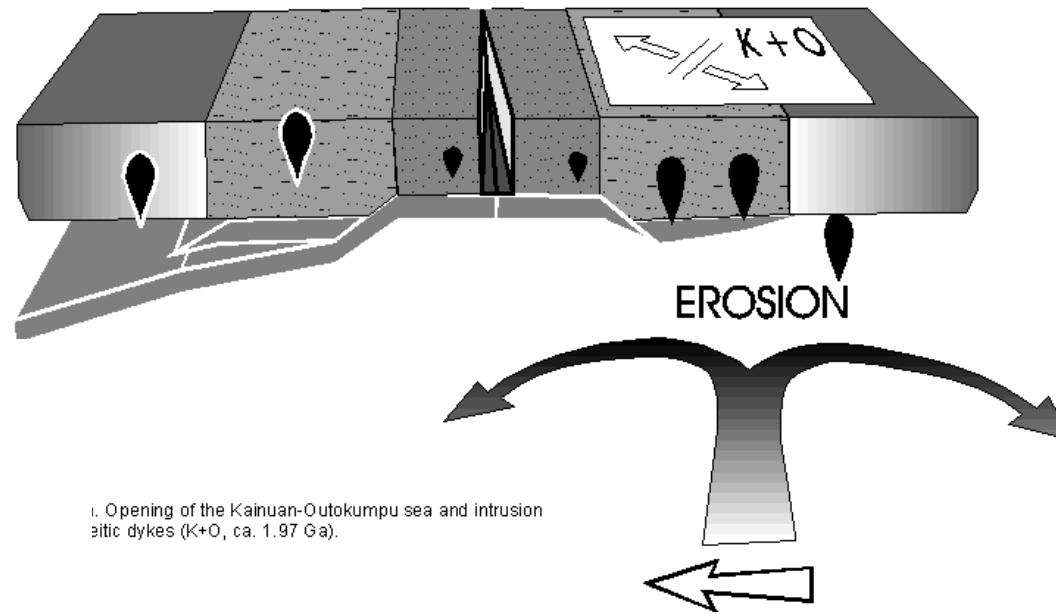

Fig. 7b-7c. Plan view of the closing stage of the Baltic sea. Intrusion of Fe-tholeiitic dykes (DB). Subduction under Svecobaltian continent. Convection cells move beneath and behind the Karelian continent.

SBC
3.6(?) - 2.6 Ga

BS
2.1 -
2.0 Ga

KC
2.6 - 3.1 Ga



ca. 2.0 - 1.96 Ga

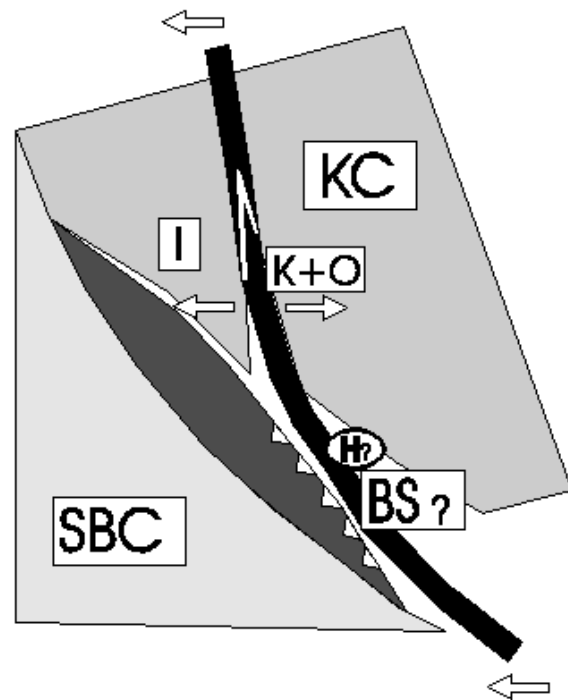

i. Opening of the Kainuan-Outokumpu sea and intrusion
siltic dykes (K+O, ca. 1.97 Ga).

Začátek sfekofenského orogenetického cyklu

Fig. 8b. Divergent convection cells evolve or move beneath the Karelian continent. Intracontinental rifting and opening of the Kainuan-Outokumpu sea (K+O). Separation of Iisalmi block (I). Formation of the Haveri seamount (H).

Otevírání Svekofenského moře

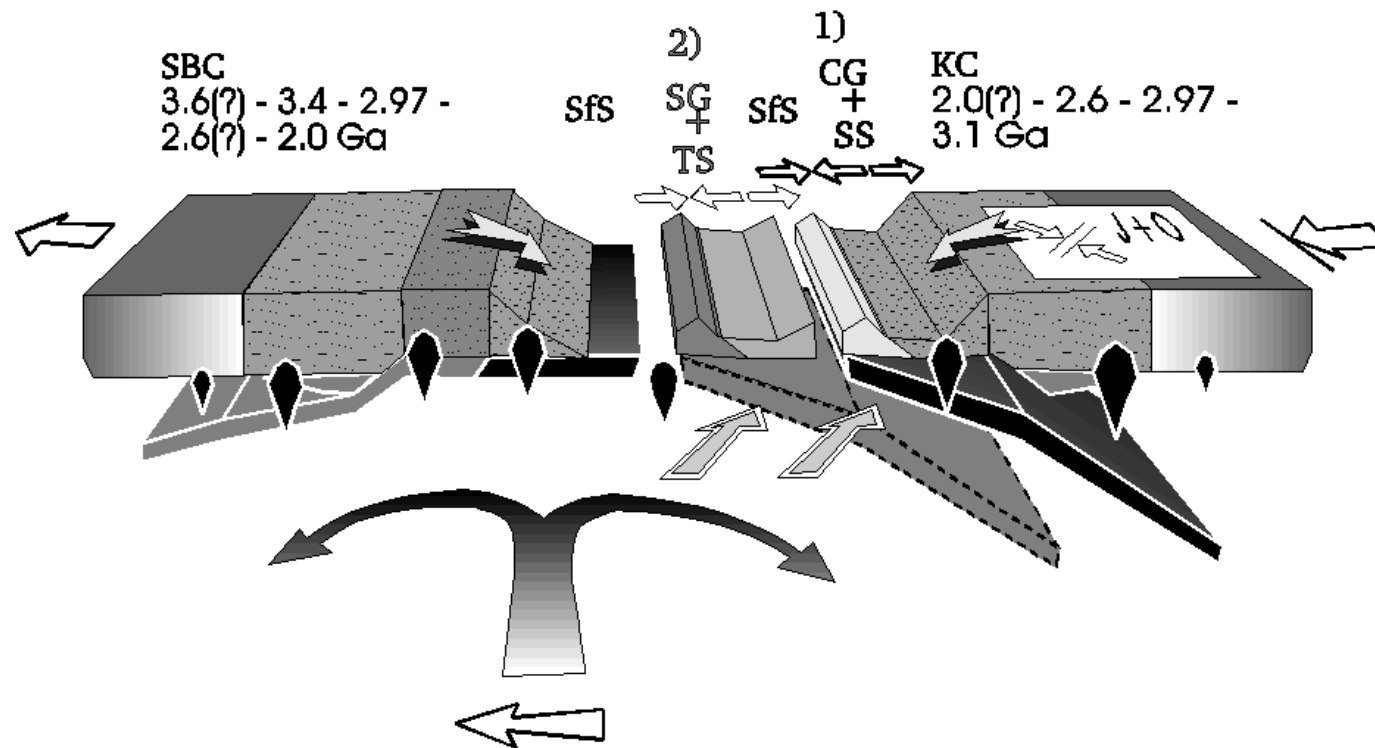
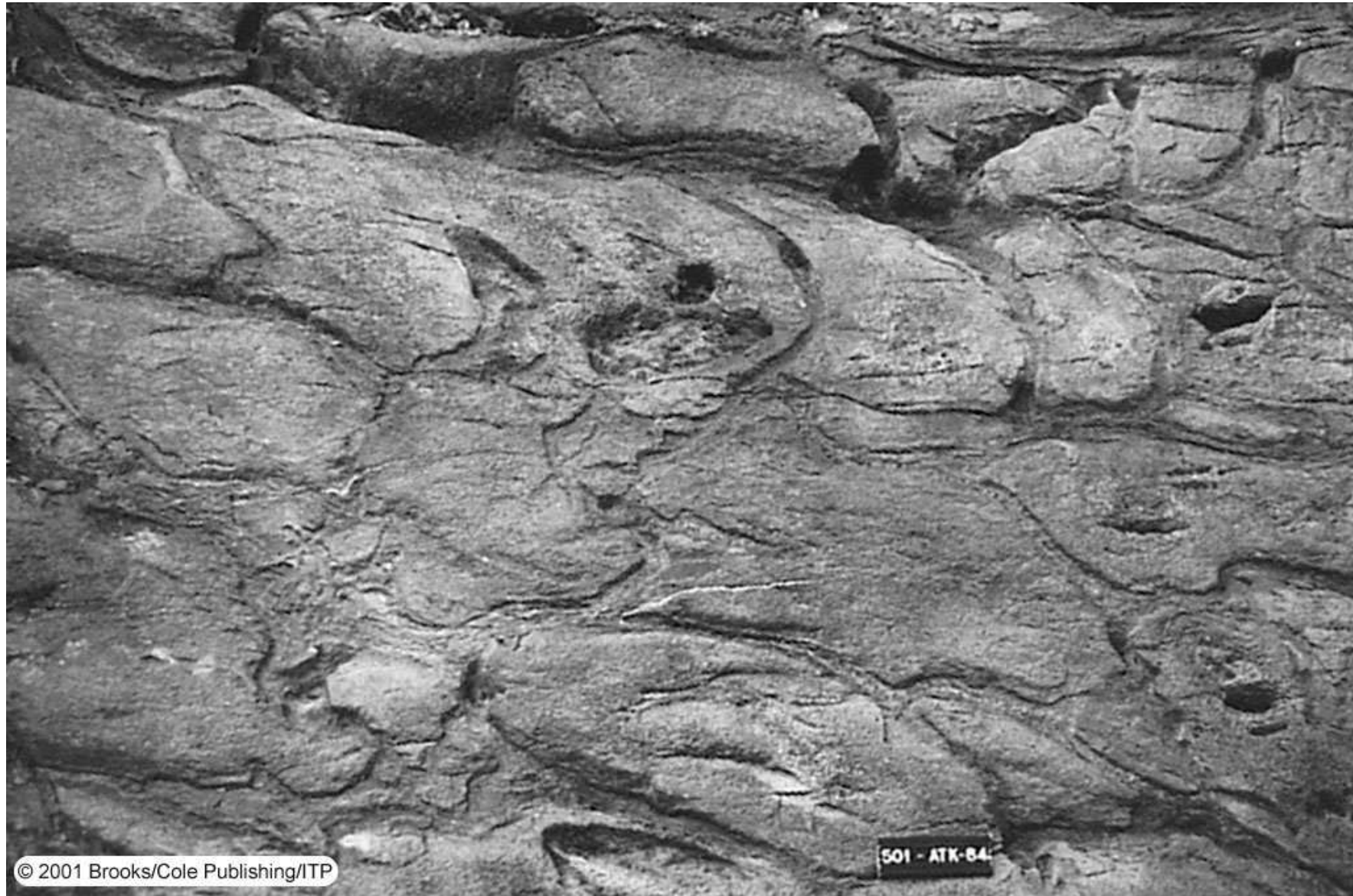

Fig. 10a. Opening of the Svecofennian sea (SfS), subduction, evolution of central Finland island arc + Savo back arc basin (CG+SS) and of southern Finland island arc + Vaasa-Tampere back arc basin (SG+TS). Closing stage of the Kainuan sea and obduction of the Jormua and Outokumpu ophiolites (J+O; ca. 1.97 - ... Ga). The grey 'double arrows' represent the southern component of the compression.

21

Metamorphosed pillow basalts – Jormua, Finland.



© 2001 Brooks/Cole Publishing/ITP

20 Ophiolite suites –oceanic crust preserved in areas of continental collision.

Jormua mafic-ultramafic complex in Finland, about 1.96 billion years old, compares closely in detail with younger well-documented ophiolites.

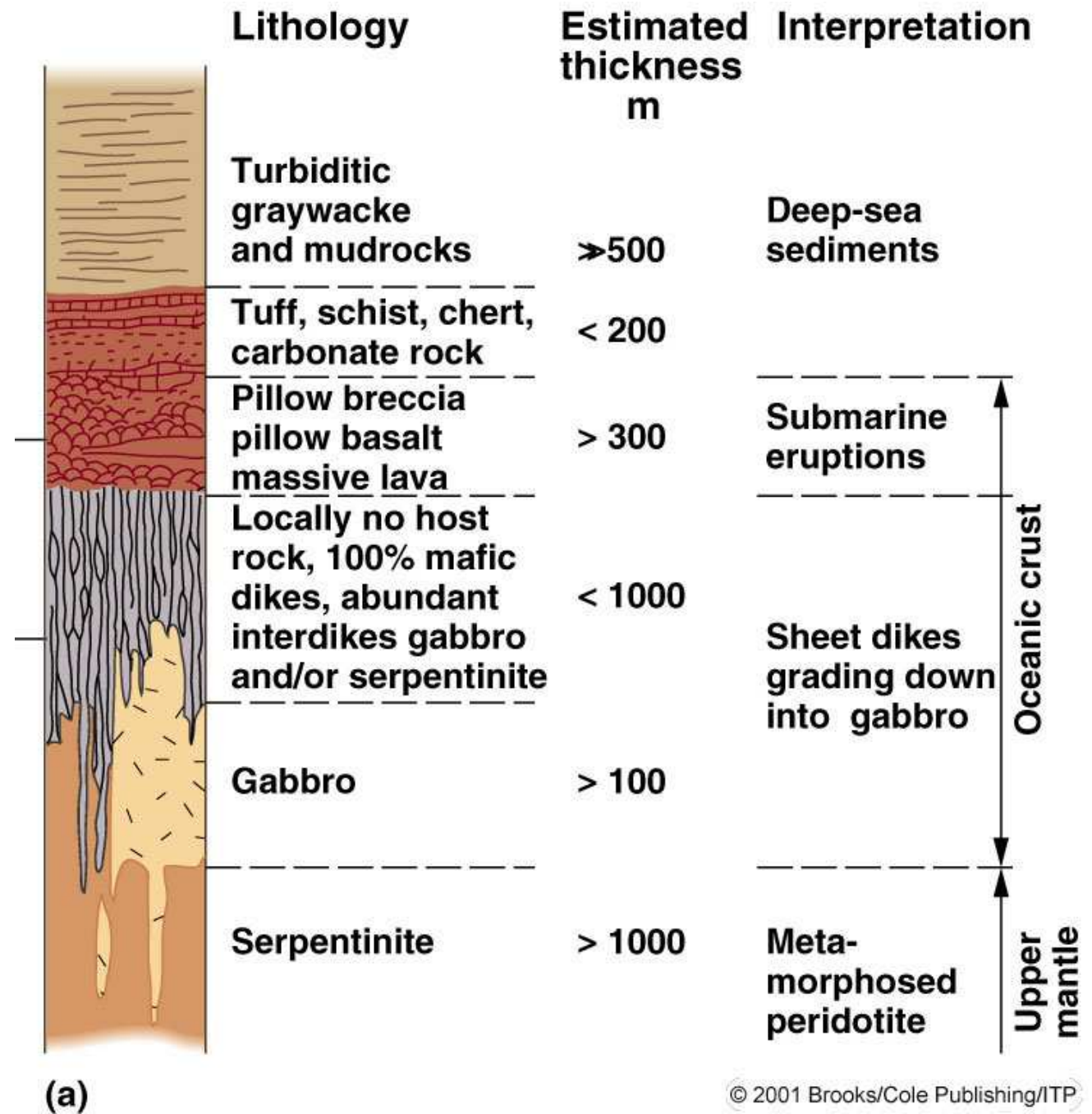

Vznik systému ostrovních a magmatických oblouků

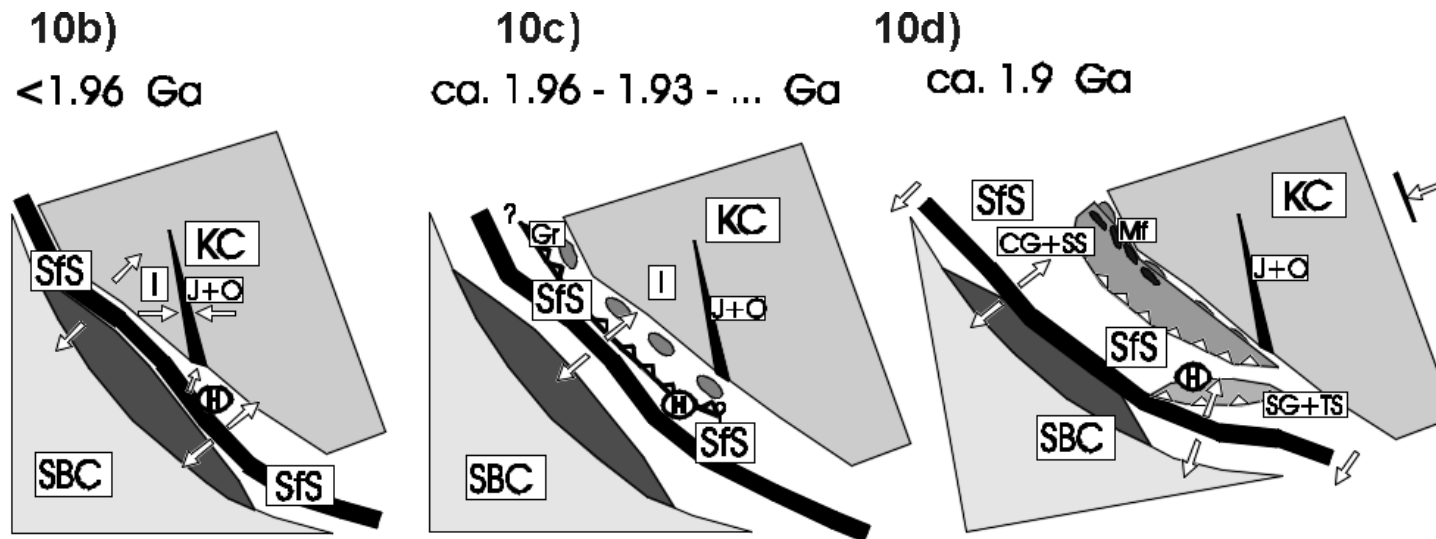

Fig. 10b. Plan view of rifting and opening of the Svecofennian sea (SfS) at the 2.1 - 2.0 Ga suture. Closing of the Kainuan-Outokumpu sea and obduction of the Jormua-Outokumpu ophiolites (J+O).

Fig. 10c. Plan view of the 'mature stage' of the Svecofennian sea. Intrusion of the 1.93 - 1.91 Ga granitoids (GR) (subduction related?).

Fig. 10d. Plan view of the evolution of the Svecofennian island arc systems. To the north is the central Finland granite island arc and Savo schist belt back-arc basin (CG+SS), while to the south is the southern Finland island arc and Vaasa-Tampere back arc basin (SG+TS). Intrusion of the Suonenjoki-Pyhäsalmi-Vihanti-Hailuoto mafic complexes (MF).

Sfekofenská orogeneze

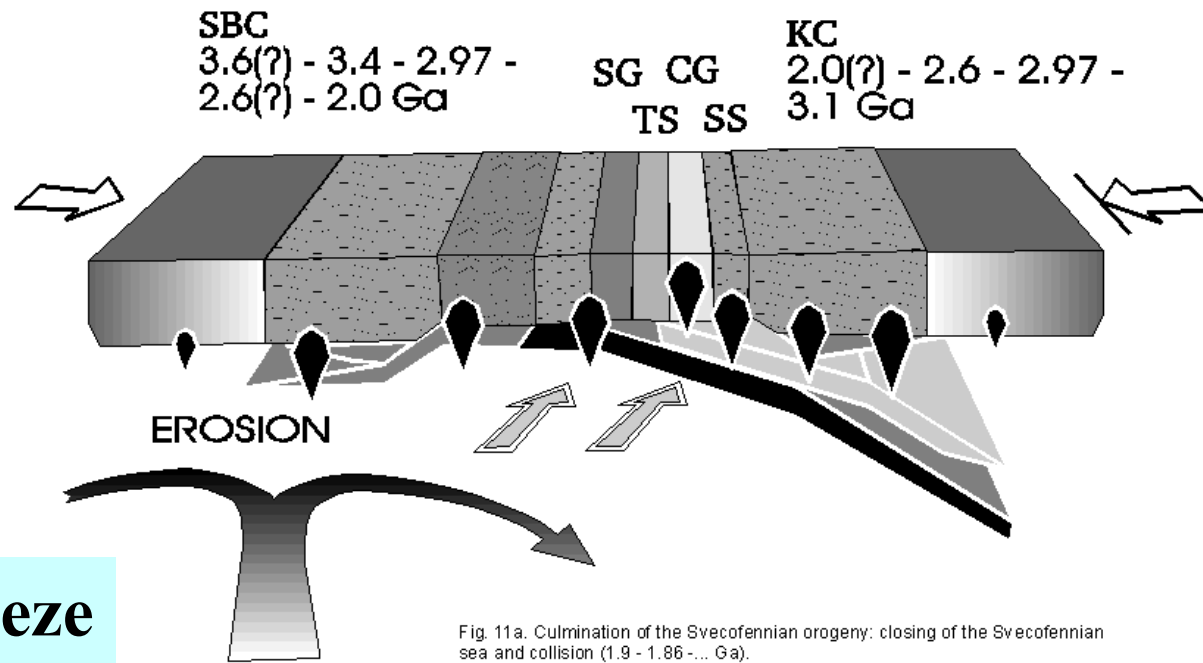

Fig. 11a. Culmination of the Svecofennian orogeny: closing of the Svecofennian sea and collision (1.9 - 1.86 - ... Ga).

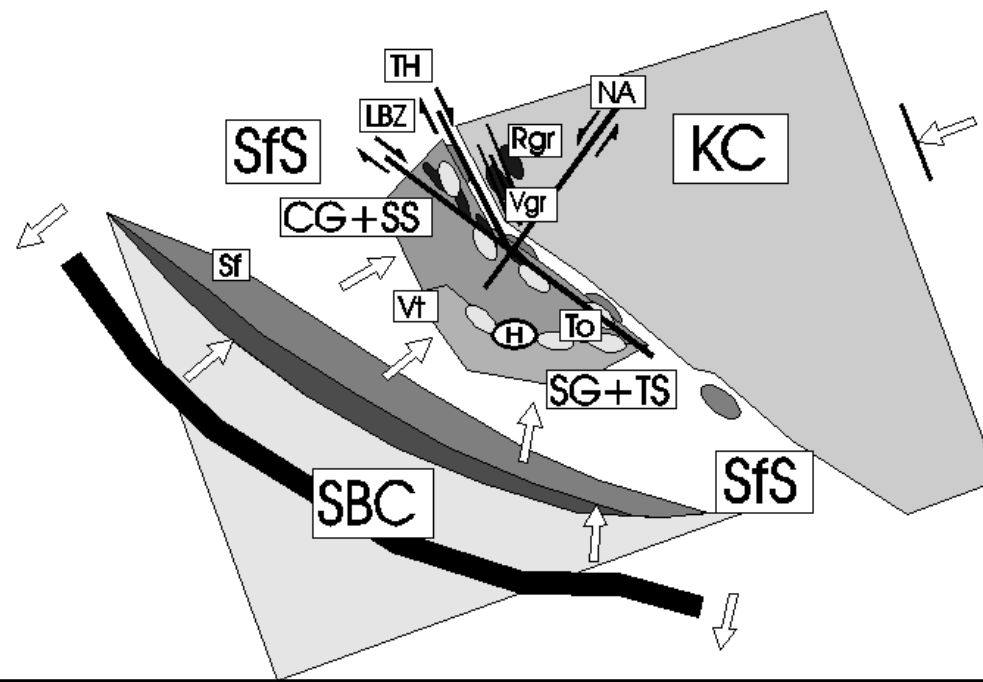

Fig. 11b. Plan view of the collision stage of the (CG+SS) and (SG+TS) island arc systems with Haveri volcanics in between. Overthrusting of the Vaasa block (Vt) and upthrusting of the Varpaisjärvi and Rautavaara granulites (Vgr and Rgr). Intrusion of tonalites (To). Evolution of the Ladoga-Bothnian Bay zone (LBZ) dextral faulting and its conjugate Näränkäväära-Auho faults (NA). Tervo-Haaparanta fracture zone (TH) represents the NE branch of LBZ. Later Svecofennian processes in Sweden and Estonia are denoted by (Sf).

Sfekonorvegská orogeneze 1,0 kolize s Laurentii

C. W. Carrigan et al. / *Precambrian Research* 120 (2003) 1–36

3

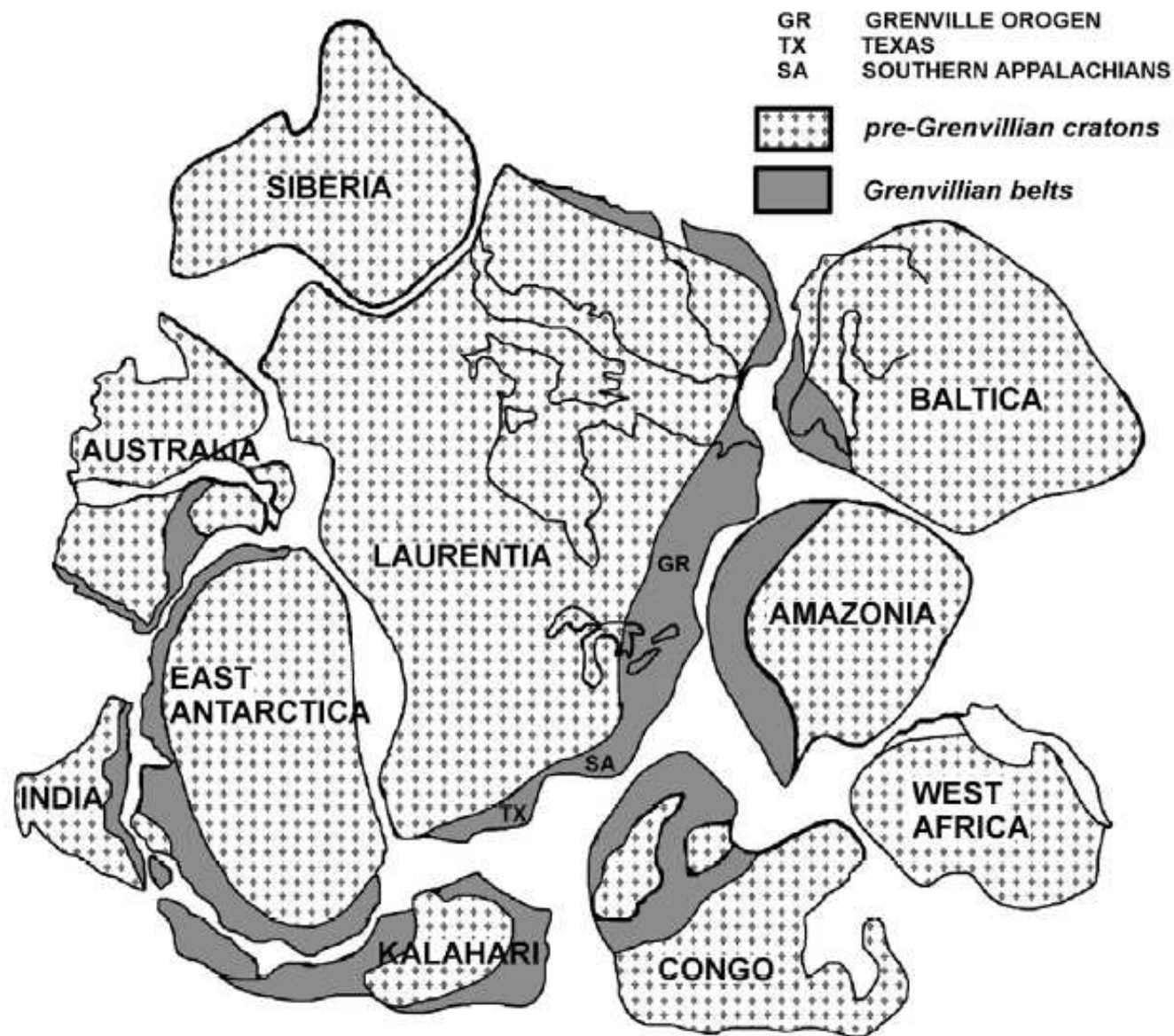

Fig. 1. One possible reconstruction of the late Mesoproterozoic supercontinent Rodinia. Archean cratons in light gray stipple, Grenvillian belts in dark gray. Modified from Hoffman (1991).

Saamská orogeneze	cca 3 Ga	kolize svekobaltského(SVK) a karelského kontinentu(KK)
-------------------	----------	---

Kuhmo-belomorská orogeneze	2,8 Ga	Wilsonův cyklus mezi SVK a KK
----------------------------	--------	-------------------------------

Sfekobaltská orogeneze	2,2 Ga	další Wilsonův cyklus mezi SVK a KK
------------------------	--------	-------------------------------------

Sfekofenská orogeneze	2,0 Ga	další Wilsonův cyklus mezi SVK a KK
-----------------------	--------	-------------------------------------

Gotská orogeneze	1,7-1,5	?? Akrece oblouků, mikrokontinentu, Amazonie
------------------	---------	---

Sfekonorvegská orogeneze	1,0	kolize s Laurentii
--------------------------	-----	--------------------

