

9. MECHANISMS OF DEVELOPMENT I – REGULATION OF LIMB DEVELOPMENT BY FIBROBLAST GROWTH FACTORS (FGF)

4 receptors: FGFR1-4
22 ligands: FGF1-23

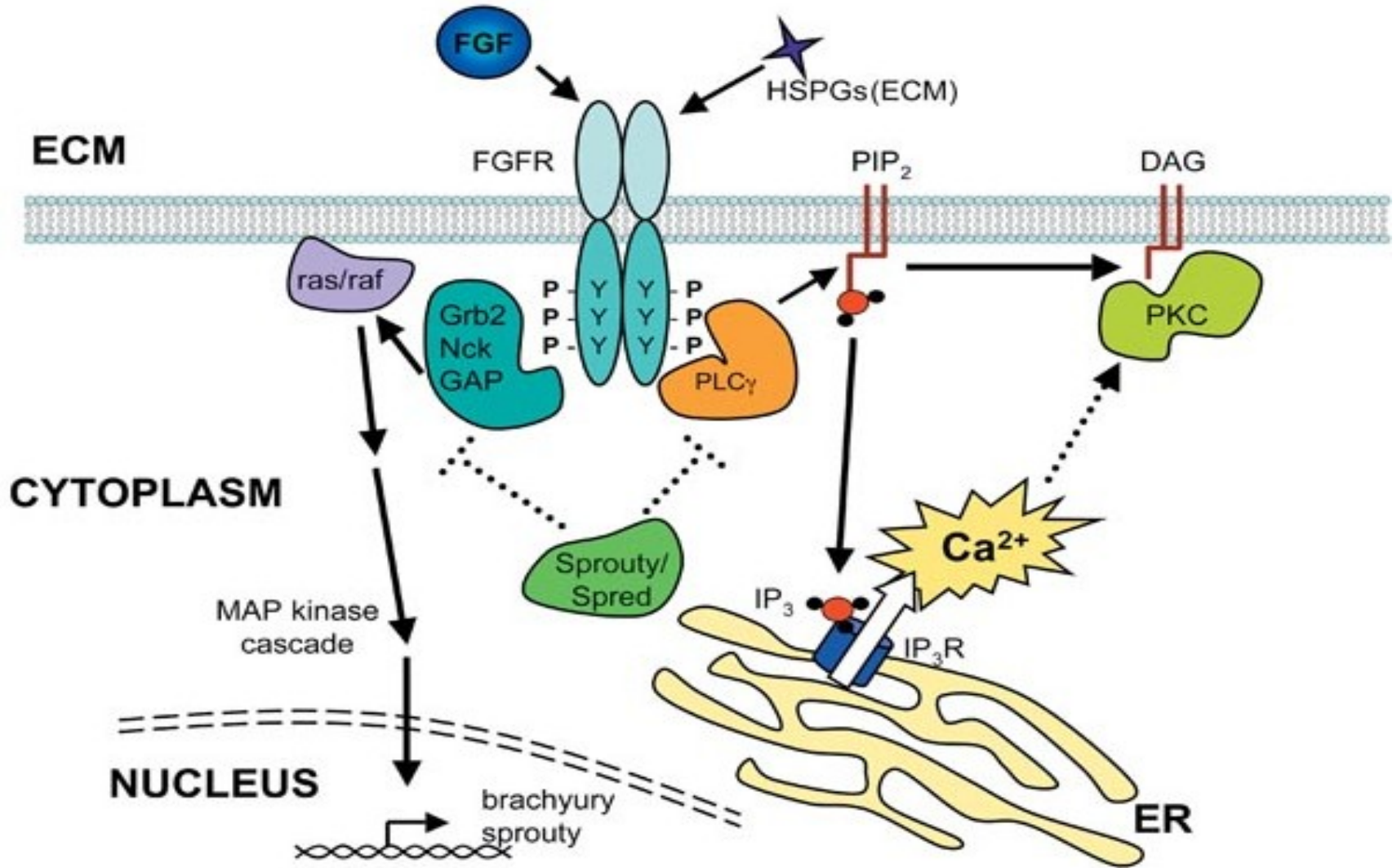

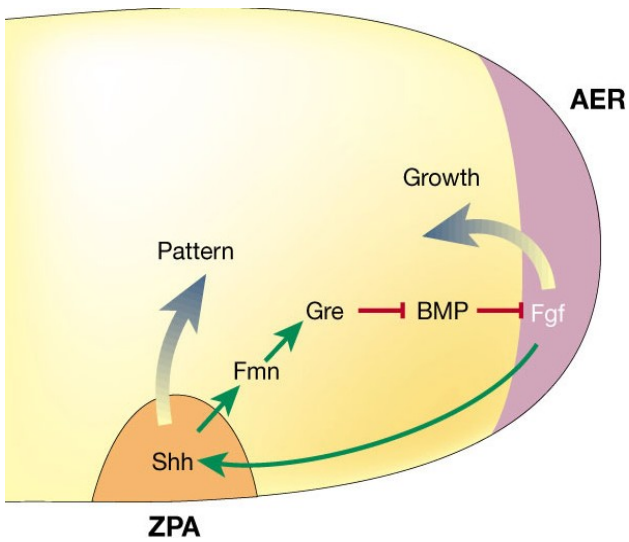

Initiation: *Tbx5* - dependent

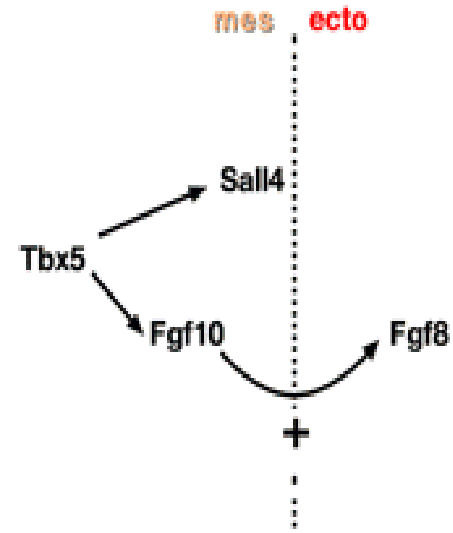
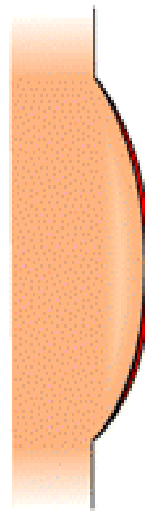

A Induction

B Progression

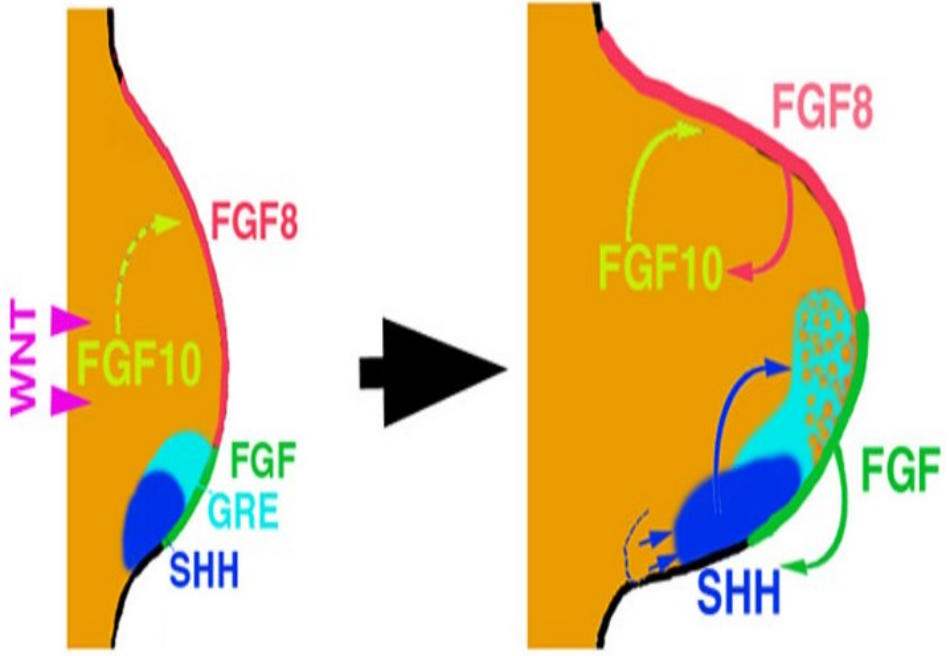

Outgrowth: *Tbx5* - independent

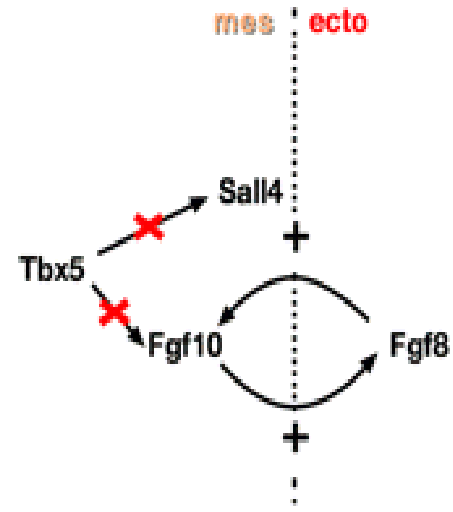
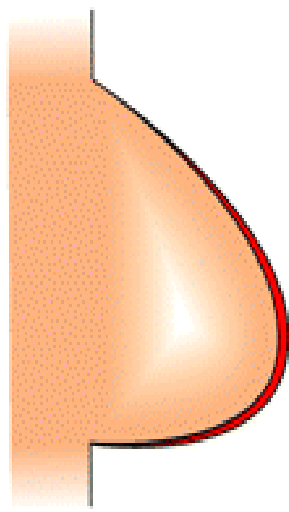

wt

Fgf10^{-/-}

wt

Fgf10^{-/-}

c

d

e

f

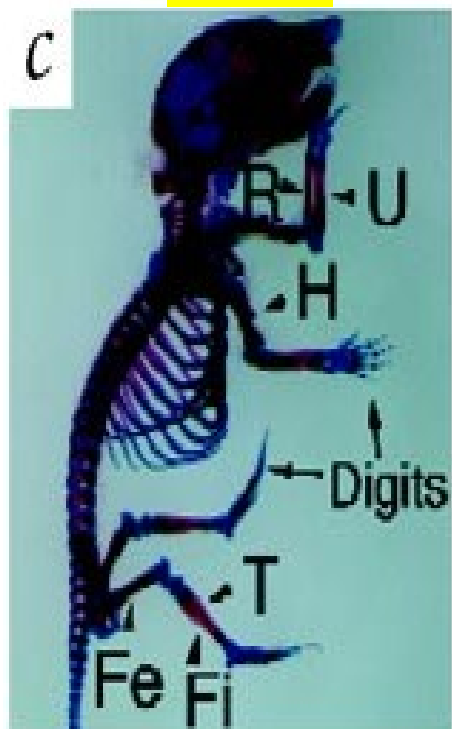

AER

k

l

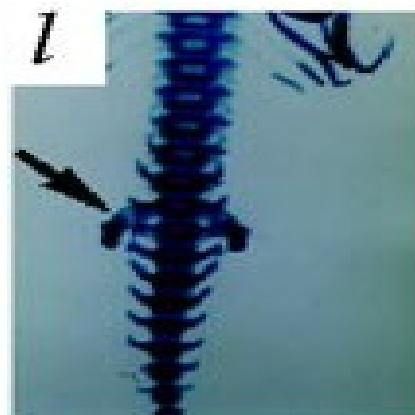
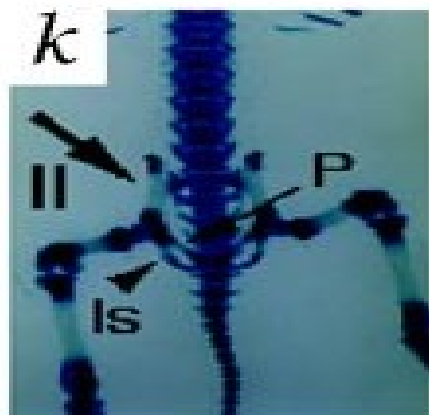

wt

Hindlimb

Fgf8/Fgf4^{-/-}

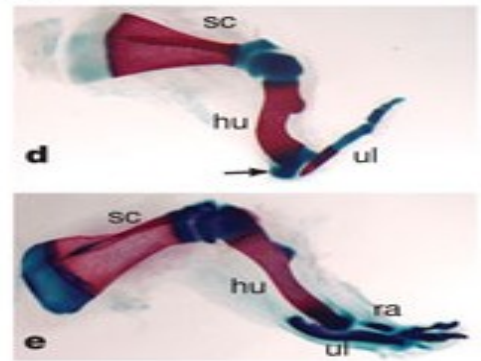
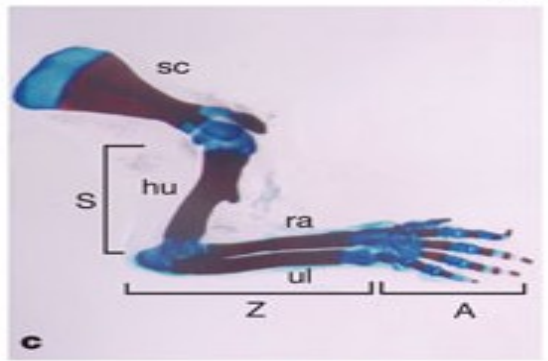
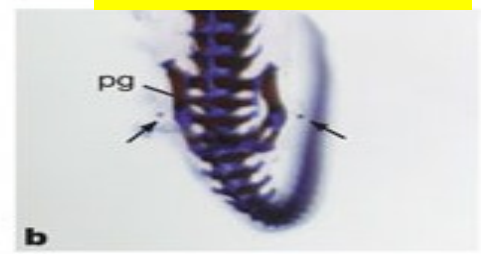
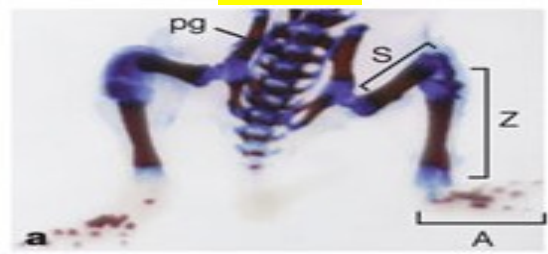

Double KO
 No *Fgf8* expression
 No *Fgf4* expression

Transient *Fgf8* expression
 Precocious, transient *Fgf4* expression

wt

Hindlimb

Fgf8/Fgf4^{-/-}

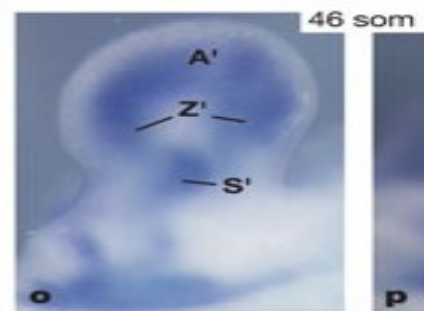
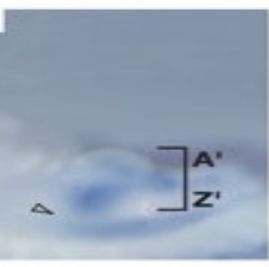
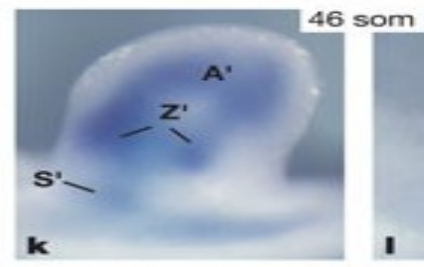

a Normal FL and HL

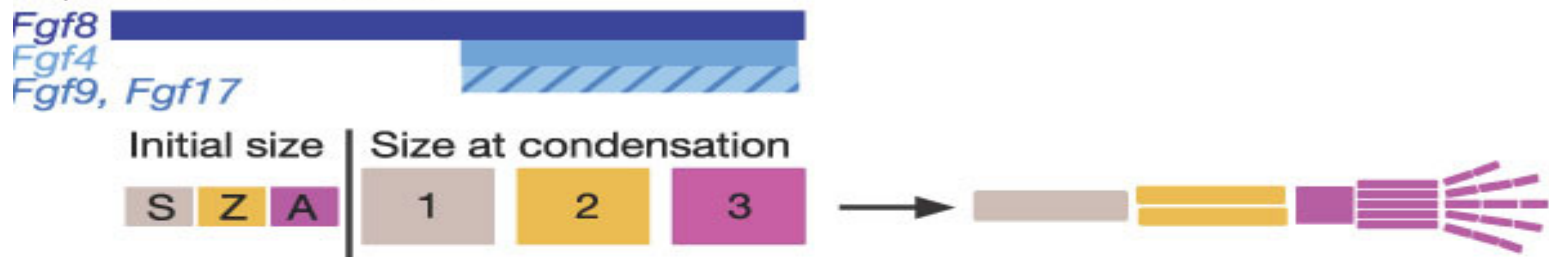

AER KO mutant phenotypes

b *Fgf8* single KO FL

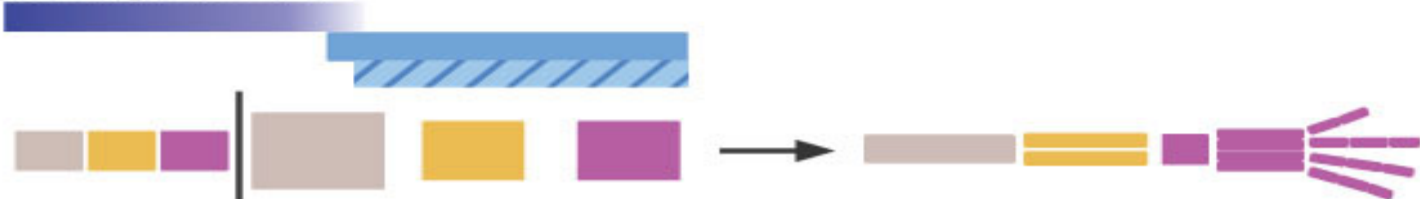

c *Fgf4; Fgf8* double KO FL



d *Fgf8* single KO HL



e *Fgf4; Fgf8* double KO HL



How do the limbs grow?

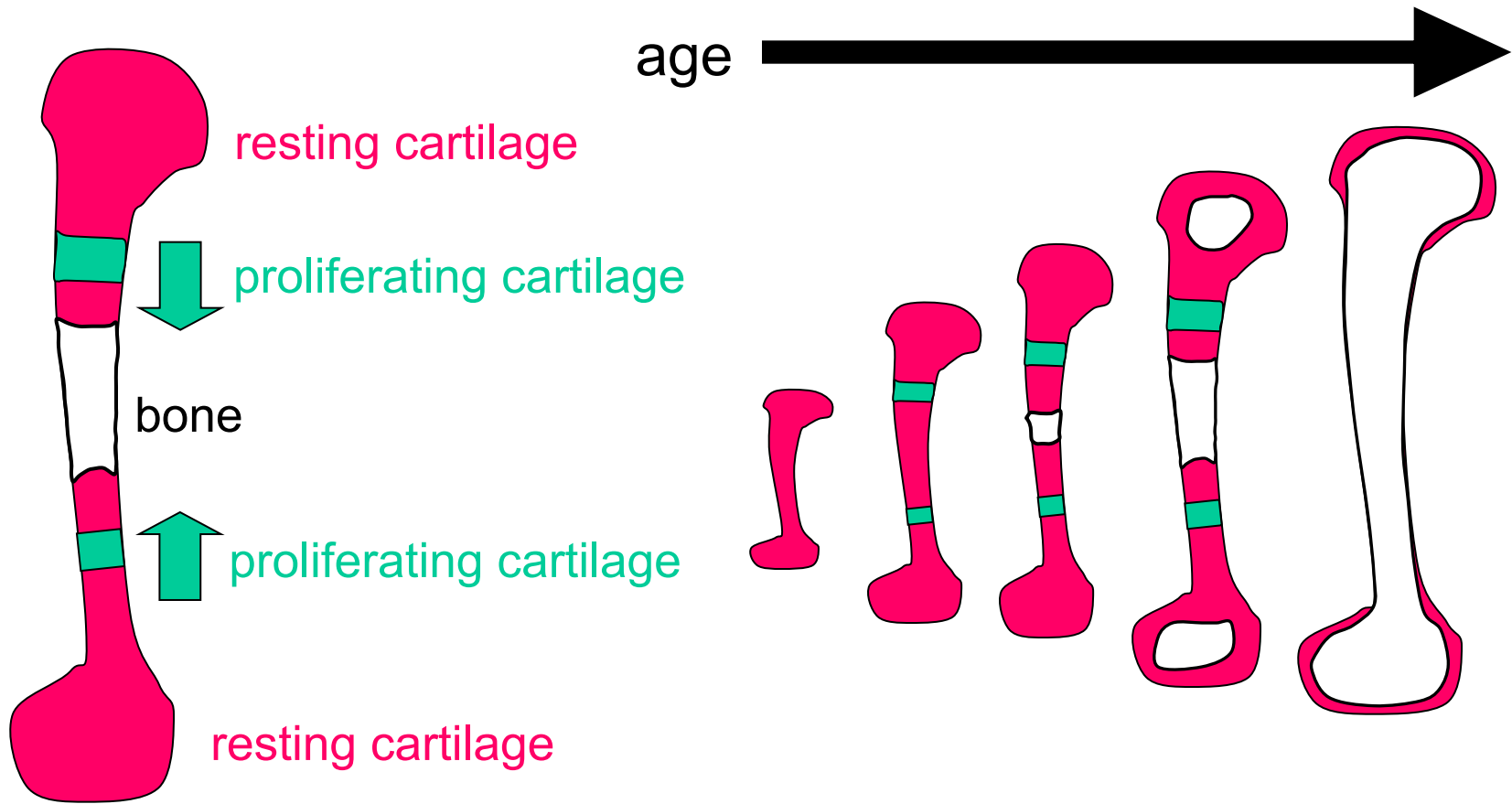

FGFR3



Tyrosine Kinase Group

Tyrosine Kinase Like Group

Group of Homologs of Yeast Sterile Protein Kinases

Casein Protein Kinases

PKA, PKG & PKC Containing Group

Calcium/Calmodulin Dependent Protein Kinase Group

CDK, MAP, GSK3 & CLK Containing Group

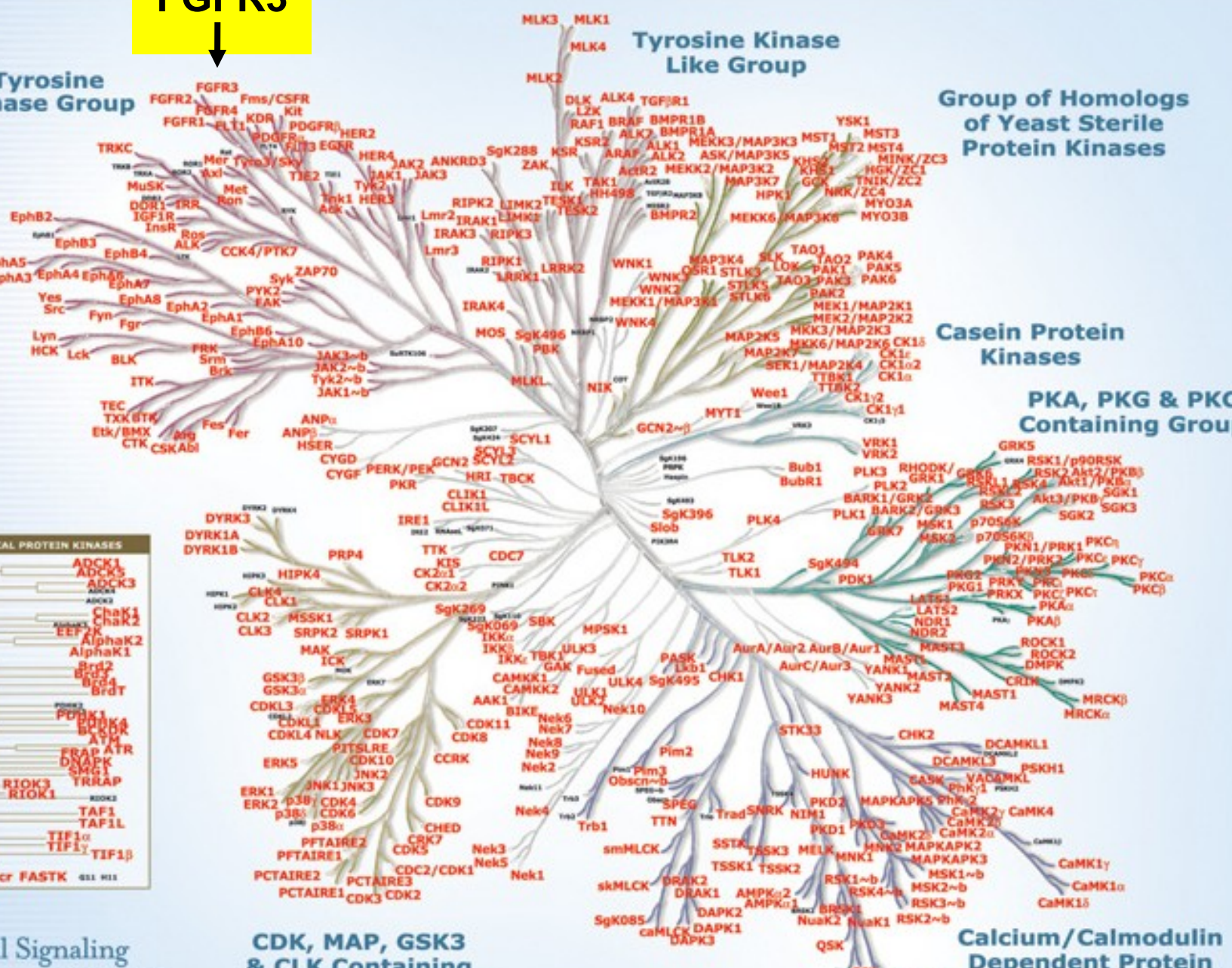
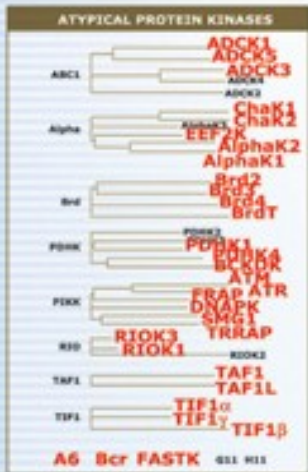

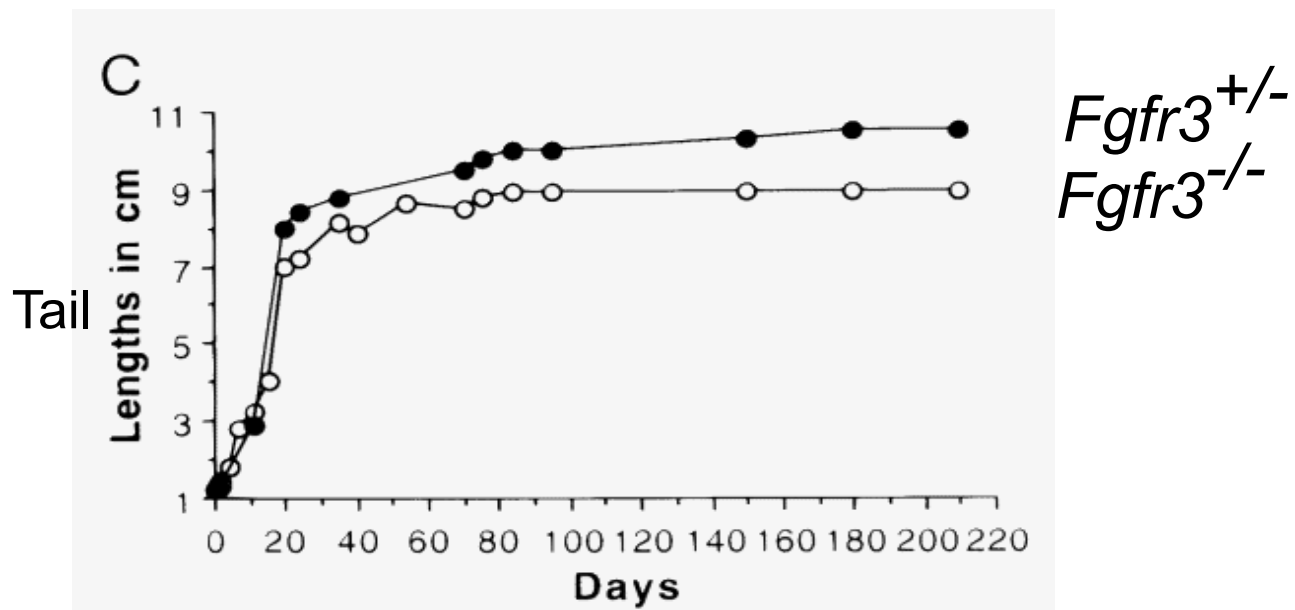
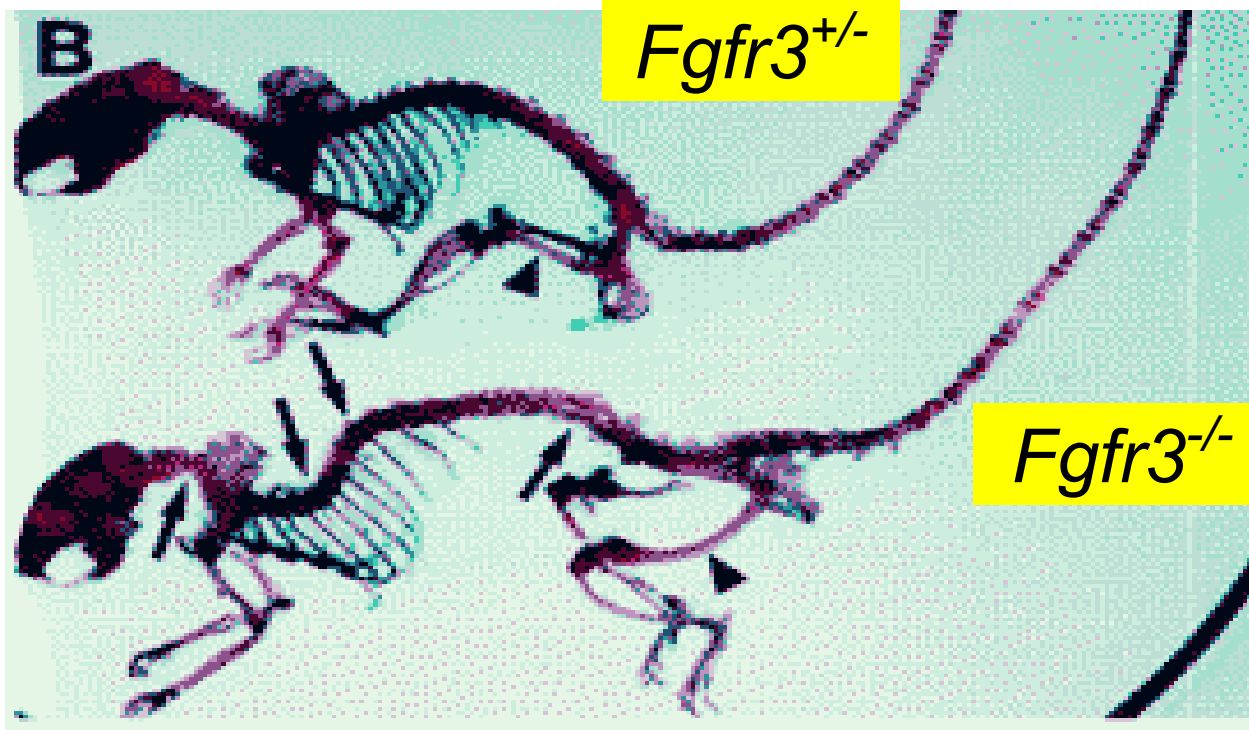

FGFR3-related skeletal dysplasia

Hypochondroplasia
Achondroplasia
SADDAN
Thanatophoric Dysplasia

STATURE

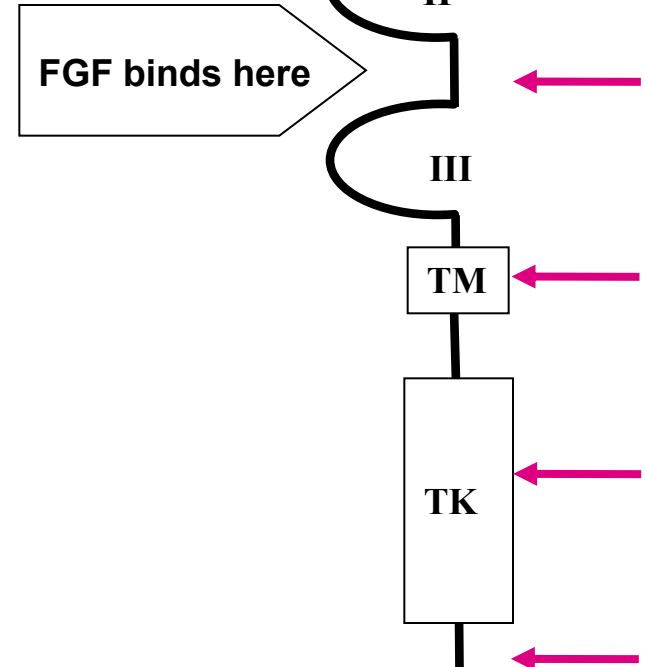

FGFR3-related skeletal dysplasia



Achondroplasia

Thanatophoric Dysplasia



healthy

- short long bones
- brachydactyly
- macrocephaly

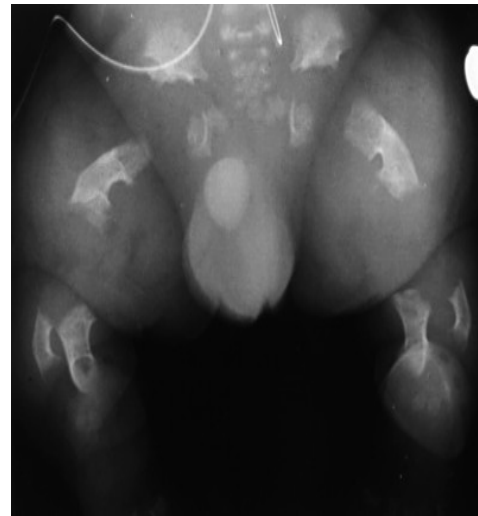
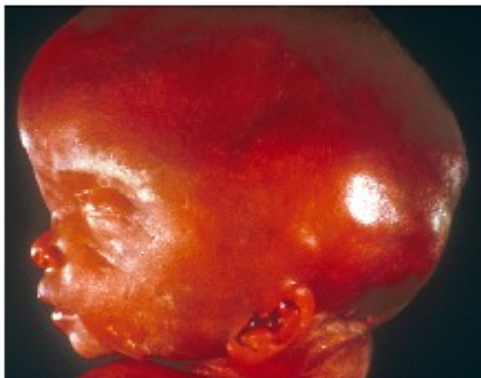

TD

- low nasal bridge
- spinal stenosis
- temporal lobe malformations

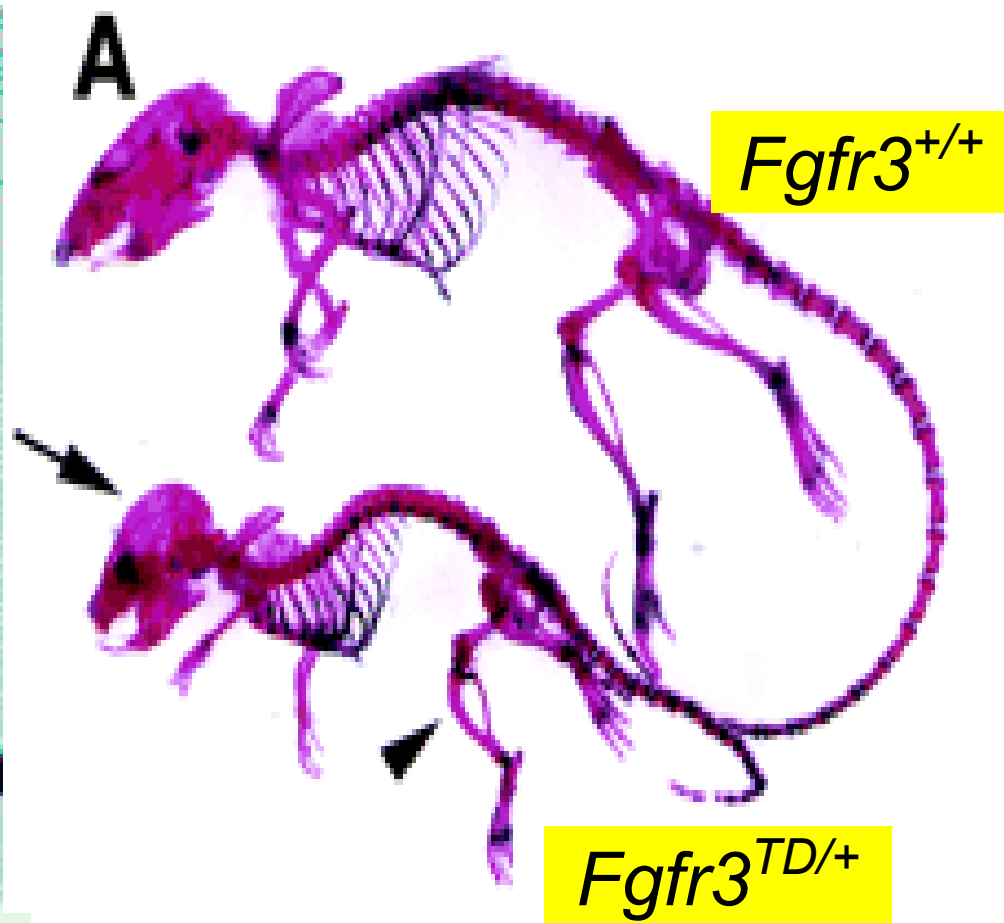
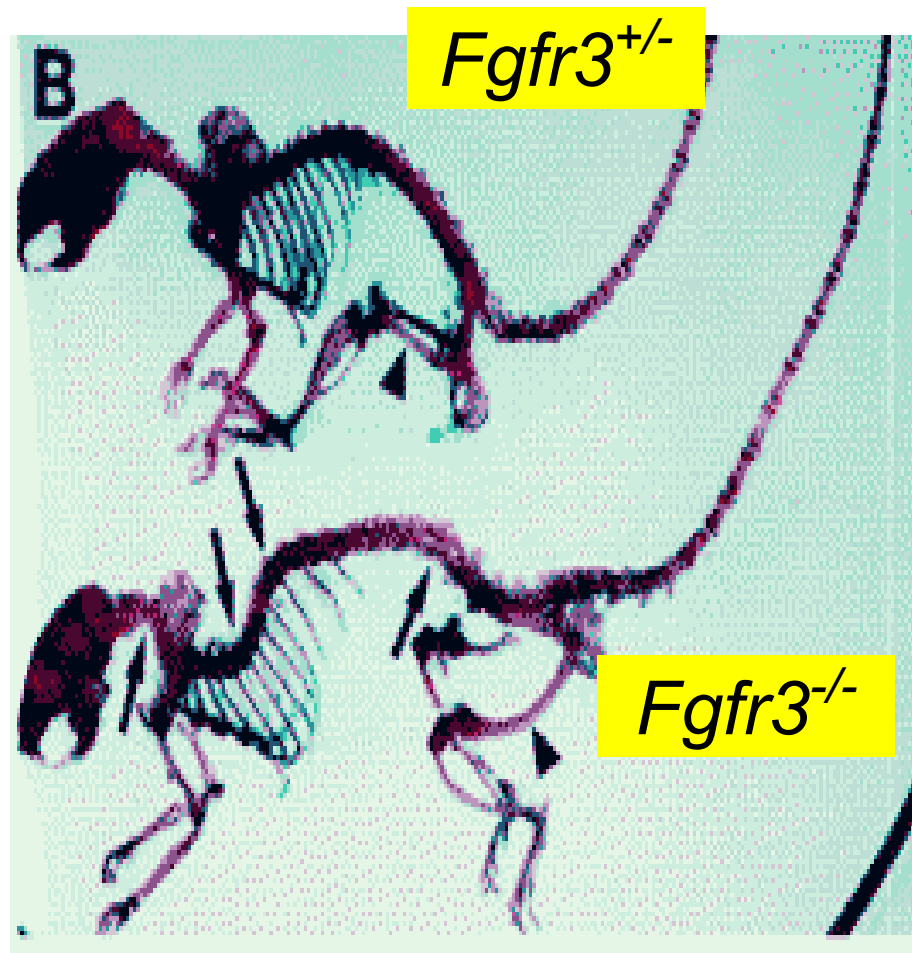

Loss-of-function

vs. Gain-of-function

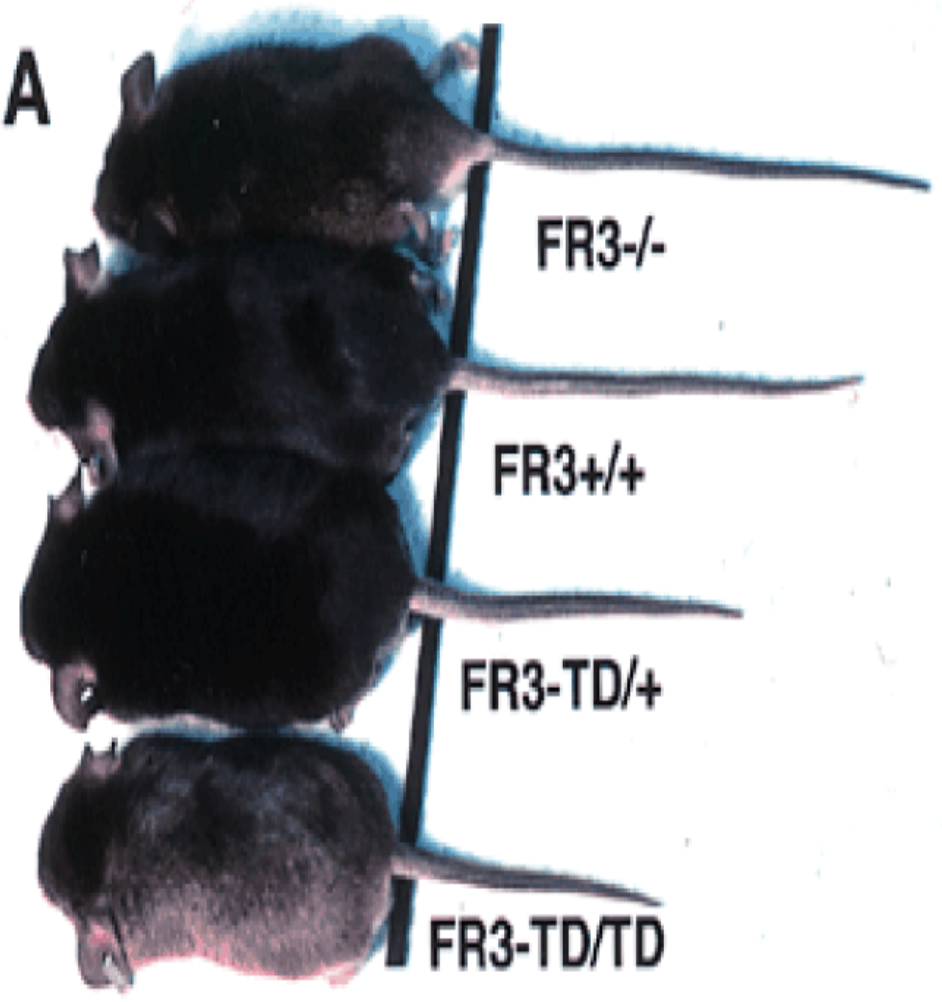
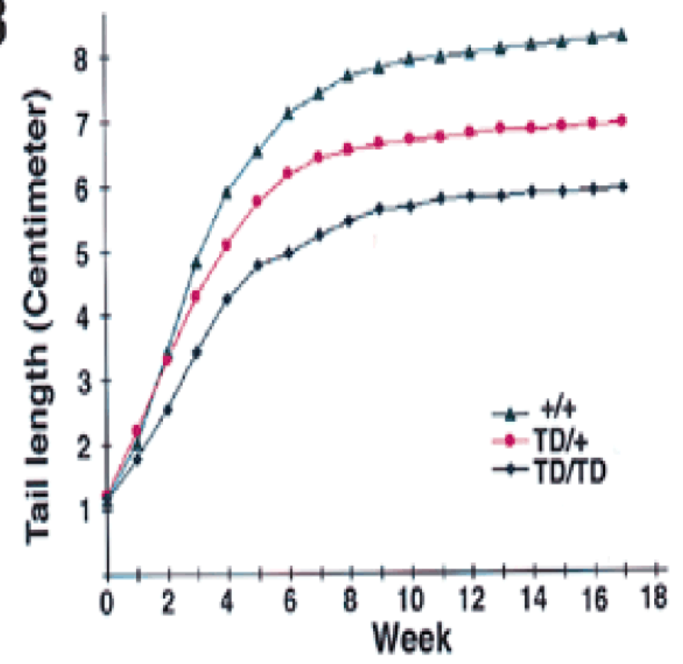
A**B**

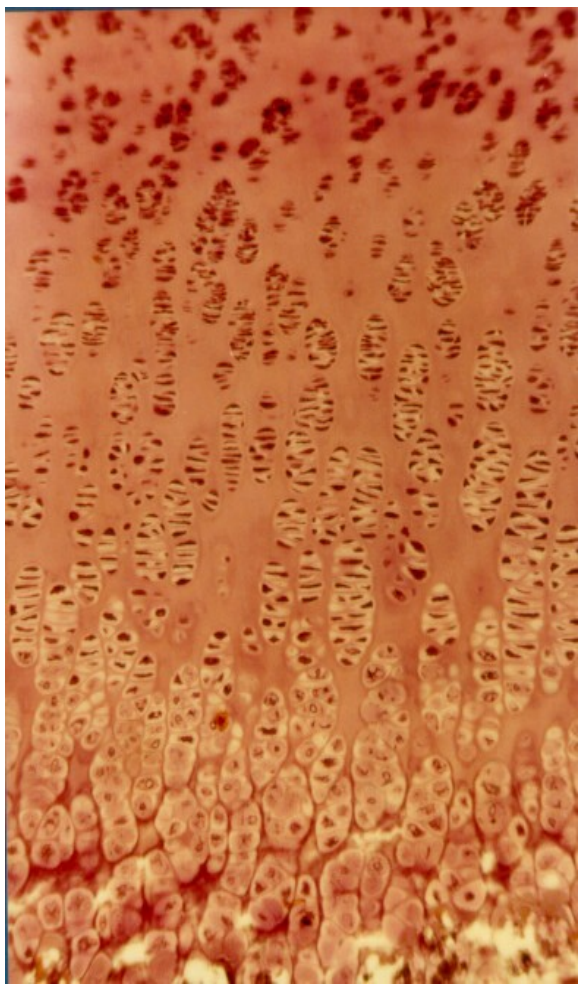
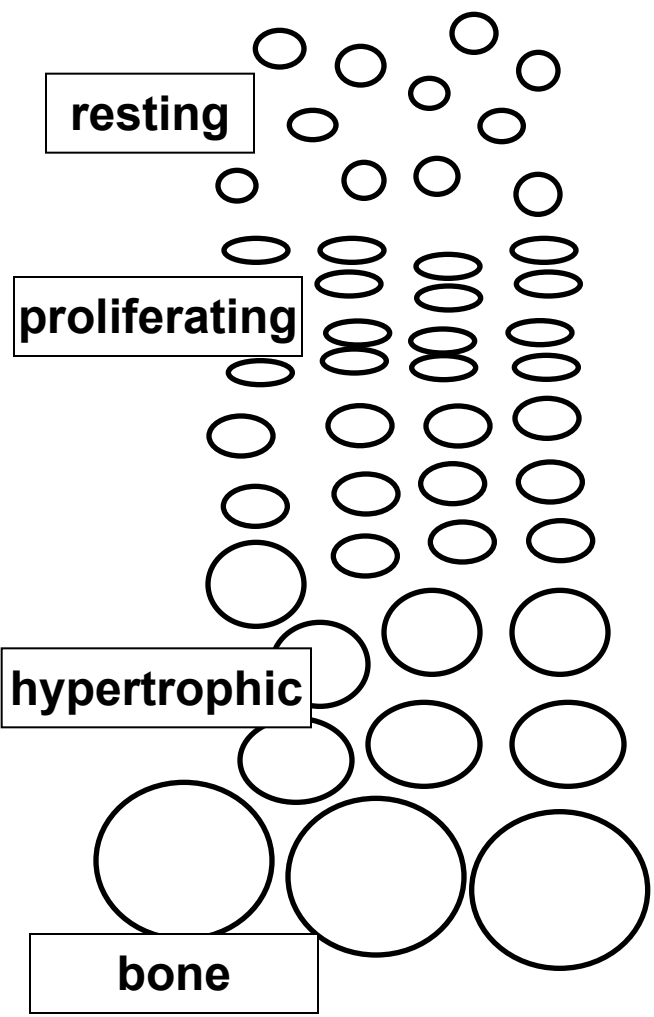

healthy

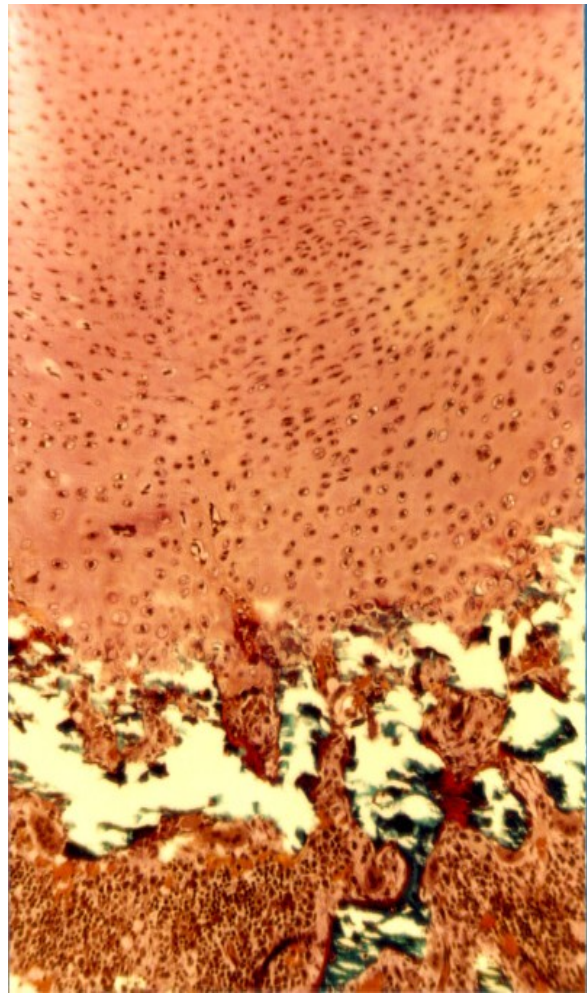

TD

FGFR3 inhibits chondrocyte proliferation by arresting their cell cycle in G1 phase

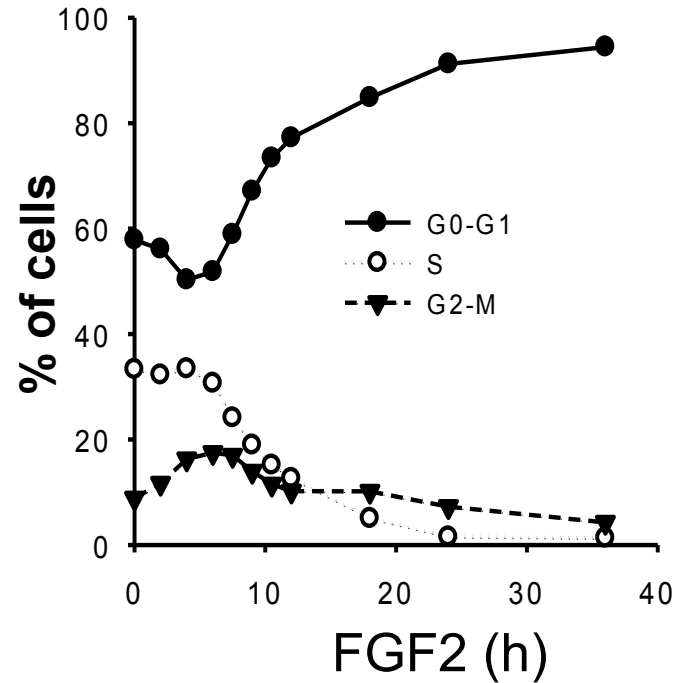
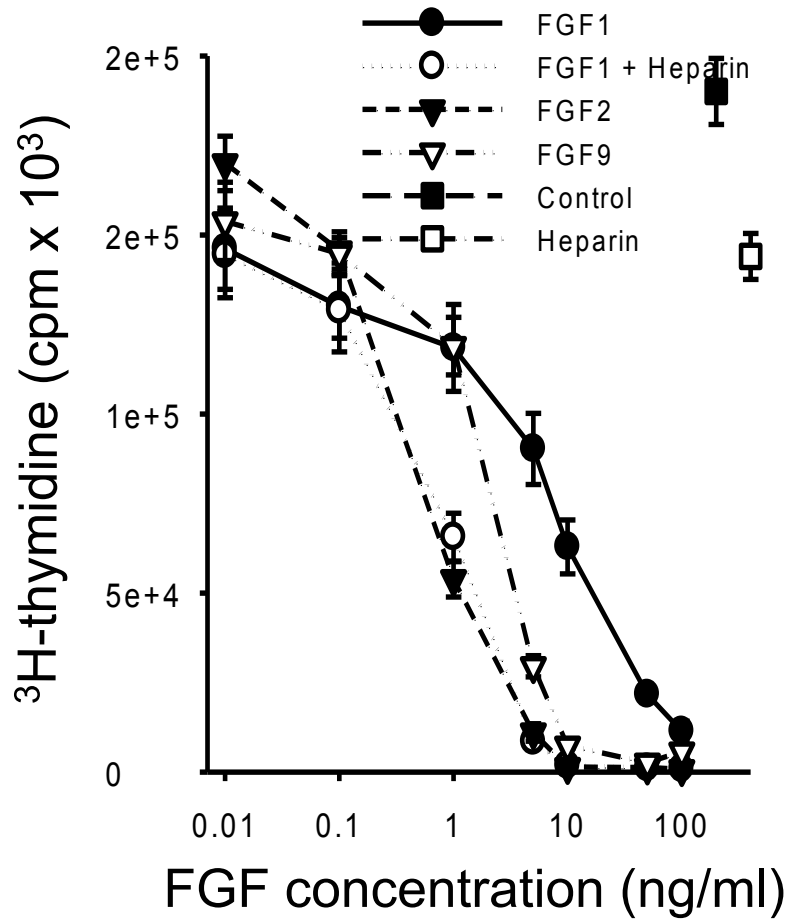

....via inhibition of cdk activity necessary for progression through the G1 phase of a cell cycle

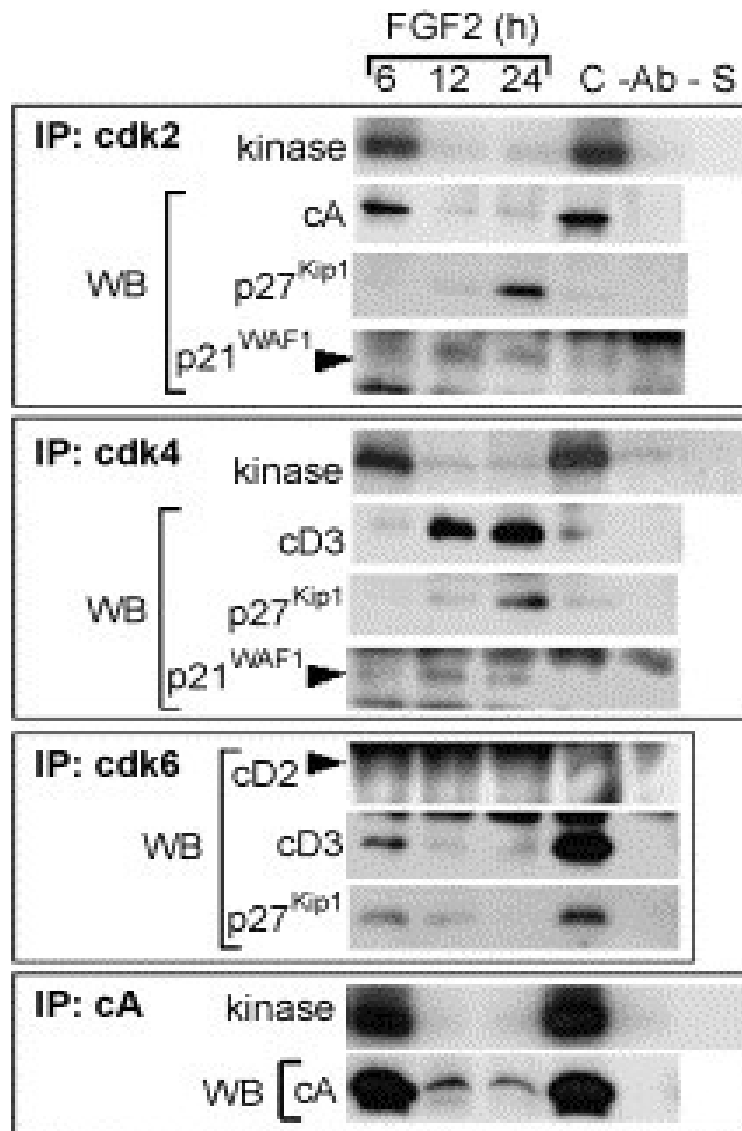
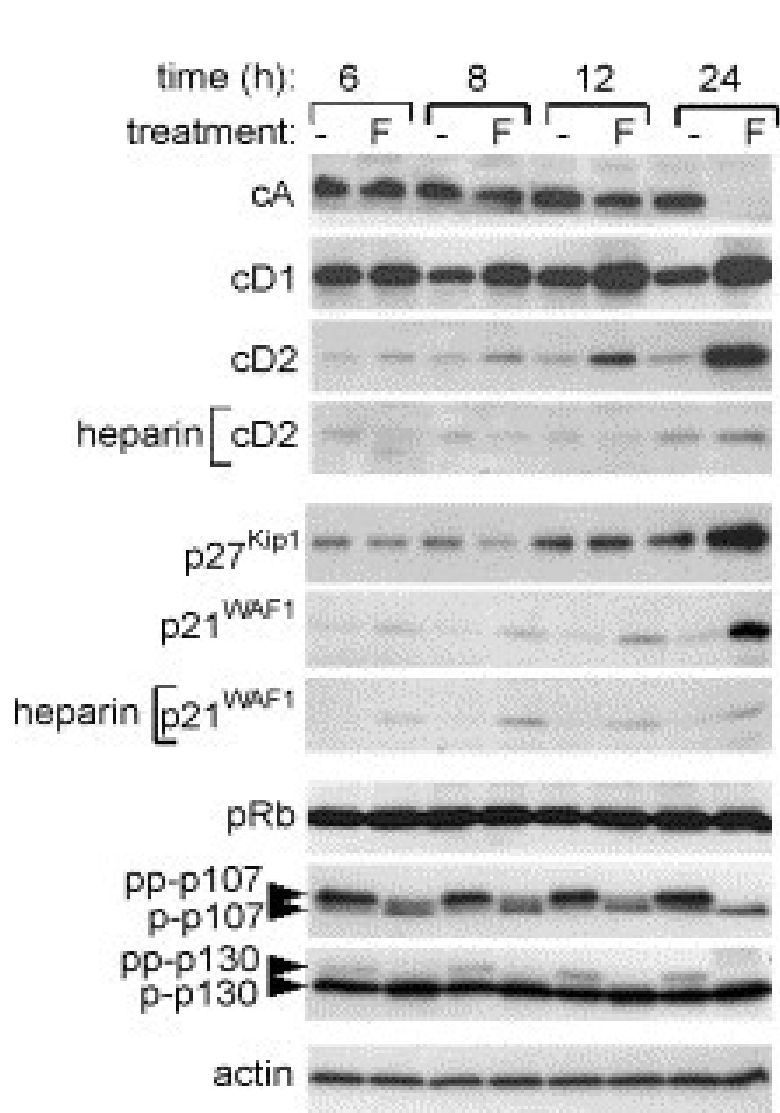

FGF alters the cartilage-like phenotype of chondrocytes

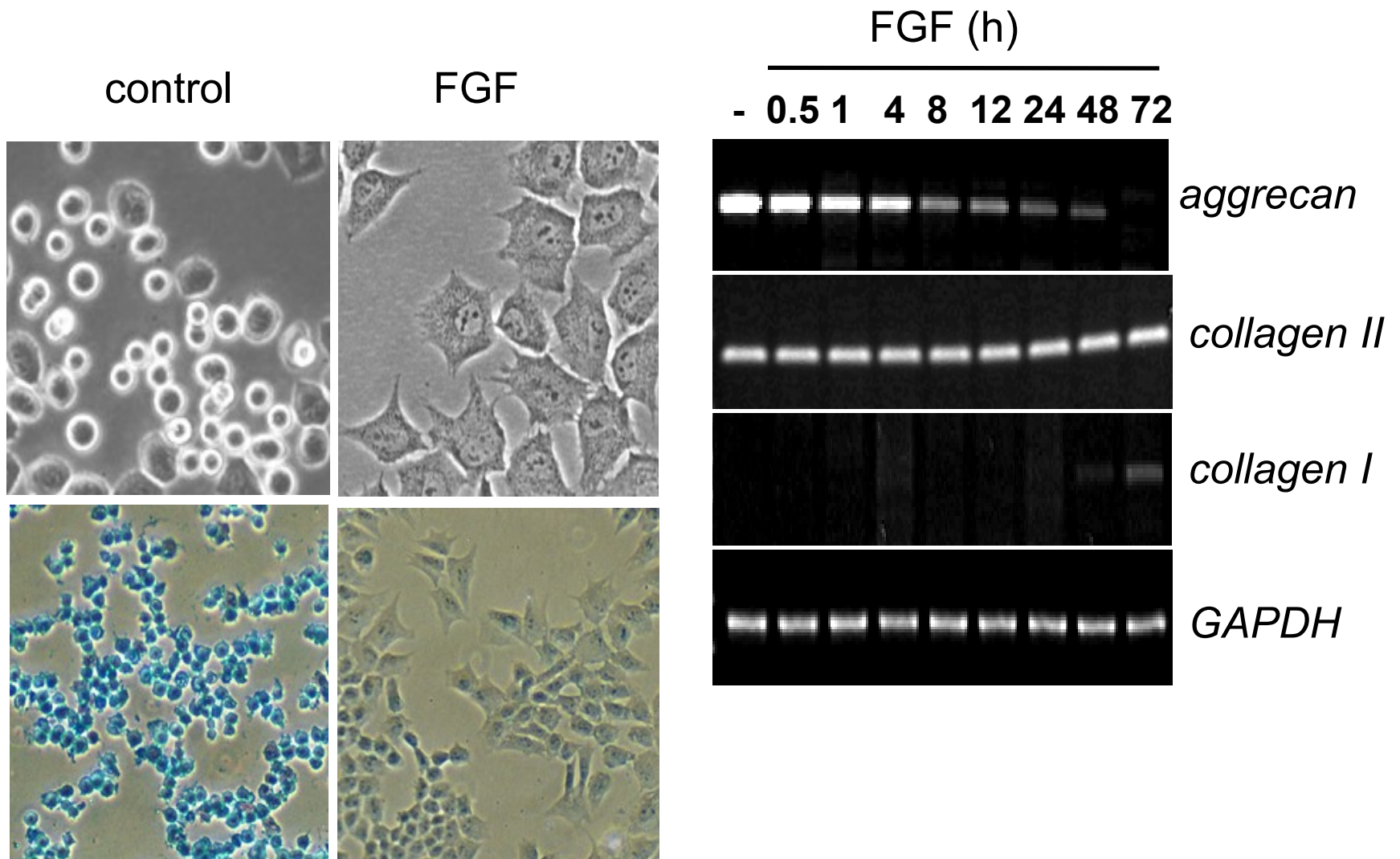

.....via MMP-mediated degradation of extracellular matrix

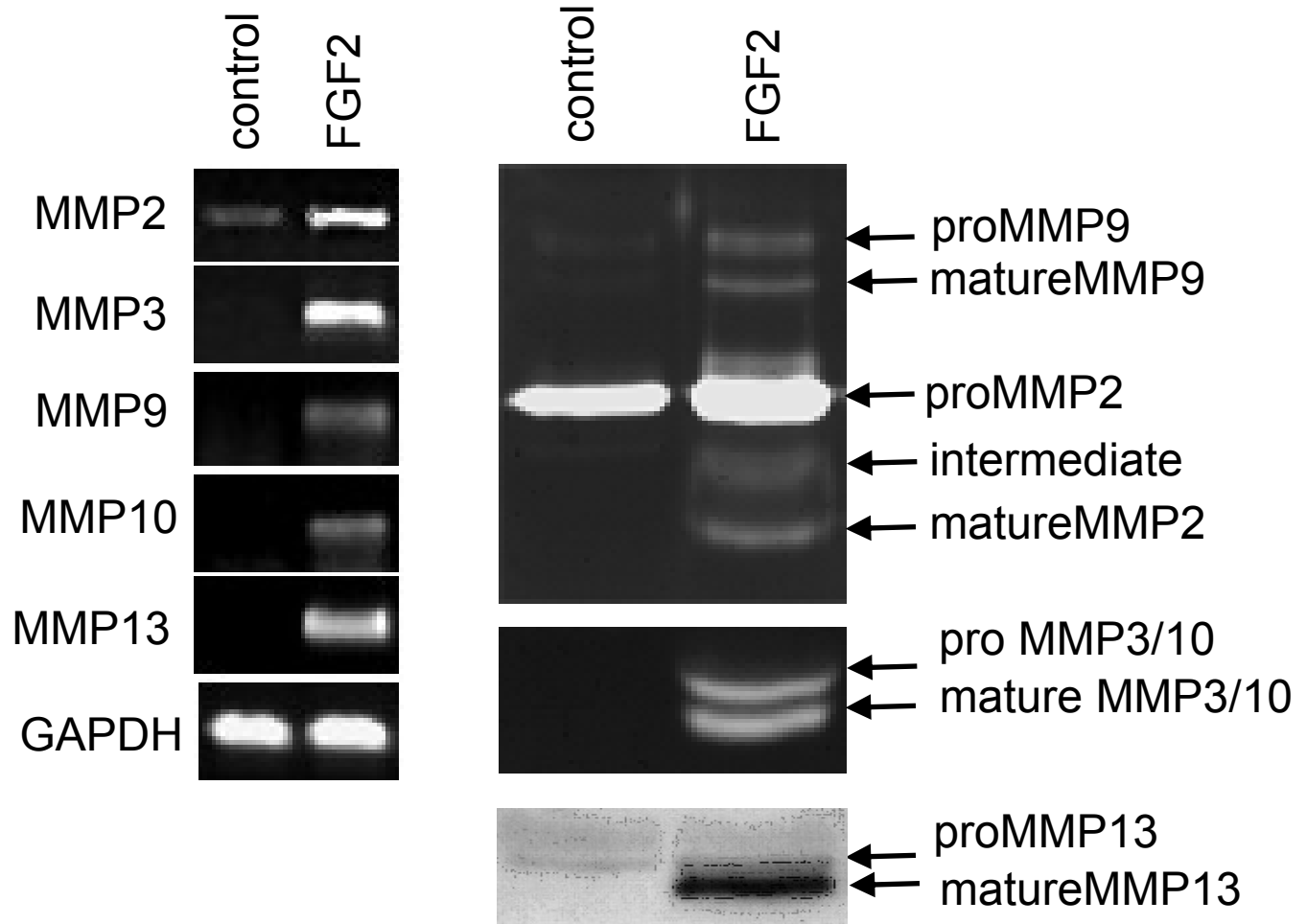

FGF2 activates Erk and p38 MAPK, PLC γ and PKB in chondrocytes

FGF2

C1 C2 1' 5' 10' 30' 1h 2h 4h 8h

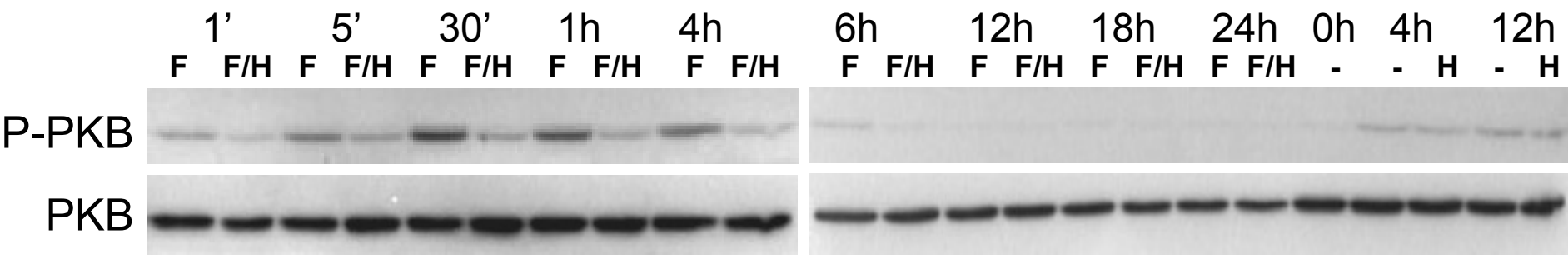
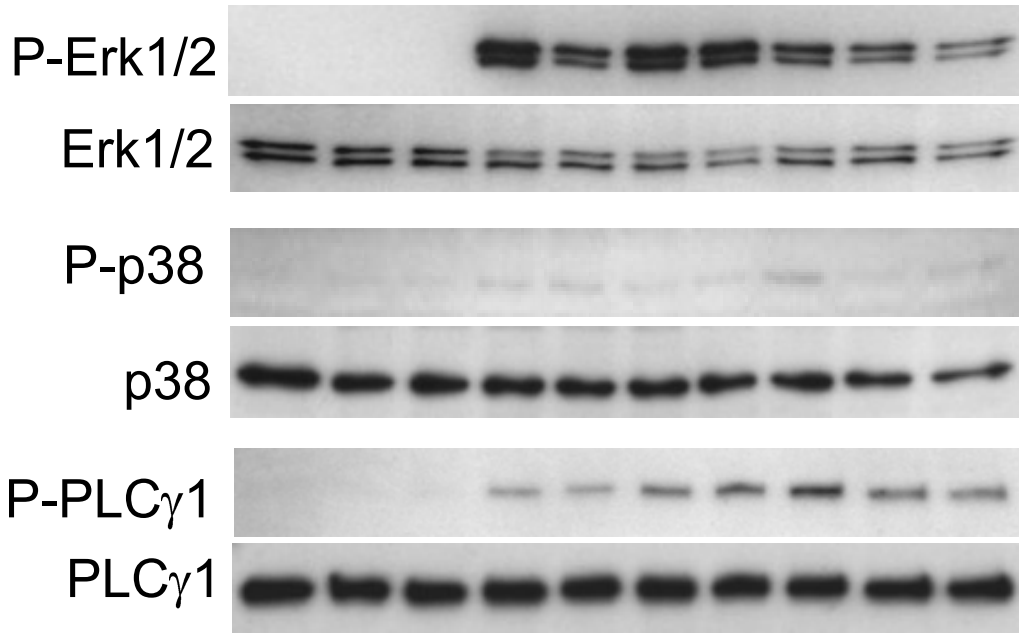

.....but only Ras/Erk activity is involved in FGF-induced growth arrest

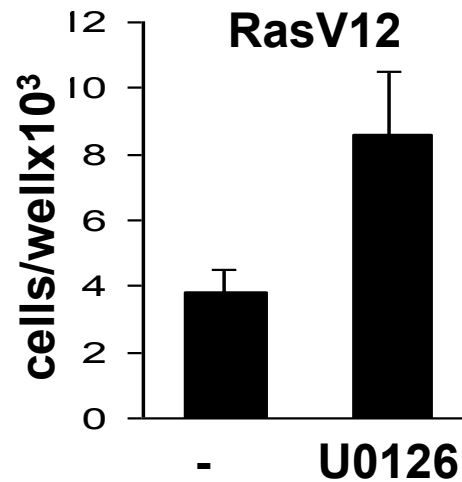
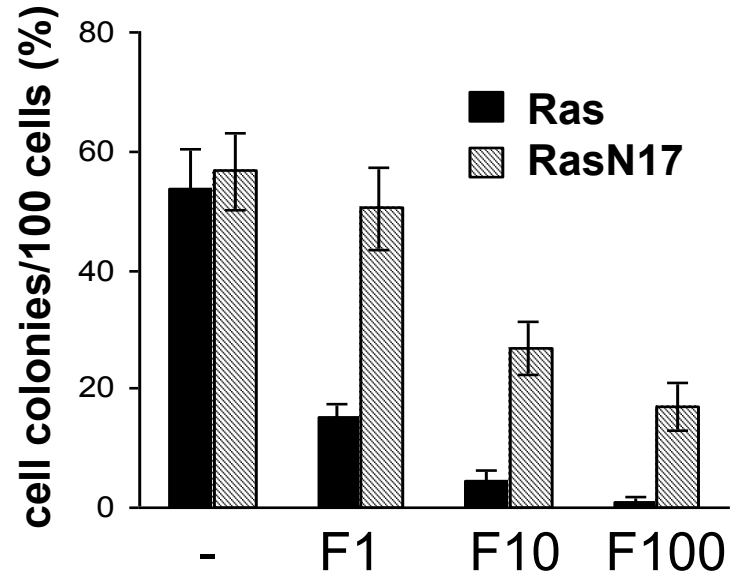
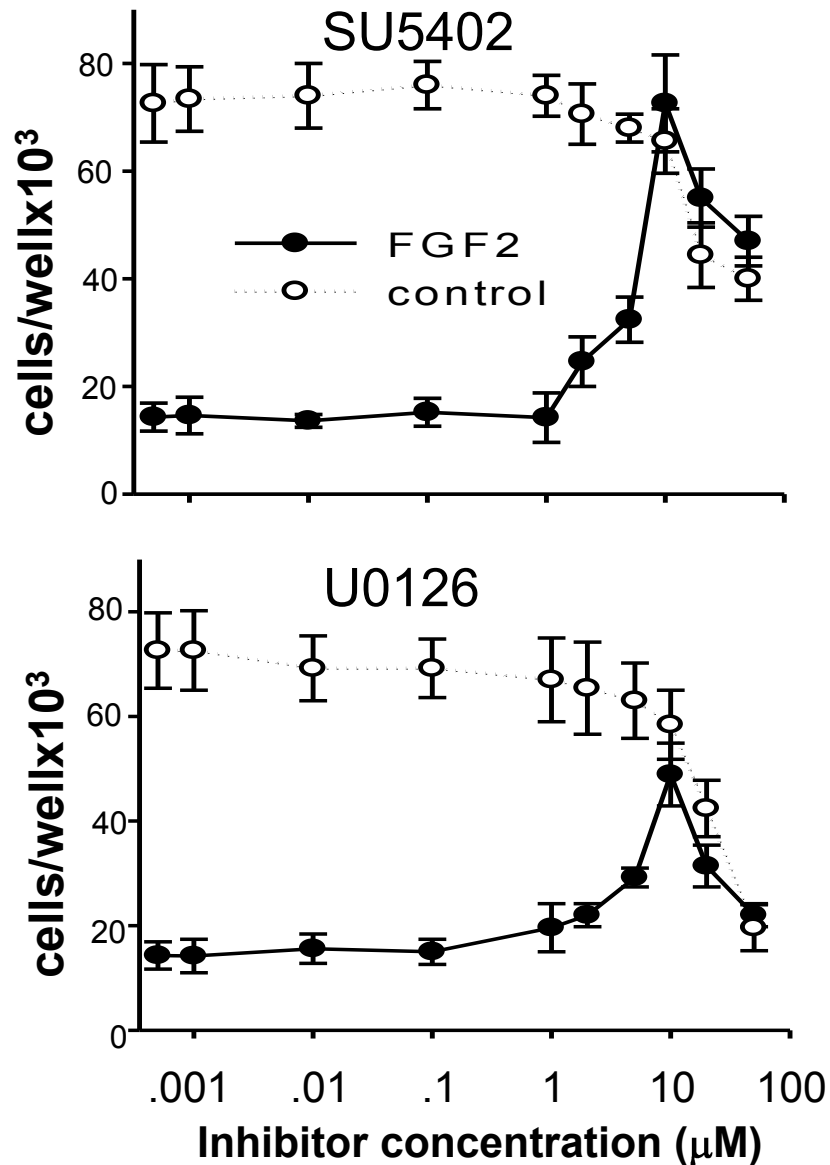

Erk MAP kinase activity is necessary for FGFR3 phenotype in cartilage

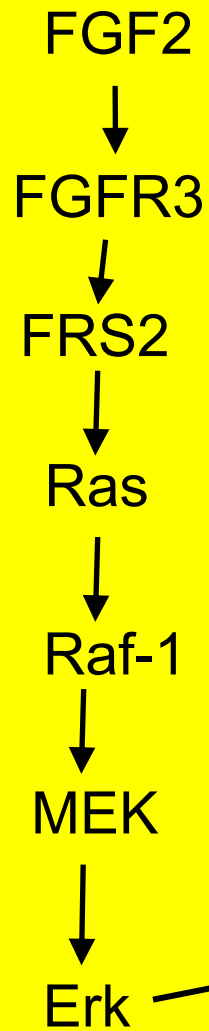

C-type Natriuretic Peptide (CNP) over-expression results in skeleton overgrowth in mice

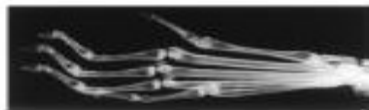

wild-type

CNP ↑

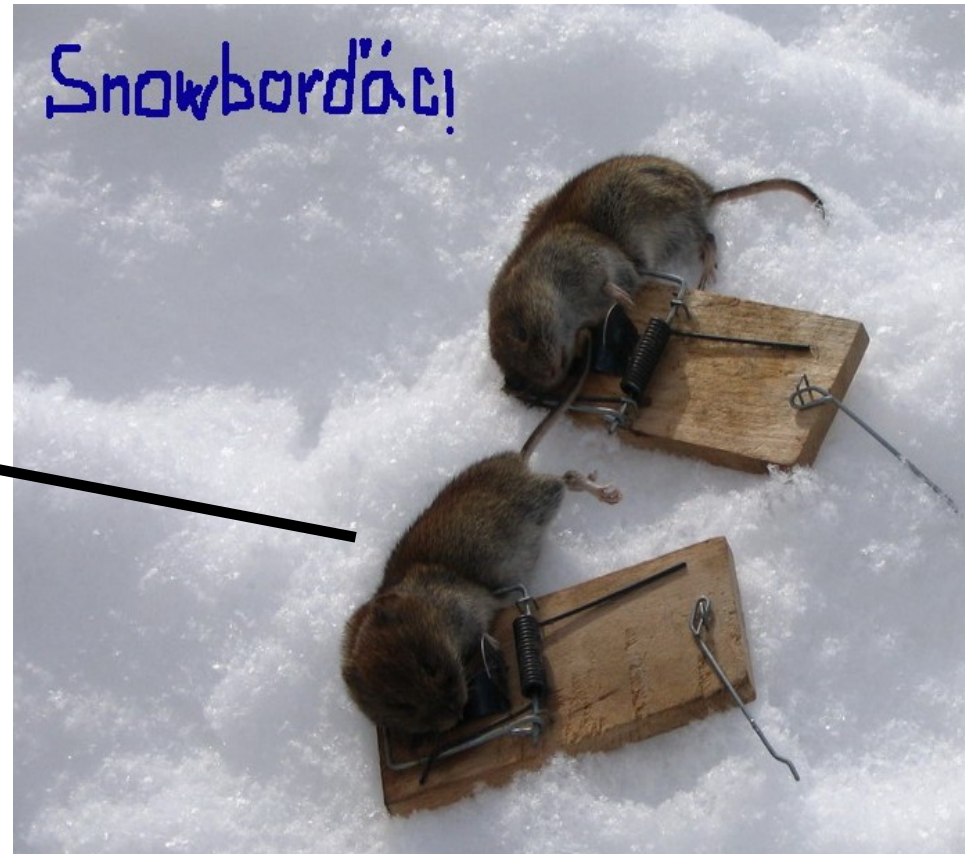

CNP over-expression???

CNP rescues dwarfism caused by ACH mutation in FGFR3

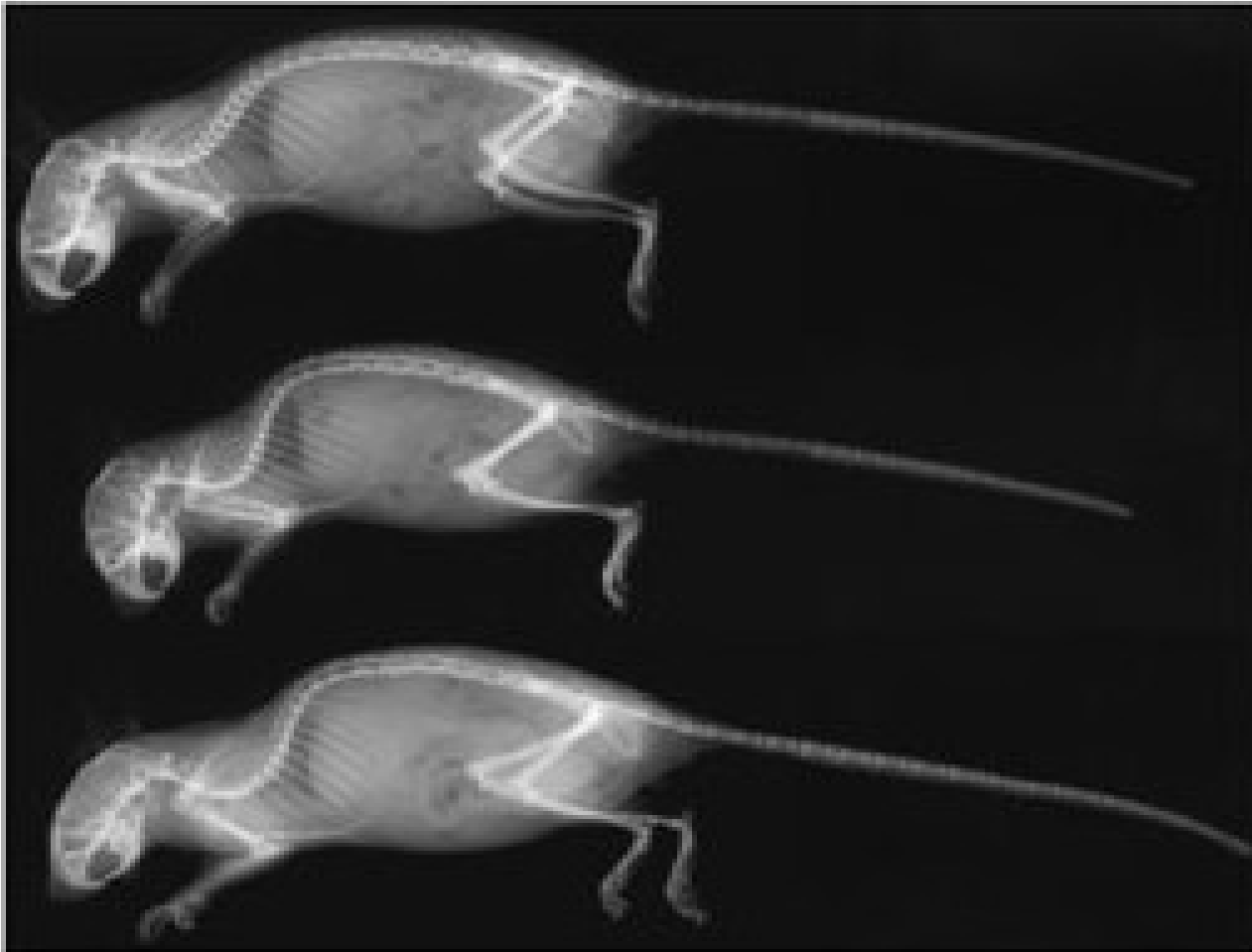

wild-type

$Fgfr3^{Ach}$

$Fgfr3^{Ach/CNP}$ ↑

CNP counteracts FGF2-mediated chondrocyte growth arrest through cGMP-dependent pathway

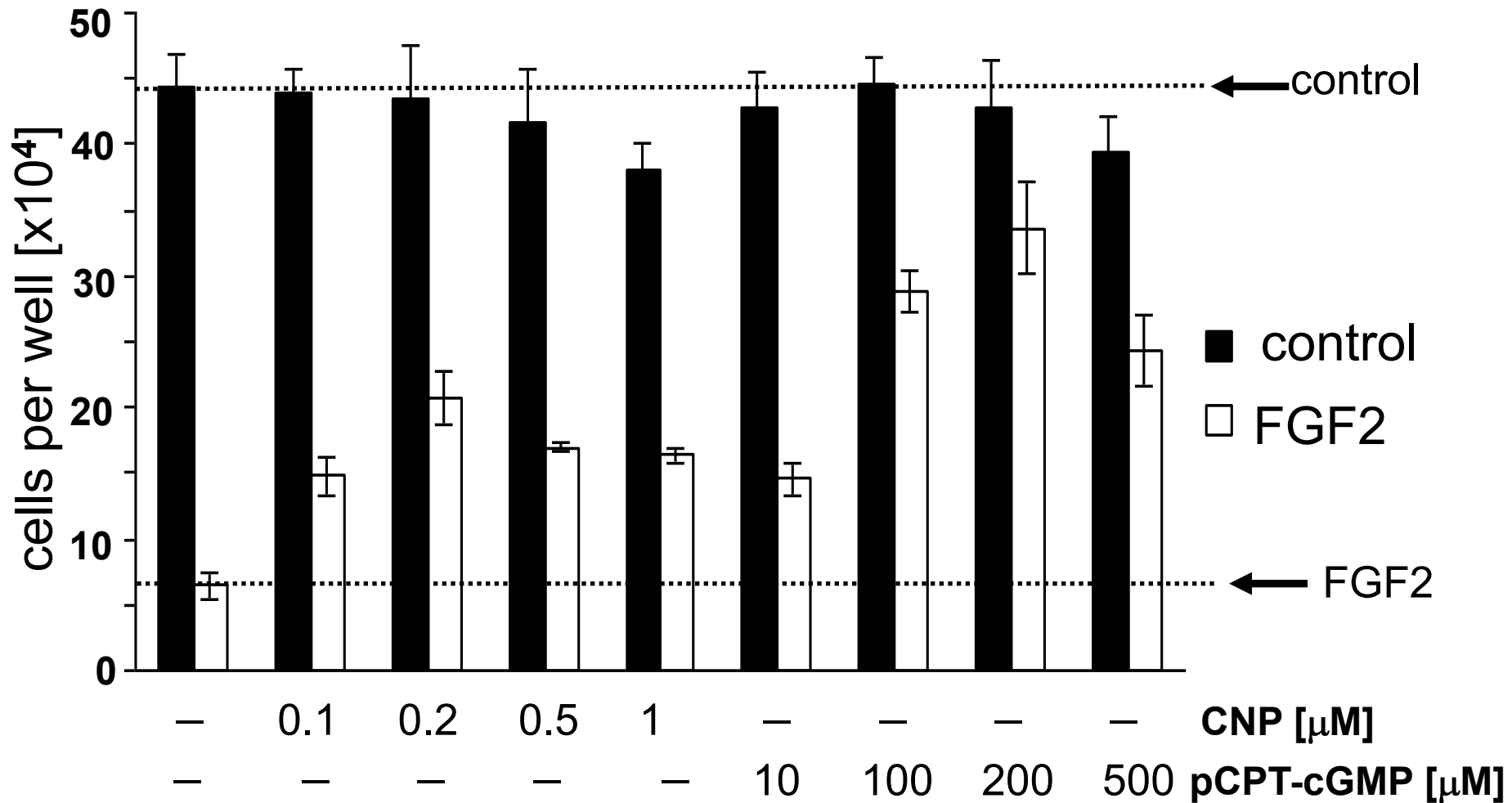

CNP antagonizes FGF2-mediated loss of cartilage extracellular matrix in chondrocytes

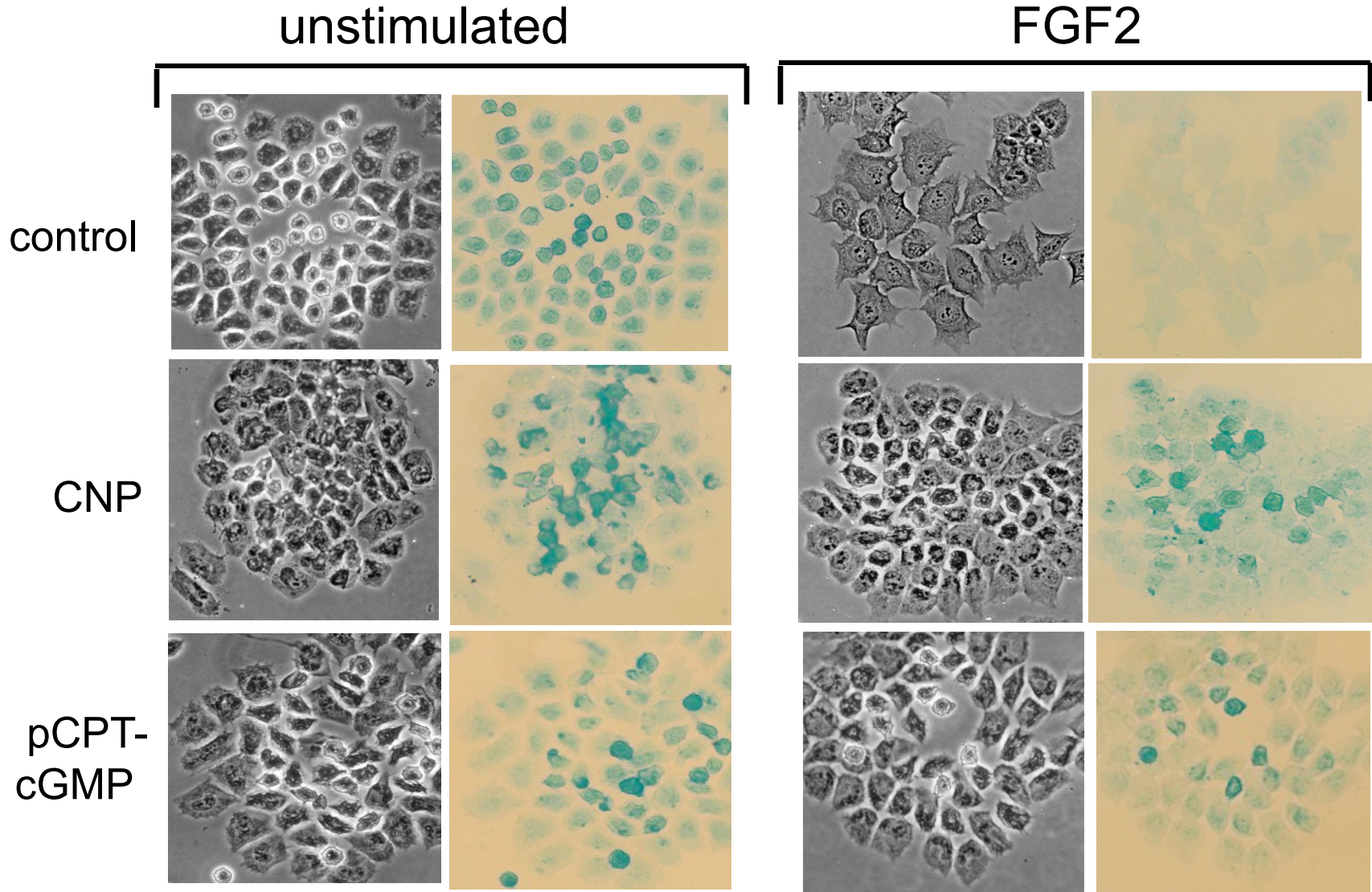

CNP counteracts FGF2-mediated activation of Erk MAP kinase in chondrocytes

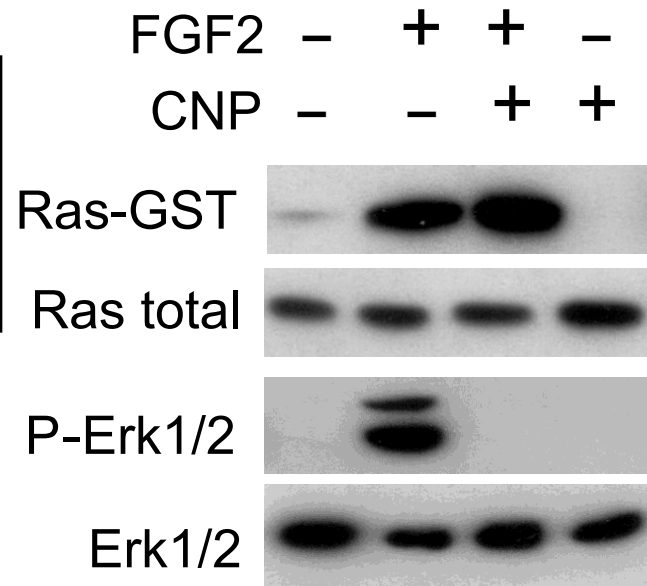
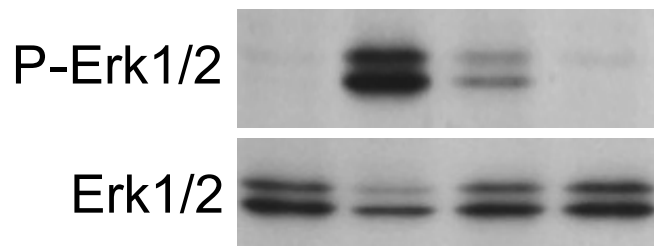
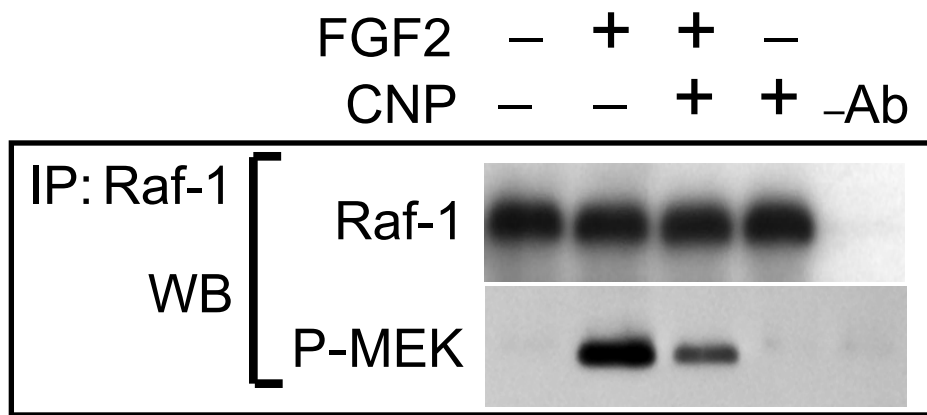
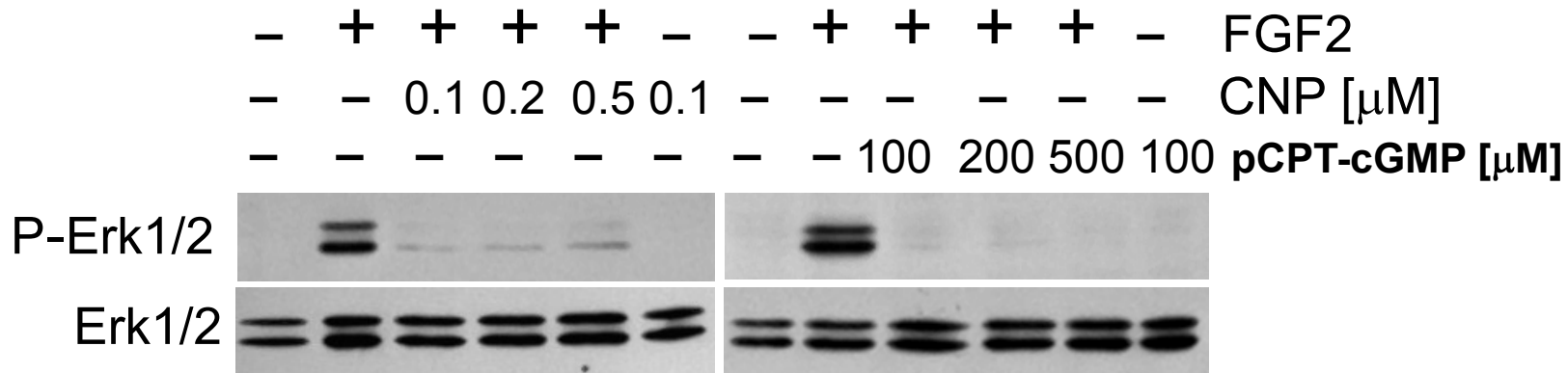
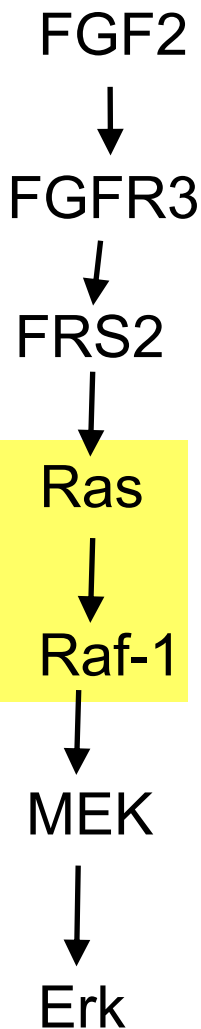

CNP inhibits Erk MAP kinase module at the Raf level

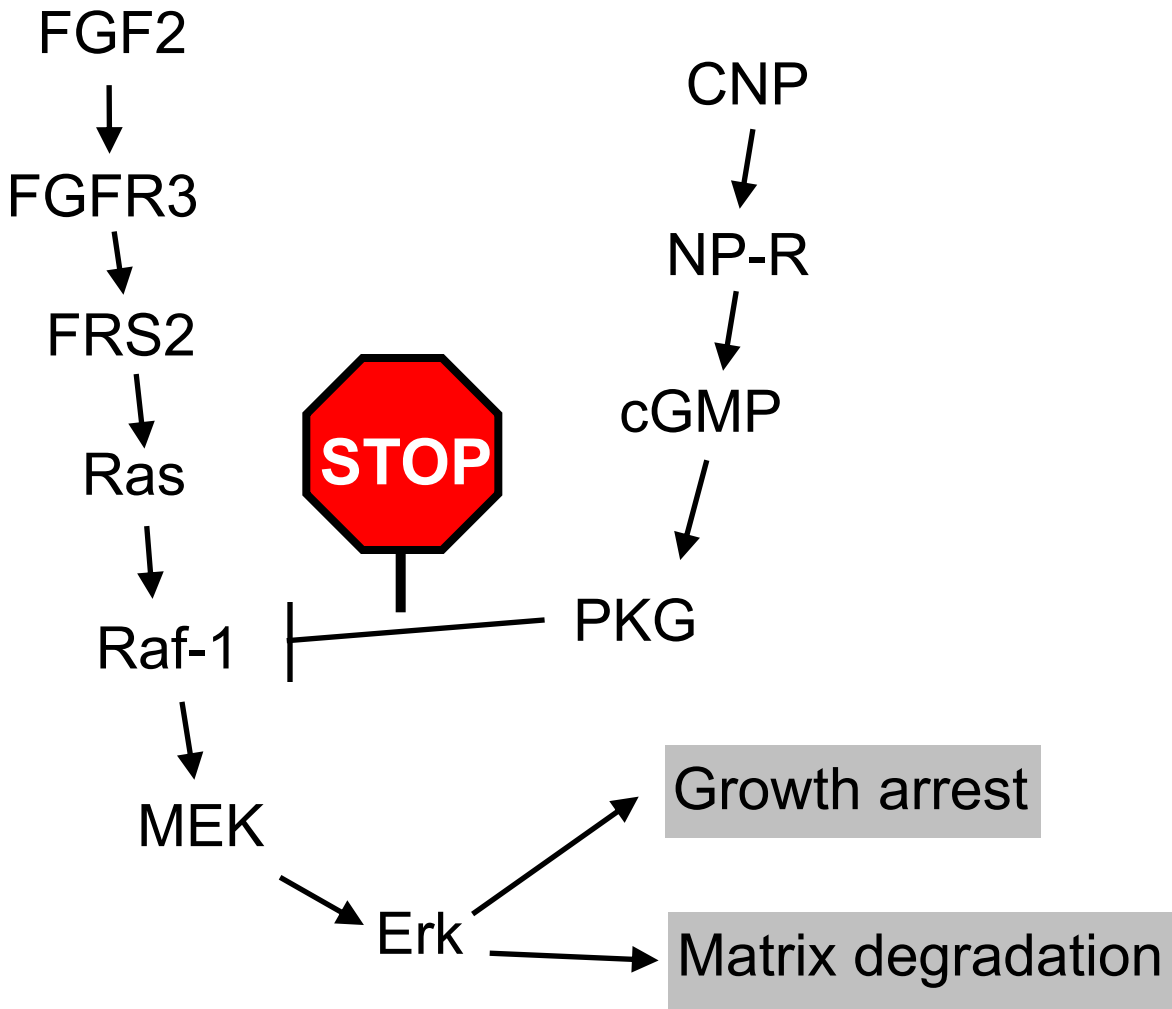

Is protein kinase C (PKC) involved in FGFR3-mediated activation of Erk in chondrocytes?

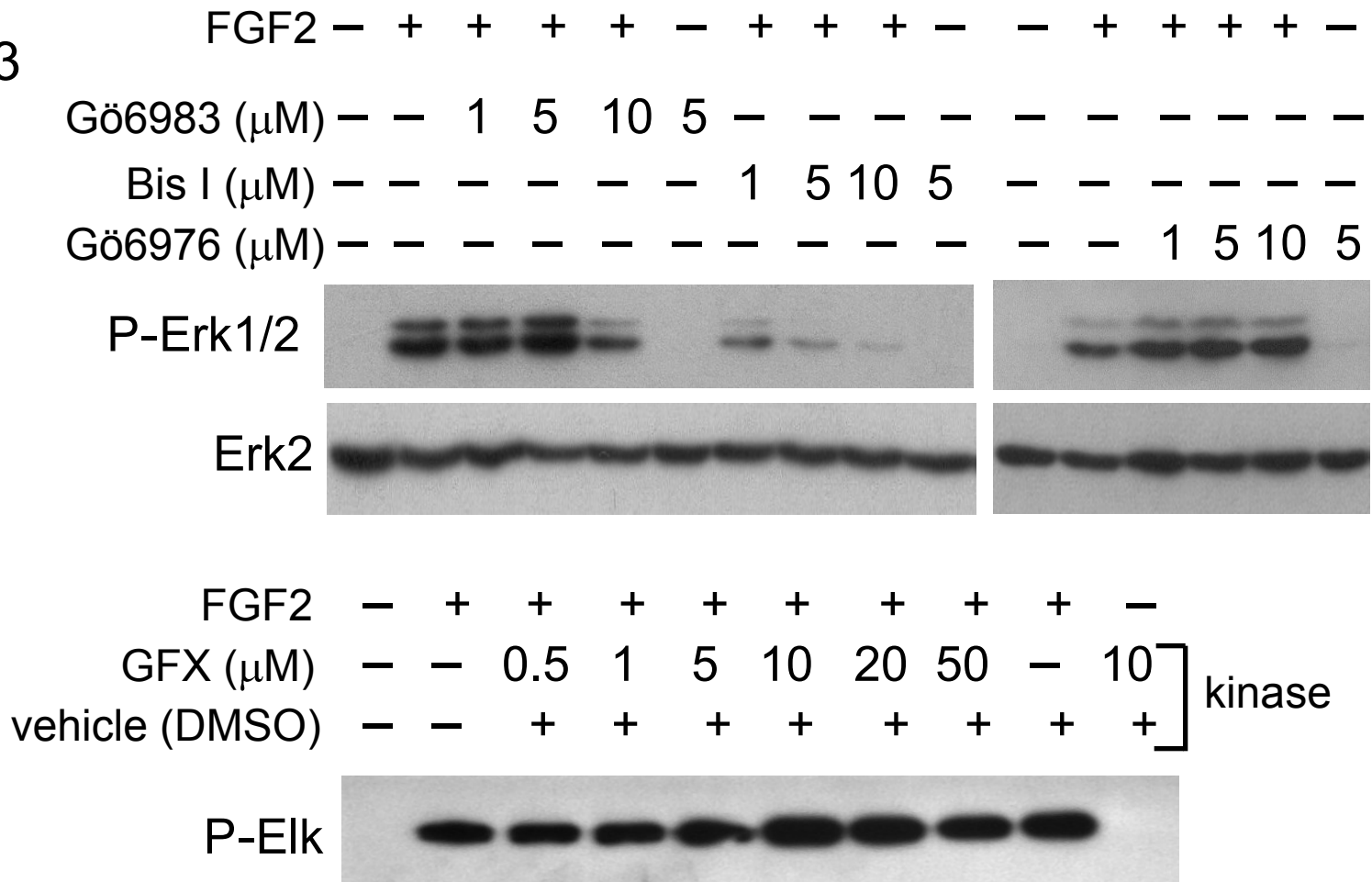
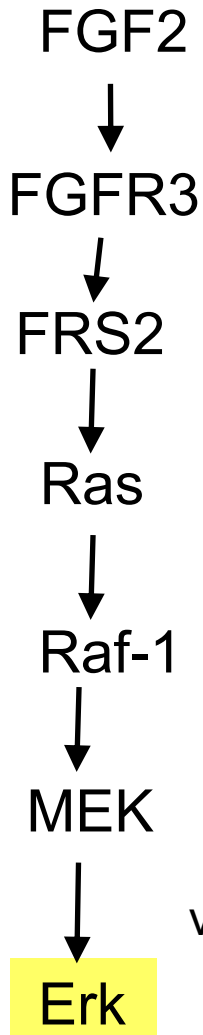

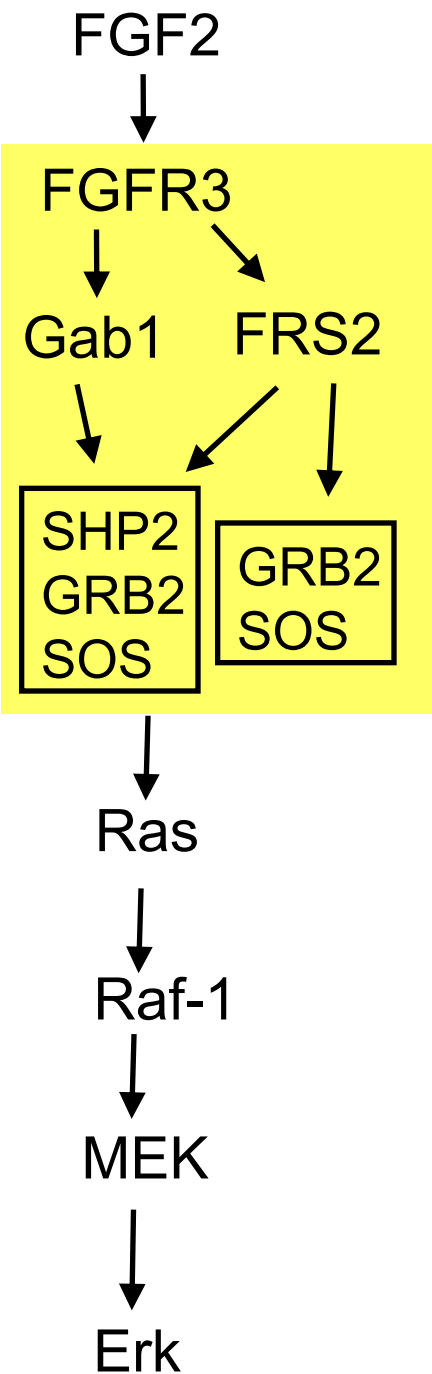

FGF2	-	+	+	+	+	+	+	+	+	+
Bis I (μ M)	-	-	1	5	10	20	50	-	-	-
SU5402(μ M)	-	-	-	-	-	-	-	1	10	20
vehicle(DMSO)	-	-	+	+	+	+	+	+	+	+

kinase

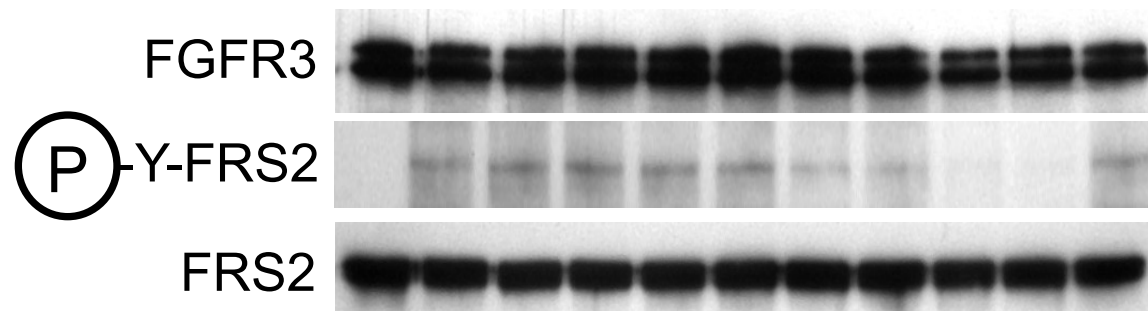

FGF2	-	5'	10'	30'	1h	-	30'	30'	-
Bis I	-	-	-	-	-	-	-	+	+

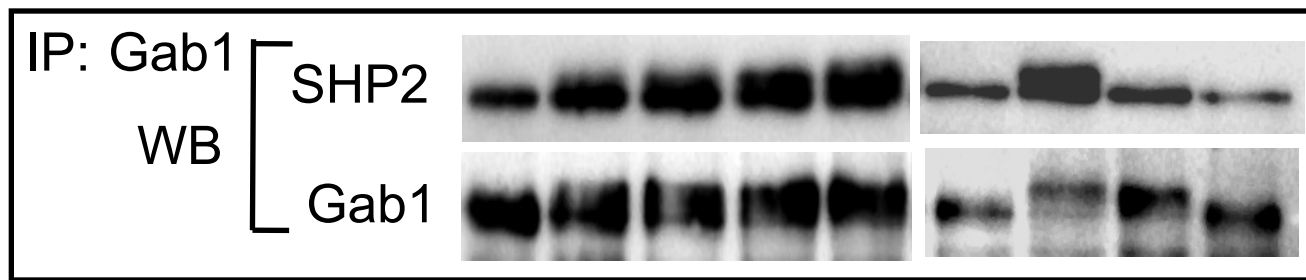
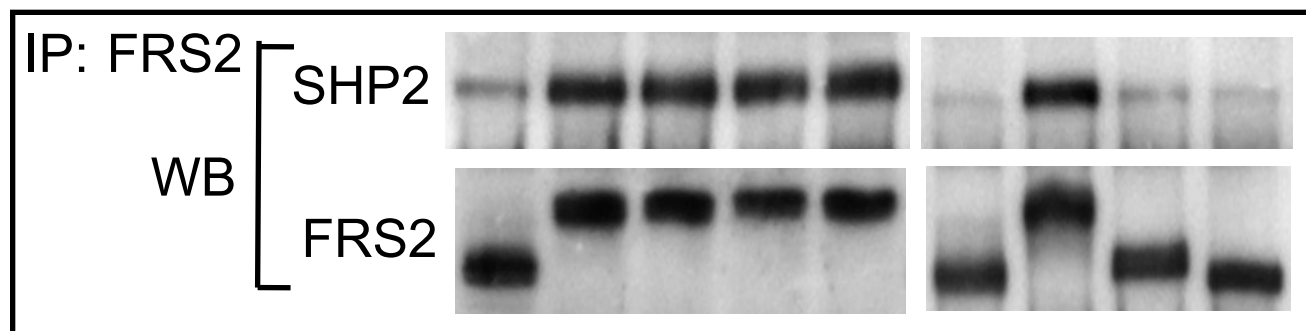

Protein kinase C inhibitor Bisindolylmaleimide I (Bis I) suppresses the FGF2-mediated activation of Erk MAP kinase pathway in chondrocytes by preventing the SHP2 association with FRS2 and Gab1 adaptor proteins

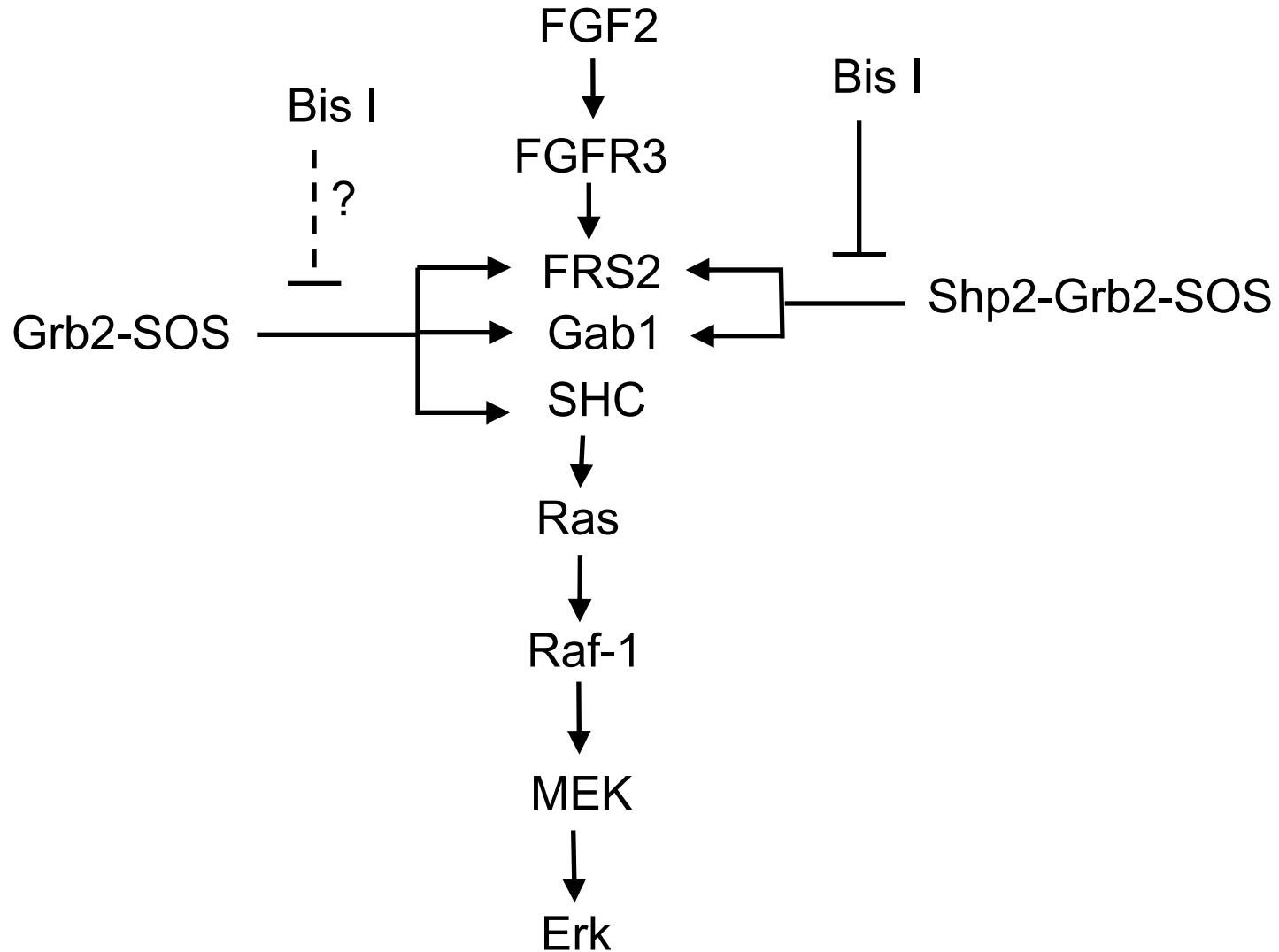

FGFR3 associates with STAT1 and acts as STAT1-kinase in chondrocytes

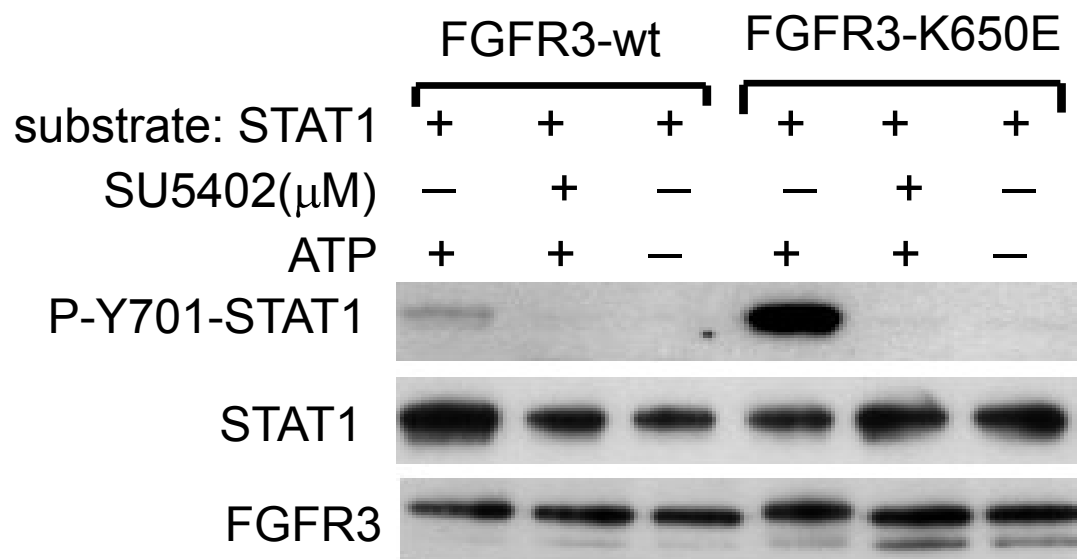
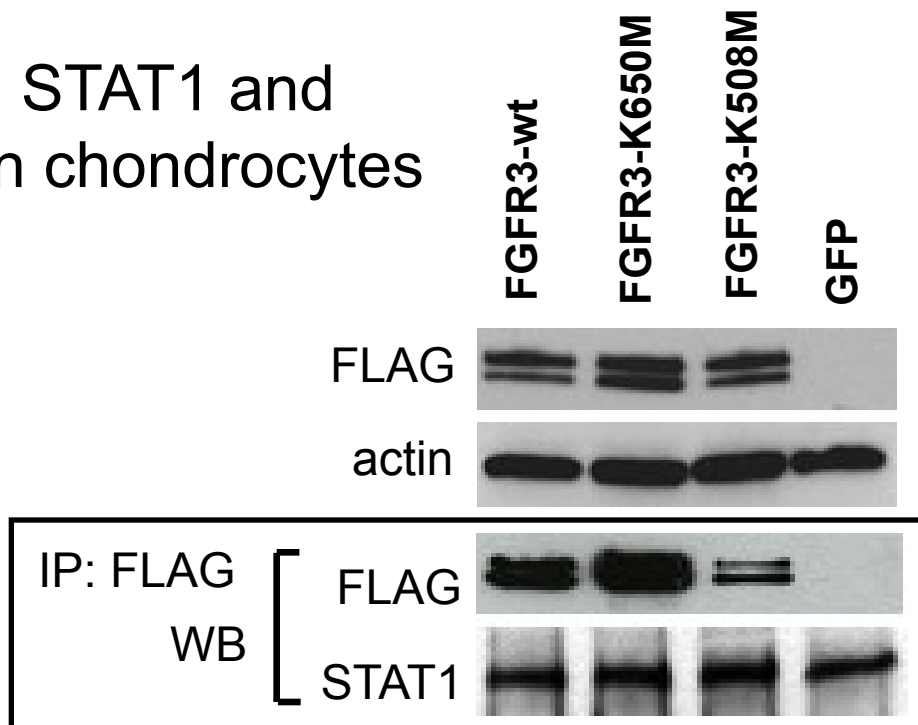
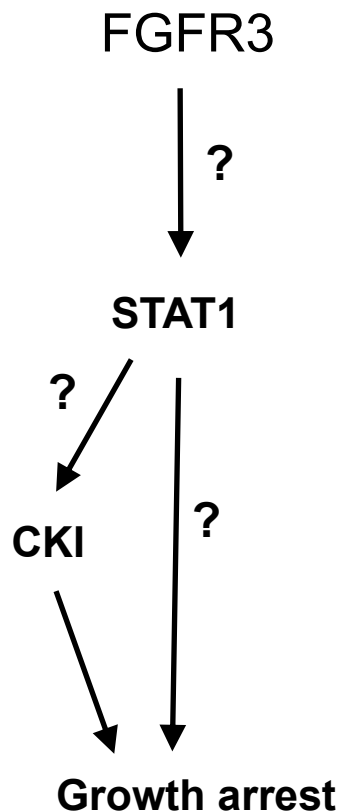

Chronic FGF stimulus inhibits cytokine/STAT signaling in chondrocytes

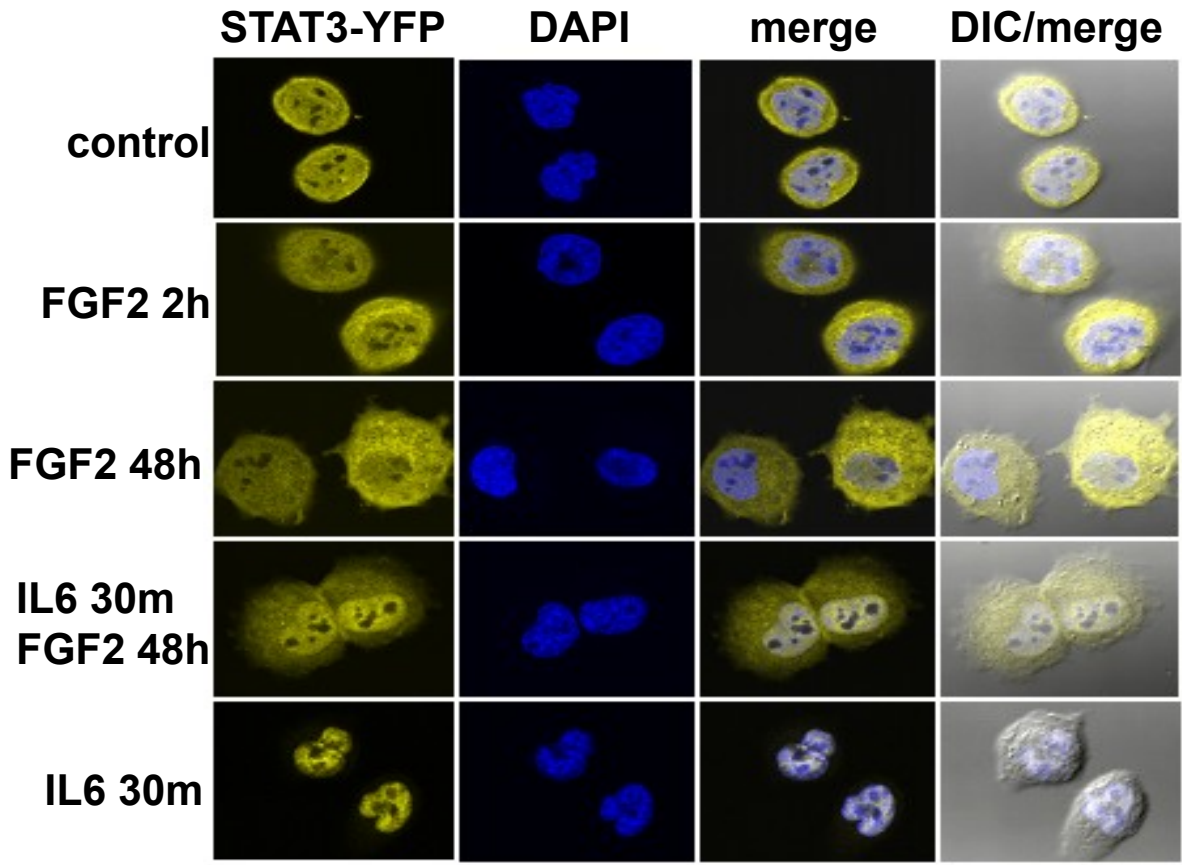
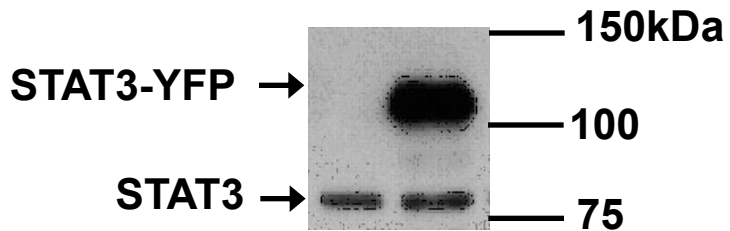

Chronic FGF stimulus inhibits cytokine/STAT signaling in chondrocytes

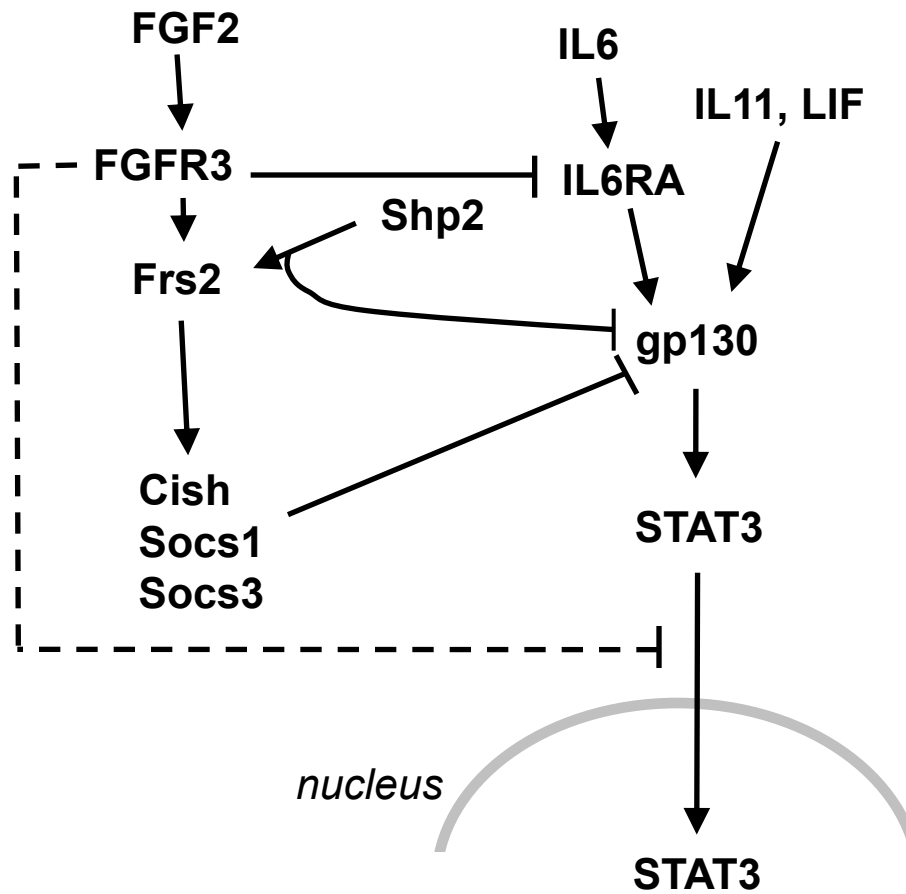

FGF2 causes premature senescence in chondrocytes

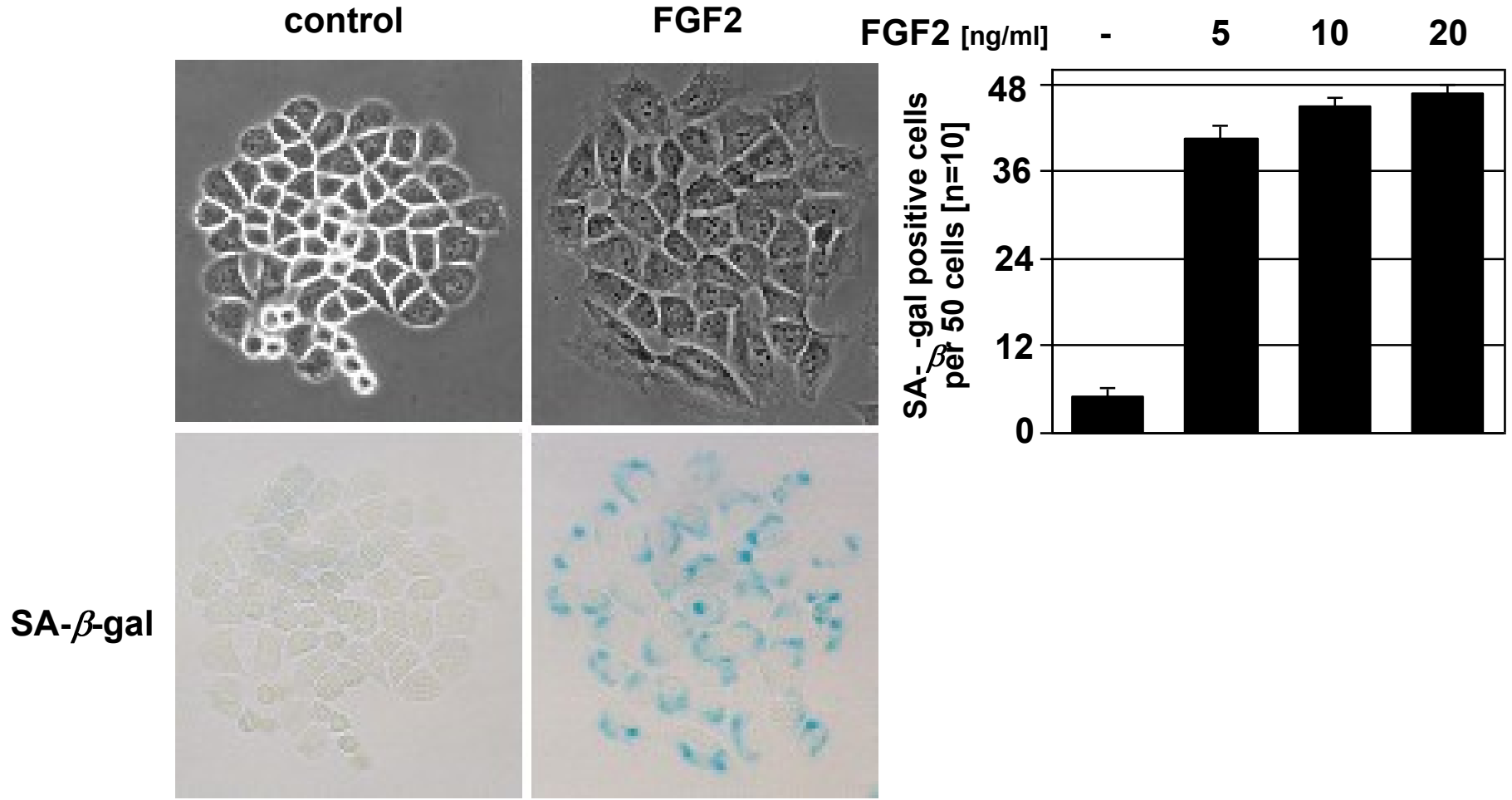

FGF2 signals towards the cytoskeleton in chondrocytes

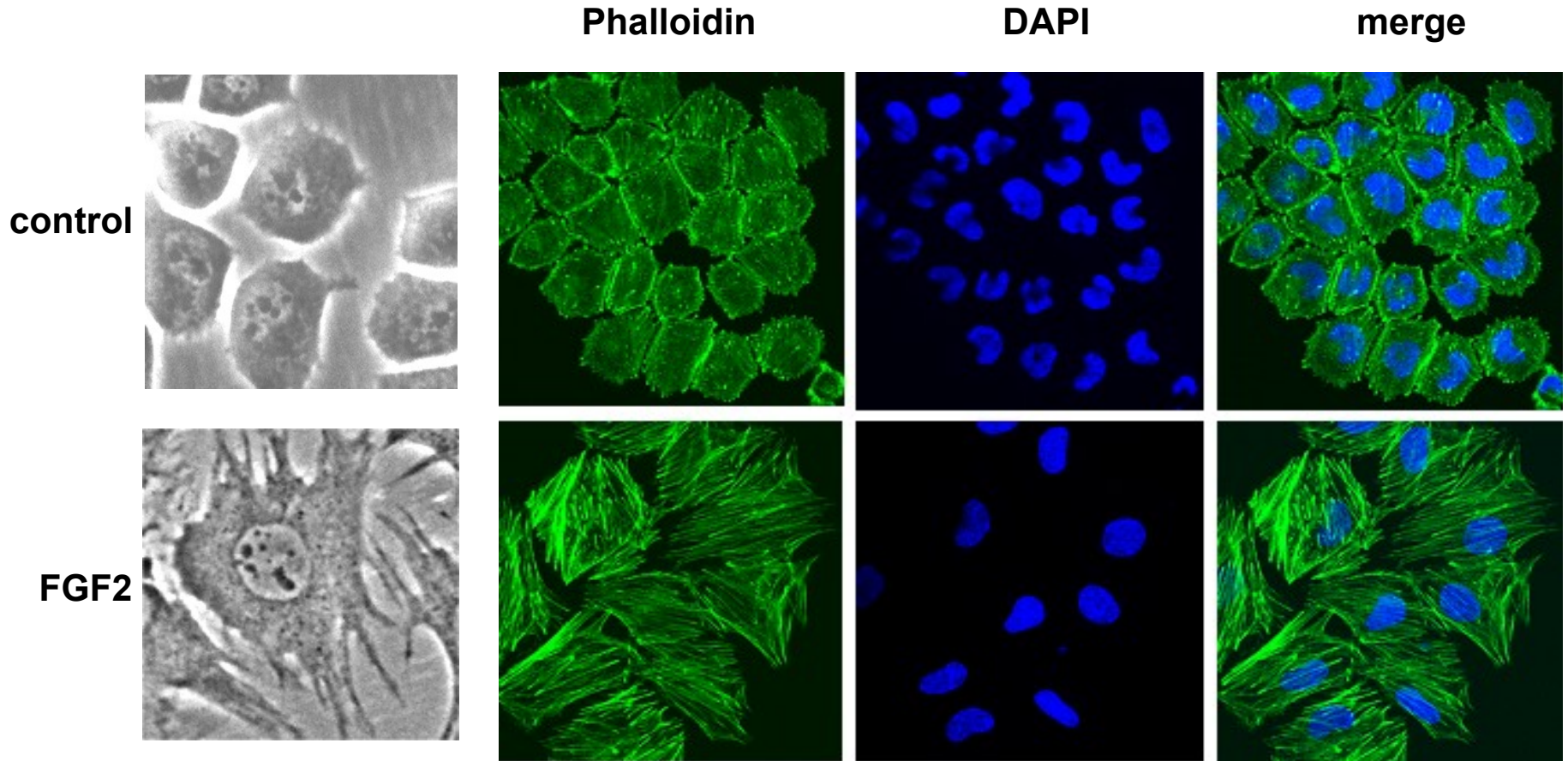

Where is Wnt?



FGF2: C1 15' 1h 3h 6h 12h 24h 48h 72h C2 C3

b-catenin

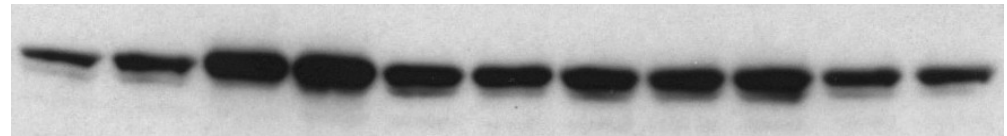

actin

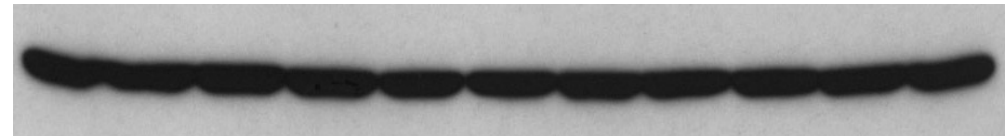

2001

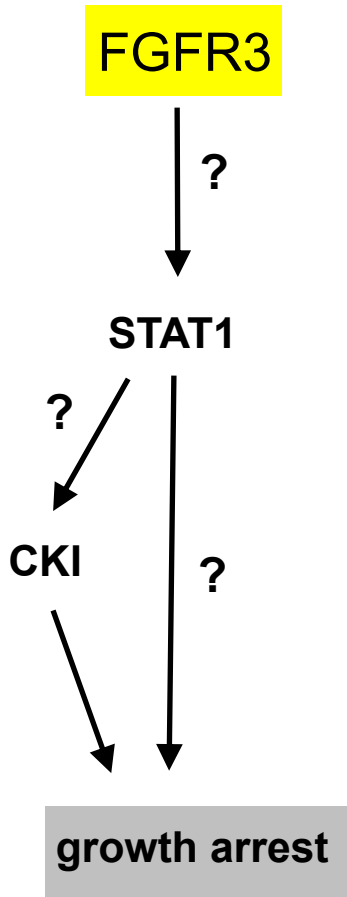

2008

