

Basic steps in the CVD process

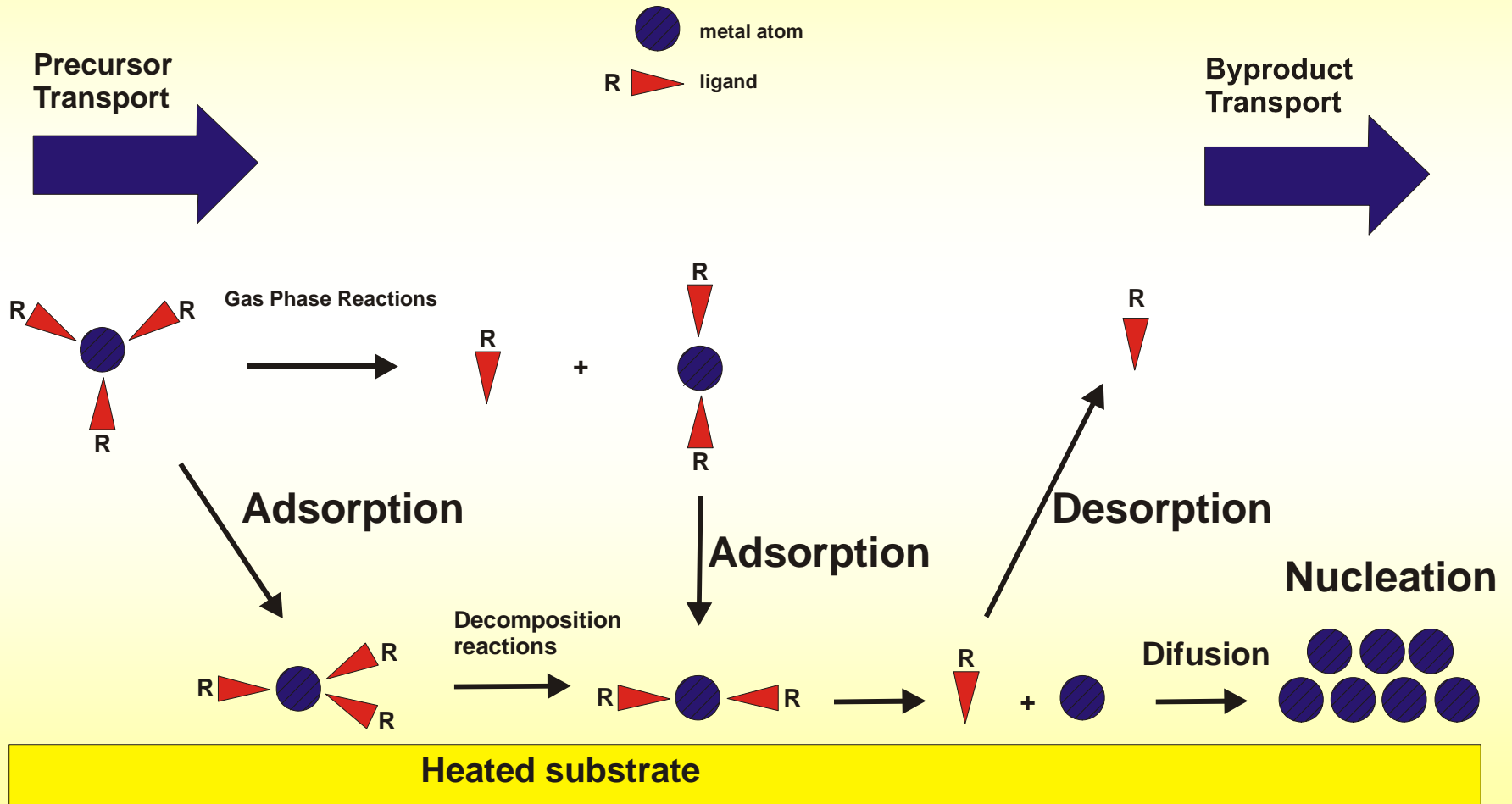

CVD

CVD Reactor

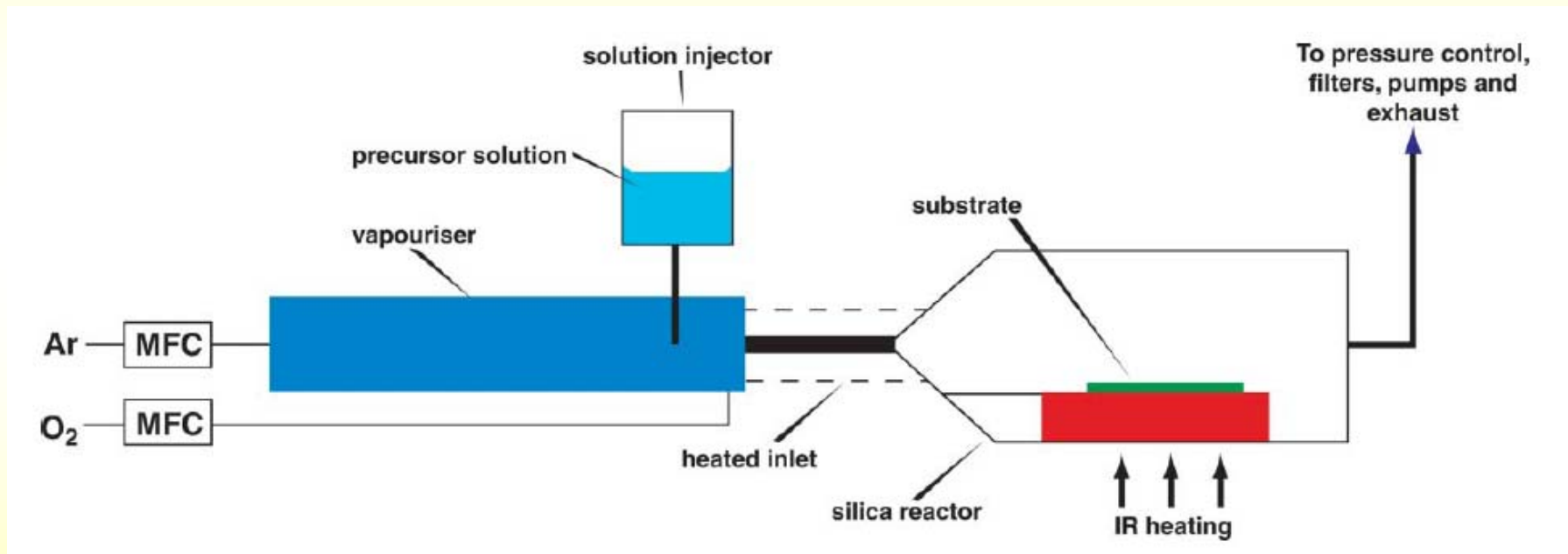

CVD Reactor

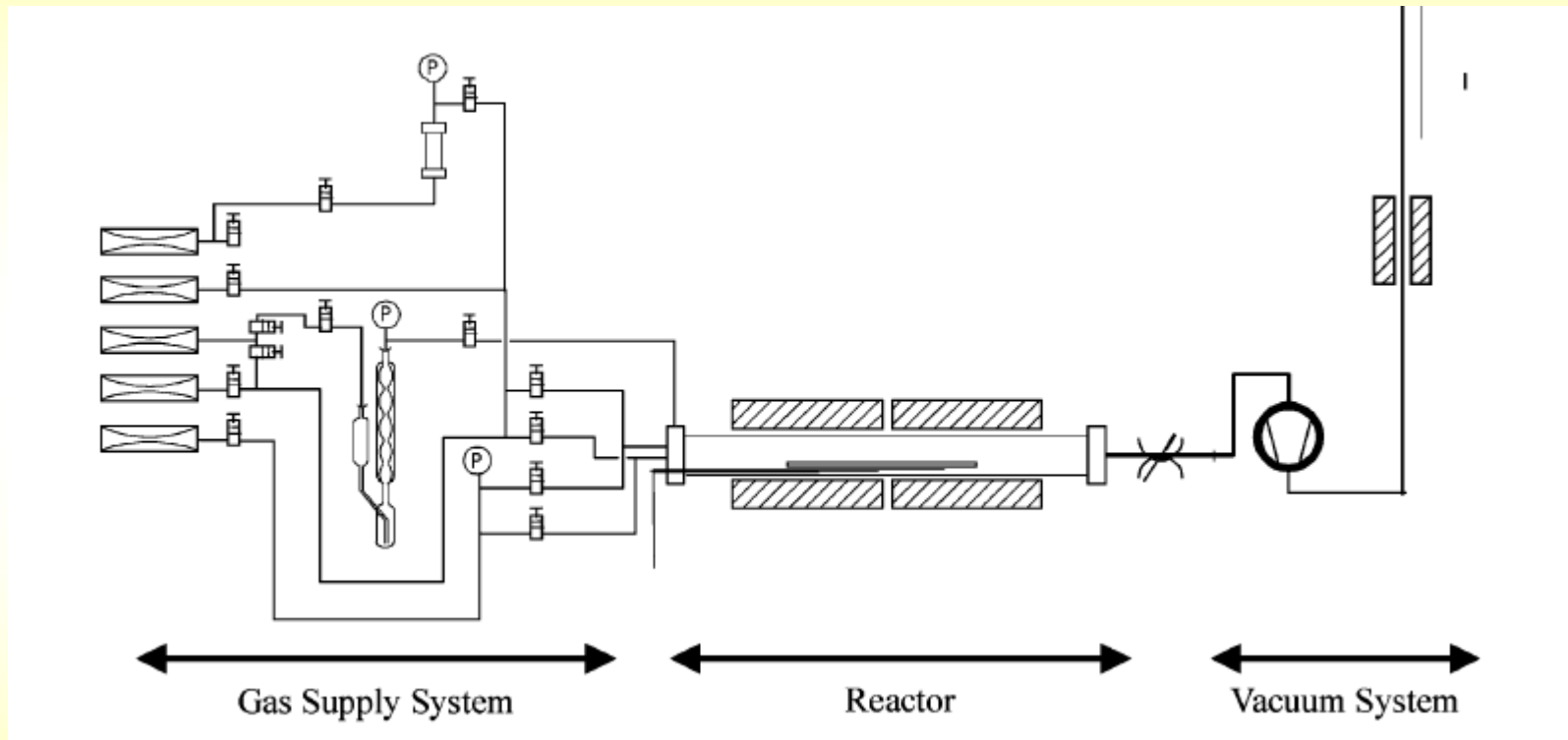

CVD

Precursor Volatility

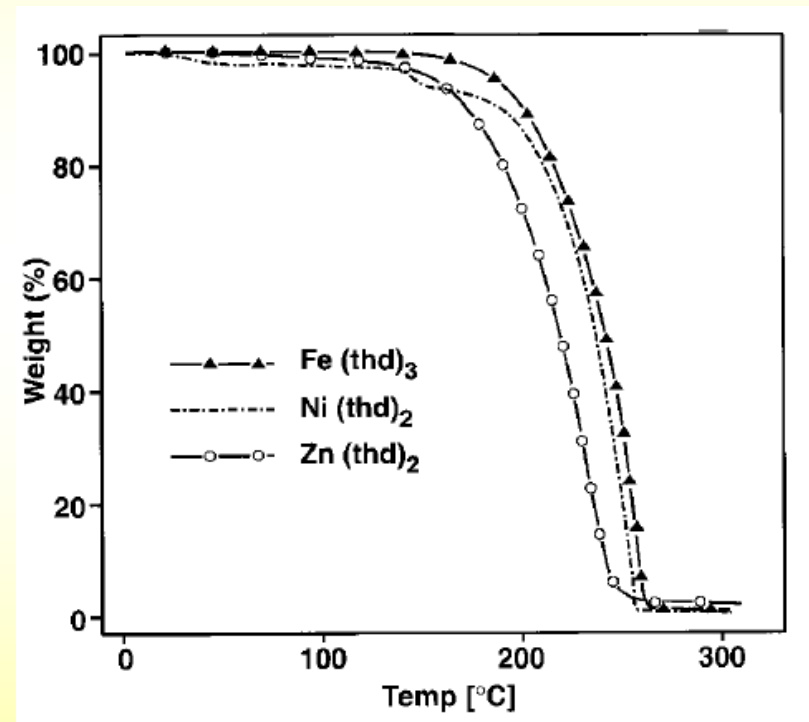
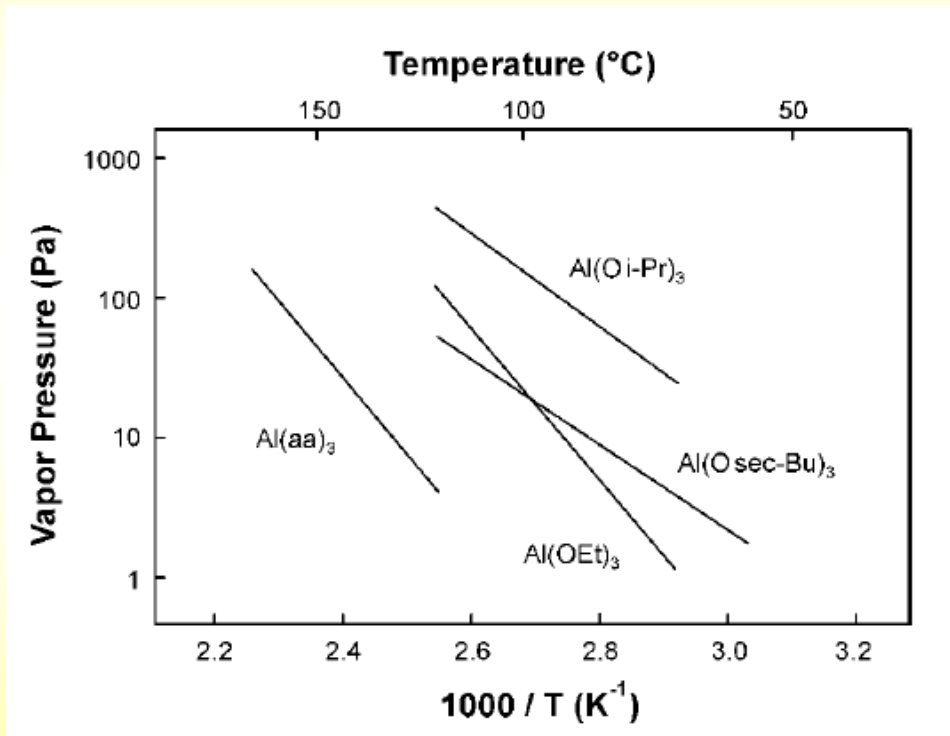

Chemical Vapor Deposition

Aluminum

2.27 $\mu\Omega\text{cm}$, easily etched, Al dissolves in Si,

$\text{GaAs} + \text{Al} \rightarrow \text{AlAs} + \text{Ga}$

Gas diffusion barriers, Al on polypropylene, food packaging = chip bags, party balloons, high optical reflectivity

TIBA

β -Hydride Elimination

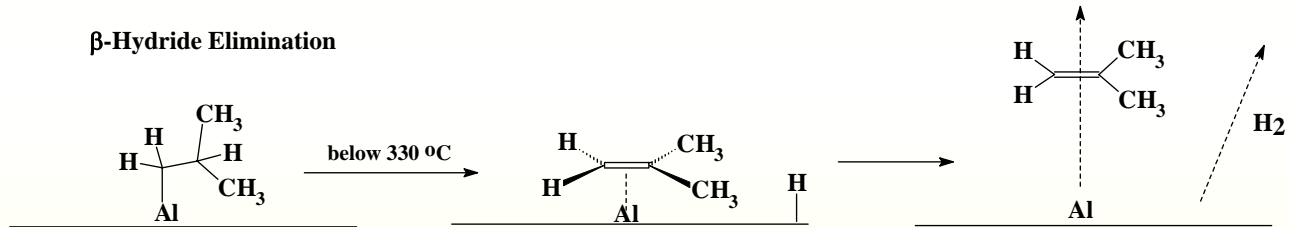

β -Methyl Elimination

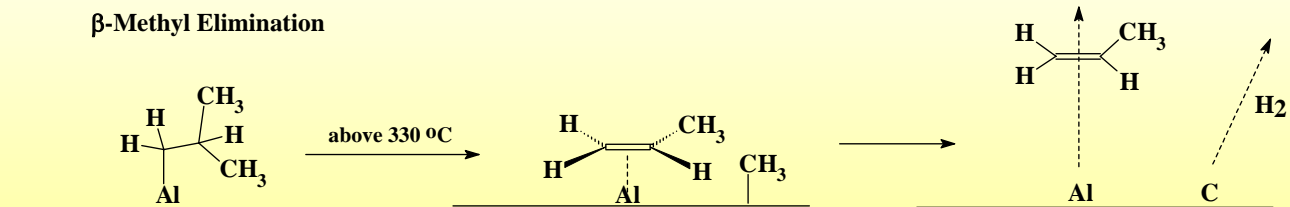

CVD

Chemical Vapor Deposition

Al deposits selectively on Al surfaces, not on SiO₂

Laser-induced nucleation

248 nm only surface adsorbates pyrolysed

193 nm gas phase reactions, loss of spatial selectivity control

TMA

large carbon incorporation, Al₄C₃, RF plasma, laser

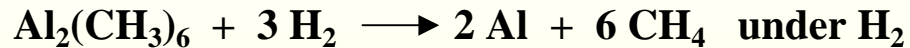

Chemical Vapor Deposition

TMAA

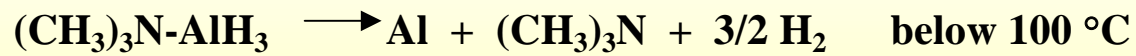
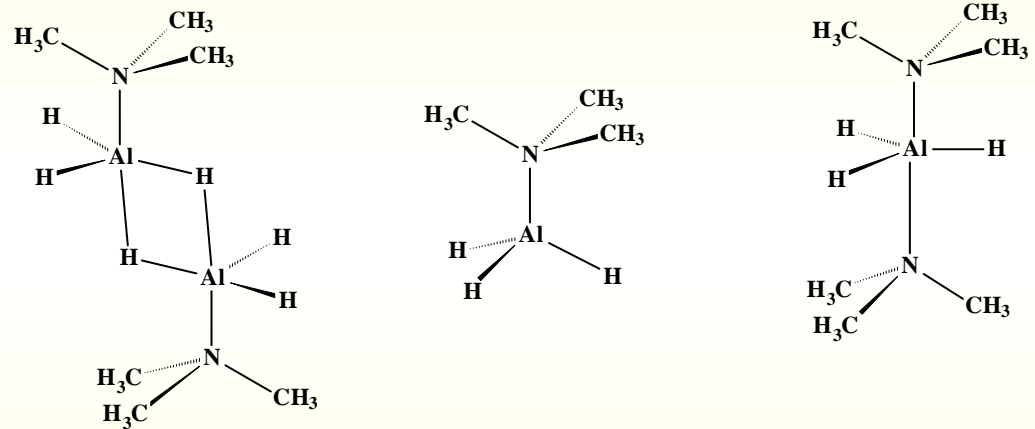

CVD

Chemical Vapor Deposition

Decomposition mechanism of TMAA on Al

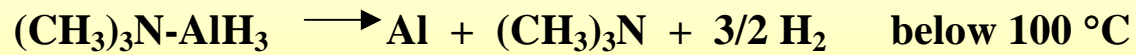
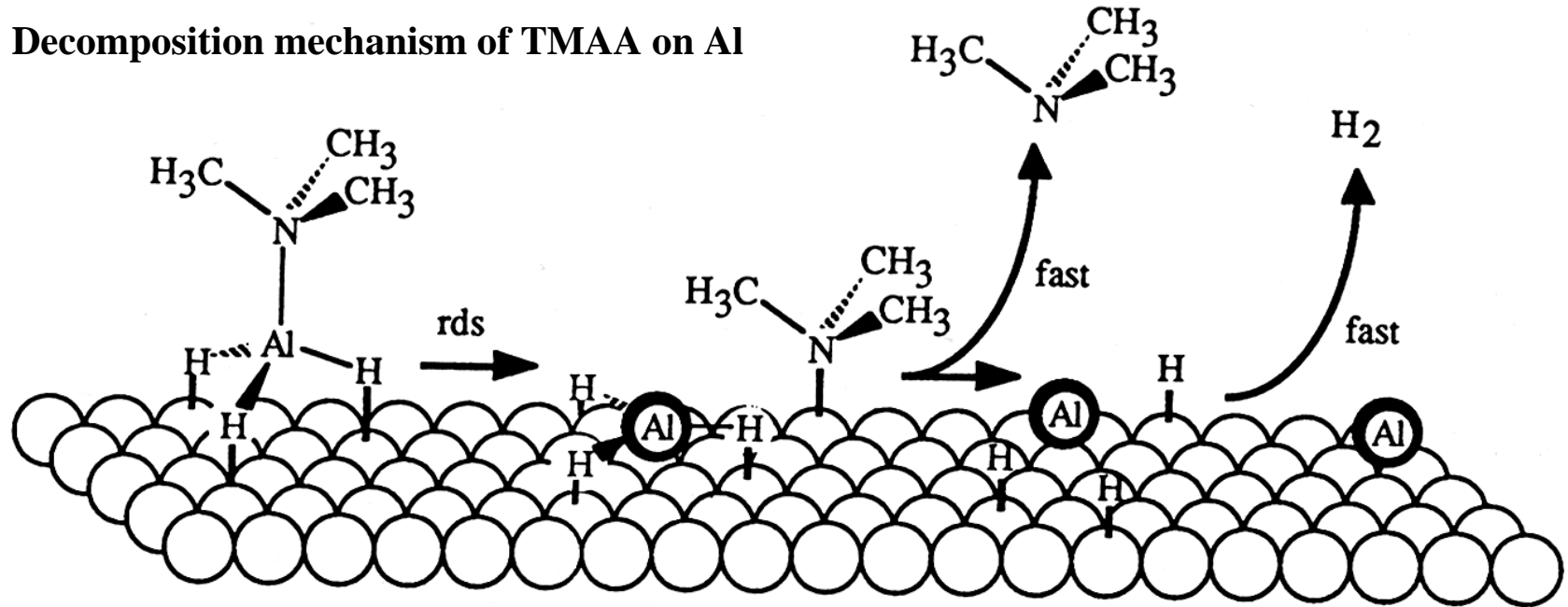

CVD

Chemical Vapor Deposition

Aluminoboranes

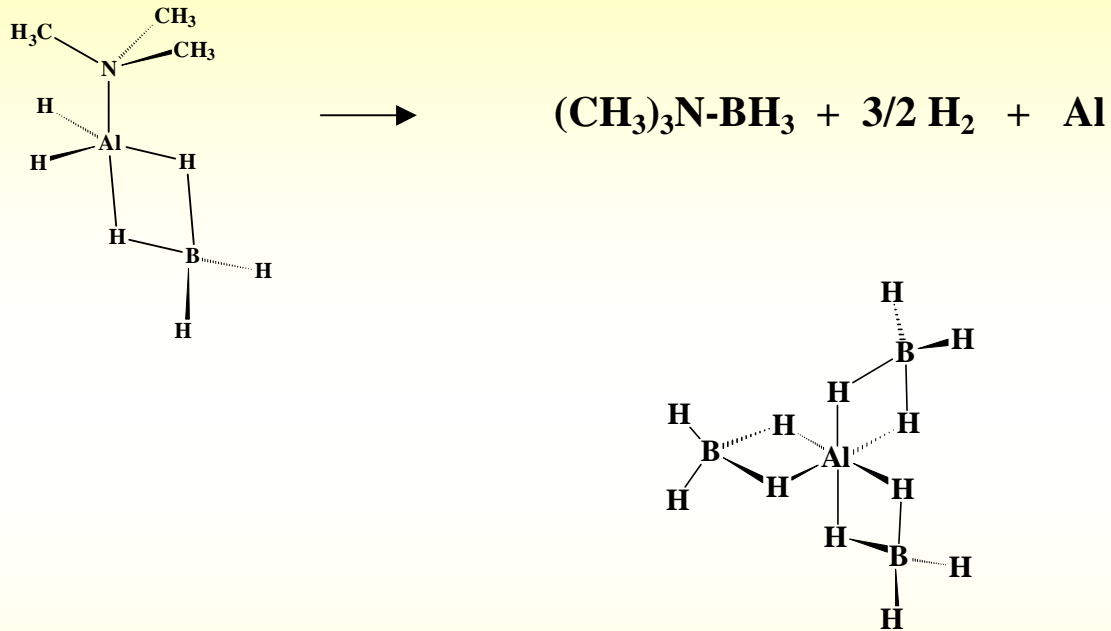

DMAH

ligand redistribution

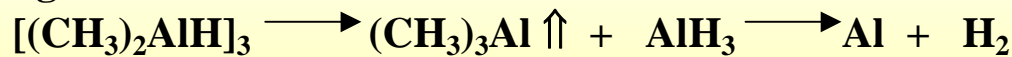

at 280 °C, low carbon incorporation

Chemical Vapor Deposition

Tungsten

5.6 $\mu\Omega\text{cm}$, a high resistance to electromigration, the highest mp of all metals 3410 °C.

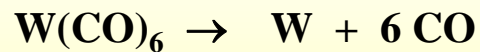
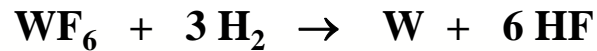
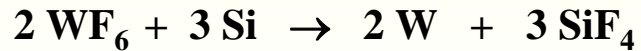

Diketonate Ligands

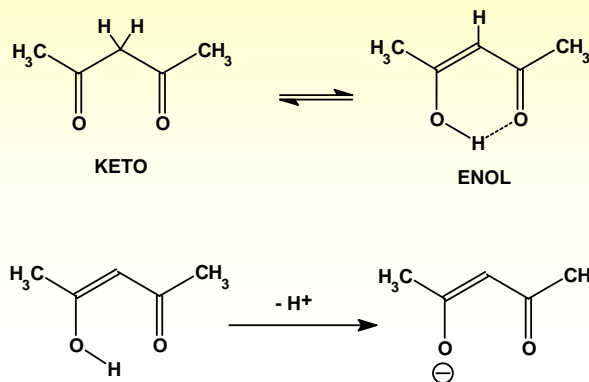

R_1	R_2	Name	Abbreviation
CH_3	CH_3	Pentane-2,4-dionate (acetylacetonate)	acac
CH_3	CF_3	1,1,1-trifluoropentane-2,4-dionate (trifluoroacetylacetonate)	tfac
CF_3	CF_3	1,1,1,5,5,5-hexafluoropentane-2,4-dionate (hexafluoroacetylacetonate)	hfac
CH_3	$C(CH_3)_3$	1,1-dimethylhexane-3,5-dionate	dhd
$C(CH_3)_3$	$C(CH_3)_3$	2,2,6,6-tetramethylheptane-3,5-dionate	thd
CH_3	$CH_2CH(CH_3)_2$	6-methylheptane-2,4-dionate	mhd
$C(CH_3)_3$	$CH_2CH(CH_3)_2$	2,2,7-trimethyloctane-3,5-dionate	tmod
C_6H_5	C_6H_5	1,3-diphenylpropane-1,3-dionate (dibenzoylmethanate)	dbm

Diketonate Precursors

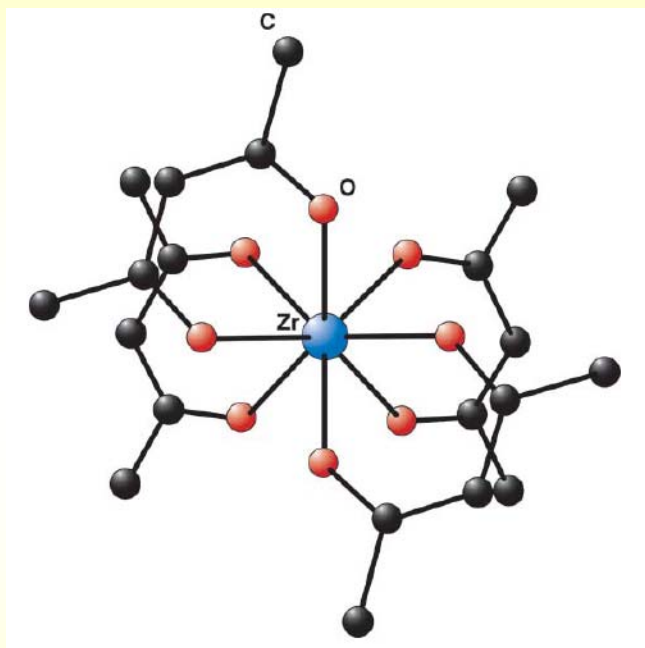

Mononuclear

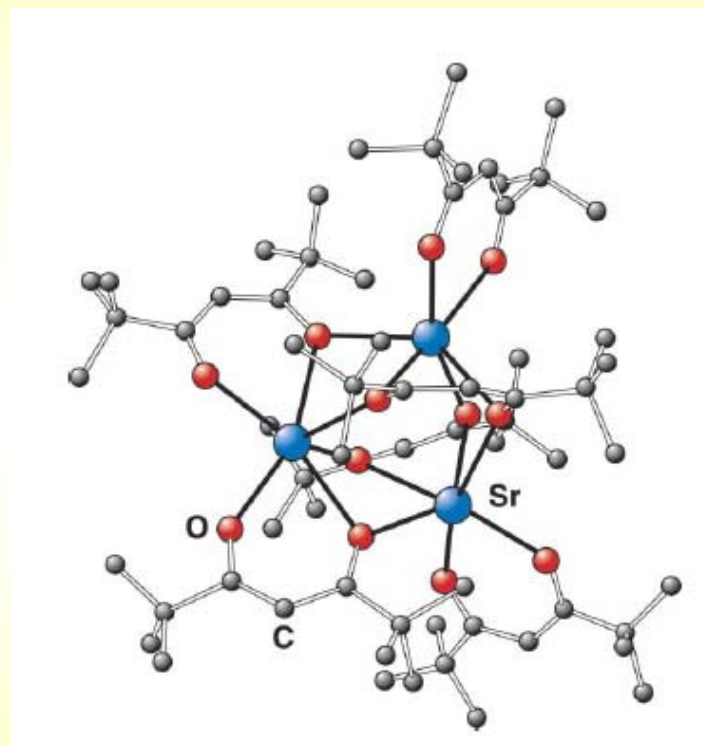

Polynuclear

Chemical Vapor Deposition

Copper(II) hexafluoroacetylacetonate

excellent volatility (a vapor pressure of 0.06 Torr at r. t.),
low decomposition temperature,
stability in air, low toxicity,
commercial availability

deposition on metal surfaces (Cu, Ag, Ta)
the first step, which can already occur at $-150\text{ }^{\circ}\text{C}$,
a dissociation of the precursor molecules on the surface (Scheme I).

An electron transfer from a metal substrate to the single occupied HOMO which has an anti-bonding character with respect to copper d_{xy} and oxygen p orbitals weakens the Cu-O bonds and facilitates their fission.

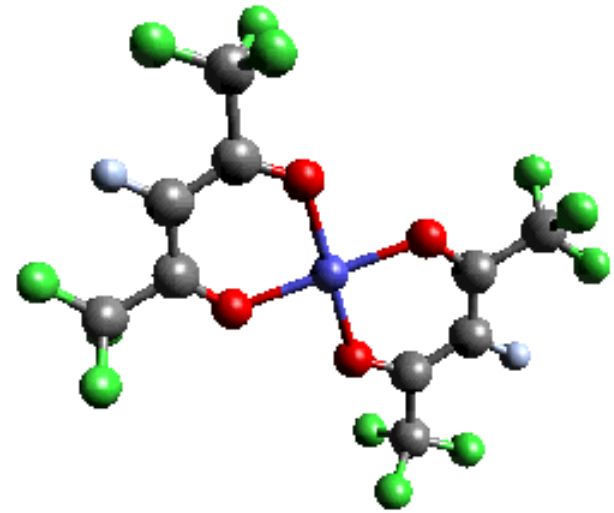

Chemical Vapor Deposition

Scheme I

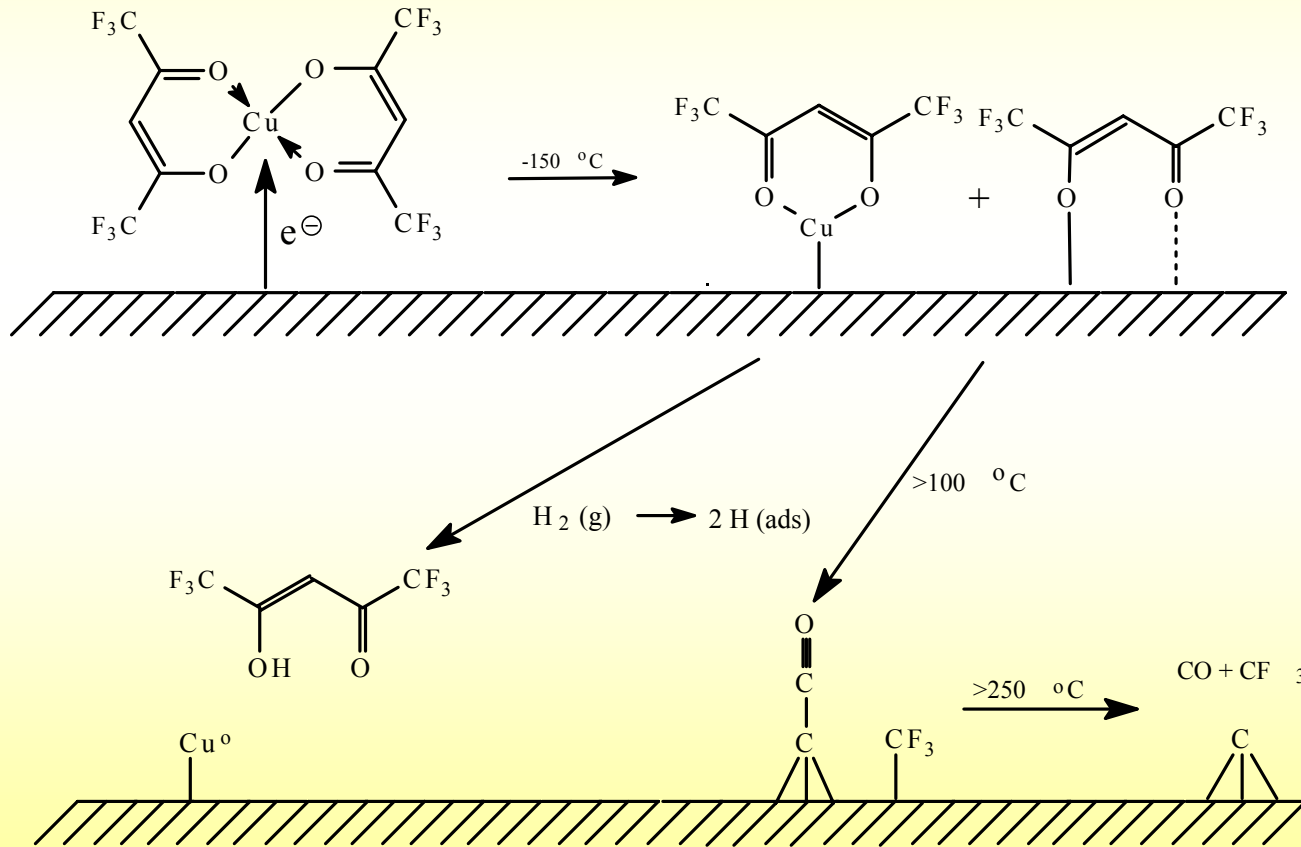

CVD

Chemical Vapor Deposition

SEM of Cu film, coarse grain, high resistivity

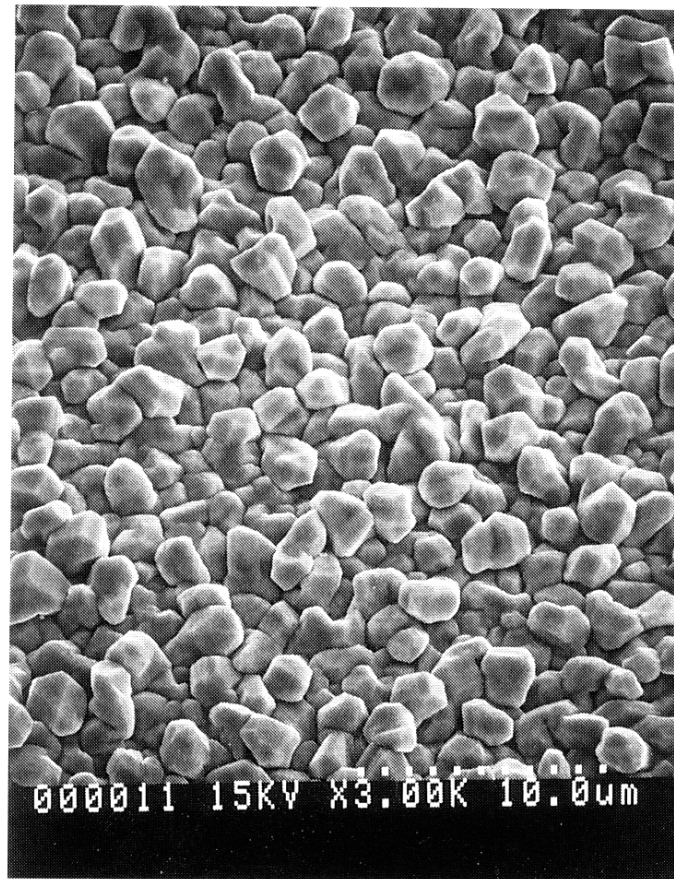

CVD

Chemical Vapor Deposition

Growth rate of Cu films deposited from $\text{Cu}(\text{hfacac})_2$ with 10 torr of H_2

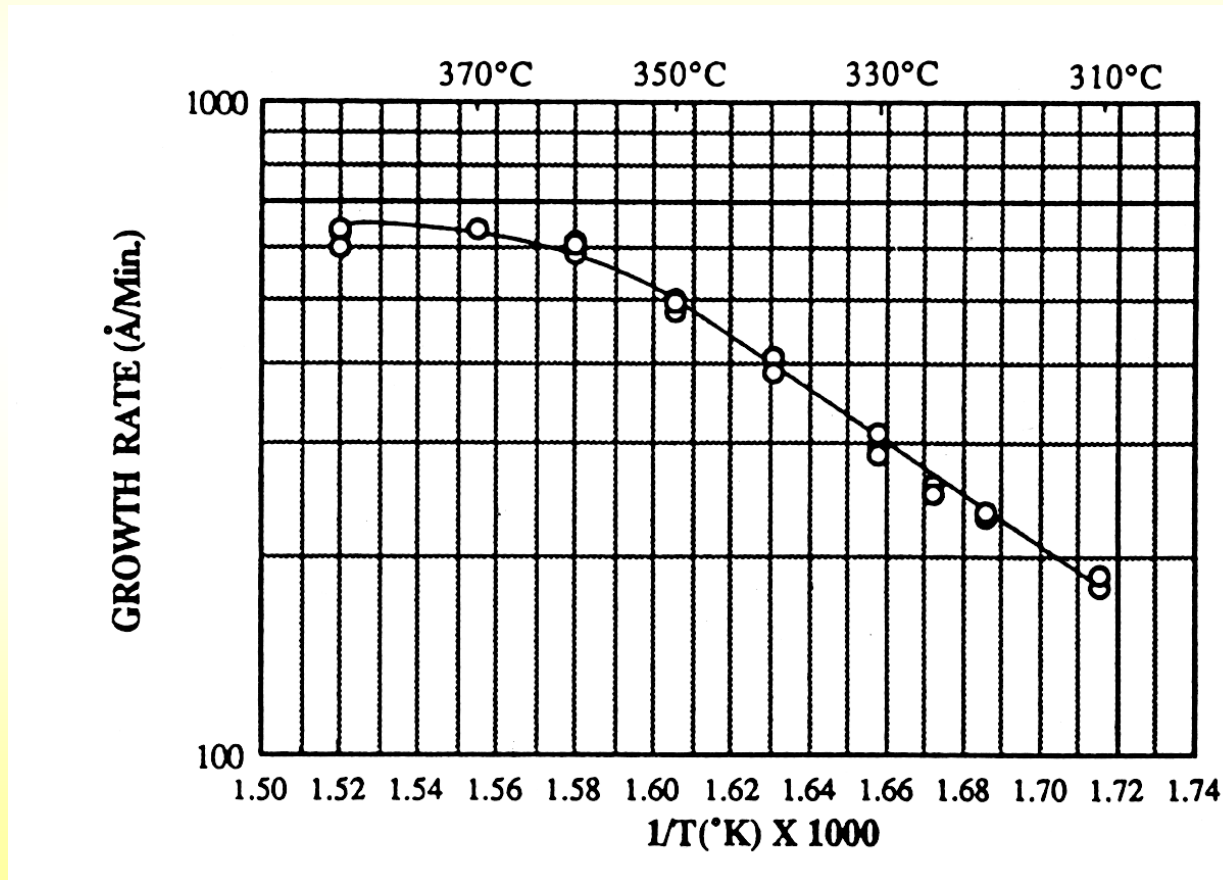

CVD

Chemical Vapor Deposition

Cu(I) precursors

Disproportionation to Cu(0) and Cu(II)

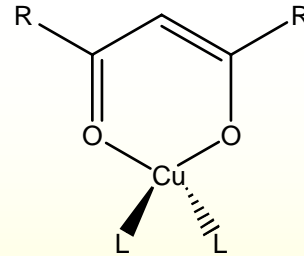
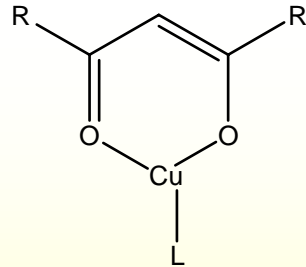
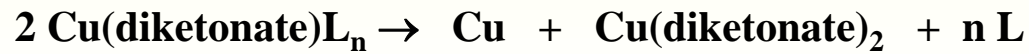

L: PMe_3 , PEt_3 , CO , CN^tBu ,

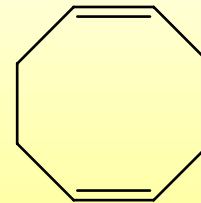
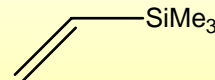

CVD

Chemical Vapor Deposition

Diamond films

activating gas-phase carbon-containing precursor molecules:

- thermal (*e.g.* hot filament)
- plasma (D.C., R.F., or microwave)
- combustion flame (oxyacetylene or plasma torches)

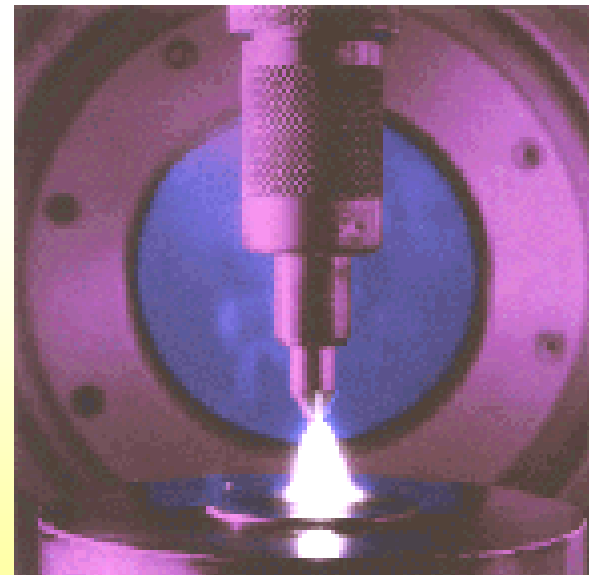
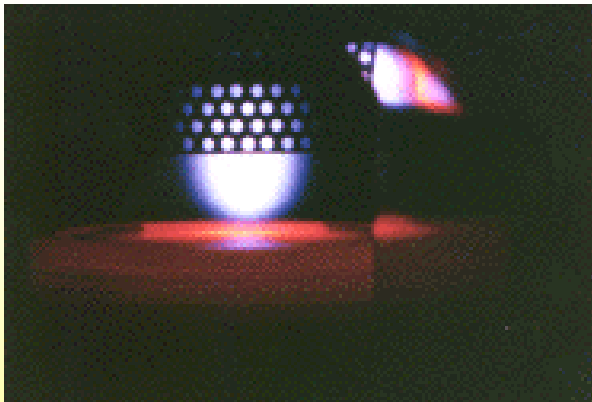

CVD

Chemical Vapor Deposition

Experimental conditions:

temperature 1000-1400 K

the precursor gas diluted in an excess of hydrogen (typical CH₄ mixing ratio ~1-2vol%)

Deposited films are polycrystalline

Film quality:

- the ratio of sp³ (diamond) to sp²-bonded (graphite) carbon**
- the composition (*e.g.* C-C versus C-H bond content)**
- the crystallinity**

Combustion methods: high rates (100-1000 μm/hr), small, localised areas, poor quality films.

Hot filament and plasma methods: slower growth rates (0.1-10 μm/hr), high quality films.

Chemical Vapor Deposition

Hydrogen atoms generated by activation (thermally or via electron bombardment)

H-atoms play a number of crucial roles in the CVD process:

H abstraction reactions with hydrocarbons, highly reactive radicals: CH_3

(stable hydrocarbon molecules do not react to cause diamond growth)

radicals diffuse to the substrate surface and form C-C bonds to propagate the diamond lattice.

H-atoms terminate the 'dangling' carbon bonds on the growing diamond surface,

prevent cross-linking and reconstructing to a graphite-like surface.

Atomic hydrogen etches both diamond and graphite but, under typical CVD conditions, the rate of diamond growth exceeds its etch rate whilst for graphite the converse is true.

This is the basis for the preferential deposition of diamond rather than graphite.

Chemical Vapor Deposition

**Diamond initially nucleates as individual microcrystals,
which then grow larger until they coalesce into a continuous film**

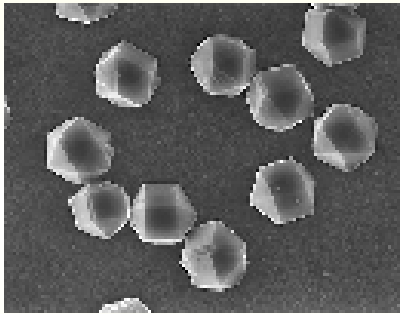

Enhanced nucleation by ion bombardment:

damage the surface - more nucleation sites

implant ions into the lattice

form a carbide interlayer - glue, promotes diamond growth, aids adhesion

Chemical Vapor Deposition

Substrates: metals, alloys, and pure elements:

Little or no C Solubility or Reaction: Cu, Sn, Pb, Ag, and Au, Ge, sapphire, diamond, graphite

C Diffusion: Pt, Pd, Rh, Fe, Ni, and Ti

the substrate acts as a carbon sink, deposited carbon dissolves into the metal surface,
large amounts of C transported into the bulk,
a temporary decrease in the surface C concentration, delaying the onset of nucleation

Carbide Formation: Ti, Zr, Hf, V, Nb, Ta, Cr, Mo, W, Fe, Co, Ni, Y, Al

B, Si, SiO₂, quartz, Si₃N₄ also form carbide layers.

SiC, WC, and TiC

Chemical Vapor Deposition

Applications of diamond films:

Thermal management - a heat sink for laser diodes, microwave integrated circuits
active devices mounted on diamond can be packed more tightly without overheating

Cutting tools - an abrasive, a coating on cutting tool inserts

CVD diamond-coated tools have a longer life, cut faster and provide a better finish
than conventional WC tool bits

Wear Resistant Coatings -protect mechanical parts, reduce lubrication
gearboxes, engines, and transmissions

Chemical Vapor Deposition

Optics - protective coatings for infrared optics in harsh environments,

ZnS, ZnSe, Ge: excellent IR transmission but brittle

the flatness of the surface, roughness causes attenuation and scattering of the IR signal

Electronic devices - doping, an insulator into a **semiconductor**

p-doping: B₂H₆ incorporates B into the lattice

doping with atoms larger than C very difficult, *n*-dopants such as P or As, cannot be used

for diamond, alternative dopants, such as Li

Laser-Enhanced CVD

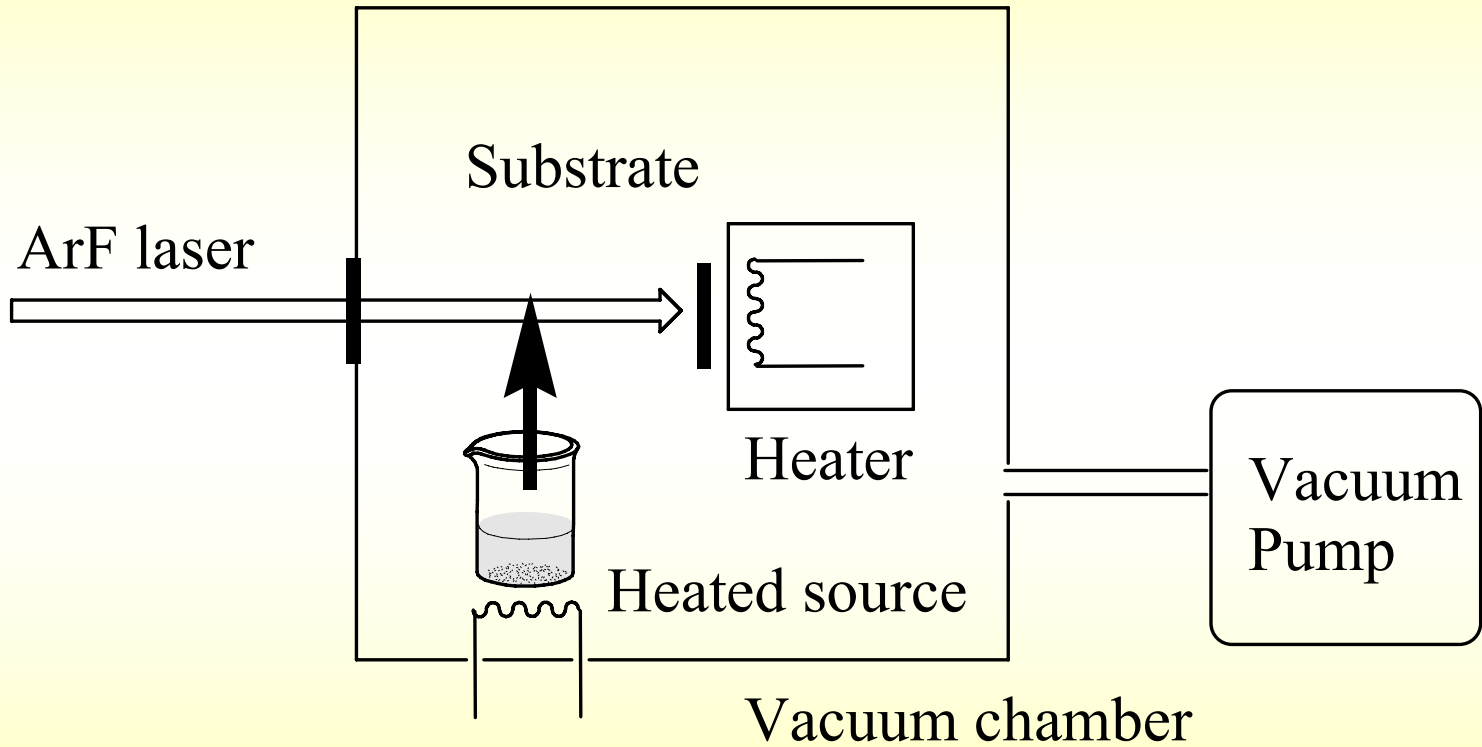

CVD

LPCVD of ZnO from Aminoalcoholates

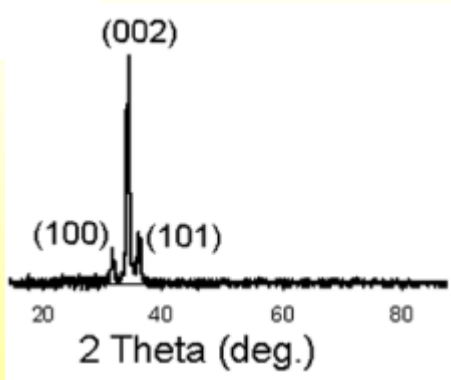
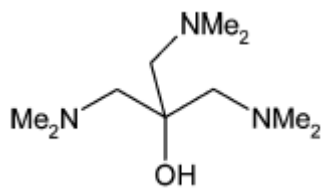
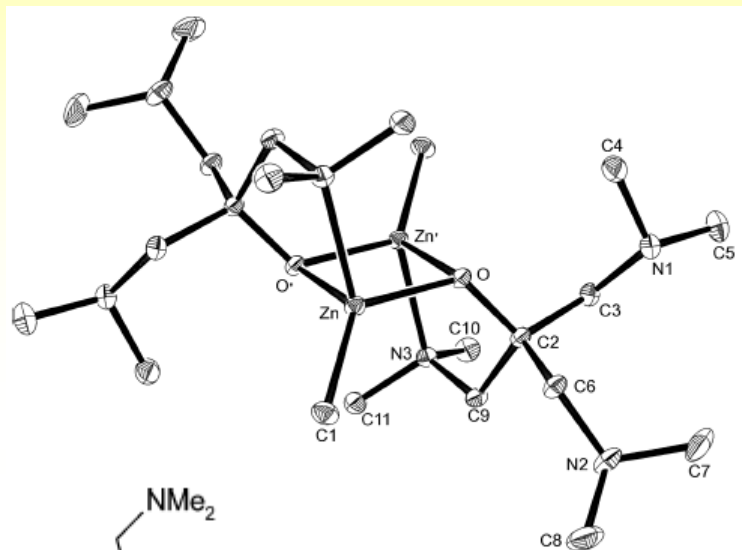

Hexagonal ZnO PDF 79-0208

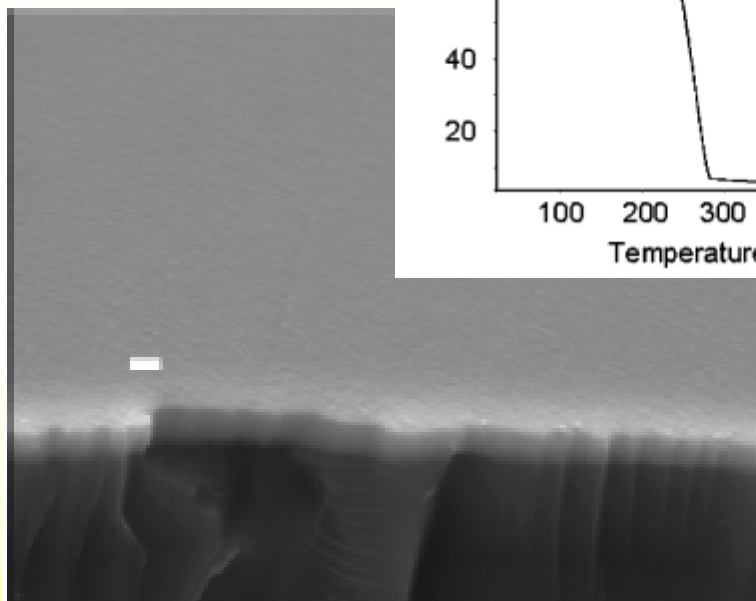
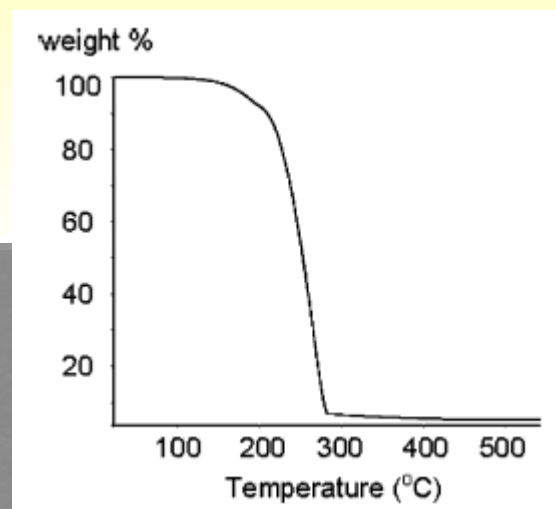

SEM of the film deposited by LPCVD at 500 °C. Bar = 1 μm.

CVD

LPCVD of ZnO from Aminoalcoholates

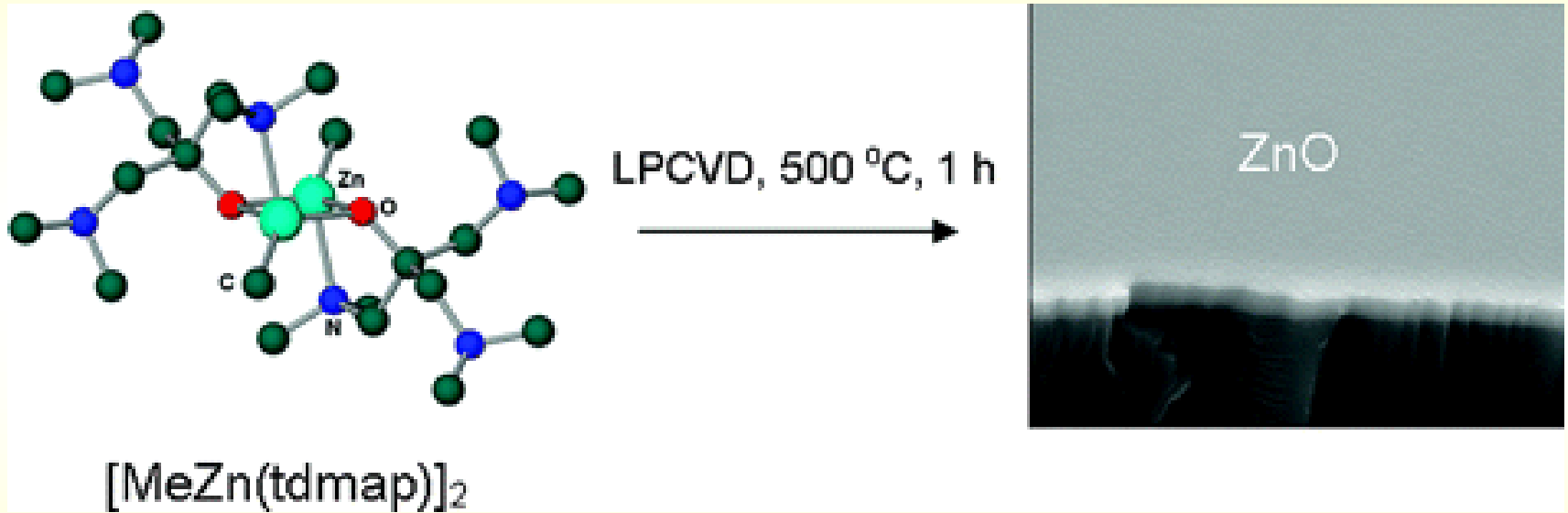

CVD of YF_3 from hfacac Complex

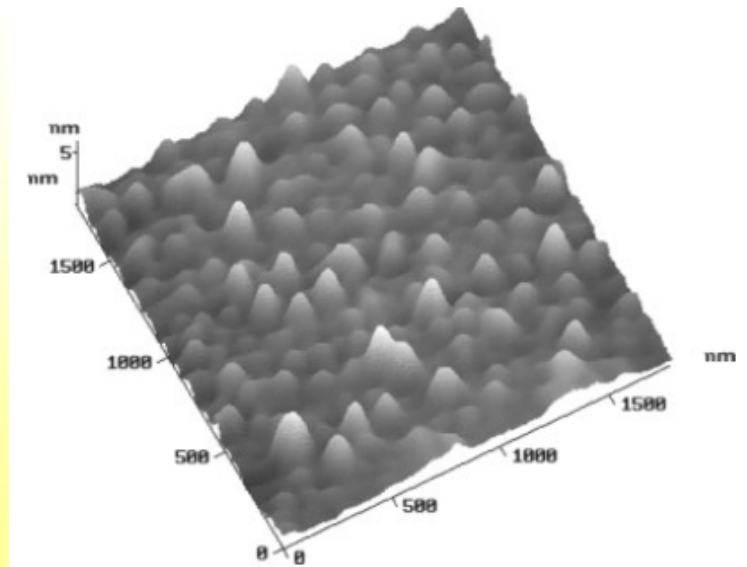
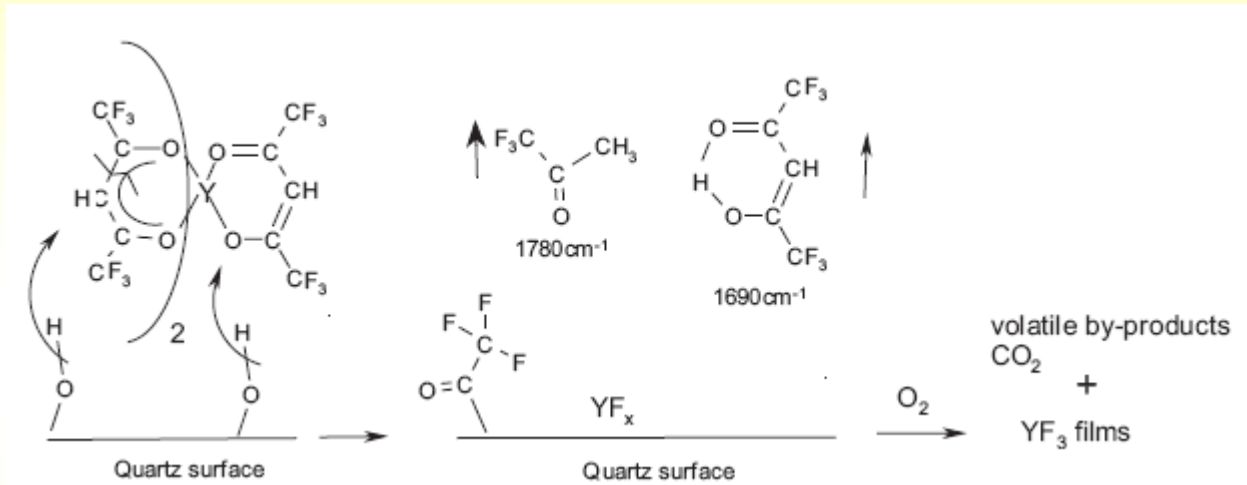

CVD

ALD Atomic Layer Deposition

Special modification of CVD

Method for the deposition of thin films

Film growth by cyclic process

4 steps:

1/ exposition by 1st precursor

2/ cleaning of the reaction chamber

3/ exposition by 2nd precursor

4/ cleaning of the reaction chamber

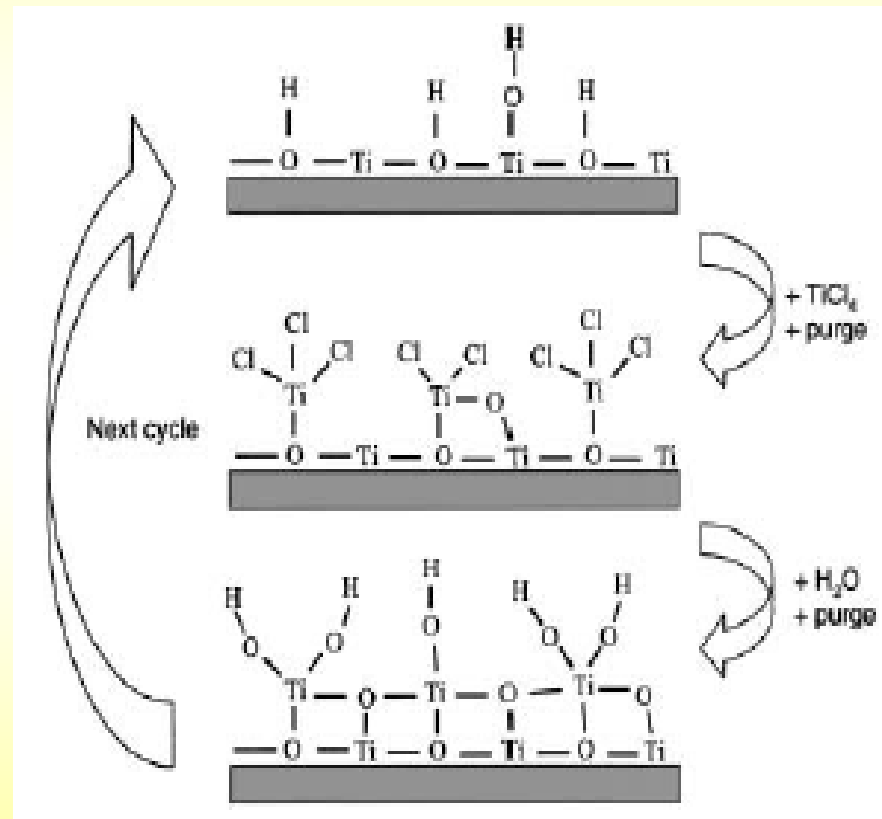

ALD Atomic Layer Deposition

Cycle repetitions until desired film thickness is reached

1 cycle: 0.5 s – several sec. thickness 0.1- 3 Å

Self-Limiting Growth Mechanism

High reactivity

Formation of a monolayer

Control of film thickness and composition

Deposition on large surface area

ALD vs. CVD Comparison

ALD Carried out at room temperature

Control over number of deposited layers = film thickness

Reactor walls inactive – no reactive layer

Separate loading of reactive precursors

Self-limiting growth

Precursor transport to the reaction zone does not have to be highly uniform (as in CVD)

Solid precursors

ALD vs. CVD Comparison

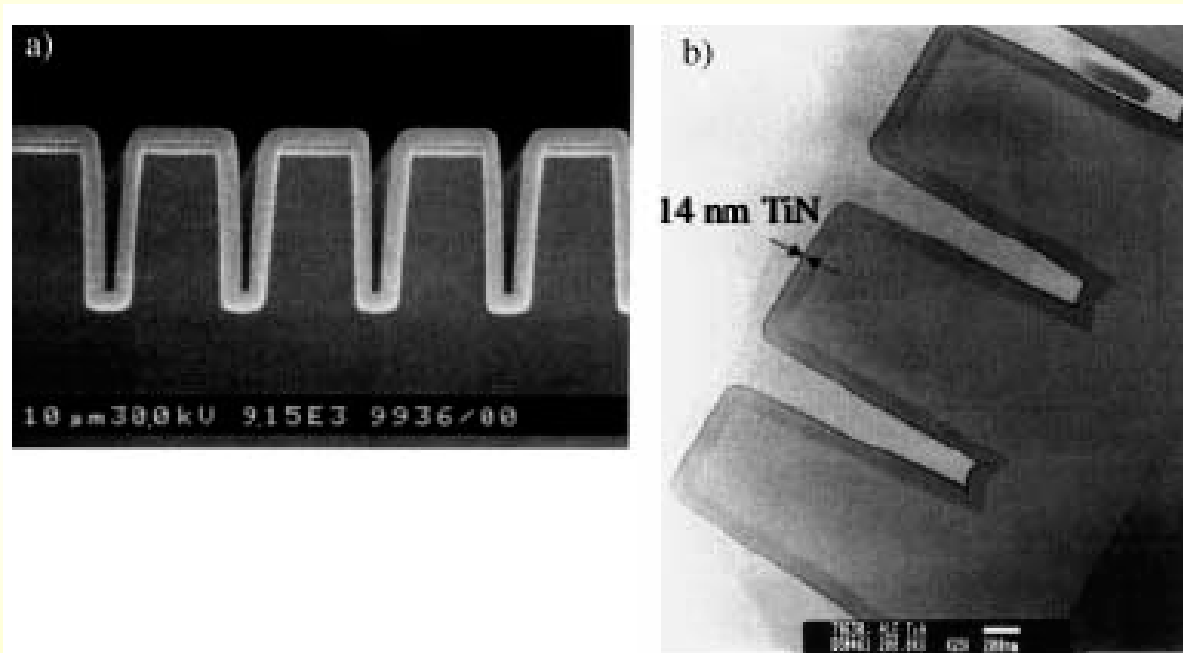

Figure 2. Cross-sectional SEM images for a 300-nm Al_2O_3 film (a) and a 14-nm TiN film (b) deposited on a patterned silicon substrate.

Precursor Properties

Selection of suitable combination of precursors

Molecular size influences film thickness

Gases, volatile liquids, solids with high vapor pressure

Typical precursors:

Metallic - halogenides (chlorides), alkyls, alkoxides, organometallics (cyclopentadienyl complexes), alkyl amides

Nonmetallic - water, hydrogen peroxide, ozone, hydrides, ammonia, hydrazine, amines

Precursor Properties

Thermally stable

**Must react with surface centers
(hydroxyl groups on oxide surface)**

Thermodynamics

Kinetics

Mechanisms

Examples of ALD

High-permittivity Oxides

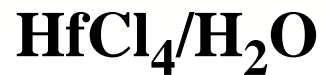
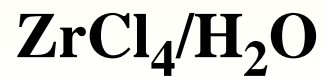
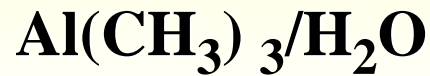

NMOS Transistor
(n-channel MOSFET)

From Computer Desktop Encyclopedia
© 2004 The Computer Language Co. Inc.

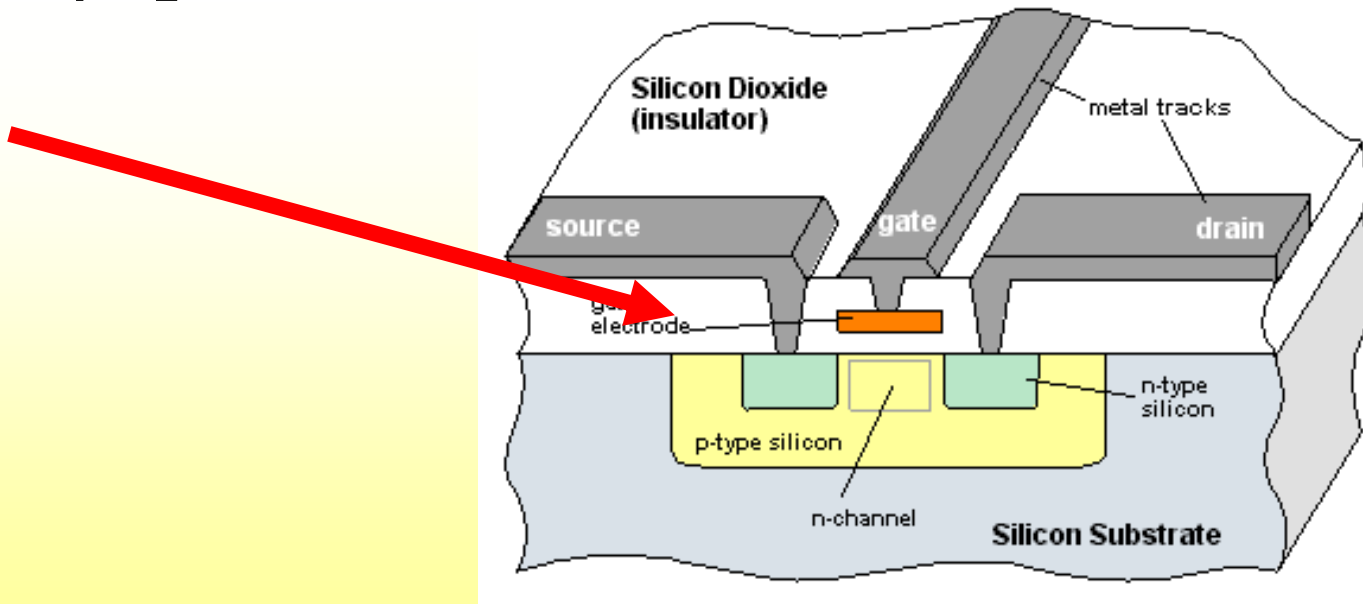

CVD

Examples of ALD

DRAM capacitors

**(Ba,Sr)TiO₃ – Sr and Ba cyclopentadienyl compounds
and water as precursors**

Nitrides of transition metals

TiN - TiCl₄ and NH₃

TaN - TaCl₅/Zn/NH₃

WN - WF₆ and NH₃

WC_xN_y

Examples of ALD

Metallic films

**Difficult by ALD: metal surface has no reaction sites,
low reactivity with reducing agents**

W - WF_6 and Si_2H_6

Ru, Pt - organometallic precursors and oxygen

**applies to all precious metals capable of catalytic
dissociation of O_2**

**Ni, Cu – metal oxide reduction by hydrogen radicals
formed in plasma**

Al – direct reduction of AlMe_3 by H radicals from plasma

ALD of SiO₂ and Al₂O₃ Films

Precursors: trimethylalane, tris(tert-butoxy)silanol

Deposition of amorphous SiO₂ and nanolaminates of Al₂O₃

32 monolayers in 1 cycle

Applications:

microelectronics

optical filters

protective layers (against diffusion, oxidation, corrosion)

ALD of SiO₂ and Al₂O₃ Films

Step A

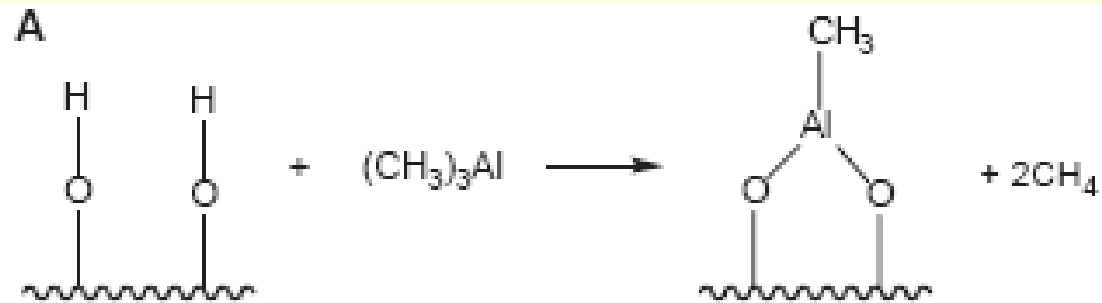

Step B

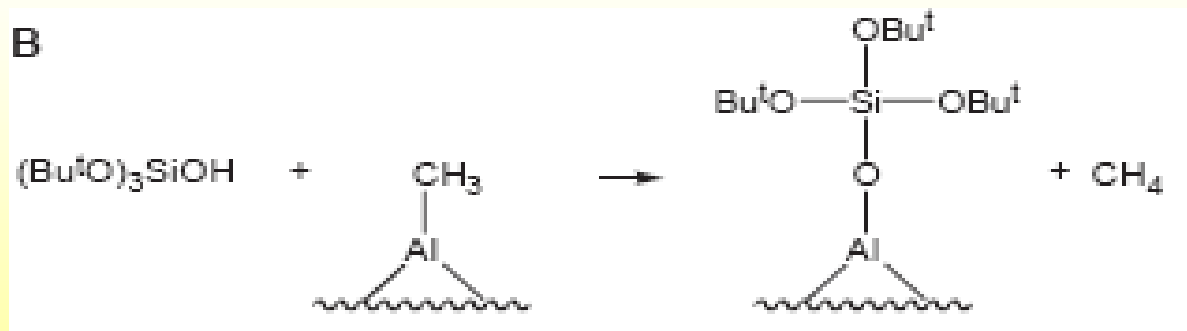

CVD

ALD of SiO₂ and Al₂O₃ Films

C, D: alkoxide - siloxide exchange

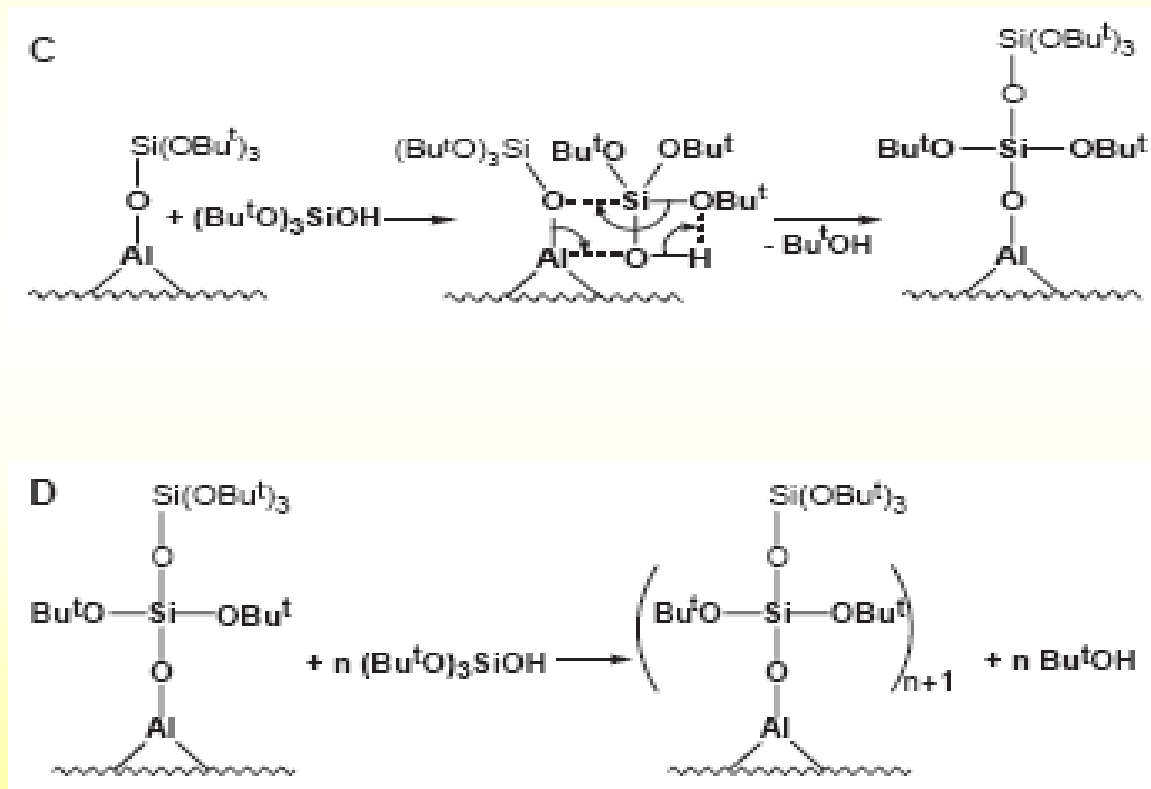

ALD of SiO_2 and Al_2O_3 Films

E: elimination of isobutene = formation of -OH

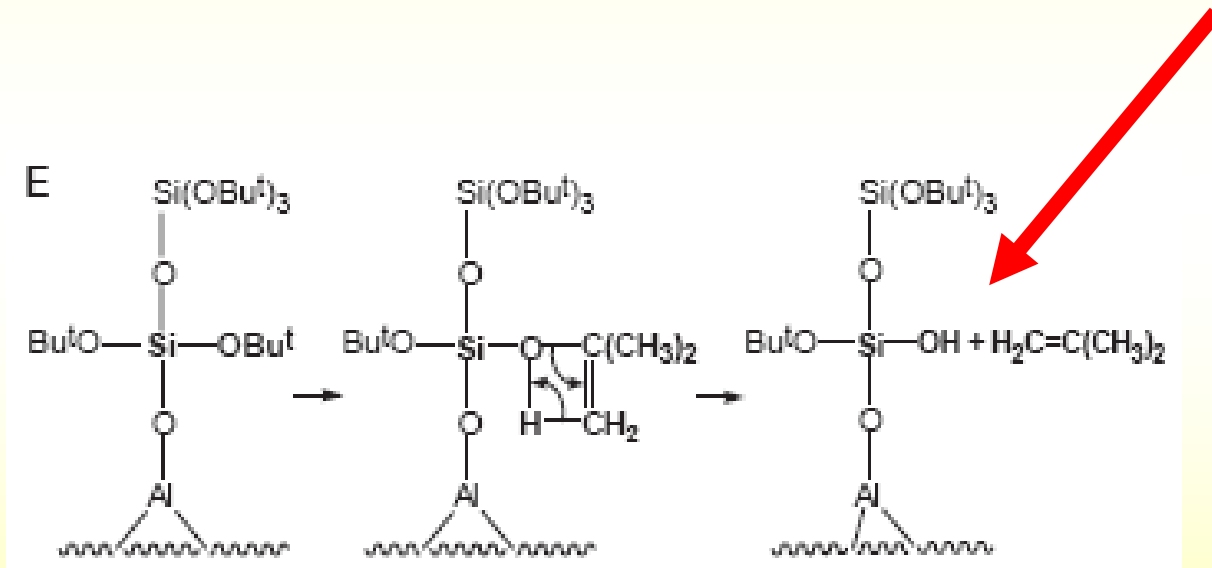

ALD of SiO_2 and Al_2O_3 Films

F: elimination of butanol = condensation

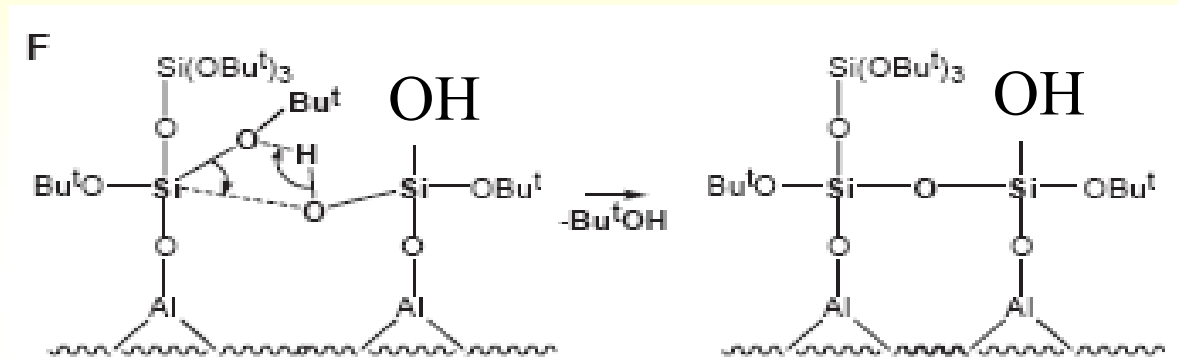

G: elimination of water = condensation

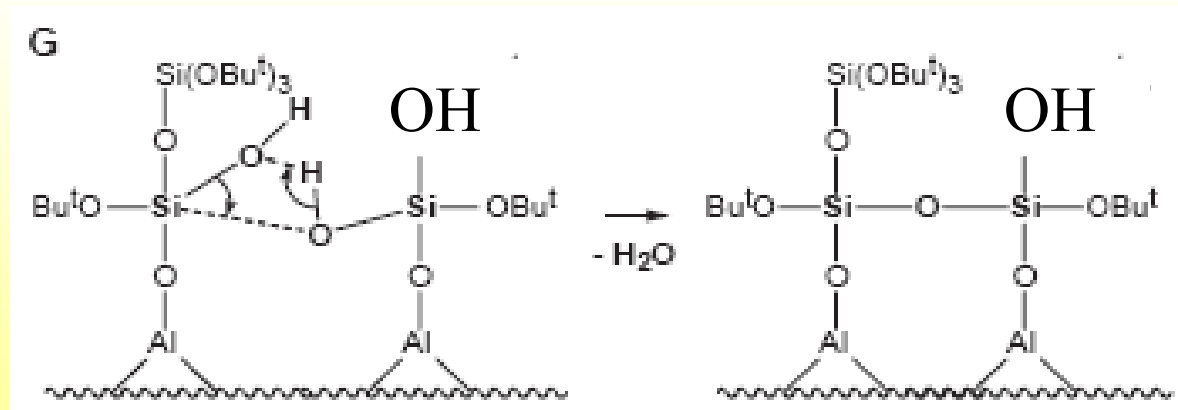

CVD

ALD of SiO₂ and Al₂O₃ Films

Repeat Step A

