

Learning outcomes (Lecture 2a)

Understanding:

- Detailed mechanism of NER in *E. coli*
- The defect in NER in xeroderma pigmentosum (XP)
- The genetic heterogeneity of XP
- Global genome repair and transcription-coupled DNA repair

Removal of damage

Base excision repair (BER)

Removes damaged base by breaking bond between base and sugar

Nucleotide excision repair (NER)

Removes damaged base(s) as part of an oligonucleotide fragment

(A2, A7)

UvrA protein

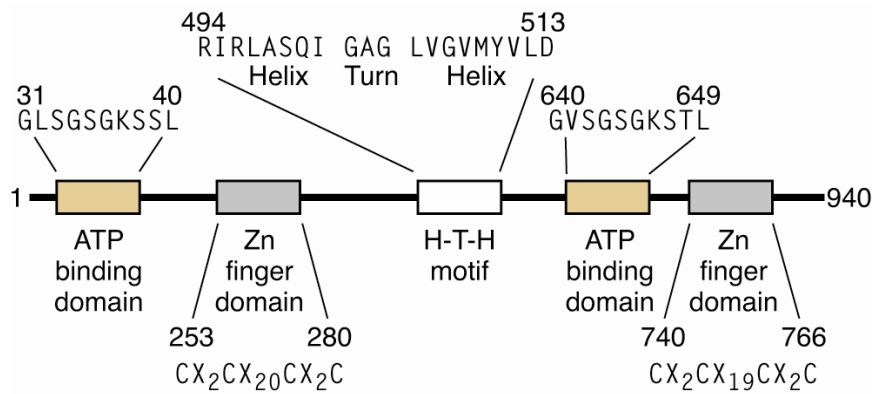

Action of UvrA₂B

UvrA is a DNA-binding protein

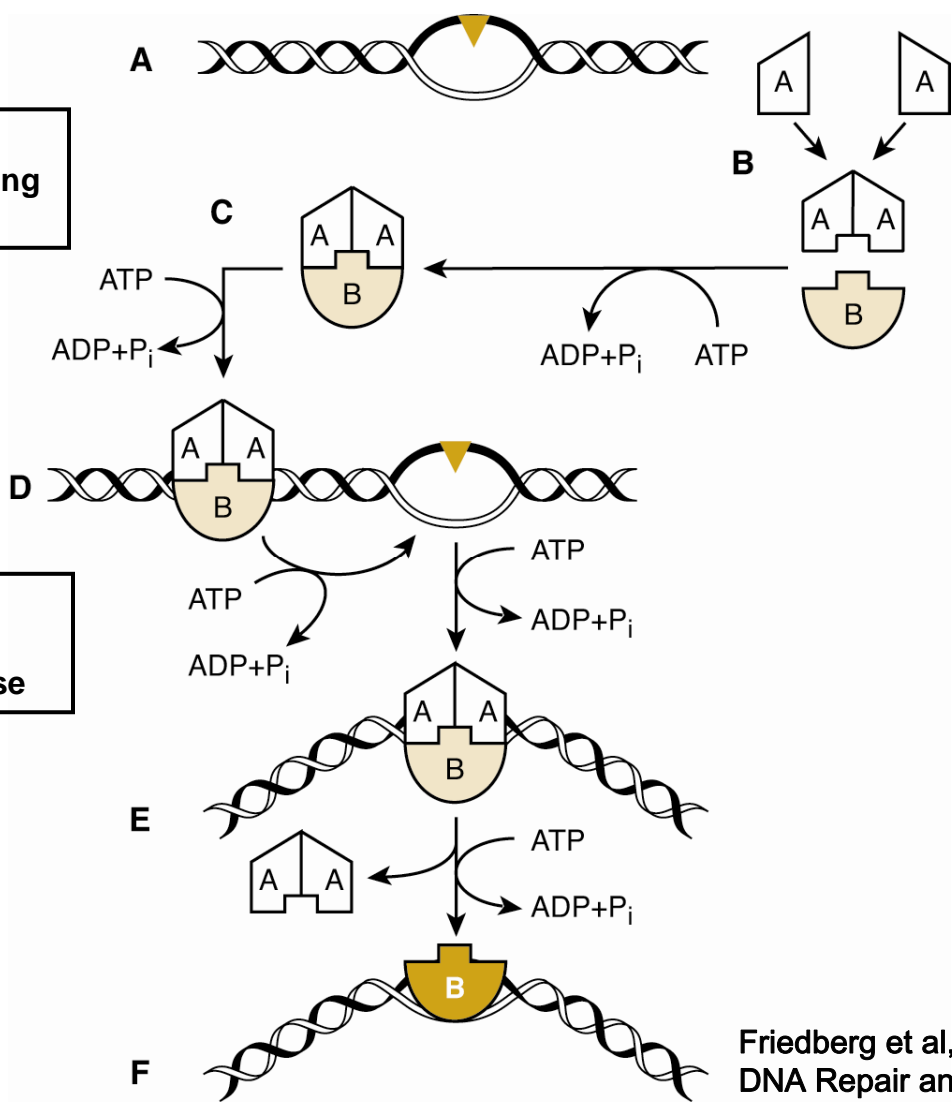

UvrB is a helicase/translocase

2.3

Friedberg et al, 2005
DNA Repair and Mutagenesis

Incision by UvrC

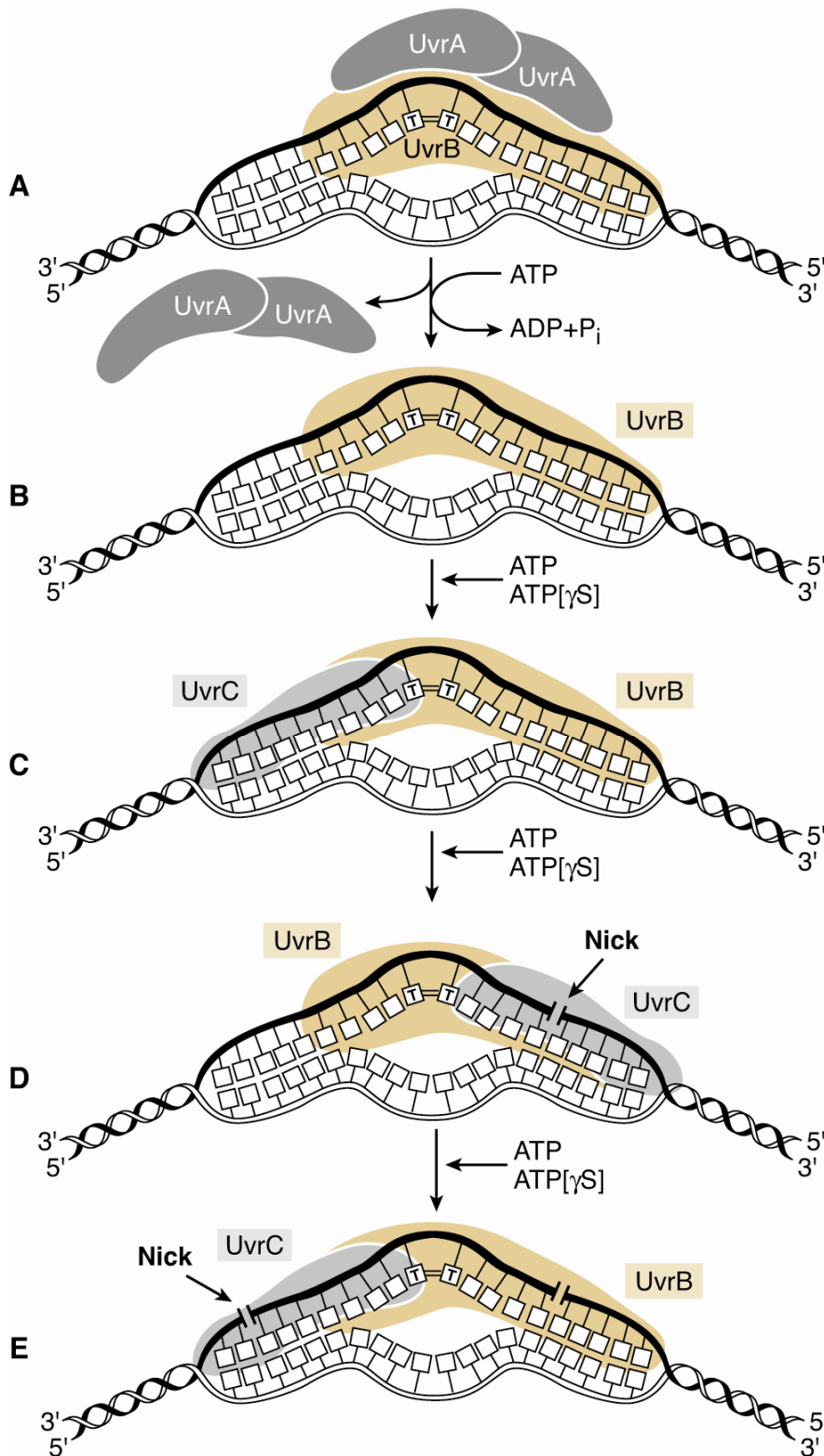

Late steps of NER

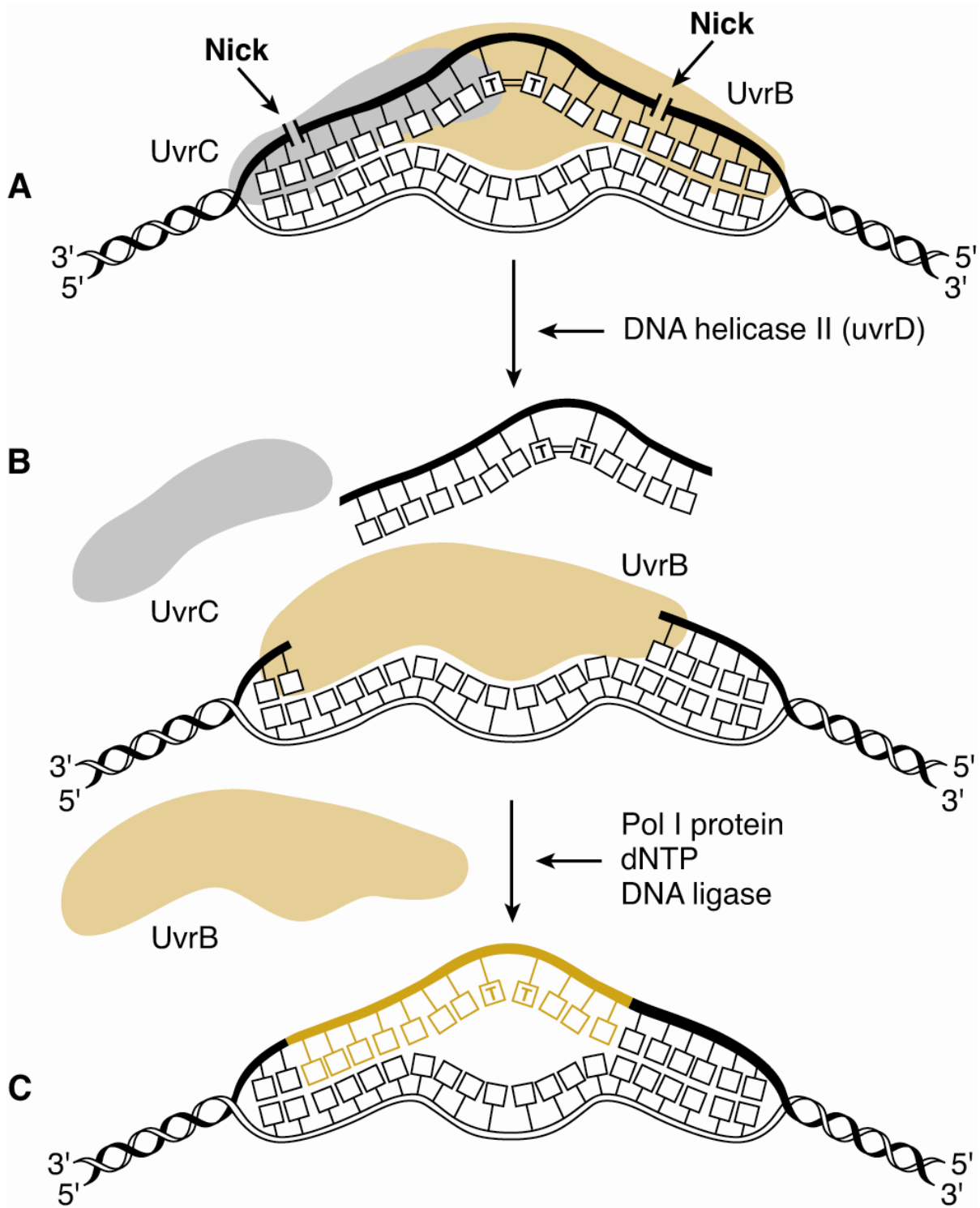

UV-sensitive mutants

Epistasis analysis in yeast

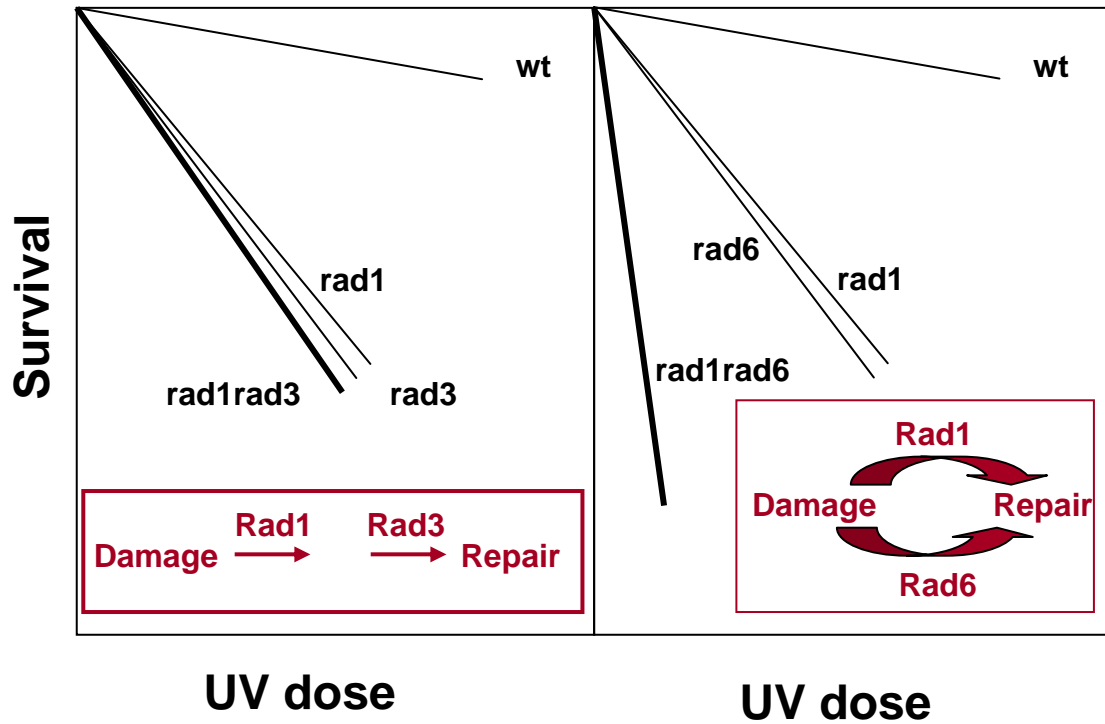

Rad3 epistasis group is involved in NER.
More than 10 genes.

Xeroderma Pigmentosum Patients

XP-C

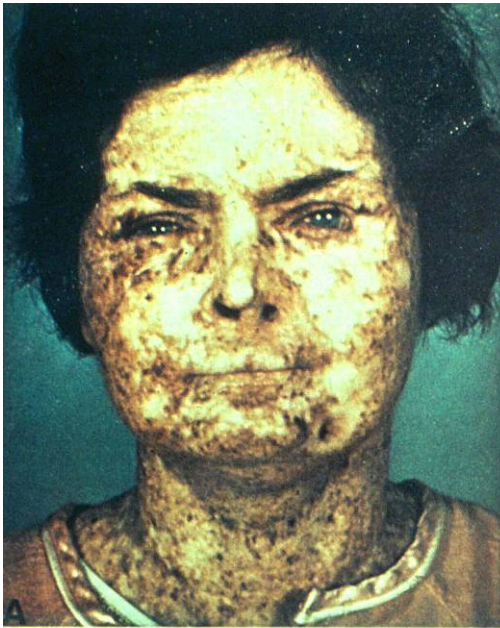

XP-V

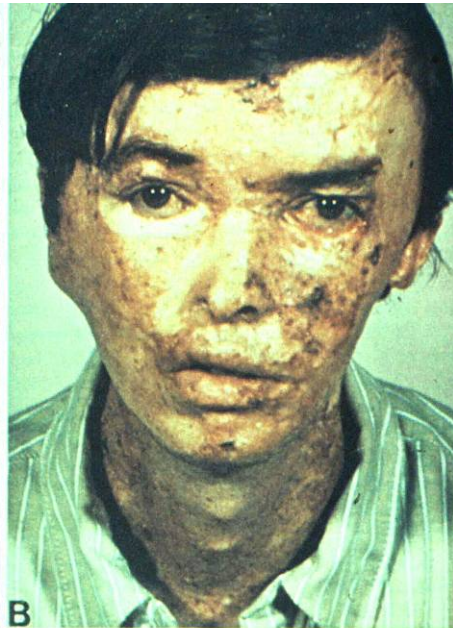

XP-D

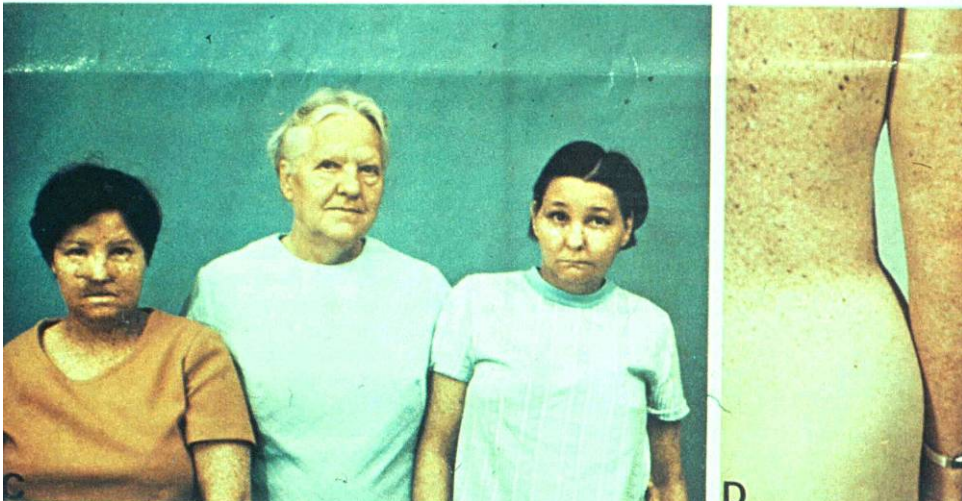

**Robbins et al
1974**

Clinical symptoms of repair-deficient diseases

- 1. Xeroderma pigmentosum (XP).** Sensitivity of skin to sunlight: freckles, pigmentation abnormalities, thickening of the skin, multiple skin cancers. In some case neurological abnormalities and mental retardation.
- 2. Trichothiodystrophy (TTD).** Sulphur deficient brittle hair, mental and physical retardation, ichthyosis (fish-like scaly skin), sun sensitivity, no cancer.
- 3. Cockayne Syndrome (CS).** Dwarfism, loss of adipose tissue, beaked nose, sunken eyes, premature ageing, skeletal abnormalities, severe mental retardation, retinal atrophy, sun sensitivity, no cancer.
- 4. HNPCC.** Familial non-polyposis colon carcinoma.
- 5. Familial breast cancer.**
- 6. Immunodeficiency (Ligase IV syndrome)** Microcephaly, mental retardation, unusual facial features, immune deficiencies (cellular and humoral)
- 7. Nijmegen Breakage Syndrome (NBS).** Microcephaly, mental retardation, unusual facial features, immune deficiencies (cellular and humoral), frequent infections, lymphomas, radiation sensitive. Chromosome aberrations.
- 8. Ataxia-telangiectasia (A-T).** Progressive cerebellar ataxia, telangiectasia, immune deficiencies (cellular and humoral), lymphoreticular cancers and carcinomas, radiation-sensitive. Chromosome aberrations.
- 9. Fanconi anaemia.** Bone marrow deficiency, abnormal pigmentation, skeletal deformities especially of radius and thumb, leukemias, and other cancers. Chromosome aberrations.
- 10. Bloom Syndrome.** Small size, sun-sensitive rash, immune deficiencies – infections, leukemias. Chromosome aberrations and SCE's.

UV-sensitive mutants

Epistasis analysis in yeast

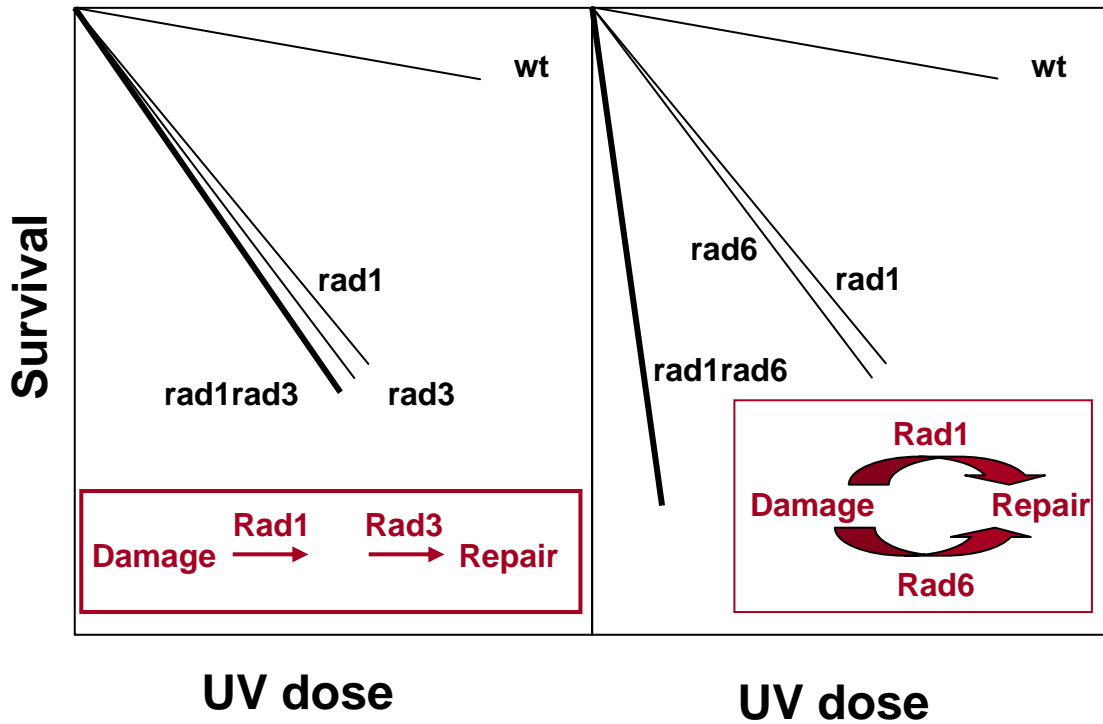

Rad3 epistasis group is involved in NER.
More than 10 genes.

Human cells

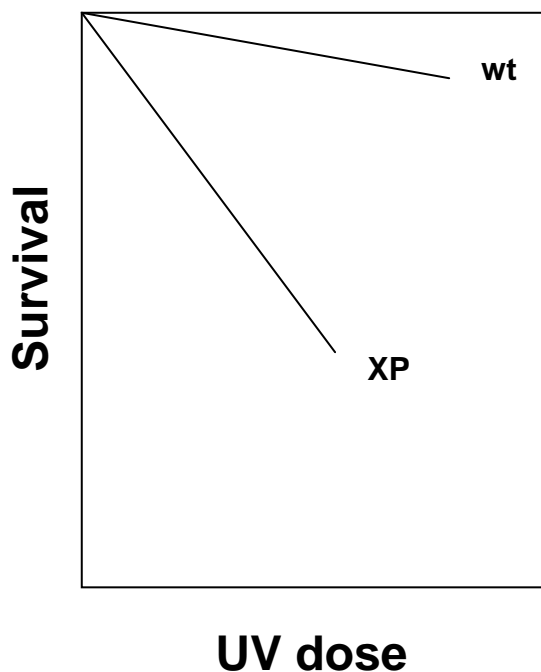

Unscheduled DNA Synthesis (UDS)

S phase nuclei

No UV

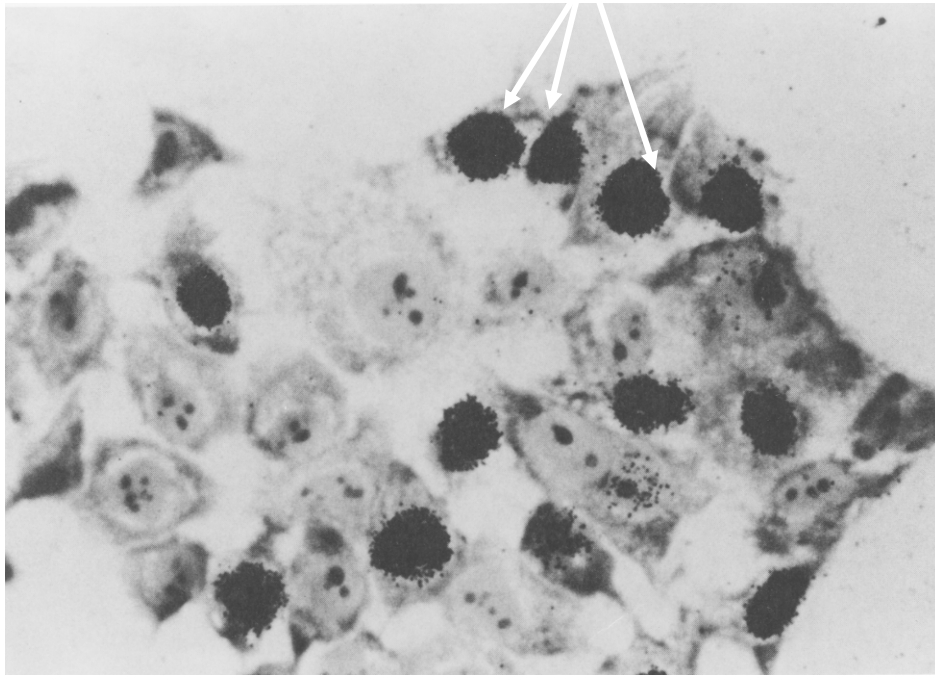

+ UV

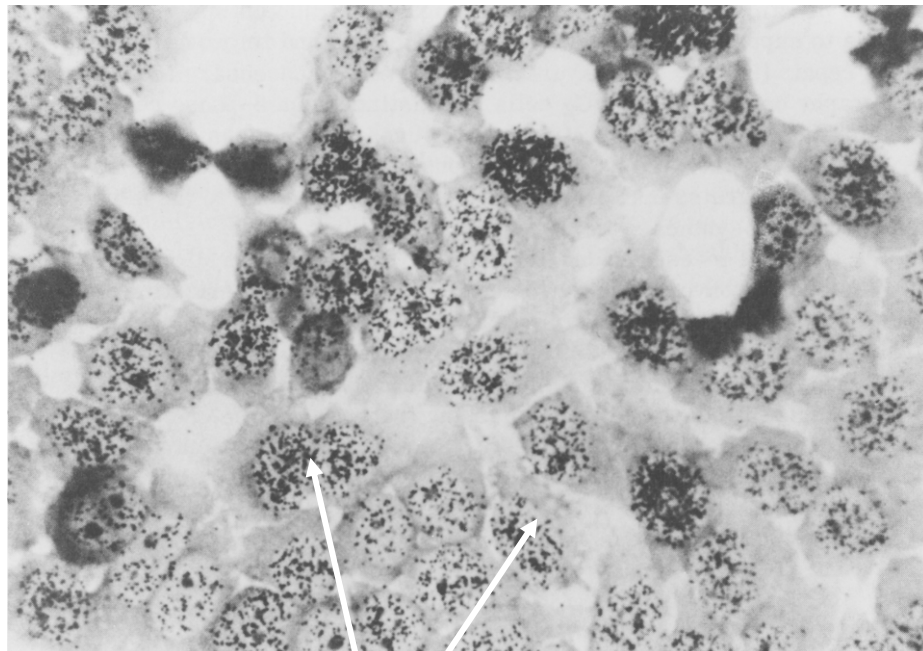

UDS in non-S phase nuclei

Absent in XP cells

Most XP patients are defective in NER

2.8

Diagnostic test for UDS

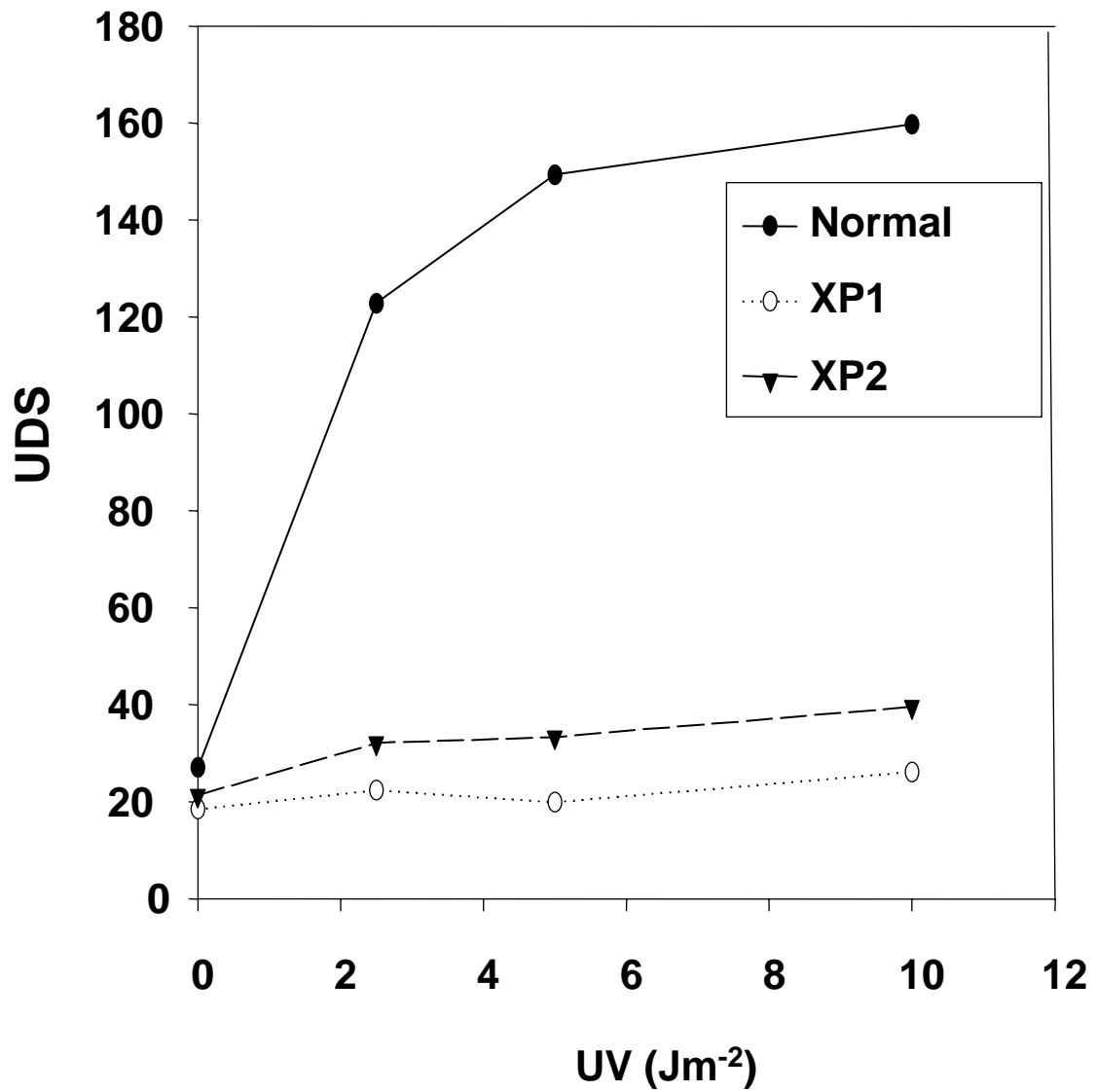

2.8a

Properties of XP, CS and TTD complementation groups

Clinical features				Repair characteristics		
Group	Skin Cancer	Neurological abnormalities	Relative frequency of occurrence	UV-sensitivity	Residual UDS*	Remarks
XP-A	+	++	high	+++	<5	
XP-B	+/-	+++/+	very rare	++	<10	Combined XP/CS or TTD
XP-C	+	-	high	+	15-30	Deficient in 'global genome' repair. Normal transcription-coupled repair
XP-D	+	++/-	intermediate	++	15-50	Includes patients with TTD and patients with XP/CS
XP-E	+/-	-	rare	±	>50	
XP-F	+/-	-	rare/ intermediate	+	15-30	
XP-G	+/-	+++/+	rare	++	<10	Includes patients with XP/CS
XP-V	+	-	high	+	100	Defective in post-replication repair. Normal NER
CS-A	-	++	rare	+	100	Defective in transcription-coupled repair 'Global genome' repair normal
CS-B	-	++	high	+	100	Defective in transcription-coupled repair 'Global genome' repair normal
TTD-A	-	+	very rare	+	15	TTD

*Unscheduled DNA synthesis as a percentage of wild-type activity

XP, TTD and CS

XP



TTD



Cockayne
Syndrome



A. CLINICAL SYMPTOMS OF REPAIR-DEFICIENT DISEASES

- 1. Xeroderma pigmentosum (XP).** Sensitivity of skin to sunlight: freckles, pigmentation abnormalities, thickening of the skin, multiple skin cancers. In some case neurological abnormalities and mental retardation.
- 2. Trichothiodystrophy (TTD).** Sulphur deficient brittle hair, mental and physical retardation, ichthyosis (fish-like scaly skin), sun sensitivity, no cancer.
- 3. Cockayne Syndrome (CS).** Dwarfism, loss of adipose tissue, beaked nose, sunken eyes, premature ageing, skeletal abnormalities, severe mental retardation, retinal atrophy, sun sensitivity, no cancer.
- 4. HNPCC.** Familial non-polyposis colon carcinoma.
- 5. Familial breast cancer.**
- 6. Immunodeficiency (Ligase IV syndrome)** Microcephaly, mental retardation, unusual facial features, immune deficiencies (cellular and humoral)
- 7. Nijmegen Breakage Syndrome (NBS).** Microcephaly, mental retardation, unusual facial features, immune deficiencies (cellular and humoral), frequent infections, lymphomas, radiation sensitive. Chromosome aberrations.
- 8. Ataxia-telangiectasia (A-T).** Progressive cerebellar ataxia, telangiectasia, immune deficiencies (cellular and humoral), lymphoreticular cancers and carcinomas, radiation-sensitive. Chromosome aberrations.
- 9. Fanconi anaemia.** Bone marrow deficiency, abnormal pigmentation, skeletal deformities especially of radius and thumb, leukemias, and other cancers. Chromosome aberrations.
- 10. Bloom Syndrome.** Small size, sun-sensitive rash, immune deficiencies – infections, leukemias. Chromosome aberrations and SCE's.

Properties of XP, CS and TTD complementation groups

Clinical features				Repair characteristics		
Group	Skin Cancer	Neurological abnormalities	Relative frequency of occurrence	UV-sensitivity	Residual UDS*	Remarks
XP-A	+	++	high	+++	<5	
XP-B	+/-	+++/+	very rare	++	<10	Combined XP/CS or TTD
XP-C	+	-	high	+	15-30	Deficient in 'global genome' repair. Normal transcription-coupled repair
XP-D	+	++/-	intermediate	++	15-50	Includes patients with TTD and patients with XP/CS
XP-E	+/-	-	rare	±	>50	
XP-F	+/-	-	rare/ intermediate	+	15-30	Repair slow but prolonged
XP-G	+/-	+++/+	rare	++	<10	Includes patients with XP/CS
XP-V	+	-	high	+	100	Defective in post-replication repair. Normal NER
CS-A	-	++	rare	+	100	Defective in transcription-coupled repair 'Global genome' repair normal
CS-B	-	++	high	+	100	Defective in transcription-coupled repair 'Global genome' repair normal
TTD-A	-	+	very rare	+	15	TTD

*Unscheduled DNA synthesis as a percentage of wild-type activity

XP, TTD and CS

XP



TTD



Cockayne
Syndrome



A. CLINICAL SYMPTOMS OF REPAIR-DEFICIENT DISEASES

- 1. Xeroderma pigmentosum (XP).** Sensitivity of skin to sunlight: freckles, pigmentation abnormalities, thickening of the skin, multiple skin cancers. In some case neurological abnormalities and mental retardation.
- 2. Trichothiodystrophy (TTD).** Sulphur deficient brittle hair, mental and physical retardation, ichthyosis (fish-like scales), sun sensitivity, no cancer.
- 3. Cockayne Syndrome (CS).** Dwarfism, loss of adipose tissue, beaked nose, sunken eyes, premature ageing, skeletal abnormalities, severe mental retardation, retinal atrophy, sun sensitivity, no cancer.
- 4. HNPCC.** Familial non-polyposis colon carcinoma.
- 5. Familial breast cancer.**
- 6. Immunodeficiency (Ligase IV syndrome)** Microcephaly, mental retardation, unusual facial features, immune deficiencies (cellular and humoral)
- 7. Nijmegen Breakage Syndrome (NBS).** Microcephaly, mental retardation, unusual facial features, immune deficiencies (cellular and humoral), frequent infections, lymphomas, radiation sensitive. Chromosome aberrations.
- 8. Ataxia-telangiectasia (A-T).** Progressive cerebellar ataxia, telangiectasia, immune deficiencies (cellular and humoral), lymphoreticular cancers and carcinomas, radiation-sensitive. Chromosome aberrations.
- 9. Fanconi anaemia.** Bone marrow deficiency, abnormal pigmentation, skeletal deformities especially of radius and thumb, leukemias, and other cancers. Chromosome aberrations.
- 10. Bloom Syndrome.** Small size, sun-sensitive rash, immune deficiencies – infections, leukemias. Chromosome aberrations and SCE's.

UV sensitivity of CS cells

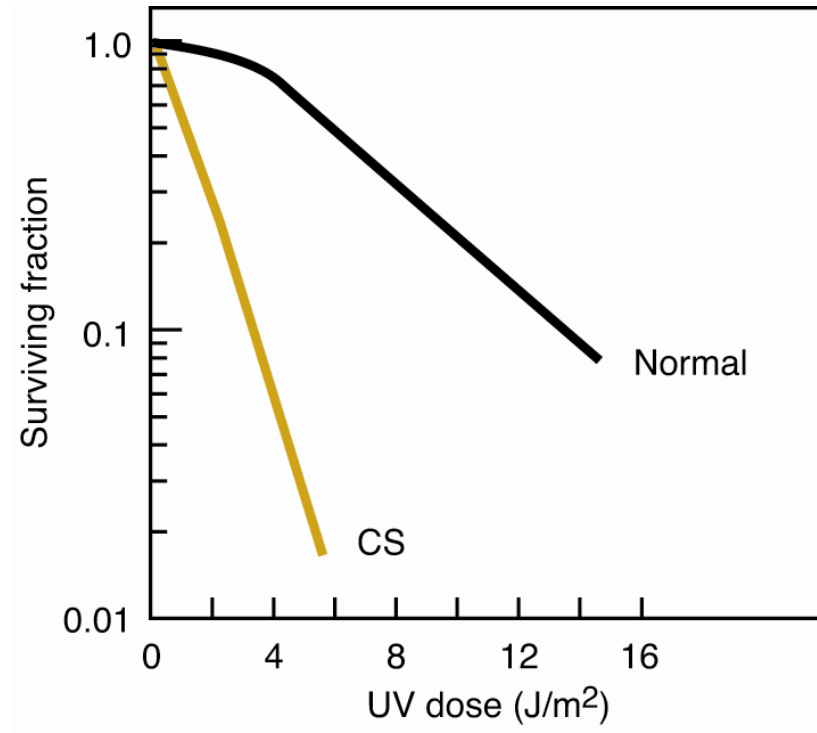

**UV sensitivity similar to XPs
But UDS is normal**

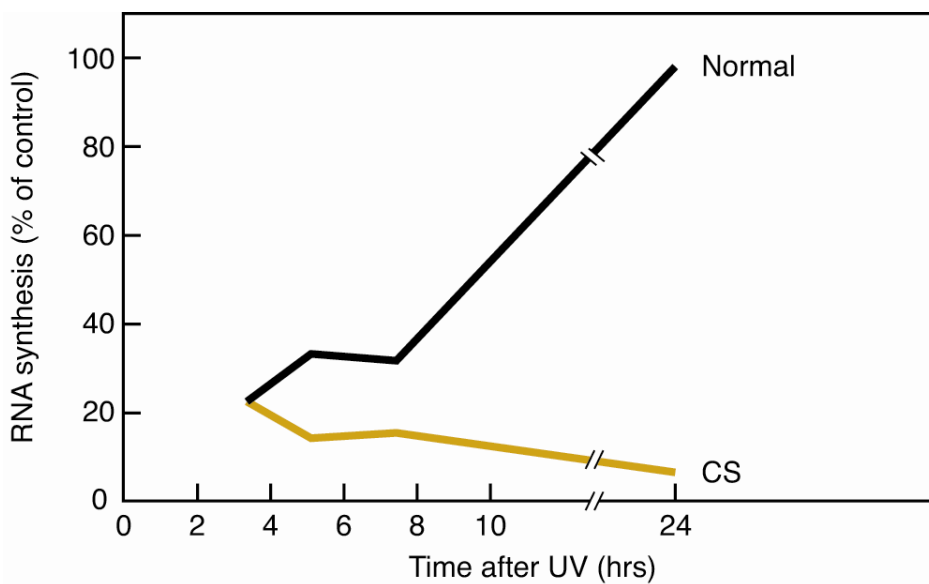

2.10

Friedberg et al, 2005
DNA Repair and Mutagenesis

Diagnostic test for CS

UV-irradiate cells. Incubate 24 h. Measure RNA synthesis.

E822RNA

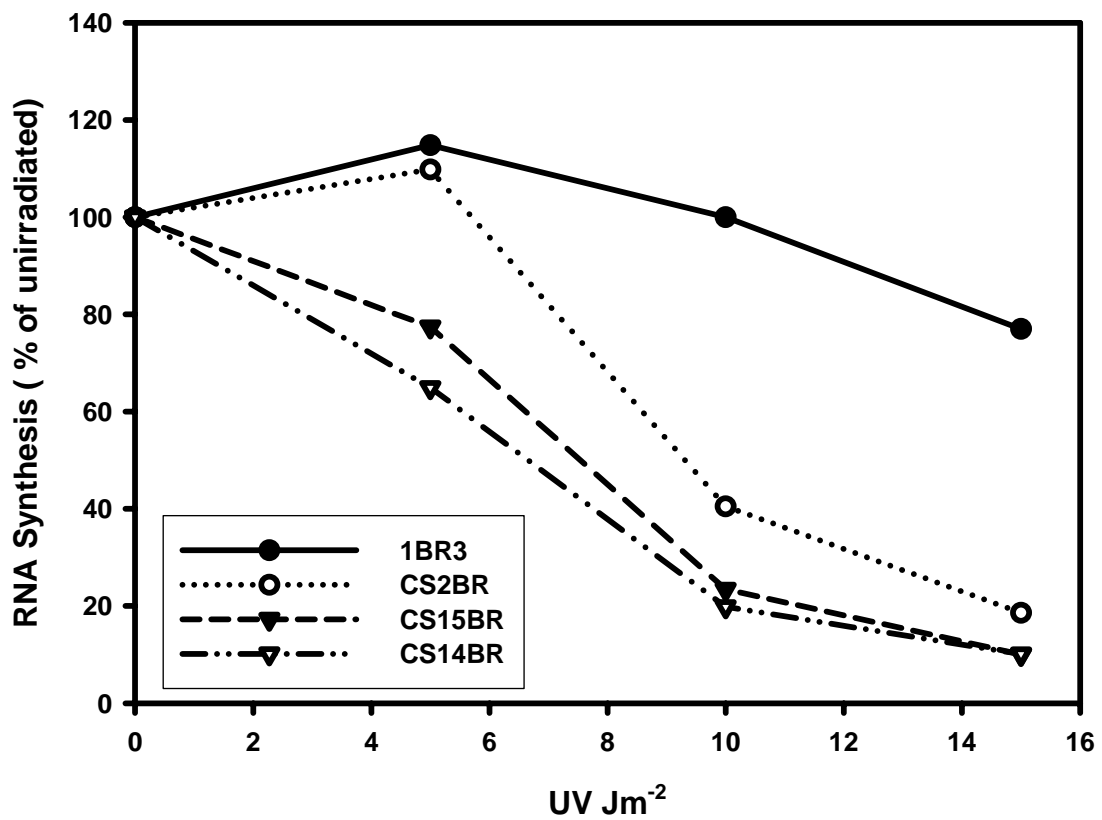

Properties of XP, CS and TTD complementation groups

Clinical features				Repair characteristics		
Group	Skin Cancer	Neurological abnormalities	Relative frequency of occurrence	UV-sensitivity	Residual UDS*	Remarks
XP-A	+	++	high	+++	<5	
XP-B	+/-	+++/+	very rare	++	<10	Combined XP/CS or TTD
XP-C	+	-	high	+	15-30	Deficient in 'global genome' repair. Normal transcription-coupled repair
XP-D	+	++/-	intermediate	++	15-50	Includes patients with TTD and patients with XP/CS
XP-E	+/-	-	rare	±	>50	
XP-F	+/-	-	rare/ intermediate	+	15-30	Repair slow but prolonged
XP-G	+/-	+++/+	rare	++	<10	Includes patients with XP/CS
XP-V	+	-	high	+	100	Defective in post-replication repair. Normal NER
CS-A	-	++	rare	+	100	Defective in transcription-coupled repair 'Global genome' repair normal
CS-B	-	++	high	+	100	Defective in transcription-coupled repair 'Global genome' repair normal
TTD-A	-	+	very rare	+	15	TTD

*Unscheduled DNA synthesis as a percentage of wild-type activity

Measurement of gene-specific repair

A Lyse cells immediately or incubate to allow repair.
Purify and restrict DNA **with selected enzyme**

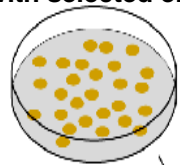

UV radiation (254 nm)

Treat (or not) with damage-specific endonuclease

Incubation time after DNA damage

0 Hours	24 Hours
---------	----------

Damage Endonuclease

-	+	-	+
---	---	---	---

D Southern blot analysis (alkaline gel)

Autoradiography

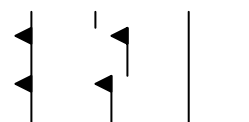
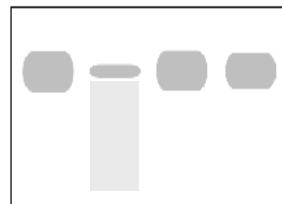

Modified from
Friedberg et al, 2005
DNA Repair and Mutagenesis
(Adapted from Bohr, 1991)

Hamster dhfr gene
 14kb Kpn1 fragment:
 10Jm⁻² 58% repair in 8 h

Bulk DNA:
 5 Jm⁻² 16% repair in 24 h

Transcription-coupled repair

Hours of repair	0	2	4	6	12	24
T4 denV	- +	- +	- +	- +	- +	- +
Transcribed strand	-----					
Non-transcribed strand	-----					

- **Rodent cells : CPD only repaired in transcribed strand of active genes**
- **Human cells: CPD repaired much faster in transcribed strands of active genes**
- **This is called Transcription-coupled repair (TCR)**
- **Repair of bulk DNA called global genome repair (GGR)**

- **CS cells defective in TCR
All repair at rate of GGR**
- **In contrast XP-C, not v. sensitive, but UDS low, 10-15%
XP-C cells only carry out TCR, defective in GGR**

Summary (Lecture 2a)

- **NER in *E. coli* involves dual incisions and can be reconstituted with 6 proteins**
- **XP cells are defective in NER**
- **There are 8 XP complementation groups**
- **TTD cells are also defective in NER, mainly in XP-D group**
- **CS cells are specifically defective in TCR**
- **XP-C cells are specifically defective in GGR**

Learning outcomes (Lecture 2b)

Understanding:

- Detailed mechanism of NER in human cells
- The roles of the XP gene products
- The link via TFIIH between NER and transcription
- The mechanism of TCR and the roles of the CS proteins

HUMAN NER PROTEINS

Human protein	Yeast protein	AAs(MW - KD)	Protein function
XPA	Rad14	273 (31)	Damage verification
XPC +HR23B	Rad4 + Rad23	940 (106) + 409 (58)	Damage recognition
XPE (DDB2)		314 (48)	UV-DNA binding
ERCC1	Rad10	297 (31)	5' Nuclease subunit
XPF	Rad1	1050 (115)	5' Nuclease subunit
XPG	Rad2	1186 (133)	3' Nuclease
XPB	Rad3	760 (87)	TFIIH subunit, helicase
XPB	Rad25	782 (89)	TFIIH subunit, helicase
P62,P44, P52, P34, P10(TTDA)	Tfb1, Ssl1, Tfb2, Tfb3, Tfb5	548 (62), 395 (44), 464 (52), 303 (34), 71 (10)	TFIIH subunit
RPA(p70,p34,p14)	Rfa1, Rfa2, Rfa3	616, 270, 121 (70, 34, 14)	SS-DNA binding
PCNA	Pol30	261 (32)	Polymerase clamp
DNA pol δ , κ OR ϵ	Pol3 or Pol2		DNA polymerase
LIG1	Cdc9	919 (102)	DNA ligase

(A7)

GGR in humans

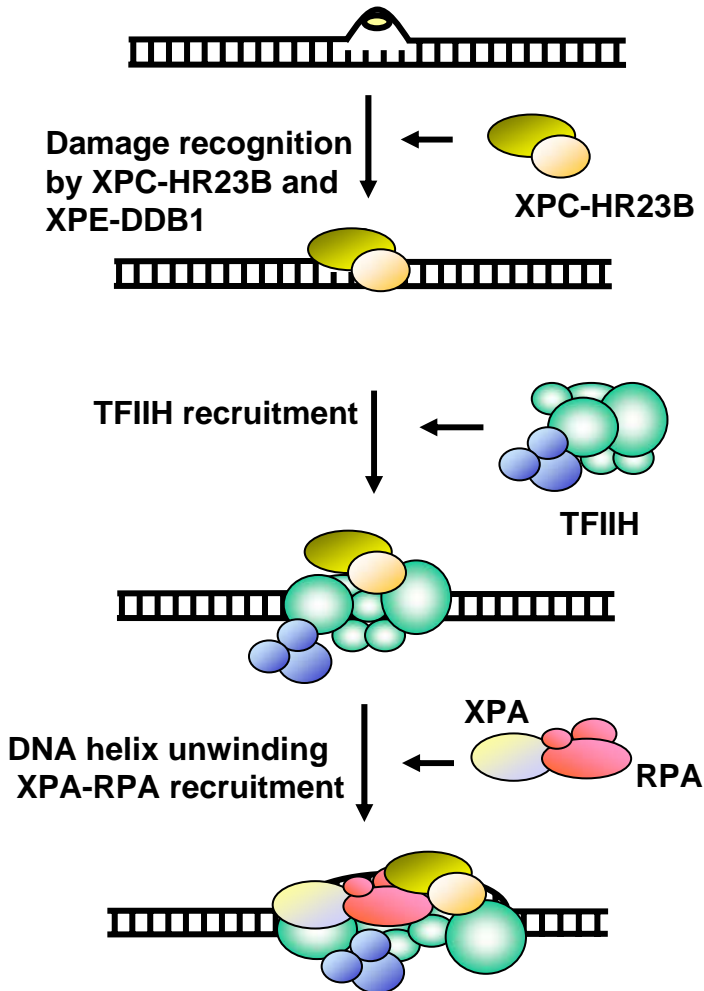

- Recognition – must detect 1 damaged base in 1 million undamaged bases
- XPC is a general damage recognition factor
- CPD not well recognised by XPC. 6-4PP are.
- Both recognised by DDB
- DDB is a heterodimer of DDB1 and DDB2
- DDB2 is the XPE protein
- DDB is part of large ubiquitin ligase complex.
- It binds to damage, then ubiquitinates and recruits XPC (not degraded).
- Also self-ubiquitinates and degrades itself.
- XPE not expressed in rodent cells.

Structures of DDB and XPC

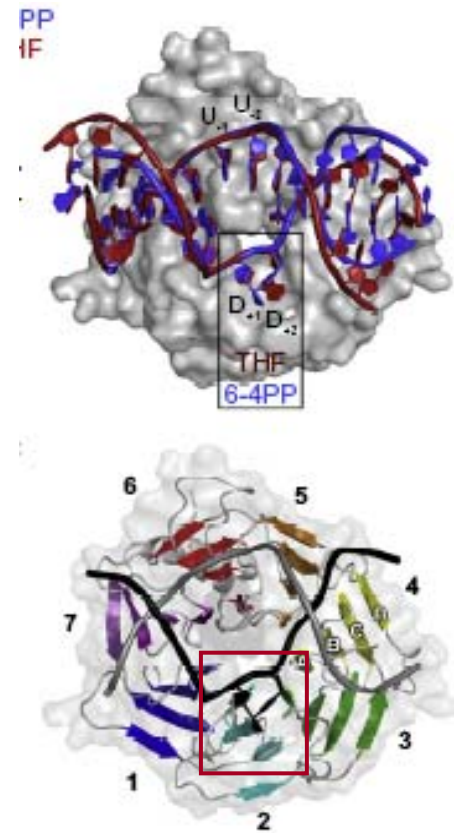
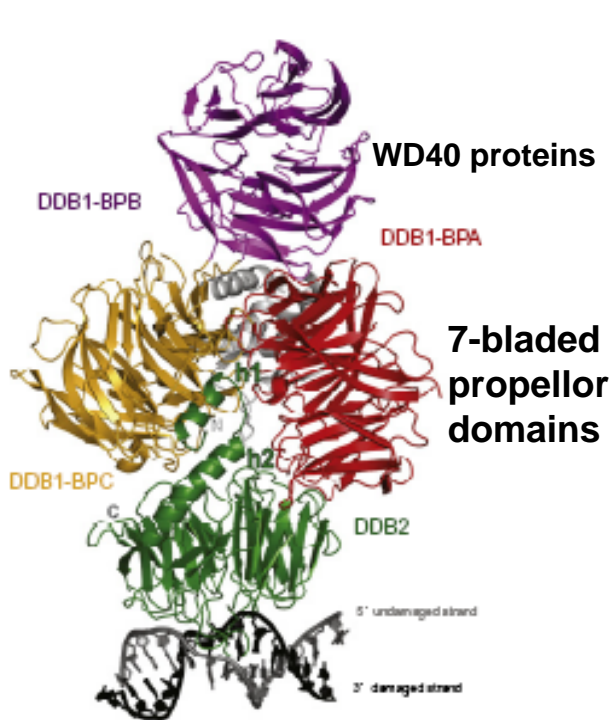

XPE (DDB2) binds flipped out 6-4PP in a pocket

Scrima et al, Cell 2008

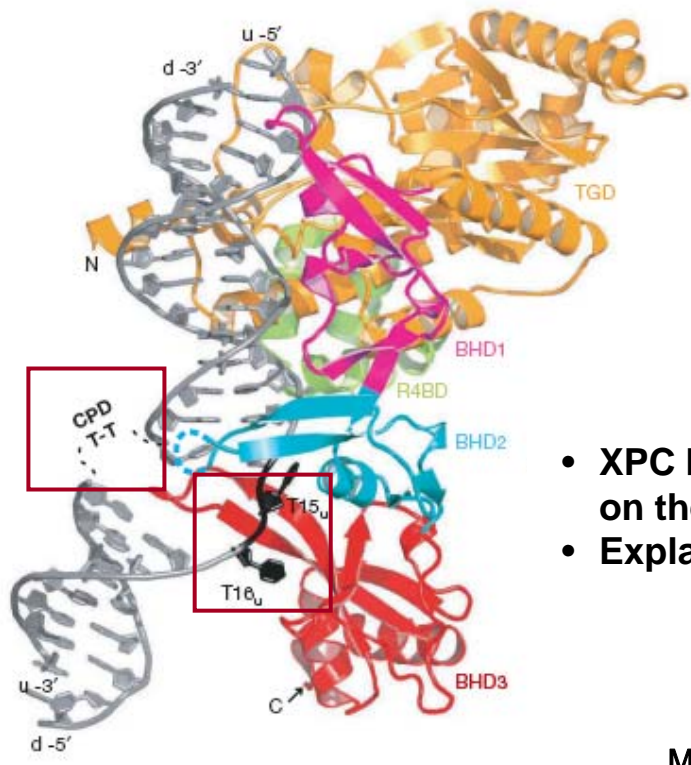

- XPC binds flipped out bases on the undamaged strand
- Explains broad specificity

2.18

Min and Pavletich, Nature 2007

XPD, XPB and TFIIH

- XPD highly homologous to Rad3, well studied, ATP-dependent DNA helicase.
- Apart from helicase activity, also a separate essential function, ie RAD3del lethal.
- Mutations found in XP-D and TTDs: mainly base-change mutns.
- XPB is another helicase of opposite polarity

TFIIH (A7)

- TFIIH, basal transcription initiation factor - ten subunits.
- P89 isolated, helicase activity and gene cloned and sequenced - it is XPB!, ie XPB is a subunit of TFIIH.
- XPD also.
- 10 subunits now cloned from yeast and humans.
- Products of these genes are therefore subunits of TFIIH, which has 2 functions, in NER and in transcription (essential function).
- XPB: part of TFIIH core and helicase activity is vital for transcription. Required to open up promoter site. Helicase activity not needed for NER. NB mutations can affect repair, transcription or both.
- XPD: not as tightly associated – helicase activity not needed for transcription, is needed for NER.
- TTDA (p8): not essential, only involved in NER.

TFIIH, XP and TTD

- All three genes associated with TTD (XPD, XPB and TTDA) encode subunits of TFIIH
- XP known to be a repair syndrome
- TTD proposed to be a “transcription syndrome”
- Slightly altered transcription must affect some proteins specifically, eg hair and myelin.

What is the evidence?

Prediction: Sites of *XPD* mutations differ between two syndromes

Mutations in *XPD* gene (B1)

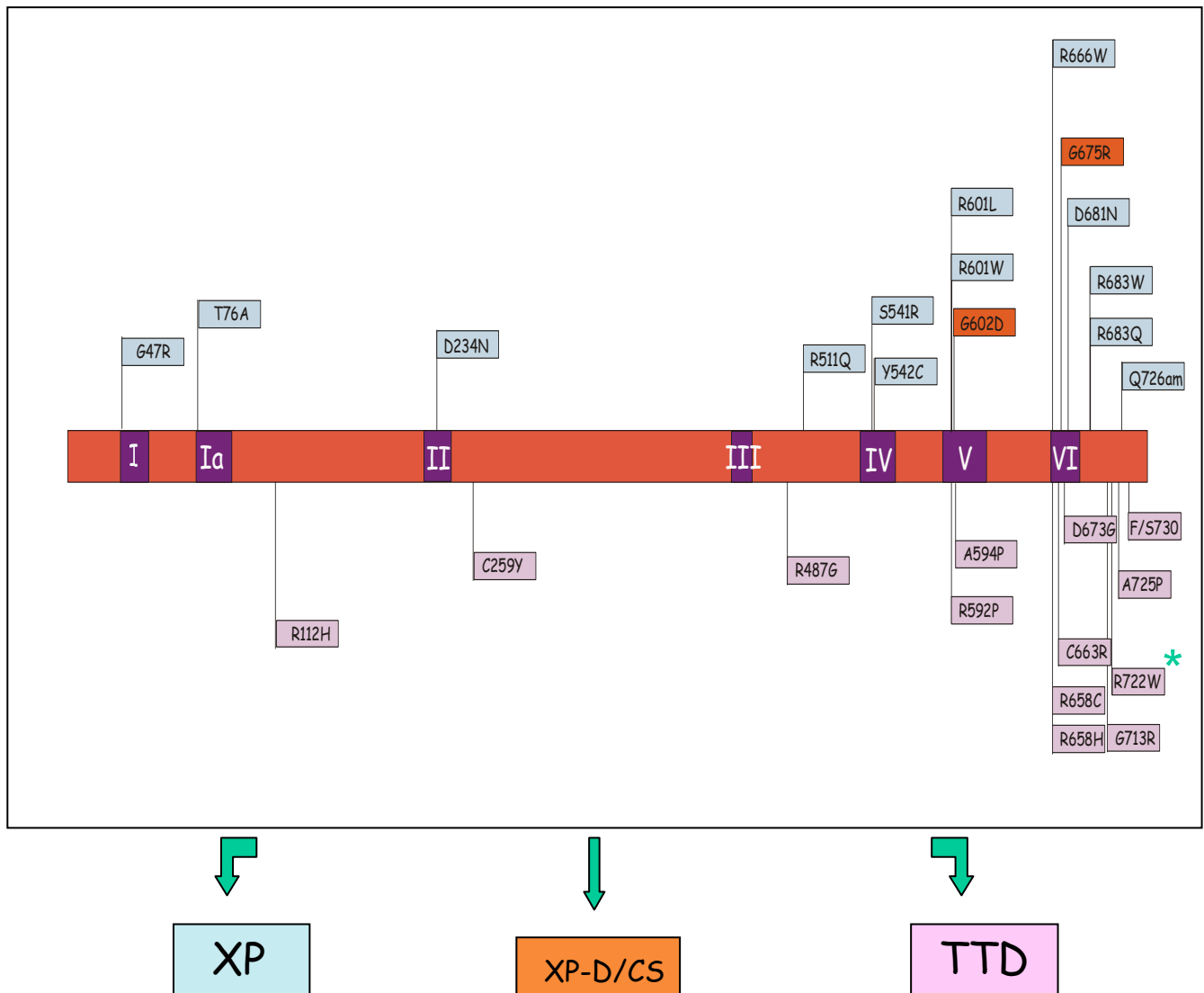

TTD
Mouse
(B2)



Structure of archaeal XPD (B3)

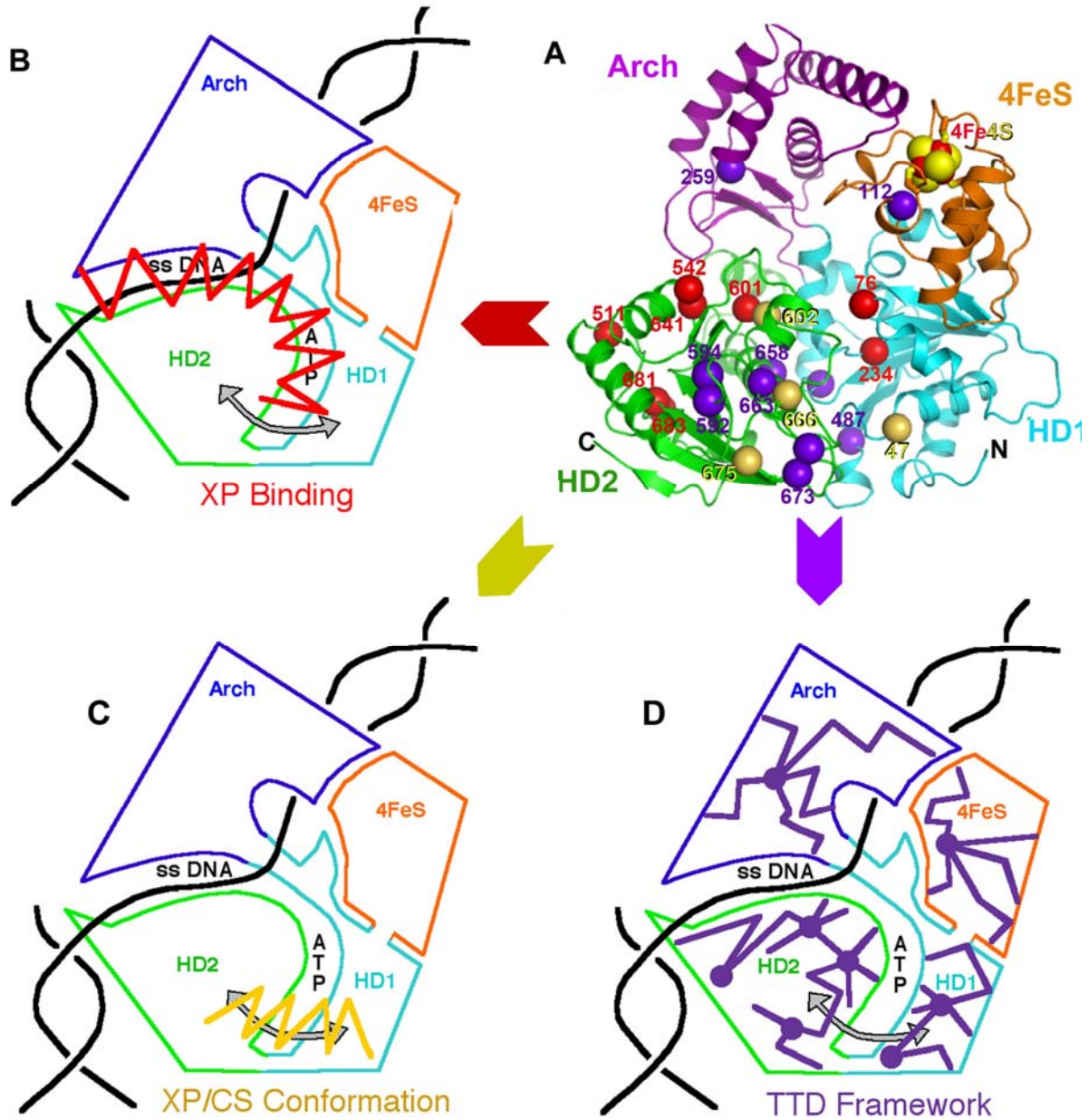

Red, XP mutations; purple, TTD mutations;
yellow, XP-CS mutations

Fan et al., Cell, 2008

GGR in humans

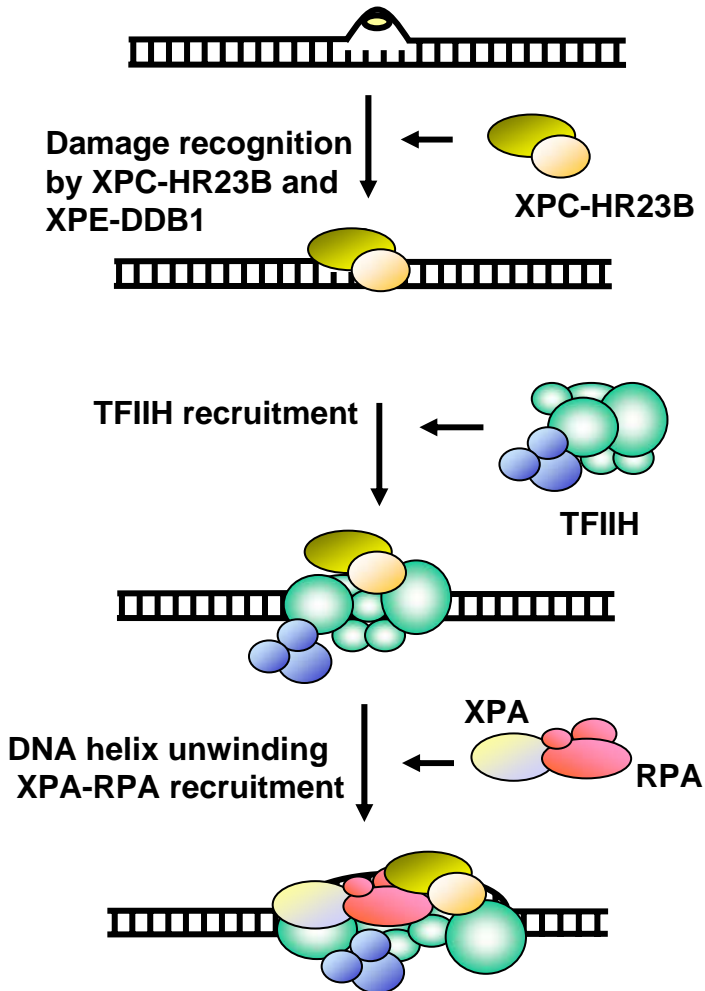

- CPD not well recognised by XPC. 6-4PP are.
- Both recognised by DDB
- DDB is a heterodimer of DDB1 and DDB2
- DDB2 is the XPE protein
- DDB is part of large ubiquitin ligase complex.
- It binds to damage then ubiquitinates and recruits XPC (not degraded).
- Also self-ubiquitinates and degrades itself.
- XPE not expressed in rodent cells.

XPA

- Zinc finger protein, binds more strongly to UV-irradiated DNA, homologous to yeast Rad14.
- Binding to UV-irradiated DNA increased by RPA.
- Originally thought to recognise damage. Now thought to verify damage and position everything.
- XPA and XPC knockouts - mice sensitive to UV light and susceptible to UV carcinogenesis. Gene not essential.

XPG, XPF-ERCC1

- XPG: structure specific nuclease, suitable for cutting 3' to damage.
- ERCC1 and XPF protein heterodimer is a nuclease, cuts 5' to damage.
- ERCC1 is not an XP gene. ERCC1 k/o mice died before weaning with liver failure.
- More severe than XPA mice. Implies another function for ERCC1.

Recruitment of NER proteins to damage: XPC before XPA

UV-irradiate cells through a microfilter results in
localised damage in the nucleus

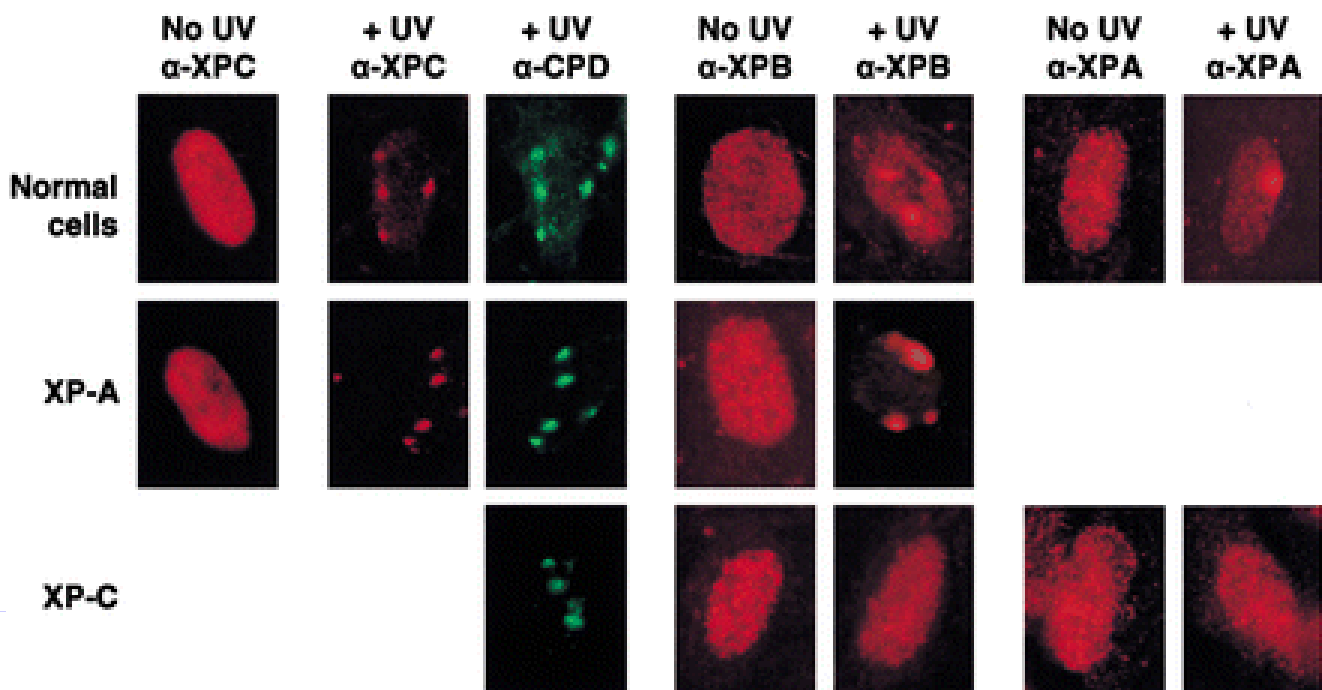

From Volker et al., Mol Cell 2001 (B4)

Sequential recruitment of NER proteins to damage

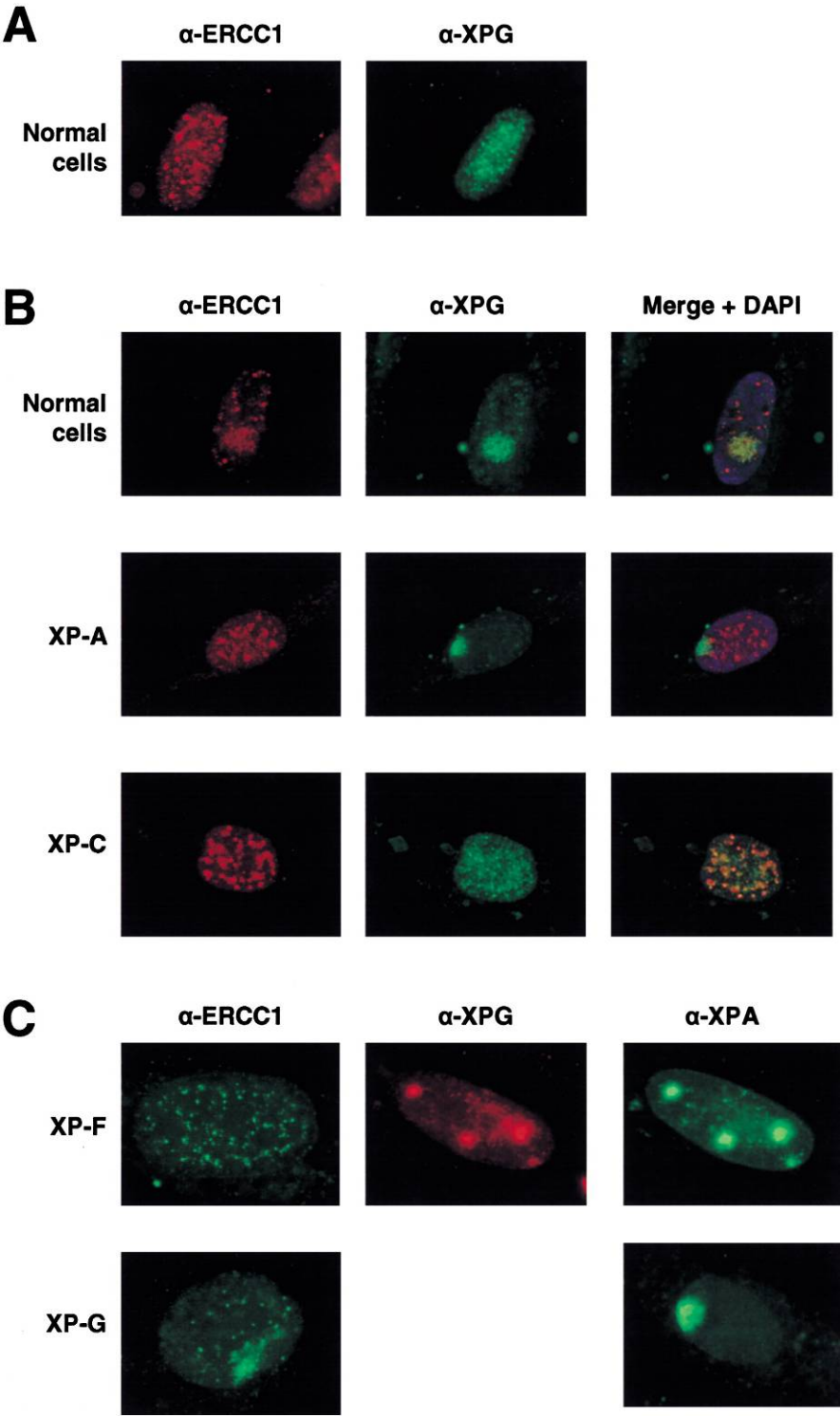

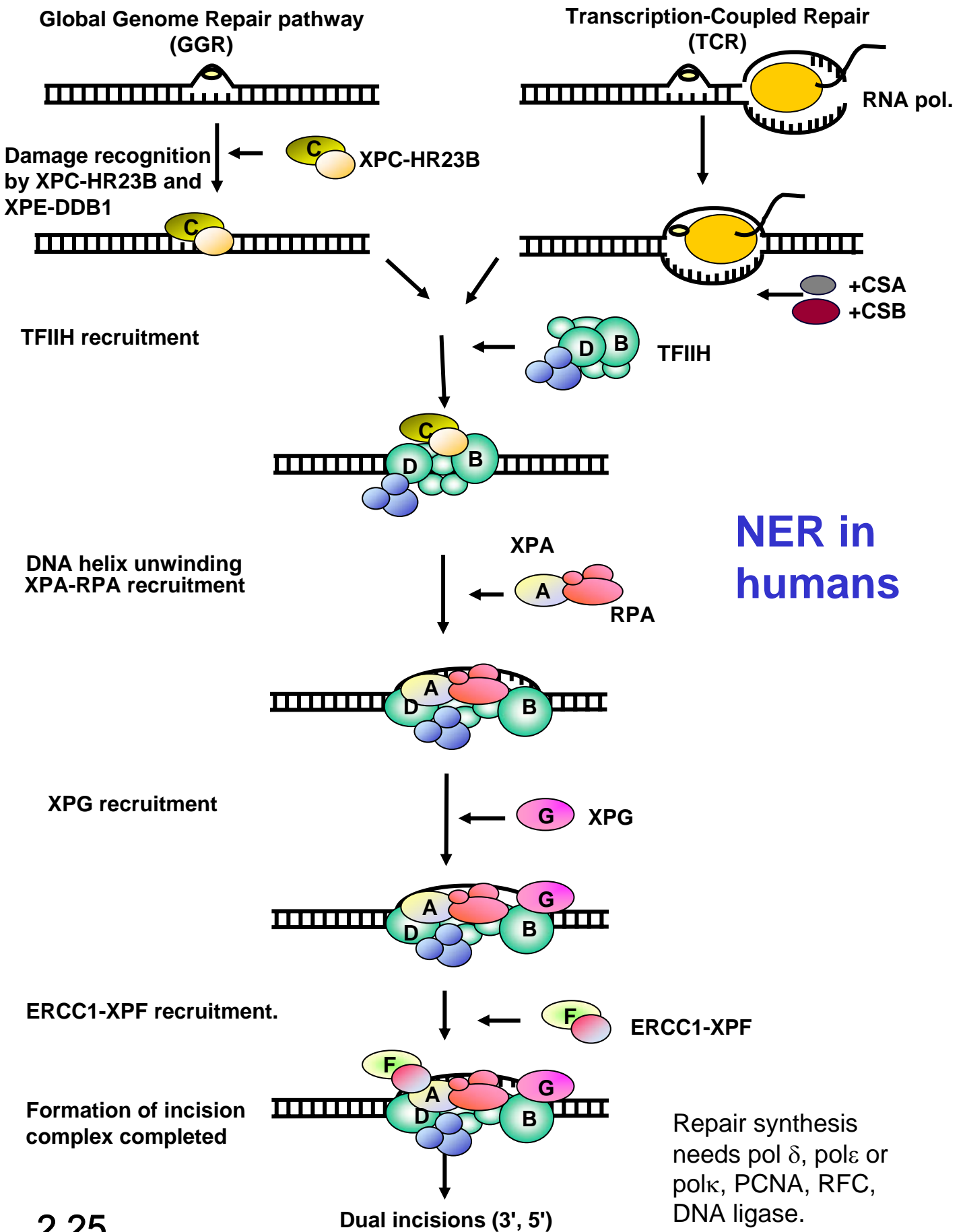

TRCF and NER (*E. coli*)

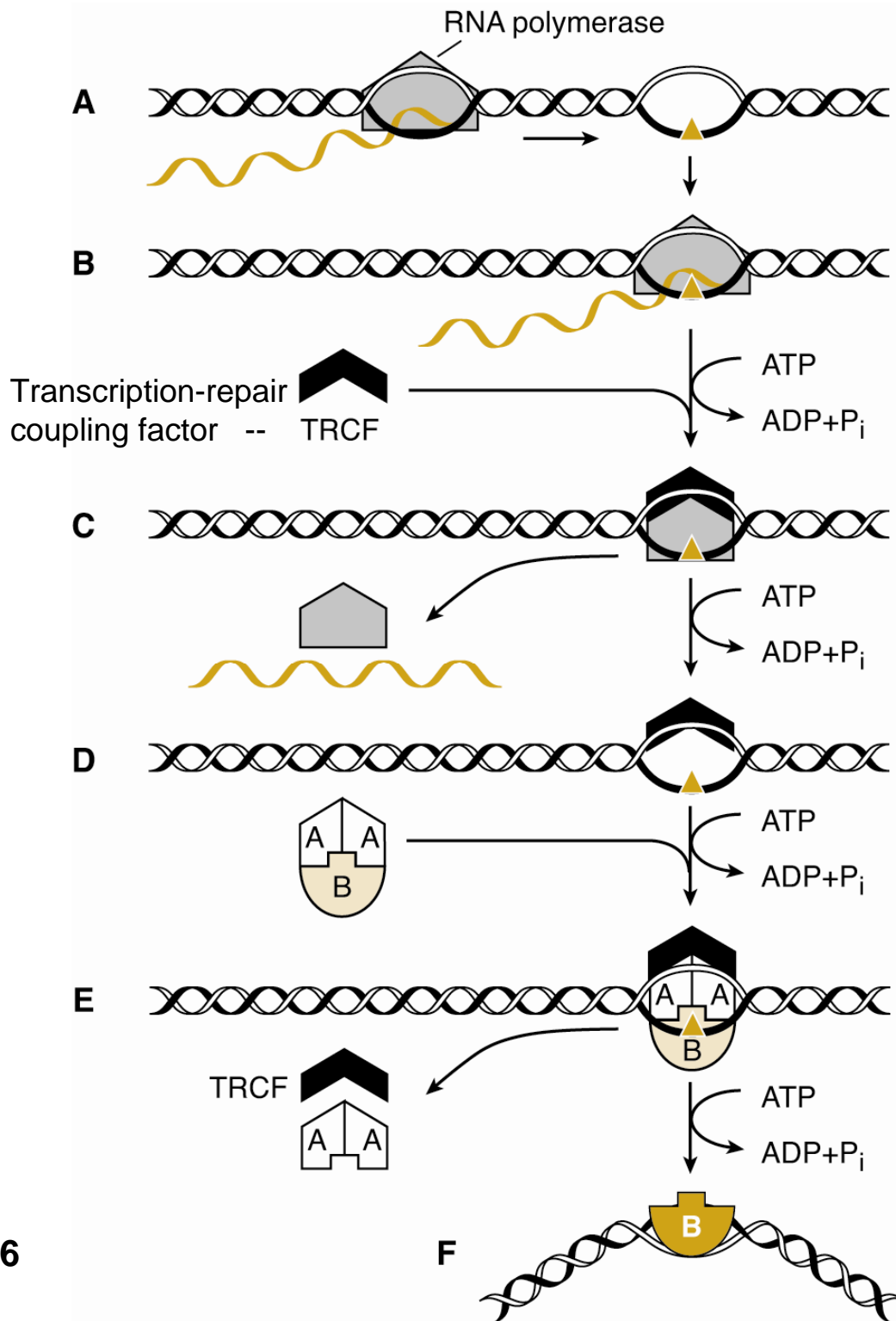

Assembly of TCR complex (B5)

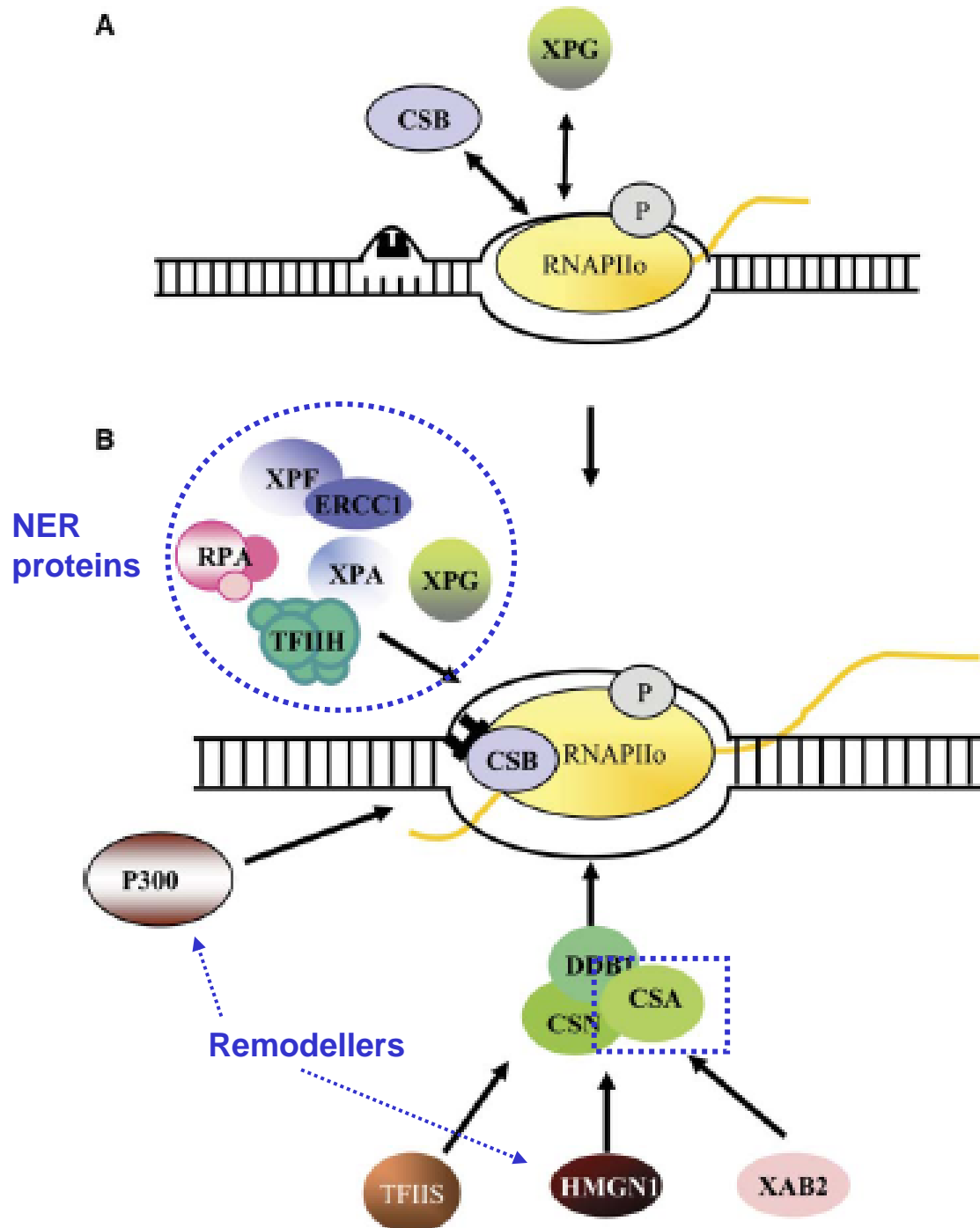

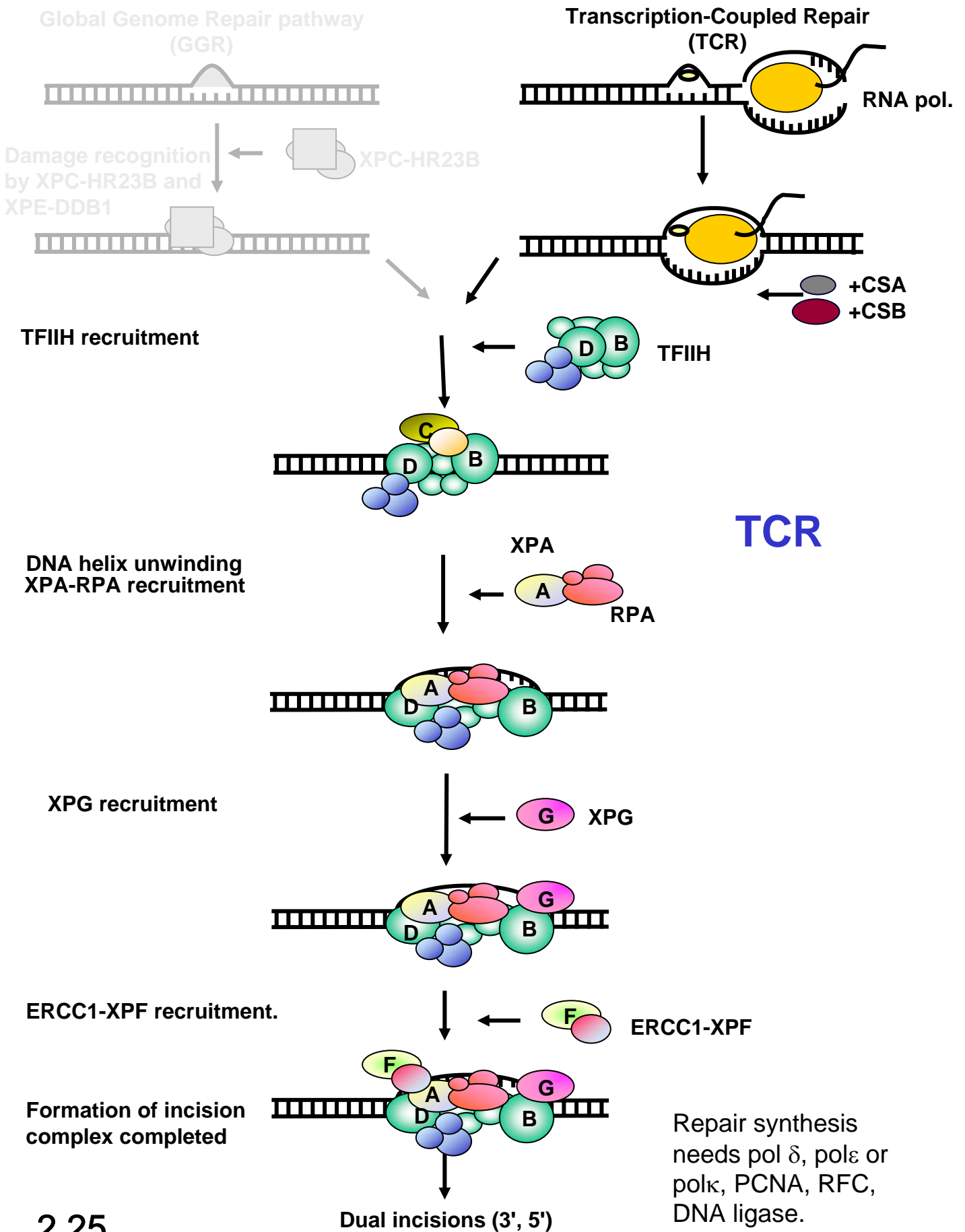

2.25

Summary (Lecture 2b)

- **XP proteins are involved in damage recognition, unwinding of the DNA and cutting on either side of the damage**
- **XPD, XPB and TTDA are subunits of TFIIH, which has dual roles in NER and transcription**
- **TTD is a transcription syndrome**
- **CS proteins are involved in recruiting NER proteins and chromatin remodellers to enable NER to take place at sites where RNA polymerase is stalled at damage**