

Facioskapulohumerální svalová dystrofie

- AD dědičnost, incidence 1:20 000
- FSHD lokus: subtelomerická oblast 4 chromozomu (4q35).

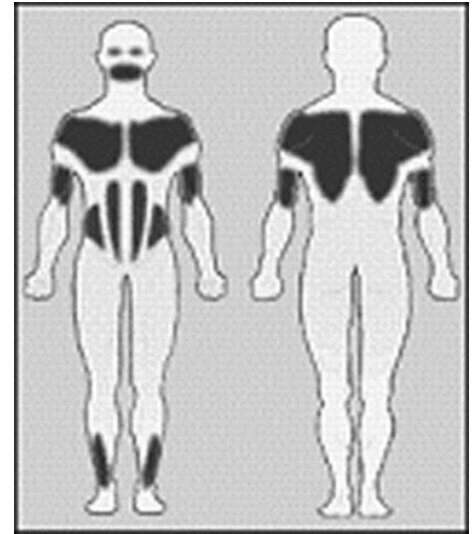

Repetice D4Z4

- 11-110 repetice D4Z4 (normální DNA)
- 1-10 repetice D4Z4 (pacienti s FSHD)

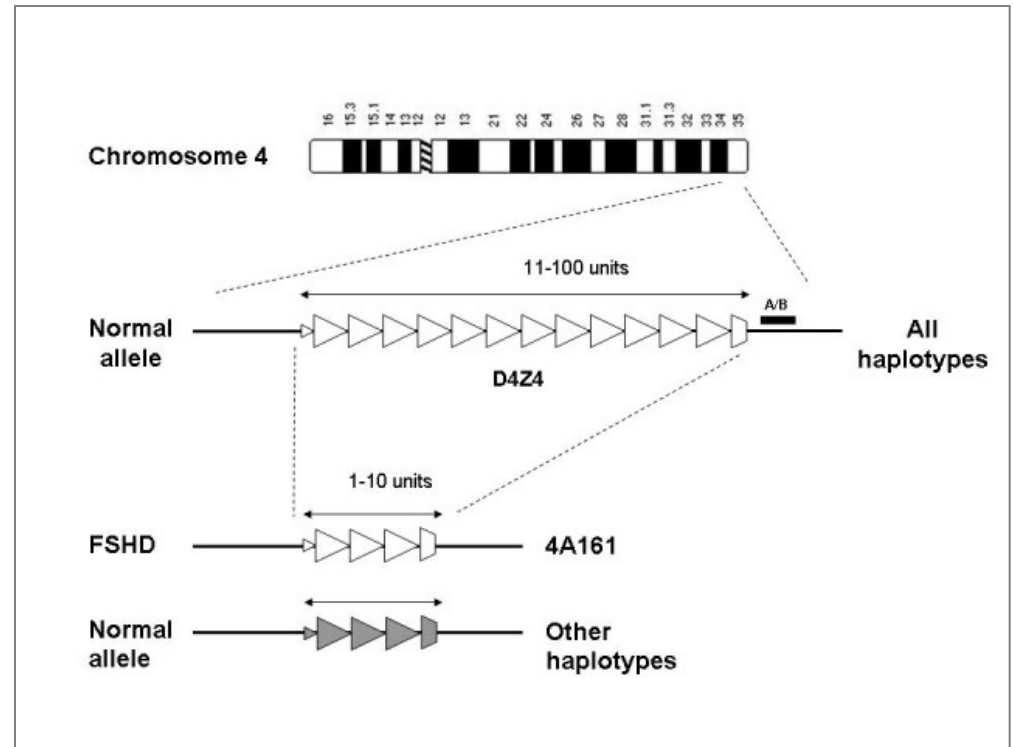

Clinical manifestations of FSHD:

- Disease onset - typically in **the second decade of life** - characterized by initially restricted **weakness of shoulder and facial muscles**.
- The spectrum of disease severity is wide, ranging from **mildly affected individuals to severely affected wheelchair bound individuals** (approx. 20%).
- There is no linear and inverse correlation between residual repeat size and disease severity and onset. However, **patients having repeat arrays of 1–3 units usually have an infantile onset and rapid progression**.



*27-year-old female with FSHD.
Marked non-structural hyperlordosis.*

Repeat sequences in the human genome

- Approximately **half of the human genome consists of repetitive DNA**, and a significant proportion is organized in tandem arrays. These tandem arrays of DNA embody an example of **copy number variation** and are **classified according to their repeat unit size and their total length**.
- Repeat unit sizes **1- 4 nucleotides** and spanning **less than 100 bp** are typically defined as **microsatellite repeats**. Those with repeat unit sizes between **10 - 40 nucleotides** covering **several hundreds** of base pairs are referred to as **minisatellite repeats**. The term **midisatellite repeat** has been proposed for loci containing repeat units of **40 - 100 nucleotides** that can extend over distances of **250–500 kb**. **Macrosatellite repeats**, to which D4Z4 belongs, are the largest class of repeat arrays with unit sizes of **>100 nucleotides** but which are typically much larger and can span **hundreds of kb** of DNA.
- **Whereas FSHD represents a macrosatellite repeat contraction disease, microsatellite repeat expansions are a frequent cause of neurodegenerative diseases.**

D4Z4 size: 3.3-kb

- **Normal DNA: 11-100 D4Z4 (330 kb)**
- **FSHD patients: 1-10 D4Z4 (<33 kb)**

- Byly identifikovány dvě alelické varianty 4q35 subtelomery (4qA a 4qB), které jsou podobně zastoupeny v běžné populaci; alela 4qA se od alely 4qB liší přítomností beta-satelitní repetice o velikosti 6,2 kb.
- **FSHD je asociovaná s delecí repetice D4Z4 na alele 4qA (delece D4Z4 na alele 4qB nezpůsobí fenotyp FSHD)!!!**

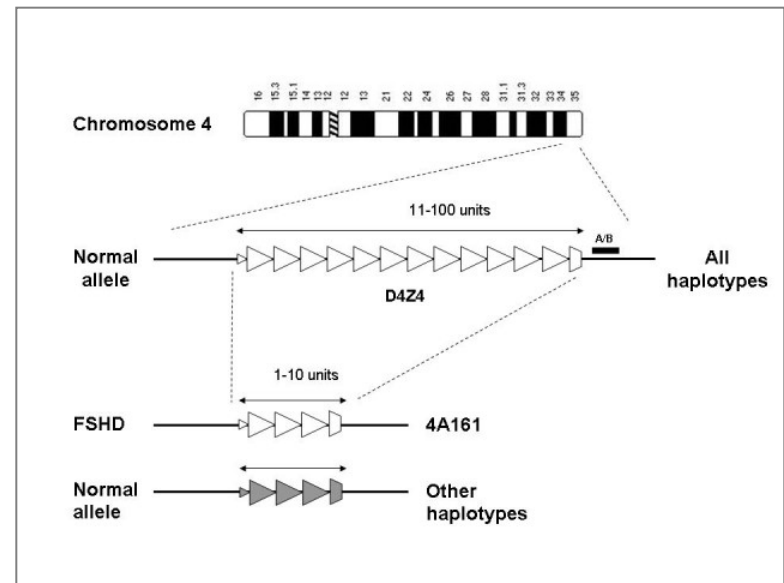

- **Monosomie subtelomery 4q35 nezpůsobí FSHD!!!!**

- Malé procento FSHD pacientů (5%), jsou tzv. „phenotypic“ FSHD pacienti – **nemají delecí D4Z4 v oblasti subtelomery 4q35!!!**

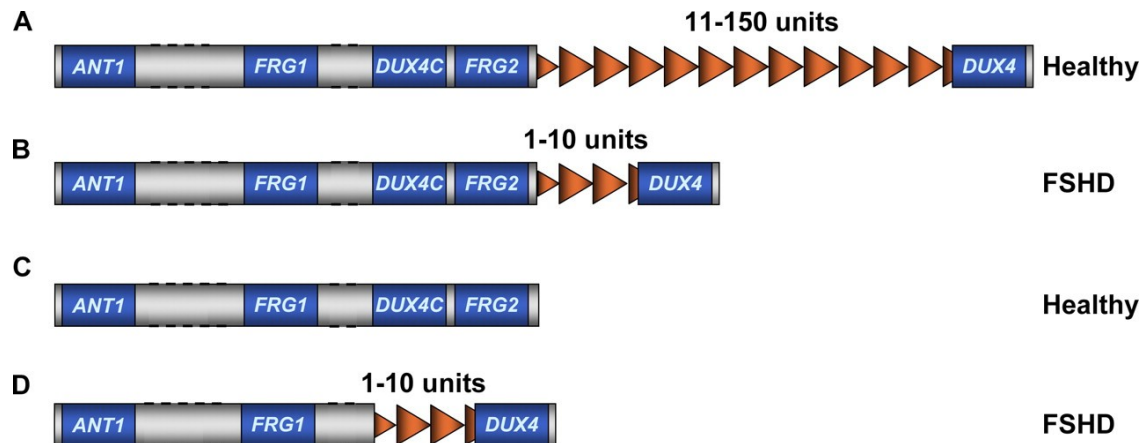

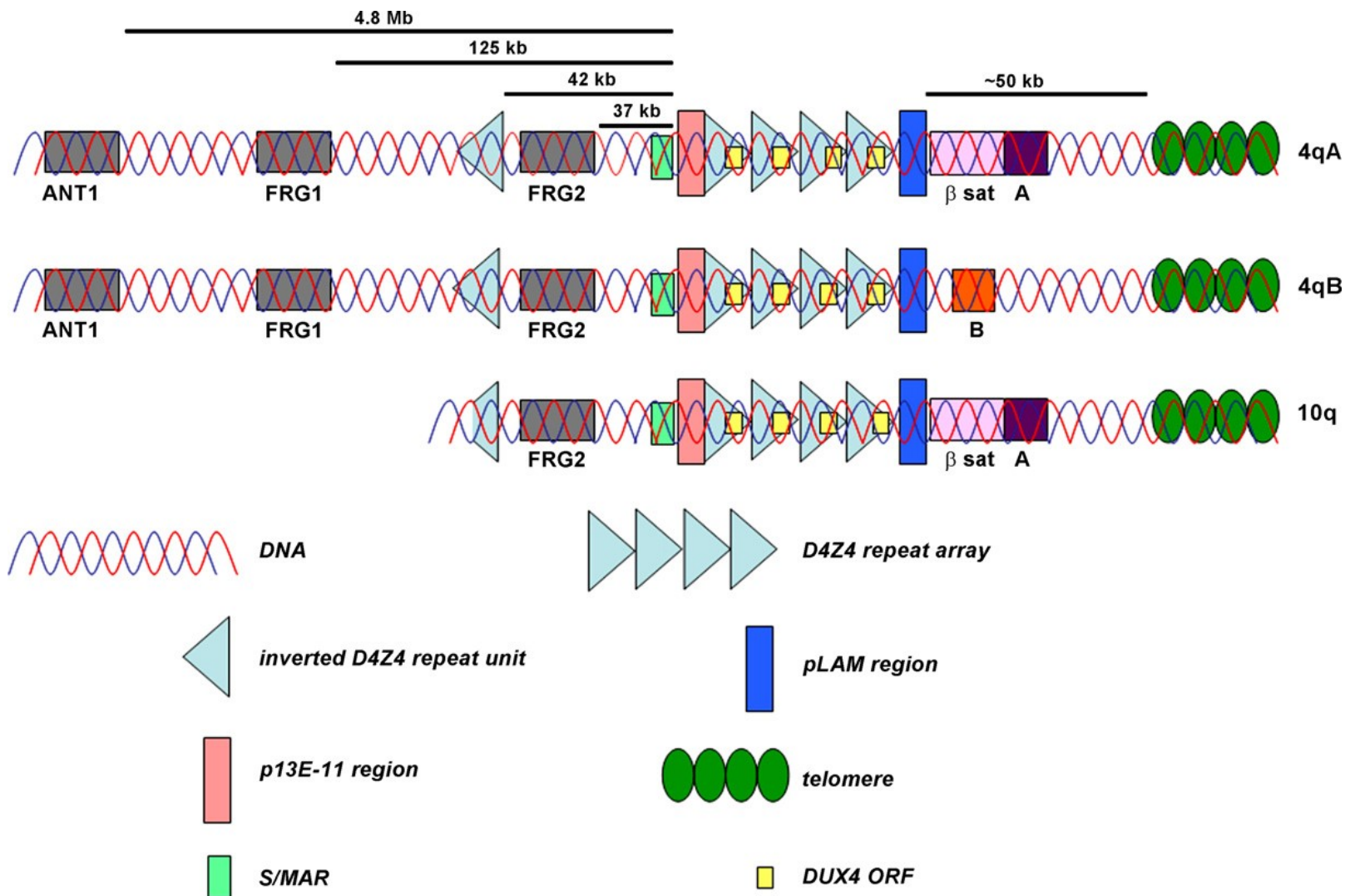

Schematic map of 4qA, 4qB and 10q. The subtelomere of chromosome 10q contains a repeat array that is highly homologous to D4Z4 on 4qter. The homology extends both in proximal and distal direction. In addition, two allelic variants of the 4q subtelomere have been identified. The presence of beta satellite DNA distal to D4Z4 on 4qA-type alleles is the most prominent difference between these allelic variants.

- D4Z4 are extremely GC-rich (290 CpG) - attractive candidates for **DNA methylation**. DNA methylation is a common modification of mammalian DNA. DNA methylation is associated with increased chromatin condensation and gene silencing.

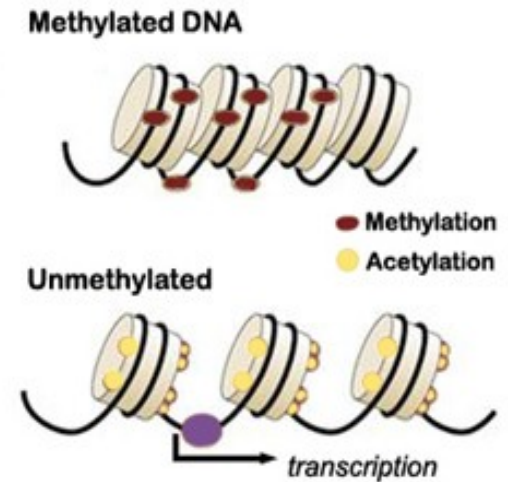
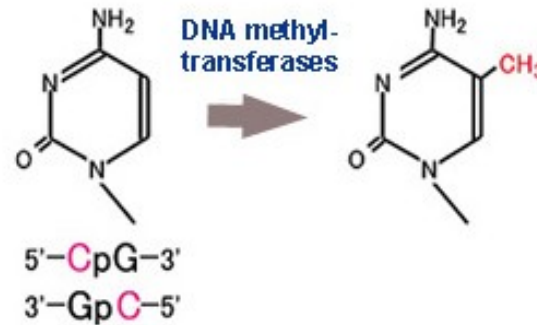

- **D4Z4 has both euchromatic and heterochromatic features.**
- **DNA methylation of D4Z4 on the FSHD allele (D4Z4 contraction) was significantly reduced in FSHD patients.**
- **In „phenotypic“ FSHD patients (without D4Z4 contraction) but with clinical symptoms of FSHD patients, significant D4Z4 hypomethylation at both chromosome 4q alleles was observed.**

- FSHD pacienti s 1-3 D4Z4 mají výraznější D4Z4 hypometylaci než pacienti s 4-10 D4Z4.
- Pacienti s 4-10 D4Z4 vykazují velkou interindividuální variabilitu hypometylace D4Z4.
- Normální DNA (11-100 D4Z4) nevykazuje žádný vztah mezi D4Z4 metylací a počtem repetit D4Z4.

Delece repetit D4Z4 na chromozomu 4qB i chromozomu 10q (tj. delece neasociované s FSHD) jsou taky spojeny s DNA hypometylací D4Z4.

→ D4Z4 hypometylace je nutná ale ne dostačující k rozvinutí FSHD → další faktory determinují rozvoj FSHD.

- Chromatin - DNA, histones and other chromosomal proteins. A major function of chromatin is packaging of the DNA in the nucleus.
- Histones may undergo several posttranslational modifications (acetylation, methylation, phosphorylation and ubiquitination).
- Histone modifications directly affect chromatin structure by altering interactions between nucleosomes, changing the interactions of the histone tails with the DNA in the nucleosome, on the other hand, histone modifications may serve as a site for recruitment of chromatin-associating proteins that recognize a specific histone code.
- Specific histone modifications seem to be associated with either transcriptional activation or transcriptional repression. Methylation at lysine residues 4, 36 and 79 of histone H3 has been correlated with transcriptional activation. In contrast, **methylation at lysine residues 9 and 27 of histone H3** and at lysine residue 20 of histone H4 has been linked to heterochromatin and gene repression.

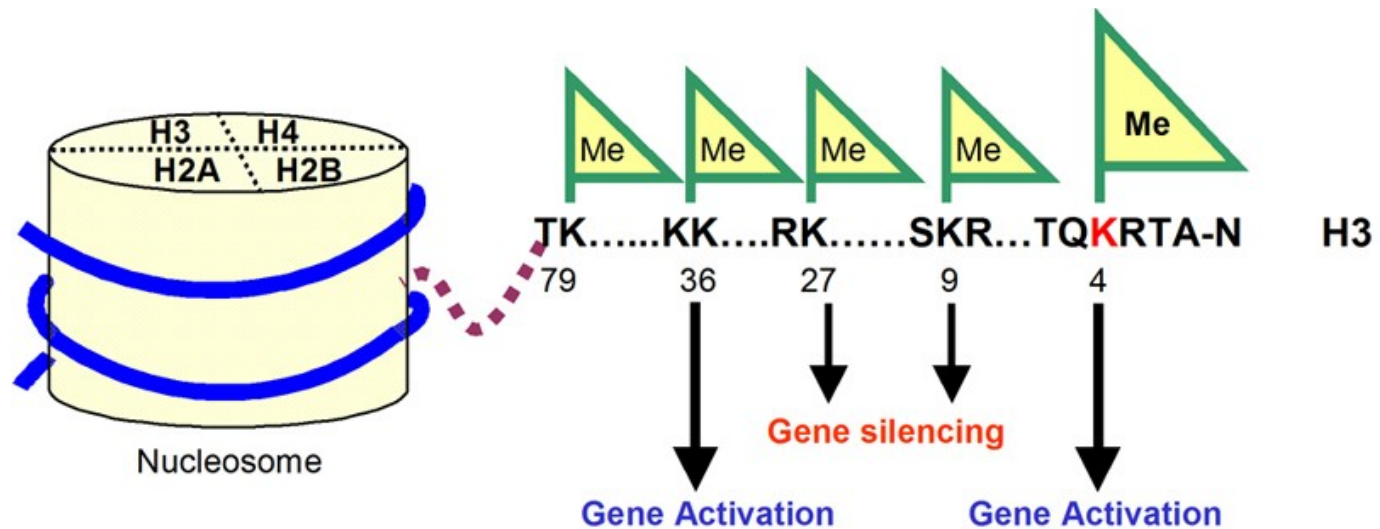

FSHD je asociována s epigenetickými změnami chromatinu – DNA metylace, modifikace H3K9me3

- Normální alela 4q35: DNA metylace, modifikace H3K9me3

- FSHD alela s delecí D4Z4: DNA hypometylace, ztráta modifikace H3K9me3

- „phenotypic“ FSHD pacienti: DNA hypometylace, ztráta modifikace H3K9me3 na obou alelách

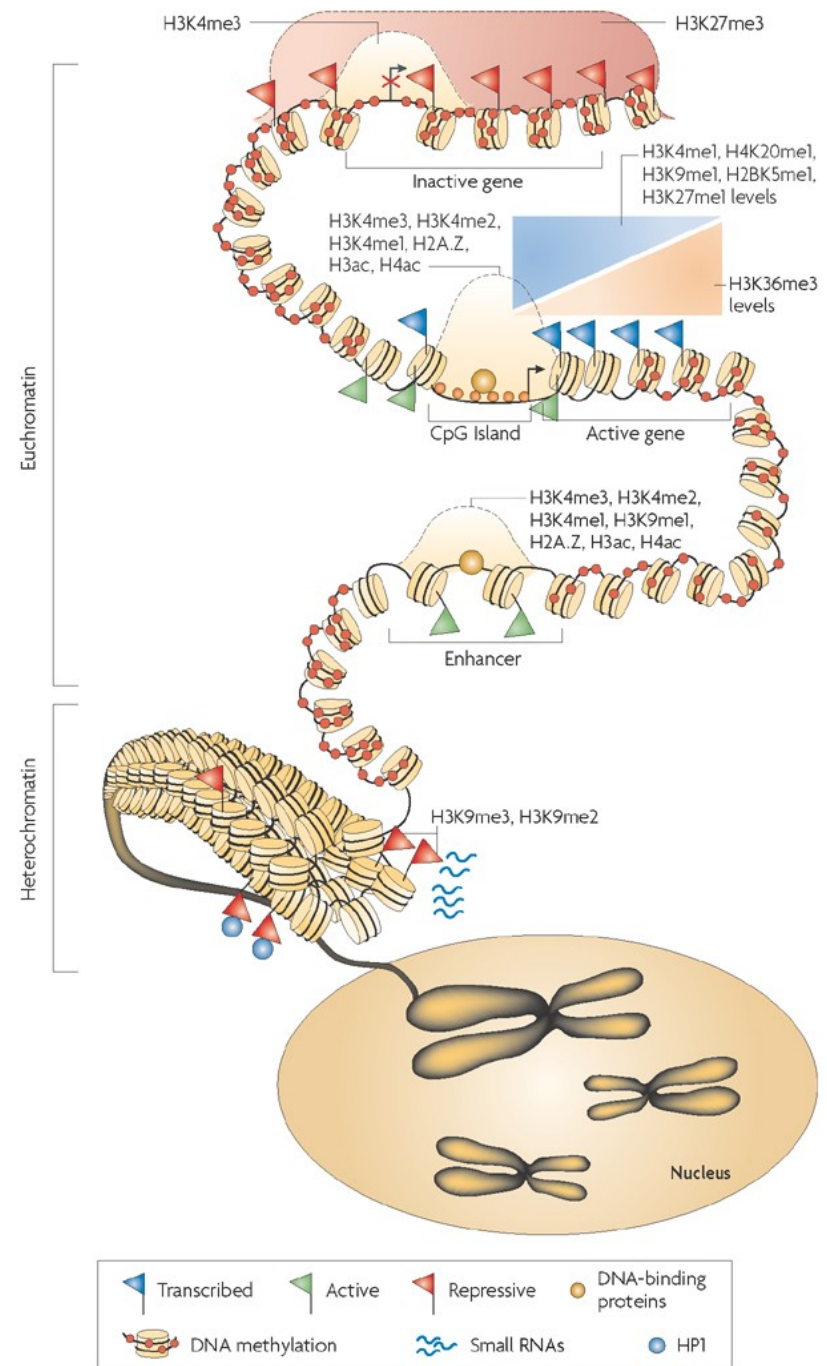

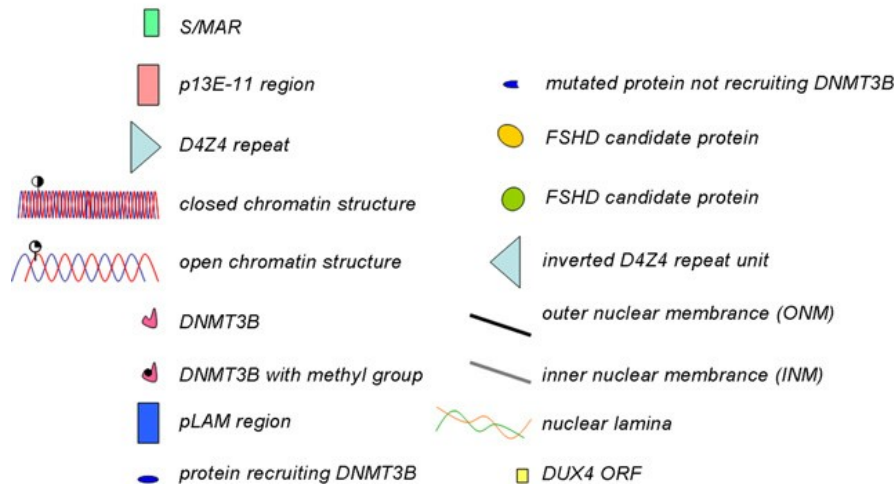
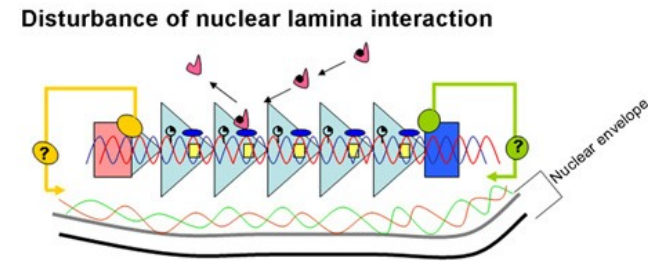
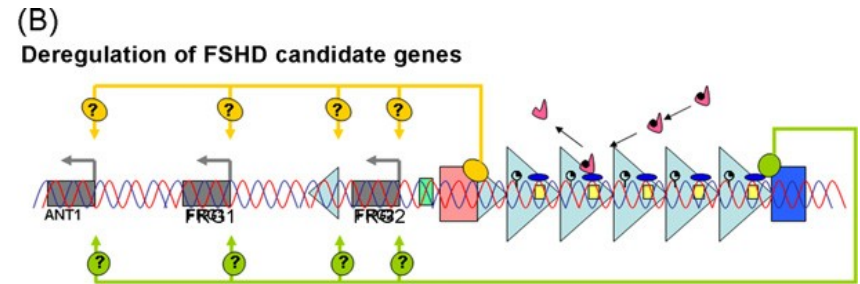
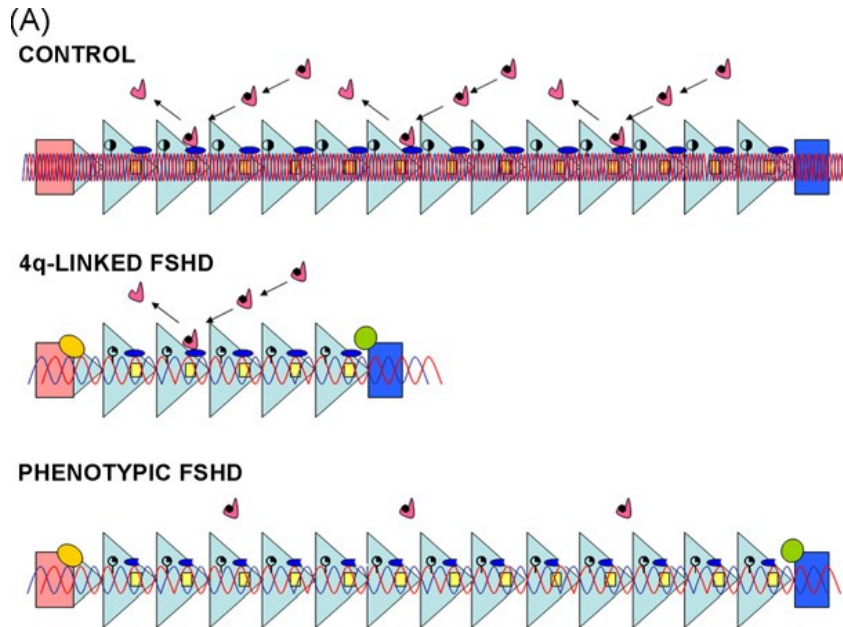

(A) In controls - D4Z4 is packed as heterochromatin. **In patients with FSHD - more open chromatin structure is induced. Because of the open chromatin structure in patients with FSHD, binding of protein(s) to D4Z4 that normally do not bind may occur.**

(B) When the chromatin structure is in a more open conformation, candidate genes may be deregulated *in cis* (upper panel) and the interaction with the nuclear envelope may be disturbed (lower panel).

A
CHROMOSOME 4 – PROXIMAL UNIT

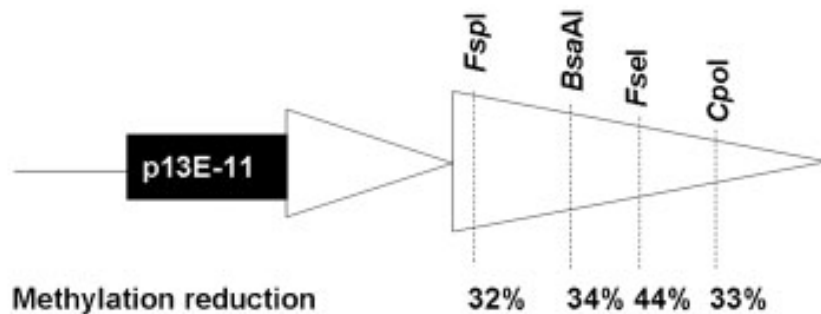

B

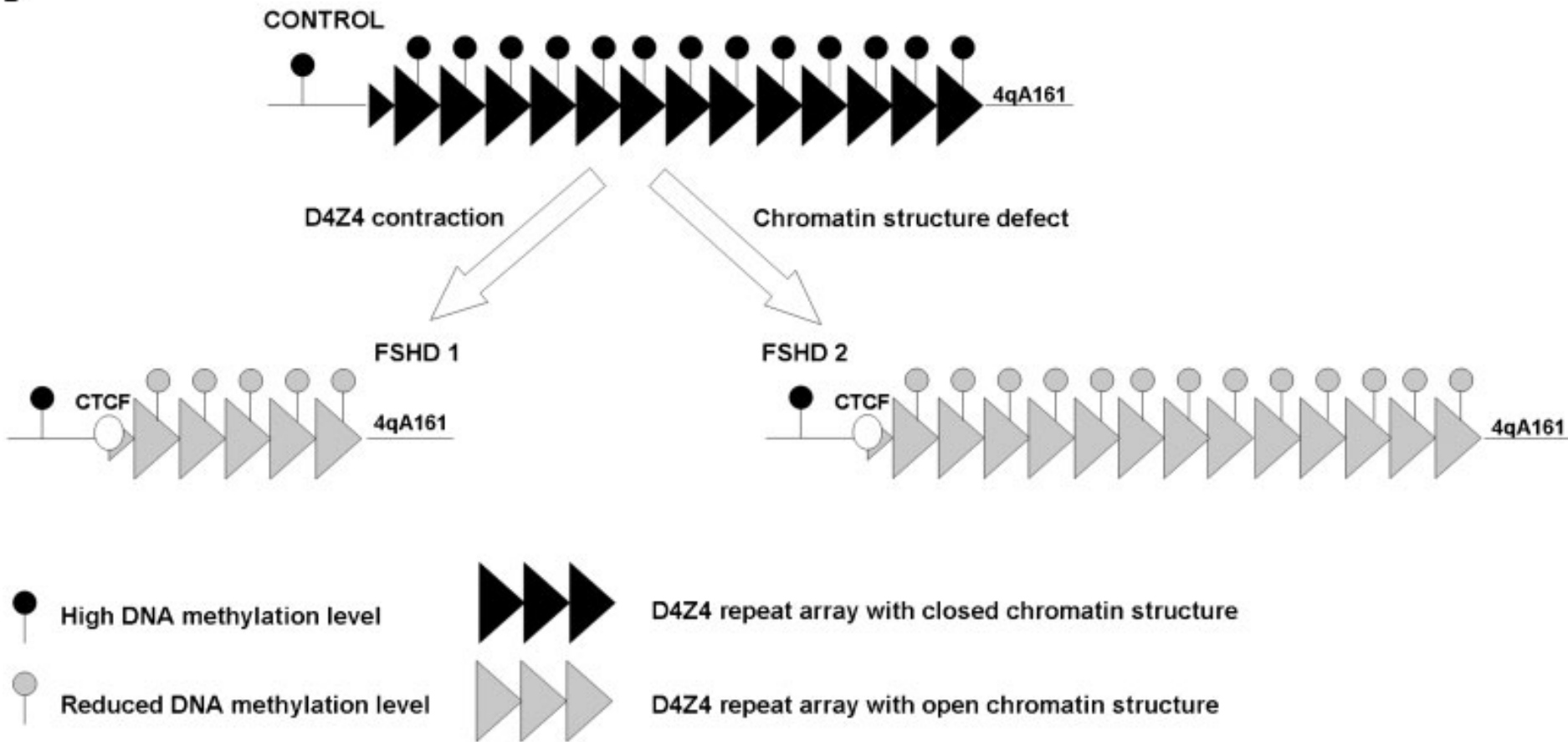

The combination of an epigenetic change in D4Z4 on a 4qA161 haplotype unifies FSHD1 and FSHD2. A: Schematic overview of four methylation-sensitive restriction sites in the D4Z4 repeat array. The methylation levels on the BsaAI and FseI restriction sites were reported earlier. The methylation levels on the CpoI site are presented in this article. The methylation levels on the FspI site are unpublished results. Compared to control individuals the D4Z4 methylation level on these four sites is on average 32–44% reduced in FSHD1 patients. B: D4Z4 contraction-induced chromatin changes are the cause for FSHD1 while a yet unidentified factor that affects the D4Z4 chromatin structure causes FSHD2. Importantly, this phenomenon needs to occur on the 4qA161 haplotype. Binding of CTCF to the proximal end of the D4Z4 repeat may prevent spreading of hypomethylation proximally in patients with FSHD.

HUMAN MUTATION, Vol. 30, No. 0, 1–11, 2009

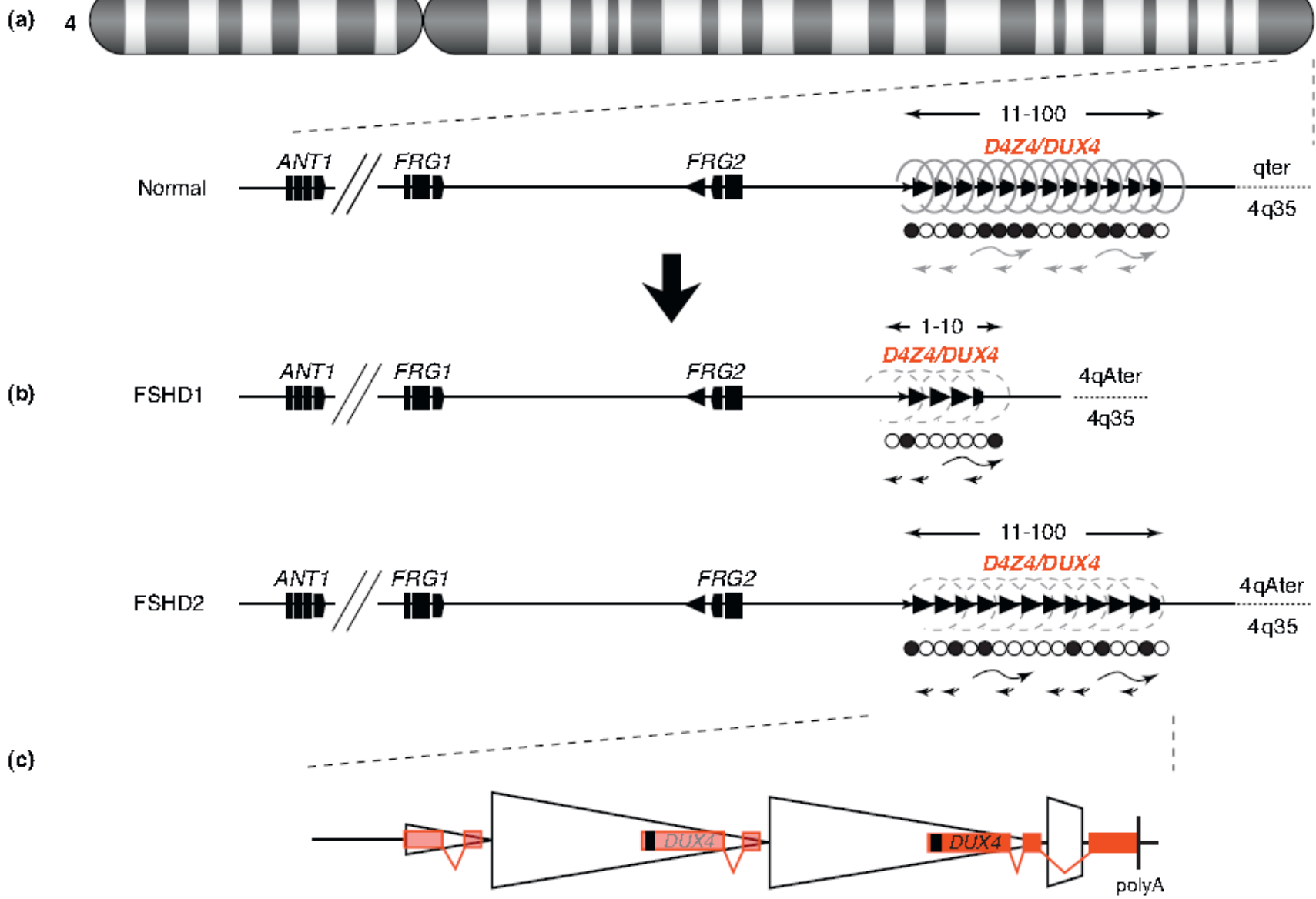

The DUX4 gene is located within each D4Z4 unit. On permissive chromosomes, the last copy of the DUX4 genes splices to a third exon located in the region immediately flanking the repeat and stabilizing the transcript owing to the presence of a polyadenylation (polyA) signal.

Schematic of the FSHD locus.

(a) The D4Z4 repeat (triangles) is located in the subtelomere of chromosome 4q and can vary between 11 and 100 copies in the unaffected population. This repeat structure has a closed chromatin structure characterized by heterochromatic histone modifications (dense springs), high DNA methylation levels (closed circles) and complex bidirectional transcriptional activity (gray arrows). Candidate genes DUX4, FRG2, FRG1 and ANT1 are indicated.

(b) In patients with FSHD, the chromatin structure of D4Z4 adopts a more open configuration (open springs and open circles) leading to inefficient transcriptional repression (black arrows) of the D4Z4 repeat.

(c) The DUX4 gene is located within each D4Z4 unit. On permissive chromosomes, the last copy of the DUX4 genes splices to a third exon located in the region immediately flanking the repeat and stabilizing the transcript owing to the presence of a polyadenylation (polyA) signal.

Trends in Molecular Medicine May 2011, Vol. 17, No. 5

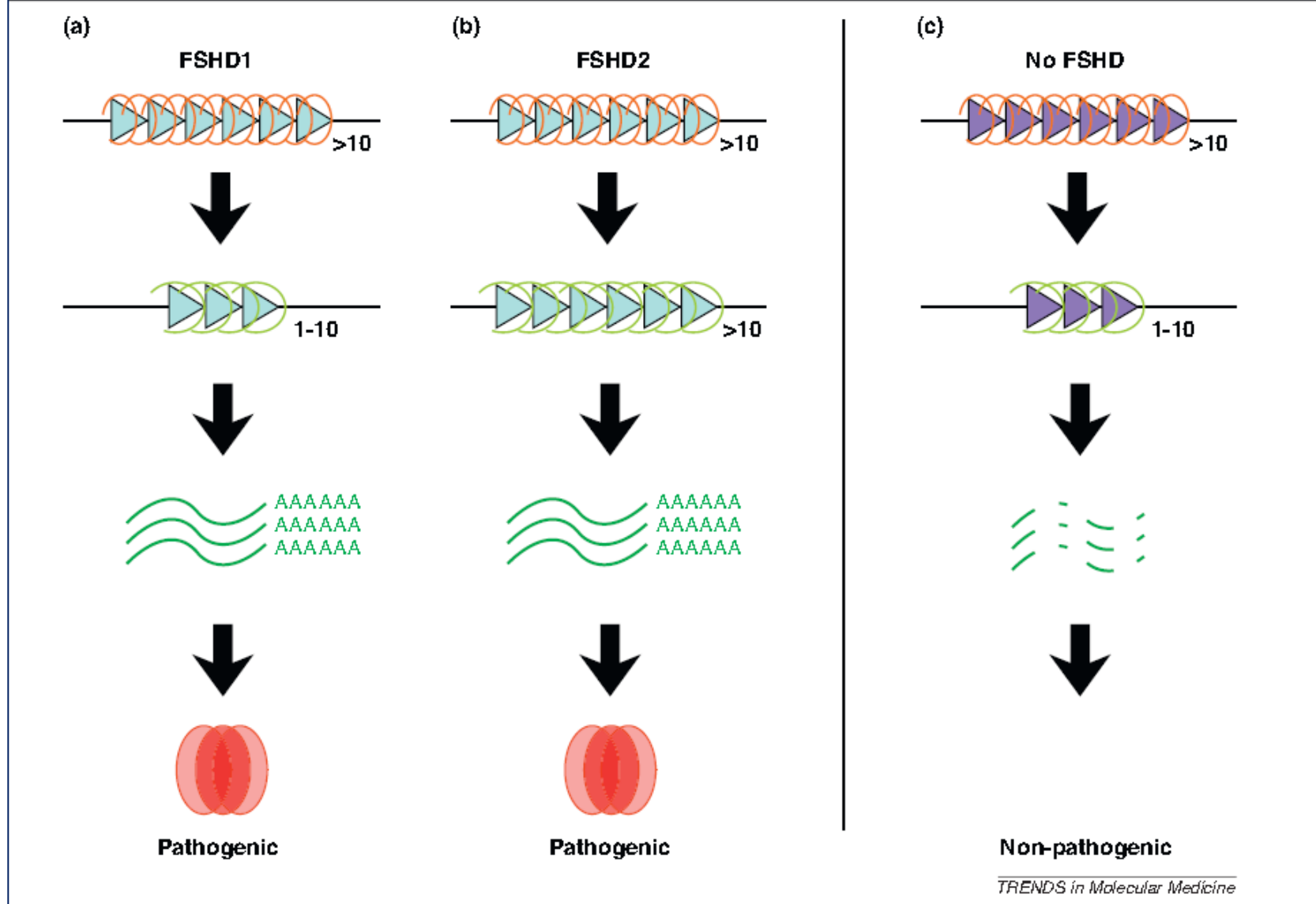

Upon (a) contraction of the D4Z4 repeat (FSHD1) or by (b) a yet unknown mechanism (FSHD2, phenotypic FSHD), the D4Z4 repeat array adopts a more open chromatin configuration leading to the leaky expression of DUX4 mRNA. On permissive chromosomes, this mRNA is stabilized owing to the presence of a canonical polyadenylation signal immediately distal to the D4Z4 repeat array. (c) Nonpermissive chromosomes do not have this polyadenylation signal and therefore DUX4 mRNA becomes rapidly degraded. The DUX4 mRNA encodes for a nuclear double-homeobox protein that when expressed in muscle induces apoptosis.

A unifying mechanism for FSHD.

Upon (a) contraction of the D4Z4 repeat (FSHD1) or by (b) a yet unknown mechanism (FSHD2, phenotypic FSHD), the D4Z4 repeat array (triangles) adopts a more open chromatin configuration (orange > green dots) leading to the leaky expression of DUX4 mRNA. On permissive chromosomes, this mRNA is stabilized owing to the presence of a canonical polyadenylation signal immediately distal to the D4Z4 repeat array. (c) Nonpermissive chromosomes do not have this polyadenylation signal and therefore DUX4 mRNA becomes rapidly degraded. The DUX4 mRNA encodes for a nuclear double-homeobox protein that when expressed in muscle induces apoptosis.

Trends in Molecular Medicine May 2011, Vol. 17, No. 5

- The sequence of the **D4Z4 repeat** contains the open reading frame (ORF) of a double-homeobox transcription factor, **DUX4**.
- **Major advance in understanding FSHD was the identification of polyadenylated mRNA containing the DUX4 ORF.** The polyadenylation site of the DUX4 mRNA was mapped to the region immediately telomeric to the last D4Z4 repeat. **It was proposed that the contraction of the D4Z4 array results in the transcription of the DUX4.**
- One noticeable difference between chromosomes 4A and chromosomes 4B and 10 was the presence of a DUX4 polyadenylation signal on chromosome 4A.

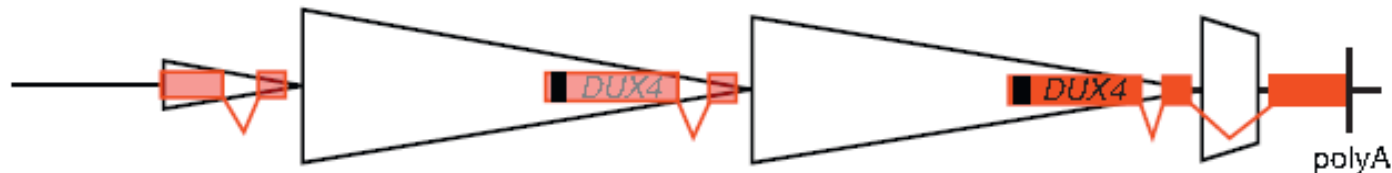

A model of FSHD pathophysiology:

- Full-length DUX4 is produced from the last D4Z4 unit in early development and is suppressed during cellular differentiation; **in differentiated tissues, the D4Z4 array is associated with DNA methylation and H3K9me3 and DUX4 expression is repressed.**
- In FSHD, the expression of the full-length DUX4 transcript is not completely suppressed in skeletal muscle (and possibly other differentiated tissues) and results in a small percentage of cells expressing relatively abundant amounts of the full-length DUX4 mRNA and protein.
- **FSHD is caused by the inefficient suppression of the DUX4 and the residual expression of the full-length DUX4 in skeletal muscle is sufficient to cause the disease - expression of full-length DUX4 in muscle cells induces DUX4-induced apoptosis.**

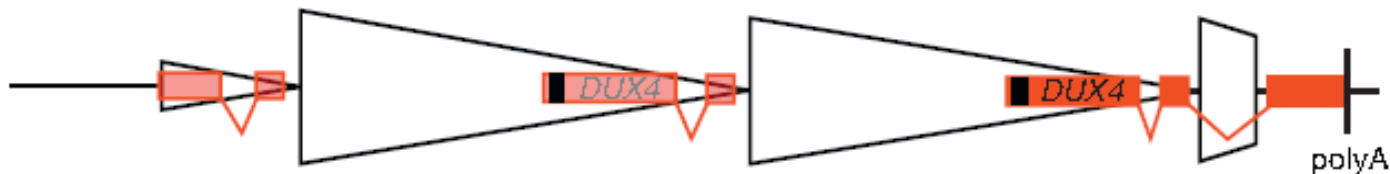

Molekulárně genetická diagnostika FSHD:

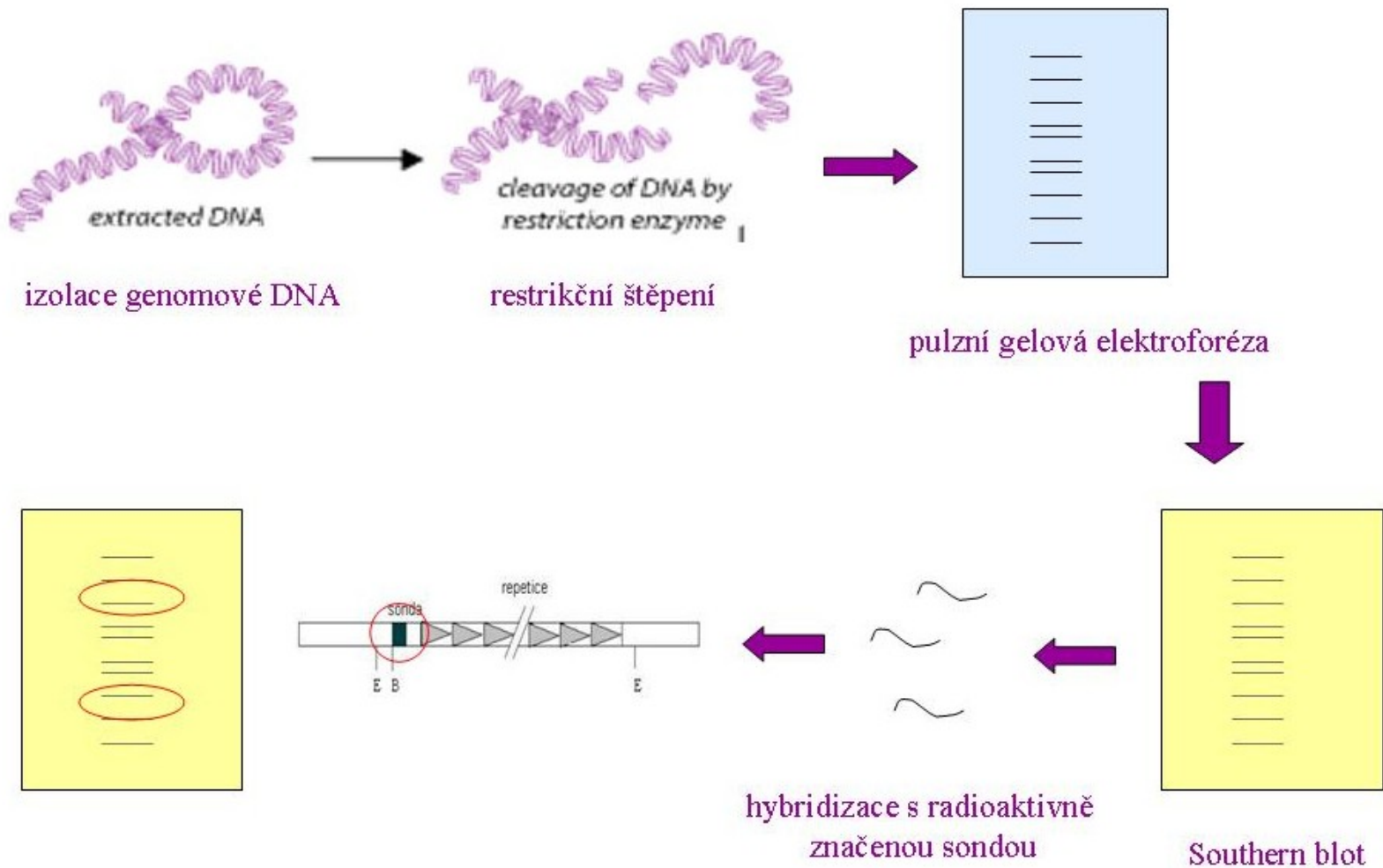

Genomic map of the facioscapulohumeral muscular dystrophy locus region containing 4qA-defined and 4qB-defined 4qter subtelomeres.

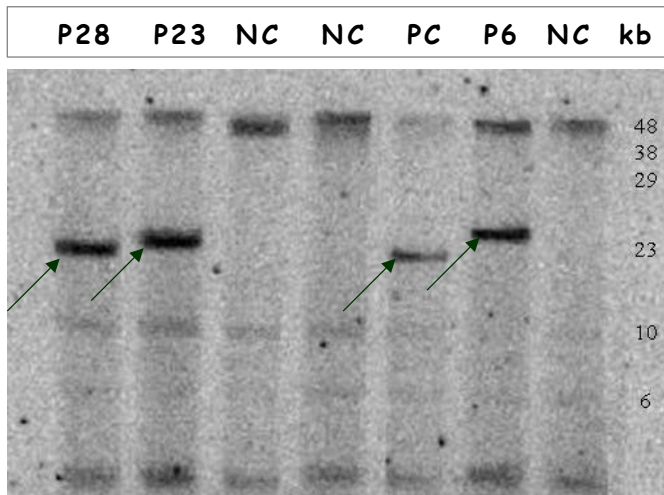
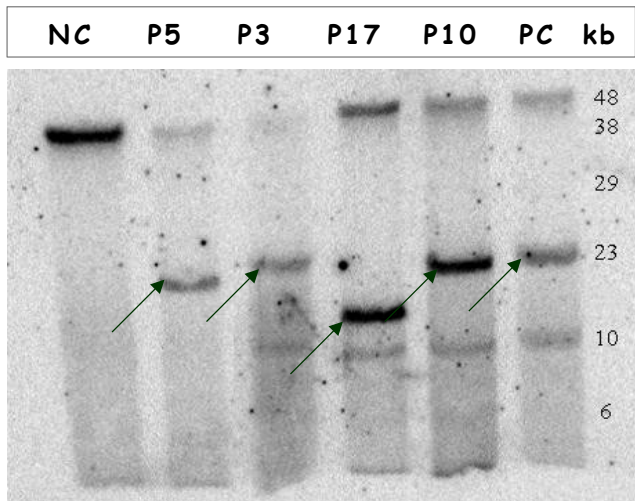
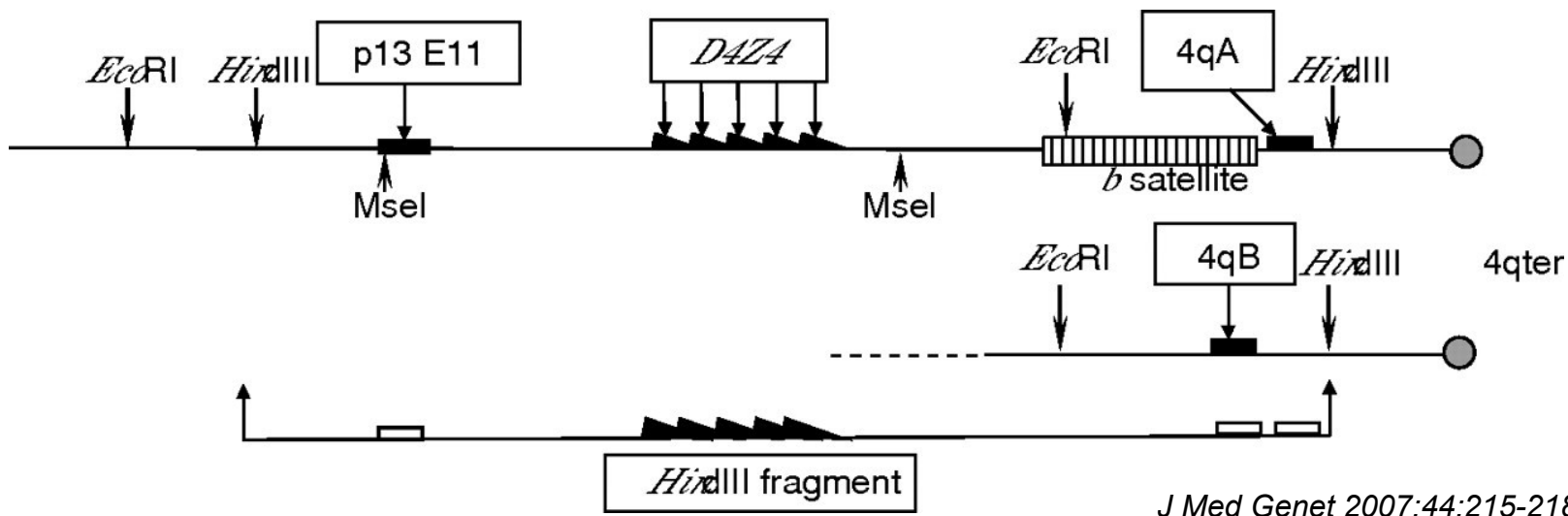

- **Pacientis s FSHD:**
detekce fragmentu < 38kb (< 10 repetice)
- **Kontrola:**
detekce fragmentu > 38kb (11-100 repetice)

Výsledky molekulárně genetické diagnostiky FSHD:

- Počet pacientů s provedenou analýzou: **209**
- Počet pozitivních záchytů: **111 (53%)**

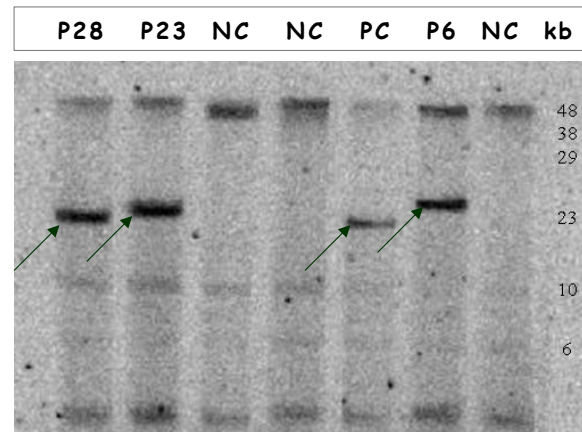
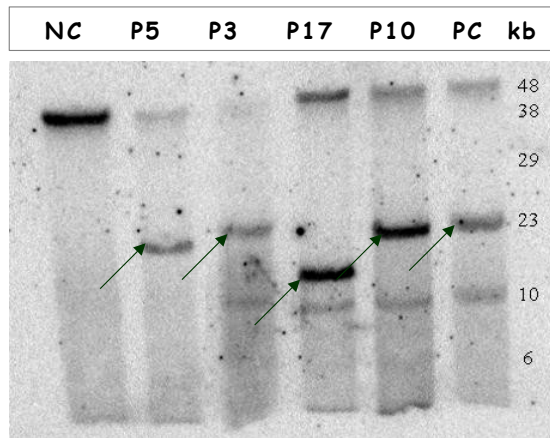

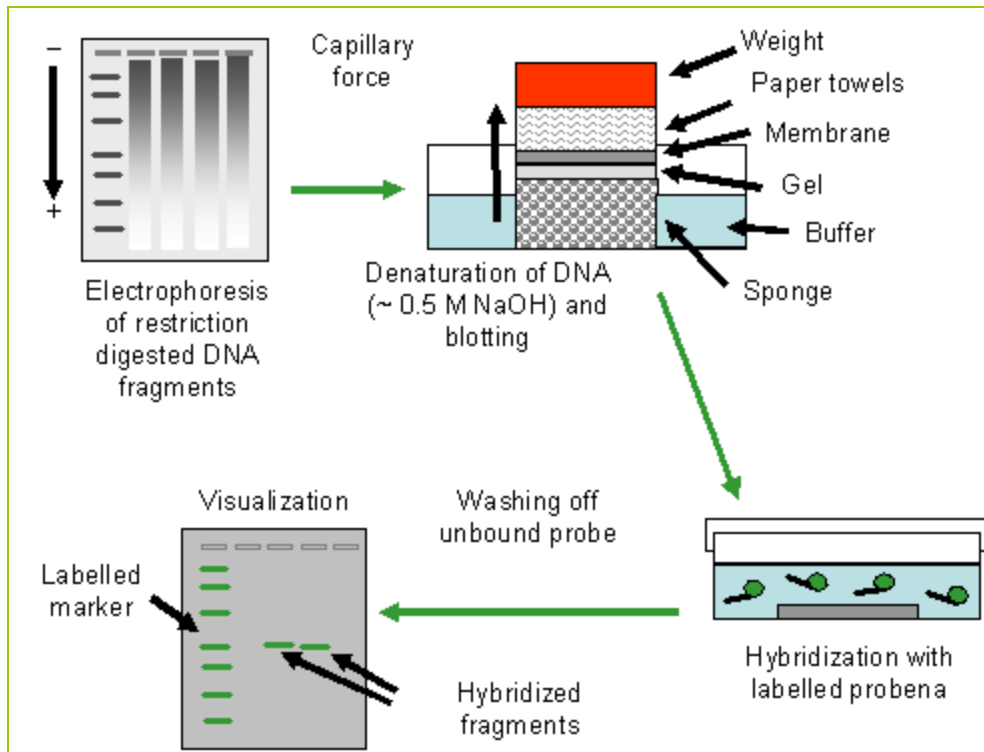

- Restrikční štěpení DNA.
- Elektroforetické rozdělení naštěpené DNA v agarózovém gelu na základě velikosti DNA fragmentů.

Southern blot:

- Depurinace v 0,25 M HCl (v případě fragmentů větších než 15 kb, štěpí DNA na menší fragmenty pro účinnější přenos z gelu na membránu).
- Denaturace a fragmentace DNA (v místě depurinace) 0,5 M NaOH.
- Alkalický přenos DNA na membránu v 0.5 M NaOH (vazba negativně nabitě DNA k pozitivně nabitě membráně) - *různé možnosti.*

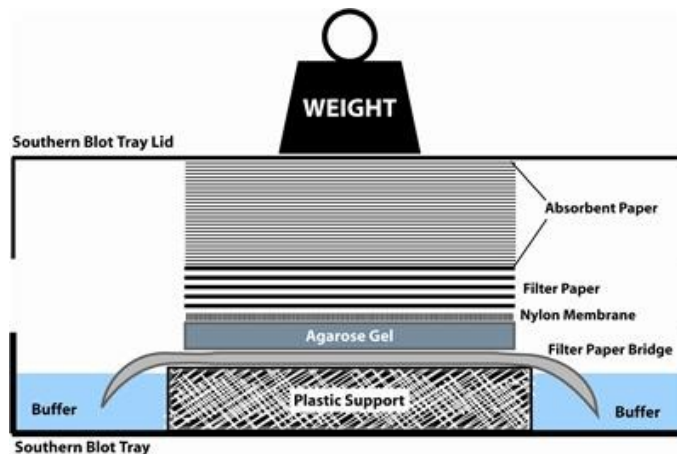

- Radioaktivní značení hybridizační sondy (fragment DNA, jehož sekvence je komplementární s analyzovanou sekvencí na membráně).
- Hybridizace značené sondy s DNA na membráně – vhodná teplota, zajištění specifity pro vazbu próby (salmon sperm DNA – blokování povrchu membrány a DNA, detergenty – redukce nespecifické vazby).
- Odmytí nenavázané próby.
- Autoradiografie.

DNA labeling by *in vitro* DNA strand synthesis.

• (A) **Nick translation.** Pancreatic DNase I introduces single-stranded nicks by cleaving internal phosphodiester bonds (p), generating a 5' phosphate group and a 3' hydroxyl terminus. Addition of the multisubunit enzyme *E. coli* DNA polymerase I contributes two enzyme activities: (i) a 5'→3' exonuclease attacks the exposed 5' termini of a nick and sequentially removes nucleotides in the 5'→3' direction; (ii) a DNA polymerase adds new nucleotides to the exposed 3' hydroxyl group, continuing in the 5'→3' direction, thereby replacing nucleotides removed by the exonuclease and causing lateral displacement (translation) of the nick.

• (B) **Random primed labeling.** The Klenow subunit of *E. coli* DNA polymerase I can synthesize new radiolabeled DNA strands using as a template separated strands of DNA, and random hexanucleotide primers.

Radioaktivní značení sondy

(A)

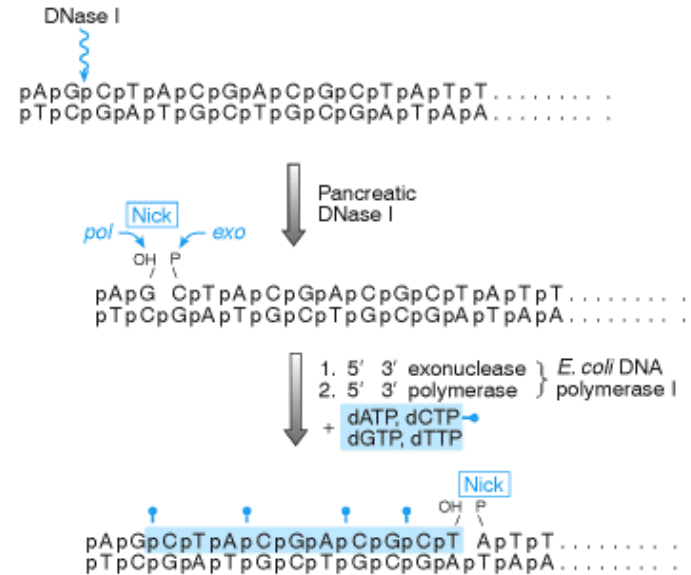

(B)

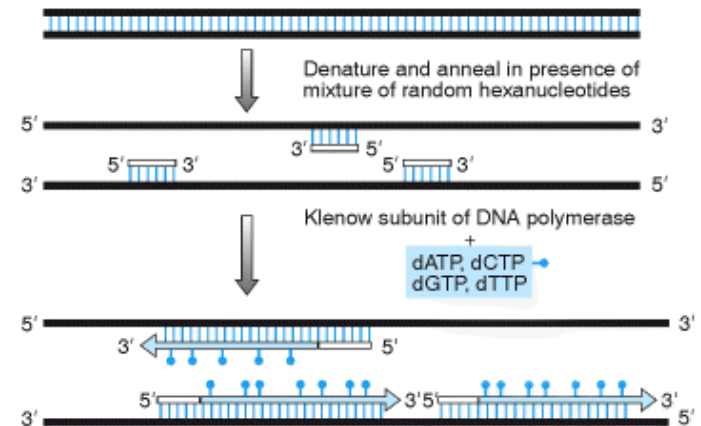

Key:

↑ Labeled nucleotide

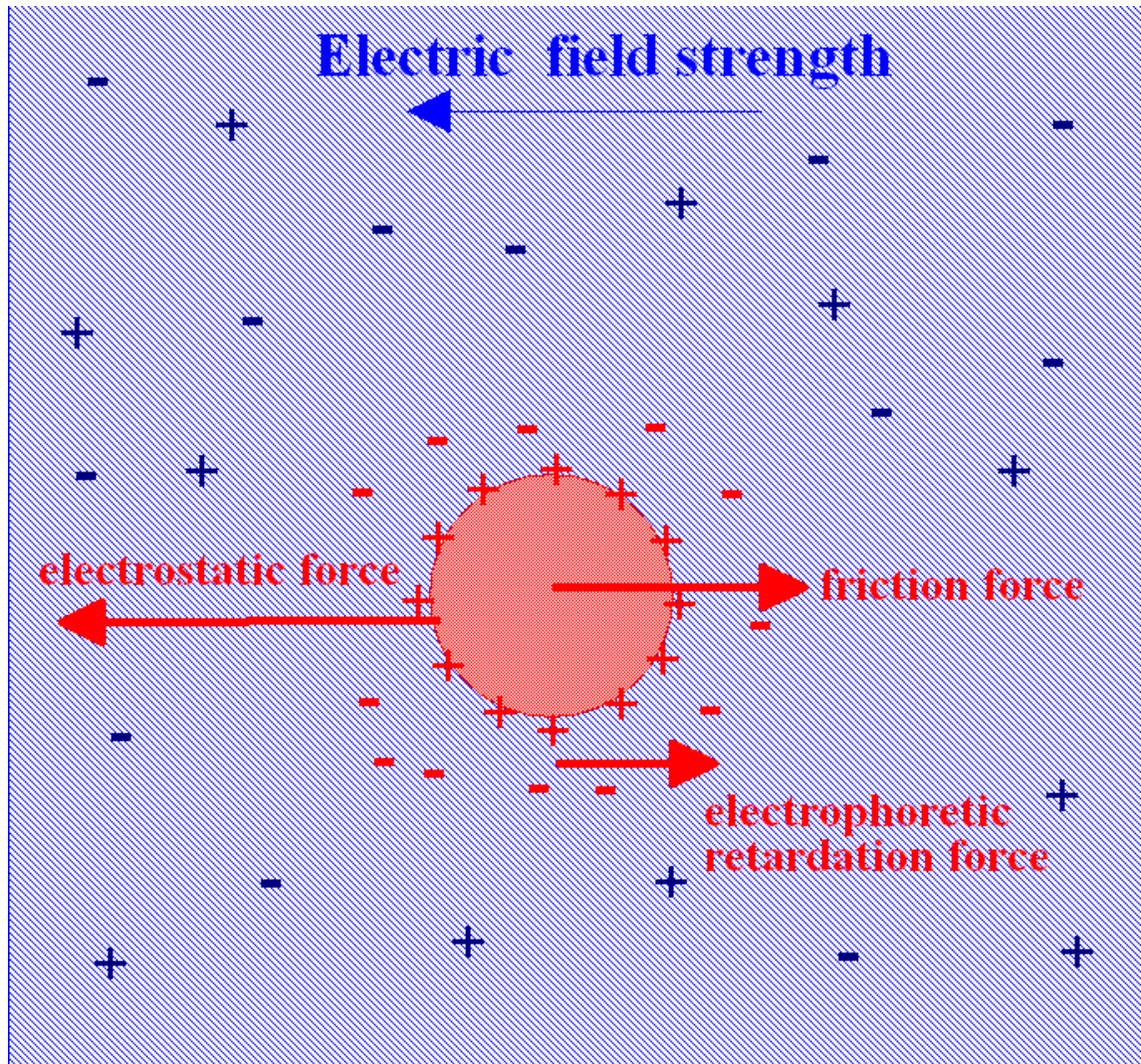

Mobilita dělených částic závisí zejména na:

1) velikosti a tvaru částic

2) náboji částic

3) na prostředí – např. na hustotě / velikosti pórů prostředí (koncentrace agarózy, koncentrace a hustota zesíťování polyakrylamidu, na složení a koncentraci elfo pufry)

4) na potenciálu el. pole (napětí)

5) na teplotě

....

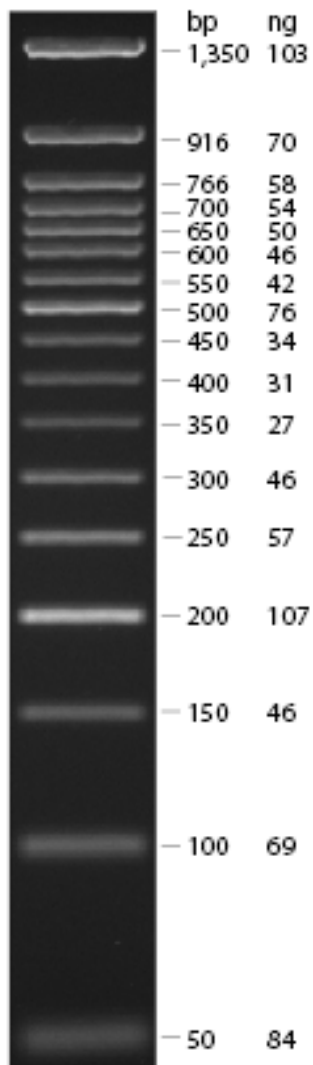

Rozlišení elfo lze regulovat volbou typu gelu (PAGE pro fragmenty do 1 kb, agaróza pro fragmenty od 100 bp do 20 kb), a jeho koncentrace (v případě PAGE též hustotou zesíťování, tj. poměrem AA:BIS).

1,8% agarose



Od určité velikosti částic se už přestává uplatňovat závislost mobility na velikosti částic, **všechny částice od této velikosti výše už putují stejně rychle/stejně daleko.**

V případě DNA dojde k jejímu zapletení do gelu a zastavení

(např. u 1% agarózy je tento limit asi 20 kb, u 0,6% agarózy asi 30 kb) – tzv. **kompresní zóna.**

Jak separovat molekuly DNA o velikosti >30kb ?

PULSNÍ ELFO

Separation of yeast chromosome-sized DNAs by pulsed field gradient gel electrophoresis **David C. Schwartz and Charles R. Cantor**
Cell, [Volume 37, Issue 1](#), 67-75, 1984.

Idea: změnou směru elektrického pole umožnit DNA zapletené do vláken agarózy přeorientovat se ve směru nového pole a znovu popojet.

Různé typy pulsní elfo, dnes nejčastější je **hexagonální uspořádání elektrod.**

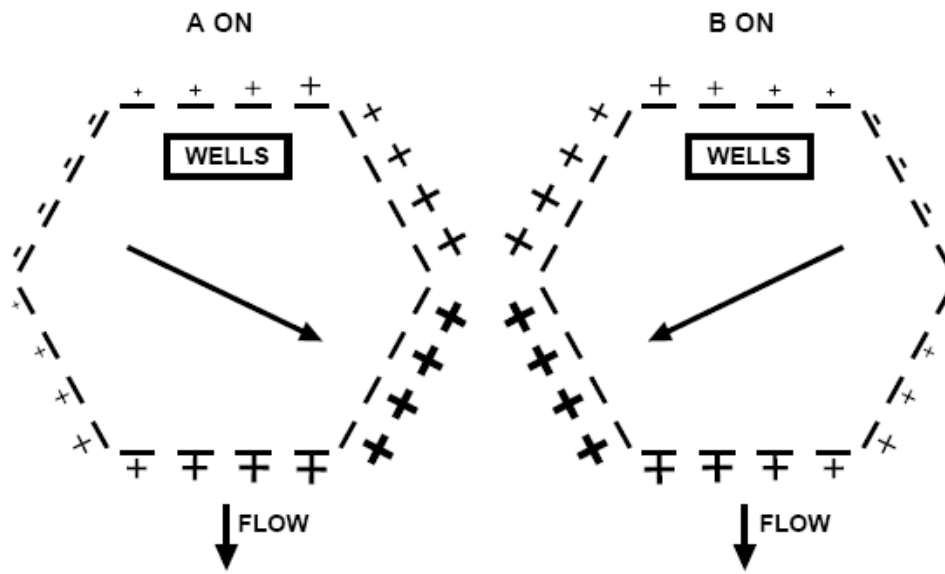
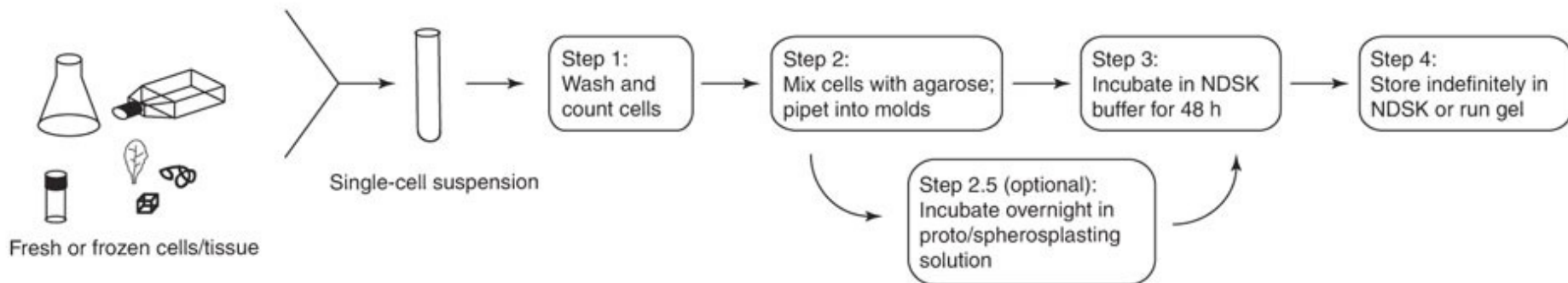
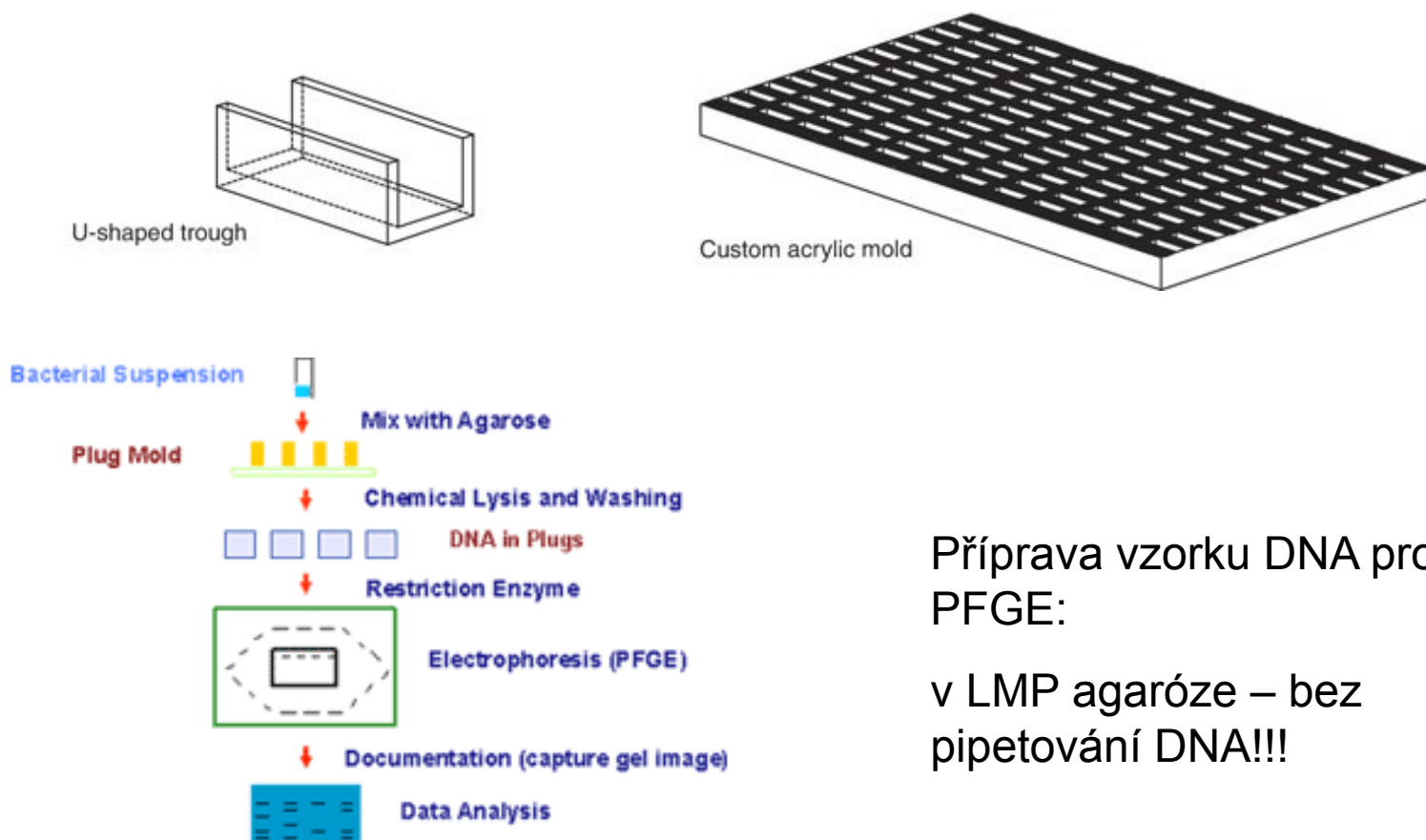

Fig. 1.1. Voltage Clamping by the CHEF-DR II system. **A.** Relative electrode potentials when the $+ 60^\circ$ field vector is activated. **B.** Relative electrode potentials when the $- 60^\circ$ field vector is activated.

a**b**

Příprava vzorku DNA pro PFGE:

v LMP agaróze – bez pipetování DNA!!!

I při PFGE dochází ke vzniku kompresní zóny – tj. i PFGE má limit rozlišení

Rapid and reversible fragmentation of chromosomal DNA into HMW DNA fragments in U937 cells treated with VM-26 and H₂O₂.

A

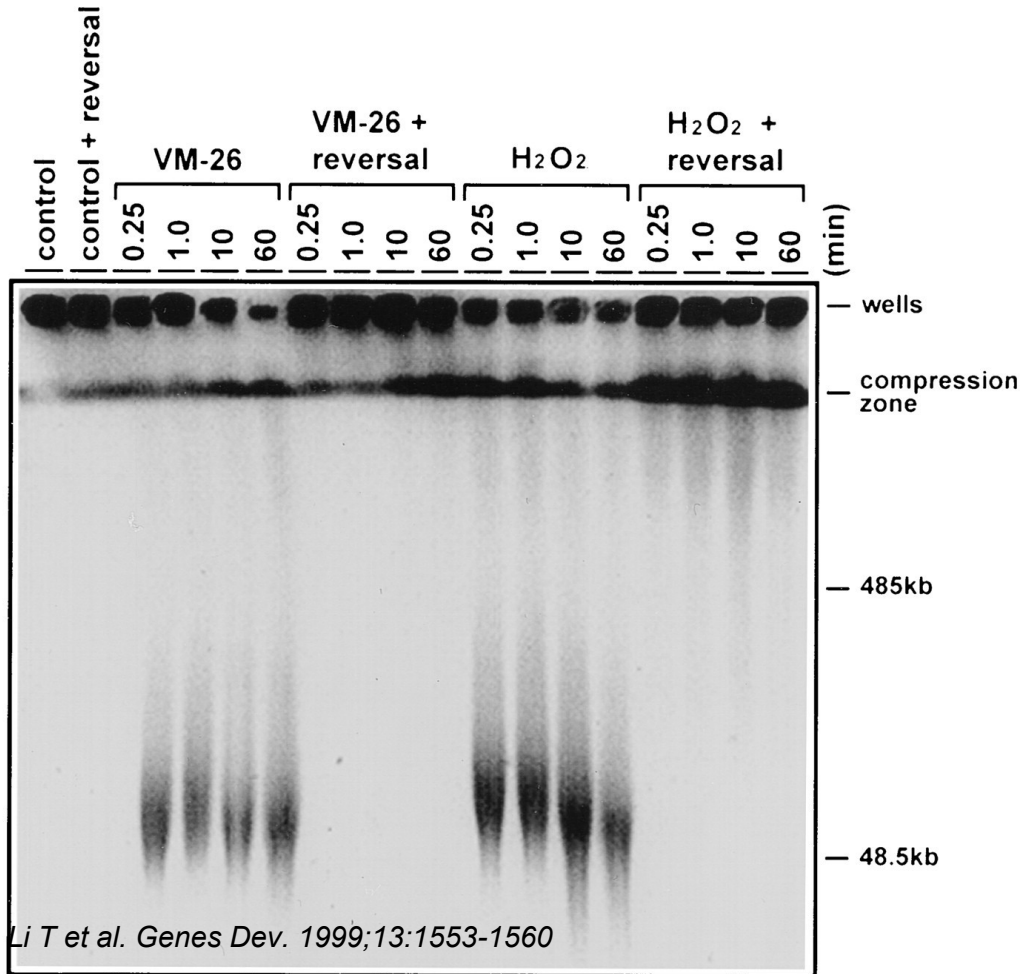

B



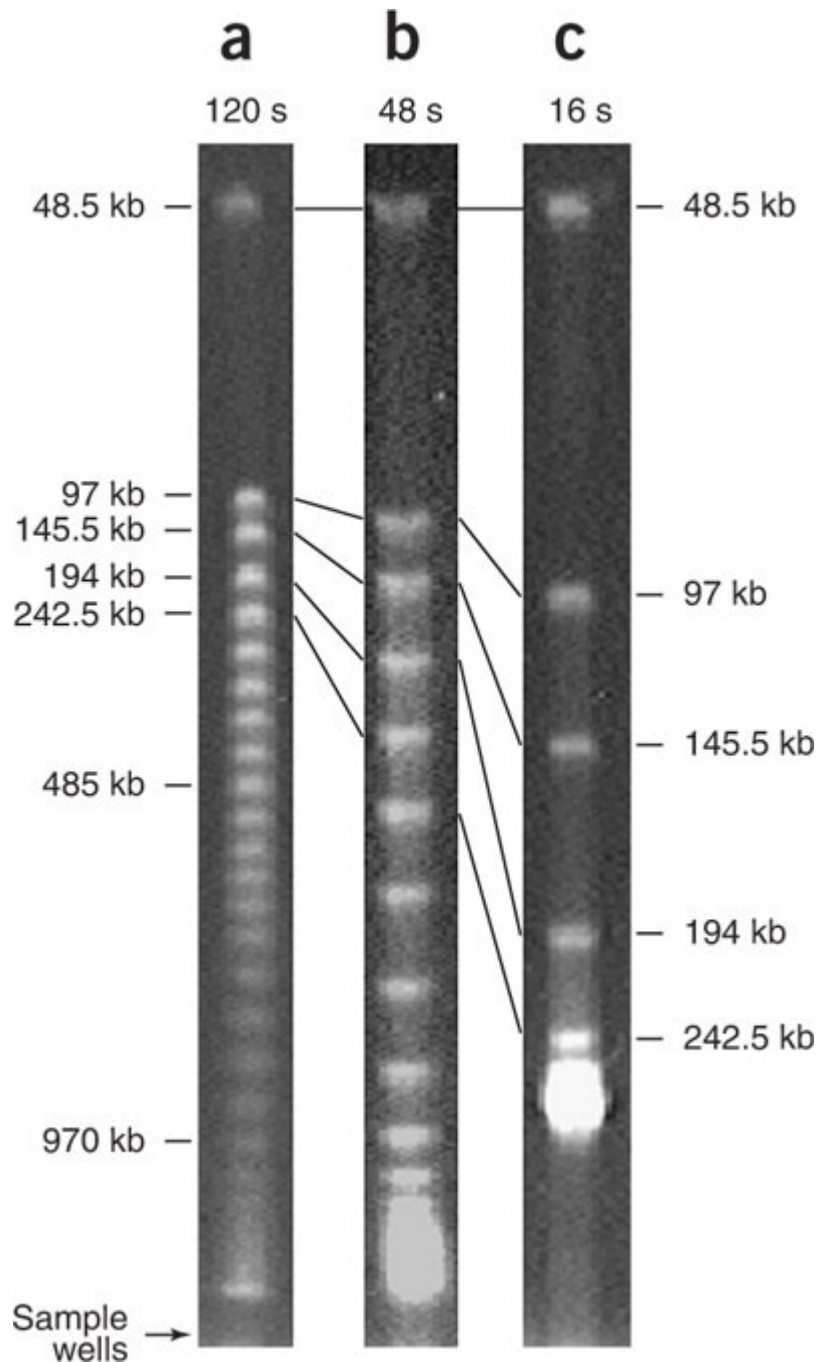

Na čem závisí rozlišení PFGE:

1) **délka pulsu** – čím delší puls, tím větší molekuly se stihnou přeorientovat a mohou se pohybovat. Většinou se pracuje s několika různými délkami pulsu nebo s jejich gradientem během doby elfo.

- 1) úhel mezi vektory intenzity pole
- 2) napětí (čím větší napětí, tím rychlejší přeorientování molekul)
- 3) teplota
- 4) koncentrace a EEO agarózy (0,8-1,2%)
- 5) koncentrace a volba pufru (TBE, TAE)

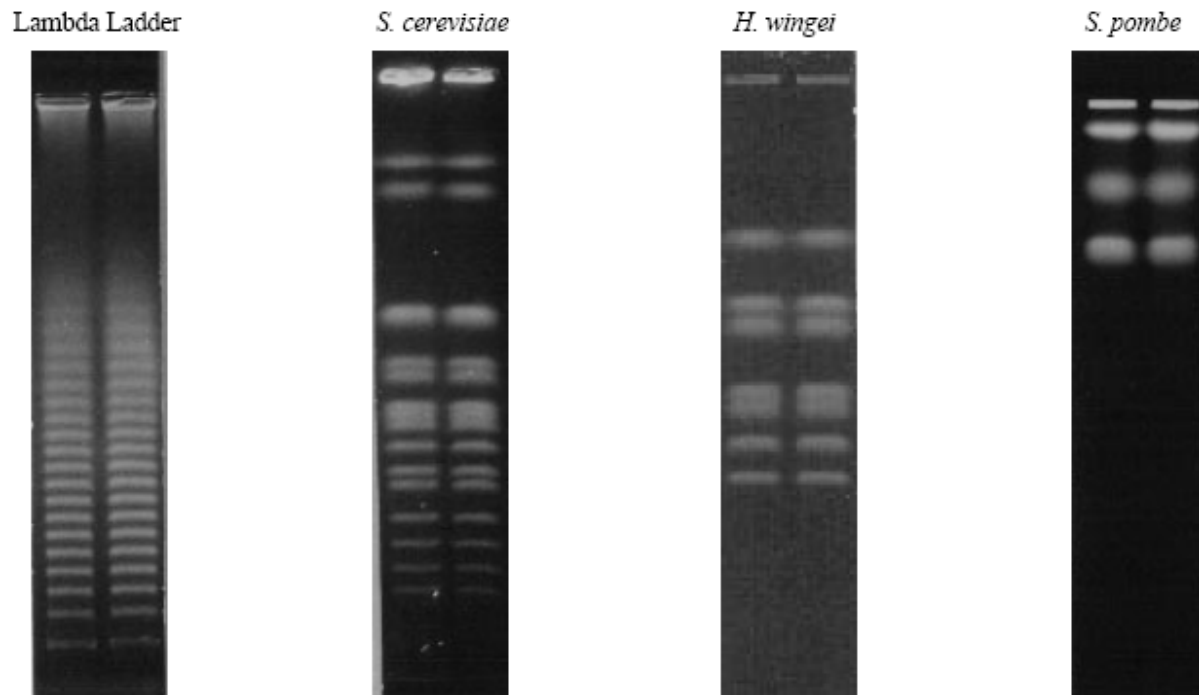

Fig. 4.2. A. Lambda ladder (catalog number 170-3635) was separated on a 1.0% Molecular Biology Certified Agarose (catalog number 162-0133) gel in 0.5x TBE, recirculated at 14 °C. The run time was 22 hours at 6 V/cm with a 50 to 90 second switch time ramp.

B. *Saccharomyces cerevisiae* Strain YNN295. (Catalog number 170-3605). Chromosomes were separated on a 1.0% Pulsed Field Certified Agarose (catalog number 162-0137) gel in 0.5x TBE, recirculated at 14 °C. The run time was 24 hours at 6 V/cm with a 60 to 120 second switch time ramp.

C. *Hansenula wingei* Strain YB-4662-VIA. (Catalog number 170-3667). Chromosomes were separated on a 0.8% Molecular Biology Certified Agarose gel in 1.0x TAE, recirculated at 14 °C. The run time was 50 hours at 3 V/cm with a 250 to 900 second switch time ramp.

D. *Schizosaccharomyces pombe* Strain 972 h-. (Catalog number 170-3633). Chromosomes were separated on a 0.6% Chromosomal Grade Agarose (catalog number 162-0135) gel in 1.0x TAE, recirculated at 14 °C. The run time was 72 hours at 2 V/cm with a 20 to 30 minute switch time ramp.