

# System savců (Mammalia)

## V. Eutheria, Placentalia: Euarchontoglires

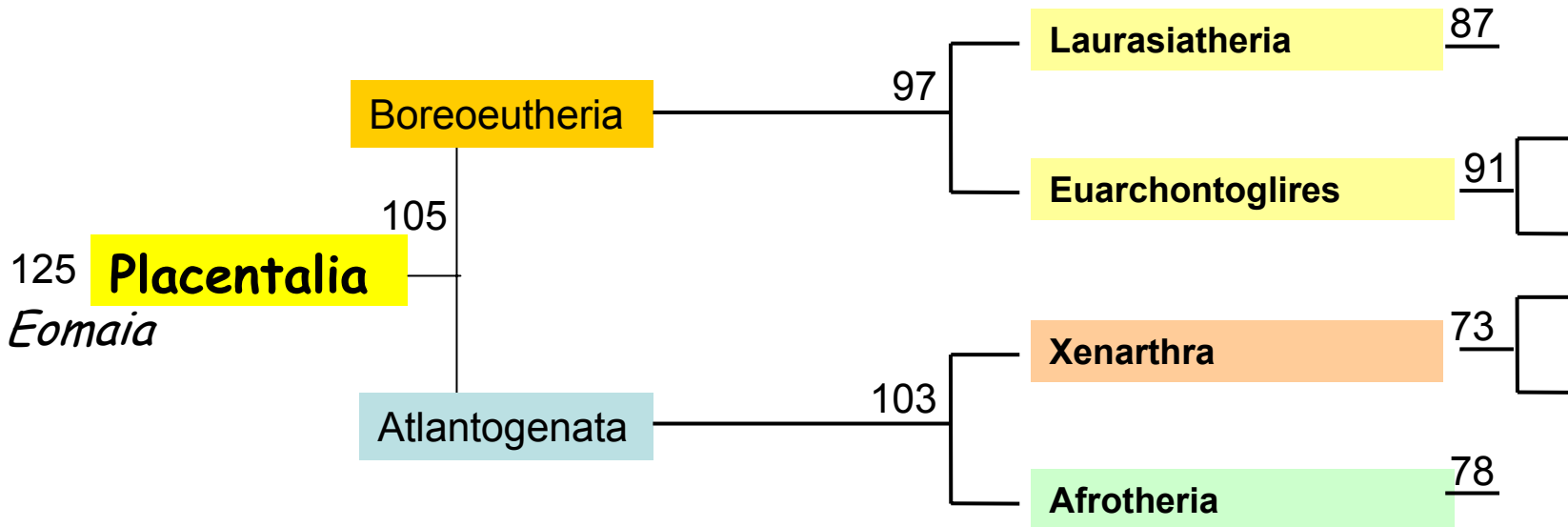

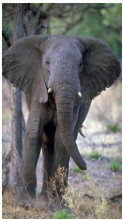
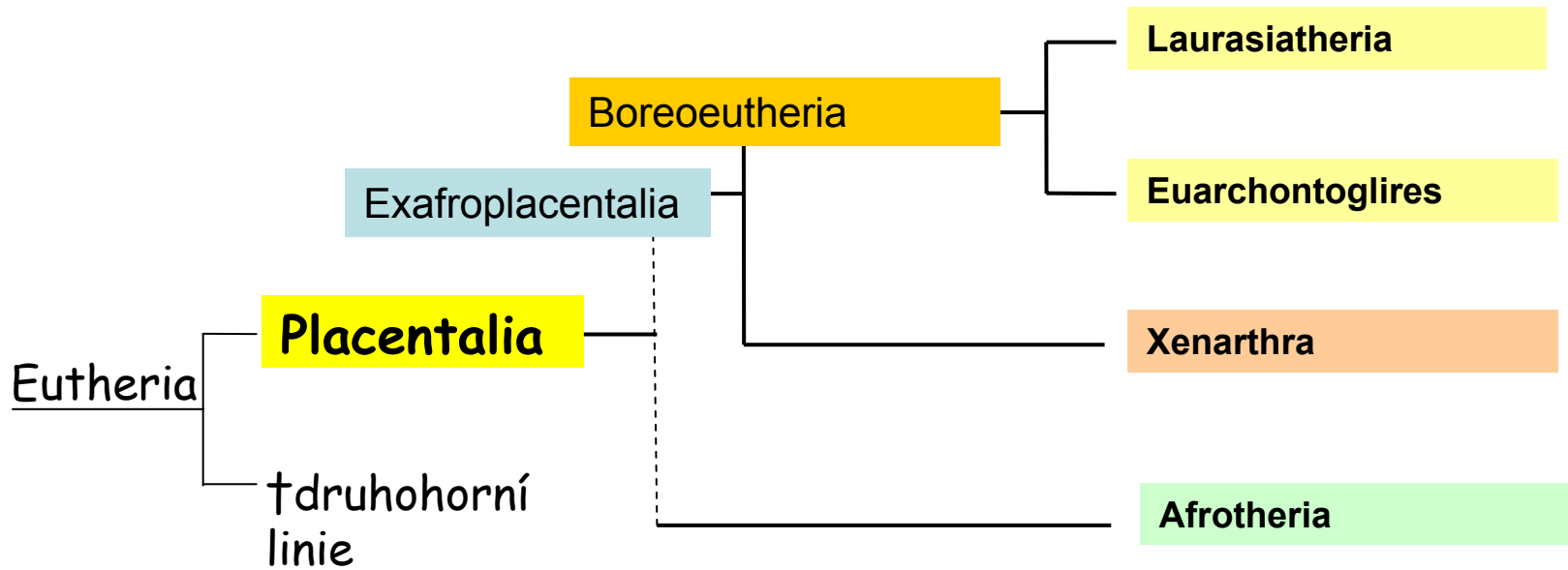

# Euarchontoglires

Předkové v Asii před 85-90 mil. lety

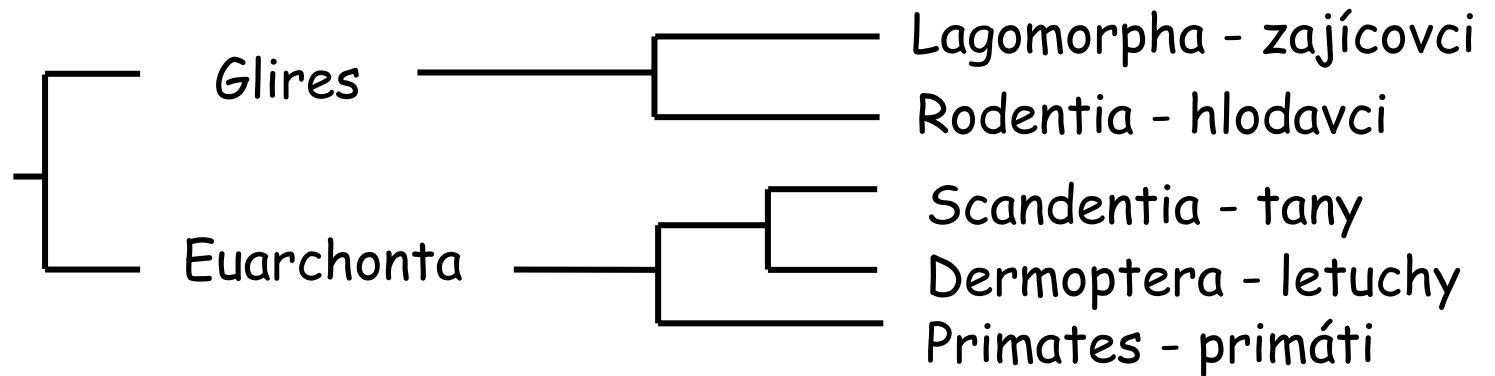

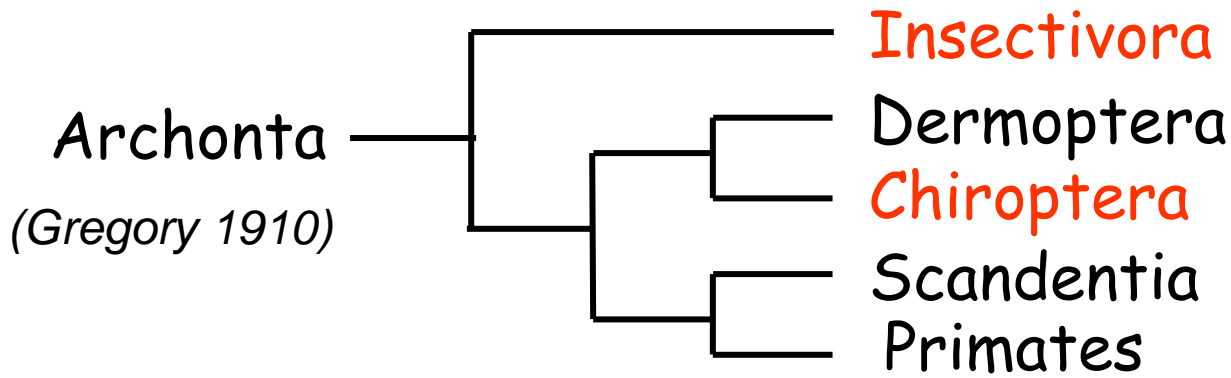

Archonta = Euarchonta + Insectivora + Chiroptera

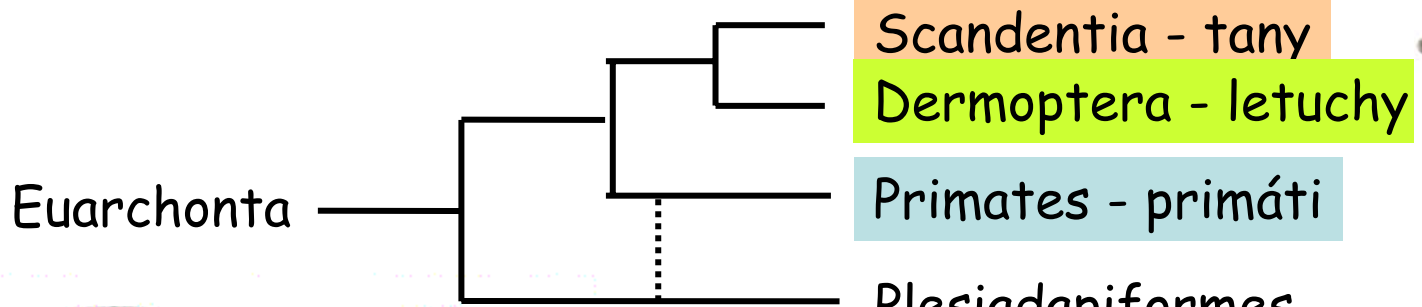

Scandentia - tany  
 Dermoptera - letuchy  
 Primates - primáti  
 Plesiadapiformes  
 střední paleocén - 60 Mya  
 Evropa, SAM

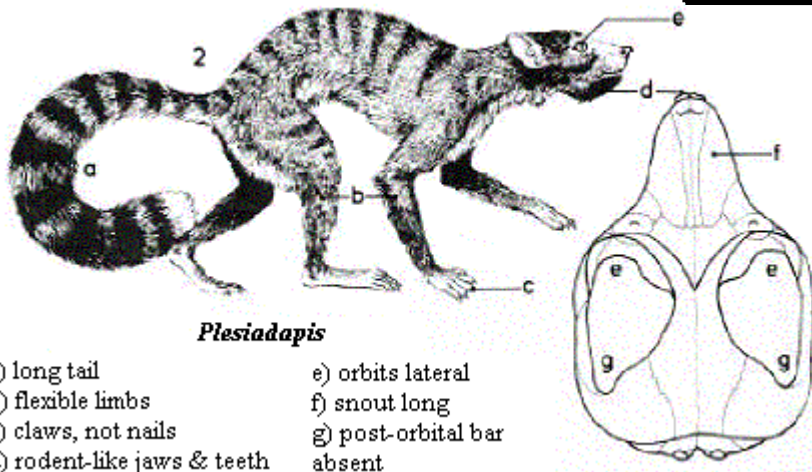

terestrický předek → arborikolní  
 (frugivorie, herbivorie)  
 velké řezáky a diastema)

- a) long tail
- b) flexible limbs
- c) claws, not nails
- d) rodent-like jaws & teeth
- e) orbits lateral
- f) snout long
- g) post-orbital bar absent

# Primates - primáti

Primates = první, nejvyšší (Karl Linné)

Primárně arborikolní s přechodem k denní aktivitě (barevné vidění), adaptace ke šplhání - palec v opozici, ohebné prsty často s nehty, volný ramenní kloub - clavícula; tendence k prostorovému vidění, „generalizování“ savci, úplný bunodontní chrup (2133), počet zubů 18-38, gyrencephální mozek, redukce čichu - zkracování viscerokrania a zesílení jařmového oblouku, uzavírání očních, reprodukce - K-stratégové

Tropické lesy, 13 čeledí, 233 rec. druhů

# Primates - primáti

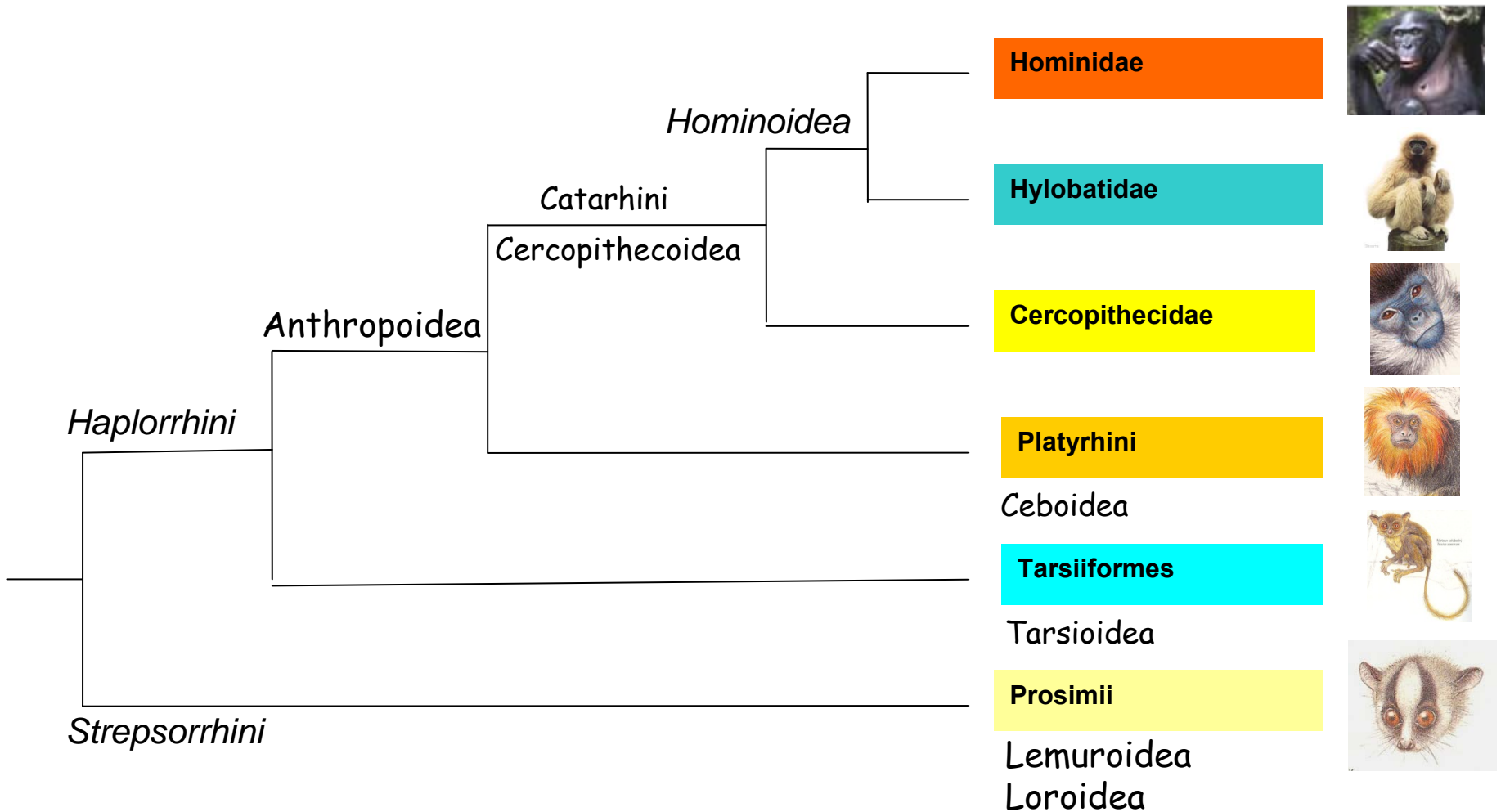

Strepsorrhini - lemuři, rhinarium vyvinuto - stále vlhká, lysá kůže kolem nozder  
 Haplorrhini - ostatní, redukované rhinarium

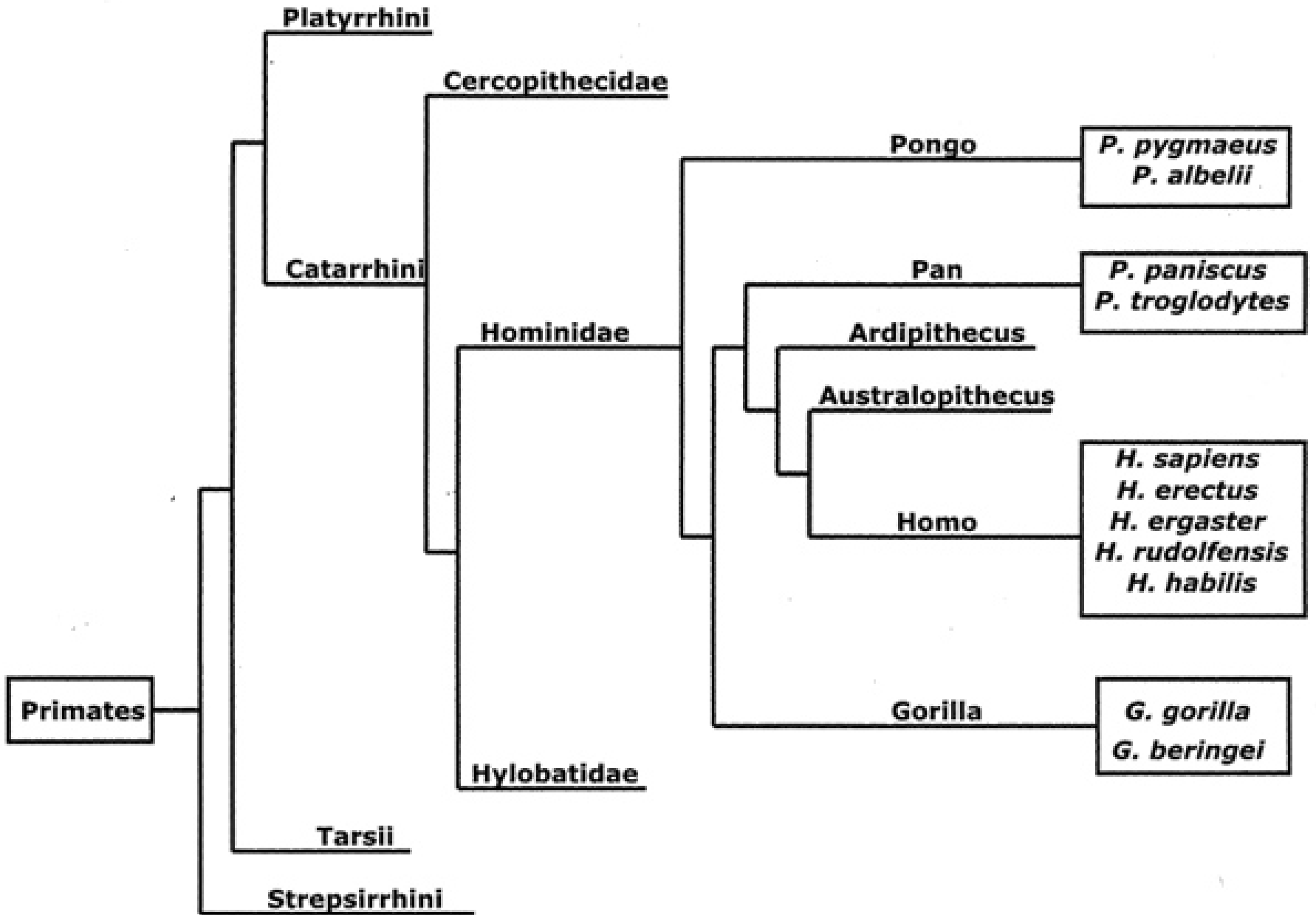

# Primates

## Haplorhini



relatively short  
rostrum

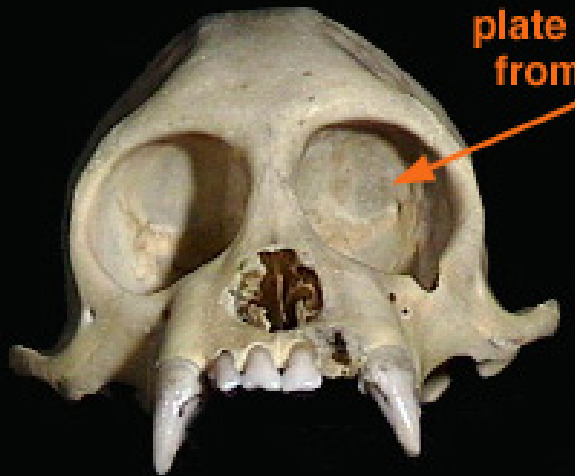
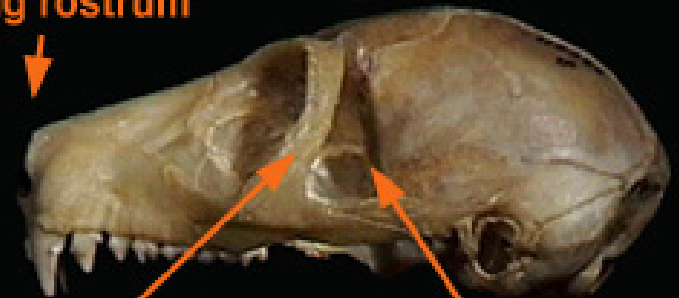

plate separating orbits  
from temporal fossa

## Strepsirhini

relatively  
long rostrum



postorbital bar

temporal fossa

no plate





## Prosimii - poloopice

- prsty většinou s drápy, palec vždy nehet, palec zadní končetiny chápavý, i srůstý prstů, hřebínek na drápku 2. prstu zadní končetiny
- velké oči - očnice ještě vzadu otevřené, převážně noční, malý mozek, zadní končetiny delší než přední, živí se hmyzem, nebo mlád'aty obratlovců, nebo býložraví
- krátká říje, 2-3 holá a slepá altriciální mlád'ata
- 7 čeledí, 88 druhů, subsaharská Afrika, Madagaskar, JV Asie

lemur kata *Lemur cata*



outloň *Nycticebus coucang*



**Lemuroidea:** jen Madagaskar, *lemuros* - lat. duchové zemřelých, duchové noci - světélkující oči, naříkavý pláč (indri - rezonanční vak na průdušnici - 2-3 km)

**Cheirogaleidae - makiovití** (trpasličí lemuři) - 15 (maki - *Cheirogaleus*, *Microcebus*, *Allocebus*), tuk v kořeni dlouhého ocásku, aestivace, 36 zubů, noční, vegetariáni.

*Microcebus*

maki





lemur kata



lemur vari – pralesní forma



lemur vari červený  
– pralesní forma z poloostrova  
Masoala



**Lemuridae - lemuři denní**, 10 (Lemur catta, Eulemur, Haplemur, Varecia variegata), čištění srsti spodními řezáky a špičáky, 36 zubů, dráp jen na 2. prstu zadní nohy, jinak nehty, vegetariáni, i na Komorských ostrovech - introdukce



noční lemur - *Lepilemur*



Megalapidae - lemuři **noční**, 23 (*Lepilemur*), jen 32  
zubů, chybí horní řezáky

Daubentoniidae - ksukol ocasatý (aye-aye), *Daubentonia madagascariensis*, jen 18 zubů, **srostlé řezáky k hlodání** - skořápky ořechů, **vpředu dlouhý prostřední prst** k vytahování dužniny z bambusových stébel, ořechů ze skořápky, hmyzu ze dřeva, **noční**



ksukol





ksukol



„madagaskarská veverka“ -  
srostlé řezáky v hlodavé zuby



Indriidae - indriovití 11 (Indri, Avahi, Propithecus - sifaka), největší, dlouhé zadní končetiny, tělo ve svislé pozici, chůze po dvou, mezi prsty blána, 30 zubů, denní (avahi - noční), vegetariáni.



*Propithecus* - sifaka

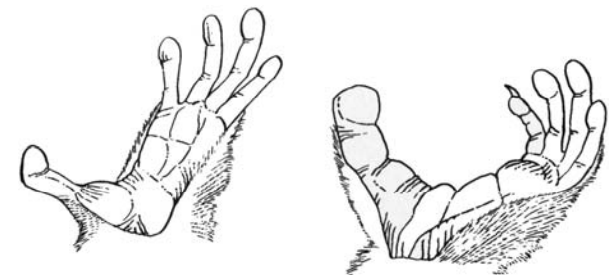
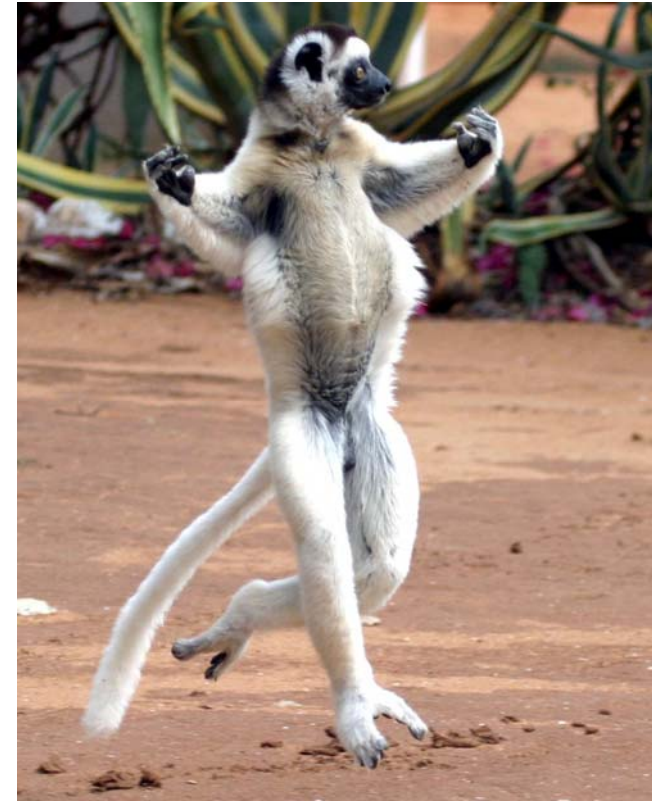

*Indri indri* - redukovaný ocas,  
až 10 kg



*Avahi laniger* - avahi vlnatý - redukovaný ocas, do 1 kg, poplašný křik ava-hi, noční





# Loroidea: Afrika, Indie, JV Asie

Lorisidae - outloňovití 6 (*Loris* - lori, *Nycticebus* - outloň, *Arctocebus* - poto, *Perodicticus* - poto), zavalití, kulatá hlava, malé boltce, velké oči, zakrnělý ocas, 2. přední prst zakrnělý, zadní s česacím drápem, ovoce i hmyz, **noční**, Indie, Cejlon (lori) a JV Asie, Indonézie, Borneo, Filipíny (outloň), Afrika (poto)

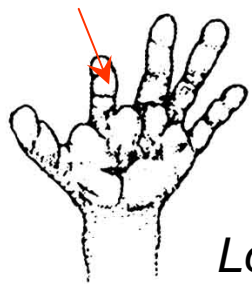

*Loris*

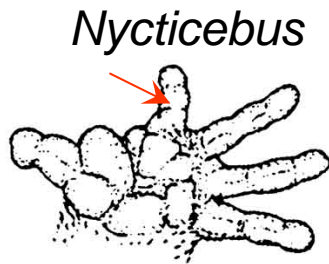

*Nycticebus*

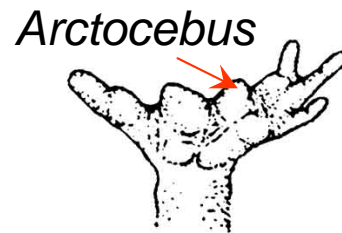

*Arctocebus*

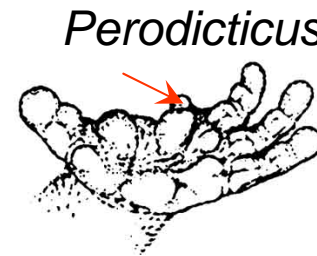

*Perodicticus*

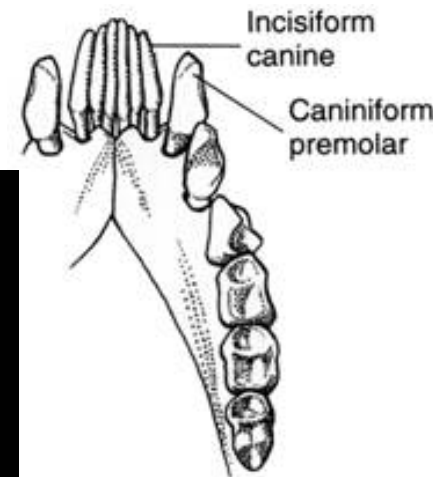
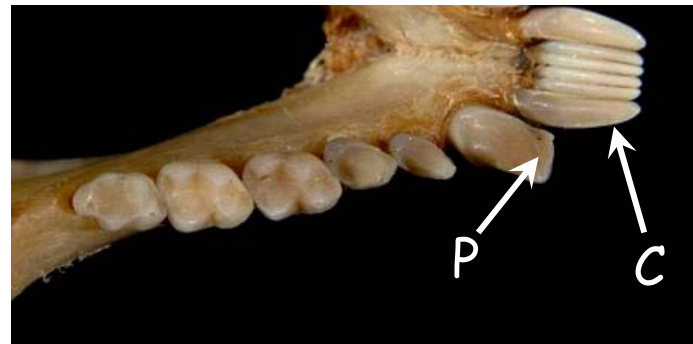

*Nycticebus* - outloň





Galagonidae - kombovití 12 (*Galago*, *Galagoides*, *Euoticus*, *Otolemus*),  
Afrika, 36 zubů, velké boltce, děti buše, dlouhé nohy, chytání  
létajícího hmyzu, dlouhý ocas - kormidlo při skoku, vedle hmyzu se žíví  
pryskyřicí a mízou stromů, překociální mlád'ata, aktivita soumráčná až  
noční

*Galago senegalensis* - komba ušatá



# Tarsiidae - nártouni (7)

Pokročilá stavba mozku, JV Asie, noční - velké oči, velká hlava, malý trup, dlouhý ocas, na prstech paličkovité přísavky, dlouhé nártý (tarsalia), loví skokem hmyz a drobné obratlovce

## Tarsiidae - nártounovití (*Tarsius*)





# Anthropoidea - vyšší primáti

zkrácený obličej, **oči ve frontální rovině s uzavřenými očnicemi**, dokonalý zrak, velký gyrifikovaný mozek, nehty, denní aktivita (vyjma JM mirikina), převážně býložraví (plody), kosman zakrslý - gorila

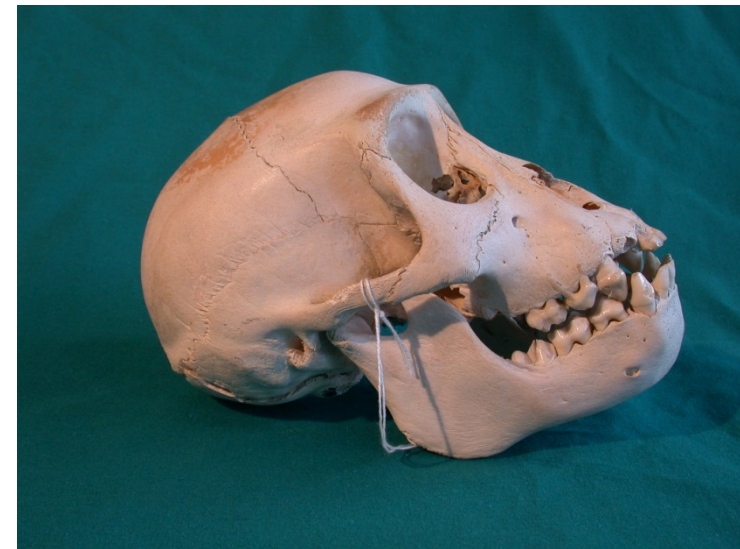
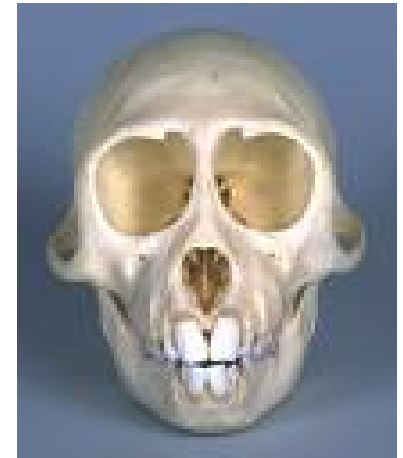
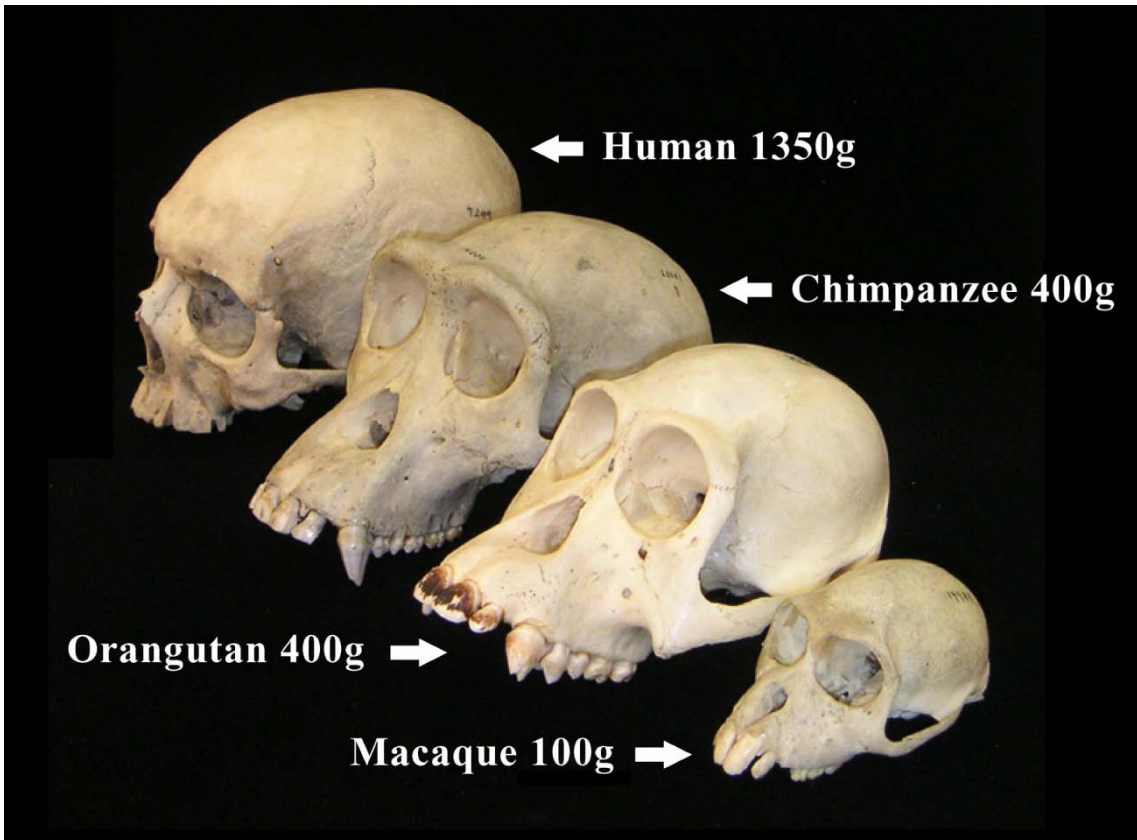

**Platyrrhini (Ceboidea)** - ploskonosí, opice N. světa (4 čeledi, 128 druhů), drápkaté opice

Široká mezinosní přepážka, **ectotympanicum** - tenký prstenec, JAm

### PLATYRRHINES

Zygomatic-Parietal Contact

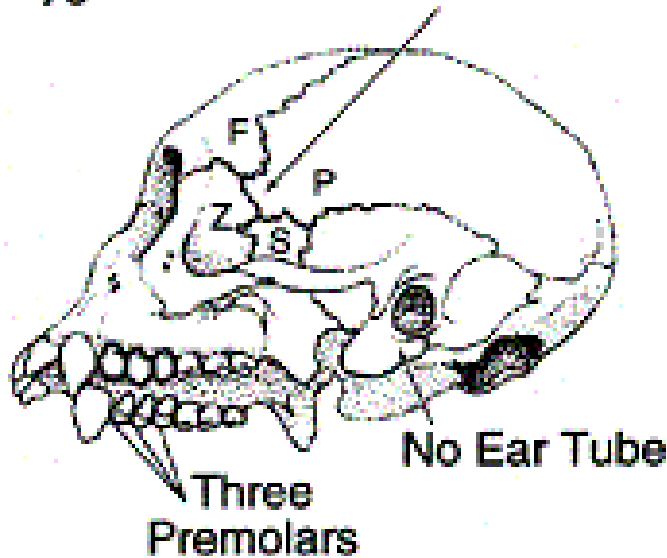

Z-P kontakt

### CATARRHINES

Frontal-Sphenoid Contact

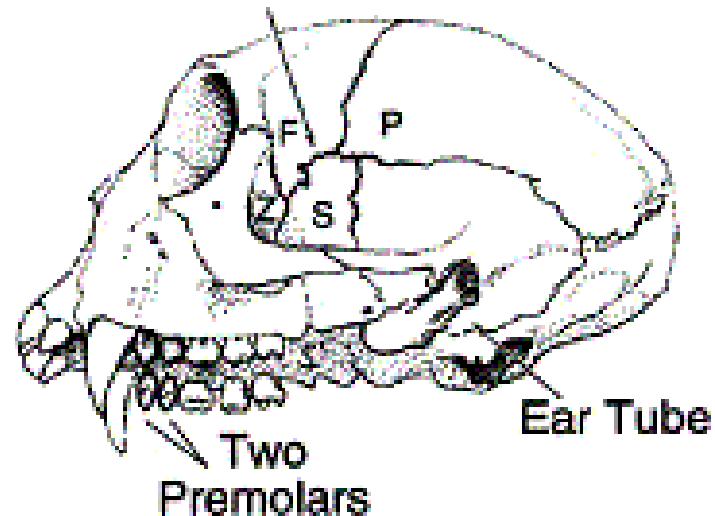

F-S kontakt

Callithricidae - kosmanovití (26), většina prstů s drápkou, primitivní, hladké hemisféry, nechápavý ocas delší než tělo, bledě modré malé oči, osrstěné boltce

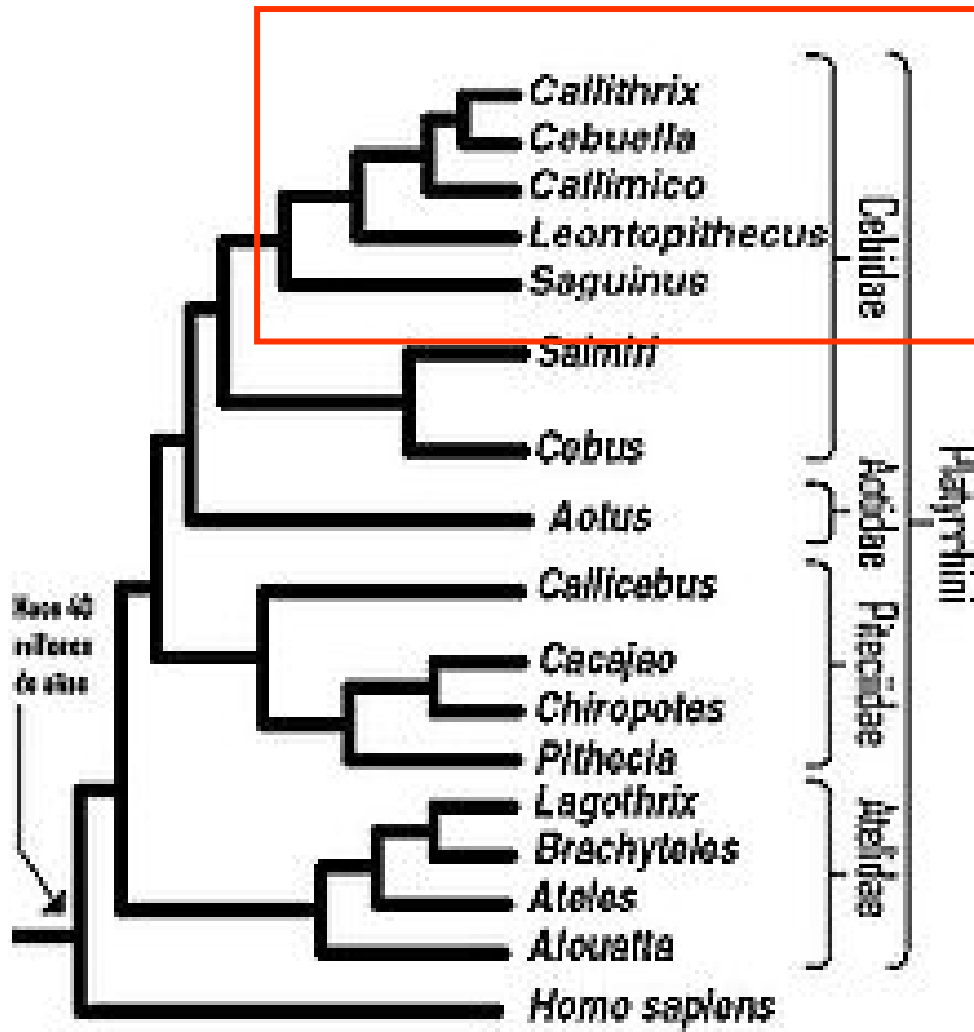

Callos = řec. krásný





kosman bělovousý *Callithrix jacchus*



kosman zakrslý *Cebuella pygmaea*



lvíček zlatý *Leontopithecus rosalia*



tamarín žlutoruký *Sanguinus*



tamarín pinčů



**Cebidae - malpovití** (58), tropické pralesy JAm, noční mirikiny (i sam. čeled' - Aotidae), malpy s chápavým ocasem, kotulové (Cebidae s.s.), chvostani, titiové a uakari (i sam. čeled' - Pitheciidae), neosrstěný boltec

**Atelidae - chápanovití**, chápavý ocas, brachiátoři

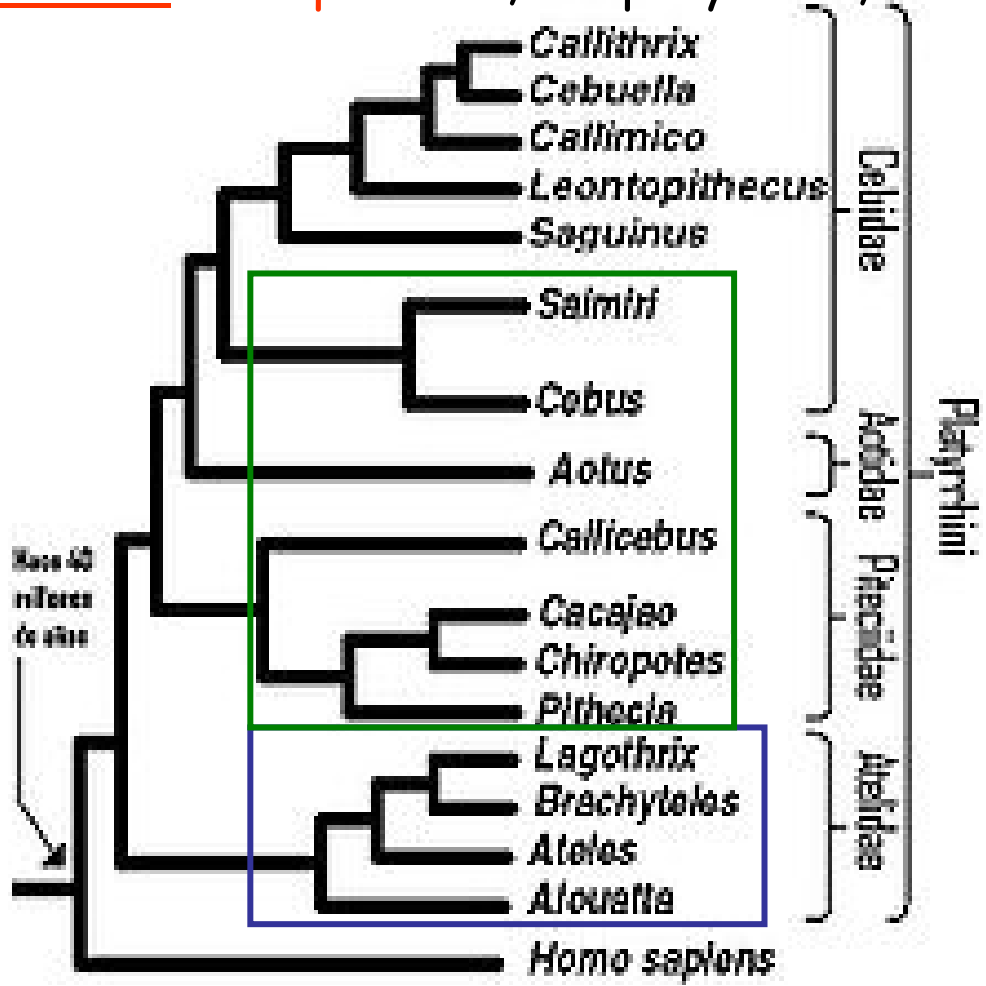

kotul  
malpa  
mirikina  
titi  
uakari  
chvostan  
chvostan



chápan  
chápan  
chápan  
vřešť'an

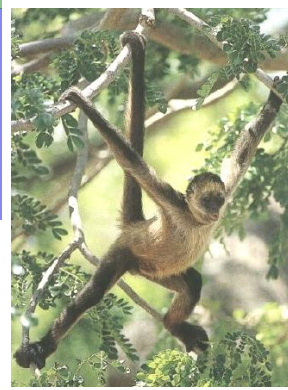

**Catarrhini (Cercopithecoidea)** - úzkonocí, opice St. světa  
úzká nosní přepážka, ectotympanicum - dlouhá trubice, Afr., Asie, zubní  
vzorec (2123), ocas není chápavý, sedací hrboly, palce v opozici, na ruce  
i redukován, jen nehty, samice mají menstruační cyklus  
Cercopithecidae - kočkodanovití (130), klenutá lebka, hulmani (As),  
guerézy (Afr), makakové (As), paviáni (V Afr, PŘAs), kočkodani (Afr)



hulman  
posvátný

gueréza  
plášťiková



makak  
rhesus



pavián plášťikový



mandril

kahau

kočkodan husarský



# Hominoidea

Z úzkonosých opic, velcí s dorzoventrálně zploštělým hrudníkem, prodloužené přední končetiny, brachiace, ztráta ocasu, malé nebo bez sedacích hrbolů, drypitěkový vzorec stoliček (Y), dlouhá gravidita, 1 mládě; Hylobatidae (giboni, 14)) a Hominidae (lidoopi a lidé)

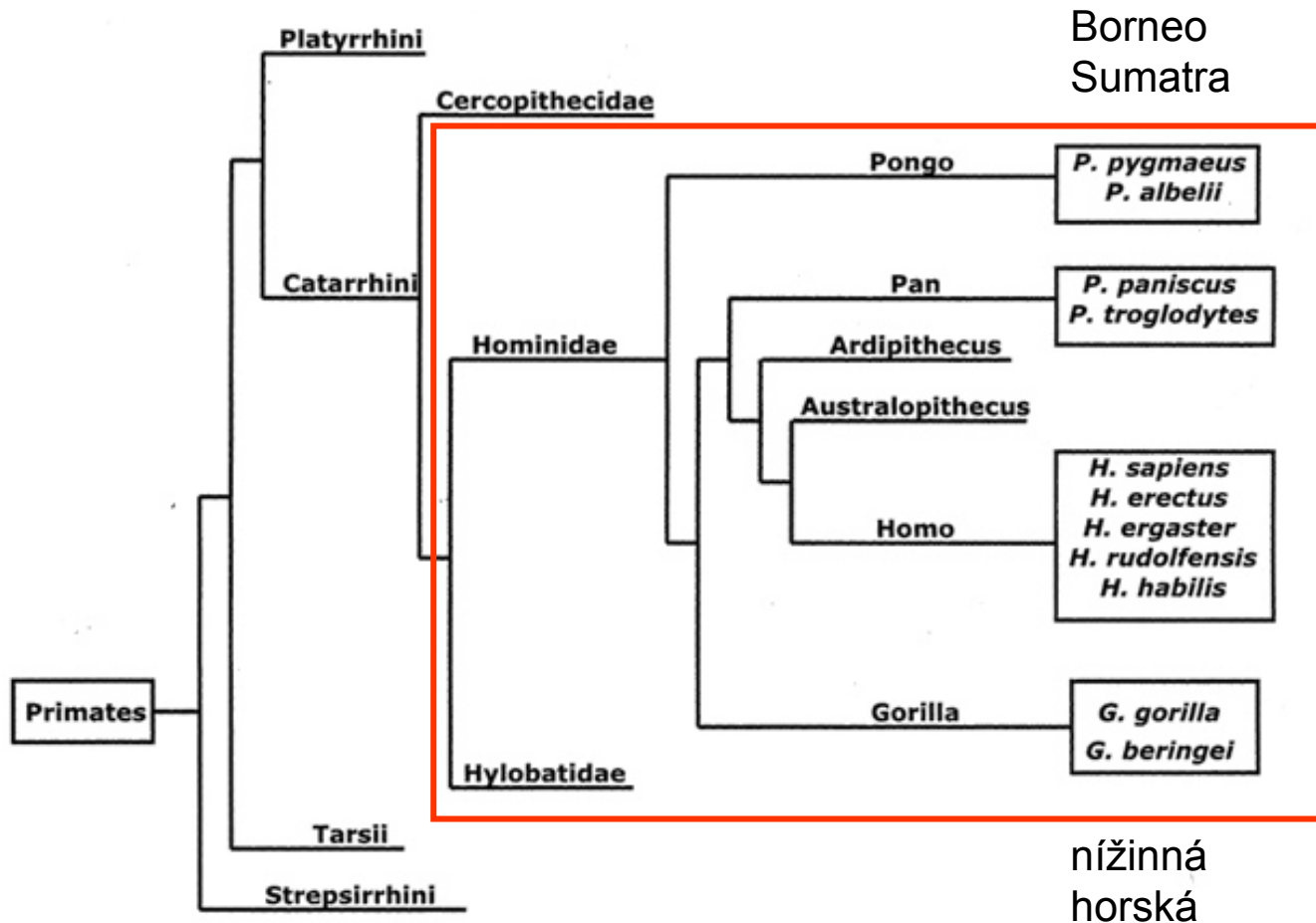



Hylobatidae - stromoví brachiátoři, po zemi bipedně



Gibon běloruký - lar

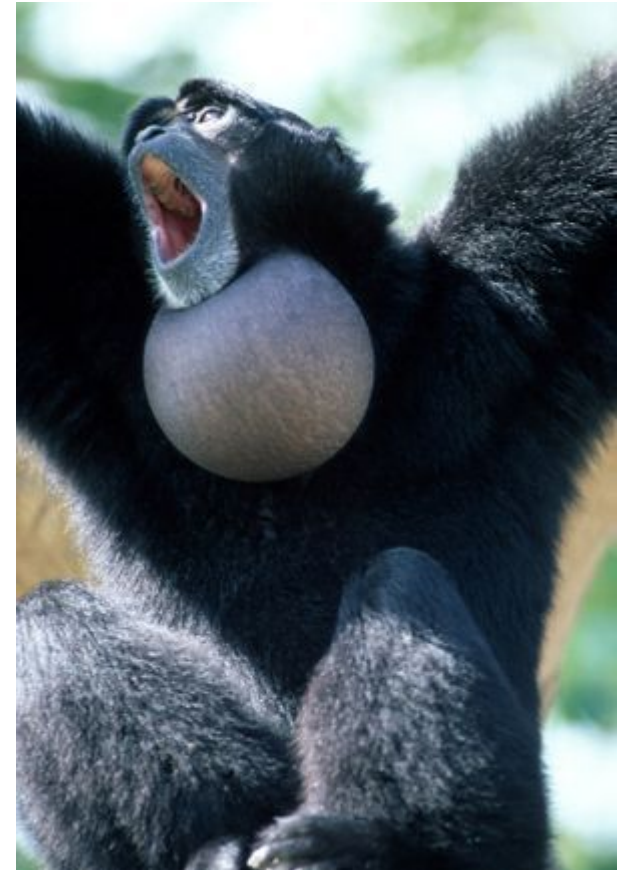

siamang



# A New Kind of Ancestor: *Ardipithecus* Unveiled

The oldest known hominin skeleton reveals the body plan of our very early ancestors and the upright origins of humankind

Every day, scientists add new pages to the story of human evolution by deciphering clues to our past in everything from the DNA in our genes to the bones and artifacts of thousands of our ancestors. But perhaps once each generation, a spectacular fossil reveals a whole chapter of our prehistory all at once. In 1974, it was the famous 3.2-million-year-old skeleton "Lucy," who proved in one stroke that our ancestors walked upright before they evolved big brains.

Ever since Lucy's discovery, researchers have wondered what came before her. Did the earliest members of the human family walk upright like Lucy or on their knuckles like chimpanzees and gorillas? Did they swing through the trees or venture into open grasslands? Researchers have had only partial, fleeting glimpses of Lucy's own ancestors—the earliest hominins, members of the group that includes humans and our ancestors (and are sometimes called hominids). Now, in a special section beginning on page 60 and online, a multidisciplinary international team presents the oldest known skeleton of a potential human ancestor, 4.4-million-year-old *Ardipithecus ramidus* from Aramis, Ethiopia.

This remarkably rare skeleton is not the oldest putative hominin, but it is by far the most complete of the earliest specimens. It includes most of the skull and teeth, as well as the pelvis, hands, and feet—parts that the authors say reveal an "intermediate" form of upright walking, consid-

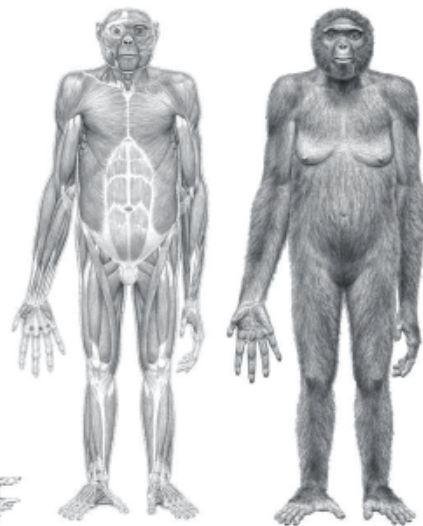
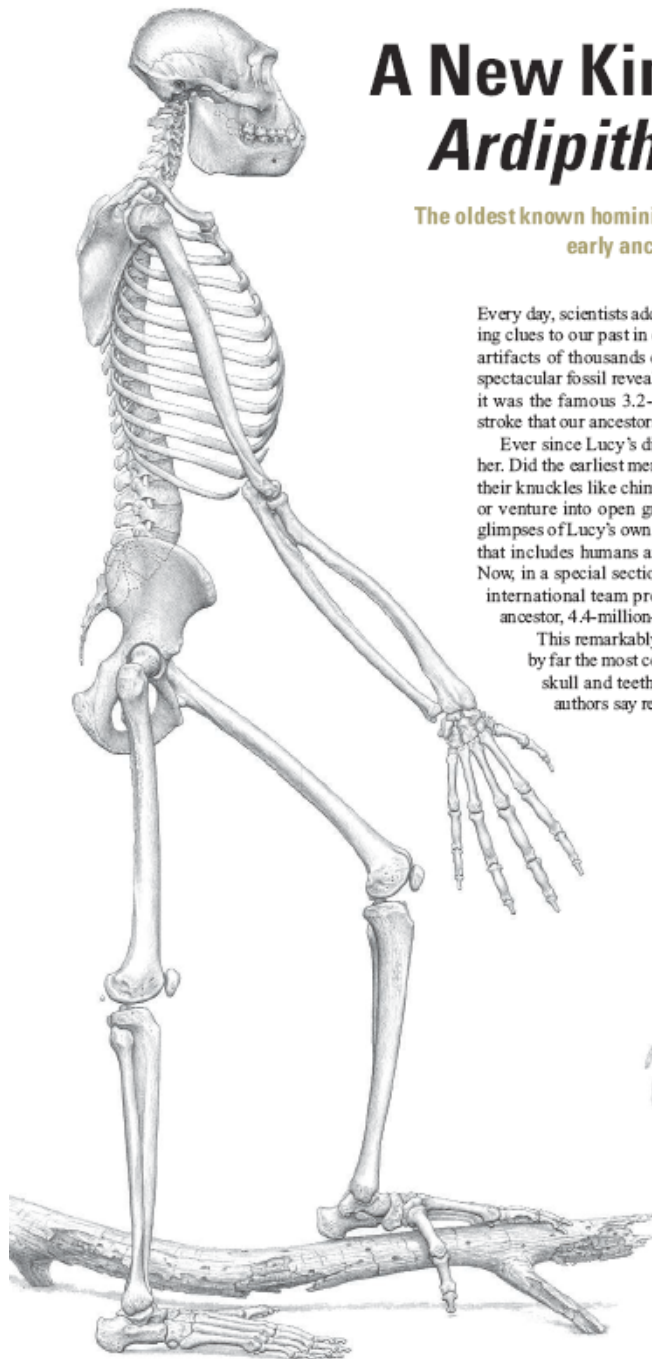

From the inside out. Artist's reconstructions show how Ard's skeleton, muscles, and body looked and how she would have moved on top of branches.

# Hominidae

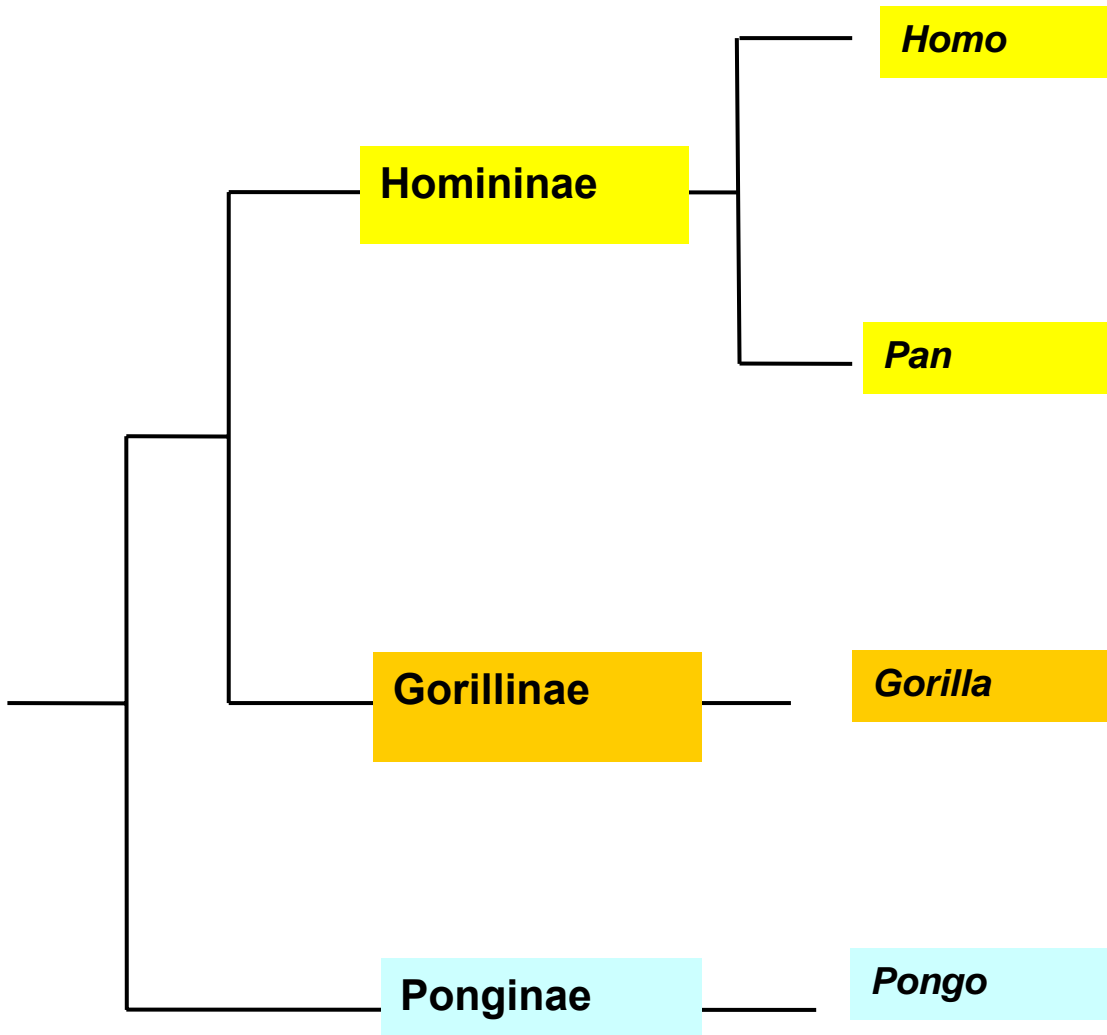

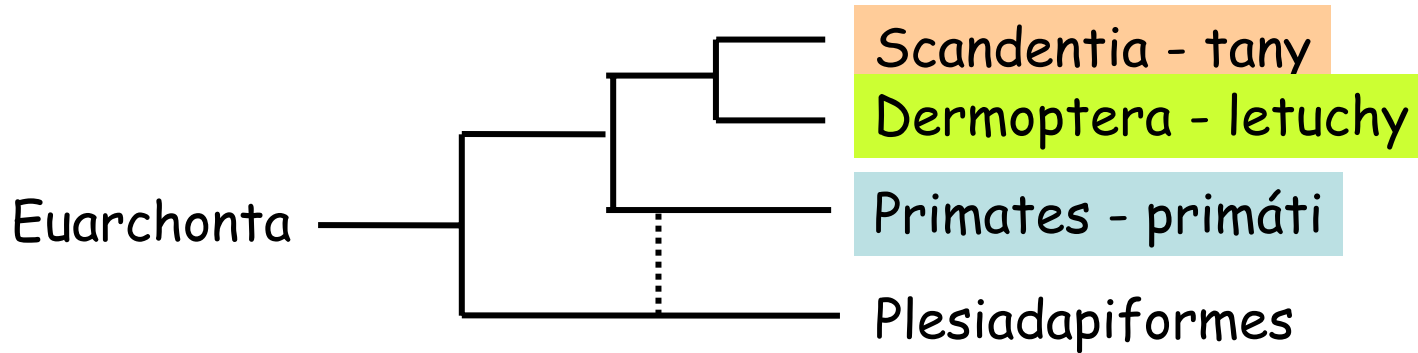

## Dermoptera - letuchy

- osrstěný kožní lem - pasivní klouzavý let (flying lemurs), přes 130 m, **stromoví**, soumravná aktivita, velké dopředu směřující oči - stereoskopické vidění, býložraví - úplný chrup, **hřebenité spodní řezáky** (až 20 hrotů) i k čištění srsti,
- velký žaludek a dlouhé stočené tlusté střevo s mikroorganismy trávicími celulózu, velikost kočky (*Cynocephalus volans*, *C. variegatus*)
- l. filipínská, l. malajská)

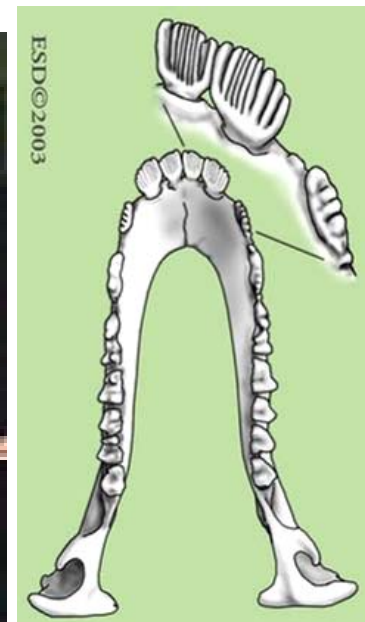



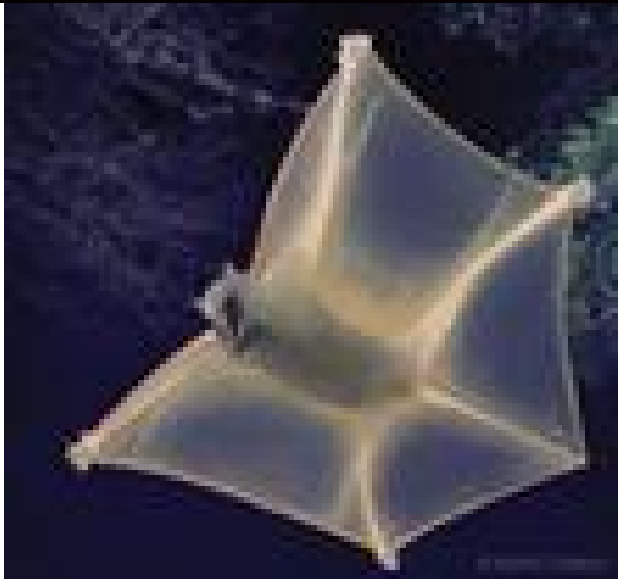
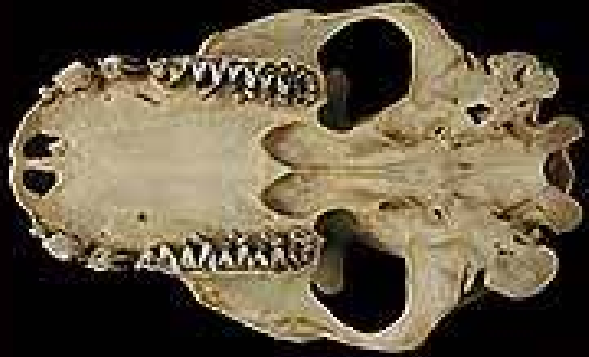



## Scandentia - tany

- protažený čenich, nápadné boltce, **dilambdodontní chrup**
- JV Asie, stromoví, podobní veverkám („tupaia“), dlouhý osrstěný ocas, lov předními tlapkami, insektivorní, velká mozkovna, uzavřené očné (jako primáti), protáhý lysý čenich jako rejsek (tree shrews), dilambdodontní stoličky (W), sublingua, dlouhé pětiprsté končetiny, pohyblivé boltce, úplný chrup (38 zubů, I2/3, C1/1, P3/3, M3/3), velké horní řezáky, malé špičáky, široké stoličky, **denní aktivita**, již na konci křídly
- t. obecná (*Tupaia glis*), t. péroocasá (*Ptilocercus lowii*)

1 čeleď, 20 druhů  
Tanovití (Tupaidae)



Glires

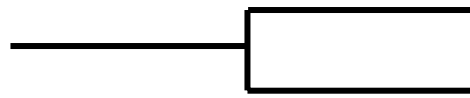

Lagomorpha - zajícovci

Rodentia - hlodavci

Glires

Býložraví s hlodavými zuby, bez špičáků; s diastemou, charakteristické žvýkácí svaly, palearktický původ

### Lagomorpha - zajícovci (80-92)

řec. *Lagos* = zajíc, paleocén - *Eurymylus* - VAs

- v horní čelisti **2 páry řezáků**, I<sup>2</sup> - hlodák - na celém povrchu sklovina; za ním drobný I<sup>3</sup>; lofodontní stoličky s vysokými korunkami (hypsodontní), svalový výběžek nevyvinut, býložravci
- **cekotrofie**
- kulovitý čelistní kloub
- ploskochodci s osrstěnou spodinou tlapek, redukovaná clavicula
- u samců scrotum před penisem, bez bakula

Pišťuchovití (Ochotonidae, 26) eocén

- velehory Asie a SAm, krátké boltce, zakrnělý ocas

Zajícovití (Leporidae, 54-58) paleocén

- pozemní, hrabou nory, prodloužené boltce a zadní nohy, rozeklané pysky, slepé střevo 10x větší než žaludek, krátký ocas, *Lepus* (28)

# Lagomorpha

# Rodentia

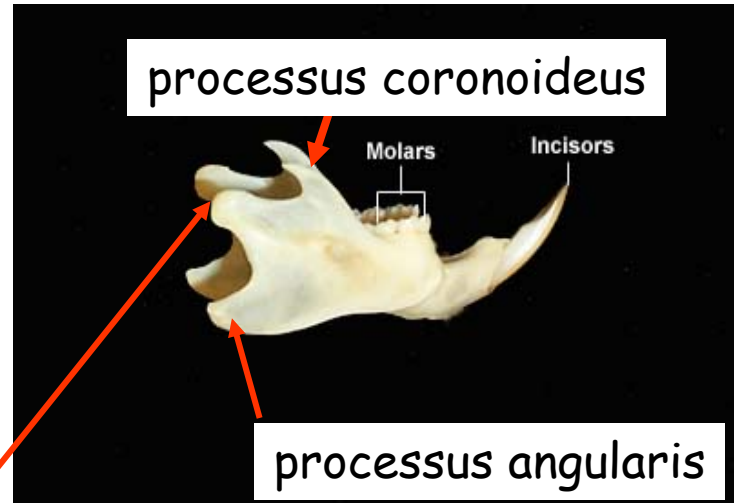
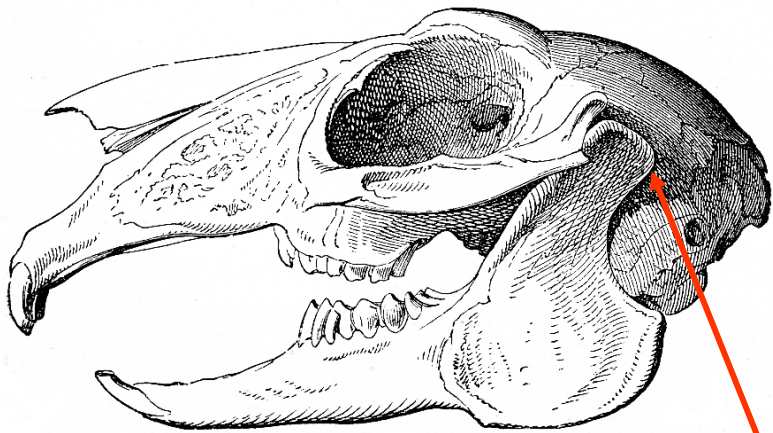

processus articularis



# Ochotonidae

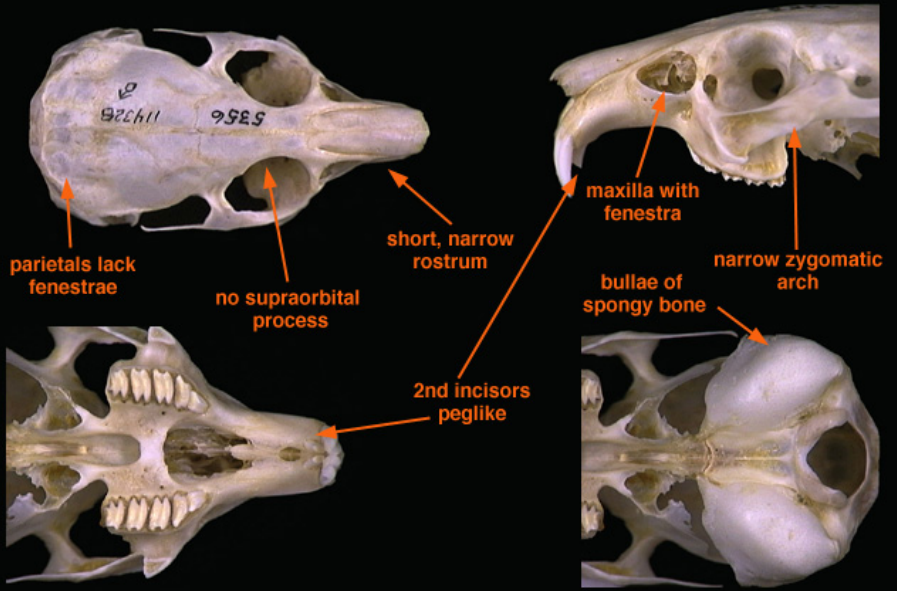

*Ochotona princeps*



# Lagomorpha Leporidae

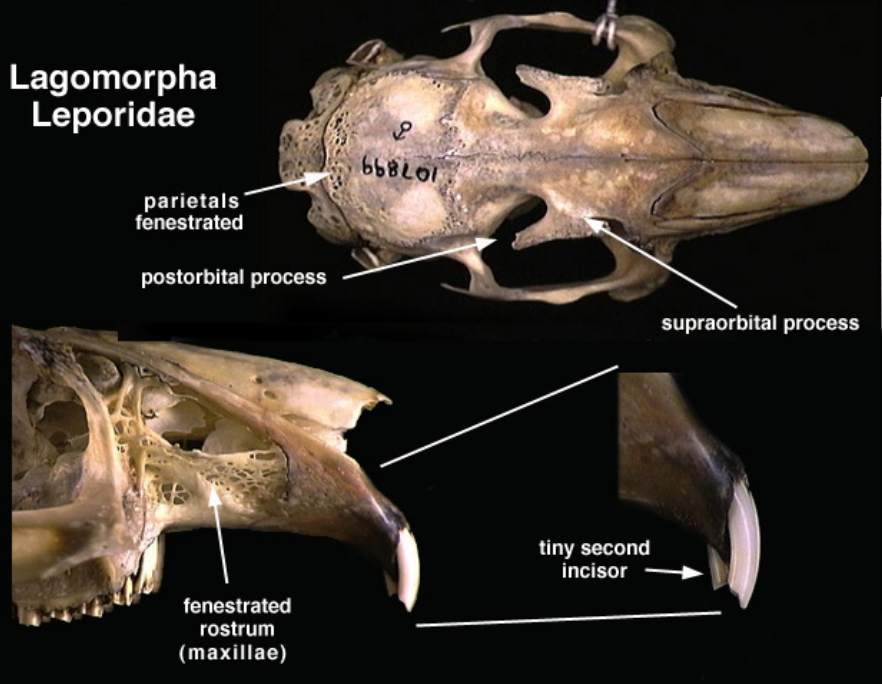

*Oryctolagus cuniculus*

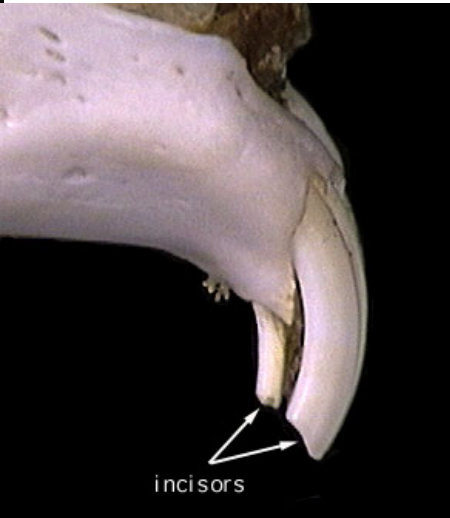

*Lepus europaeus*



*Lepus europaeus*

*Oryctolagus cuniculus*

zajíc



králík



## Rodentia - hlodavci (přes 2000 druhů, u nás 26)

- známí z počátku třetihor, ale podle molekulárních hodin již před 100-94 mil. lety; pozdní paleocén, myšovití až koncem třetihor - rychlá evoluce
- krátká gravidita, početné vrhy, mláďata altriciální, i prekociální (JAm)
- diprotodontní chrup - jen s **jedním párem hlodáků** v každé čelisti, sklovina jen zepředu, diastema, na mandibule zřetelný p. **angularis**
- I1/1, C0/0, P2/1, M3/3 = 22, ztráta P = 16, rypoš stříbřitý 28 zubů



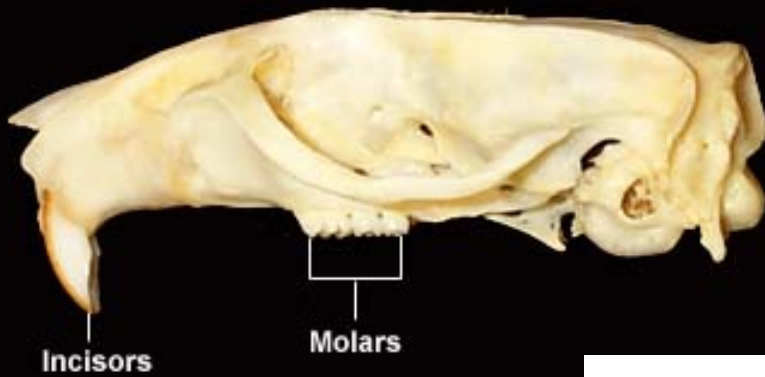
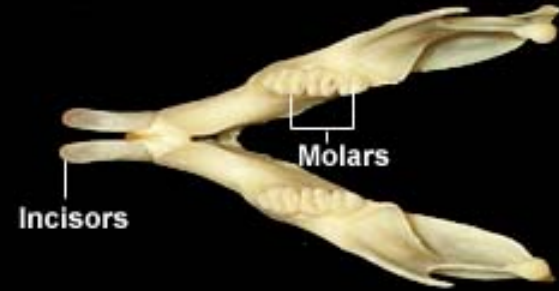

processus coronoideus

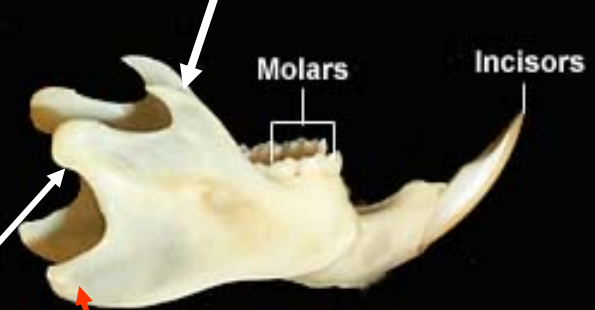

processus articularis

processus angularis

diferenciace m. **masseter** - systematický znak (Brandt 1885)

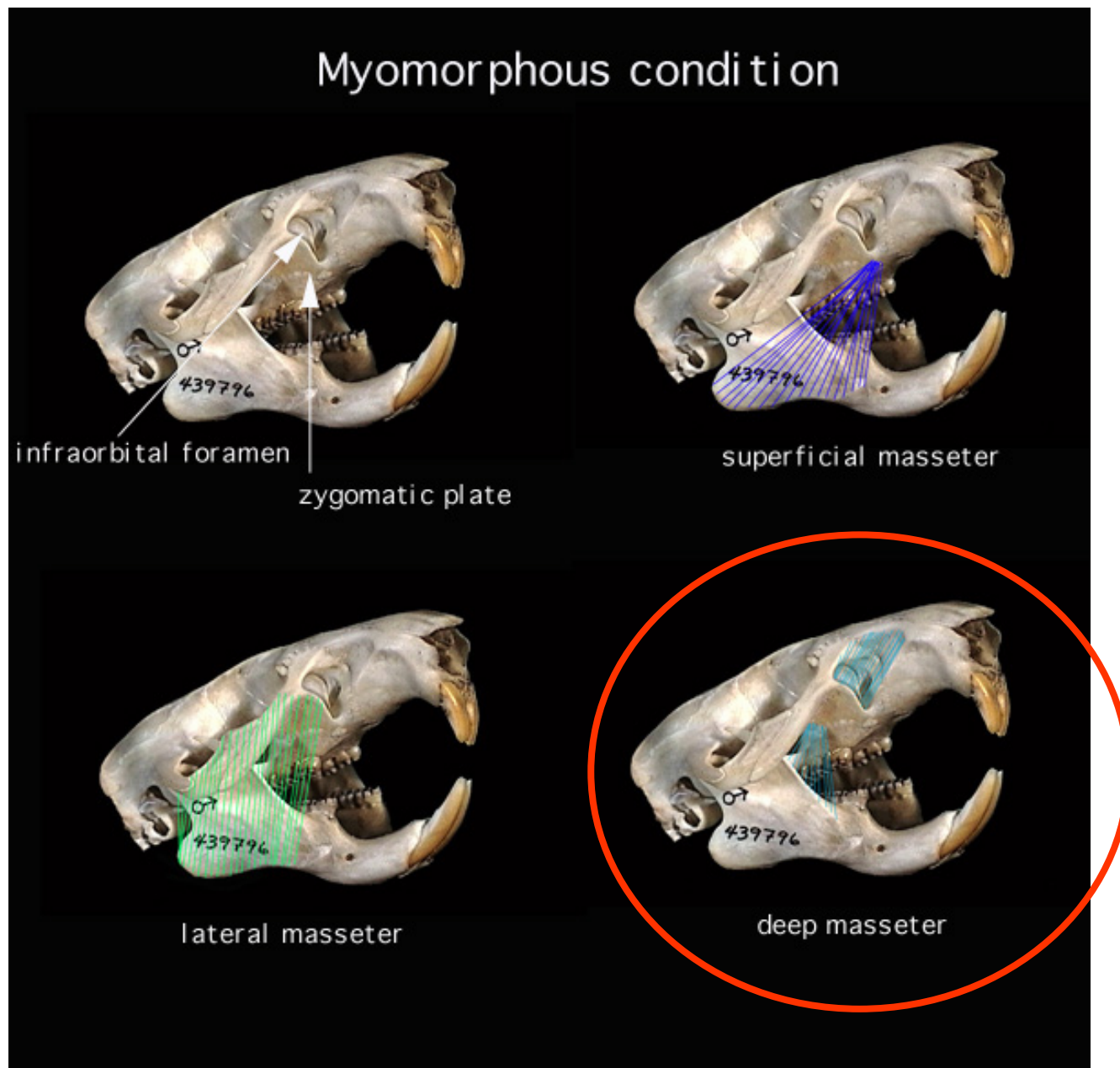



## Medial masseter

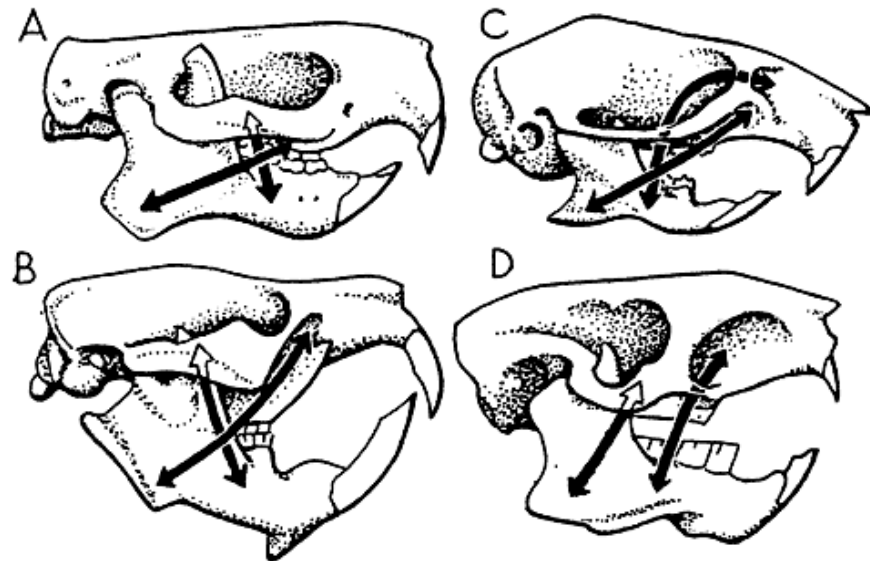
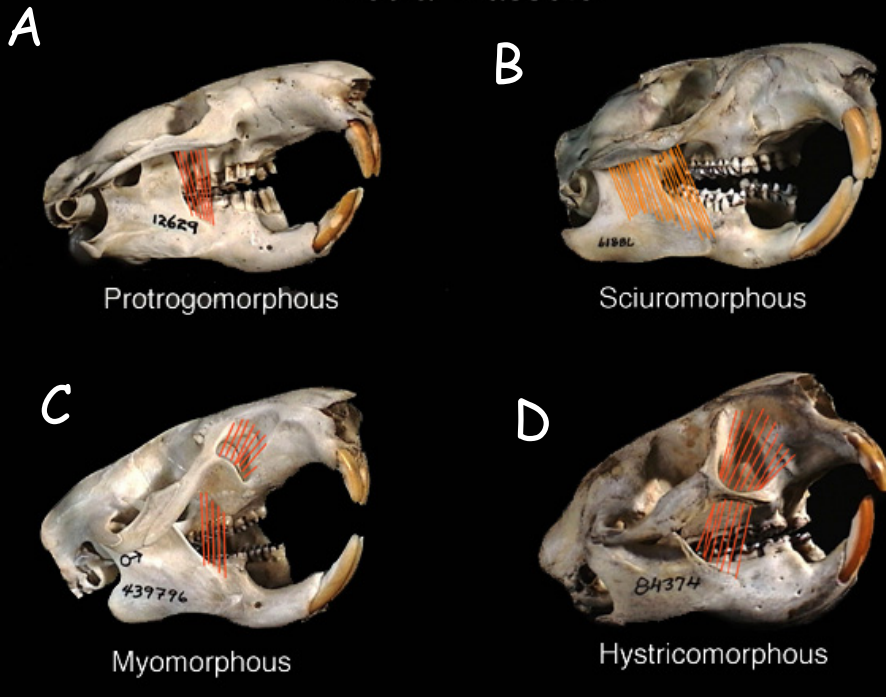

- **protrogomorfní** (bobruškovití - SAm, rypoši - Af), **m.m. na ventrální povrch jařma**
- **sciuiromorfní** (veverkovití, bobrovití - Spol, pytlonošovití, pytloušovití - SAm), **2 větve m.m. na jařmo, 1 laterální větve podél jařma na rostrum**
- **hystrikomorfní** = kaviomorfní (šupinatky - Af, tarbíci - Af, As, gundiové - Af, dikobrazovití - Af, JAs, paky a agutiové - JAm, morčata, nutrie), **střední větve mm. pod jařmem na rostrum skrz rozšířený infraorbitální otvor, laterální větve na jařmo**
- **myomorfní** (myšovití, plchovití) - **1 laterální větve m.m. pod jařmem na rostrum**

## Sciurognathous jaws



## Hystriognathous jaws



- typy podle polohy p. angularis mandibulae: **sciurognátní** - p.a. je pokračováním spodního okraje mandibuly, pod zubní řadou, může se stáčet dovnitř a **hystriognátní** (230) (Tullberg 1899) - p.a. silně vybočený ven mimo zubní řadu, začíná na rameni mandibuly

- 28-33 čeledí, 2277 druhů (40 % savců)

### veverkočelistní (*Sciurognathi*)

bobruškovití (*Aplodontidae*)  
veverkovití (*Sciuridae*)  
bobrovití (*Castoridae*)  
pytlonošovití (*Geomyidae*)  
pytloušovití (*Heteromyidae*)  
tarbíkovití (*Dipodidae*)  
myšovití (*Muridae*)  
šupinatkovití (*Anomaluridae*)  
noháčovití (*Pedetidae*)  
gundiovití (*Ctenodactylidae*)  
slepcovití (*Spalacidae*)

### dikobrazočelistní (*Hystricognathi*)

rypošovití (*Bathyergidae*)  
dikobrazovití (*Hystricidae*)  
skalní krysy (*Petromuridae*)  
řekomyšovití (*Thryonomyidae*)  
urzonovití (*Erethizontidae*)  
činčilovití (*Chinchillidae*)  
pakaranovití (*Dinomyidae*)  
morčatovití (*Caviidae*)  
kapybarovití (*Hydrochaeridae*)  
agutiovití (*Dasyproctidae*)  
pakovití (*Agoutidae*)  
tukotukovití (*Ctenomyidae*)  
osmákovití (*Octodontidae*)  
činčilákovití (*Abrocomidae*)  
korovití (*Echimyidae*)  
hutiovití (*Capromyidae*)  
+ velehutiovití (*Heptaxodontidae*)  
nutriovití (*Myocastoridae*)



# Rodentia

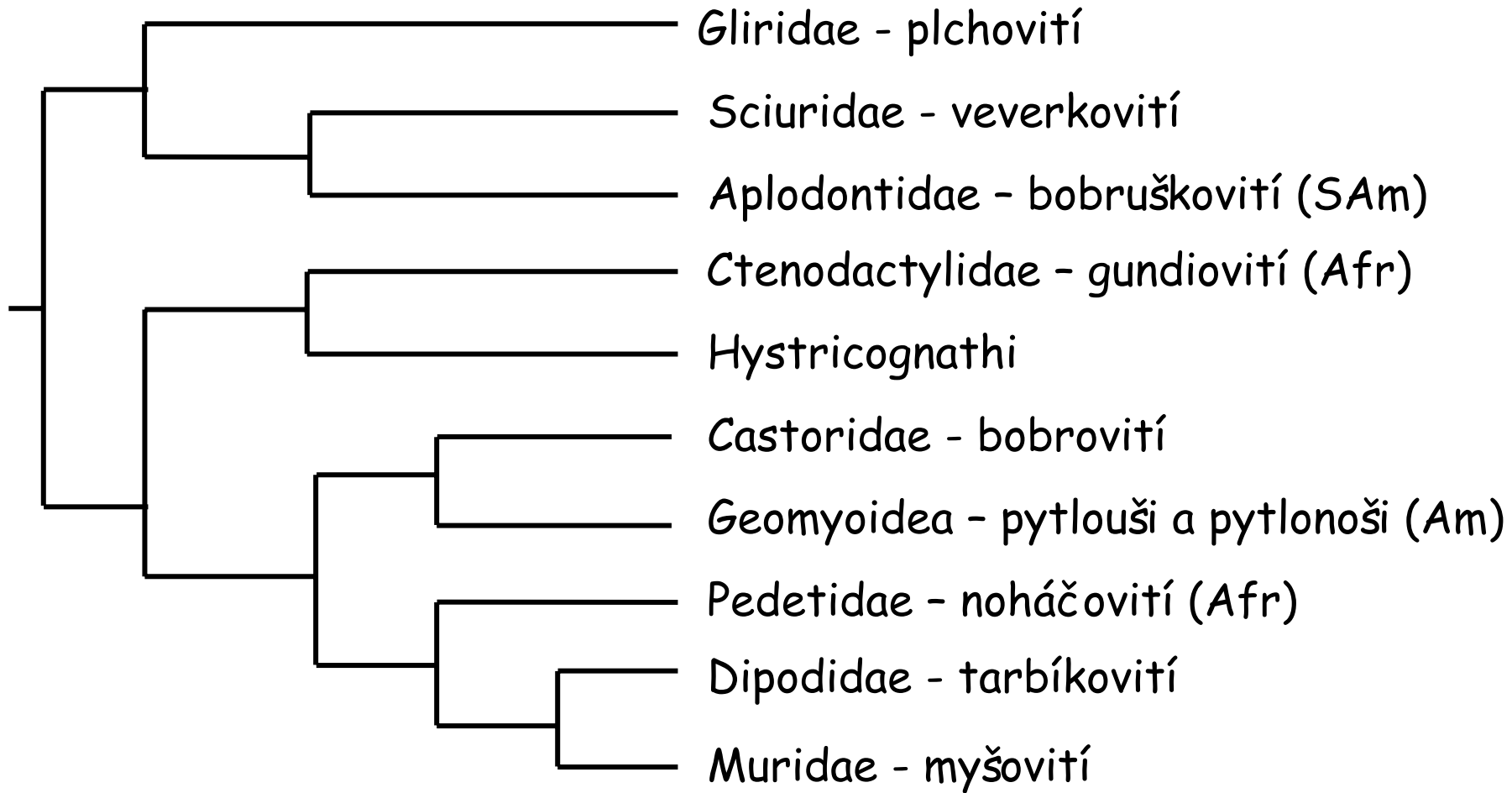

Hystricognathi = rypoši (Bathyergidae), dikobrazi (Hystricidae), morčata (Caviidae), činčily (Chinchilliidae), kapybary (Hydrochoeridae), nutrie (Myocastoridae) aj.

Muridae - myšovití (1300) vč. křečkovití (Cricetidae), hrabošovití (Arvicolidae), rychlá evoluce



*Glis glis*



*Spermophilus fulvus*

*Marmota marmota*



*Sciurus vulgaris*







*Aplodontia rufa* - bobruška  
(SAm)



*Ctenodactylus gundi* - gundi  
(Afr)





*Heterocephalus glaber* - rypoš lysý

*Heliophobius argenteocinereus* - rypoš stříbřitý

(Afr)



© Bruce G. Marcot





*Hydrochoerus hydrochaeris* - kapybara



*Dolichotis patagonum* - mara stepní (JAm)



paka horská - aguti  
(JAm)



dikobraz obecný  
(Afr, JaV Asie, Evr)



urzon kanadský  
(SAM)





bobr kanadský



pytlonoš nížinný

(SaStř Am)

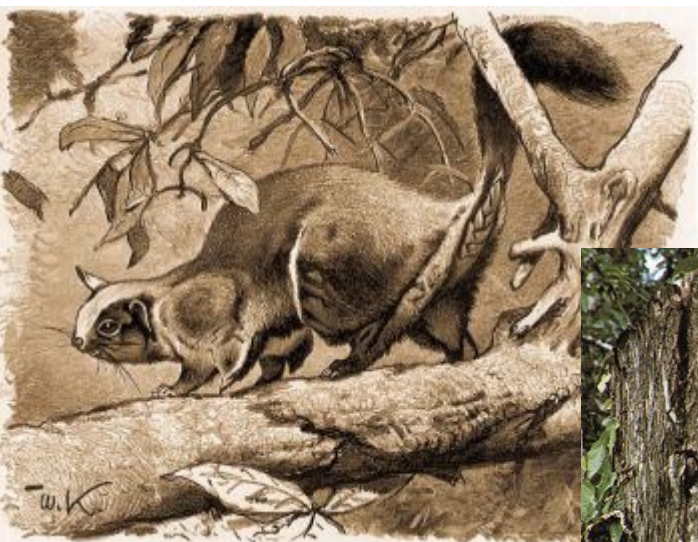

šupinatka

(Afr)



pytlouš mexický

( Am)





noháč jihoafrický - *Pedetes capensis*



slepec malý - *Nannospalax leucodon*



tarbík egyptský - *Jaculus jaculus*

(SV Afr,  
V Asie)

(Afr)





(SV Afr,  
JZ Asie)



myš bodlinatá - *Acomys cahirinus*



pestruška - *Lagurus*  
(stepi Stř. Eurasie)

(od Tur po stř. As)

(J Rusko)



slepuška krtčí - *Ellobius talpinus*



lumík norský - *Lemmus lemmus*  
(hory S Eurasie, Am)

# Microtinae - hrabošovité

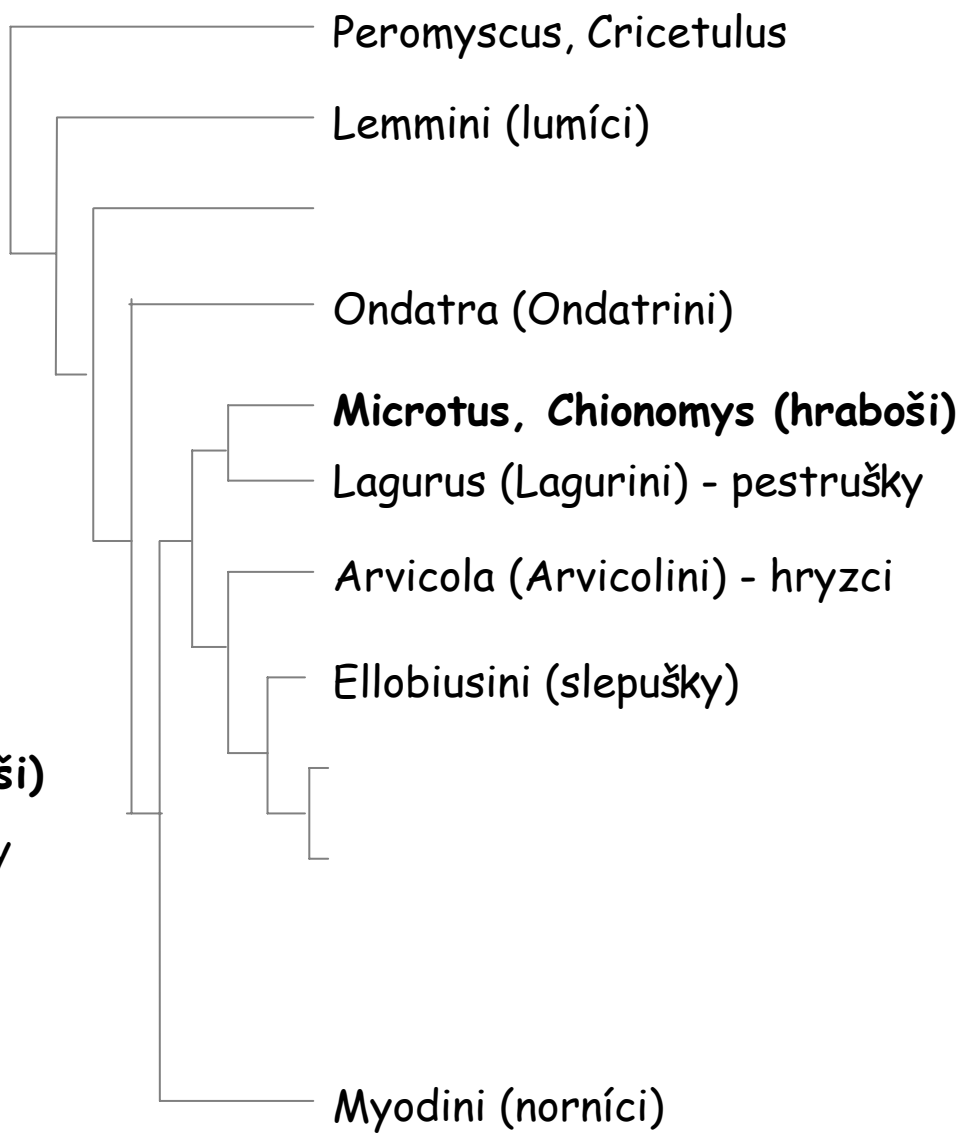
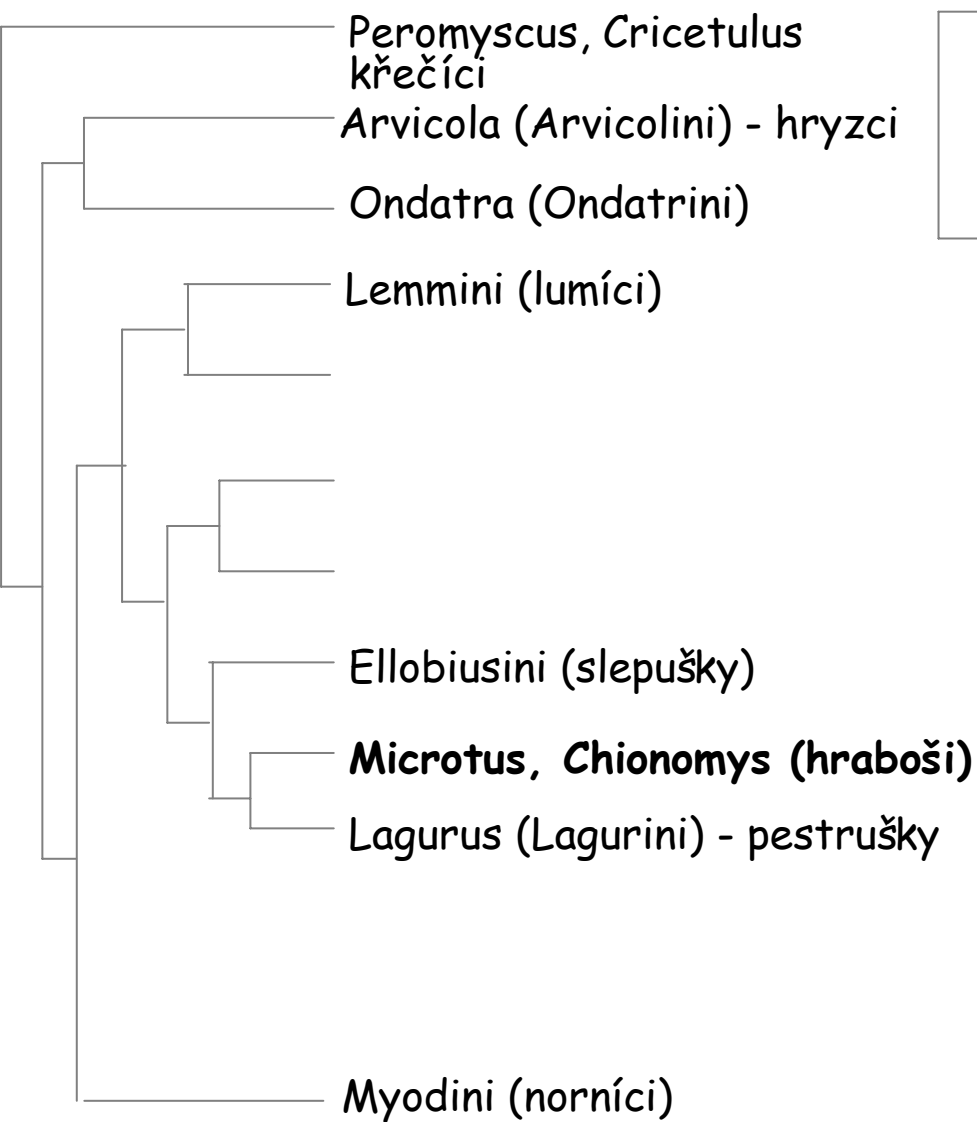



# Arvicolinae

voles, lemmings, muskrat



postorbital crest or process  
formed on squamosal



myomorphous, sciurognathous,  
key-hole shaped infraorbital

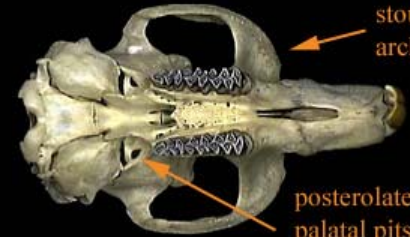

stout zygomatic  
arches and plate

posterolateral  
palatal pits

cheekteeth prismatic,  
hypsodont



# Murinae

Old World rats and mice



myomorphous, sciurognathous,  
key-hole shaped infraorbital



cheekteeth of most species  
have 3 distinct rows of cusps

