

System savců (Mammalia)

V. Eutheria, Placentalia: Euarchontoglires

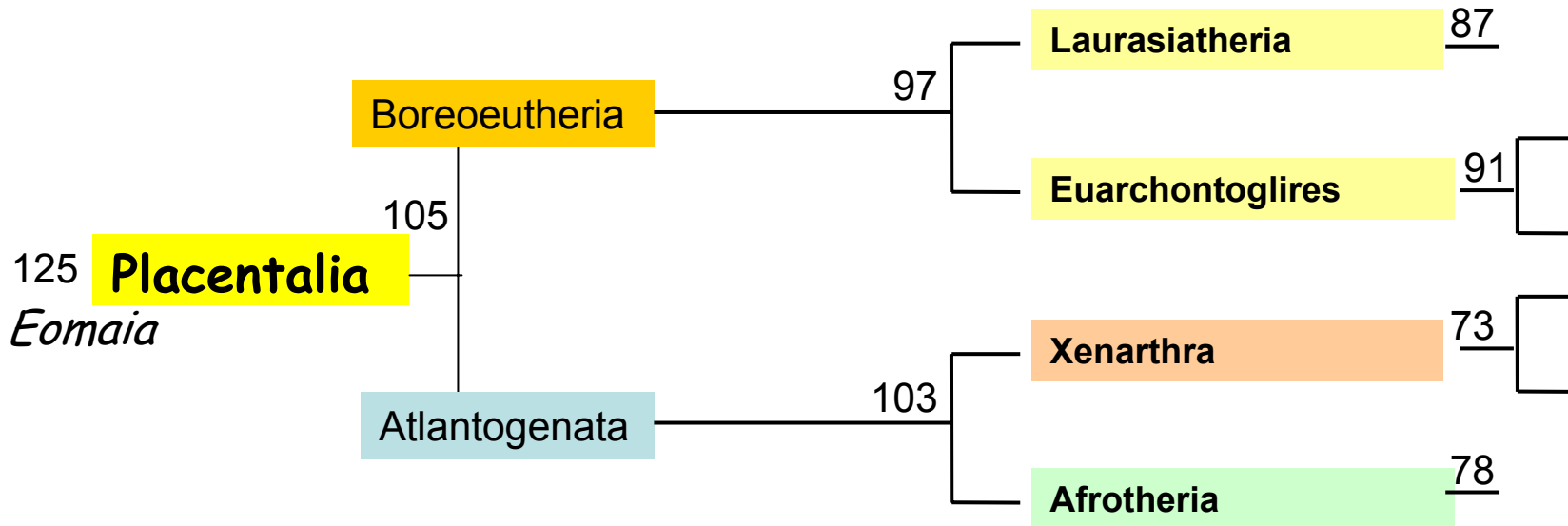

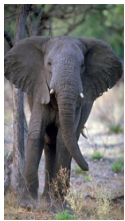
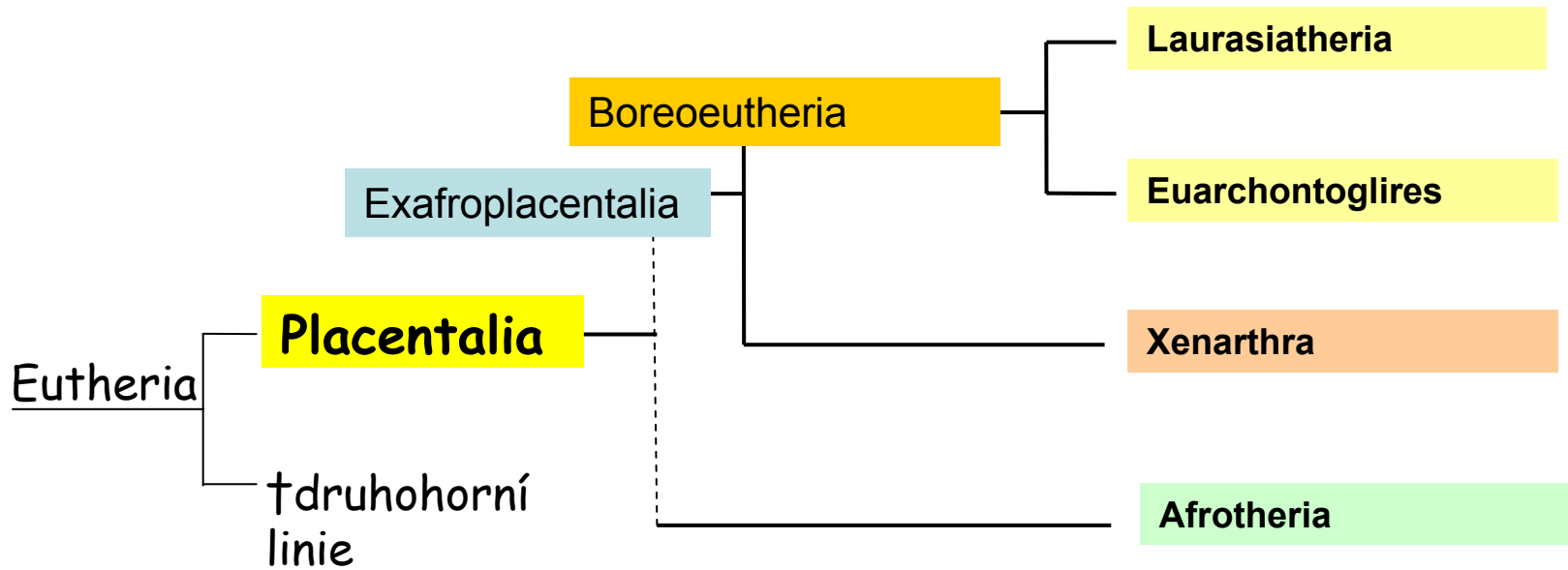

Euarchontoglires

Předkové v Asii před 85-90 mil. lety

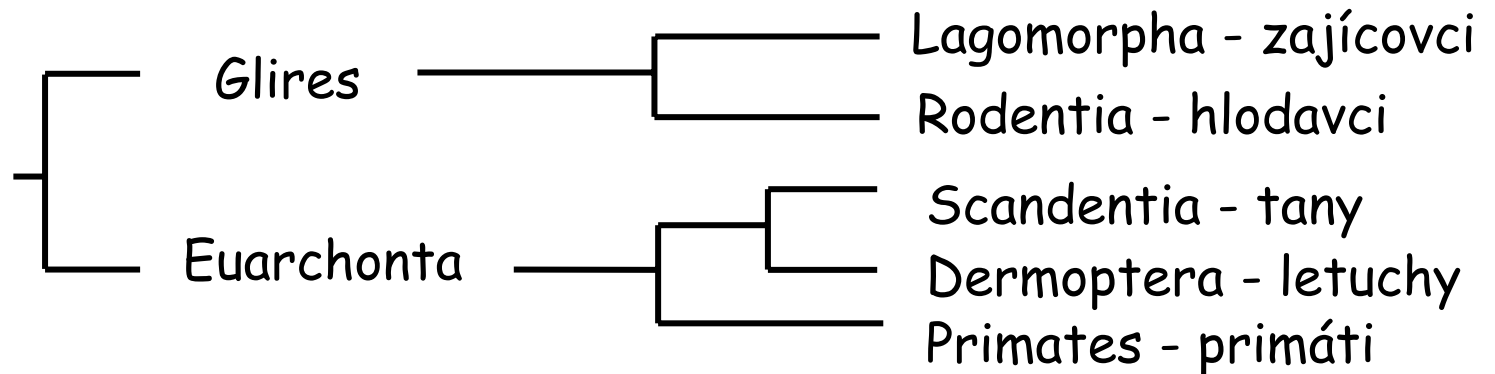

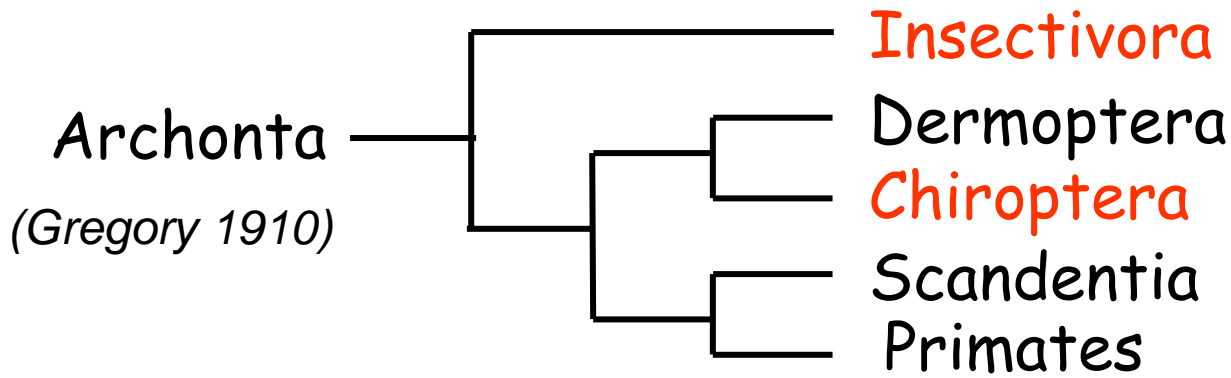

Archonta = Euarchonta + Insectivora + Chiroptera

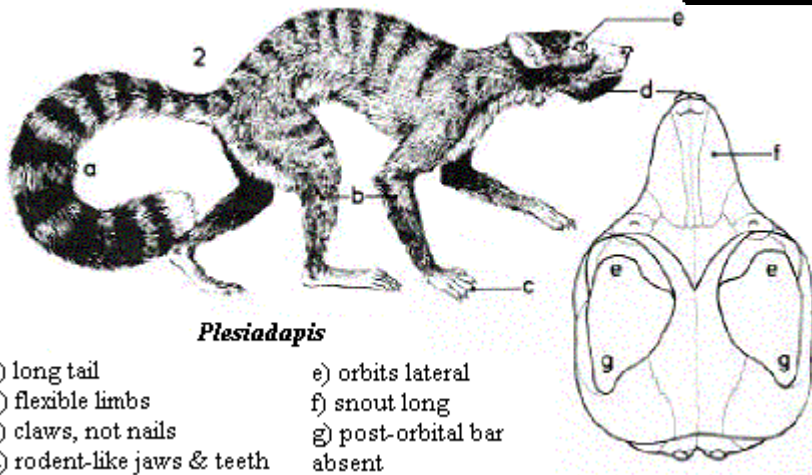
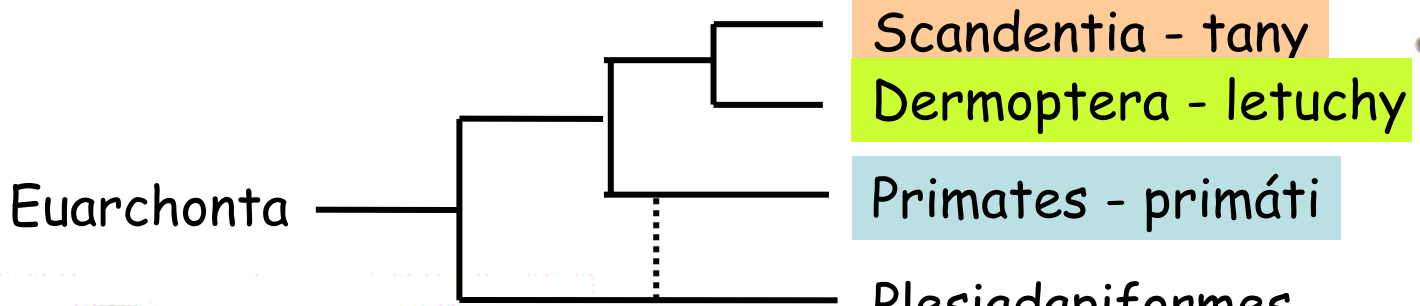

Plesiadapiformes
střední paleocén - 60 Mya
Evropa, SAM

terestrický předek → arborikolní (herbivorie)
(frugivorie, velké řezáky a diastema)

- a) long tail
- b) flexible limbs
- c) claws, not nails
- d) rodent-like jaws & teeth
- e) orbits lateral
- f) snout long
- g) post-orbital bar absent

Primates - primáti

Primates = první, nejvyšší (Karl Linné)

Primárně arborikolní s přechodem k denní aktivitě (barevné vidění), adaptace ke šplhání - palec v opozici, ohebné prsty často s nehty, volný ramenní kloub - clavícula; tendence k prostorovému vidění, „generalizování“ savci, úplný bunodontní chrup (2133), počet zubů 18-38, gyrencephální mozek, redukce čichu - zkracování viscerokrania a zesílení jařmového oblouku, uzavírání očnic, reprodukce - K-stratégové

Tropické lesy, 13 čeledí, 233 rec. druhů

Primates - primáti

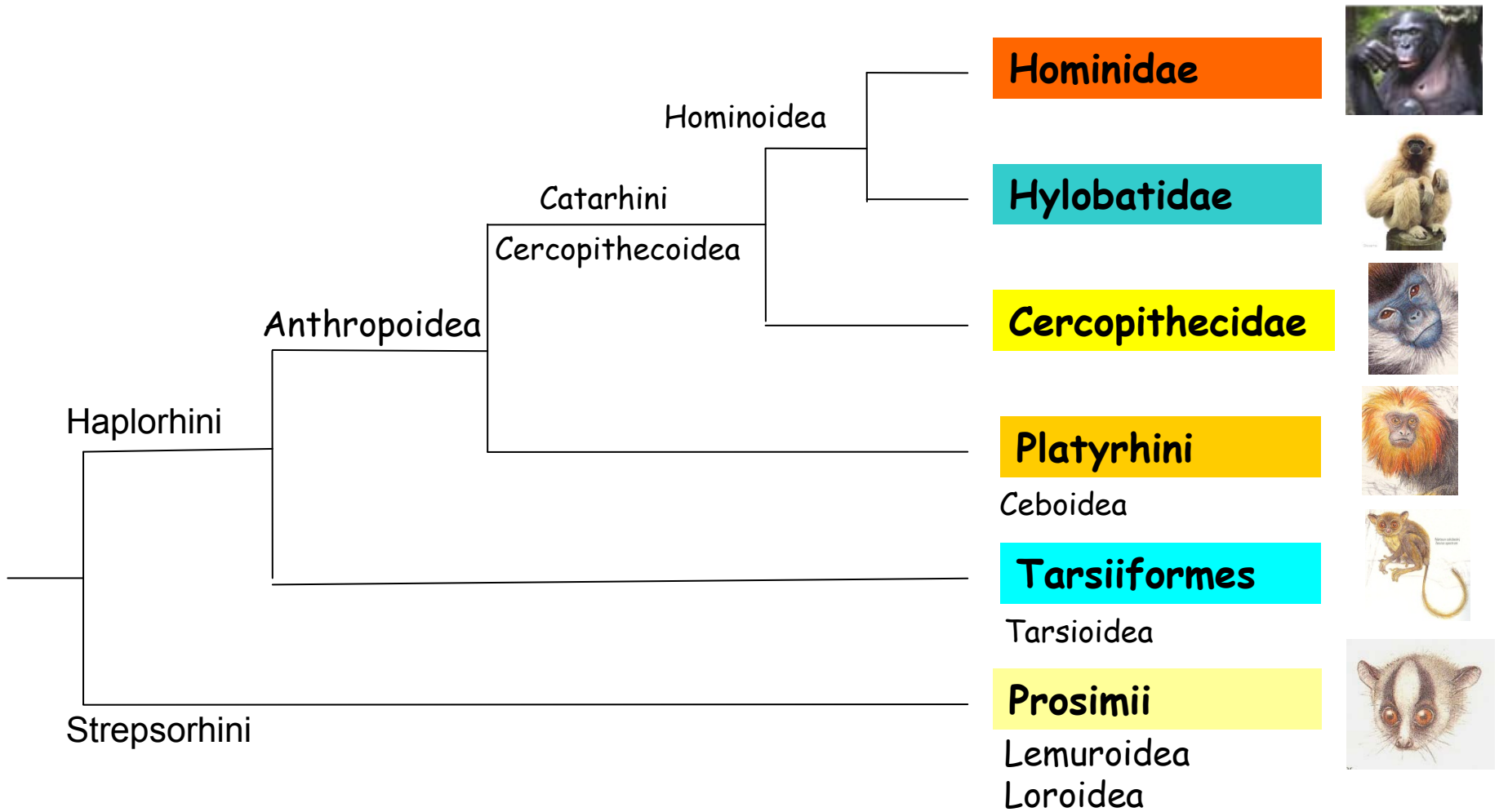

Strepsorhini - lemuři, rhinarium vyvinuto - stále vlhká, lysá kůže kolem nozder
Haplorhini - ostatní, redukované rhinarium

Primates

Haplorhini

Strepsirhini



relatively short rostrum



relatively long rostrum

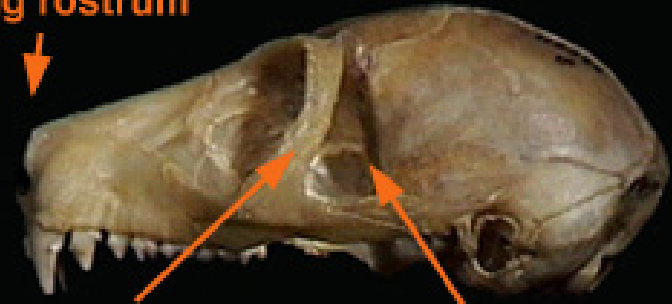

postorbital bar

temporal fossa

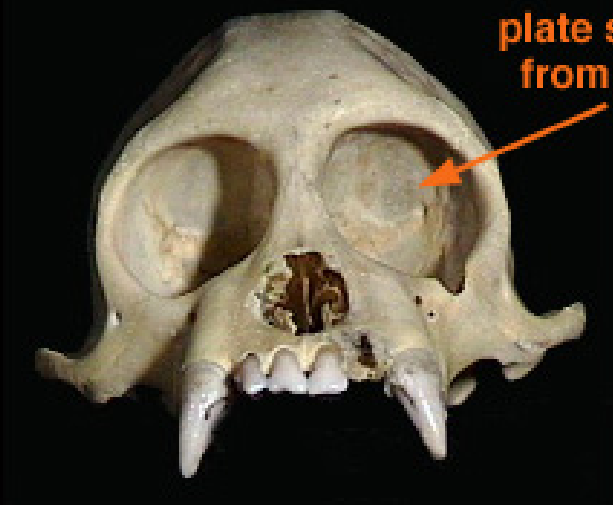
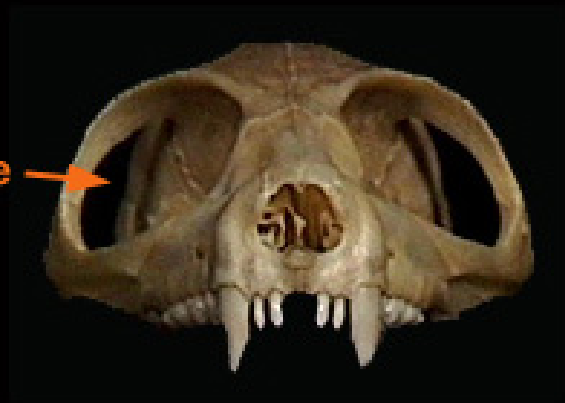

plate separating orbits from temporal fossa



no plate



Prosimii - poloopice

- prsty většinou s drápy, na palci vždy nehet, palec zadní končetiny chápavý, i srůstý prstů, hřebínek na drápku 2. prstu zadní končetiny
- velké oči - očnice ještě vzadu otevřené, převážně noční, malý mozek, zadní končetiny delší než přední, živí se hmyzem, nebo mlád'aty obratlovců, nebo býložraví
- krátká říje, 2-3 holá a slepá altriciální mlád'ata
- 7 čeledí, 88 druhů, subsaharská Afrika, Madagaskar, JV Asie

lemur kata *Lemur cata*



outloň *Nycticebus coucang*



Lemuroidea: jen Madagaskar, *lemuros* - lat. duchové zemřelých, duchové noci - světélkující oči, naříkavý pláč (indri - rezonanční vak na průdušnici - 2-3 km)

Cheirogaleidae - makiovití (trpasličí lemuři) - 15 (maki - *Cheirogaleus*, *Microcebus*, *Allocebus*), tuk v kořeni dlouhého ocásku, aestivace, 36 zubů, noční, vegetariáni.

Microcebus

maki



Microcebus lehilahytsara
Credit: The Hannover



lemur kata



lemur vari – pralesní forma



lemur vari červený
– pralesní forma z poloostrova
Masoala



Lemuridae - lemuři denní, 10 (*Lemur catta*, *Eulemur*, *Haplemur*, *Varecia variegata*), čištění srsti spodními řezáky a špičáky, 36 zubů, dráp jen na 2. prstu zadní nohy, jinak nehty, vegetariáni, i na Komorských ostrovech - introdukce

noční lemur - *Lepilemur*



Megaladapidae - **lemuři noční**, 23 (*Lepilemur*), jen 32
zubů, chybí horní řezáky

Daubentoniidae - ksukol ocasatý (aye-aye), *Daubentonia madagascariensis*, jen 18 zubů, **srostlé řezáky k hlodání** - skořápky ořechů, **vpředu dlouhý prostřední prst k vytahování dužniny** z bambusových stébel, ořechů ze skořápky, hmyzu ze dřeva, **noční**



ksukol



ksukol



„madagaskarská veverka“ -
srostlé řezáky v hlodavé zuby

Indriidae - indriovití 11 (Indri, Avahi, Propithecus - sifaka), největší, dlouhé zadní končetiny, tělo ve svislé pozici, chůze po dvou, mezi prsty blána, 30 zubů, denní (avahi - noční), vegetariáni.



Propithecus - sifaka

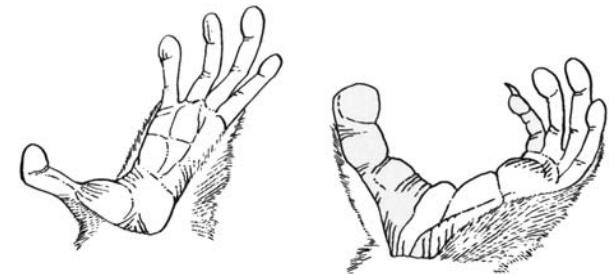
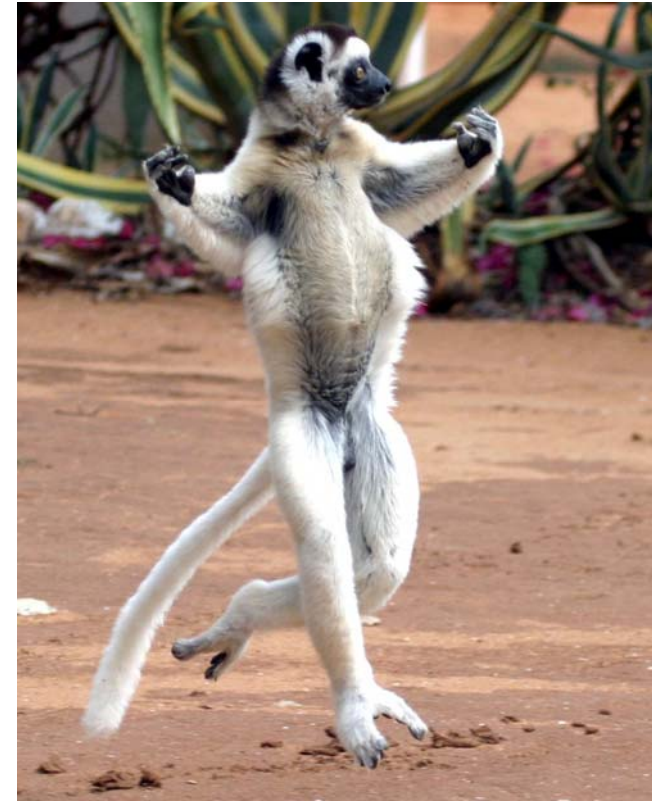

Indri indri - redukovaný ocas,
až 10 kg



Avahi laniger - avahi vlnatý - redukovaný ocas, do 1 kg, poplašný křik ava-hi, noční



Loroidea: Afrika, Indie, JV Asie

Lorisidae - outloňovití 6 (*Loris* - lori, *Nycticebus* - outloň, *Arctocebus* - poto, *Perodicticus* - poto), zavalití, kulatá hlava, malé boltce, velké oči, zakrnělý ocas, 2. přední prst zakrnělý, zadní s česacím drápem, ovoce i hmyz, **noční**, Indie, Cejlon (lori) a JV Asie, Indonézie, Borneo, Filipíny (outloň), Afrika (poto)

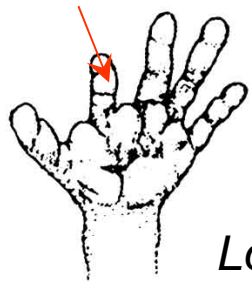

Loris

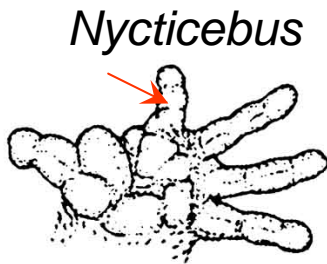

Nycticebus

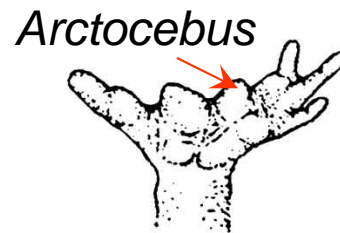

Arctocebus

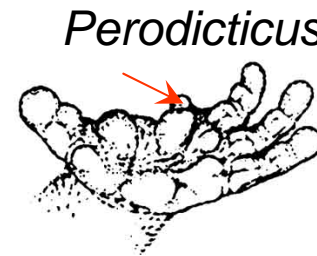

Perodicticus

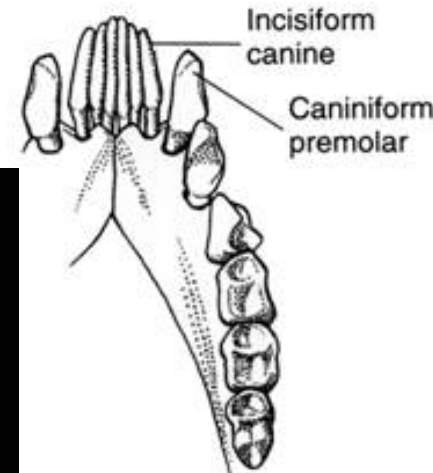

Nycticebus - outloň



Galagonidae - kombovití 12 (*Galago*, *Galagoides*, *Euoticus*, *Otolemus*),
Afrika, 36 zubů, velké boltce, děti buše, dlouhé nohy, chytání
létajícího hmyzu, dlouhý ocas - kormidlo při skoku, vedle hmyzu se žíví
pryskyřicí a mízou stromů, prekociální mlád'ata, aktivita soumráčná až
noční *Galago senegalensis* - komba ušatá



Tarsioidea - nártouni (7)

Pokročilá stavba mozku, JV Asie, noční - velké oči, velká hlava, malý trup, dlouhý ocas, na prstech paličkovité přísavky, dlouhé nártý (tarsalia), loví skokem hmyz a drobné obratlovce

Tarsiidae - nártounovití (*Tarsius*)

Oči těžší než mozek,
dlouhý tenký ocas



Anthropoidea - vyšší primáti

zkrácený obličej, **oči ve frontální rovině s uzavřenými očnicemi**, dokonalý zrak, velký gyrifikovaný mozek, denní aktivita (vyjma JAm mirikina), převážně býložraví (plody), kosman zakrslý - gorila

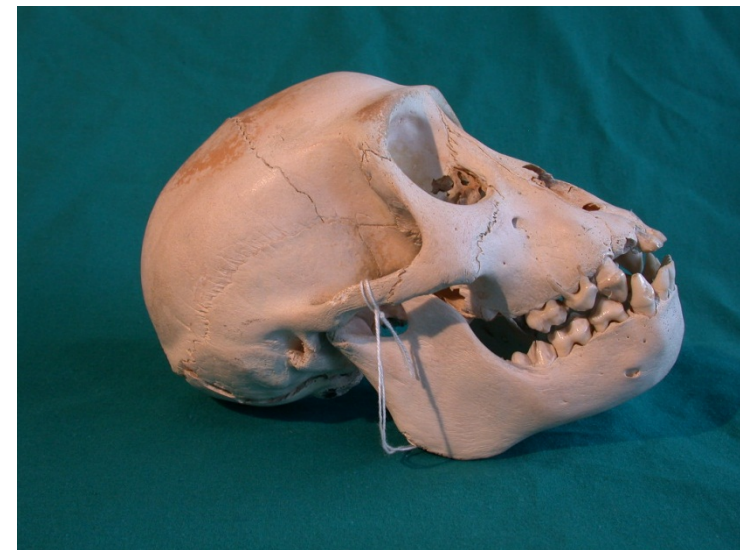
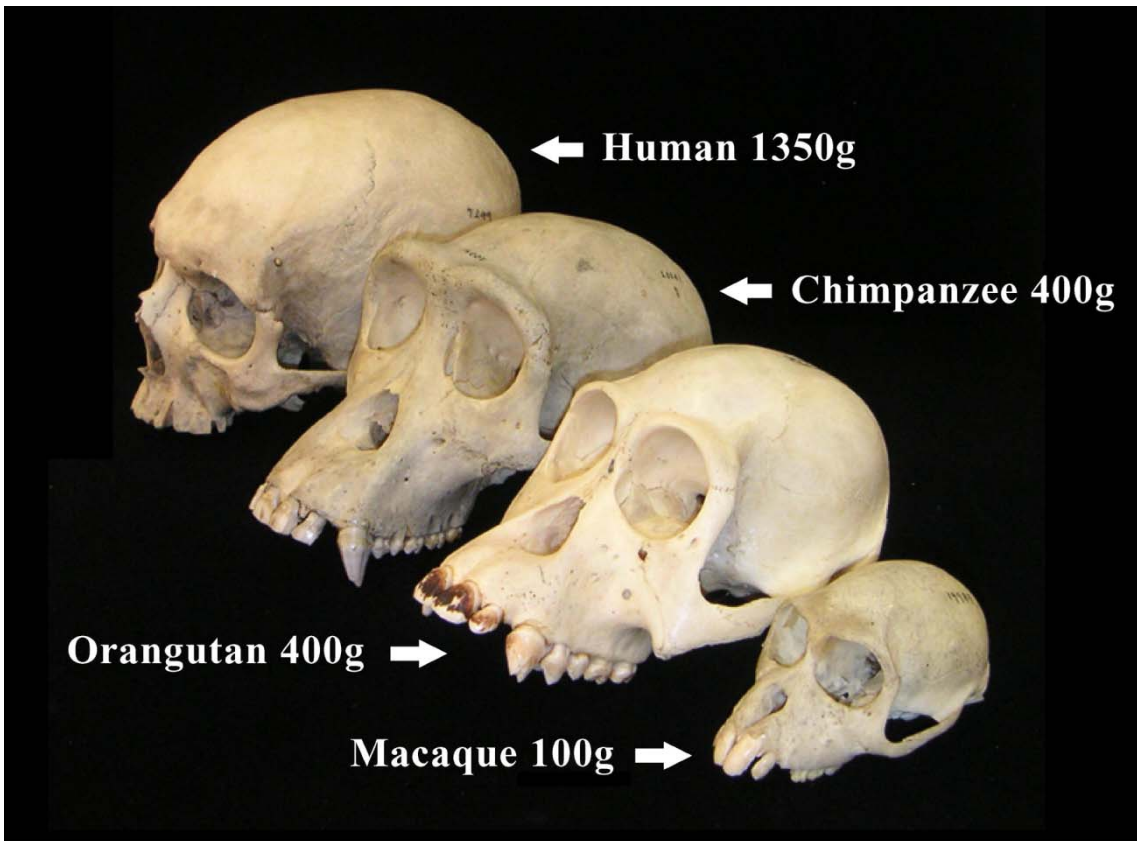

Platyrrhini (Ceboidea) - ploskonosí, opice N. světa (4 čeledi, 128 druhů), drápkaté opice

Široká mezinosní přepážka, **ectotympanicum** - tenký prstenec, JAm

PLATYRRHINES

Zygomatic-Parietal Contact

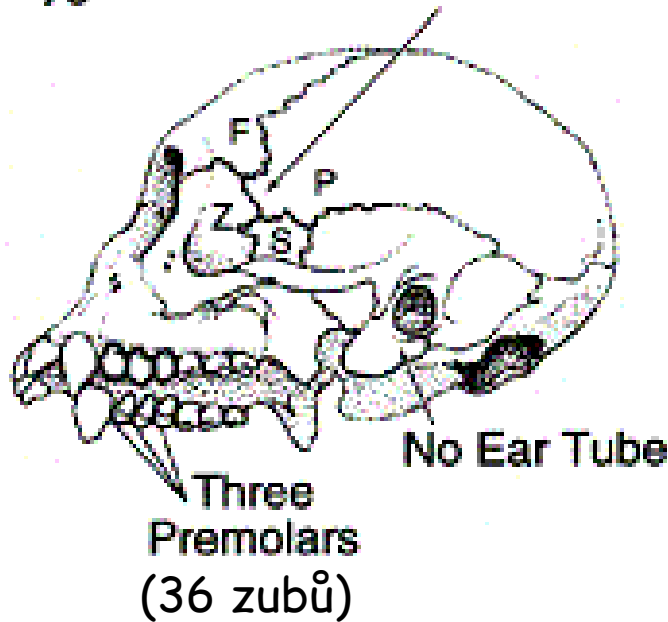

Z-P kontakt

CATARRHINES

Frontal-Sphenoid Contact

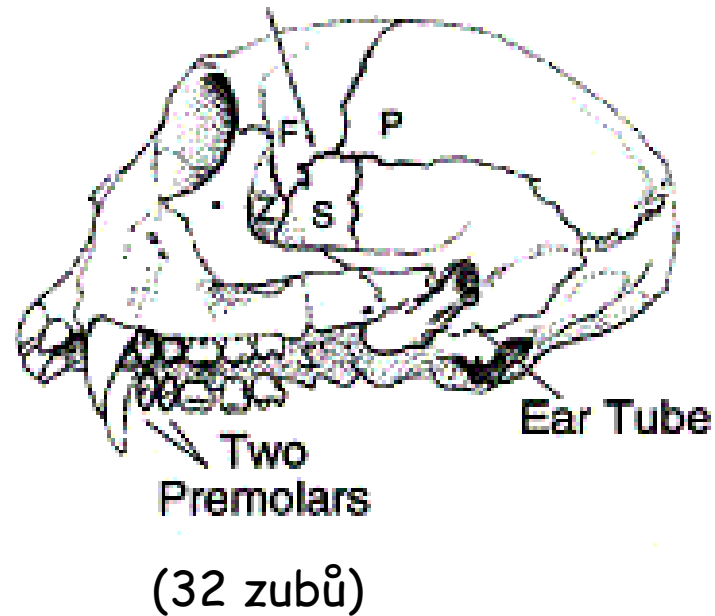

F-S kontakt

Callithricidae - kosmanovití (26), většina prstů s drápkou, primitivní, hladké hemisféry, nechápavý ocas delší než tělo, bledě modré malé oči, osrstěné boltce

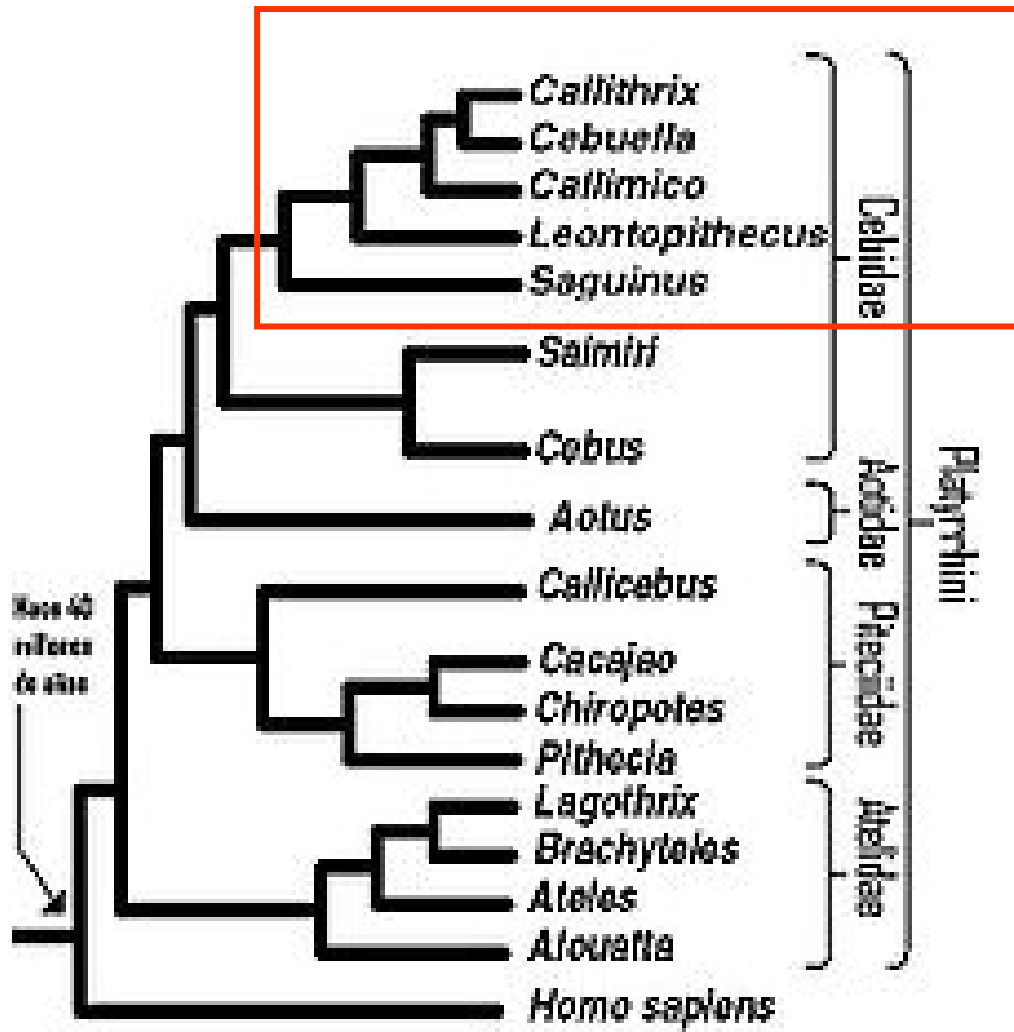

Callos = řec. krásný

kosman, kalimiko,
lvíček.
tamarín



kosman bělovousý *Callithrix jacchus*



kosman zakrslý *Cebuella pygmaea*



lvíček zlatý *Leontopithecus rosalia*



tamarín žlutoruký *Sanguinus*



tamarín pinčů

Cebidae - malpovití (58), tropické pralesy JAm, noční mirikiny (i sam. čeled' - Aotidae), malpy s chápavým ocasem, kotulové (Cebidae s.s.), chvostani, titiové a uakari (i sam. čeled' - Pitheciidae), neosrstěný boltec

Atelidae - chápanovití, chápavý ocas, brachiátoři

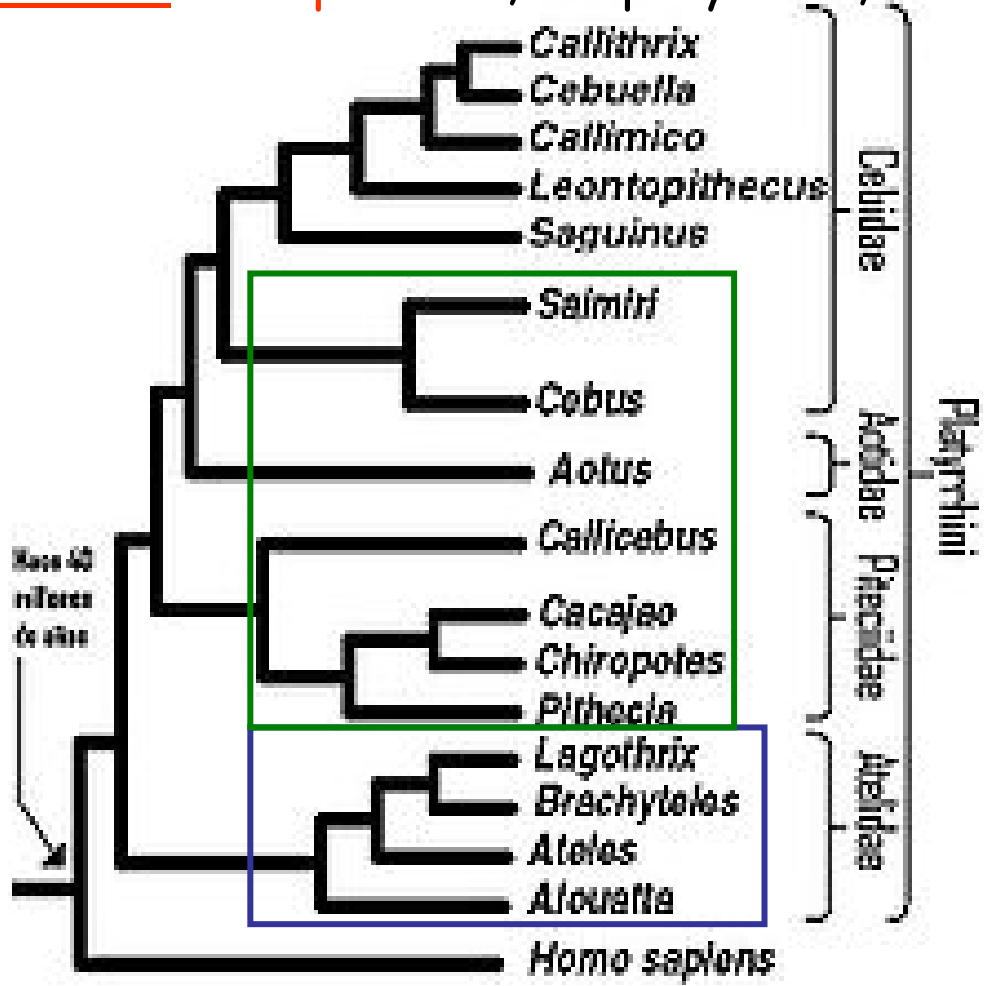

kotul
malpa
mirikina
titi
uakari
chvostan
chvostan



chápan
chápan
chápan
vřešť'an

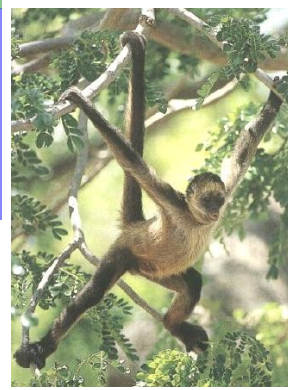

Catarrhini (Cercopithecoidea) - úzkonocí, opice St. světa
úzká nosní přepážka, ectotympanicum - dlouhá trubice, Afr., Asie, zubní
vzorec (2123), ocas není chápavý, sedací hrboly, palce v opozici, na ruce
i redukován, jen nehty, samice mají menstruační cyklus

Cercopithecidae - kočkodanovití (130), klenutá lebka, hulmani (As),
guerézy (Afr), makakové (As), paviáni (V Afr, PŘAs), kočkodani (Afr)



hulman
posvátný

gueréza
plášťiková



makak
rhesus



mandril

kahau



kočkodan husarský

pavián plášťikový



Hominoidea

Z úzkonosých opic, velcí s dorzoventrálně zploštělým hrudníkem, prodloužené přední končetiny, brachiace, ztráta ocasu, malé nebo bez sedacích hrbolů, dryopitékový vzorec stoliček (Y), dlouhá gravidita, 1 mládě; Hylobatidae (giboni, 14)) a Hominidae (lidoopi a lidé)

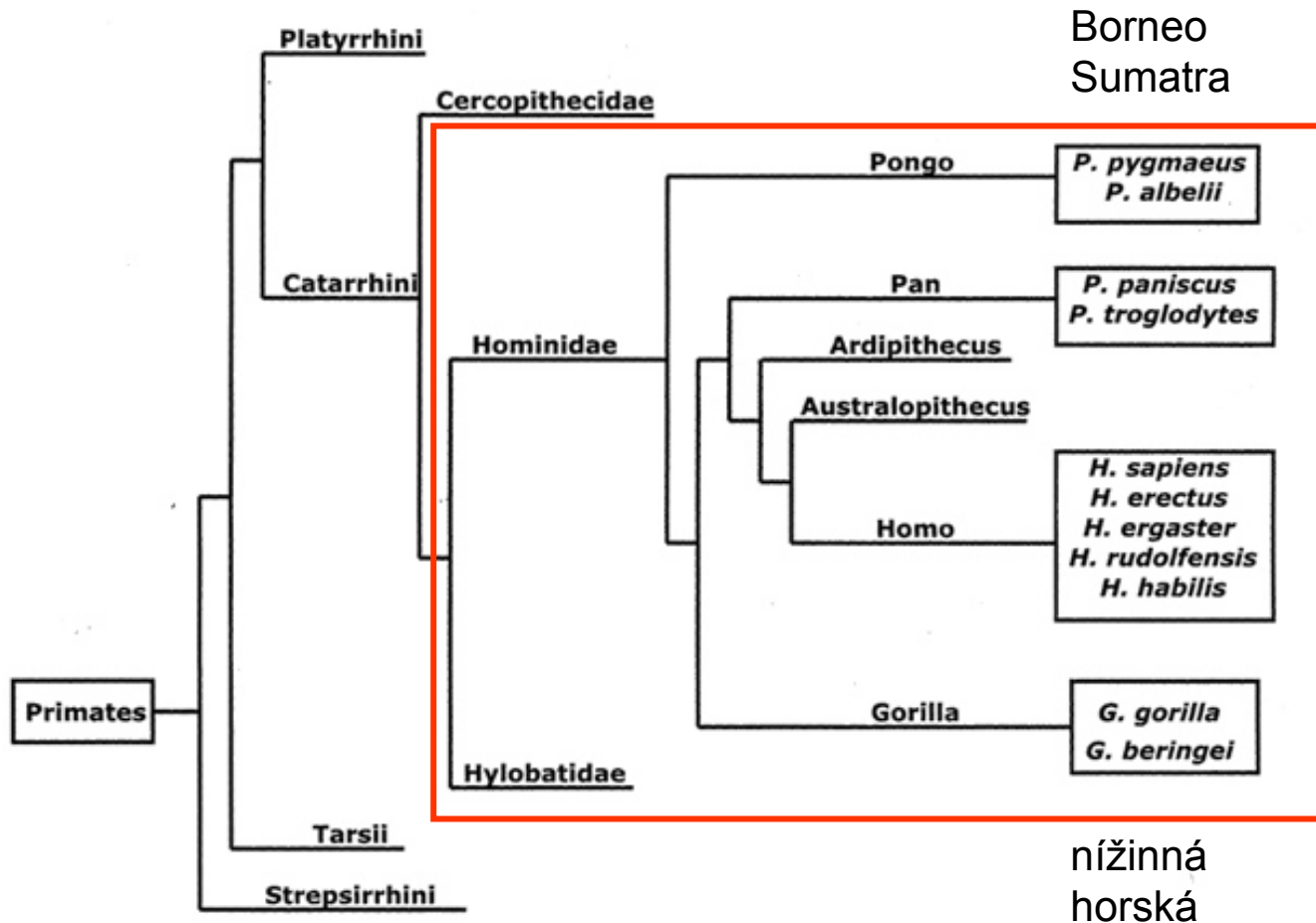

A New Kind of Ancestor: *Ardipithecus* Unveiled

The oldest known hominin skeleton reveals the body plan of our very early ancestors and the upright origins of humankind

Every day, scientists add new pages to the story of human evolution by deciphering clues to our past in everything from the DNA in our genes to the bones and artifacts of thousands of our ancestors. But perhaps once each generation, a spectacular fossil reveals a whole chapter of our prehistory all at once. In 1974, it was the famous 3.2-million-year-old skeleton “Lucy,” who proved in one stroke that our ancestors walked upright before they evolved big brains.

Ever since Lucy’s discovery, researchers have wondered what came before her. Did the earliest members of the human family walk upright like Lucy or on their knuckles like chimpanzees and gorillas? Did they swing through the trees or venture into open grasslands? Researchers have had only partial, fleeting glimpses of Lucy’s own ancestors—the earliest hominins, members of the group that includes humans and our ancestors (and are sometimes called hominids). Now, in a special section beginning on page 60 and online, a multidisciplinary international team presents the oldest known skeleton of a potential human ancestor, 4.4-million-year-old *Ardipithecus ramidus* from Aramis, Ethiopia.

This remarkably rare skeleton is not the oldest putative hominin, but it is by far the most complete of the earliest specimens. It includes most of the skull and teeth, as well as the pelvis, hands, and feet—parts that the authors say reveal an “intermediate” form of upright walking, consid-

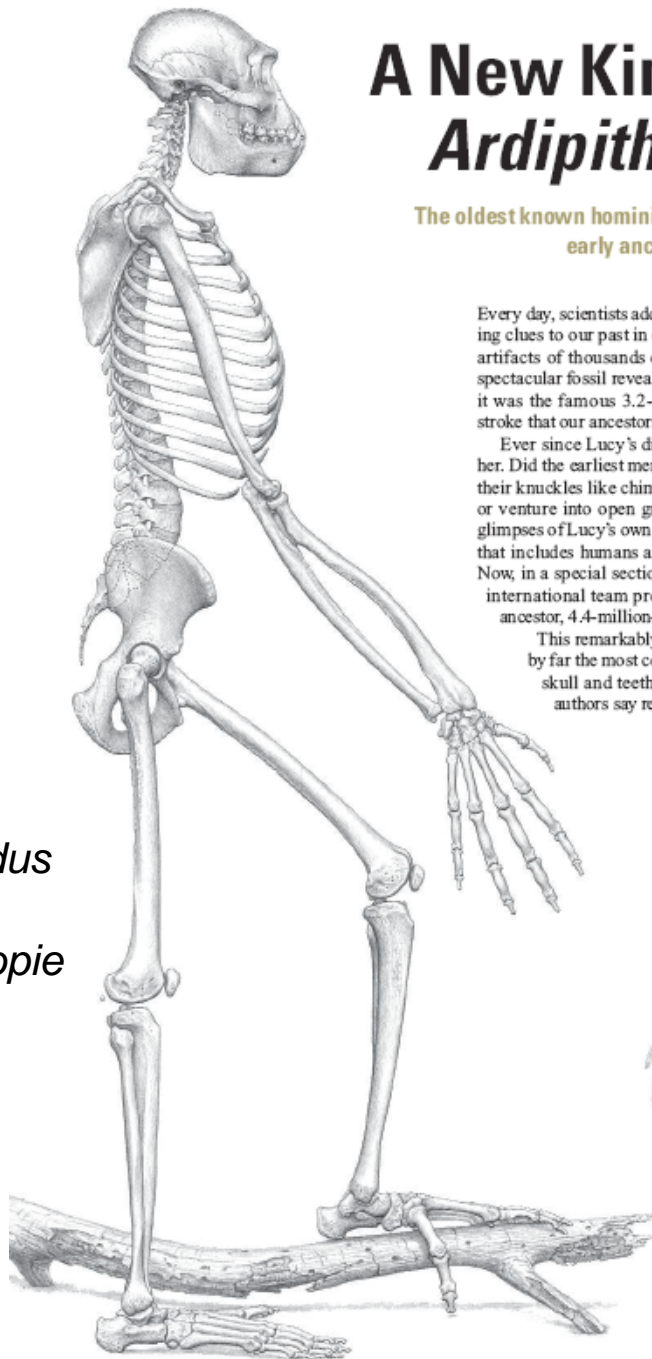

Ardipithecus ramidus

Arammis – V – Etiope
2009

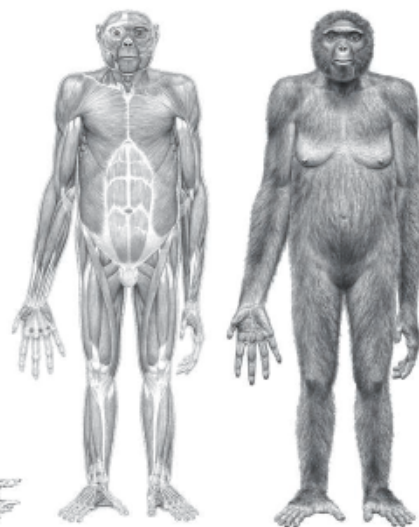

From the inside out. Artist’s reconstructions show how Ard’s skeleton, muscles, and body looked and how she would have moved on top of branches.

Hylobatidae - stromoví brachiátoři, po zemi bipedně



Gibon běloruký - lar

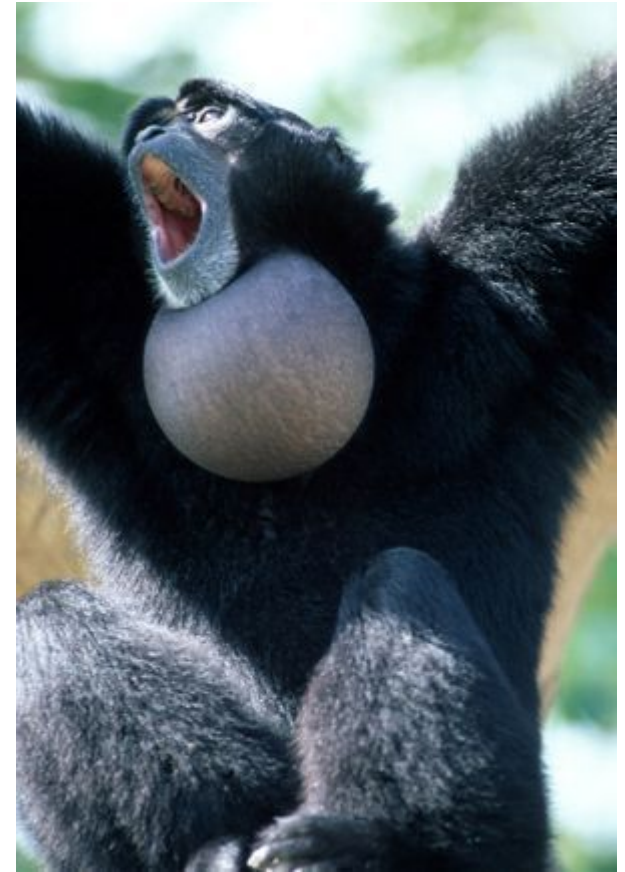

siamang



Hominidae

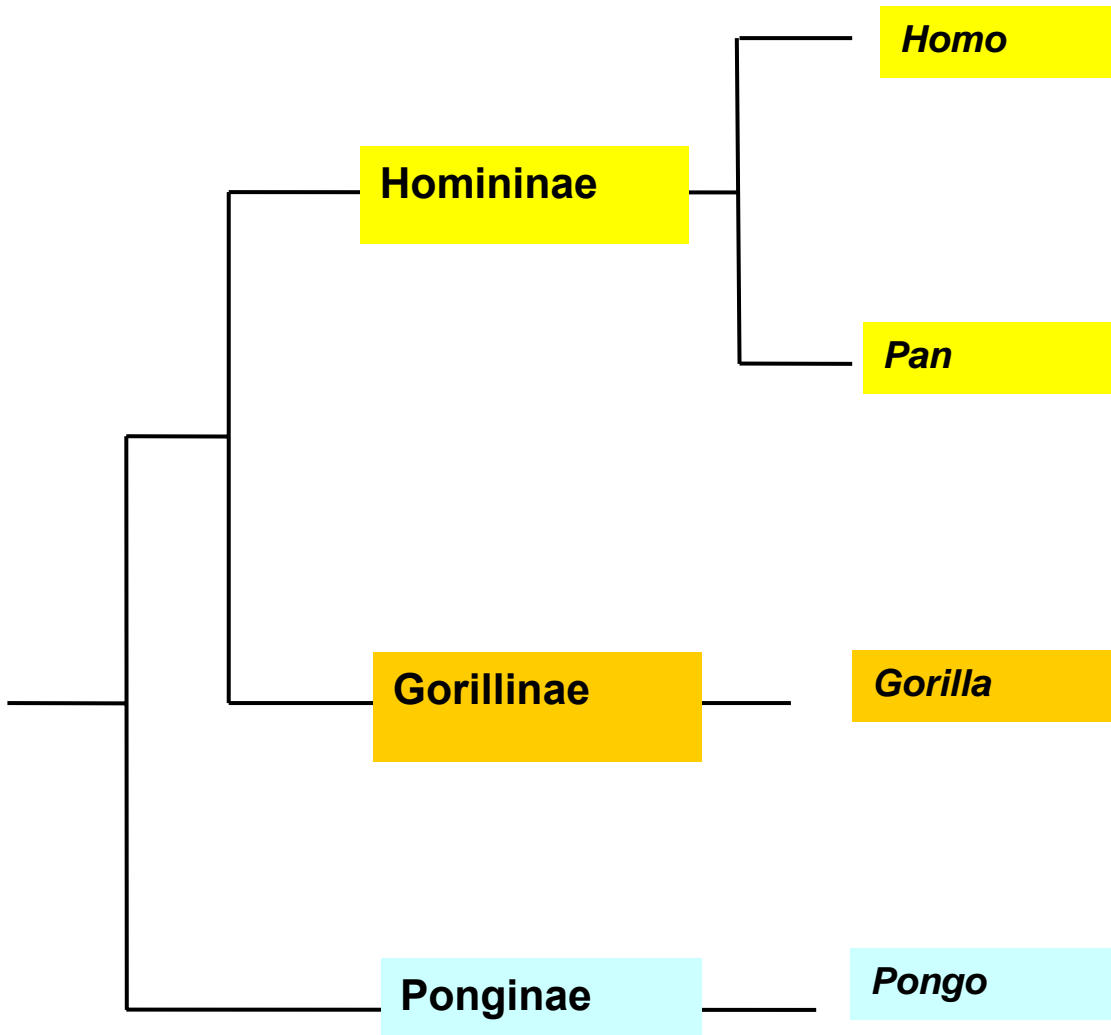

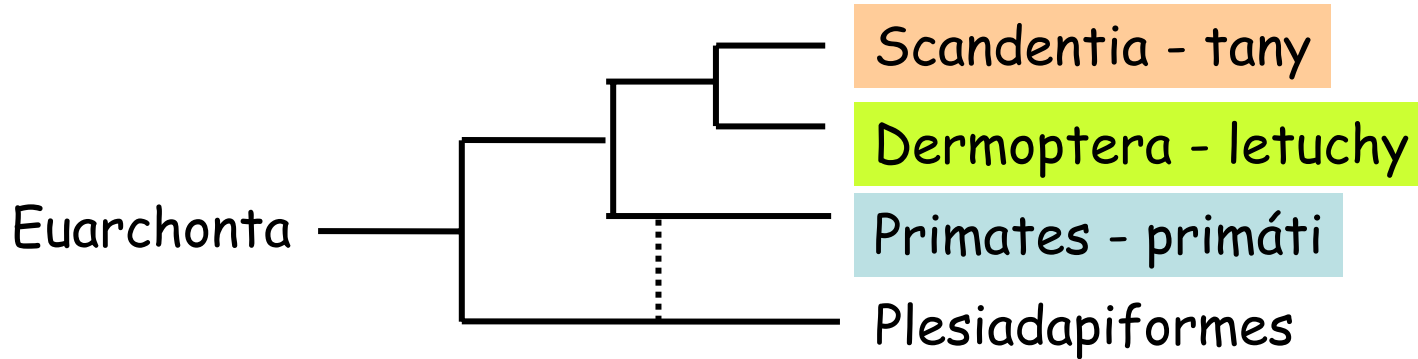

Dermoptera - letuchy

- osrstěný kožní lem - pasivní klouzavý let (flying lemurs), přes 130 m, **stromoví**, soumravná aktivita, velké dopředu směřující oči - stereoskopické vidění, býložraví - úplný chrup, **hřebenité spodní řezáky** (až 20 hrotů) i k čištění srsti,
- velký žaludek a dlouhé stočené tlusté střevo s mikroorganismy trávicími celulózu, velikost kočky (*Cynocephalus volans*, *C. variegatus*)
- l. filipínská, l. malajská)

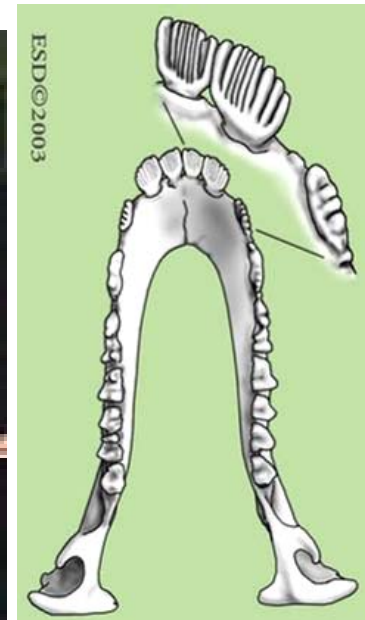



Scandentia - tany

- protažený čenich, nápadné boltce, **dilambdodontní chrup**
- JV Asie, stromoví, podobní veverkám („tupaia“), dlouhý osrstěný ocas, lov předními tlapkami, insektivorní, velká mozkovna, uzavřené očné (jako primáti), protáhý lysý čenich jako rejsek (tree shrews), dilambdodontní stoličky (W), sublingua, dlouhé pětiprsté končetiny, pohyblivé boltce, úplný chrup (38 zubů, I2/3, C1/1, P3/3, M3/3), velké horní řezáky, malé špičáky, široké stoličky, **denní aktivita**, již na konci křídly
- t. obecná (*Tupaia glis*), t. péroocasá (*Ptilocercus lowii*)

1 čeleď, 20 druhů
Tanovití (Tupaidae)



Glires

Lagomorpha - zajícovci

Rodentia - hlodavci

Glires

Býložraví s hlodavými zuby, bez špičáků; s diastemou, charakteristické žvýkací svaly, palearktický původ

Lagomorpha - zajícovci (80-92)

řec. *Lagos* = zajíc, paleocén - *Eurymylus* - VAs

- v horní čelisti **2 páry řezáků**, I² - hlodák - na celém povrchu sklovina; za ním drobný I³; lofodontní stoličky s vysokými korunkami (hypsodontní), **svalový výběžek nevyvinut**, býložravci
- **cekotrofie**
- kulovitý čelistní kloub
- ploskochodci s osrstěnou spodinou tlapek, redukovaná clavicula
- u samců scrotum před penisem, bez bakula

Pišťuchovití (Ochotonidae, 26) eocén

- velehory Asie a SAm, krátké boltce, zakrnělý ocas

Zajícovití (Leporidae, 54-58) paleocén

- pozemní, hrabou nory, prodloužené boltce a zadní nohy, rozeklané pysky, slepé střevo 10x větší než žaludek, krátký ocas, *Lepus* (28)

Lagomorpha

Rodentia

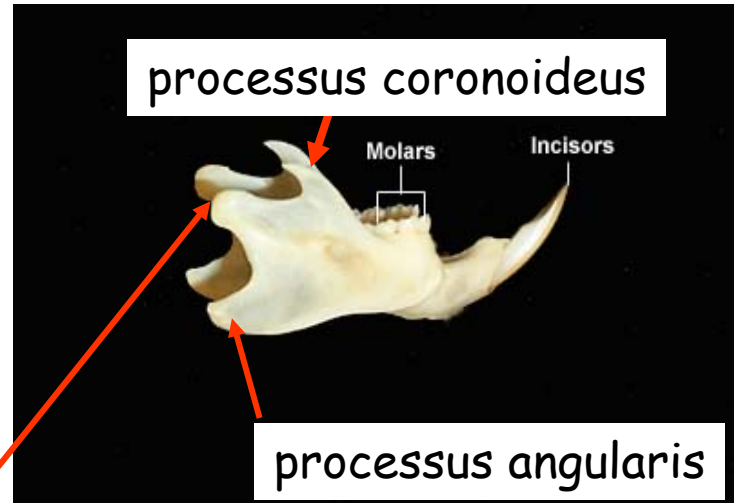
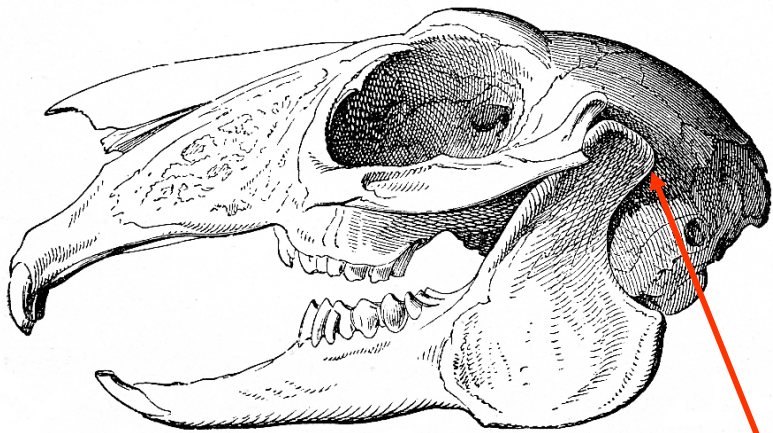

processus articularis

Ochotonidae

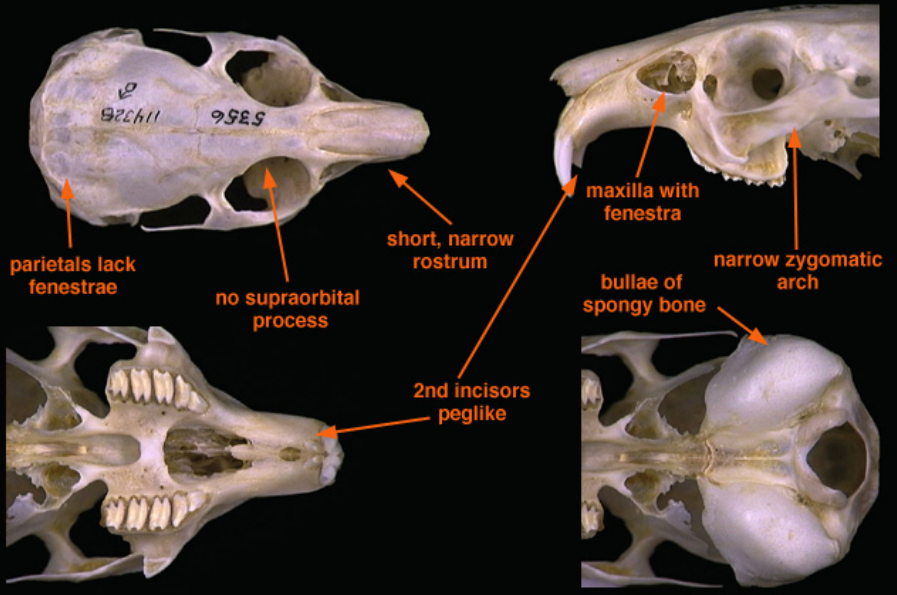

Ochotona princeps



Lagomorpha Leporidae

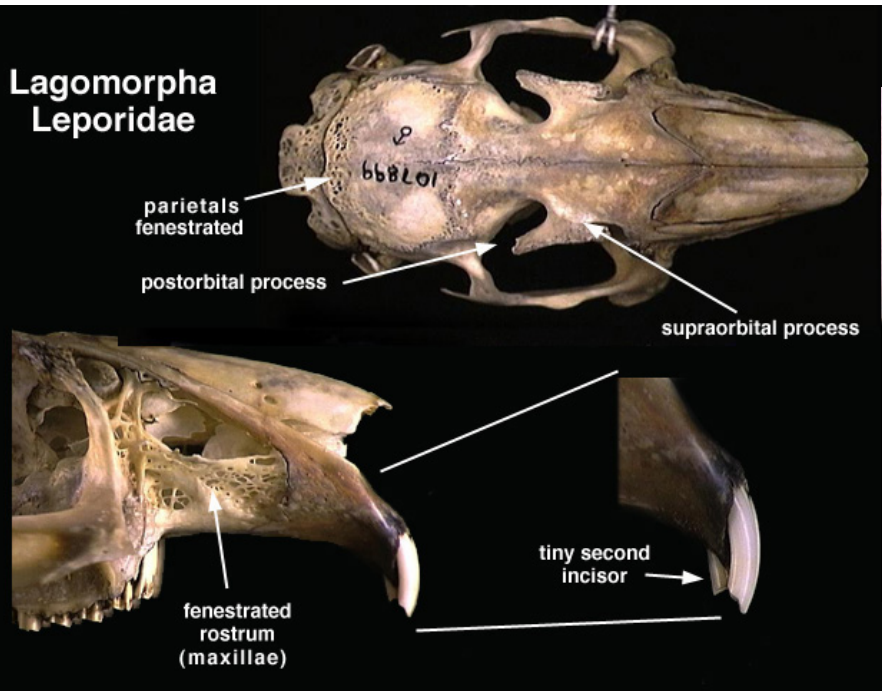

Oryctolagus cuniculus

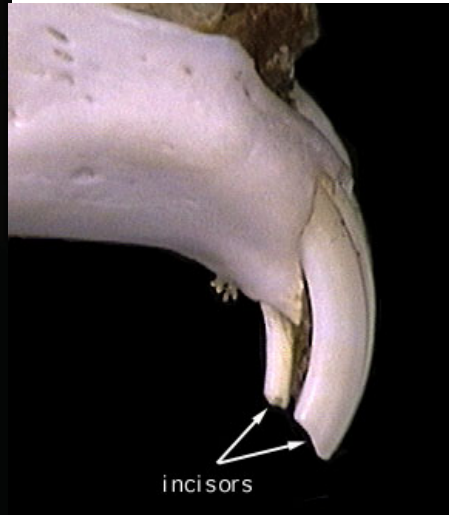

Lepus europaeus



Lepus europaeus

Oryctolagus cuniculus

zajíc



králík



Rodentia - hlodavci (2277 druhů, u nás 26)

- známí z počátku třetihor, ale podle molekulárních hodin již před 100-94 mil. lety; pozdní paleocén, myšovití až koncem třetihor - rychlá evoluce
- krátká gravidita, početné vrhy, mláďata altriciální, i prekociální (JAm)
- diprotodontní chrup - jen s **jedním párem hlodáků** v každé čelisti, sklovina jen zepředu, diastema, na mandibule zřetelný p. **angularis**
- I1/1, C0/0, P2/1, M3/3 = 22, ztráta P = 16, rypoš stříbřitý 28 zubů

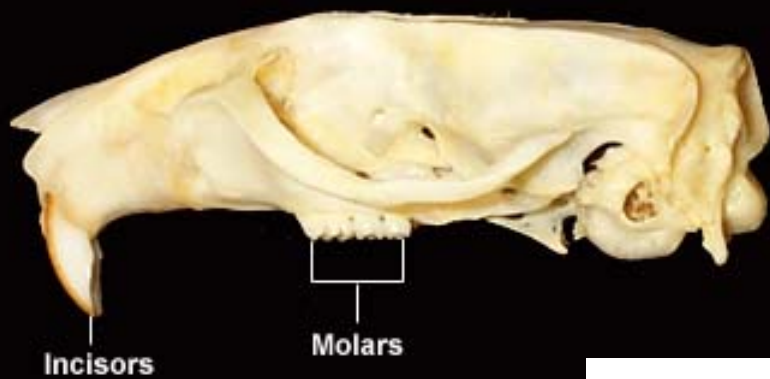

processus coronoideus

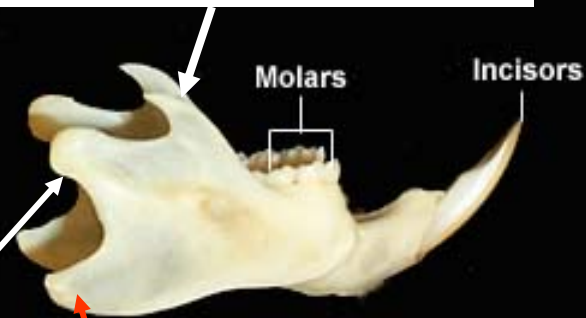

processus articularis

processus angularis

diferenciace m. **masseter** - systematický znak (Brandt 1885)

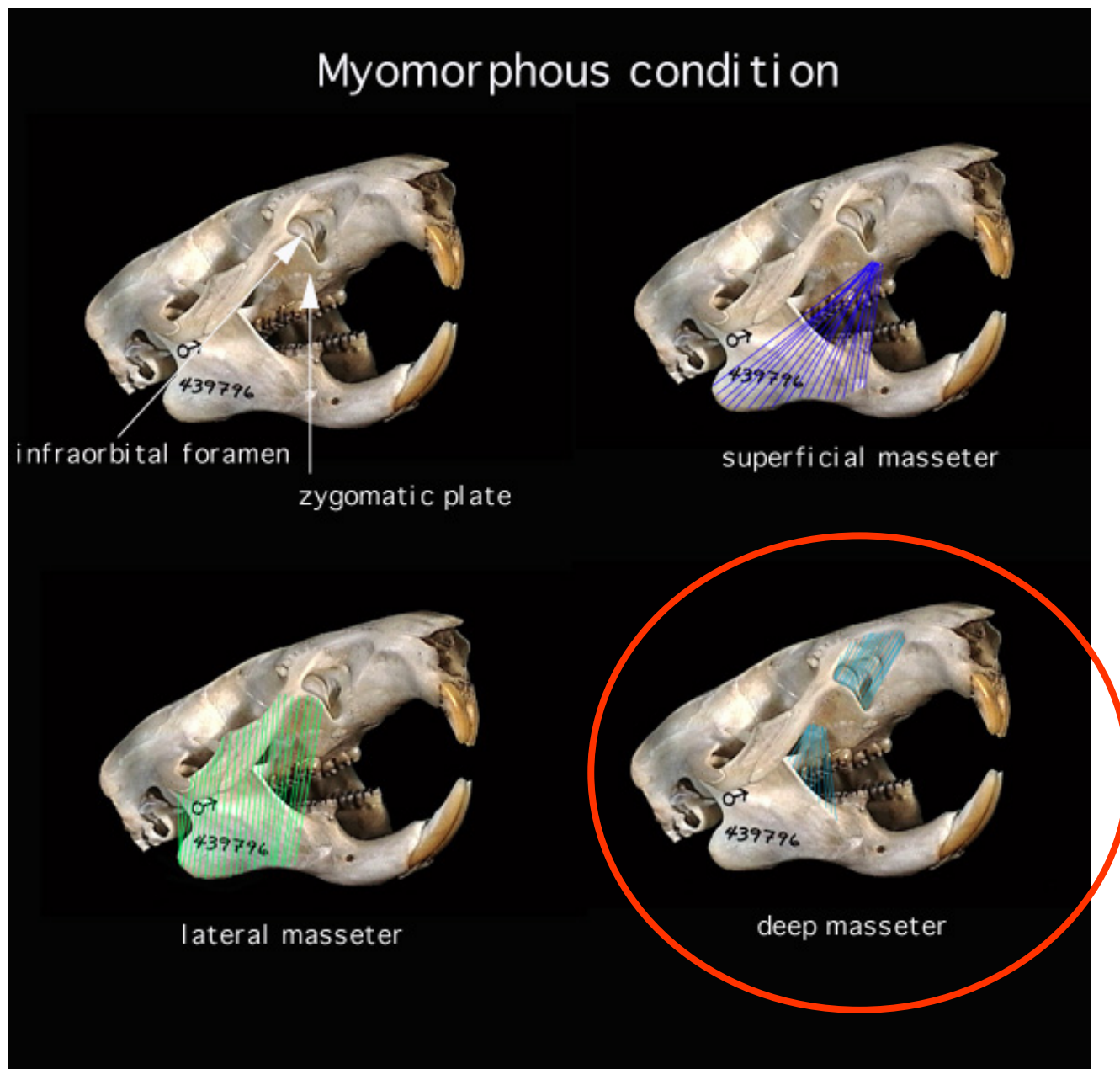

Medial masseter

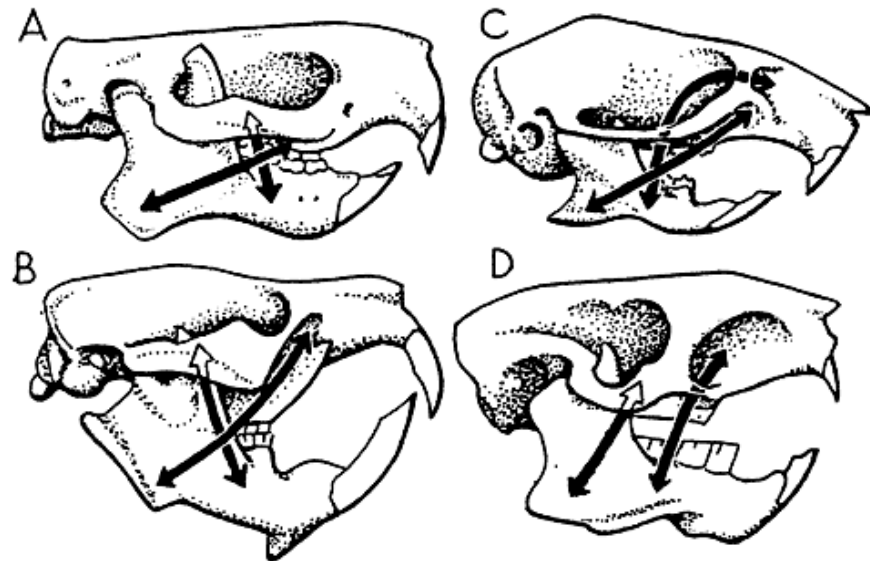
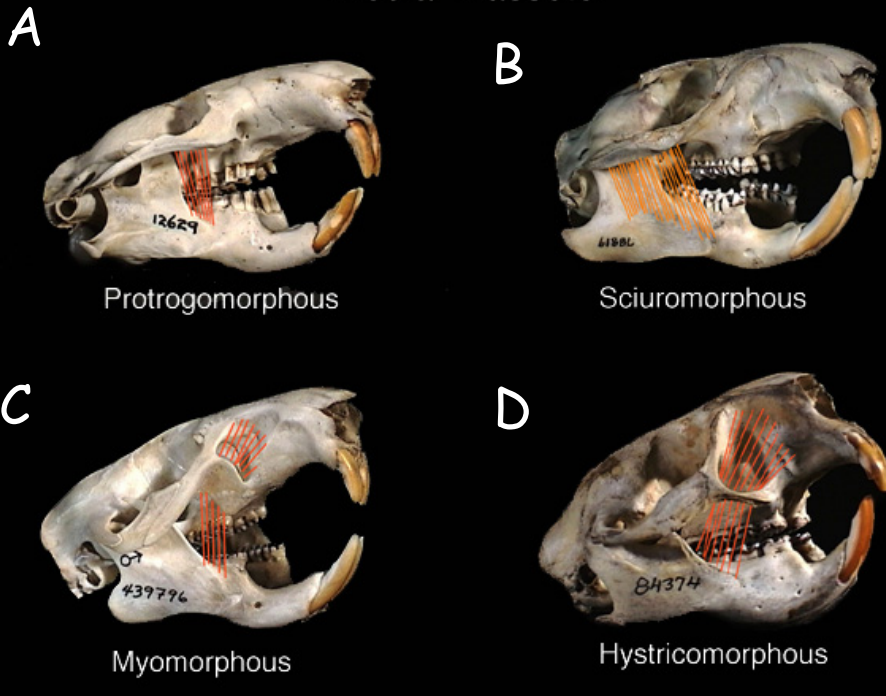

- **protrogomorfní** (bobruškovití - SAm, rypoši - Af), **m.m. na ventrální povrch jařma**
- **sciuiromorfní** (veverkovití, bobrovití - Spol, pytlonošovití, pytloušovití - SAm), **2 větve m.m. na jařmo, 1 laterální větve podél jařma na rostrum**
- **myomorfní** (myšovití, plchovití) - **1 laterální větve m.m. pod jařmem na rostrum**
- **hystrikomorfní** = kaviomorfní (šupinatky - Af, tarbíci - Af, As, gundiové - Af, dikobrazovití - Af, JAs, paky a agutiové - JAm, morčata, nutrie), **střední větve mm. pod jařmem na rostrum skrz rozšířený infraorbitální otvor, laterální větve na jařmo**

Sciurognathous jaws

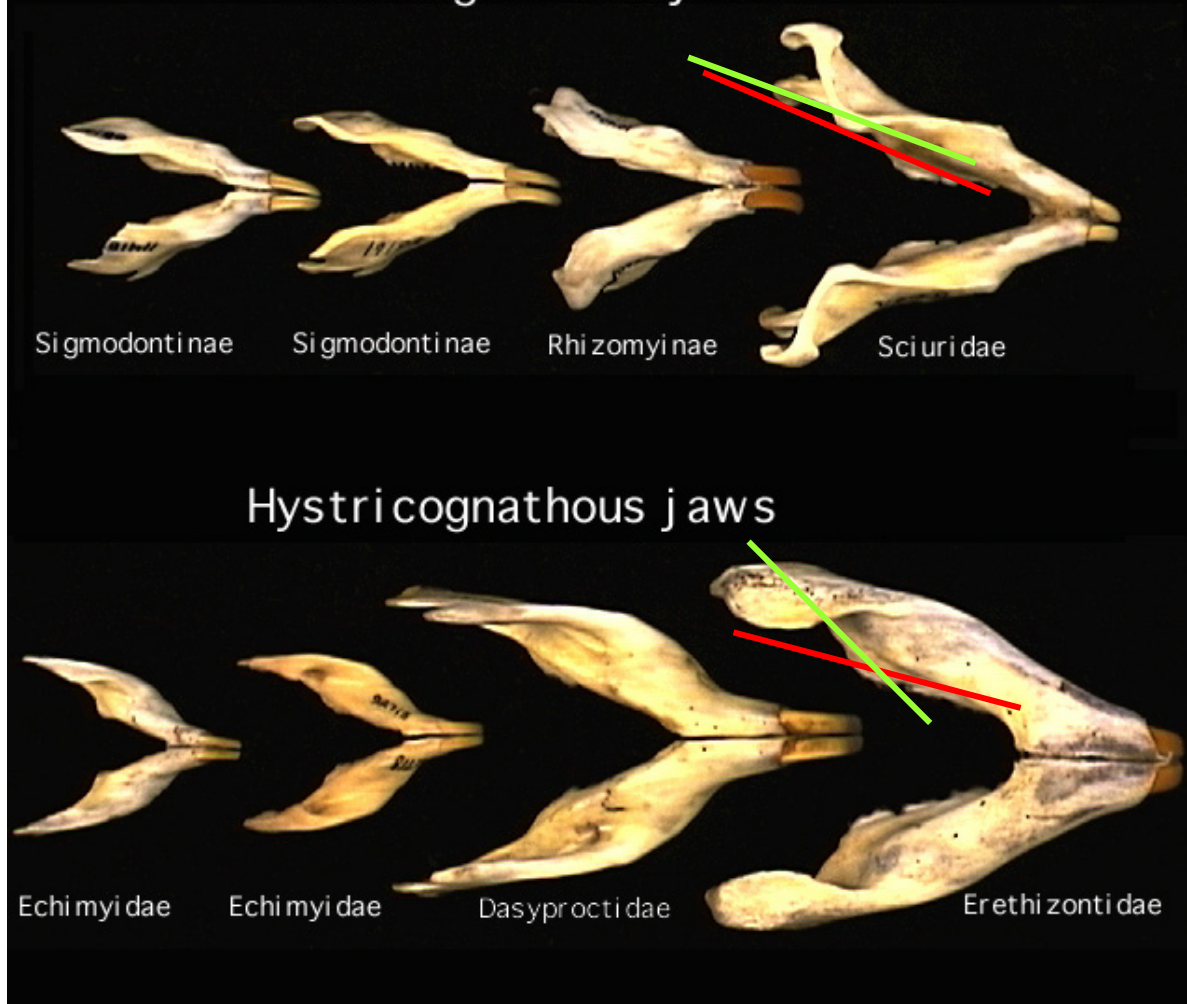

Hystriognathous jaws

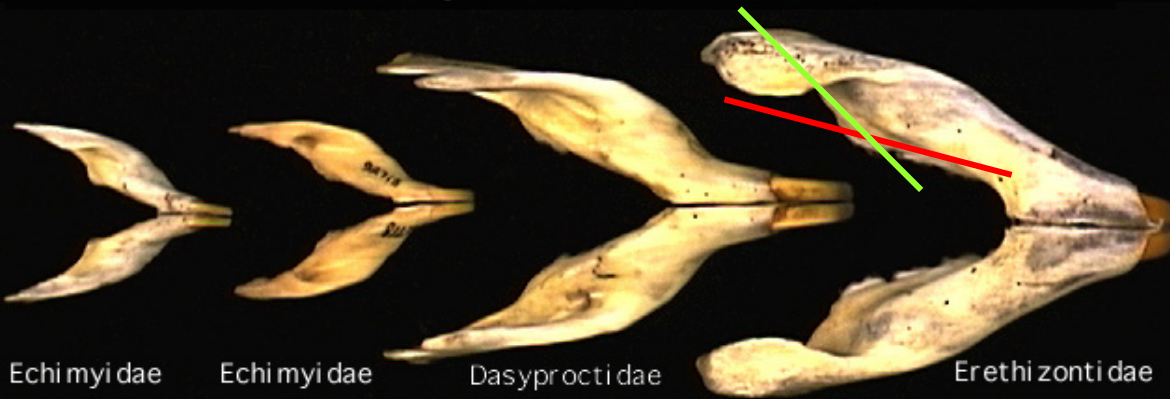

- typy podle polohy p. angularis mandibulae: **sciurognátní** - p.a. je pokračováním spodního okraje mandibuly, pod zubní řadou, může se stáčet dovnitř a **hystriognátní** (230) (Tullberg 1899) - p.a. silně vybočený ven mimo zubní řadu, začíná na rameni mandibuly

- 28-33 čeledí, 2277 druhů (40 % savců)

veverkočelistní (*Sciurognathi*)

bobruškovití (*Aplodontidae*)
veverkovití (*Sciuridae*)
bobrovití (*Castoridae*)
pytlonošovití (*Geomyidae*)
pytloušovití (*Heteromyidae*)
tarbíkovití (*Dipodidae*)
myšovití (*Muridae*)
šupinatkovití (*Anomaluridae*)
noháčovití (*Pedetidae*)
gundiovití (*Ctenodactylidae*)
slepčovití (*Spalacidae*)

dikobrazočelistní (*Hystricognathi*)

rypošovití (*Bathyergidae*)
dikobrazovití (*Hystricidae*)
skalní krysy (*Petromuridae*)
řekomyšovití (*Thryonomyidae*)
urzonovití (*Erethizontidae*)
činčilovití (*Chinchillidae*)
pakaranovití (*Dinomyidae*)
morčatovití (*Caviidae*)
kapybarovití (*Hydrochaeridae*)
agutiovití (*Dasyproctidae*)
pakovití (*Agoutidae*)
tukotukovití (*Ctenomyidae*)
osmákovití (*Octodontidae*)
činčilákovití (*Abrocomidae*)
korovití (*Echimyidae*)
hutiovití (*Capromyidae*)
+ velehutiovití (*Heptaxodontidae*)
nutriovití (*Myocastoridae*)

Rodentia

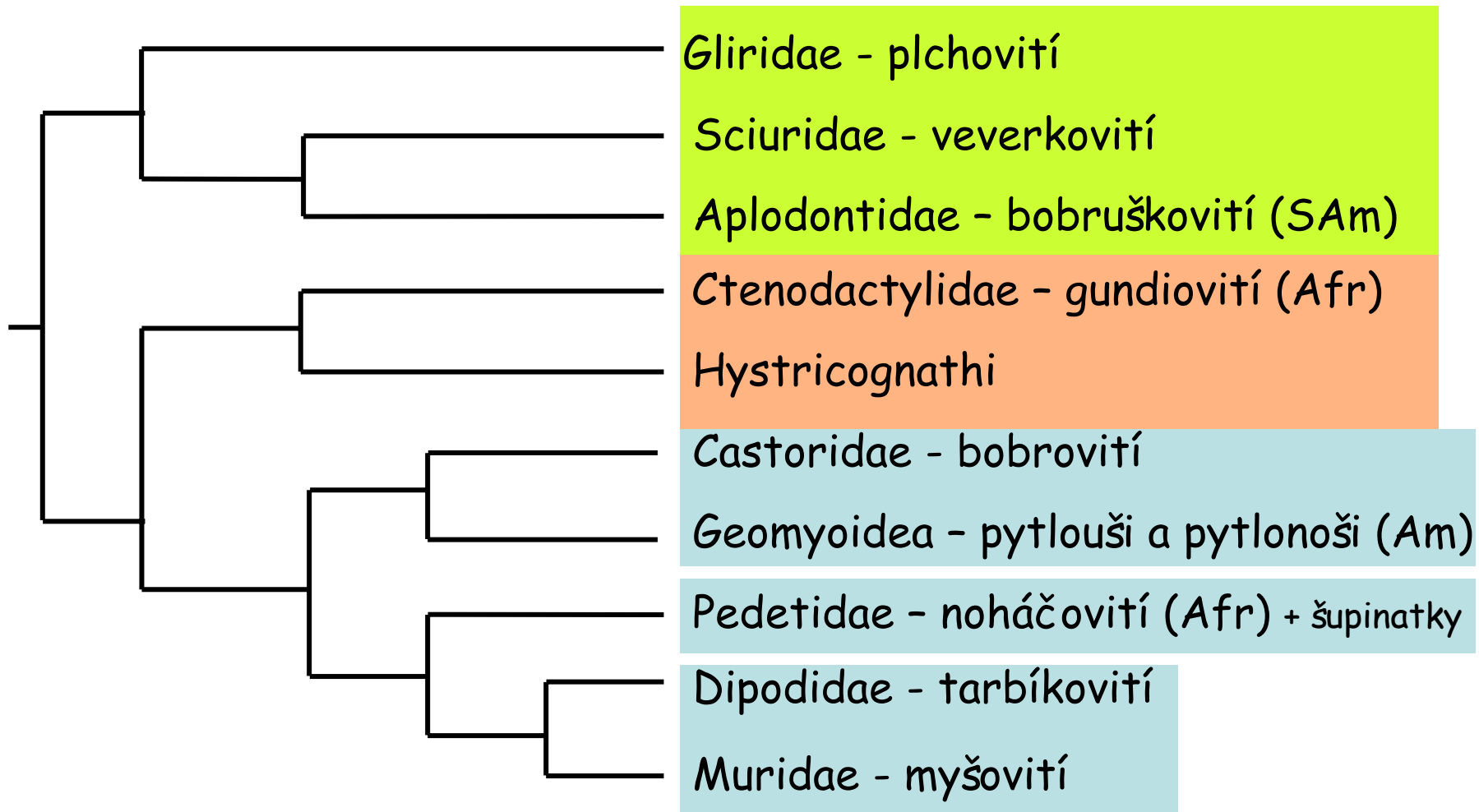

Hystricognathi = rypoši (Bathyergidae), dikobrazi (Hystricidae), morčata (Caviidae), činčily (Chinchilliidae), kapybary (Hydrochoeridae), nutrie (Myocastoridae) aj.

Muridae - myšovití (1300) vč. křečkovití (Cricetidae), hrabošovití (Arvicolidae), rychlá evoluce

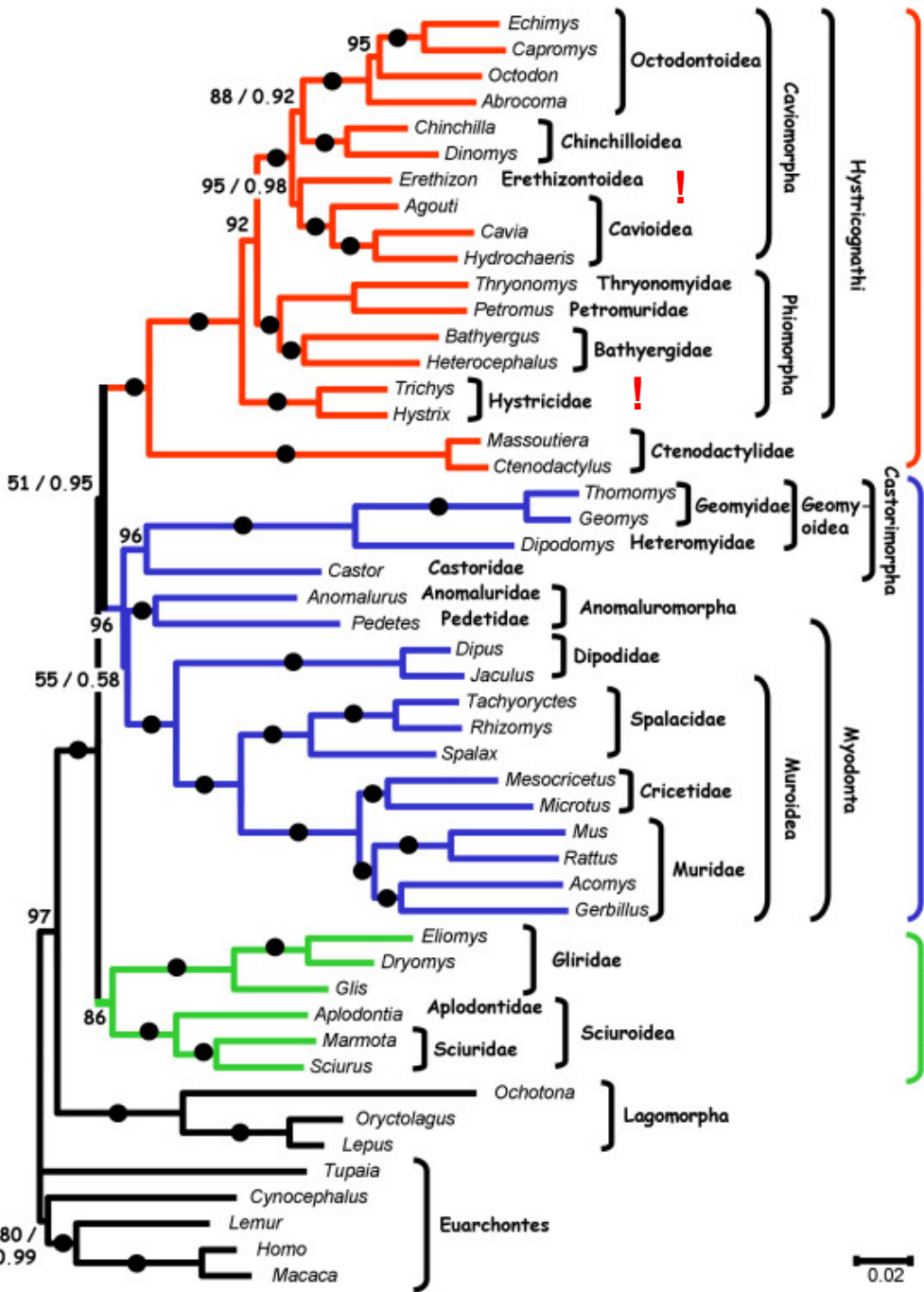

Hystricognathi - dikobrazočelistní
 Caviomorpha - morčatovci - osmáci, činčily, urzoni, agutiové, morčata a kapybara (JAm)
 Phiomorpha - řekomyši, skalní krysy, rypoši, dikobrazi (Afr)

Gundiovití

Castorimorpha - bobři, pytlonoši, pytlouši

Anomalomorpha - šupinatky a noháčci

Myodonta - myšovci
 Dipodidae - tarbíkovití
 Muroidea
 slepcovití
 křečkovití s hraboši
 myšovití s pískomily

Veverkovci (= Sciuroidea)
 veverkovití
 bobruškovití
 Plchovití (= Gliridae)



Glis glis



Spermophilus fulvus

Marmota marmota



Sciurus vulgaris





Aplodontia rufa - bobruška
(SAm)



Ctenodactylus gundi - gundi
(Afr)



Heterocephalus glaber - rypoš lysý

Heliophobius argenteocinereus - rypoš stříbřitý

(Afr)



© Bruce G. Marcot



Hydrochoerus hydrochaeris - kapybara



Dolichotis patagonum - mara stepní (JAm)



paka horská - aguti
(JAm)



dikobraz obecný
(Afr, JaV Asie, Evr)



urzon kanadský
(SAM)



bobr kanadský



pytlonoš nížinný

(SaStř Am)

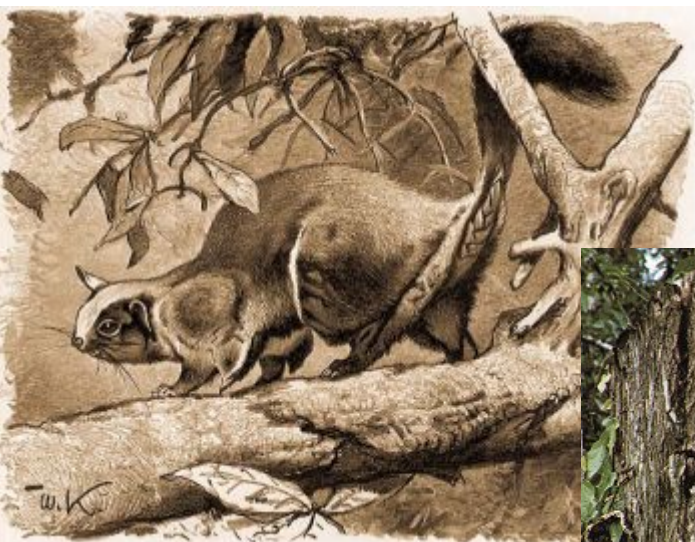

šupinatka

(Afr)



pytlouš mexický

(Am)



© Milan Kořínek

noháč jihoafrický - *Pedetes capensis*



slepec malý - *Nannospalax leucodon*



tarbík egyptský - *Jaculus jaculus*

(SV Afr,
V Asie)

(Afr)



(SV Afr,
JZ Asie)



myš bodlinatá - *Acomys cahirinus*



pestruška - *Lagurus*
(stepi Stř. Eurasie)

(od Tur po stř. As)

(J Rusko)



slepuška krtčí - *Ellobius talpinus*



lumík norský - *Lemmus lemmus*
(hory S Eurasie, Am)

Microtinae - hrabošovité

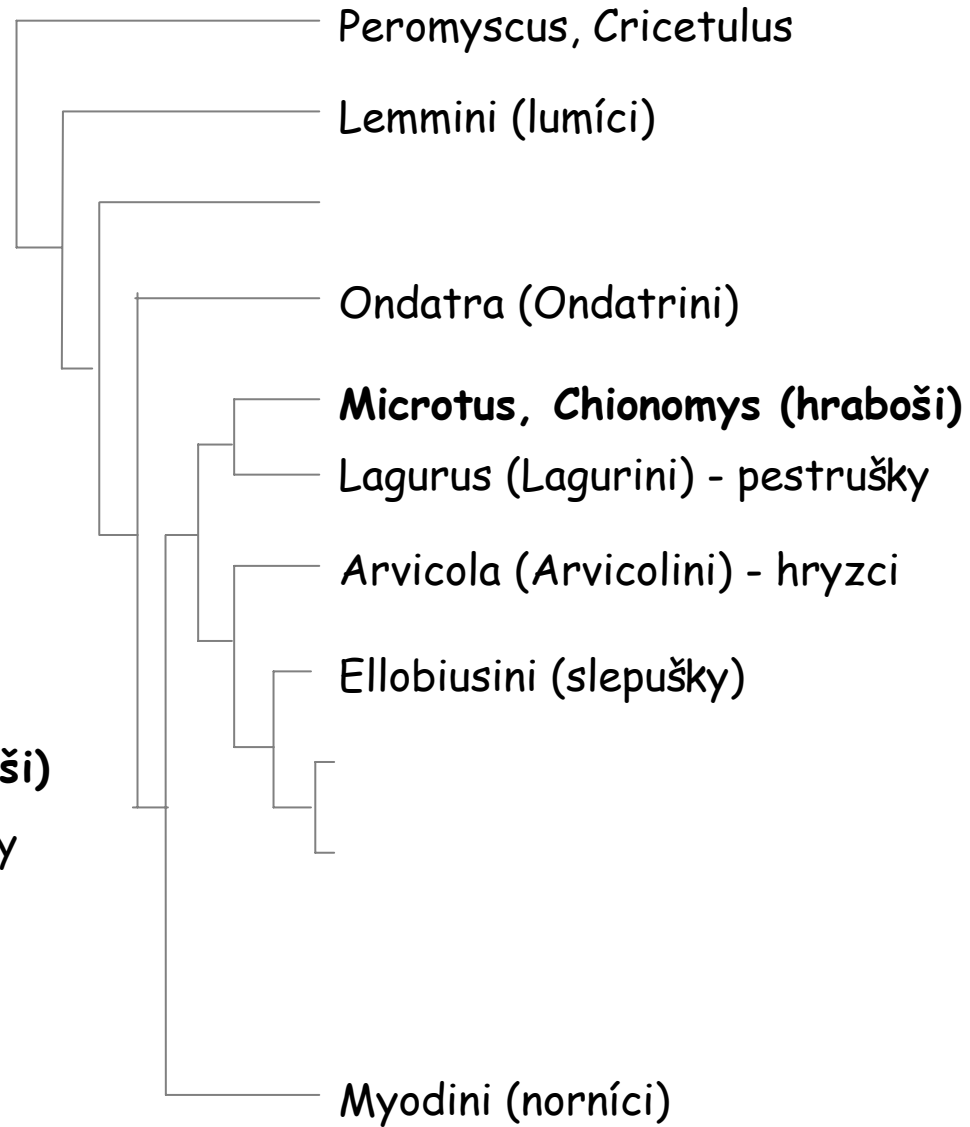
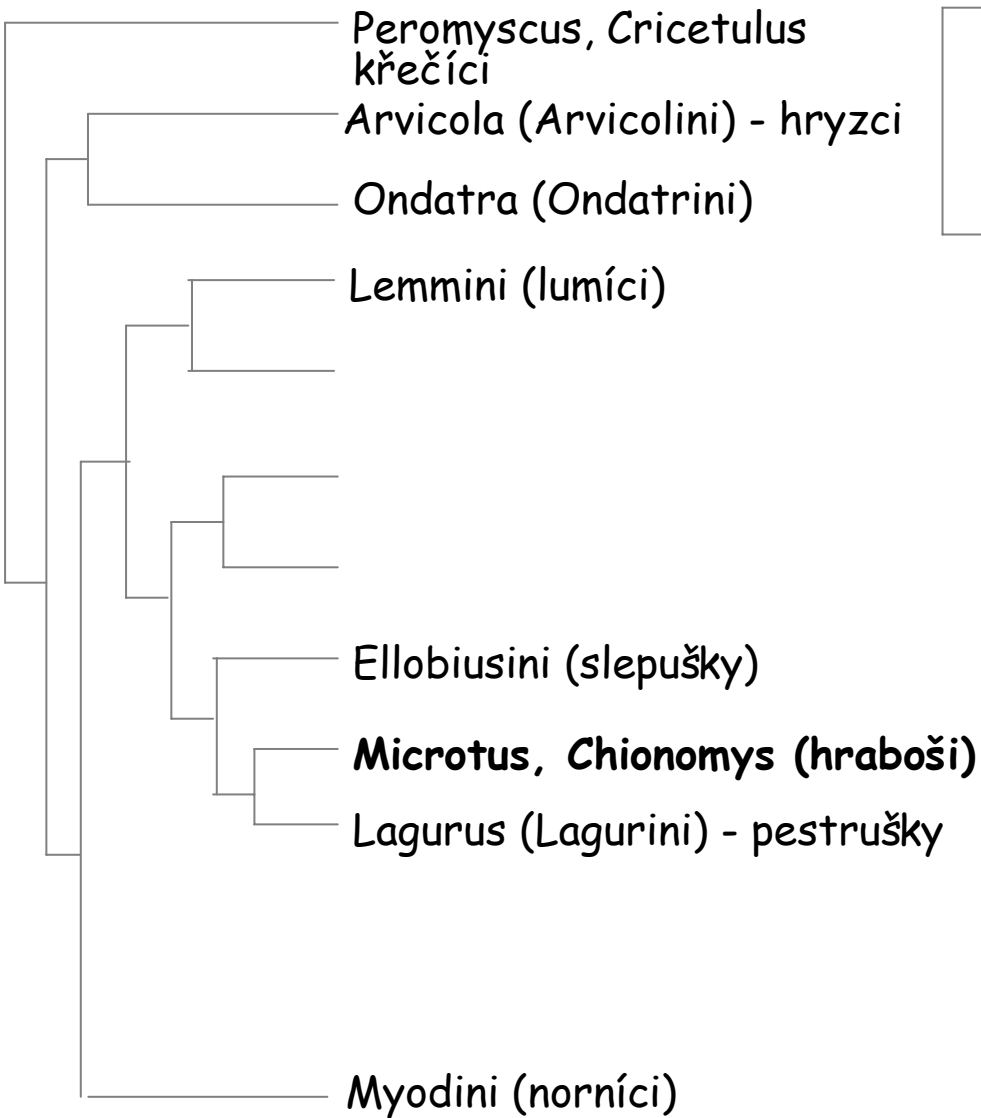

Arvicolinae

voles, lemmings, muskrat

Murinae

Old World rats and mice



postorbital crest or process
formed on squamosal

myomorphous, sciurognathous,
key-hole shaped infraorbital



myomorphous, sciurognathous,
key-hole shaped infraorbital

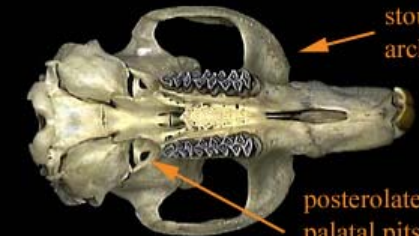

stout zygomatic
arches and plate

cheekteeth prismatic,
hypsodont

posterolateral
palatal pits



cheekteeth of most species
have 3 distinct rows of cusps



DVD

Primáti

4/1 - stromoví

lemuři (sifaka) 36:00 – 41:30

loriové 28:30 – 33:55

komba 33:55 – 36:00

5/1 - žebříček

malpy, kosmani a chápani 1:30 – 20:40

vřešťan, makak, pavián, dželada 20:40

4/1 – stromoví

giboni 44:50 – 48:35

5/2 – potrava a myšlení

orangutan 1:30 – 8:40

šimpanz 8:40 – 30:00

13 + ? + 28

Hlodavci

Hlodavci

aguti 1:50 do konce

potkan 41:10 – 46:30

Stromoví

veverka 14:35 – 17:10

poletuchy 17:10 – 19:30

? + 5,5 + 2,5 + 2,2