

PTÁCI

2.část

Řád: PĚVCI (*Passeriformes*)

- více jak polovina ptačích druhů (skoro 6000 druhů v asi 100 čeledích), rozmanitá skupina
- většinou menší ptáci, zpěvné svaly v syrinxu (zpívají samci - stř. Evropa)
- anisodaktylní noha (3+1 prsty bez blan, stejně vysoko a stejně dlouhé)
- samci většinou větší a pestřejší
- staví hnízdo, nidikolní ml., většinou se starají oba rodiče, rozmanitá potrava
- u nás zjištěno 151 druhů (97 hnízdí)



Členění do 2 skupin:
Suboscines (Tyranni)
Oscines (Passeri)

-původ v Gondwaně?
(Acanthisittidae)

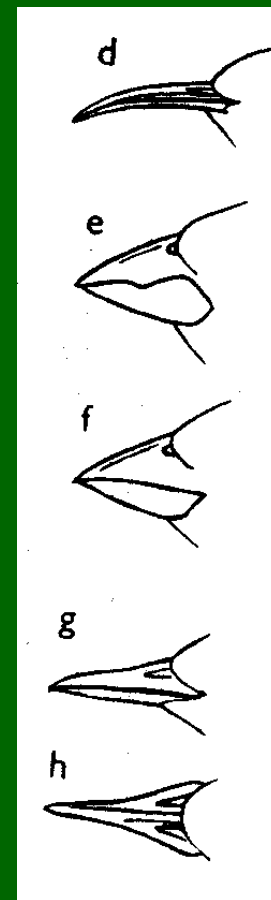
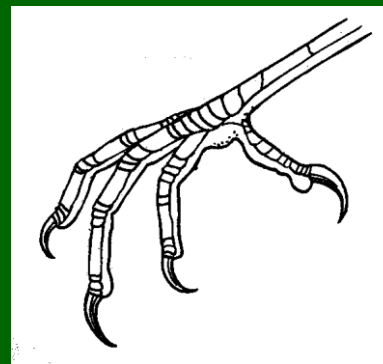
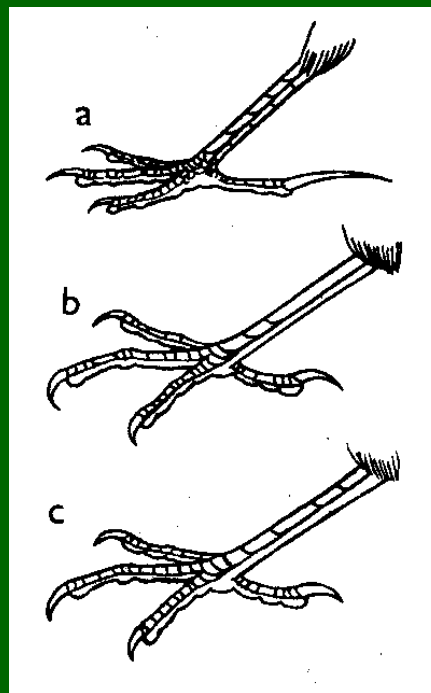

Oscines - zpěvní (859/4530)

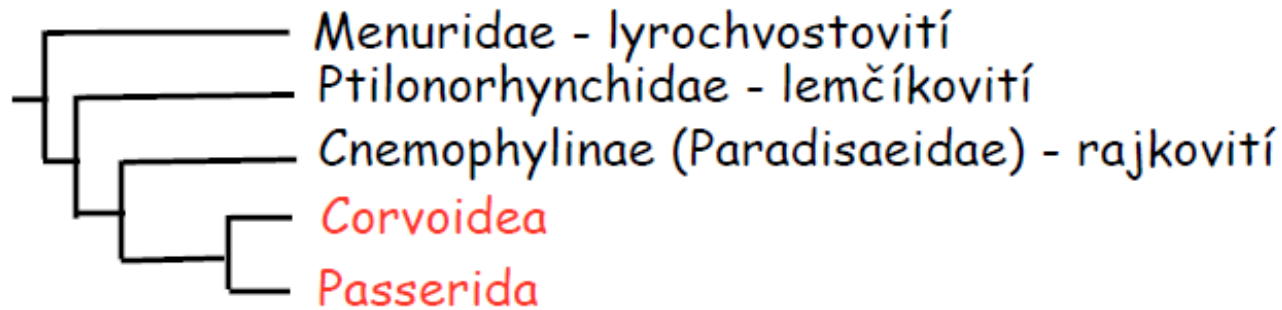

Corvoidea - převážně Nový svět

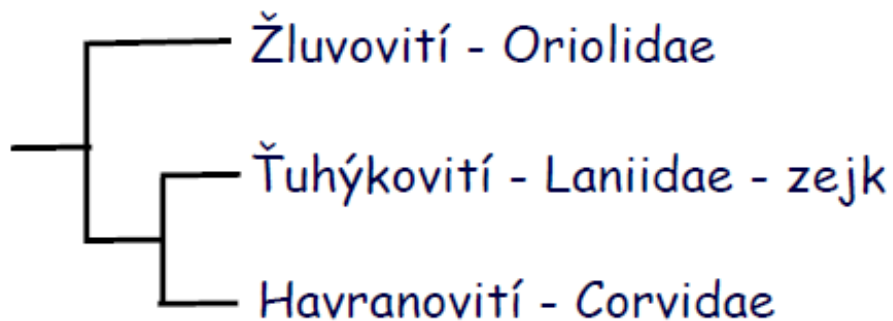

Passerida - Starý svět

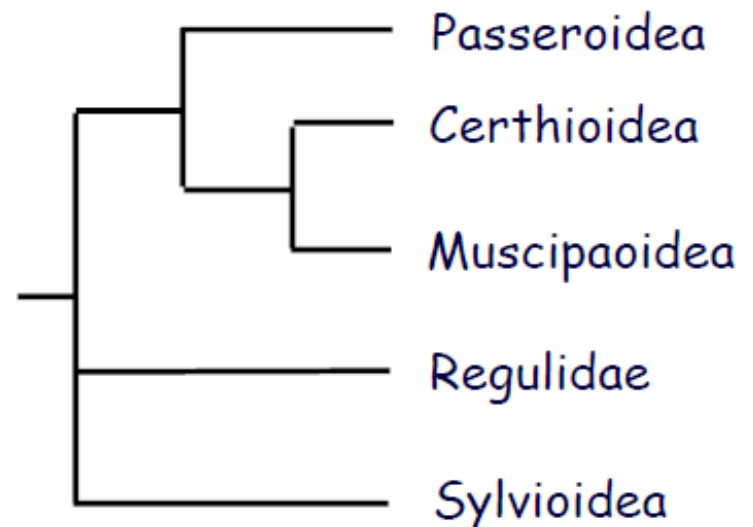

Č: Žluvovití – *Oriolidae*

CORVOIDEA (CORVIDA)

- středně velcí, stromoví
- silný zobák, pestré zbarvení
- samci větší a pestřejší
- potravou hlavně hmyz
- hluboké hnízdo z trávy vysoko na stromech (u nás 1 druh)



Žluva hajní (*Oriolus oriolus*)

Č: Ťuhýkovití – *Laniidae*

CORVOIDEA (CORVIDA)

- statní masožraví ptáci, velká hlava, ostrý zobák se zejkem, vibrisy
- silné ostré drápy, delší ocas, pestré zbarvení
- někdy pohl. dimorfismus, hnízdo v keřích či na stromech
- potravou bezobratlí i drobní obratlovci (zásobárny)
- u nás 4 druhy (2 hnízdí)



Ťuhýk obecný (*Lanius collurio*)



Ťuhák šedý (*Lanius excubitor*)



Řuhák menší (*Lanius minor*)



© - lubomir hlasek
www.hlasek.com
Lanius minor 8548



Řuhák rudohlavý (*Lanius senator*)



Č: Krkavcovití – *Corvidae*

CORVOIDEA (CORVIDA)

- středně velcí až velcí ptáci (největší pěvci), silný zobák
- často tmavé zbarvení, hnízda vysoko na stromech, často stálé páry
- všežravci i mrchožrouti, vospělé chování, u nás 9 druhů (8 hnízdí)



Krkavec velký (*Corvus corax*)

Vrána černá (*Corvus corone*)



Vrána šedivka (*Corvus cornix*)



Havran polní (*Corvus frugilegus*)



Kavka obecná (*Corvus monedula*)



Sojka obecná (*Garrulus glandarius*)



Straka obecná (*Pica pica*)



Ořešník kropenatý (*Nucifraga caryocatactes*)

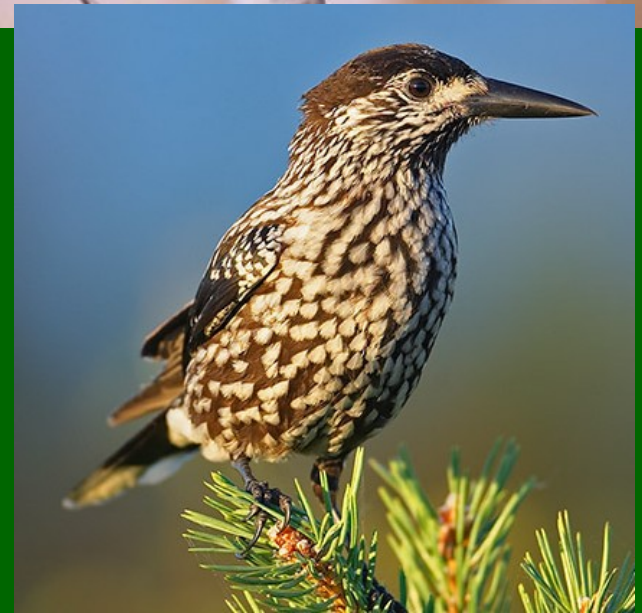

Passerida

a) Sylvioidea:

Sýkorovití - Paridae

Moudivláčkovití - Remizidae

Skřivanovití - Alaudidae

Panurus - sýkořice

Mlynaříkovití - Aegithalidae

Sýkořicovití - Timaliidae

„Pěnicovití“ - Sylviidae

Vlaštovkovití - Hirundinidae

b) Králíčkovití - Regulidae

c) Muscicapoidea:

Brkoslavovití - Bombycillidae?

Skorcovití - Cinclidae

Drozdovití - Turdidae

Lejskovití - Muscicapidae

Špačkovití - Sturnidae

d) Certhioidea

Brhlíkovití - Sittidae

Zedníčkovití - Tichodromatidae

Šoupáلكovití - Certhiidae

Střízlíkovití - Troglodytidae

e) Passeroidea:

Vrabcovití - Passeridae

Konipasovití - Motacillidae

Pěvuškovití - Prunellidae

Pěnkavovití - Fringillidae

Strnadovití - Emberizidae

Zatím poslední pojetí PASSERIDA

REGULOIDEA

Regulidae

PAROIDEA

Remizidae

Paridae

SYLVIOIDEA

Panuridae

Alaudidae

Hirundinidae

Aegithalidae

Locustellidae

Acrocephalidae

Phylloscopidae

Sylviidae

BOMBYCILLOIDEA

Bombycillidae

CERTHIOIDEA

Trichodromadidae

Sittidae

Certhiidae

Troglodytidae

MUSCICAPOIDEA

Sturnidae

Cinclidae

Turdidae

Muscicapidae

PASSEROIDEA

Prunellidae

Passeridae

Motacillidae

Fringillidae

Emberizidae

Č: Králíčkovití – *Regulidae*

REGULOIDEA

- drobní zavalití ptáčci (nejmenší pěvci)
- krátký špičatý zobák, nenápadné zbarvení, barevná korunka
- jehličnaté lesy, hnízdo vysoko na stromech, hmyzožravci, v zimě pospolití
- u nás 2 hnízdící druhy (kdysi řazeni k pěnicovitým)



Králíček obecný (*Regulus regulus*)

Králíček ohnivý (*Regulus ignicapilla*)

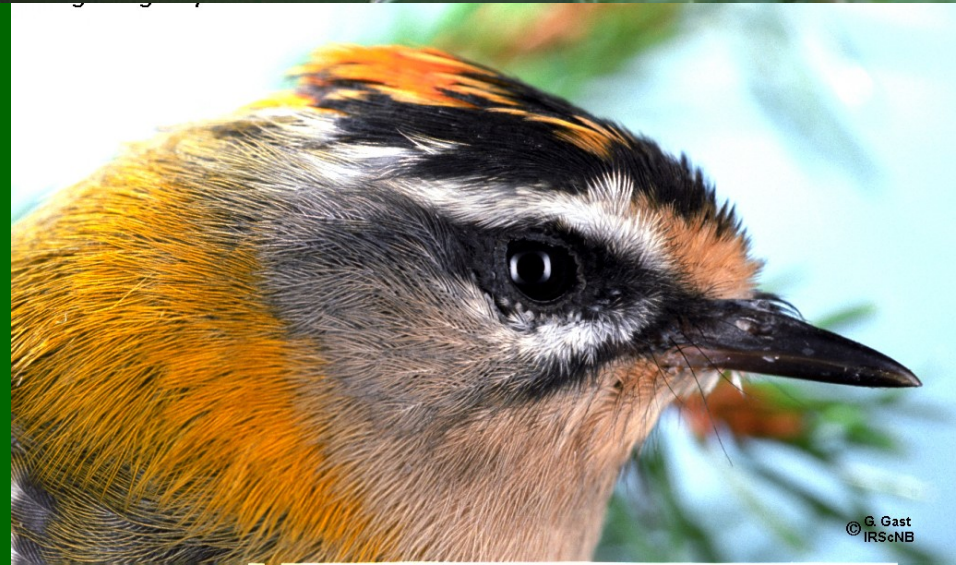

Č: Moudivláčkovití - *Remizidae*

PAROIDEA

- malí podsadití ptáčci, v blízkosti vod
- visící vakovité hnízdo z chmýří, potravou hmyz a semena
- u nás 1 hnízdící druh



Moudivláček lužní (*Remiz pendulinus*)

Č: Sýkorovití – Paridae

PAROIDEA

- drobní podsadití stromoví ptáci s ostrým silným zobáčkem
- samci větší a pestřejší, vícedruhová hejna, různé biotopy
- hnízdí v dutinách či štěrbinách
- potravou hmyz, v zimě hlavně olejnatá semena
- u nás 7 druhů (6 hnízdí)



Sýkora koňadra (*Parus major*)

Sýkora modřinka (*Cyanistes caeruleus*)



Sýkora uhelníček (*Periparus ater*)



© - lubomir hlasek
www.hlasek.com
Parus ater 11034

Sýkora parukářka (*Lophophanes cristatus*)



Sýkora babka (*Poecile palustris*)



Sýkora lužní (*Poecile montana*)



Č: Sýkořicovití – *Panuridae*

SYLVIOIDEA

- drobní společenší ptáci, krátký zobák, dlouhý stupňovitý ocas
- rákosiny, mimo hnízdění potulky
- potravou hmyz, semena, plody
- u nás 1 hnízdící druh
- nevyjasněné zařazení (součást Timaliidae, Paradoxornithidae, monotypická čeleď)



Sýkořice vousatá (*Panurus biarmicus*)

Č: Skřivanovití – *Alaudidae*

SYLVIOIDEA

- pozemní ptáci s dlouhými drápy – hlavně na palci
- nenápadné zbarvení, většinou otevřená krajina, vysoké zpěvné lety
- hnízdo na zemi, potravou semena a bezobratlí
- u nás 5 druhů (3 hnízdí)

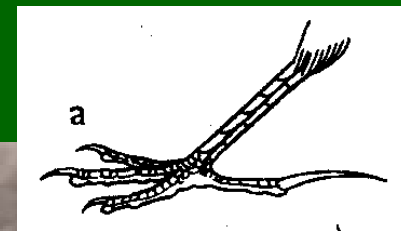

Chocholouš obecný (*Galerida cristata*)

Skřivan polní (*Alauda arvensis*)



Skřivan lesní (*Lullula arborea*)



Č: Vlaštovkovití – *Hirundinidae*

SYLVIOIDEA

- štíhlí ptáci, adaptace na rychlý let – úzká špičatá křídla, dlouhý vidličnatý ocas, malé nohy
- lov hmyzu v letu – široký zobák s vibrisy
- koloniální hnízdění, hnízdo z bláta, synantropizace
- u nás 5 druhů (3 hnízdí)



Vlaštovka obecná
(*Hirundo rustica*)



Jiříčka obecná (*Delichon urbicum*)



Břehule říční (*Riparia riparia*)



Č: Mlynaříkovití – *Aegithalidae*

SYLVIOIDEA

- drobní ptáčci s dlouhým ocáskem a krátkým zobáčkem
- společenští, kulovité hnízdo s postranním vchodem
- vlnovitý let, potravou hlavně hmyz
- u nás 1 hnízdící druh



Mlynařík dlouhoocasý
(*Aegithalos caudatus*)



Č: „Pěnicovití – *Sylviidae*“

SYLVIOIDEA

- drobní štíhlí, nenápadně zbarvení ptáci, úzký špičatý zobák
- výrazný zpěv, tažní hmyzožravci
- život i hnízdění v husté vegetaci
- u nás 28 druhů (17 hnízdí)
- dnes obvykle členění na Cettiidae, Locustellidae, Phylloscopidae, Acrocephalidae, Cisticolidae a Sylviidae

Č: Locustellidae - cvrčilkovití



Cvrčilka říční
(*Locustella fluviatilis*)

Cvrčilka zelená (*Locustella naevia*)



Cvrčilka slavíková (*Locustella luscinioides*)



Č: Acrocephalidae - rákosníkovití

Rákosník obecný (*Acrocephalus scirpaceus*)



Rákosník zpěvný (*Acrocephalus palustris*)



Rousserolle verderolle
(*Acrocephalus palustris*)



Rákosník velký (*Acrocephalus arundinaceus*)



Rákosník proužkovaný (*Acrocephalus schoenobaenus*)



Rákosník tamaryškový
(*Acrocephalus melanopogon*)



Rákosník ostřicový
(*Acrocephalus paludicola*)



Sedmihlásek hajní (*Hippolais icterina*)



Č: Sylviidae – pěnicovití s. str.
Pěnice černohlavá (*Sylvia atricapilla*)



Pěnice slavíková (*Sylvia borin*)



Pěnice hnědokřídlá (*Sylvia communis*)



Pěnice pokřovní (*Sylvia curruca*)



Pěnice vlašská (*Sylvia nisoria*)



Č: Phylloscopidae - budníčkovití
Budníček menší (*Phylloscopus collybita*)



Budníček větší (*Phylloscopus trochilus*)



Budníček lesní (*Phylloscopus sibilatrix*)



Budníček zelený (*Phylloscopus trochiloides*)



Č: Brkoslavovití – *Bombycillidae*

- středně velcí pěvci, měkké pestré opeření, krátký zobák, chocholka
- pospolití, plodožraví specialisté, u nás zimní hosté (1 druh – invaze)



Brkoslav severní
(*Bombycilla garrulus*)

Č: Zedníčkovití – *Tichodromadidae*

- středně velký pták, dlouhý zahnutý zobák, silné drápy
- šedivé zbarvení, červená křídla
- vysokohorské habitaty, šplh po skalách
- hmyzožravci, hnízda ve skalních štěrbinách
- u nás vzácně zimující 1 druh



Zedníček skalní
(*Tichodroma muraria*)

Č: Brhlíkovití – *Sittidae*

CERTHIOIDEA

- podsadití stromoví ptáci, šplh po stromech a větvích, i hlavou dolů
- dlouhý silný zobák, krátký ocas, silné zahnuté drápy
- lesní biotopy, teritoriální, hnízdí v dutinách (zedník)
- potravou bezobratlí, semena
- u nás 1 hnízdící druh

Sitta europaea ♀



Brhlík lesní (*Sitta europaea*)



Č: Šoupálkovití – *Certhiidae*

- malí štíhlí stromoví ptáci, dlouhý zahnutý zobák
- krátké nohy s dlouhými zahnutými drápy, dlouhý pevný ocas
- šplh hlavou nahoru, hnízdo ve štěrbinách (za kůrou)
- potravou hlavně bezobratlí, vícedruhová hejna
- u nás 2 hnízdící druhy



Šoupálek dlouhoprstý
(*Certhia familiaris*)

Šoupálek krátkoprstý (*Certhia brachydactyla*)



Č: Střízlíkovití – *Troglodytidae*

CERTHIOIDEA

- drobní, podsaditá ptáčci s krátkým ocáskem vztyčeným nahoru
- hnědé zbarvení, tmavé příčkování, úzký špičatý zobák
- teritoriální, hlasitý zpěv, potravou bezobratlí
- křoviny, kupolovité hnízdo s postranním vchodem
- u nás 1 hnízdící druh



Střízlík obecný (*Troglodytes troglodytes*)

Č: Špačkovití – *Sturnidae*

MUSCICAPOIDEA

- menší stromoví ptáci, silný zobák, trojúhelníkovitá křídla, kovový lesk peří
- hnízdí v dutinách stromů, potravu hledají na zemi (všežravci)
- sociální chování, imitují zpěv
- u nás 2 druhy (1 hnízdí)



Špaček obecný (*Sturnus vulgaris*)



Č: Skorcovití – *Cinclidae*

MUSCICAPOIDEA

- zavalití pěvci, vázaní na vodu, silná chodidla s drápy, husté prachové peří, krátká špičatá křídla
- rychle tekoucí úseky toků, potravou hl. vodní bezobratlí – lov pod vodou
- kupolovitá hnízda ve výklencích břehů a pod.
- u nás 1 hnízdící druh



Skorec vodní
(*Cinclus cinclus*)

Č: Drozdovití – *Turdidae*

MUSCICAPOIDEA

- středně velcí stromoví ptáci (jen rod *Turdus*), štíhlý špičatý zobák, vibrisy
- dlouhé nohy s botkou (splynutí štítků na přední straně běháků)
- výrazný zpěv z vyvýšených míst, hnízdí v keřích či stromech, potravu sbírají hlavně na zemi (bezobratlí, plody)
- u nás 10 druhů (6 hnízdí)

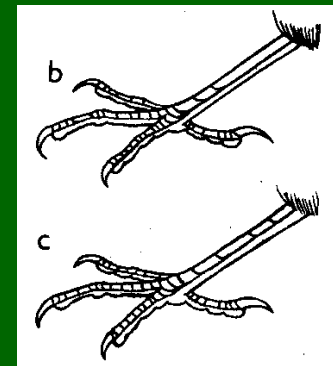

Kos černý (*Turdus merula*)



asek
m
d80

Kos horský (*Turdus torquatus*)

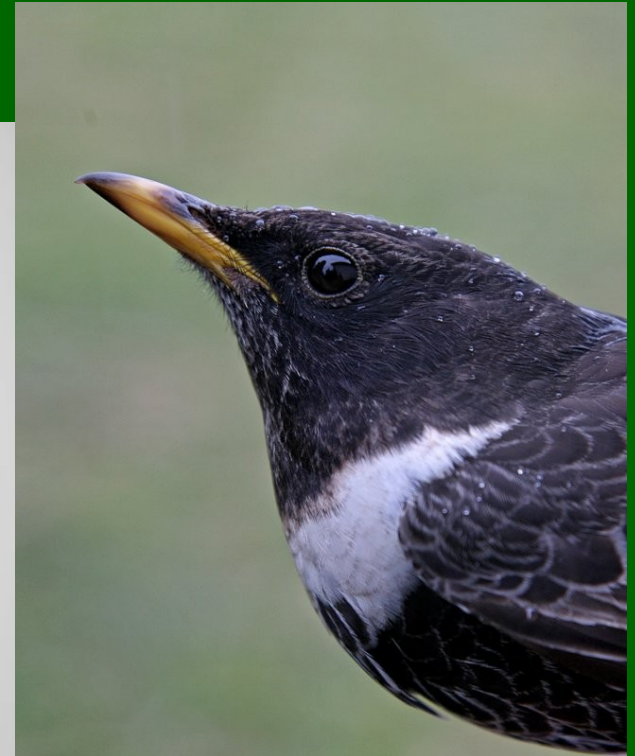

Drozd zpěvný (*Turdus philomelos*)



Drozd brávník (*Turdus viscivorus*)



Drozd kvíčala (*Turdus pilaris*)



Drozd cvrčala (*Turdus iliacus*)



Č: „Lejskovití“ – *Muscicapidae*

Muscicapa + *Ficedula* - malí stromoví ptáci s velkou hlavou a očima
 - zploštělý zobák s vibrisy, lov hmyzu v letu – „Fly – catching“
 - hnízdí v dutinách či polodutinách stromů

Saxicolinae: bělořiti, slavíci, bramborníčci a rehci - malí stromoví ptáci, štíhlý špičatý zobák, vibrisy
 - dlouhé nohy s botkou (splynutí štítků na přední straně běháků)
 - výraznější zpěv, samci někdy pestřejší
 - hnízdí v keřích či stromech, potravu sbírají hlavně na zemi (bezobratlí, plody)
 - u nás celkem 17 druhů (13 hnízdí)



Lejsek šedý (*Muscicapa striata*)

Červenka obecná (*Erithacus rubecula*)

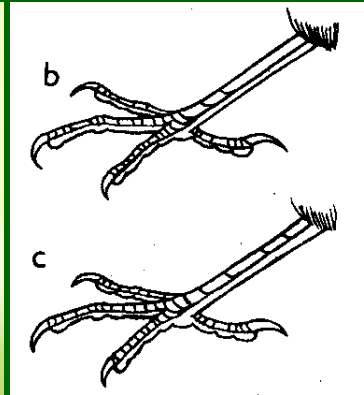

Slavík obecný (*Luscinia megarhynchos*)



Slavík tmavý (*Luscinia luscinia*)



Slavík modráček (*Luscinia svecica*)

S. m. středoevropský (*L. s. cyanecula*)



S. m. tundrový (*L. s. svecica*)



Rehek domácí (*Phoenicurus ochruros*)



Rehek zahradní (*Phoenicurus phoenicurus*)



Bramborníček černohlavý (*Saxicola rubicola*; syn. *torquatus*)



Bramborníček hnědý (*Saxicola rubetra*)



Bělořit šedý (*Oenanthe oenanthe*)



Skalník zpěvný
(*Monticola saxatilis*)



Lejsek bělokrký (*Ficedula albicollis*)



Lejsek černohlavý (*Ficedula hypoleuca*)



Lejsek malý (*Ficedula parva*)



Lejsek
m
4255

Č: Pěvuškovití – *Prunellidae*

PASSEROIDEA

- drobní převážně vysokohorští pěvci, lehce podhrnutý zobák
- nevýrazné zbarvení, pozemní nebo v keřích
- hnízdo ve vegetaci nebo ve skalách
- potravou hmyz, semena, plody
- u nás 3 druhy (2 hnízdí)



Pěvuška modrá (*Prunella modularis*)

Pěvuška podhorní (*Prunella collaris*)



Č: Vrabcovití – *Passeridae*

PASSEROIDEA

- menší ptáci se silným kuželovitým zobákem, pozemní
- hlavně semenožraví, méně plody, hmyz
- společenšší – komplex sociálního chování
- koloniální hnízdění – v keřích či dutinách, synantropní
- u nás 3 druhy (2 hnízdí)



Vrabc domácí
(*Passer domesticus*)

Vrabec polní (*Passer montanus*)



Pěnkavák sněžní (*Montifringilla nivalis*)



Č: Konipasovití – *Motacillidae*

PASSEROIDEA

- většinou pozemní štíhlí ptáci s dlouhýma nohama a ocasem
- kontrastní (konipasi) nebo nenápadné zbarvení (lindušky)
- otevřené biotopy, let ve vlnkách, hnízdo na zemi, ve štěrbinách
- všežravci, u nás 11 druhů (8 hnízdí)



Konipas bílý (*Motacilla alba*)

Konipas luční (*Motacilla flava*)



Konipas horský (*Motacilla cinerea*)



Konipas citrónový (*Motacilla citreola*)

Linduška lesní (*Anthus trivialis*)



Linduška luční (*Anthus pratensis*)



Linduška úhorní (*Anthus campestris*)



Linduška horská (*Anthus spinoletta*)



Č: Pěnkavovití - *Fringillidae*

PASSEROIDEA

- menší podsadití stromoví ptáci, silný krátký zobák – semenožravci
- samci většinou pestřejší, různé biotopy, vlnovkový let
- potravu hledají na zemi, otevřené miskovité hnízdo v keřích či stromech
- u nás 20 druhů (11 hnízdí)



Pěnkava obecná (*Fringilla coelebs*)

Pěnkava jíkavec (*Fringilla montifringilla*)



Zvonohlík zahradní (*Serinus serinus*)



Zvonek zelený (*Chloris chloris*)



oldrich hlasek
w.hlasek.com
duelis chloris 11340



Stehlík obecný (*Carduelis carduelis*)



Čížek lesní (*Carduelis spinus*)



www.hl
Carduel

Konopka obecná (*Carduelis cannabina*)



Konopka žlutozobá
(*Carduelis flavirostris*)

Čečetka tmavá (*Carduelis cabaret*)



Čečetka zimní (*Carduelis flammea*)



Křivka obecná (*Loxia curvirostra*)



SVO. Manu Polo.



mir hlasek
asek.com



© J.FOUCARGE

Hýl rudý (*Carpodacus erythrinus*)



Hýl křivčí
(*Pinicola enucleator*)



Hýl obecný (*Pyrrhula pyrrhula*)



d21



Dlask tlustozobý (*Coccothraustes coccothraustes*)



RGE



Č: Strnadovití – *Emberizidae*

PASSEROIDEA

- menší pozemní ptáci s tlustým zobákem, dlouhý ocas
- různě proužkované zbarvení, samci většinou pestřejší
- semenožravci, otevřená krajina, hnízdo nízko nad zemí
- u nás 14 druhů (4 hnízdí)



Strnad obecný (*Emberiza citrinella*)

Strnad rákosní (*Emberiza schoeniclus*)



Strnad zahradní (*Emberiza hortulana*)



Strnad luční (*Emberiza calandra*)



Sněhule severní (*Plectrophenax nivalis*)

