



ELECTROANALYTICAL TECHNICS

I

COULOMETRY

- ☞ An analytical method for determining the amount (m) of a substance released during electrolysis in which the number of coulombs (nF) used is measured.
- ☞ Coulometry is an absolute measurement similar to **gravimetry** and requires no chemical standards or calibration. It is therefore valuable for making absolute concentration determinations of standards.

$$m = AQ = A I t = (M/nF) I t$$

m amount of electroactive substance

A electrochemical equivalent

M molar weight

I current

t time

Definition

One Coulomb C is the quantity of charge transported by an electric current of one Ampere (A) during one second (s).

$$1 \text{ C} = 1 \text{ A} \cdot 1 \text{ s}$$

To produce one mol of a chemical compound, using one electron, 96 484 C are required.



Charles Augustin de Coulomb (1736 –1806)

- 
- **Michael Faraday, 1834** – *the relation between the amount of electricity consumed and the amount of metal produced in solid form from solutions*
 - **Laszlo Szebelledy, Zoltan Somogyi 1938** – *the basis for coulometric analysis used in electroanalytical methods - coulometry as a new electroanalytical method*
 - **Panta S. Tutundžić** – *coulomb as the primary standard*

Measurement of Charge Using Chemical Coulometers

Very high precision of charge measurement is possible with a chemical coulometer. However, chemical coulometers are always less convenient to use than electronic integration instrumentation. As a consequence chemical coulometers are no longer commonly used in the electrochemical laboratory. The types of **chemical coulometer** which are most precise are :

- the silver
- the iodine
- the hydrogen-oxygen gas
- the hydrogen-nitrogen gas

coulometer

0.1%



Measurement of Charge Using Electronic Integration

Analog method of integrating charge

*the most common method - electronic integration of the instantaneous charge (which is proportional to current) be built up as actual charge on a capacitor over a period of time,

*the voltage across the capacitor, which is a measure of the charge held, is then determined; if the quality of the capacitor is such that no significant charge leaks off during the period of charge accumulation,

*this method is capable of results of good precision; a useful integrator circuit consists of an operational amplifier with an integrating capacitor in the feedback loop.



Measurement of Charge Using Electronic Integration

Digital method of integrating charge

* can be used if the current being measured is applied as a series of identical small current pulses. If the number of coulombs in a single pulse is accurately known, multiplication by the number of pulses (which can easily be counted by a digital counter) gives the charge passed with the same relative **error** as the relative error with which the charge of a single pulse is known, provided that the number of pulses is sufficiently large.

* highly practical for coulometric titrations, since often electrogeneration conditions can be established which are not adversely affected by the pulsating nature of the current.

* this method should not be used without care both as to the apparatus and as to the electrochemical reactions being employed.

COULOMETRY

can be performed as a **constant-potential** or a **constant-current** technique.

POTENCIOSTATIC COULOMETRY

AMPEROSTATIC COULOMETRY

POTENCIOSTATIC COULOMETRY

* **Constant-potential coulometry** can be used both as **a technique of analysis** and as a means **for determining the value n** (number of electrons per molecule).

* By **Faraday's law**, the total quantity of chemical change produced at an electrode is directly proportional to the quantity of electricity passed. The fundamental requirement for a controlled-potential coulometric analysis is that the electrode reaction under investigation proceeds **with 100% current efficiency**. If this condition is satisfied, the amount of electricity produced or consumed can be related to the concentration by Faraday's law.

* In the constant-potential coulometry the electrode potential should be maintained constant using a **potentiostat**. In addition to general potentiostats used for various applications, special potentiostats for constant-potential coulometry (particularly, constant-potential coulometric titrations) have been designed.

POTENCIOSTATIC COULOMETRY

$$E = \text{const.}$$

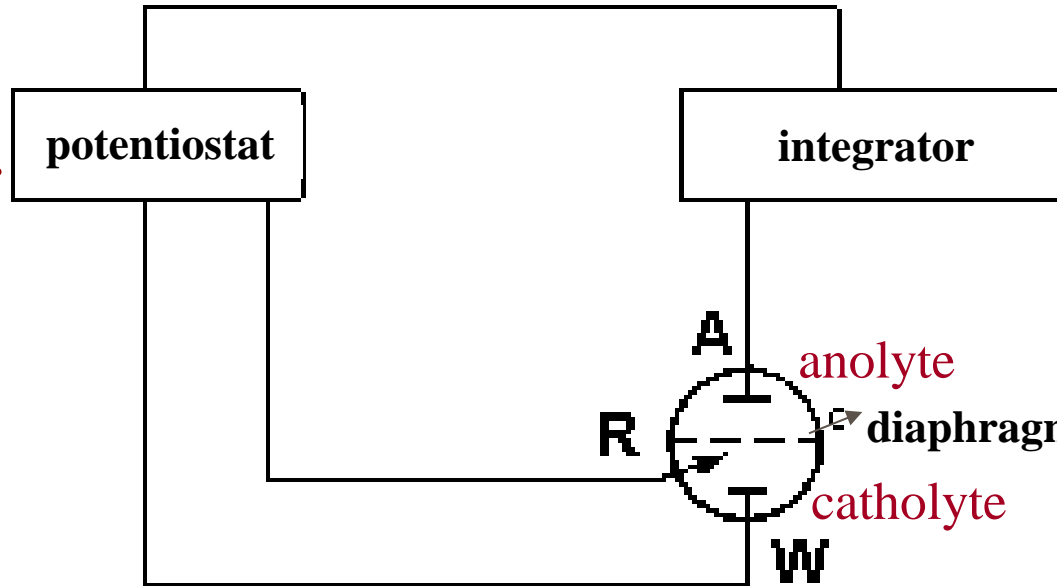

$$Q = \int_0^t I dt$$

ISES (Intelligent School Electronic System)

W.....Pt, Au, Hg and vitreous carbon

A..... auxiliary Pt

R..... Ag/AgCl/KCl or Hg/Hg₂Cl₂/KCl

Determination of metal ions, actinides, organic substances (coulometric detector in combination with HPLC)

Determination of SO₂ a NO₂

COULOMETRIC METHODS

Direct Coulometry

Methods in which a substance is quantified by either oxidation or reduction directly at an electrode.

Two approaches

Constant Potential

Constant Current



DIRECT COULOMETRY

Direct methods are of limited interest.

Approach is hard to control.

Suffers from the same problems with overpotential as electrodeposition.

Unexpected reactions can be a major problem.

Indirect coulometric methods are more useful.

DIRECT COULOMETRY

Constant potential

As the reactants are consumed, the current decreases. When the reaction is complete, the current is negligible.

The area under the curve equals the number of coulombs used.

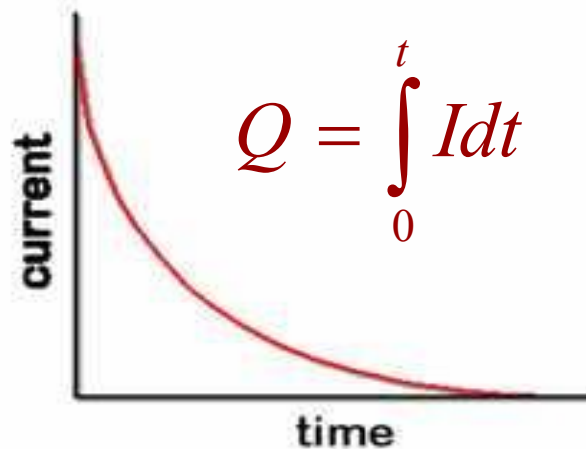

DIRECT COULOMETRY

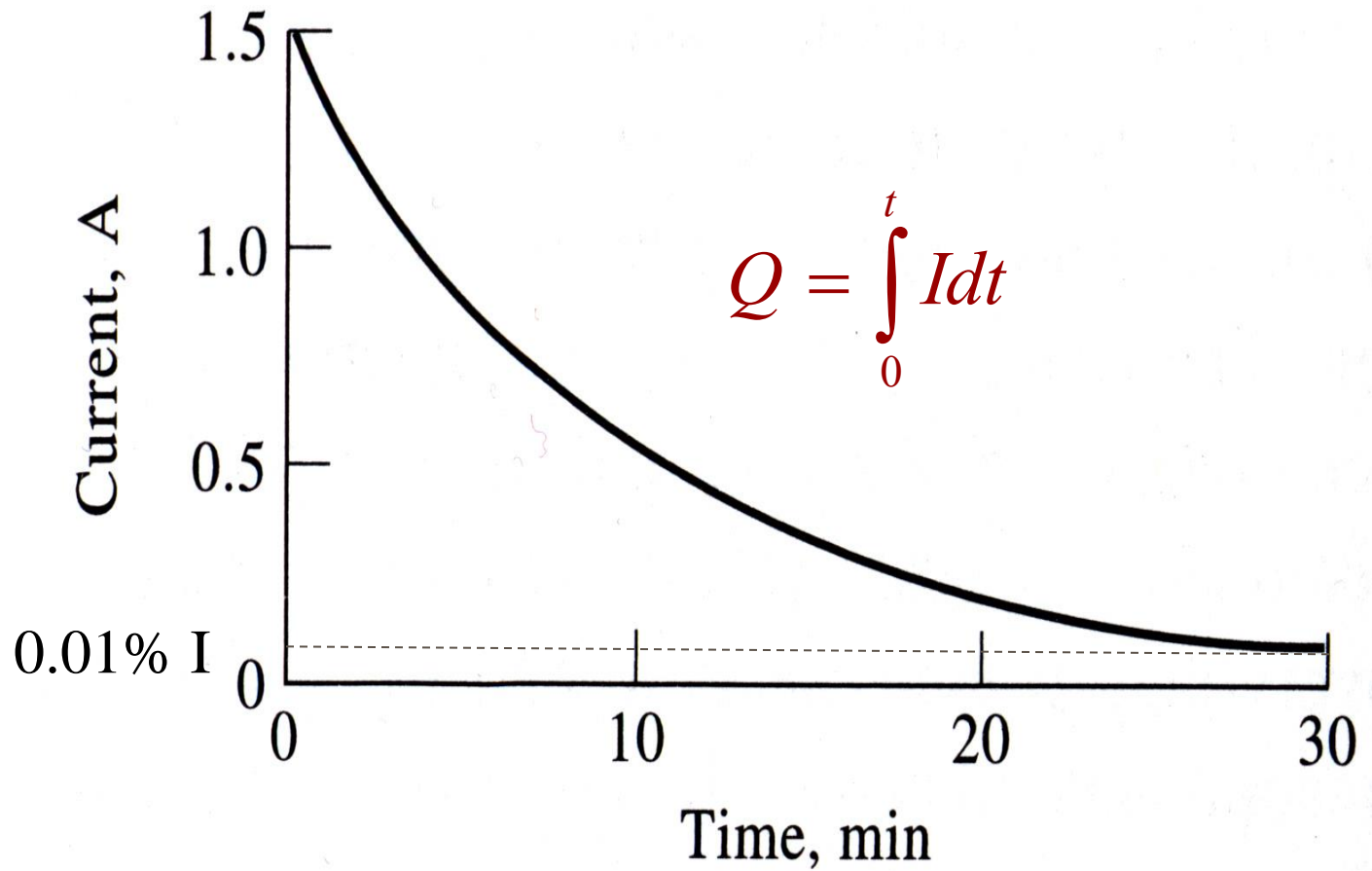

$$f_{(x=0)}(\text{flux}) = D \left(\frac{\partial c_{(x)}}{\partial x} \right)_{x=0} = D \left(\frac{c_{bulk} - c_{(x=0)}}{\delta} \right)$$

$$i = nFAf_{(x=0)}$$

$$i = nFAD \frac{c_{bulk} - c_{(x=0)}}{\delta}$$

$$i_{lim} = nFAD \frac{c_{bulk}}{\delta}$$

$$i_t = \frac{nFAD c_t}{\delta}$$

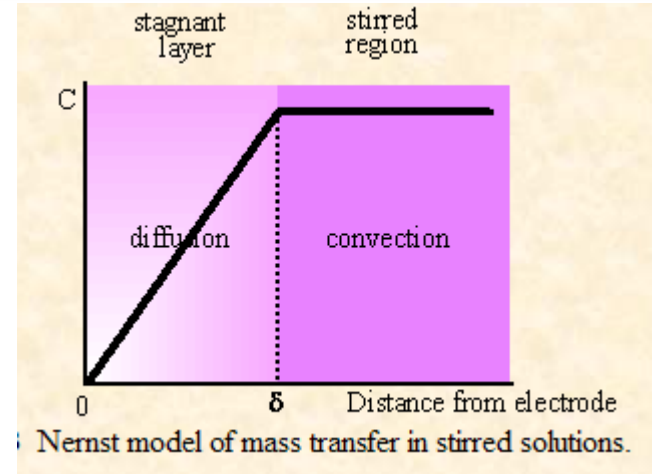

The Nernst diffusion layer δ is:

- independent of time
- inversely dependent on square root of stirring rate

POTENCIOSTATIC COULOMETRY

diffusion

$$i_t = \frac{n F A D c_t}{\delta}$$

where n number of electrons, Faraday constant $F = 96\,485 \text{ C.mol}^{-1}$, A electrode area [cm^2], D diffusion coefficient [$\text{cm}^2 \text{ s}^{-1}$], δ Nernst layer [cm]

$$c_t = \frac{i_t t}{n F V}$$

$$\frac{d c_t}{d t} = - \frac{i_t}{n F V}$$

$$\frac{d c_t}{d t} = - \frac{A D c_t}{\delta V}$$

$$c_t n F V = i_t t$$

$$\frac{d c_t}{c_t} = - \frac{A D}{\delta V} dt = - k dt$$

$$\ln c_t = \ln c_0 - kt$$

$$\ln I_t = \ln I_0 - kt$$

or

$$c_t = c_0 e^{-kt}$$

$$I_t = I_0 e^{-kt}$$

t time, i current, Q charge

Coulometric Methods

Potentiostatic Coulometry

2) Advantages:

- more specific than amperostatic coulometry
 - avoids redox of species that may interfere with amperostatic coulometry
- can be used for over 55 elements without major interference

3) Disadvantages

- does take longer than amperostatic titration
 - current (i) decreases with time
 - conversion becomes slower as less analyte around to oxidize or reduce

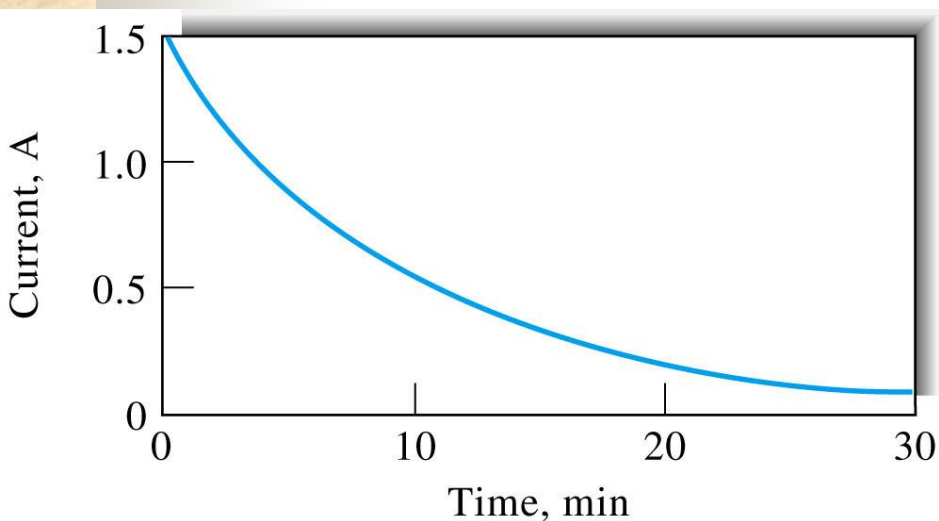

$$\frac{dc_t}{c_t} = -\left(\frac{AD}{\delta V}\right) dt = -k dt$$

$$I_t = I_o e^{-kt}$$
$$k = AD/\delta V$$

where:

D = diffusion coefficient

A = electrode surface area

V = volume

δ = thickness of the surface layer
where concentration gradient exists

Potentiostatic Coulometry

Basics:

-detection of analyte in solution by using Coulometry at fixed potential to quantitatively convert analyte to a given form

- current controlled by contents of cell.

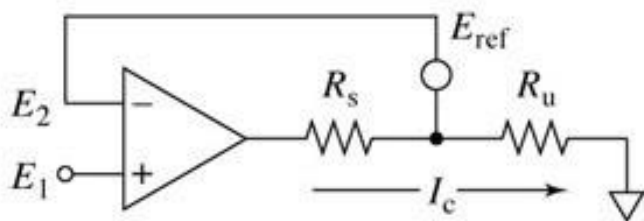

(a)

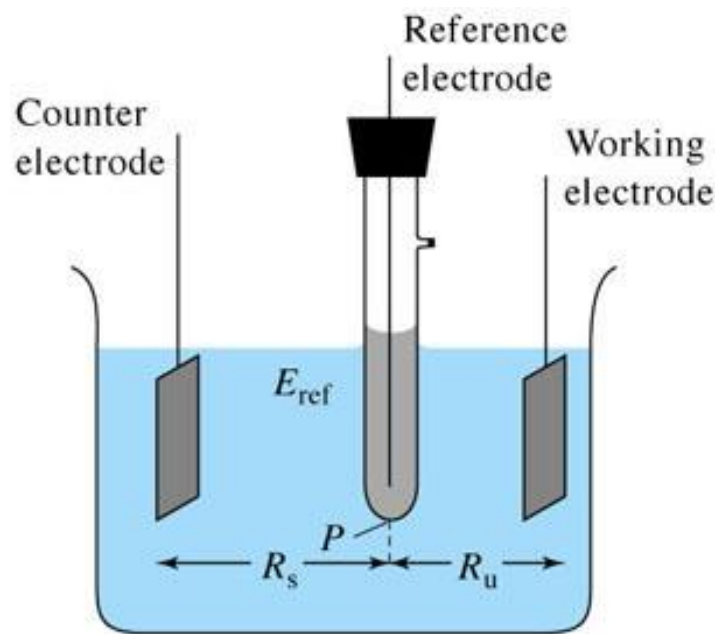

(b)

Coulometric Methods

Based on Measurement of Amount of Electricity (or charge, in coulombs) Required to Convert Analyte to Different Oxidation State

$$Q = It \quad \text{for constant current with time}$$

where:

Q = charge required (coulombs = A·s)

I = current (A)

t = time of current (s)

for variable current from 0 to t :

$$Q = \int_0^t Idt$$

Relate charge (coulombs, C) to moles of e⁻ passing electrode by Faraday constant

$$\text{Faraday (F)} = 96,485 \text{ Coulombs (C)/mole}$$

If know moles of e⁻ produced and stoichiometry of ½ cell reaction:



gives moles of analyte generated, consumed, etc.

Coulometric Methods

Coulometry: electrochemical method based on the quantitative oxidation or reduction of analyte

- measure amount of analyte by measuring amount of current and time required to complete reaction

$$\text{charge} = \text{current (i)} \times \text{time in coulombs}$$

- electrolytic method → external power added to system

Coulometric Titration:
of Cl^-

- use Ag electrode to produce Ag^+



- measure Ag^+ in solution by 2nd electrode
- only get complete circuit when Ag^+ exists in solution
- only occurs after all Cl^- is consumed
- by measuring amount of current and time required to complete reaction can determine amount of Cl^-

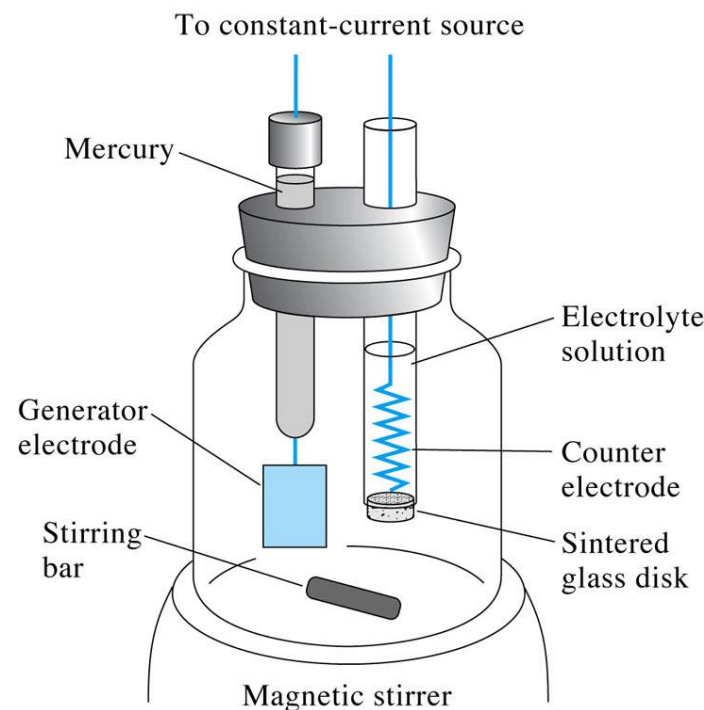

Coulometric Methods

Example : Constant current of 0.800 A (A) used to deposit Cu at the cathode and O_2 at anode of an electrolytic cell for 15.2 minutes. What quantity in grams is formed for each product?

Coulometric Methods

4) Two Types of Coulometric Methods

a) amperostatic (coulometric titration)

- most common of two

b) potentiostatic

Fundamental requirement for both methods is 100% current efficiency

- all e^- go to participate in the desired electrochemical process

- if not, then takes more current \rightarrow over-estimate amount of analyte

Amperostatic Methods (Coulometric Titrations)

1) Basics: titration of analyte in solution by using coulometry at constant current to generate a known quantity of titrant electrochemically

- potential set by contents of cell

- example:



- To detect endpoint, use 2nd electrode to detect buildup of titrant after endpoint.

Coulometric Methods

2) Applications

a) *Can be used for Acid-Base Titrations*

- Acid titration



- Base titration



b) *Can be used for Complexation Titrations (EDTA)*

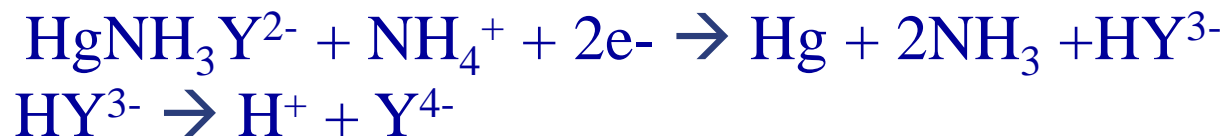

c) *Can be used for Redox Titrations*

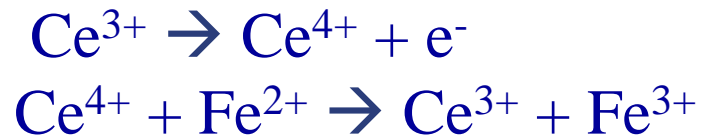

Coulometric Methods

3) Comparison of Coulometric and Volumetric Titration

a) Both have observable endpoint

- Current (e^- generation) serves same function as a standard titrant solution
- Time serves same function as volume delivered
- amount of analyte determined by combining capacity
- **reactions must be rapid, essentially complete and free of side reactions**

b) Advantages of Coulometry

- both time and current easy to measure to a high accuracy
- don't have to worry about titrant stability
- easier and more accurate for small quantities of reagent
 - small volumes of dilute solutions → problem with volumetric
- used for precipitation, complex formation oxidation/reduction or neutralization reactions
- readily automated

c) Sources of Error

- variation of current during electrolysis
- departure from 100% current efficiency
- error in measurement of current
- error in measurement of time
- titration error (difference in equivalence point and end point)

Comparison of Coulometric and Volumetric Titration

Coulometric vs Volumetric Titrations		
	Coulometric	Volumetric
Preparation of standard solutions	None	Yes
Standardization of titrant	None	Yes
Storage of titrant	None	Yes
Use of labile reagents	Trivial	Difficult
free KOH or NaOH titrants	Trivial	Possible
Dilution effects during titration	None	Yes
Addition of microquantities of analyte	Trivial	Difficult
Determination of microamounts of analyte	Yes	Difficult
Determination of microvolumes	Yes	Difficult
Accuracy of titration	High	O.K.
Economy of reagent	Maximal	Depends
Automation	Perfect	Possible
Remote control	Perfect	Possible
End-point detection	Same for both modes	
Price	Similar	

Coulometric Methods

4) Change in Potential During Amperostatic Methods

a) In constant current system, potential of cell will vary with time as analyte is consumed

- Cell “seeks out” electrochemical reactions capable of carrying the supplied current



- Nernst Equation

$$E_{\text{cathode}} = E^{\circ}_{\text{Cu}^{2+}/\text{Cu}} - 0.0592/2 \cdot \log (1/a_{\text{Cu}^{2+}})$$

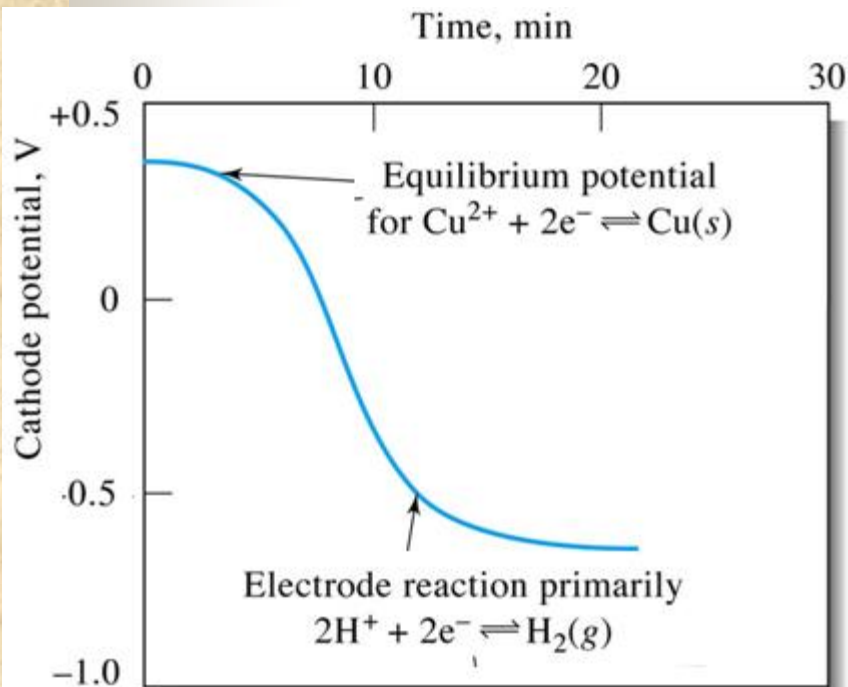

Note: E_{cathode} depends on $a_{\text{Cu}^{2+}}$. As $a_{\text{Cu}^{2+}}$ decreases \rightarrow (deposited by reaction) E_{cathode} decreases.

Coulometric Methods

4) Change in Potential During Amperostatic Methods

- when all Cu^{2+} is consumed, current is carried by another electrochemical reaction

& generation of H_2 (g) if reduction takes place



& breakdown of water if oxidation

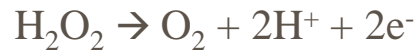

- not a problem as long as other species don't co-deposit

- or if have a large excess of species being used in titrant generation vs. titrated analyte

& Ag (s) vs. Cl^- in solution

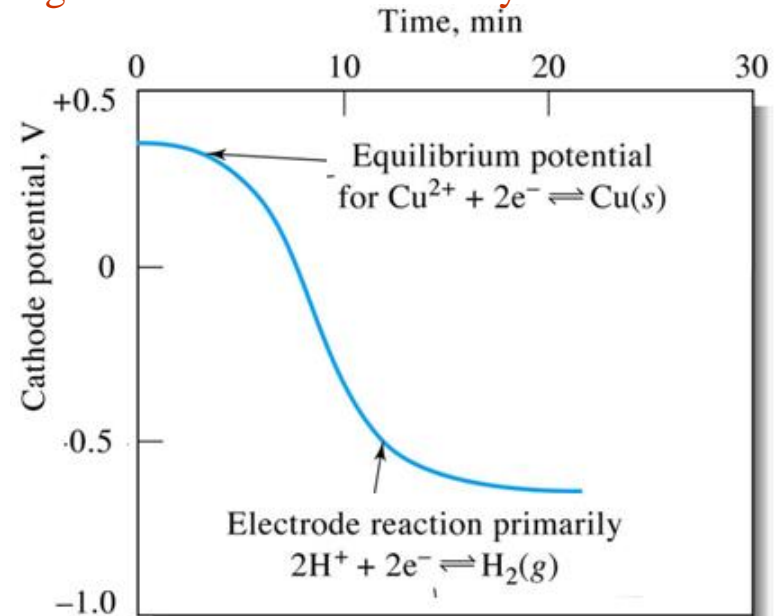



This will be exemplified by a **current-potential curve** obtained in stirred solution containing 10 mM KBr. Due to the stirring of the solution, a constant amount of electroactive material reaches the electrode and the plots are time independent. At potentials around +1.0 V vs SCE the oxidation of Br⁻ takes place; at more positive potentials water is oxidized. The oxidation of Br⁻ can proceed at a maximum current density of 5 mA/cm². If the current forced through the electrodes corresponds to a current density lower than that value, say 2.5 mA/cm² (dotted line (1)), the only reaction that takes place is the oxidation of Br⁻. If, however, a larger current density is applied, say 7.5 mA/cm² (dotted line (2)), only 5 mA/cm² are contributed by the oxidation of Br⁻. An additional 2.5 mA/cm² are due to the oxidation of water.

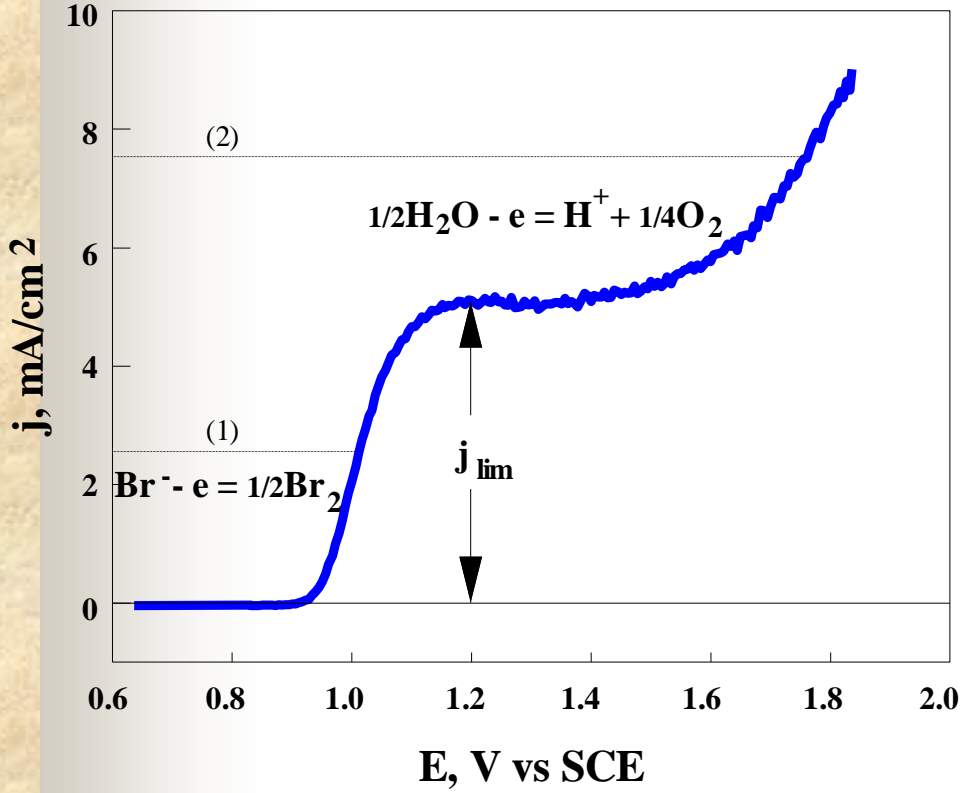

To ensure 100% current efficiency, the generation of titrant should be the only process, taking place at the generating (working) electrode. The current by which the titrant is generated has to be smaller than the limiting current of the electrode process of interest. If this condition is not maintained, some unwanted electrode process could take place and bring to the reduction of the current efficiency.

The problem is evident - the current efficiency of the generation of Br₂ is not 100% any more.

Experimental current-potential curve for oxidation of bromides at a rotating disk electrode. Composition of solution: 10 mM KBr, 60 mM HClO₄ and 0.1 M KNO₃. Area of the electrode: 0.16 cm². Rotating rate: 400 rpm.

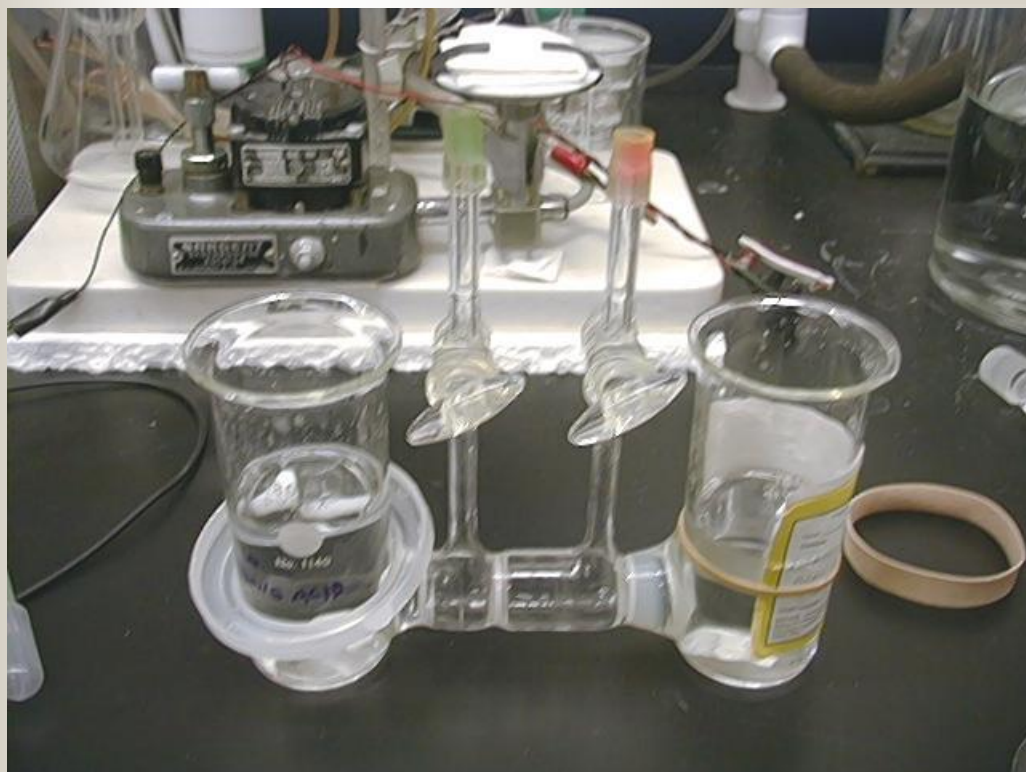

Microcoulometry -
0,05 ml (in a drop),
 $c = 10^{-11}$ až 10^{-9} g
 $1 \mu C$





INDIRECT COULOMETRY COULOMETRIC TITRATIONS

Basis

A low concentration of a 'titrant' is generated electrochemically at a constant rate from a high concentration of the oxidized or reduced form of the titrant.

As it is generated, it reacts stoichiometrically with the substance being determined.



COULOMETRIC TITRATIONS

- The technique of coulometric titration was originally developed by **L. Szebelledy and Z. Somogy** in 1938.
- The method **differs from volumetric titration** in that the titrant is generated in situ by electrolysis and then reacts stoichiometrically with the substance being determined.
- The **amount of substance** reacted is calculated from the total electrical charge passed, Q , in coulombs, and not, as in volumetric titration, from the volume of the titrant consumed.

Princip:

- ★ na pracovní elektrodě se z pomocné látky P konstantním proudem generuje činidlo X, s nímž analyt A reaguje na produkt Y:

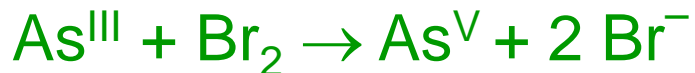

- ★ činidlo je generováno tak dlouho, aby s ním analyt právě kvantitativně zreagoval, tj. **byl jím ztitrován**
- ★ v elektrochemické cele musí být vhodný indikační systém (např. fotometrický, elektrody pro potenciometrickou, amperometrickou indikaci aj.)

AMPEROSTATIC COULOMETRY

Coulometric titration

Constant-current coulometry

CCC - is often used for coulometric titrations

***the titrant is generated** in the solution by the application of a constant current

***measurement** is made of the time of current generation, and the product of the current and the time yields coulombs $Q = I t$

*by application of Faraday's law, the equivalents of titrant can be calculated directly $m = A Q = A I t = (M/nF) I t$

***the electrode reaction proceeds with 100% current efficiency.** The titrant that is generated should react rapidly and stoichiometrically with the substance being determined.

- ★ obsah analytu se určí pomocí **Faradayova zákona** z množství činidla vygenerovaného nábojem $Q = I \cdot t$ a ze známé stechiometrie chemické reakce v roztoku

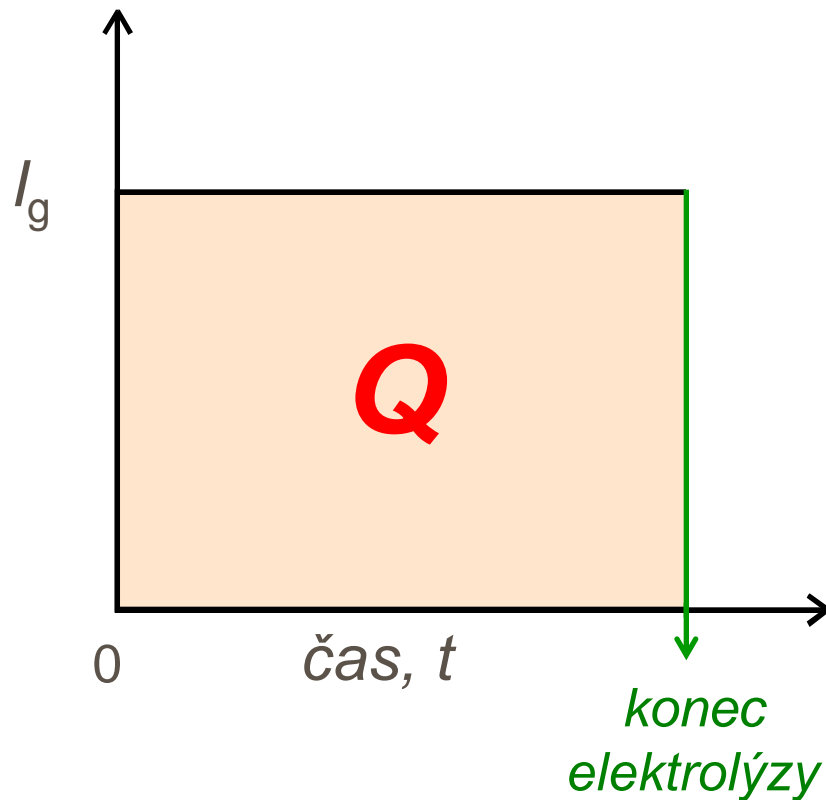

generation current ($10\text{mA}/\text{cm}^2$)

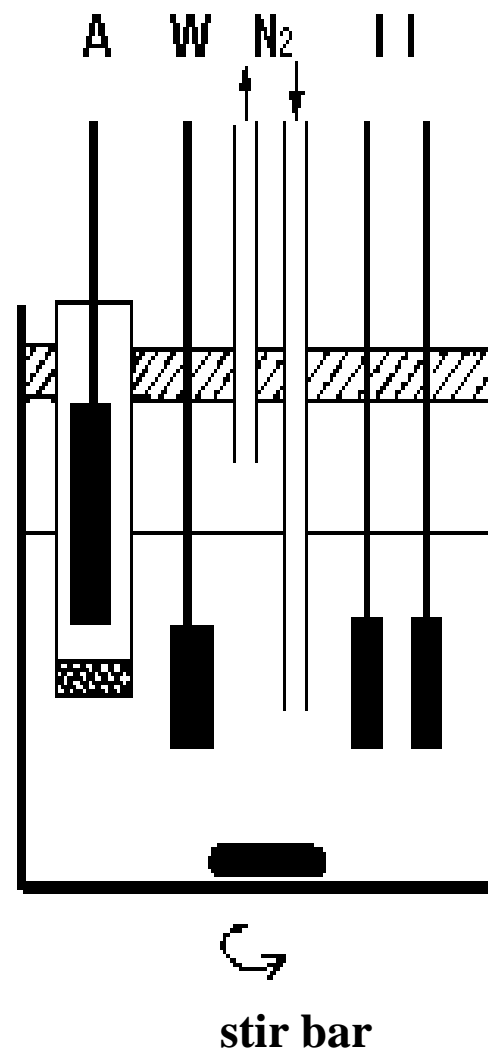
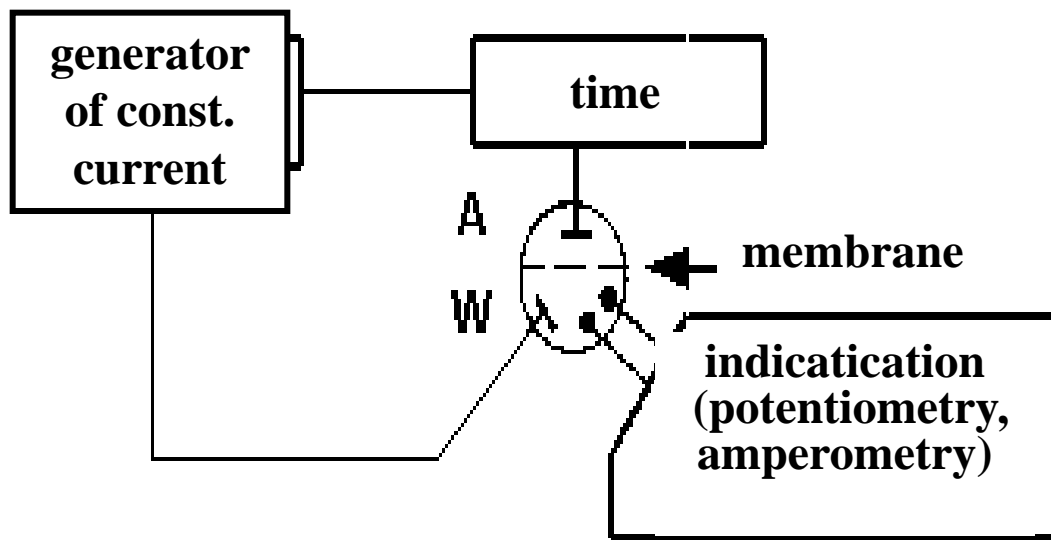



INDIRECT COULOMETRY COULOMETRIC TITRATIONS

The method overcomes

Difficulties associate with direct methods because of the high concentration of the titrant source.

Prevents side reactions

Increases reaction efficiency

The titrant need not be stable.



COULOMETRIC TITRATION EXPERIMENTS

- Coulometric analyses can in fact be carried out according to two different techniques: **controlled-current coulometry (galvanostatic coulometry)** or **controlled-potential coulometry (potentiostatic coulometry)**.
- A fundamental **requirement** for a coulometric titration is 100 percent current efficiency at the electrodes of the electrolysis cell.
- The reagent generated (**titrant**) must react stoichiometrically and preferably rapidly and irreversibly with the substance being determined (analyte).
- The reagent can be **generated in situ**, i.e. in the analysis solution, or **in an external vessel with continuous flow**. **In practice, most commonly used coulometric titrations allow the direct determination of substances that are not reduced or oxidized at the generator electrodes.**



COULOMETRIC TITRATIONS - requirements

- **100 % conversion or current efficiency** at the generator electrodes is, how can 100 % efficiency be ensured?no other reactions can take place - by controlling the applied voltage or through a suitable choice of the electrolyte.
- **The electrolyte solution** must be inert and have a sufficiently high concentration.
- **The geometry of the measuring cell and the stirrer speed** (rapid homogeneity of the analysis solution) also play a very important role. The reagent generated must be dispersed as rapidly as possible throughout the measuring cell. Efficient and rapid mixing of the analysis solution with the titrant leads to steady state conditions at the electrodes (sensors) being attained more quickly.
- **The electrode material** of the generator electrodes and their arrangement in the measuring cell are important.
- **The hydrogen overvoltage** - on mercury and platinum. Platinum is also suitable as an electrode substrate because it is chemically stable and corrosion-resistant in most electrolyte solutions.

COULOMETRIC TITRATIONS - advantages

- the equivalence point or end point of a coulometric titration can be determined as in any other titration (color indication, potentiometry, amperometry)
- constant current sources for the generation of titrants are relatively easy to make
- the electrochemical generation of a titrant is much more sensitive and can be much more accurately controlled than the mechanical addition of titrant using a burette ($I=10\ \mu\text{A}$ for $100\text{ms} \sim 10^{-8}$ mol or few micrograms of titrant)
- the preparation of standard solutions and titer determination is no necessary
- chemical substances that are unstable or difficult to handle because of their high volatility or reactivity in solution can also very easily be used as titrants (bromine, chlorine, Ti^{3+} , Sn^{2+} , Cr^{2+} and Karl Fischer reagents - iodine)
- are easier to automate because a source of current is appreciably easier to control than a burette drive
- can also be performed under inert atmosphere or be remotely controlled, e.g. with radioactive substances
- dilution effects due to the addition of the titrant are of no importance.

TITRATIONS

equivalence point = end point = titration stop
chemical reaction and steady state methods

<u>methods</u>	<u>controlled parameter</u>	<u>measured function</u>
Amperometric titration	E	$I = f(V)$
Biamperometric titration	U	$I = f(V)$
Potentiometric titration	I	$E = f(V)$
Bipotentiometric titration	I	$U = f(V)$
Coulometric titration	I	$Q = f(V) \quad I = f(t)$

BIAMPEROMETRIC TITRATIONS

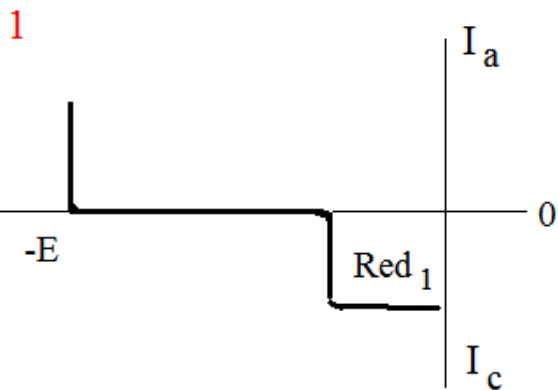

Fe^{2+} (Red_1) rev
 Fe^{3+} (Ox_1)

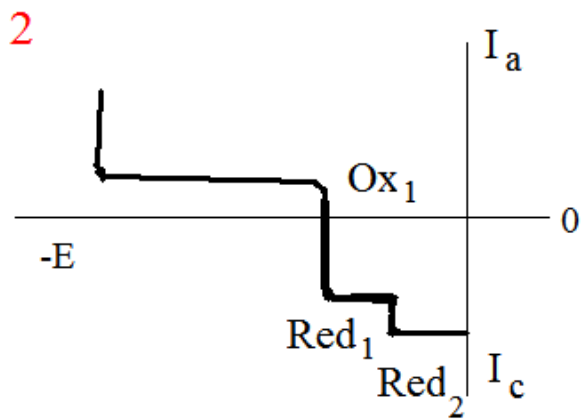

Mn^{7+} (Ox_2) irrev
 Mn^{2+} (Red_2)

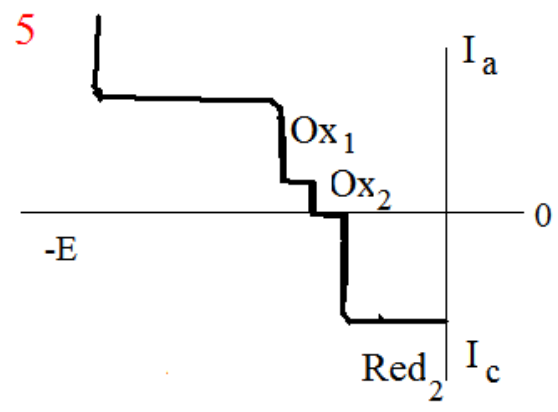
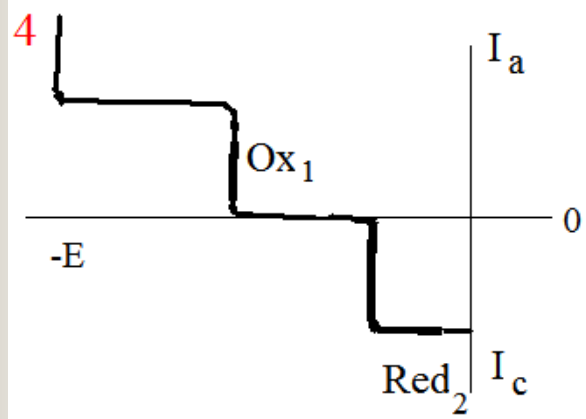
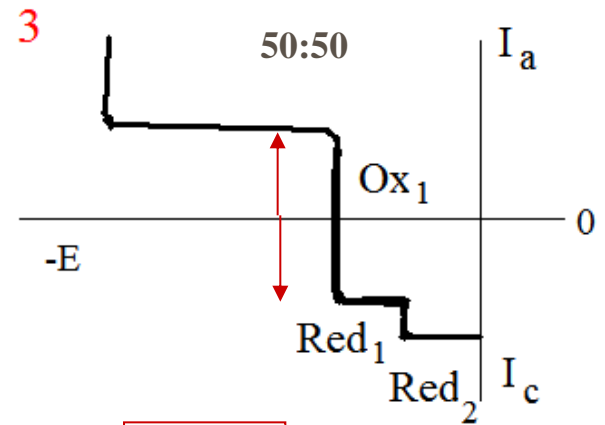

BIAMPEROMETRIC TITRATIONS

rev

by

irrev

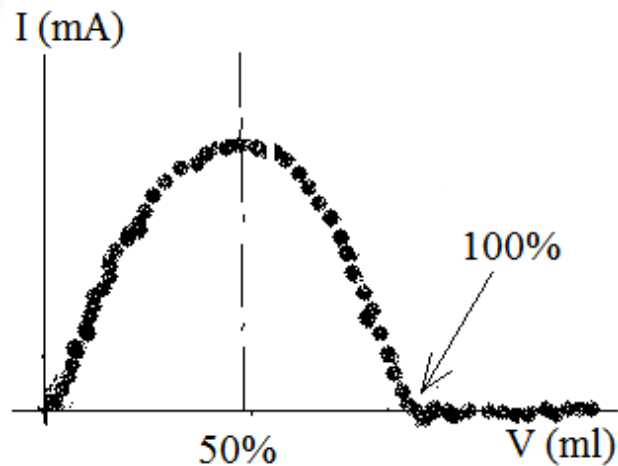

3

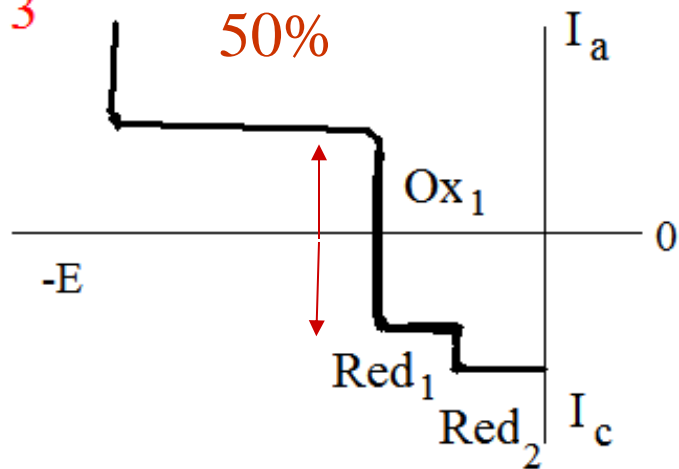

4

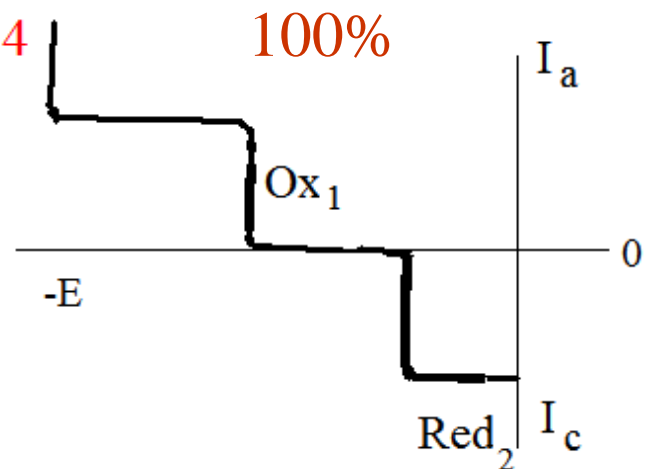

BIAMPEROMETRIC TITRATIONS

rev

by

rev

irrev

by

rev

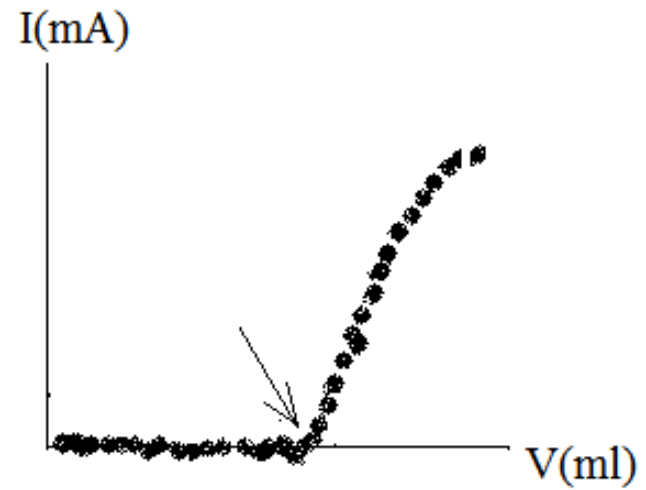
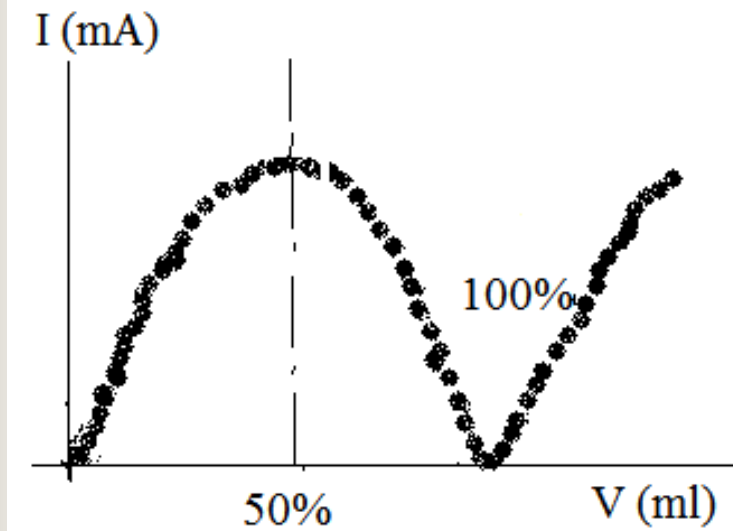

BIPOTENTIOMETRIC TITRATIONS

Two electrodes – as in biamperometric titrations

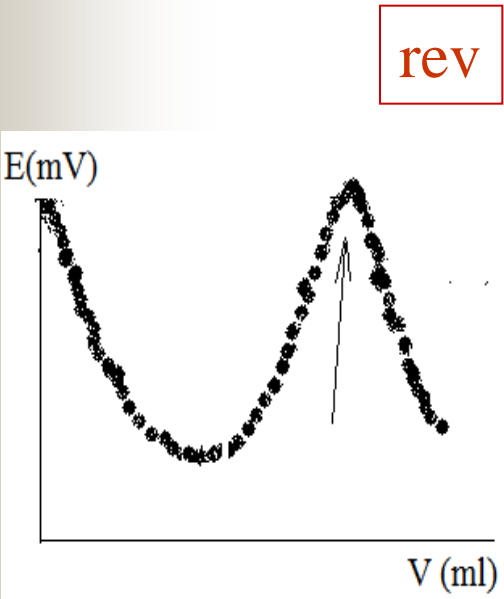

by

rev

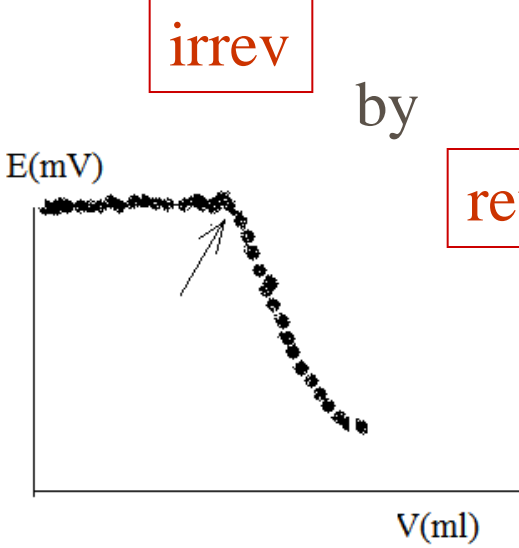

by

rev

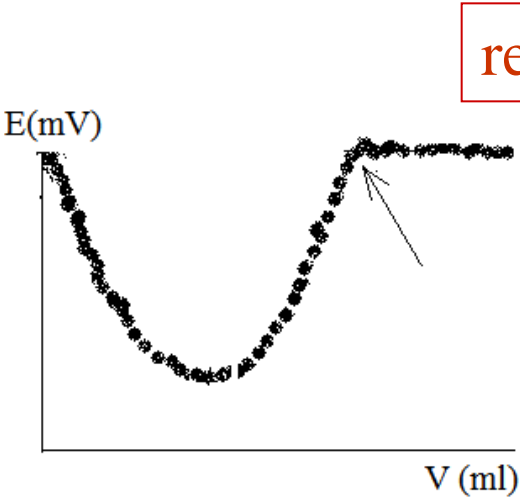

by

irrev

COULOMETRIC TITRATIONS

$I = \text{const.}$ Primary coulometric titration
Secondary coulometric titration

on working electrode

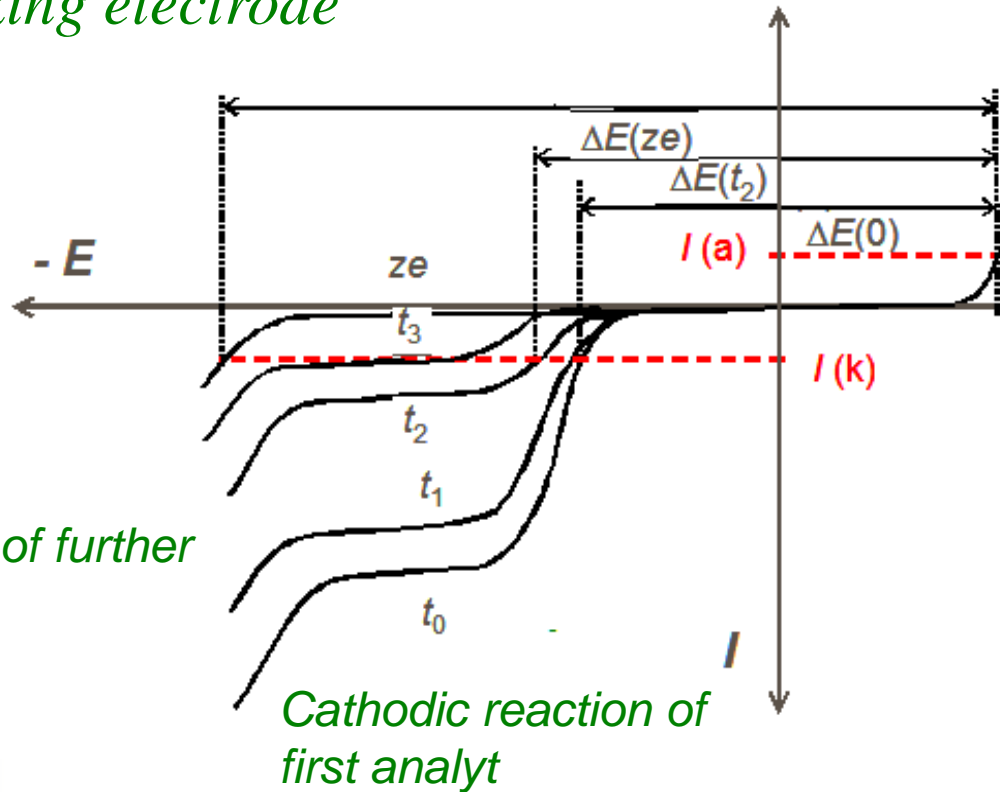

Amperostatic coulometry

Coulometric titrations

Analyt	Reakce na generační elektrodě
kyseliny, S, C v ocelích i organických látkách (po převedení na příslušné kyseliny)	$2\text{H}_2\text{O} + 2\text{e} \rightarrow 2\text{OH}^- + \text{H}_2$
anorg. zásady, aminy	$\text{H}_2\text{O} \rightarrow 2\text{H}^+ + 1/2\text{O}_2 + 2\text{e}$
Cl^- , Br^- , I^- , thioly, thiomocovina (argentometrie)	$\text{Ag} \rightarrow \text{Ag}^+ + \text{e}$
As^{3+} , Sb^{3+} , SO_2 , fenoly, thioly, nenasyc. slouč. ...	$2\text{Br}^- \rightarrow \text{Br}_2 + 2\text{e}$
As^{3+} , $\text{S}_2\text{O}_3^{2-}$, H_2S , H_2O (dle K.Fischera), kys. askorbová...	$2\text{I}^- \rightarrow \text{I}_2 + 2\text{e}$
Fe^{3+} , V^{5+} , U^{6+} ...	$\text{TiO}^{2+} + 2\text{H}^+ + \text{e} \rightarrow \text{Ti}^{3+} + \text{H}_2\text{O}$
Ca^{2+} , Cu^{2+} , Pb^{2+} , Zn^{2+} ... (chelatometrie)	$\text{HgY}^{2-} + 2\text{H}^+ + 2\text{e} \rightarrow \text{Hg}(\text{l}) + \text{H}_2\text{Y}^{2-}$



Výhody coulometrických titrací:

- snadná titrace i **málo stálými a těkavými činidly** (Br_2 , Ti^{3+});
- činidla **není nutno standardizovat** (standardem je Faradayova konstanta);
- lze stanovovat **nižší koncentrace analytů** než klasickou volumetrií
- metodu lze snadno **automatizovat**

Analyzátor solí

Model SAT-210,

DKK-TOA Corporation,
Japonsko

stanovení:

NaCl nebo chloridů

Indikace ekvivalence:

potenciometrická

Rychlost analýzy:

25 s (1% standard
NaCl)



Coulometrický analyzátor vody metodou Karl Fischer

Cou-Lo Compact

GR Scientific

Bedfordshire, UK

Indikace ekvivalence

Měřicí rozsah:

1 µg - 100mg H₂O



Princip:

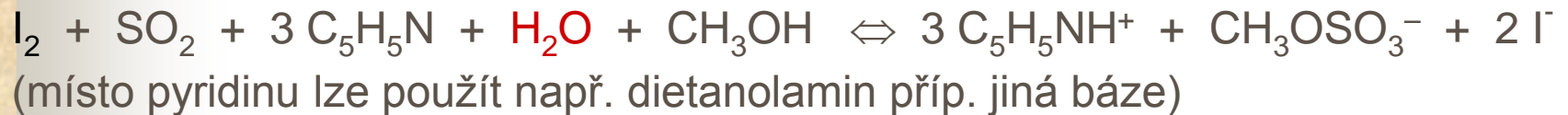

The Karl Fischer reaction uses a coulometric titration to determine the amount of water in a sample. It can determine concentrations of water on the order of milligrams per liter. It is used to find the amount of water in substances such as butter, sugar, cheese, paper, and petroleum.

Karl Fischer

It is the same reaction as the iodometric titration of sulphur dioxide in water.



However, in order to shift the equilibrium to the right, it was necessary to neutralise the acids produced. Originally pyridine was used as the neutralising base.

The Pt anode generates I_2 . The next reaction is oxidation of SO_2 by I_2 . One mole of I_2 is consumed for each mole of H_2O . In other words, 2 moles of electrons are consumed per mole of water.



The end point is detected most commonly by a bipotentiometric method.

The amount of current needed to generate I_2 and reach the end point can then be used to calculate the amount of water in the original sample.



titrovaná látka	titrační činidlo	základní elektrolyt	pracovní elektroda	indikace
anilín	Br ₂	KBr, HAc/H ₂ O/Py	Pt	biamperometricky
As(III)	Br ₂	KBr, H ₂ SO ₄	GC	potenciometricky aj biamperometricky
NH ₃ (Kjeldahl)	Br ₂	borax, HCl, KBr	Pt	biamperometricky mg až μ g
Ti(IV)	Cr ²⁺	HBr, CrBr ₃	Hg	amperometricky 0,5 mg
hydrochinon, izoniacid, rezorcín	Ag ⁺	AgNO ₃ , HNO ₃ -10 ° C	Au	potenciometricky, biamperometricky sub mg
α -tokoferol	VO ₄ ³⁻	VOSO ₄ v CH ₃ COOH	Pt	amperometricky 0,1 - 2 mg
hydrochinon ☞ obr. 8.5	Co ³⁺	Co(CH ₃ COO) ₂ , CH ₃ COONa (bezvodý) v CH ₃ COOH	GC	biamperometricky sub mg

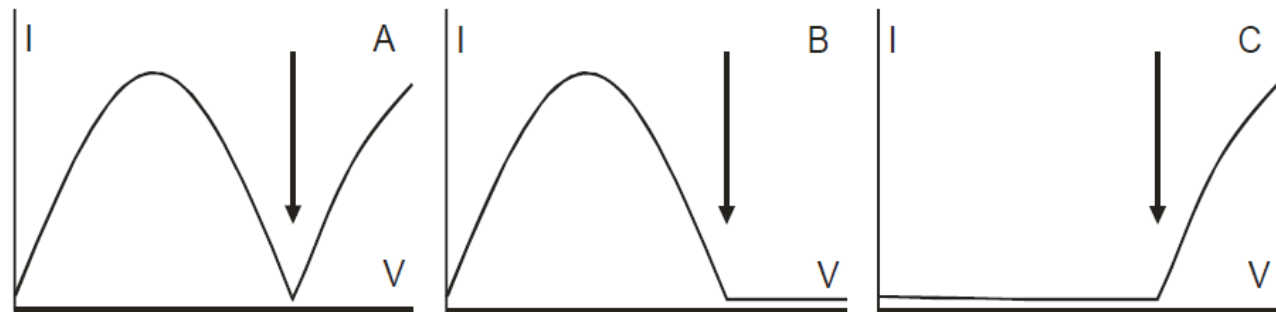

Obrázek 2: Biamperometrické titrační křivky. Na ose Y je vynesena indikační proud, na ose X je vynesena objem titračního činidla (v případě klasických titrací) či čas (v případě coulometrických titrací). Vyhodnocení konce titrace je naznačeno šipkou.

- A: titrace reverzibilního systému reverzibilním
- B: titrace reverzibilního systému ireverzibilním
- C: titrace ireverzibilního systému reverzibilním

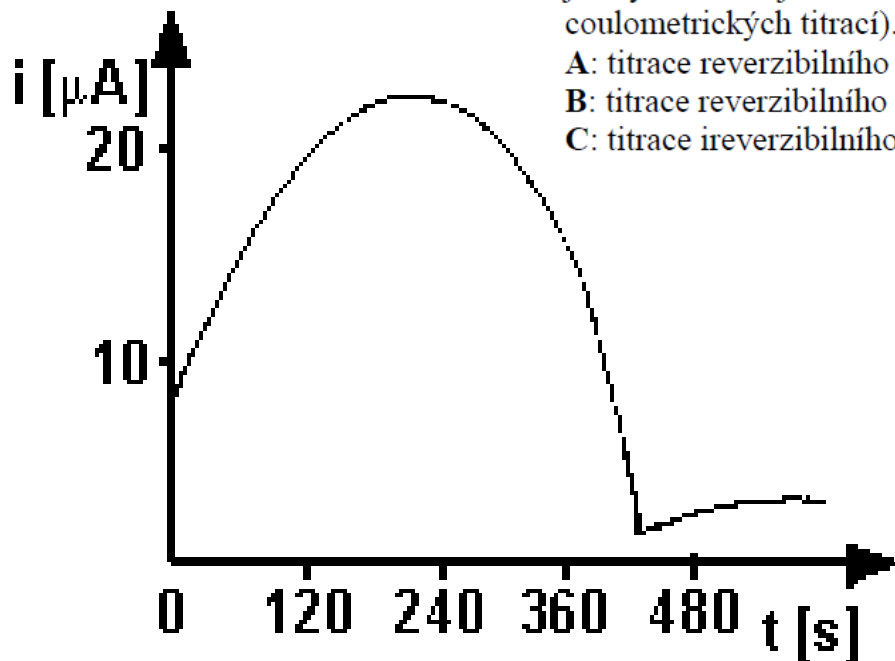

Biamperometrická titrační křivka získaná při coulometrickém stanovení hydrochinonu coulometricky generovaným Co^{3+} z nasyceného roztoku $(\text{CH}_3\text{COO})_2\text{Co}$ v prostředí bezvodé CH_3COOH - T.J. Pastor, V.V. Antonijevic, J. Barek, *Mikrochim. Acta* 117, 153 (1995).

CHRONOCOULOMETRY - CC

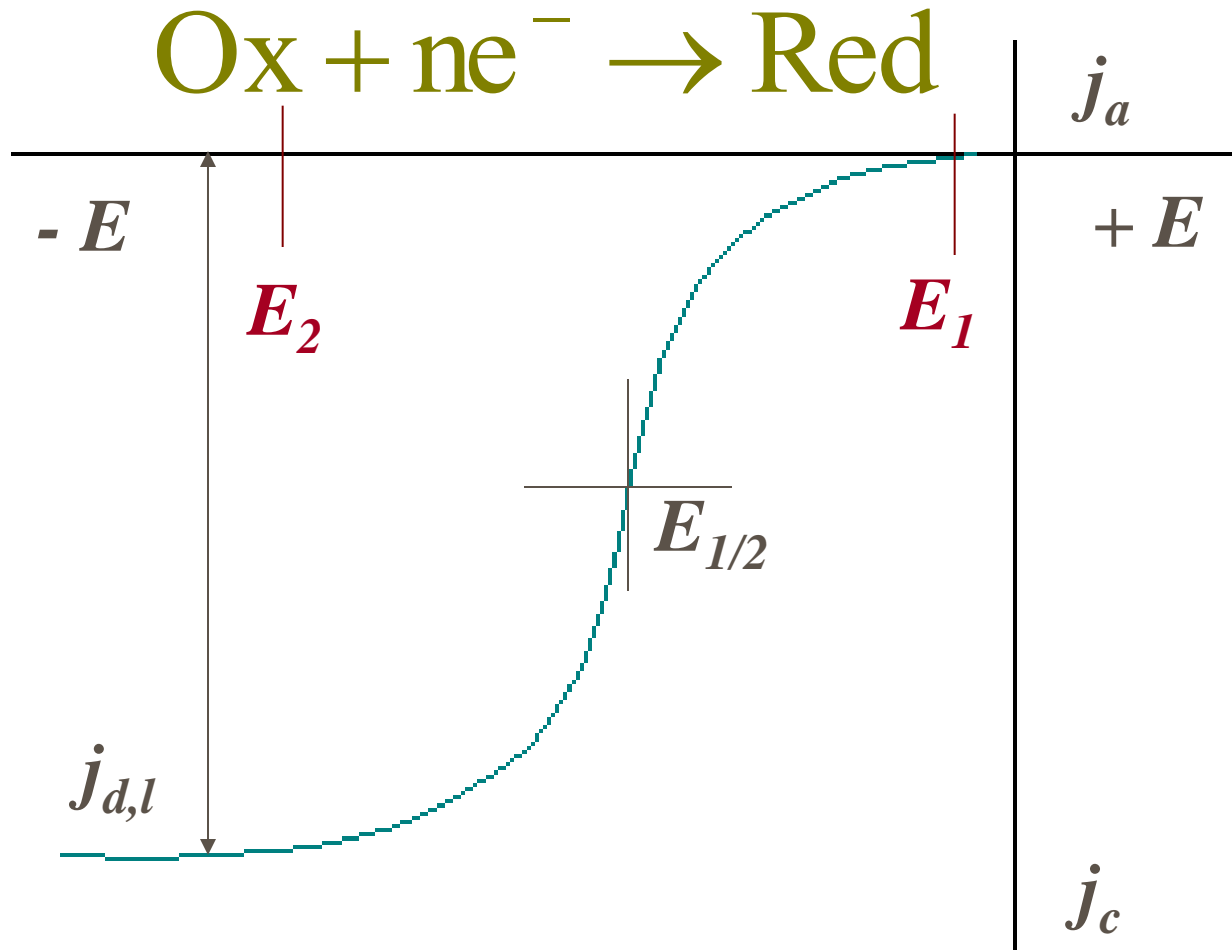

Steady-state current-potential curve for reduction of a oxidant (Ox)

unstirred solution

CHRONOCOULOMETRY - CC

CC involves measurement of the charge vs. time response to an applied potential step

CC is useful for measuring

- 1) electrode surface areas
- 2) diffusion coefficients
- 3) the time window of an electrochemical cell
- 4) adsorption of electroactive species
- 5) mechanisms and rate constants for chemical reactions coupled to ET reactions

Chronocoulogram – the shape of the resulting chronocoulogram can be understood by considering **the concentration gradient** in the solution adjacent to the electrode surface

the current from E₁ to E₂

Cottrell equation $I(t) = I_d(t) = \frac{nFAD^{1/2} c_\infty}{(\pi t)^{1/2}}$

the **Cottrell plot** - the plot of Q vs. $t^{-1/2}$

$$Q_d = \int_0^t I_d(t) dt$$

$$Q = \int_0^t \frac{nFAD^{1/2} c_\infty}{(\pi t)^{1/2}} dt$$

$$Q = \frac{2nFAD^{1/2} t^{1/2} c_\infty}{\pi^{1/2}}$$

the **Anson plot** - the plot of Q vs. $t^{1/2}$

Single step chronocoulometry

The real electrode surface area can be determined.

The used relationship for the plot slope is valid for diffusion to a **disk** working electrode and it **should be modified** in case of **any other working electrode geometry**.



A plot of **Q vs. $t^{1/2}$** transforms the data into a linear relationship whose slope is $2nAFcD^{1/2}/\pi^{1/2}$ where $n=1$ is the number of electrons transferred in a single electron transfer act, A is a real electrode surface area and F , c , D are the Faraday constant, ferricyanide concentration and ferricyanide diffusion coefficient ($D = 7.6 \times 10^{-6} \text{ cm}^2 \text{ s}^{-1}$).

The analysis of chronocoulometry (**CC**) data is based on **the Anson equation**, which defines the charge-time dependence for linear diffusion control: $Q = 2nFACD^{1/2}\pi^{-1/2}t^{1/2}$

Single step chronocoulometry

Typical waveform of a potential step experiment



E_1, E_2 potentials

Typical chronoamperometric response

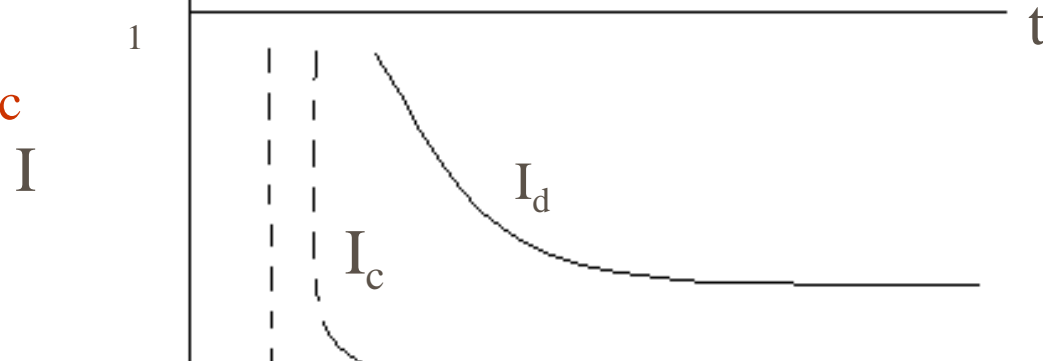

I_c capacity current

I_d diffusion current

Typical chronocoulometric response

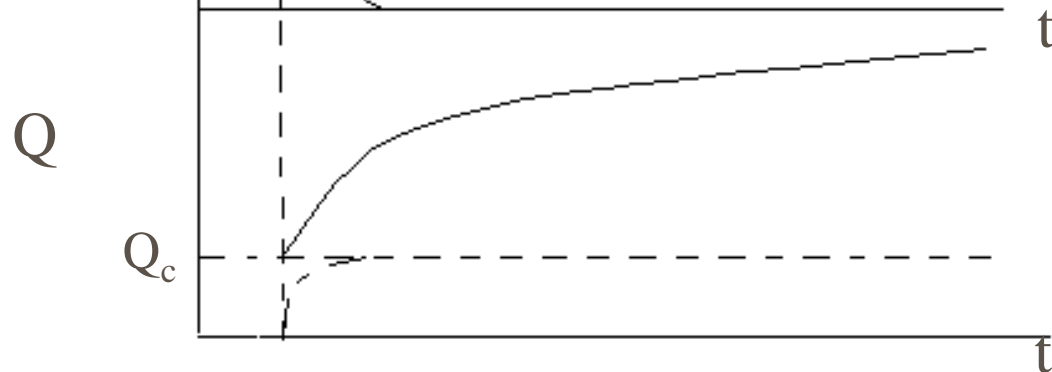

Q_c capacity charge

Single step chronocoulometry

potential step	$E = E_2 - E_1$
capacitive charge	$Q_C = Q_{dl} = EC_{dl}(1 - e^{-t/R_s C_{dl}})$
time constant	$\tau = R_s C_d$
total charge	$Q(t) = Q_d(t) + Q_C(t) + Q_{ads}(t)$
adsorptive charge	$Q_{ads}(t) = nF\Gamma_{Ox}$

estimation of surface concentration

$$Q(t) = 2nFAD^{1/2}\pi^{-1/2}t^{1/2} + EC_{dl}(1 - e^{-t/R_s C_{dl}}) + nFA\Gamma_{Ox}$$

Q_d = charge due to electrolysis of solution species

Q_{ads} = charge due to electrolysis of adsorbed species

Q_C or Q_{dl} = double-layer charging

Γ_{ox} = surface concentration of adsorbed species (mol cm⁻²)

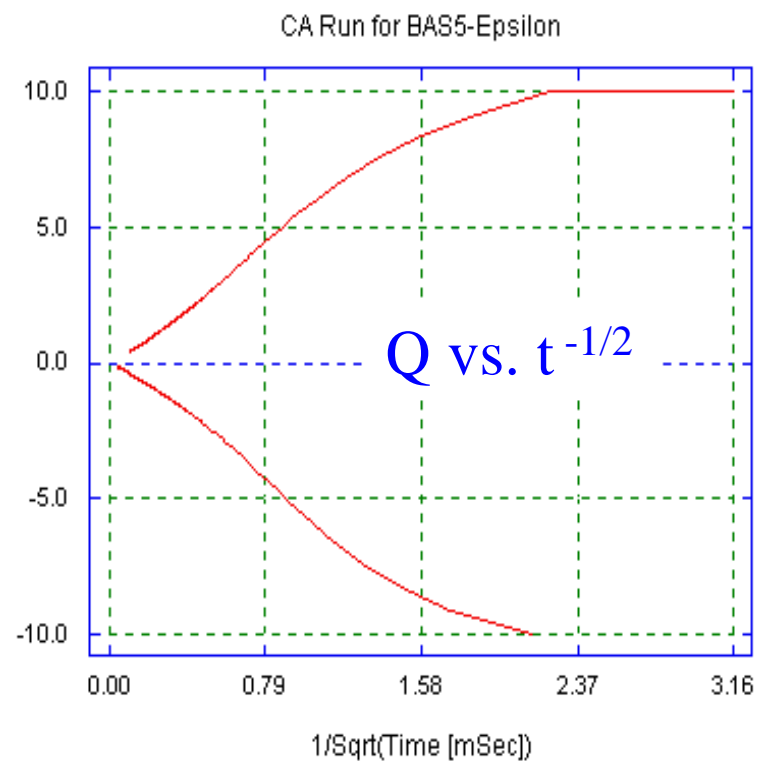

Cottrell plot for a chronoamperometry experiment

Single step chronocoulometry

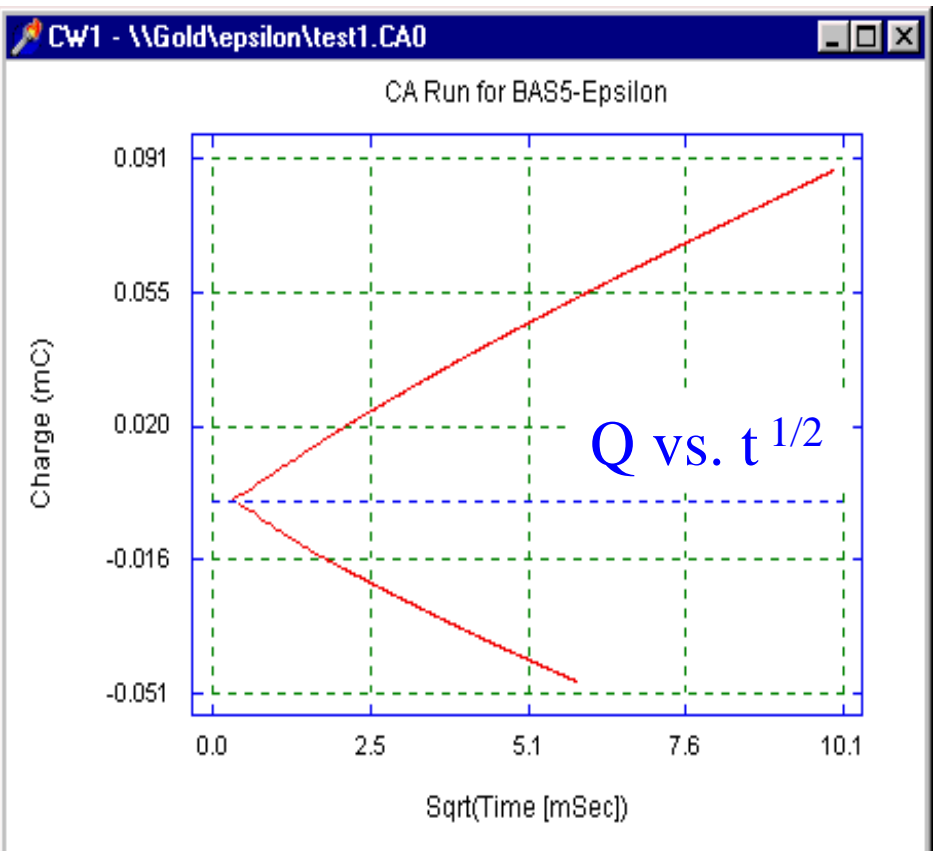

Anson plot for a chronocoulometry experiment

Single step chronocoulometry

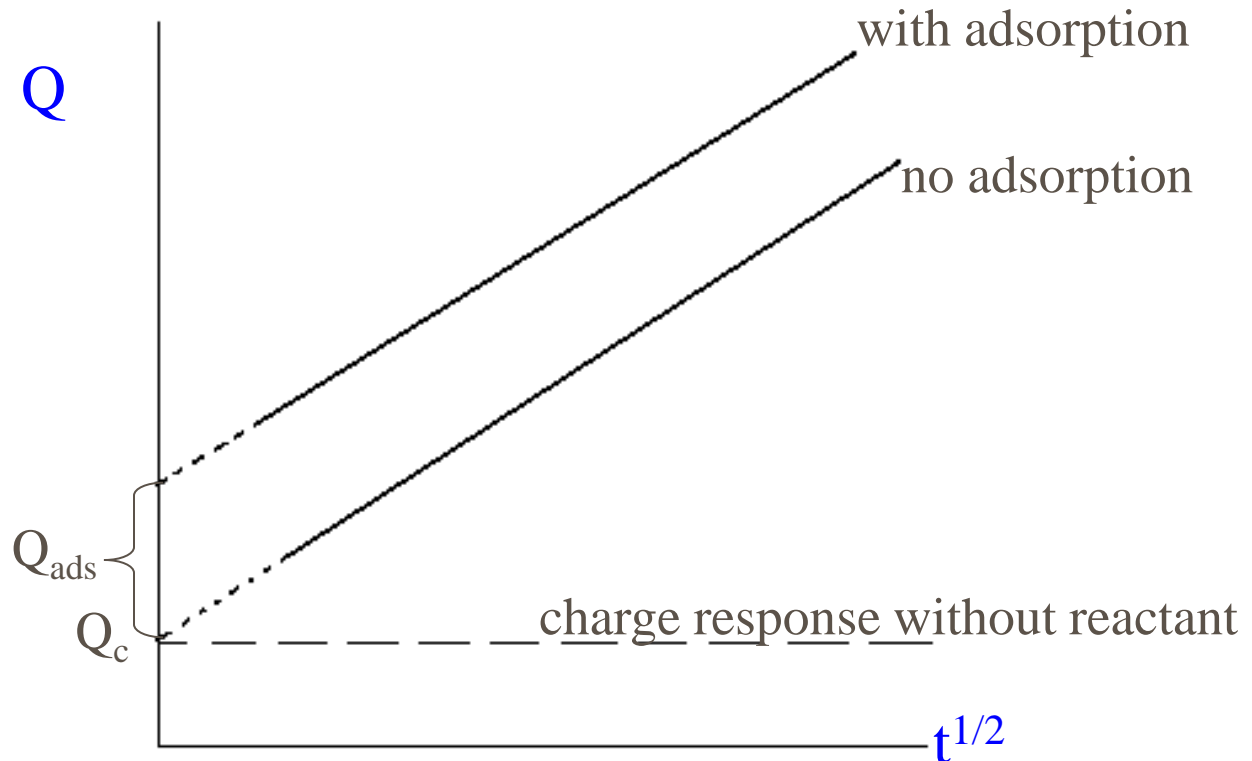

CC charge vs. time^{1/2} plot

problem : at short times this plot is not linear

Single step chronocoulometry

The **intercept** of the Anson plot is **the sum of Q_{dl} and Q_{ads}** . One method for eliminating Q_{dl} from the equation is to run **the identical experiment on the electrolyte alone**. However, this approach assumes that Q_{dl} is the same both in the presence and in the absence of the adsorbed analyte, which is generally not a valid assumption. The alternative method is to use the double potential step experiment. If only one of O and R adsorbs, then Q_{ads} is the difference of the intercepts of the **Anson plots** for the two steps.

Data from the later time domains of the experiment are being used to investigate behavior that occurred at early time points. This shows that integration retains **information about electrolysis that occurs essentially simultaneously with the potential step**. This is a major advantage of **CC**, since direct measurement of such behavior is generally very difficult.

In all the above applications, the initial potential is at a value at which electrolysis does not occur, and the step potential is at a value at which electrolysis occurs at a diffusion-controlled rate (the second step is generally from the step potential back to the initial potential). Therefore, **before these potentials can be determined, the redox potential must first be known**. In general, the simplest way to find these potentials is to **record the cyclic voltammogram of the analyte**.

Double step chronocoulometry

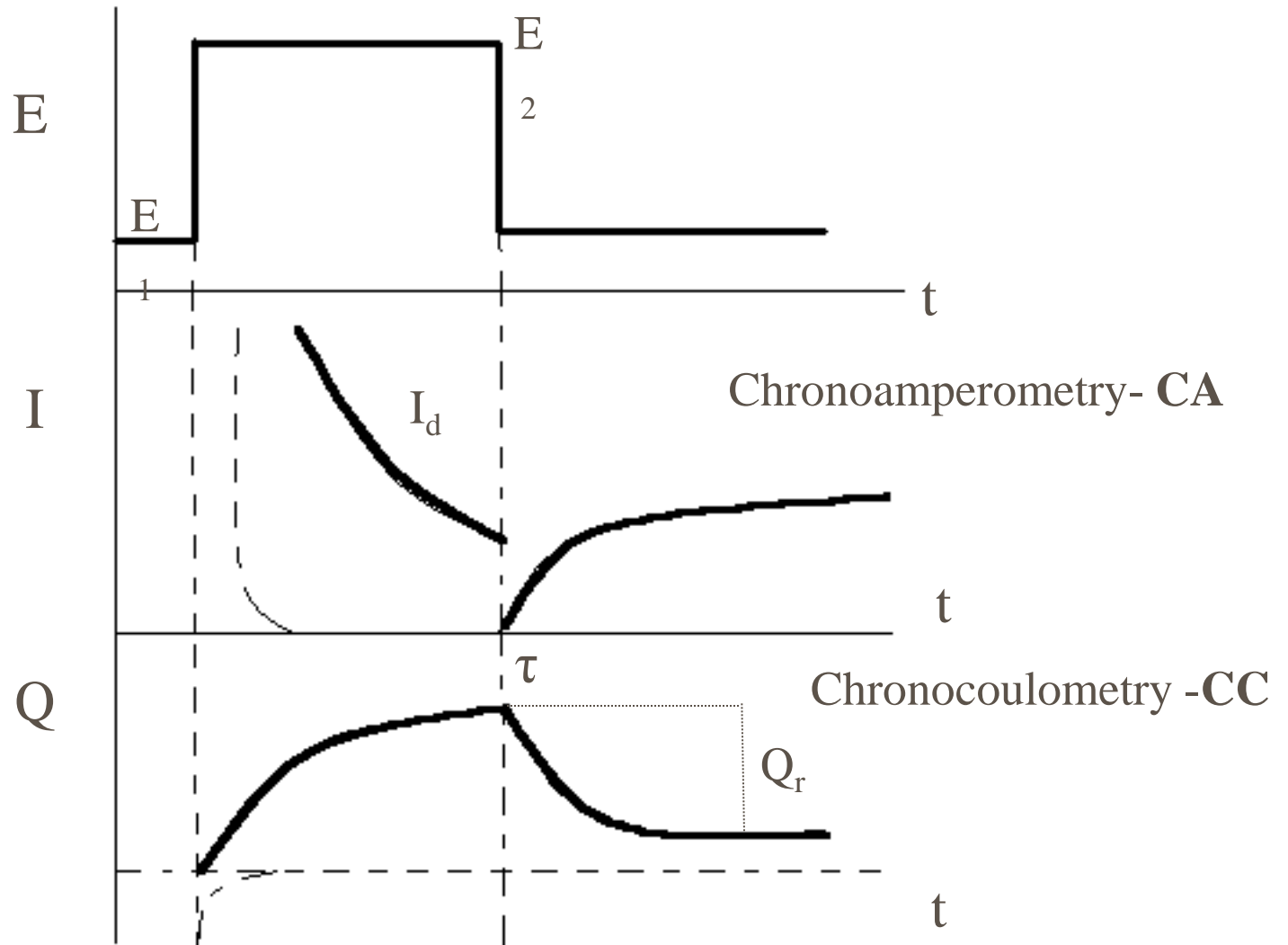

Double step chronocoulometry

Chronocoulometry (CC) and Chronoamperometry (CA)

Initial Potential - First Step Potential - First Step Time

Final Potential - Second Step Potential - Second Step Time

adsorption phenomena

kinetics of coupled homogeneous reactions

capacity contribution

$$I(t) = I_d(t) \tau = \frac{nFAD_{Red}^{1/2} c_{Red}}{\pi^{1/2}} \left[\frac{1}{(t-\tau)^{1/2}} - \frac{1}{t^{1/2}} \right]$$

$$Q(t) \tau = \frac{2nFAD_{Red}^{1/2} c_{Red}}{\pi^{1/2}} \left[\tau^{1/2} + (t-\tau)^{1/2} \right]$$

Double step chronocoulometry

$$I(t) = I_d(t) \tau = \frac{nFAD_{Red}^{1/2} c_{Red}}{\pi^{1/2}} \left[\frac{1}{(t-\tau)^{1/2}} - \frac{1}{t^{1/2}} \right]$$

$$Q(t) \tau = \frac{2nFAD_{Red}^{1/2} c_{Red}}{\pi^{1/2}} \left[\tau^{1/2} + (t-\tau)^{1/2} \right]$$

reversal step

$$Q(t) \tau, r = Q(\tau) - Q(t) \tau$$

$$Q(t) \tau, r = \frac{2nFAD_{Red}^{1/2} c_{Red}}{\pi^{1/2}} \left[\tau^{1/2} + (t-\tau)^{1/2} - t^{1/2} \right]$$

Double step chronocoulometry

plotting

$Q(t < \tau) \text{ vs. } t^{1/2}$

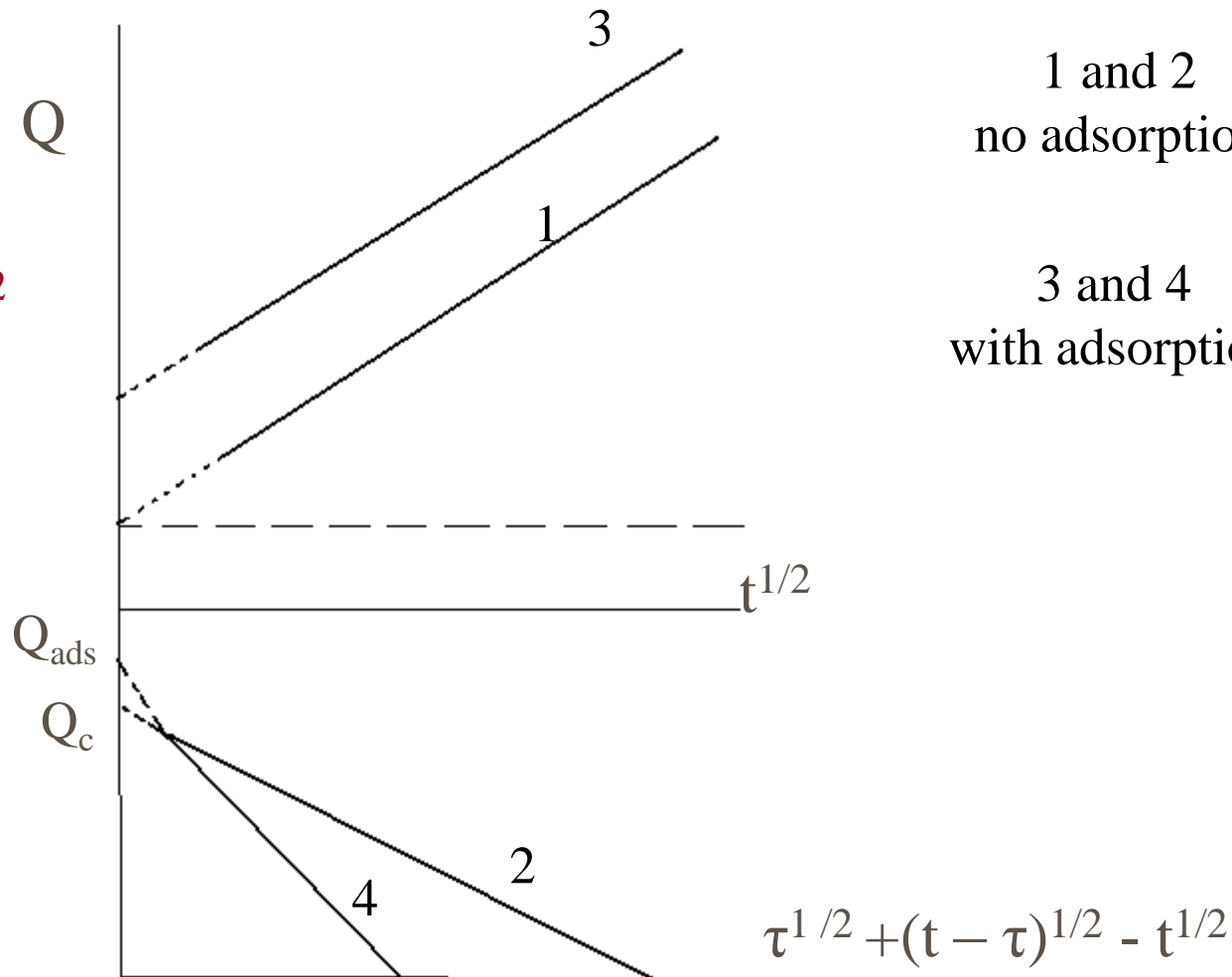

$Q(t > \tau), r \text{ vs. } [\tau^{1/2} + (t - \tau)^{1/2} - t^{1/2}]$

CA Run for BAS5-Epsilon

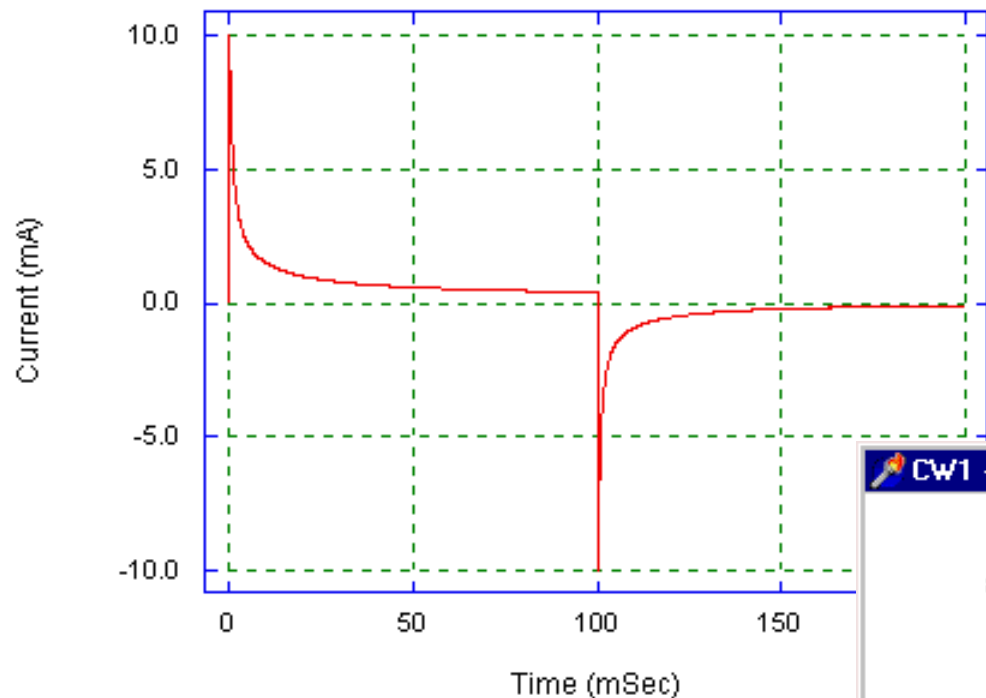

67 : 8.3

IUPAC

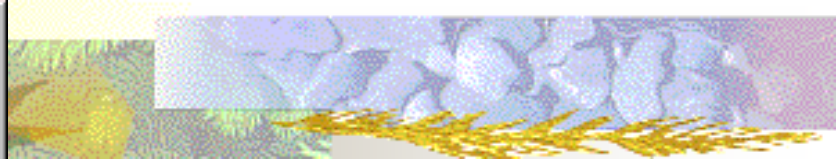

CA Run for BAS5-Epsilon

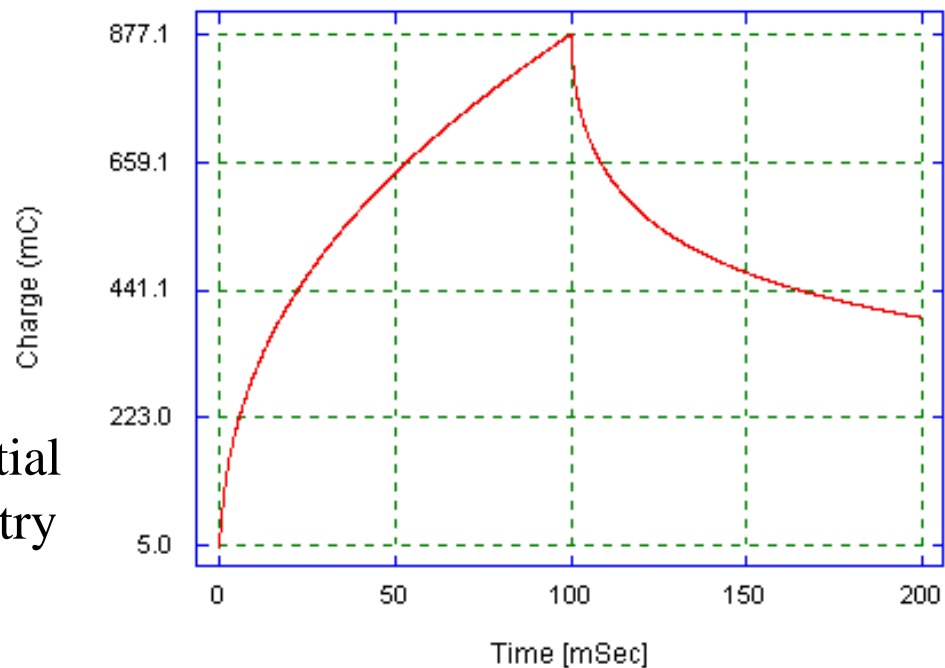

194 : 251.4

IUPAC

Charge-time response for a double-potential step chronocoulometry/chronoamperometry experiment.

CHRONOCOULOMETRY

Advantages

- the later of transient part can be detected more accurately
- the better signal-to-noise ratio (integral)
- the contribution of charging/discharging to the overall charge as a function of time can be distinguished from the diffusing electroreactants

Disadvantages

- practical problems
 - relatively long period of time (straightforward data evolution)
 - the decay of the current belonging to the DL charging should be very fast ($R_s = 1 \Omega$, $C_d = 20 \mu\text{F}$, $\tau = 20 \mu\text{s}$, 96% I_c for 60 μs)
($R_s = 1000 \Omega$, $C_d = 200 \mu\text{F}$, $\tau = 200 \text{ms}$, 96% I_c for 1 s
→ the distortion of the reliable part of the chronoamperometric response)
 R_s should be lower and A should be small
- the good potentiostat (single step and double step technique)

Polarization curves for diffusion controlled processes

$$E = E_c^o + \frac{RT}{nF} \ln \frac{\kappa_{Red}}{\kappa_{Ox}} + \frac{RT}{nF} \ln \frac{j_{dl} - j}{j}$$

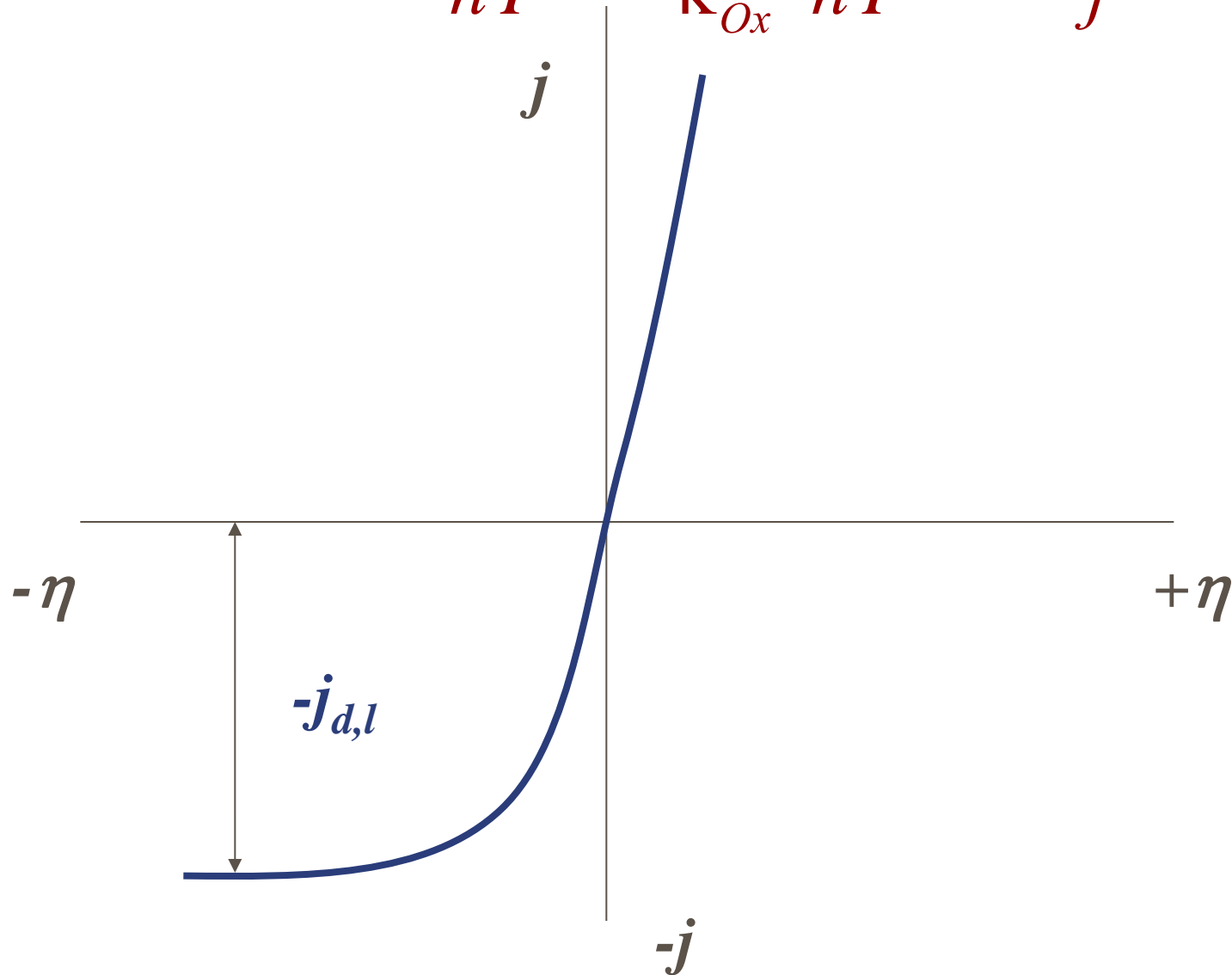

Polarization curves for diffusion controlled processes

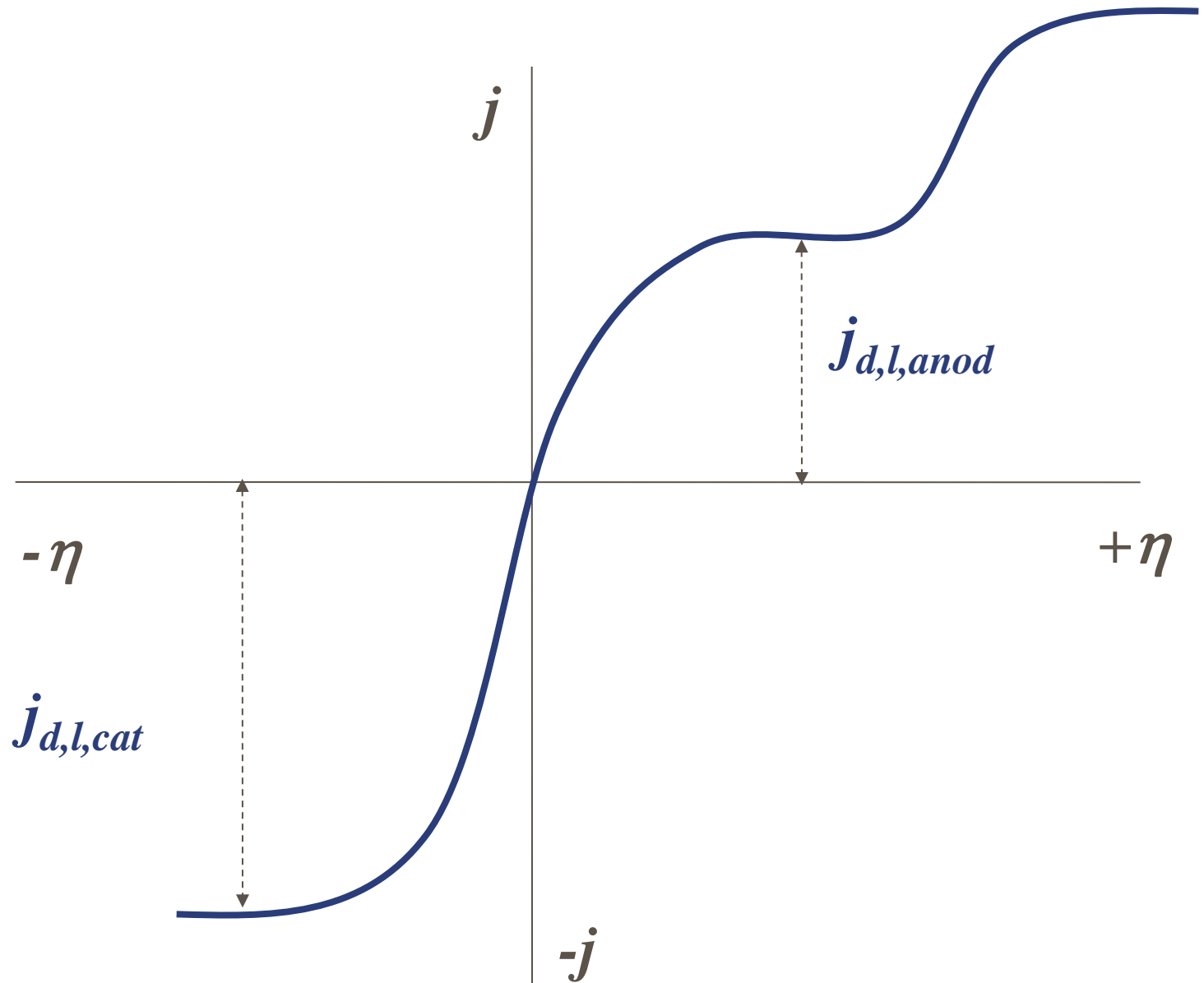

Diffusion overpotential - polarography

$$j = j_{dl} / 2$$

$$E_{1/2} = E_c^o + \frac{RT}{nF} \ln \frac{\kappa_{Red}}{\kappa_{Ox}}$$

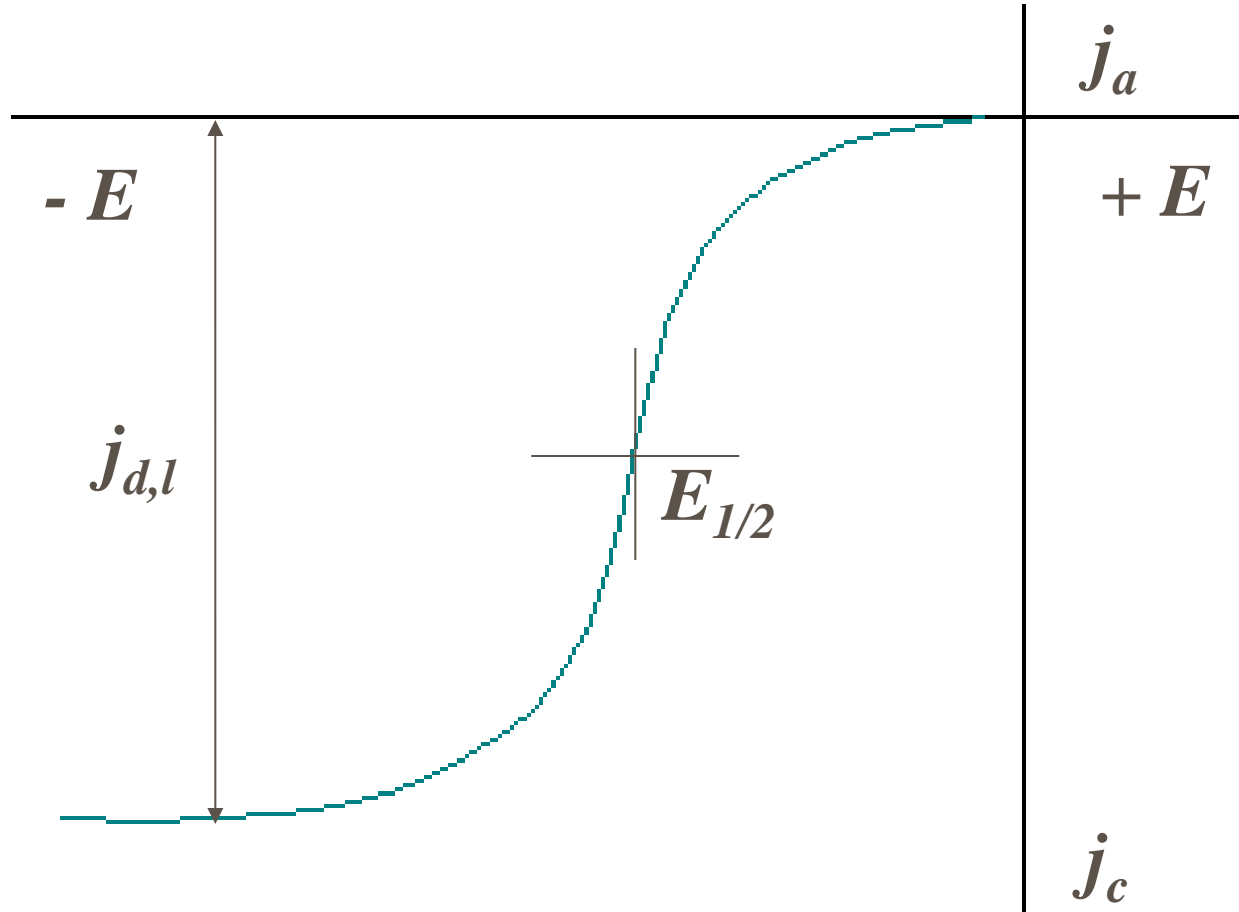

ELECTROGRAVIMETRY

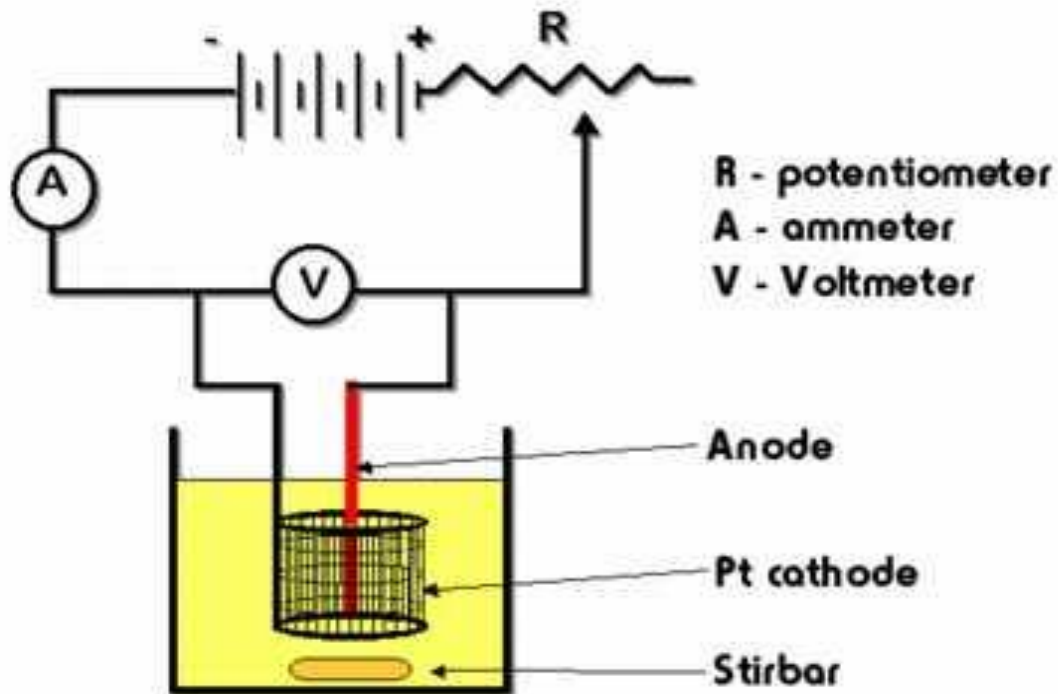

ELECTROGRAVIMETRY

A quantitative method based on weight gain. It is also referred to as electrodeposition.

- ✓ A very old method.**
- ✓ When it works, it works well.**
- ✓ Unfortunately, it only works for a limited number of materials.**

ELECTROGRAVIMETRY

Steps in the analysis

- The Pt electrode is deaned, dried and its weight determined.
- The electrode is then placed in the system and a potential is applied.
- The analyte deposits on the electrode.
- The electrode is removed and brought to constant weight.

ELECTROGRAVIMETRY



The starting potential must initially be high to insure a complete deposition



Overpotential can cause gas generation.



Our species may not be able to diffuse rapidly enough.



The deposition will slow down as the reaction proceeds.

ELECTROGRAVIMETRY

Controlled potential



A reference electrode is used in the system.

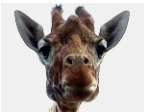

The potential difference between the working and reference electrodes is monitored and held constant.



This helps to reduce overpotential and the time for an analysis.

ELECTROGRAVIMETRY



Only a limited number of species work well with electrodeposition.



Only a few metals deposit from an acid solution quantitatively without hydrogen formation.



Not many metals form a smooth, well held coating on the cathode - can lose metal.

ELECTROGRAVIMETRY

Cathode electrodepositions.



Copper - Commonly done in an acid solution using a Pt cathode.



Nickel - Conducted in a basic solution

Zinc - Requires an acidic citrate solution



Some metals can be determined by deposition of metal complexes (cyanides).

Ag, Cd, Au.

ELECTROGRAVIMETRY

Anode electrodepositions



Some metals can be assayed by deposition on the anode.



This requires that we go to a higher oxidation - deposited as metal oxides.

