

# Bi9393 Analytická cytometrie



Biofizikální ústav AVČR  
Královopolská 135  
612 65 Brno

**e-mail: [ksoucek@ibp.cz](mailto:ksoucek@ibp.cz)**  
tel.: 541 517 166

**Karel Souček, Ph.D.**

Lukáš Kubala, Ph.D.

Eva Bártová, Ph.D.

Alena Hyršlová Vaculová, Ph.D.

Mgr. Radek Fedr



# Struktura kurzu

- Přednášky

- 7 lekcí o průtokové cytometrii a aplikacích
- 1 lekce o *in vivo* zobrazovacích metodách
- 1 lekce o mikroskopických technikách
- 1 lekce o základech analýzy obrazu
- 2 lekce studentských prezentací

- **Bi9393c Analytická cytometrie-cvičení**

- Navazuje na přednášky z oblasti průtokové cytometrie

- Test

Kurz bude zakončen zkouškou ve formě testu shrnujícího látku za celý semestr. Výsledek testu bude tvořit 75% celkového hodnocení.

- Seminář

Každý student bude prezentovat krátký seminář jehož téma bude konzultováno s přednášejícím a bude se týkat zaměření kurzu. Na základě této prezentace bude udělen zápočet a hodnocení vlastního semináře se bude také z 25-ti % odrážet v celkové známce.



# Seminář studentů

- Téma semináře: **Jak ve své DP/DSP používám/chci použít/ mohl bych použít metody analytické cytometrie.**
- Cílem je demonstrovat pochopení principů ze kterých vychází a jejich uplatnění v biologii.
- Prezentace musí být připravena např. v PowerPoint(u). Prezentaci je **doporučeno předložit v předstihu** přednášejícímu ke konzultaci a posouzení.
- Délka prezentace je 5 minut (~ 2 min představení podstaty Vaší experimentální práce) + diskuse

# Informační zdroje – průtoková cytometrie

- Practical Flow Cytometry, Howard M. Shapiro, Wiley-Liss; 4th edition
- Cytometry: New Developments, Volume 75, Fourth Edition (Methods in Cell Biology), Zbigniew Darzynkiewicz, Academic Press; 4th edition
- Flow Cytometry with Plant Cells: Analysis of Genes, Chromosomes and Genomes; Jaroslav Dolezel (Editor), Johann Greilhuber (Editor), Jan Suda (Editor), February 2007

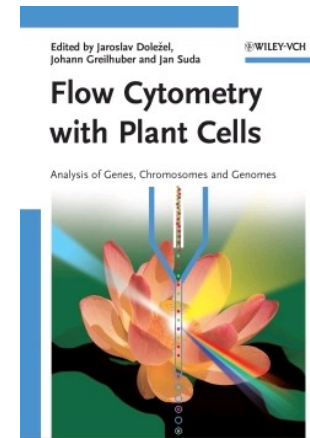
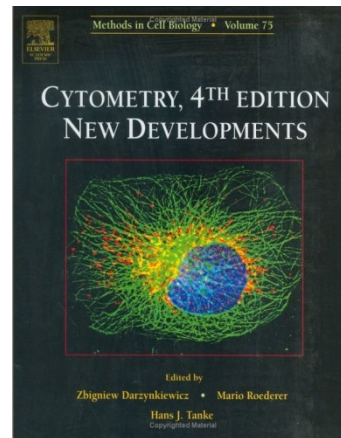
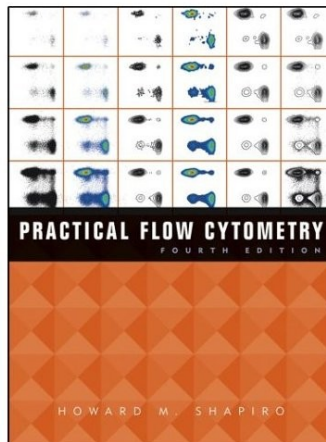

Více informací o knihách o průtokové cytometrii najdete na:  
<http://www.cyto.purdue.edu/flowcyt/newbook.htm>

# Informační zdroje – průtoková cytometrie (metody a protokoly)

- The Handbook of Flow Cytometry Methods
- Current Protocols in Cytometry
- Company web pages
  - e.g. <http://www.ebioscience.com/resources/best-protocols/flow-cytometry-protocols.htm>
  - <https://www.thermofisher.com/cz/en/home/references/protocols/cell-and-tissue-analysis/flow-cytometry-protocol.html>

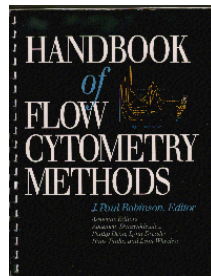
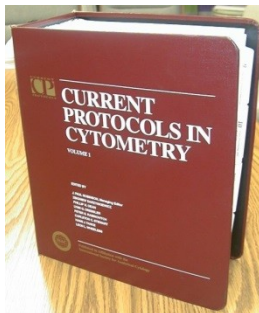

# Informační zdroje – cytometrie (časopisy)

## ■ [Cytometry Part A](http://www3.interscience.wiley.com/cgi-bin/jhome/33945)

<http://www3.interscience.wiley.com/cgi-bin/jhome/33945>



## ■ [Cytometry Part B: Clinical Cytometry](http://www3.interscience.wiley.com/cgi-bin/jhome/102019902)

<http://www3.interscience.wiley.com/cgi-bin/jhome/102019902>





## Informační zdroje – (Internet)

- Purdue University, Cytometry Labs

<http://www.cyto.purdue.edu/>

- International Society for Analytical Cytology

<http://www.isac-net.org/>

# Informační zdroje - mikroskopie

- Taatjes D. J. Cell Imaging Techniques, Methods and Protocols, Humana Press, Totowa, New Jersey, 2005
- Stephens D. Cell Imaging, Scion Publishing Ltd., 2006.
- Pawley, J. (Ed.), Handbook of Biological Confocal Microscopy, 3rd ed., 2006
- Fluorescence Microscopy: From Principles to Biological Applications
- Ulrich Kubitscheck (Editor), ISBN: 978-3-527-32922-9, 2013, Wiley-Blackwell

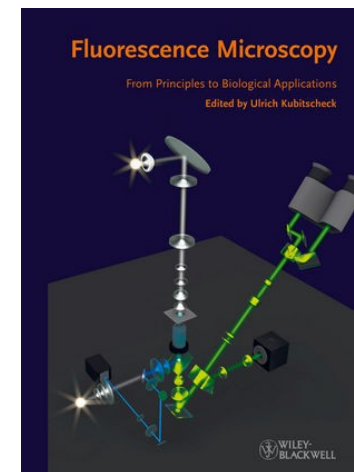
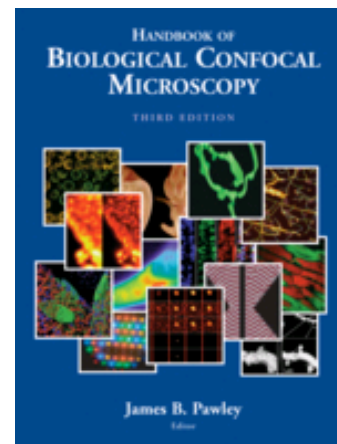
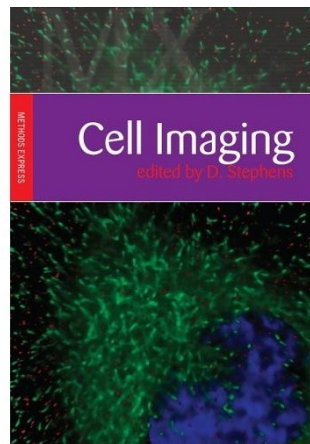
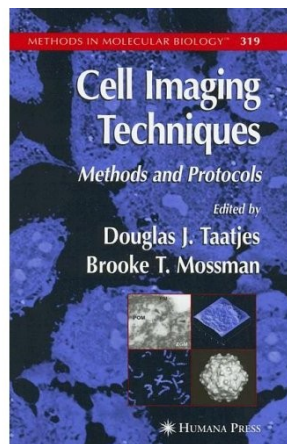





# Obecný úvod do průtokové cytometrie

- Základní principy, možnosti průtokové cytometrie a její aplikace
- Historie

# Tyto částice mají něco společného ...

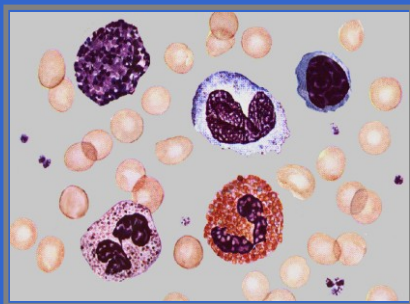

Blood cells



Chromosomes



Algae



Protozoa

... určité parametry těchto částic mohou být měřeny pomocí průtokové cytometrie.

# Komerční zařízení a vývoj

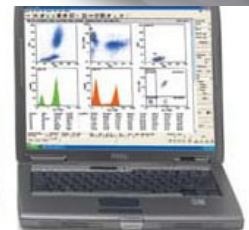
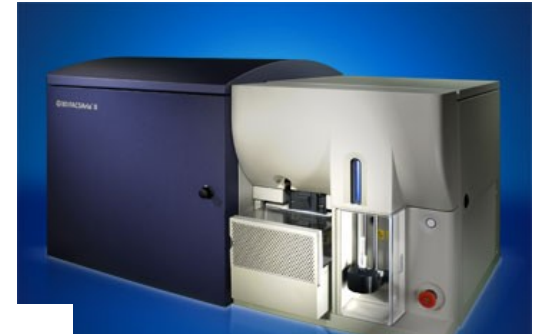

# Co je průtokový cytometr?

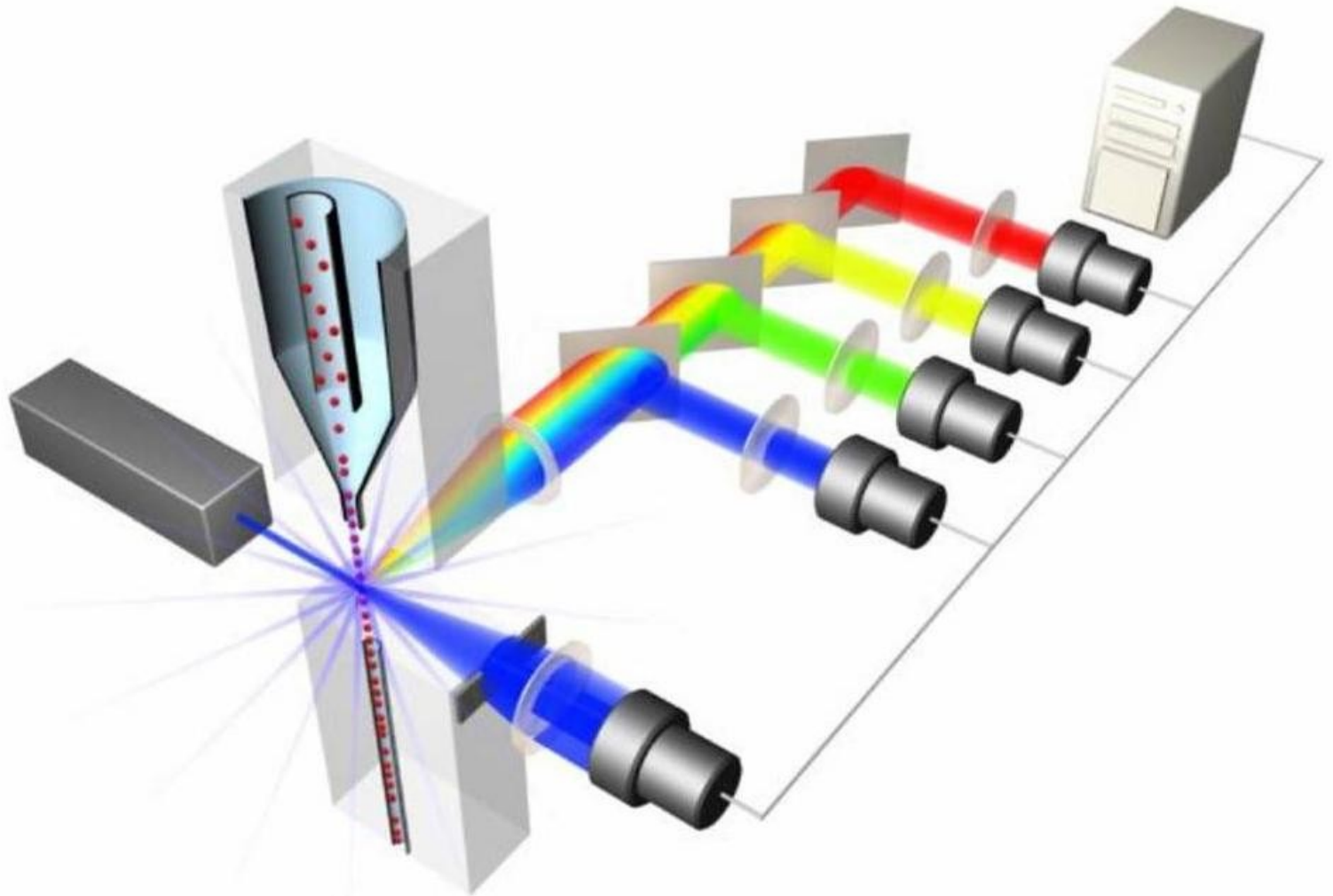



# Co můžeme analyzovat pomocí průtokové cytometrie?

- Počítat částice v suspenzi
- Oddělit živé částice od neživých
- Hodnotit  $10^5$  až  $10^6$  částic za méně než 1 minutu
- Kvantifikovat rozptyl světla, a **intenzitu fluorescence**
- Fyzicky separovat jednotlivé částice (populace) pro další analýzu



# Jaké jsou principy?

- **Rozptyl světla (Light scatter)** pomocí laseru nebo UV lampy
- Detekce specifické fluorescence
- **Hydrodynamicky** zaostřený proud částic
- **Elektrostatická** separace částic
- Možnost **multivariační** analýzy dat



# Definice

- **Průtoková cytometrie (flow cytometry)**

- Meření vlastností proudících částic (buněk)
- také známo jako **Fluorescence-Activated Cell Sorting (FACS)**

- **Průtoková separace (flow sorting)**

- fyzická separace částic (buněk) na základě parametrů měřených průtokovou cytometrií



# Technické součásti

- Zdroje světla
- Detekční systémy
- Fluidní systém
- Separace
- Sběr dat
- Analýza dat





# Technické součásti

## ■ Detekční systémy

### **Fotonásobiče (Photomultiplier Tubes (PMTs))**

dříve 1-2

nyní 3-8

### **Diody**

detekce rozptylu světla (light scatters)

## ■ Zdroje světla

**Lasery** (350-363, 420, 457, 488, 514, 532, 600, 633 nm)

Argon ion, Krypton ion, HeNe, HeCd, Yag

**UV (Arc) Lampy**

Mercury, Mercury-Xenon

# Historie barvení biologických materiálů

Až do poloviny 19. století – *byly používány pouze přírodní barviva*

*Anton van Leeuwenhoek* použil v roce 1719 šafrán na obarvení svalových buněk

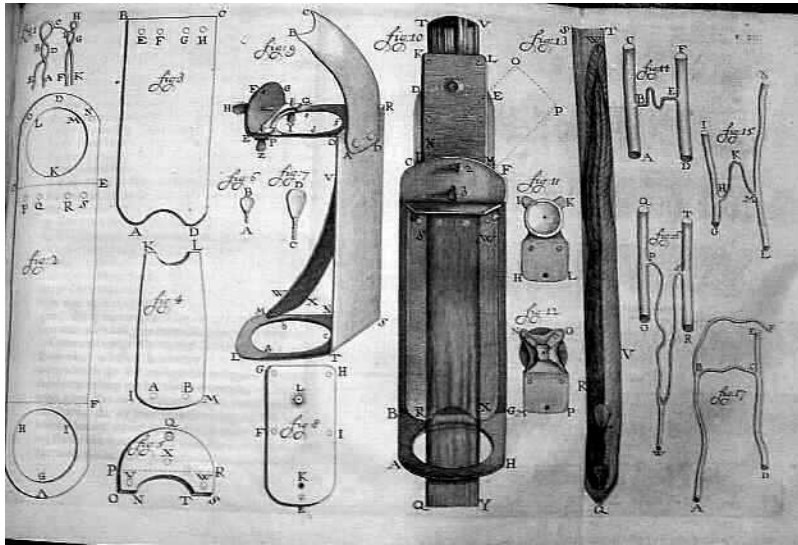

Leeuwenhoek  
Microscope  
(circa late 1600s)



# Historie barvení biologických materiálů

**Paul Ehrlich** - 1879 použil kyselá a zásaditá barviva pro odlišení acidofilních, eosinofilních a neutrofilních leukocytů

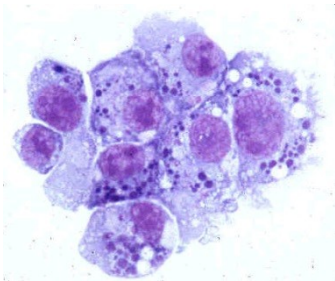

Clin Lab Med. 1993 Dec;13(4):759-71.

**The Ehrlich-Chenzinsky-Plehn-Malachowski-Romanowsky-Nocht-Jenner-May-Grunwald-Leishman-Reuter-Wright-Giemsa-Lillie-Roe-Wilcox stain. The mystery unfolds.**

Woronzoff-Dashkoff KP.

# Historie barvení biologických materiálů

## Princip fluorescenčního Mikroskopu - August Köhler - 1904



August Köhler  
(1866-1948)

Köhler's Original Woodcut

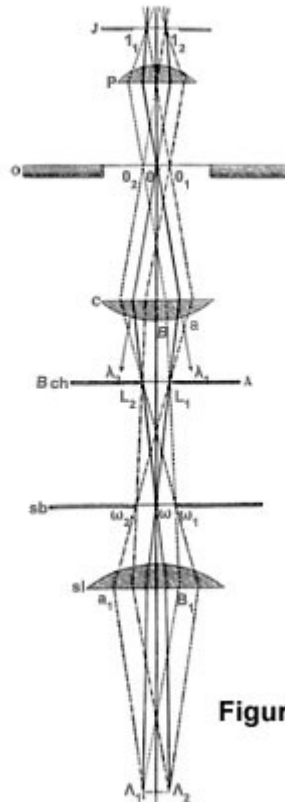
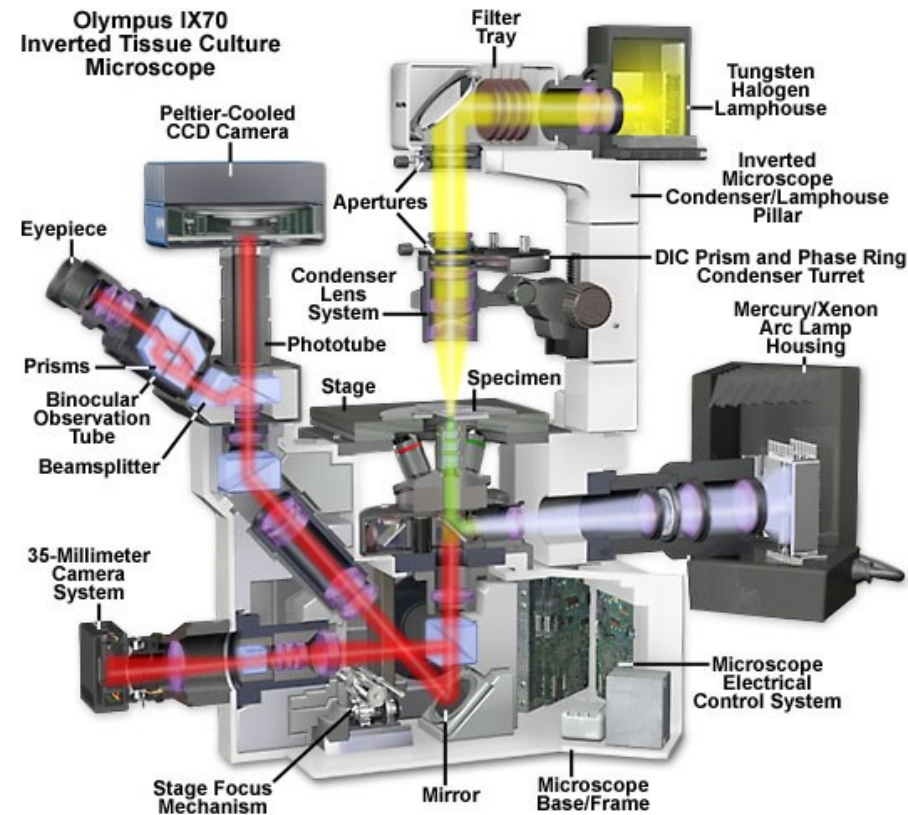

Figure 1



# Andrew Moldavan

Není jasné zda  
Moldavan vůbec svůj  
„počítač buněk“ sestrojil.  
Ve svém, článku popisuje  
mnoho problémů, ale  
žádné výsledky.

*“The purpose of the experiment is to have each microscopical cell passing through the capillary tube, register itself automatically on the photoelectric apparatus, thus creating a micro-current which can be amplified and recorded.”*

## **Photo-Electric Technique for the Counting of Microscopical Cells**

**Andrew Moldavan**  
Montreal, Canada  
Science 80:188-189, 1934

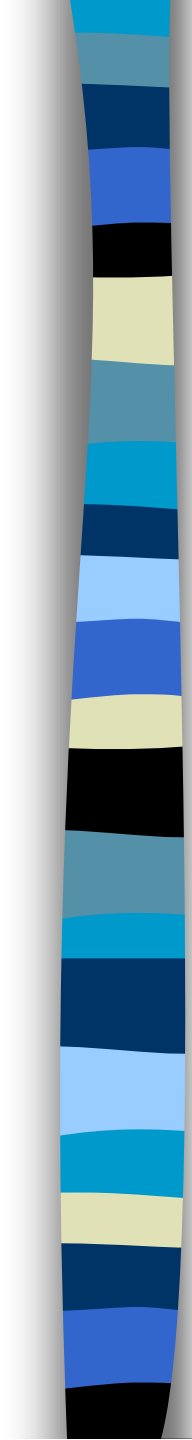

**Coons et al 1941** – vyvinuli techniku fluorescenčního značení protilátek - označili anti-pneumokokové protilátky pomocí antracénu. To jim umožnilo detekovat protilátky i patogeny v tkáni pomocí UV fluorescence.

*“Moreover, when Type II and III organisms were dried on different parts of the same slide, exposed to the conjugate for 30 minutes, washed in saline and distilled water, and mounted in glycerol, individual Type III organisms could be seen with the fluorescence microscope.....”*

### Immunological Properties of an Antibody Containing a Fluorescent Group

Albert H. Coons, Hugh J. Creech and R. Norman Jones

Department of Bacteriology and Immunology, Harvard Medical School, and the Chemical Laboratory, Harvard University  
Proc. Soc. Exp.Biol.Med. 47:200-202, 1941

**Coons a Kaplan (1950)** - konjugovali fluorescein s isokyanátem (FITC) – získali lepší signál – dále od autofluorescence.

# Friedman

**Friedman (1950)** – kombinoval kyselý fuchsin, akridinovou žlutá a berberin pro detekci buněk nádorů dělohy pomocí fluorescenčního mikroskopu

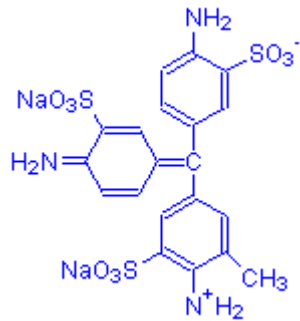

**Acid Fuchsin**

Acid magenta

Acid rubin

Acid roseine

Absorption Max 540-545

# von Bertalanffy & Bickis

**Ludwig von Bertalanffy (1901-1972)**

von Bertalanffy & Bickis (1956)

- metachromatická fluorescence Akridinové oranže byla použita pro detekci RNA v tkáni
- použili ji také pro rozlišení normálních a nádorových buněk

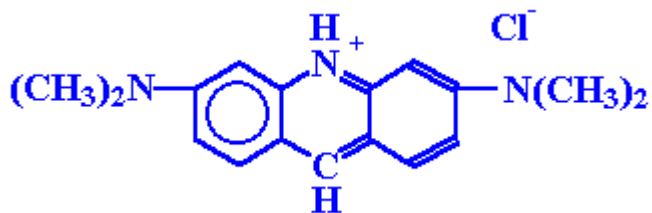

Absorption Max 467 nm





# Stain Your Own Cell

**ThermoFisher**  
SCIENTIFIC

# P.J. Crossland-Taylor

## „Sheath Flow“ princip

*“Provided there is no turbulence, the wide column of particles will then be accelerated to form a narrow column surrounded by fluid of the same refractive index which in turn is enclosed in a tube which will not interfere with observation of its axial content.”*

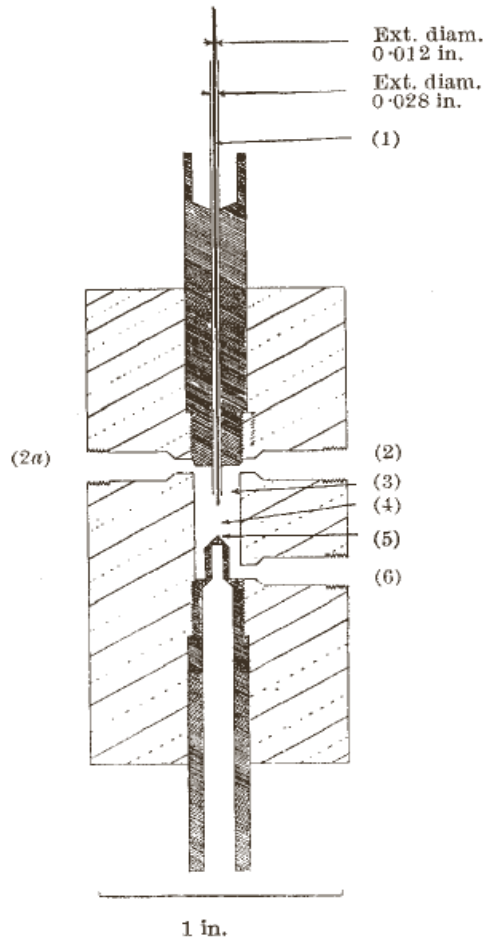

(1) Needle in holder; (2) and (2a) inflow tubes; (3) wide-bore tube; (4) observation area for (3); (5) vortex; (6) flushing tube

### A Device for Counting Small Particles suspended in a Fluid through a Tube

ATTEMPTS to count small particles suspended in fluid flowing through a tube have not hitherto been very successful. With particles such as red blood cells the experimenter must choose between a wide tube which allows particles to pass two or more abreast across a particular section, or a narrow tube

P. J. CROSLAND-TAYLOR\*

Bland-Sutton Institute of Pathology,  
Middlesex Hospital,  
London, W.1.  
June 17.

No. 4340 January 3, 1953

NATURE

# Wallace Coulter



- Wallace Coulter - Coulter orifice - 1956 -
- (patent 1953) – měření změny vodivosti během průchodu buněk v suspenzi malým otvorem

Originální  
patentová  
aplikace  
W.Coultera 1953

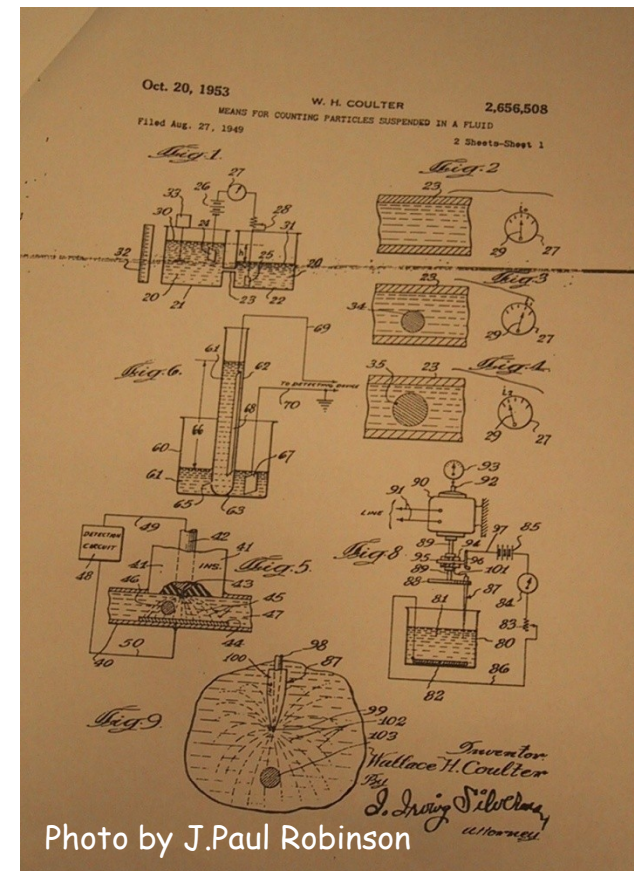
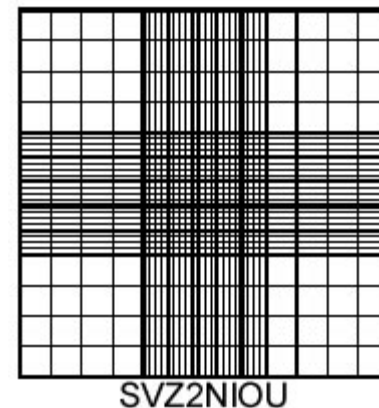
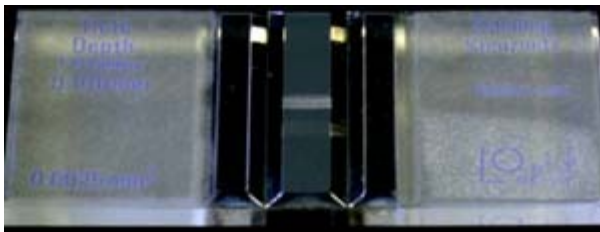

Photo by J.Paul Robinson

# Jak počítat buňky?

- Hemocytometer (Bürkerova komůrka) byla standardem pro počítání buněk do ~ 1950
- Rozměry jsou 3x3x0.1 mm. Obvykle jsou červené krvinky ( $1 \times 10^6/\text{mm}^3$ ) počítány po naředění 1:200
- Leukocyty ( $5 \times 10^3/\text{mm}^3$ ) jsou ředěny 1:10 v roztoku lyzujícím červené krvinky
- Statistická chyba:
  - koeficient variance (CV) je při 500 spočítaných buňkách 4.4%
  - chyba pipetování a ředění je ~ 10%



# Roche Innovatis Cedex

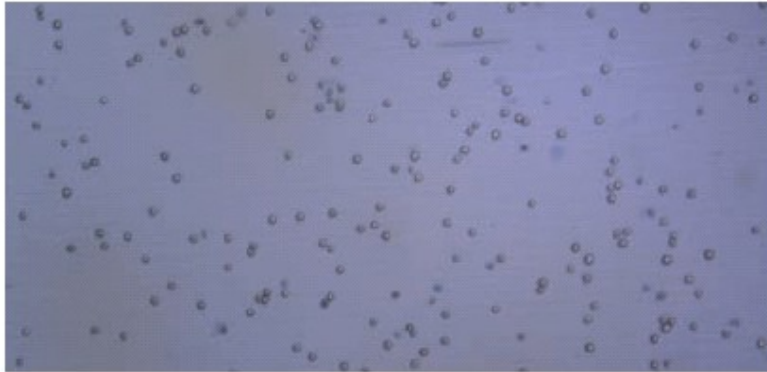

**High Resolution Color Image**

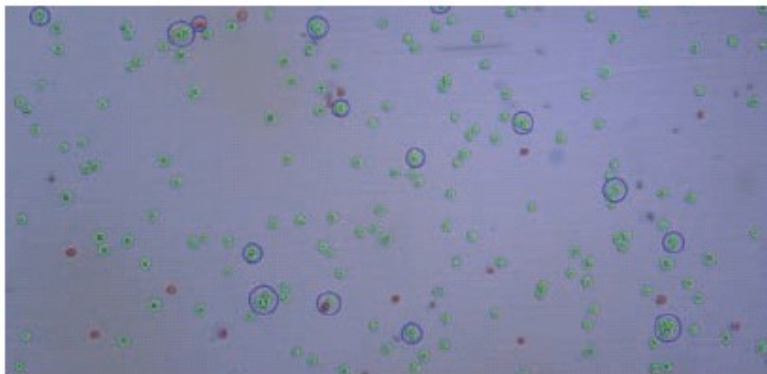

**Visual Labeling**



# Coulter Counter



První komerční verze CC

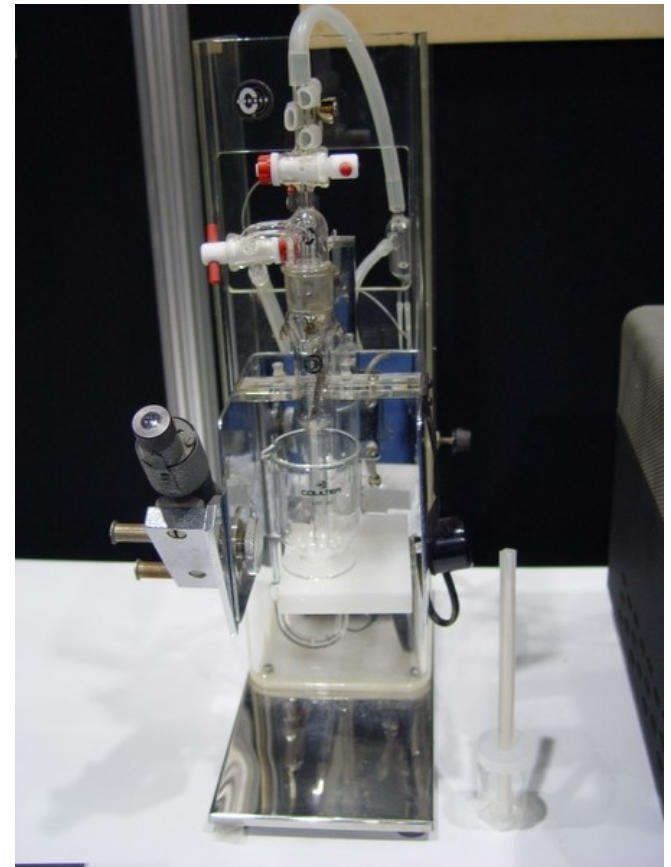

# Coulter Counter

1-2

FIG. 1-1 FUNCTIONAL BLOCK DIAGRAM FOR MODEL ZF COUNTER

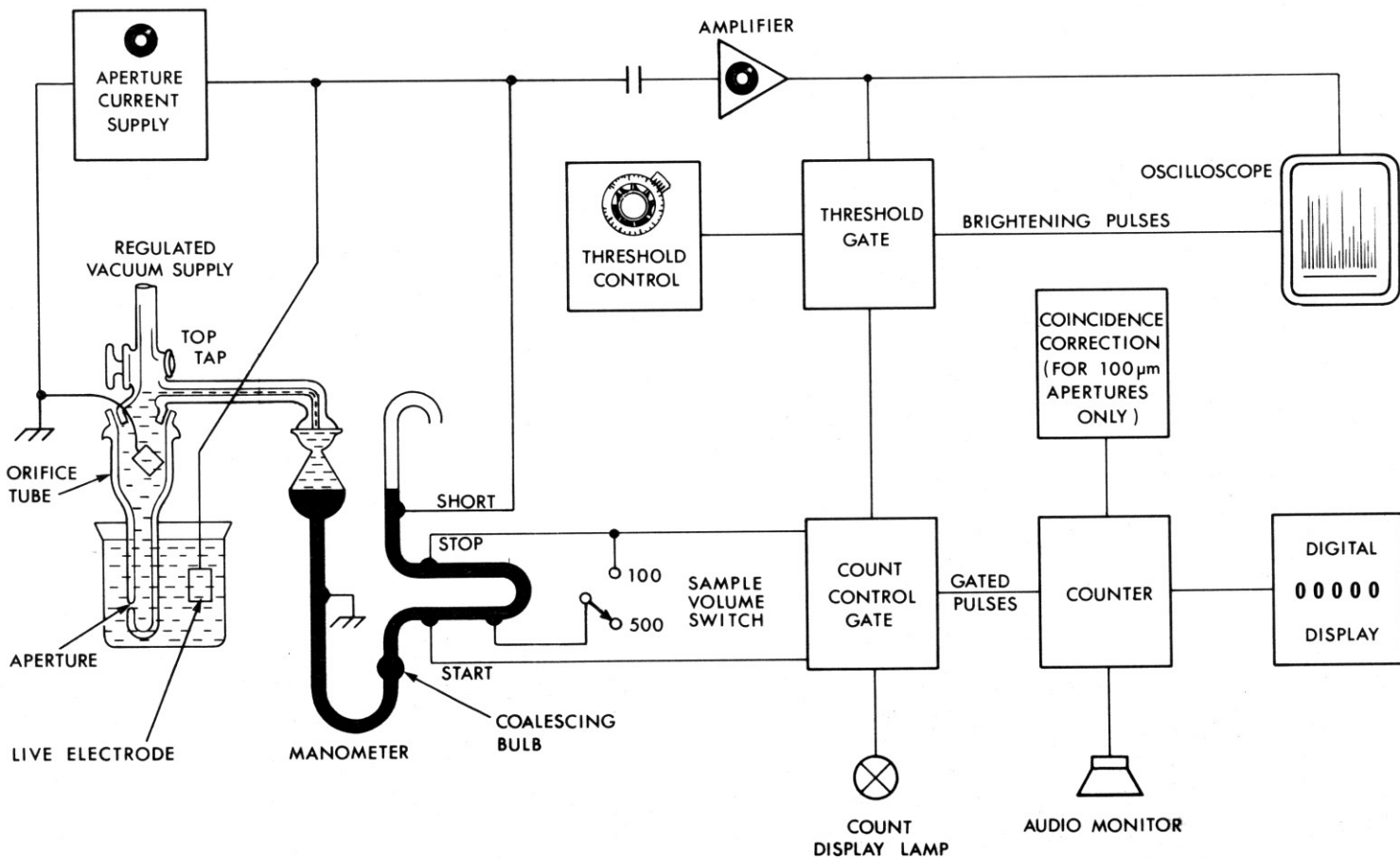

July '80

# Beckman Coulter

## ■ Multisizer™ 3&4 COULTER COUNTER®

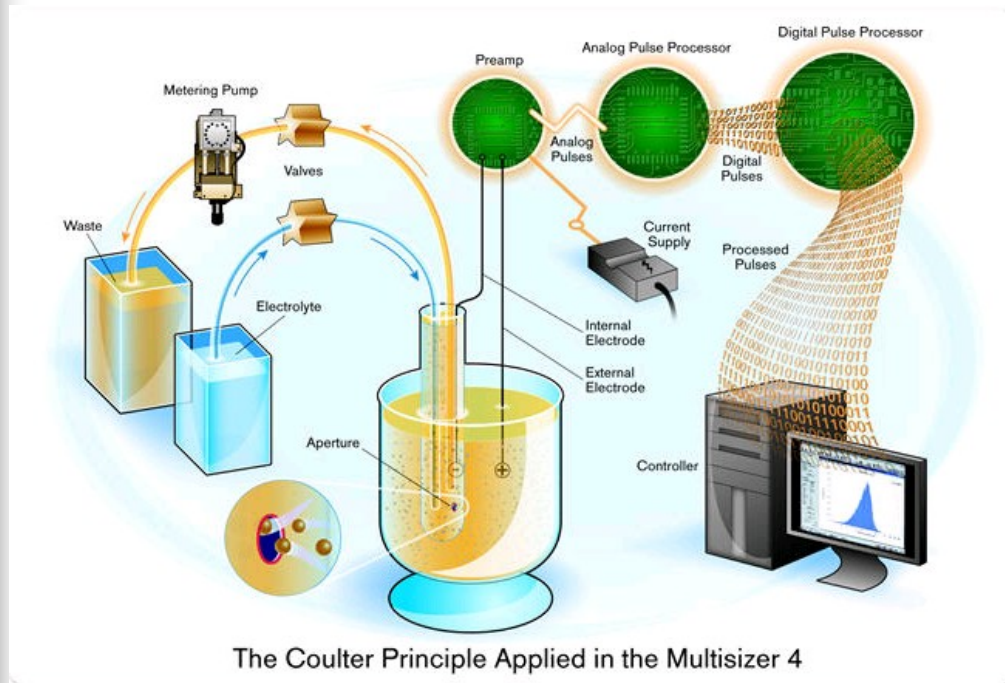



# Roche Innovatis

## CASY TT

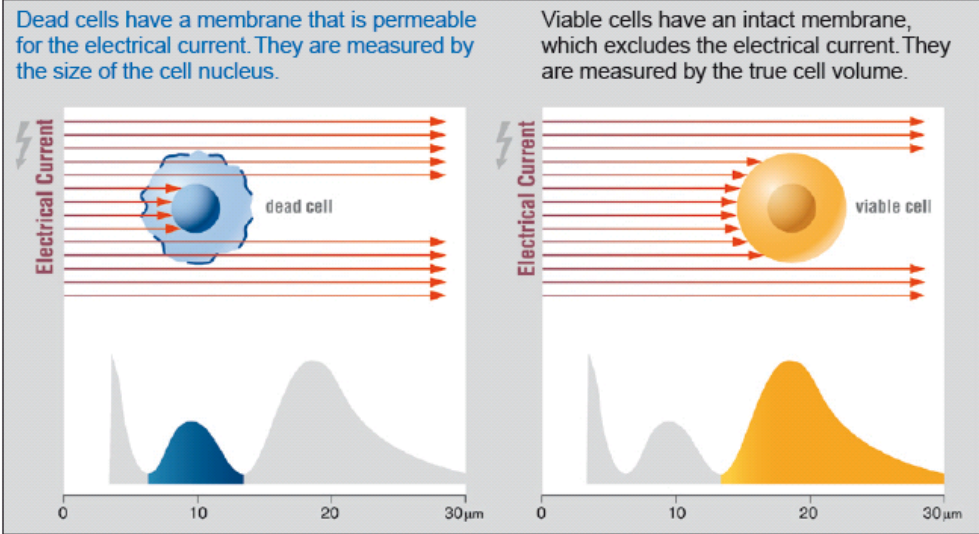

**Figure 1: Viability Measurement by Electrical Current Exclusion.** The status of the cell membrane distinctly affects the electrical signal generated when a cell is passing the measuring pore.



Cytograph. Stolní přístroj schopný měřit rozptyl světla **He-Ne laseru** (1970).

# Mack Fulwyler- sorter

**Mack Fulwyler - sorter 1965** - Los Alamos National Labs – jeho sorter separoval částice na základě elektronicky měřeného objemu (stejný princip jako Coulter counter) a separoval pomocí elektrostatičkého vychýlení.

Cílem bylo sortovat červené krvinky, protože u nich byla naměřena bimodální distribuce buněčného objemu. Princip separace byl založen na principu inkoustové tiskárny Richarda Sweeta ze Stanfordu (1965)

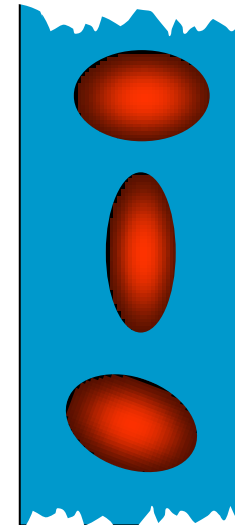
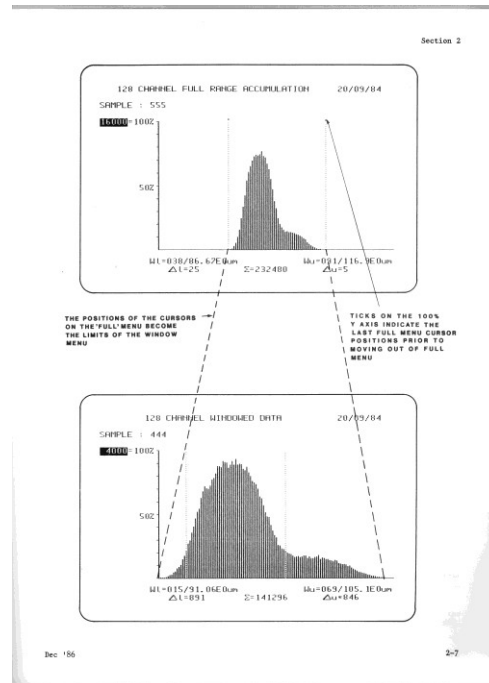

Po té co bylo objasněno, že bimodalita červených krvinek je artefakt byla tato skupina schopna separovat **neutrofilly a lymfocyty** z krve.

# Richard Sweet

Richard Sweet vyvinul elektrostatickou inkoustovou tiskárnu jejíž princip využil Mack Fulwyler pro svůj buněčný sorter.

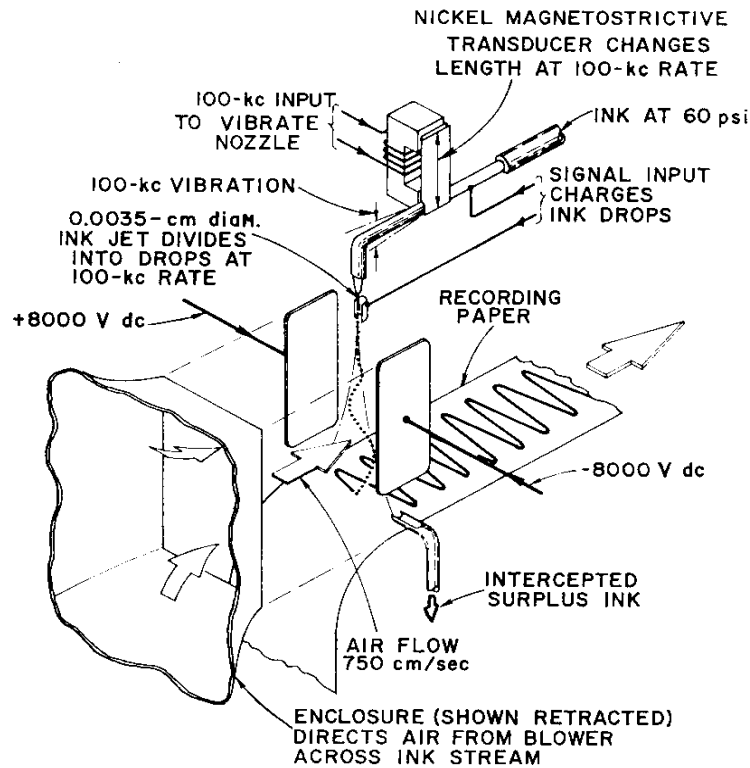

FIG. 1. Ink-jet oscillograph.

## THE REVIEW OF SCIENTIFIC INSTRUMENTS

VOLUME 36, NUMBER 2

FEBRUARY 1965

### High Frequency Recording with Electrostatically Deflected Ink Jets\*

RICHARD G. SWEET  
Systems Techniques Laboratory, Stanford Electronics Laboratories, Stanford University, Stanford, California  
(Received 28 September 1964)

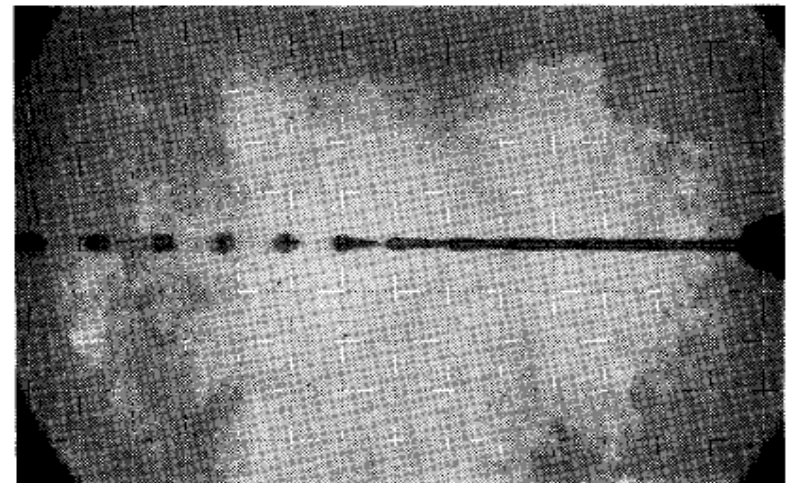
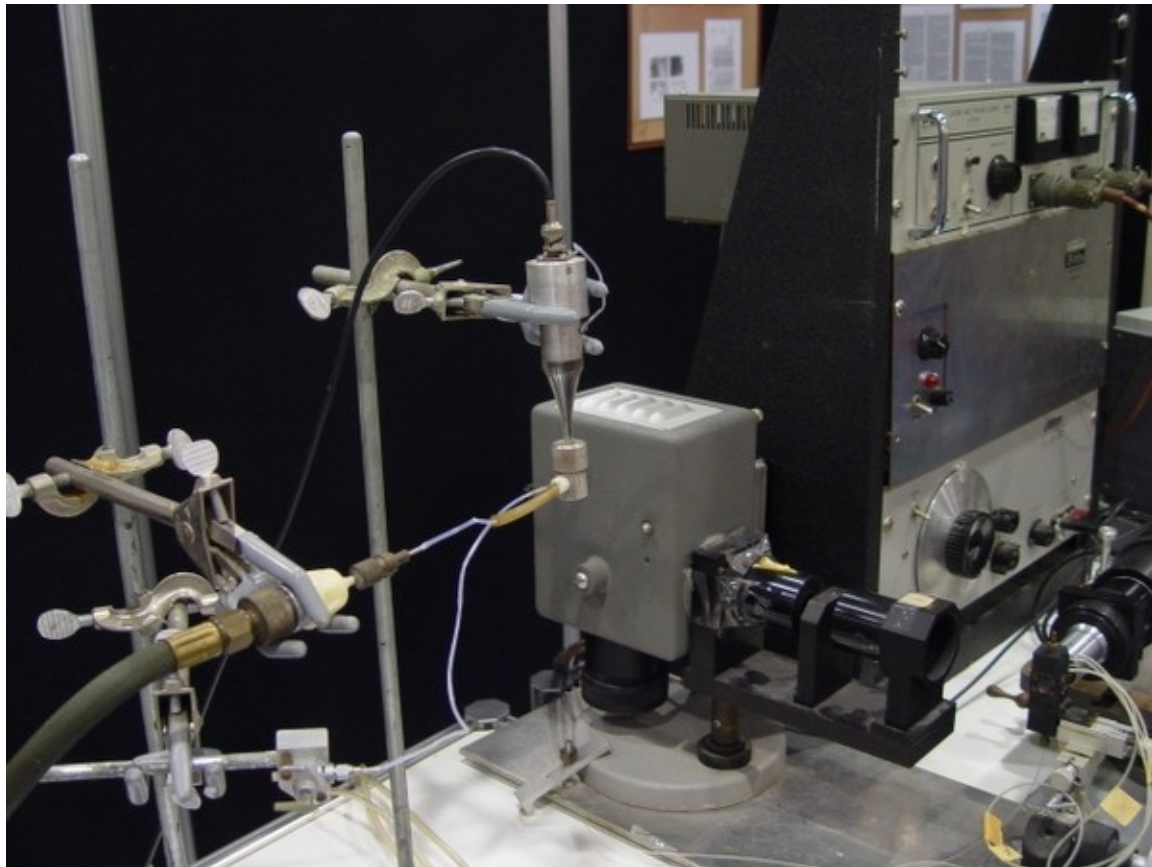
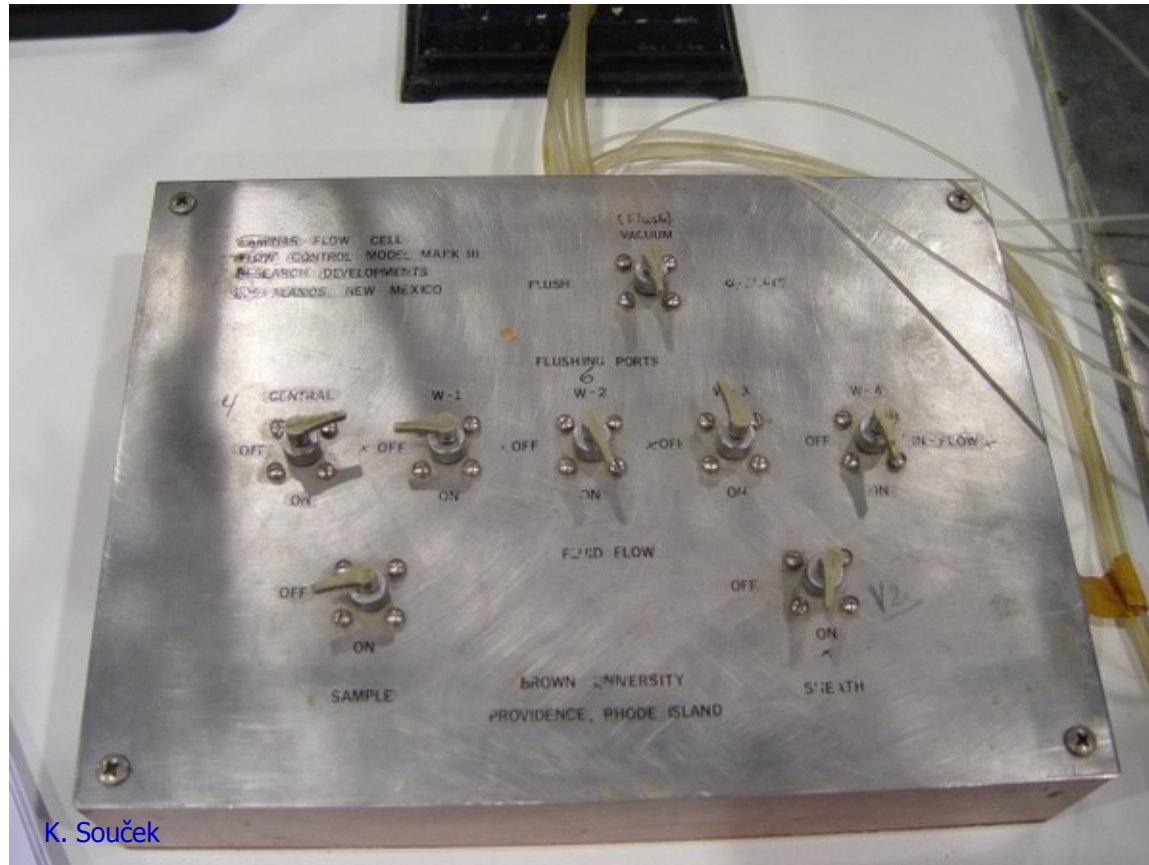

FIG. 3. Ink-drop formation.

# Mack Fulwyler- sorter



# Mack Fulwyler- sorter



K. Souček

# Mack Fulwyler in His Own Words

J. Paul Robinson

Purdue University Cytometry Laboratories, Bindley Biosciences Center, Purdue University, West Lafayette, Indiana

Received 12 July 2005; Revision 15 July 2005; Accepted 15 July 2005

MACK FULWYLER IN HIS OWN WORDS

65

FIG. 1. The Fulwyler instrument as installed in Dr. Boris Rotman's Laboratory in Brown University, immediately prior to disassembly in March 2005. The instrument had not been altered or moved since installation in 1967, except for the addition of a laser instead of the UV lamp.

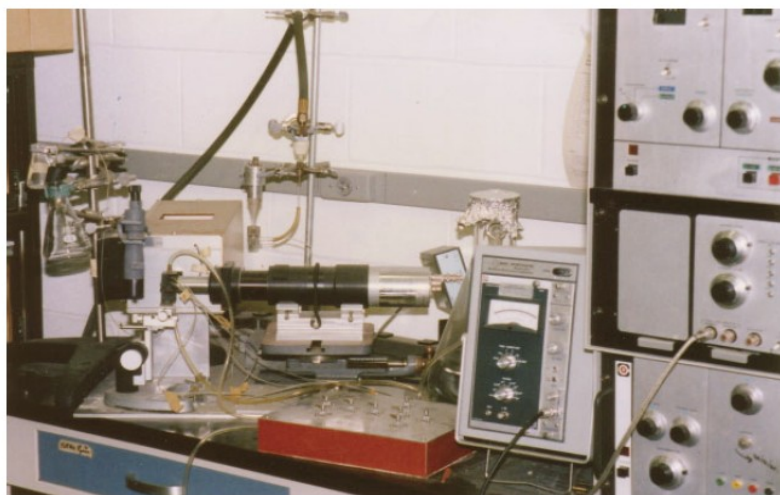

April 30, 1968

M. J. FULWYLER

3,380,584

PARTICLE SEPARATOR

Filed June 4, 1965

5 Sheets-Sheet 1

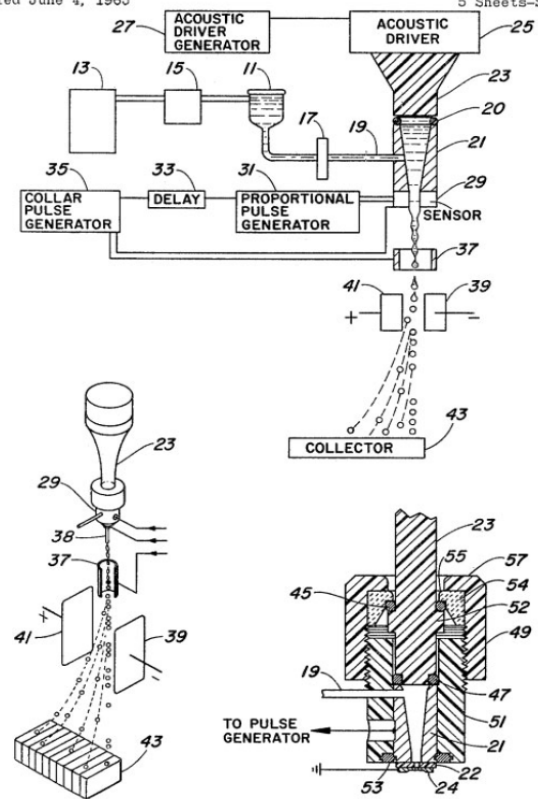

FIG. 4. A page from Fulwyler's patent on the cell separation technology patent #3,380,584 showing the fundamental components of the invention of the cell sorter.

INVENTOR.  
Mack J. Fulwyler  
BY  
*Richard A. Robinson*  
Attorney

# Leonard Arthur "Len" Herzenberg

From Hulett, HR, Bonner, WA, Barrett, J, and Herzenberg, LA. Cell Sorting: Automated Separation of Mammalian Cells as a Function of Intracellular Fluorescence. Science 1969; 166: 747-749. Reprinted with permission from AAAS.

## **Cell Sorting: Automated Separation of Mammalian Cells as a Function of Intracellular Fluorescence**

*Abstract. A system for high-speed sorting of fluorescent cells was able to sort mouse spleen cells from Chinese hamster ovarian cells after development of fluorochromasia. Highly fluorescent fractions separated after similar treatment from mouse spleen cells immunized to sheep erythrocytes were enriched in antibody-producing cells by factors of 4 to 10.*





# Klíčové „cytometrické“ publikace

- 1934: Moldovan – Fotoelektrické měření buněk v kapiláře
- 1947: Gucker – fotoelektrické počítání buněk
- 1949: Coultrův počítač částic
- 1961: Rotman poprvé používá fluorescenci pro kvantifikaci enzymatické reakce
- 1964: Sweet – elektrostatická inkoustová tiskárna
- 1965: Fulwyler – květen 1965 - patent elektrostatického sorteru
- 1965: Kanetsky – spektrofotometrické měření buněk
- 1965: Fulwyler – listopad 1965 – publikace o buněčné separaci v časopise Science
- 1968: Gohde – první článek o fluorescenční průtokové cytometrii (v němčině)
- 1969: Gohde – patent
- 1969: Van Dilla – druhý článek o fluorescenční průtokové cytometrii
- 1969: Mullaney – první článek věnující se popisu rozptylu světla jako cytometrického parametru
- 1969: Heryenberg – třetí článek o fluorescenční průtokové cytometrii
- 1973: Gohde – patent dvojího značení
- 1977: Gohde – popis kompenzací signálu při dvojtém značení
- 1978: Kachel – flow imaging – kombinace průtokové cytometrie a analýzy obrazu
- 1983: izolace a detekce jader (DNA) z tkání zalitých v parafínu
- 1984: kongres o nomenklatuře cytometrie DNA
- 1987: Graz - vysokorychlostní sortování chromozómů
- 1991: Robinson – automatizace klinických systémů – průtokový cytometr a čtečka čárkových kódů

# K čemu to všechno je... například...

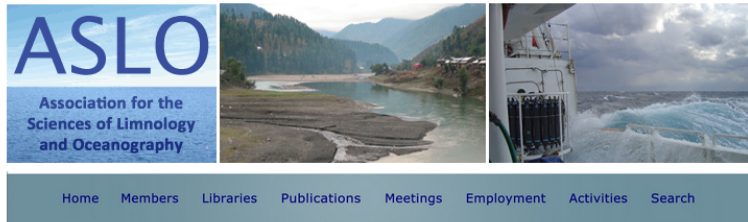

## Position Announcements

### Flow Cytometer Research Technician

Flow Cytometer - Research Technician

The Ocean Biogeochemistry Laboratory at Bigelow Laboratory of Ocean Sciences is seeking an energetic and motivated technician to join our research group. The primary responsibility of the successful candidate will be operation of our high-speed flow cytometer/ cell sorter in support of our oceanographic research. This technical position requires extensive knowledge of cytometric principles, an ability to troubleshoot and maintain analytical instrumentation, prior experience in method development, a willingness and capability of going to sea to operate the flow cytometer (cruises from 1 to several weeks), and a high degree of self-confidence and independence. A wide diversity of sample types are analyzed ranging from enumerating and sorting single cells from oceanic samples to quantification of cellular rate processes employing fluorogenic assays to combining isotopic methods with flow sorting.

The successful applicant must have at least a B.Sc. degree and 2+ years of demonstrated experience with flow cytometric cell sorters as a primary operator. The successful applicant must also be highly organized, have a strong ability to multi-task, be self-confident and independent. This position will initially be for one year with continuation for additional years based upon successful job performance.

Send CV, cover letter, and contact information for 3 references to [jobs@bigelow.org](mailto:jobs@bigelow.org). Please reference (RT-2012-4) in the subject line. Review of applicants will begin immediately and continue as applications are received until the position is filled. The preferred starting date is no later than 1 January 2013, but this may be negotiated. Salary will be commensurate with prior experience. Bigelow Laboratory is an Equal Opportunity Employer.

#### Submission Forms

[Submit Job Announcements](#)

[Submit Student Opportunities](#)

#### Employment and Student Opportunities

[Positions Offered](#)

[Student Opportunities](#)

[Job-Related Links](#)

#### Career Information

[Aquatic Science Careers](#)

[Careers in Public Policy](#)

[Early Career Scientists](#)

#### Programs and Opportunities

[Programs for Recent PhDs](#)

## Position Available

### FLOW CYTOMETRY TECHNICIAN

#### Oceanography, MIT

The Chisholm Laboratory at MIT (<http://web.mit.edu/chisholm/www/>) is seeking a full-time flow cytometry technician to participate in research involving oceanic cyanobacteria. The position requires a Bachelors degree in science or engineering and two years experience. Applicants must have a solid background in and experience with flow cytometry, including extensive knowledge of hardware, data analysis, and experimentation. Duties include maintenance of flow cytometry instruments, experimentation, and assisting other lab members with flow cytometry as needed. Must be able to work as a member of a multidisciplinary team. Opportunities for travel to field sites in Hawaii and Bermuda, and participation in oceanographic research cruises.

Please send a resume and 3 letters of recommendation to Dr. Marcia Osburne ([mosburne@mit.edu](mailto:mosburne@mit.edu)) or Dr. Marcia Osburne MIT, 15 Vassar



#### ABOUT US

- [About Us](#)
- [Contact Information](#)
- [Map & Directions](#)

#### ANNOUNCEMENTS

- [Employment Opportunities](#)
- [Events](#)
- [News](#)
- [Seminars](#)

### 4/9/12 - Job Opportunity: Biological Oceanography Technician

Date: April 9, 2012 - 8:00am  
Biological Oceanography - Job Opportunity

The Biological Oceanography Lab is seeking assistance (half-time or more) on Dr. Welschmeyer's ballast treatment testing project associated with the California Maritime Academy (CMA). The duties will include training/execution

many routine chemical and biological oceanographic analyses (e.g., DOC/POC, chlorophyll a, live organism microscopy, epifluorescence microscopy, flow cytometry, bacteria culturing assays, etc.). The employee will travel often between MLML and CMA.

Requirements: the employee must be available for two consecutive 48 hour periods (or more) each week; full time work is ideal. (Student schedules with M-W or T-Th classes will not work). A willingness to work long hours (odd hours) is mandatory; excellent pipeting skills, notetaking, and spreadsheet skills would be appreciated (state drivers license is helpful). Pay is \$20/h immediately; work will proceed through summer with possible sampling trips to southern California and South America.

Please contact Dr. Nick Welschmeyer by email ([Welschmeyer@mml.calstate.edu](mailto:Welschmeyer@mml.calstate.edu)) for information.



# K čemu to všechno je... například...

- 43 miliónů lidí na světě je infikováno virem HIV (WHO)
- ročně zemře ~ 2 miliónu lidí na HIV/AIDS (v Africe je ~ 11 miliónu AIDS sirotků)
- kvantifikace CD4 T lymfocytů je klíčový parametr při monitorování léčby
- Průtoková cytometrie je „zlatý standard“
- Optimalizované postupy a zařízení pro levné (< 3 EUR / vzorek) a rychlé detekce (250 vzorků / den)
- [Aydogan Ozcan](#): „Kill the cost, safe live“

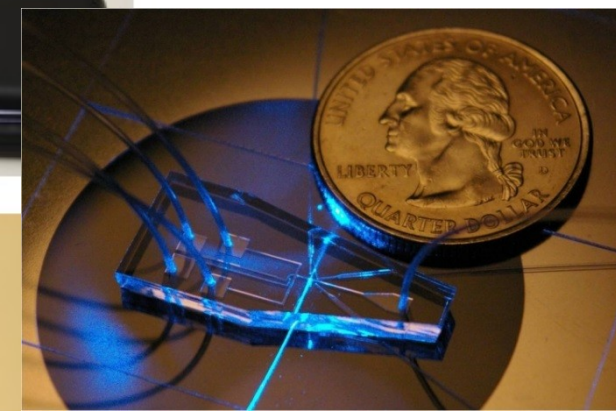
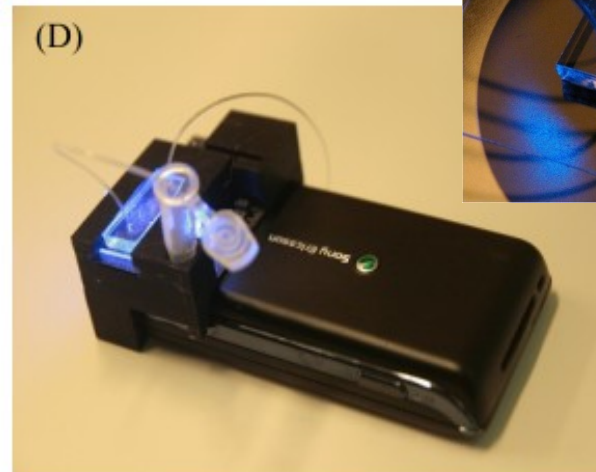
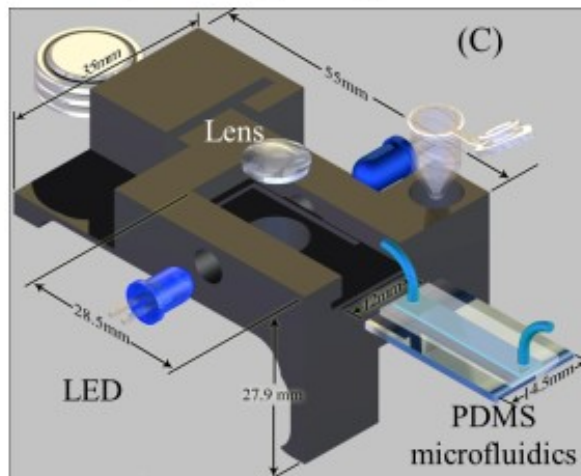
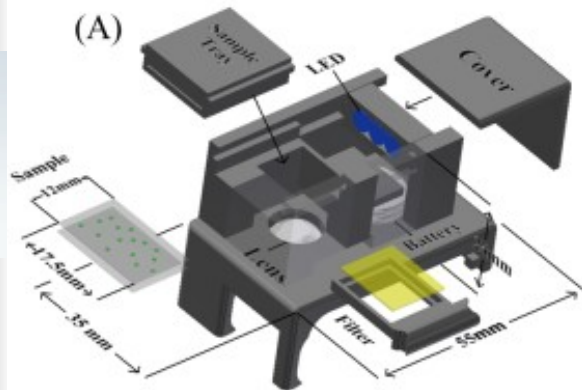

# Flow Cytometry On-a-Chip

## ■ MAGNETIC COUNTING

- **RESEARCHER:** [Hakho Lee](#), Assistant Professor of Radiology, Harvard Medical School  
**PROJECT:** Enumerating and characterizing circulating tumor cells  
**PROBLEM:** Circulating tumor cells (CTCs) are incredibly rare, with just a handful per milliliter of human blood.  
**SOLUTION:** Lee's group fabricated a hybrid microfluidic device out of polydimethylsiloxane (PDMS) that can count CTCs in real time using tiny sensors called micro-Hall detectors. ([Sci Transl Med, 4:141ra92, 2012](#))

## ■ PCR-ACTIVATED SORTING

- **RESEARCHER:** [Adam Abate](#), Assistant Professor of Bioengineering and Therapeutic Sciences, University of California, San Francisco  
**PROJECT:** Analysis of rare, uncultivable microbes  
**PROBLEM:** Developing specific antibodies for bacteria that cannot be cultured  
**SOLUTION:** As a postdoc in the Harvard University lab of droplet-based microfluidics pioneer [David Weitz](#), Abate codeveloped a device that could sort droplets according to their fluorescence intensity. Unlike traditional microfluidics, in which molecules and cells flow naked through channels, droplet-based devices encapsulate molecules or cells in uniform, picoliter-scale aqueous reaction chambers encased in oil.

## ■ SORTING BY CELL DEFORMABILITY

- **PROJECT:** Cancer cell phenotyping  
**PROBLEM:** Not every cell type has a known antigen that defines it. Plus, antibody binding may activate receptors, potentially changing the cell's behavior.  
**SOLUTION:** A physicist by training, Guck used laser beams in his graduate work to study the physical properties of cells. Not all cells are equally squishy, he found: while normal cells are relatively rigid, cancer cells are more pliable. "The more aggressive the cell, the softer it is, and that may be necessary for it to pass into tissues," Guck explains.

## ■ RAMAN-ACTIVATED CELL SORTING

- **RESEARCHER:** [Jian Xu](#), Professor and Director, and Bo Ma, Group Lead of Microfluidics, Single-Cell Center, Qingdao Institute of Bioenergy and Bioprocess Technology, Chinese Academy of Sciences  
**PROJECT:** Microbial biofuels development  
**PROBLEM:** Biofuels R&D requires identifying cells capable of specific carbon chemistries. But as these cells have yet to be cultured and studied, researchers have few if any molecular hooks for identifying and sorting them.  
**SOLUTION:** The team turned to a label-free method of single-cell interrogation known as Raman-activated cell sorting (RACS) ([Anal Chem, 87:2282-89, 2015](#)).



# Co tomu předcházelo...a čeho jsme i nyní součástí...

- Rozvoj techniky umožňující rychlou a reprodukovatelnou detekci cytometrických parametrů.
- Nové vědecké poznatky vedoucí k definici vhodných diagnostických markerů.

# ISAC presents: Mack Fulwyler - Innovator, Inventor & Pioneer

<http://www.cyto.purdue.edu/cdroms/gh/HTML/start.htm?loc=http://www.cyto.purdue.edu/cdroms/gh/HTML/video/video.html?v=Flowtheinvention.wmv>



<http://www.cyto.purdue.edu/cdroms/cyto10a/seminalcontributions/fulwyler.html>



<https://www>

[s512mepKkY](https://www)





# Shrnutí přednášky

- Úvod do kurzu
- Zdroje literatury
- Historie průtokové cytometrie
- Základní principy

## **Na konci dnešní přednášky byste měli:**

1. vědět jaké jsou požadavky pro tento kurz
2. znát základní zdroje informací
3. mít stručný přehled o historii průtokové cytometrie
4. orientovat se v některých základních principech průtokové cytometrie