

HYBRIDIZACE A HYBRIDNÍ ZÓNY



Sekundární kontakt

kruhové druhy:

Chorthippus parallelus

postglaciální expanze

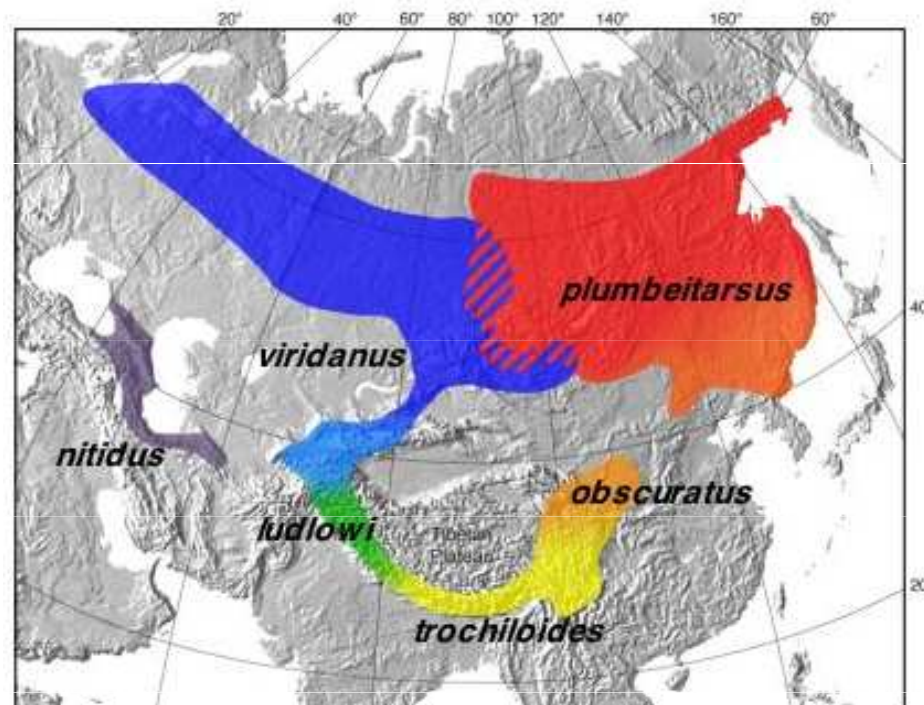
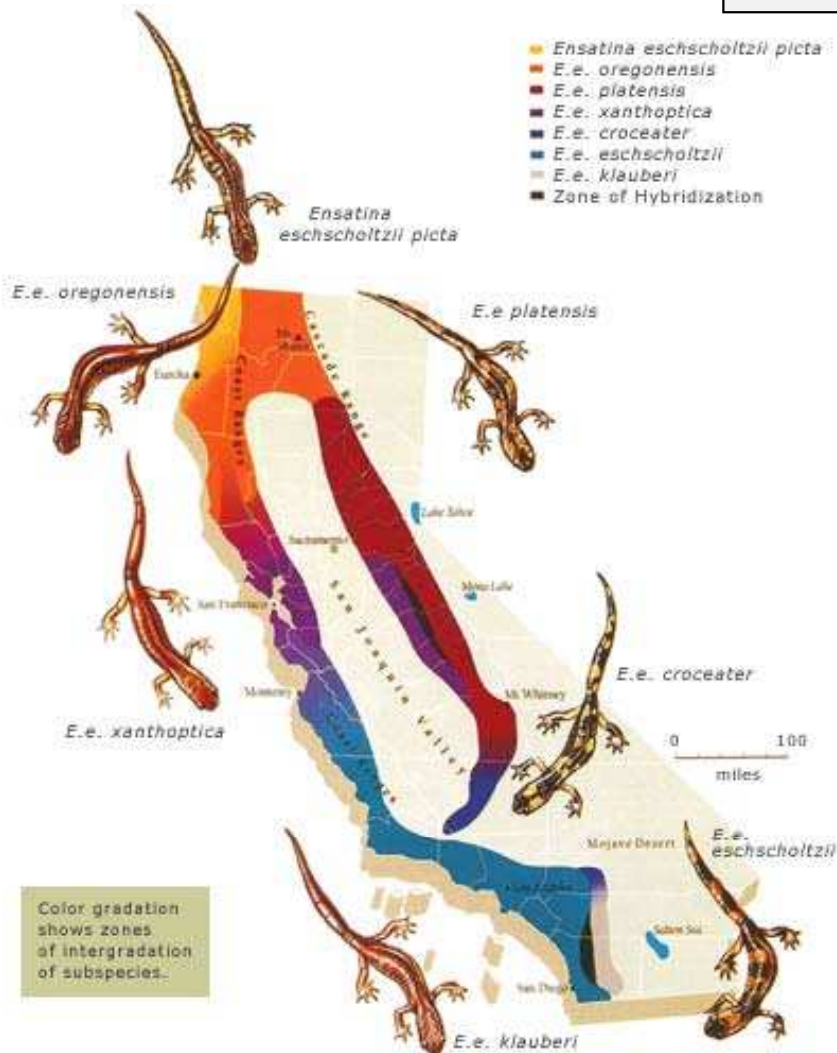
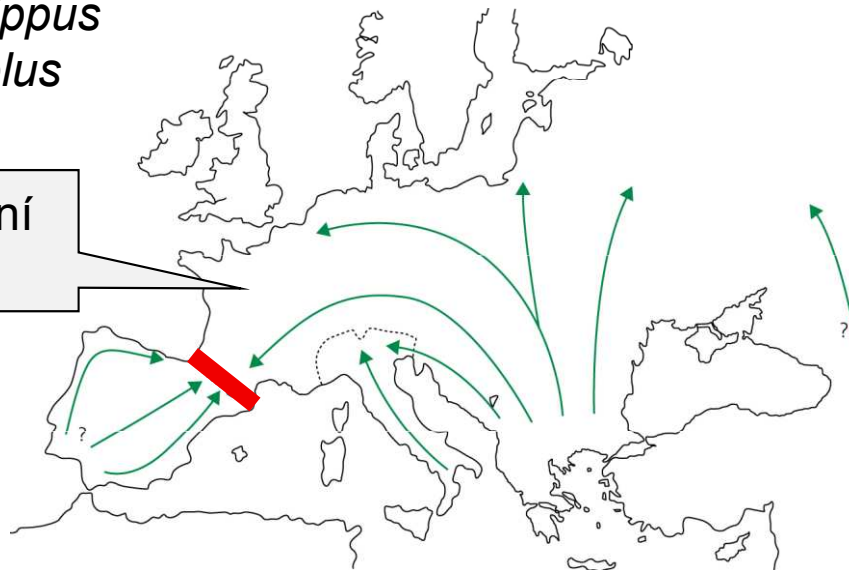

Ensatina eschscholtzii - klauberi

budníček zelený (*Phylloscopus trochiloides*)

Hybridizace:

James Mallet (TREE, 2005):

25% druhů cévnatých rostlin, 10% druhů živočichů

pravděpodobně podhodnocení (jen nápadné druhy: kachny, rajky, motýli)

často důvodem narušení prostředí:

např. cichlidy ve Viktoriině jezeře

„Darwinovy pěnkavy“ *Geospiza fuliginosa*, *G. fortis* a *G. scandens*
po El Niño



Geospiza fuliginosa



G. fortis



G. scandens

Možné výsledky hybridizace

a)

hybridní roj
(hybrid swarm)

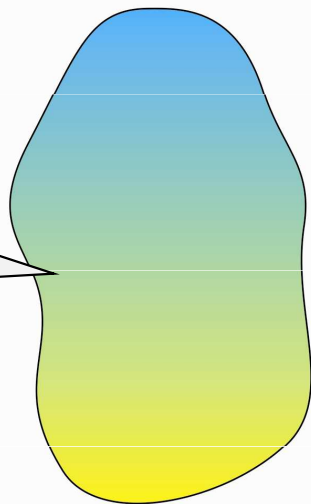

b)

hybridní zóna

hybridní zóna

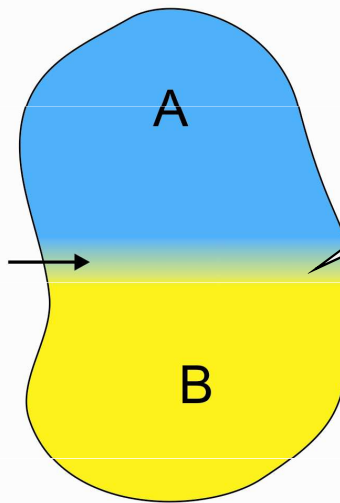

c)

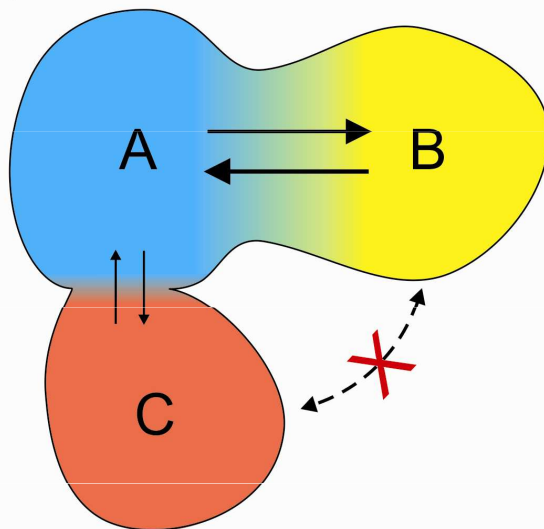

d)

hybridní taxon

nový
habitat

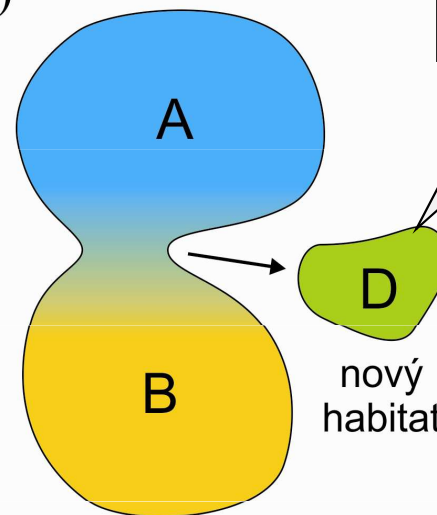

Program NewHybrids:

A Model-Based Method for Identifying Species Hybrids Using Multilocus Genetic Data

E. C. Anderson¹ and E. A. Thompson

Department of Statistics, University of Washington, Seattle, Washington 98195

Manuscript received October 3, 2001

Accepted for publication December 24, 2001

ABSTRACT

We present a statistical method for identifying species hybrids using data on multiple, unlinked markers. The method does not require that allele frequencies be known in the parental species nor that separate, pure samples of the parental species be available. The method is suitable for both markers with fixed allelic differences between the species and markers without fixed differences. The probability model used is one in which parentals and various classes of hybrids (F_1 's, F_2 's, and various backcrosses) form a mixture from which the sample is drawn. Using the framework of Bayesian model-based clustering allows us to compute, by Markov chain Monte Carlo, the posterior probability that each individual belongs to each of the distinct hybrid classes. We demonstrate the method on allozyme data from two species of hybridizing trout, as well as on two simulated data sets.

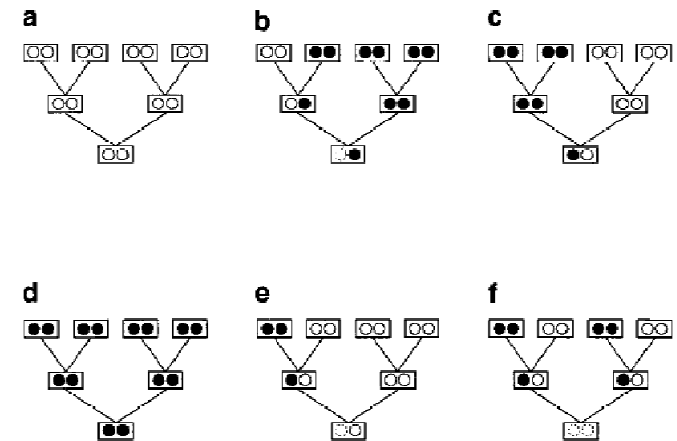
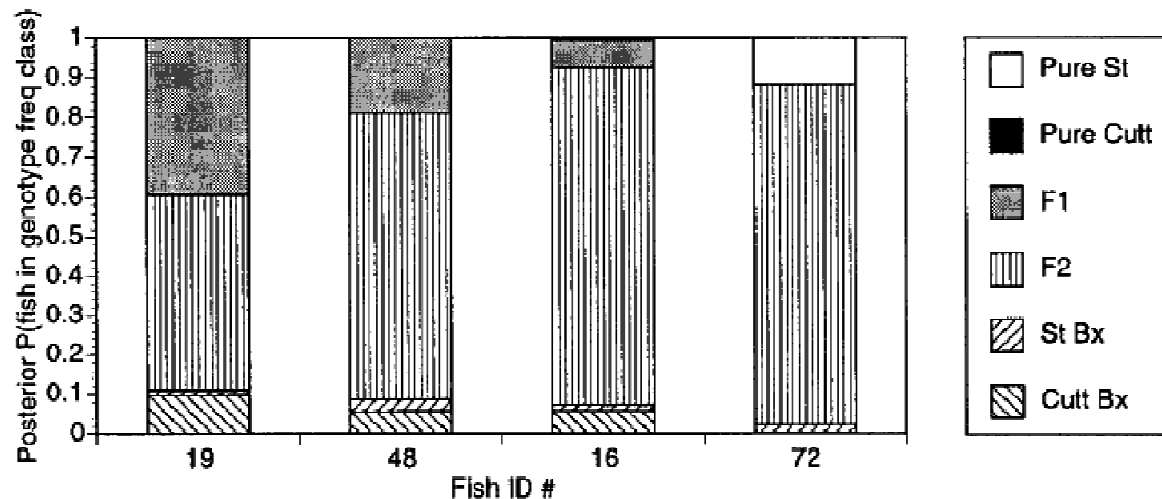
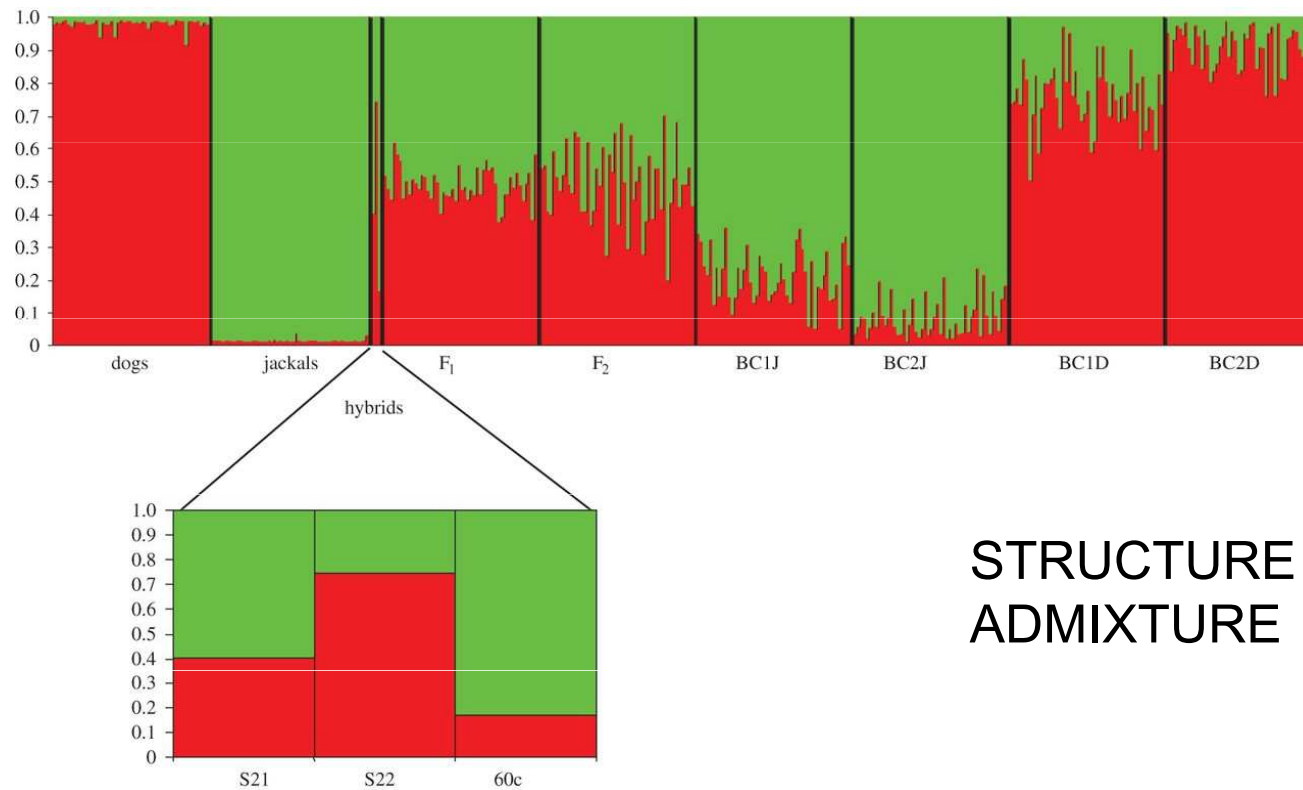
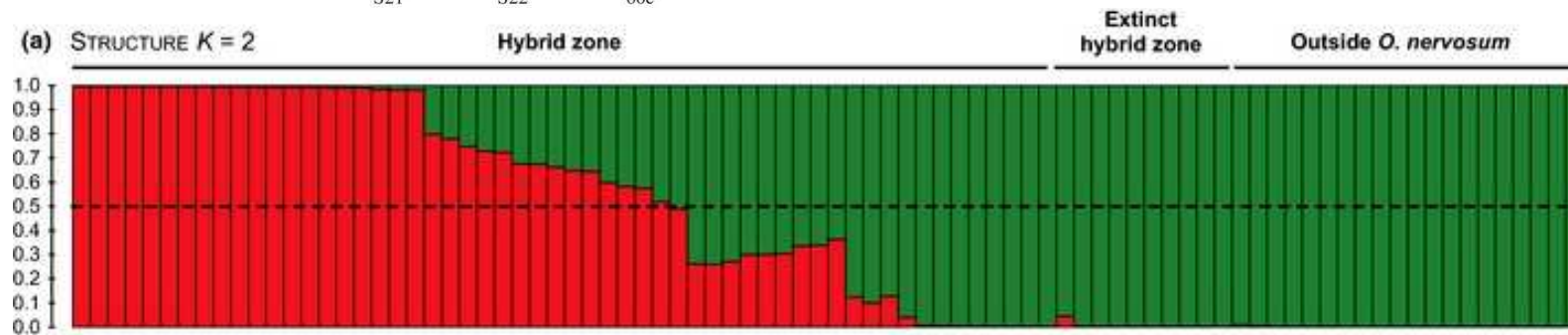

FIGURE 1.—Six arrangements of founders on a pedigree of $n = 2$ generations. Each box represents a locus. The circles within each box represent the two genes possessed by the diploid organism at the locus. The founders are the individuals in the top row of each pedigree. Black gene copies are those originating from the species A population, and the white genes are from species B. Genes that are not determined to be either black or white by the pedigree and the founders in it are denoted by broken circles. The individual at the bottom of each pedigree belongs to a different hybrid class, determined by the arrangement of species among the founders. a–f represent six distinct *genealogical classes*. a–f also represent six distinct *genotype frequency classes*. There are, however, only five distinct *gene frequency classes*; the individuals at the bottoms of pedigrees c and f are both in the same gene frequency class.





(a) STRUCTURE $K = 2$



(b) NEWHYBRIDS

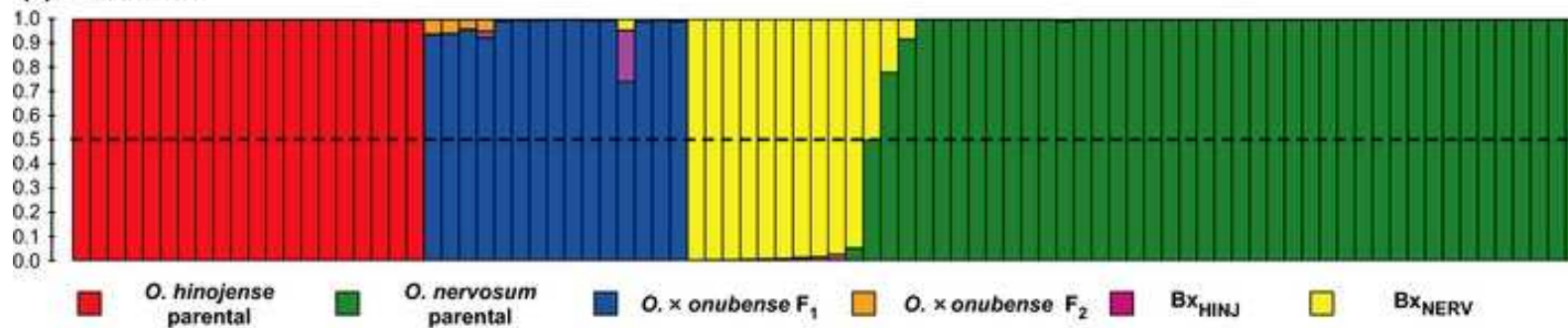

Test hybridizace v éře celogenomových dat:
ABBA/BABA test (Pattersonova D-statistika):

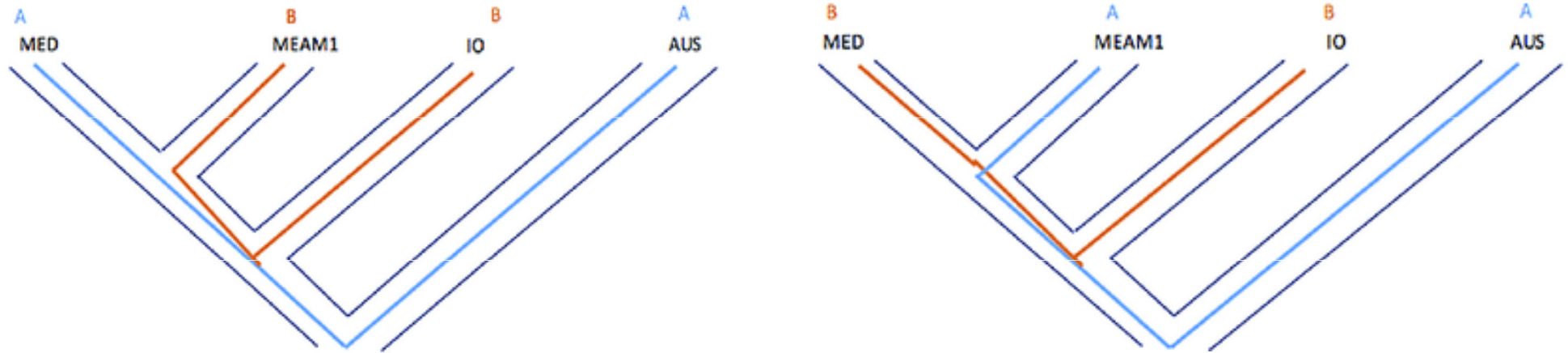

Př.: hybridizace člověka a neandertálce

Hybridní zóna (Barton a Hewitt 1985)

= oblast, ve které se dvě geneticky odlišné populace setkávají, kříží a dávají vzniknout alespoň nějakému hybridnímu potomstvu

Hybridní zóny můžeme dělit na:

primární

sekundární

tenzní (*tension*), mozaikové (*mosaic*), odsazené (*staggered*), „*mottled*“ ...

extrinsic selection (vnější prostředí)

intrinsic selection (prezygotické nebo postzygotické bariéry)

Mozaiková hybridní zóna:

vliv vnějšího prostředí

vlastně soubor několika hybridních zón

př.: *Gryllus firmus* x *G. pennsylvanicus* (SV USA)
písčité x hlinité půdy

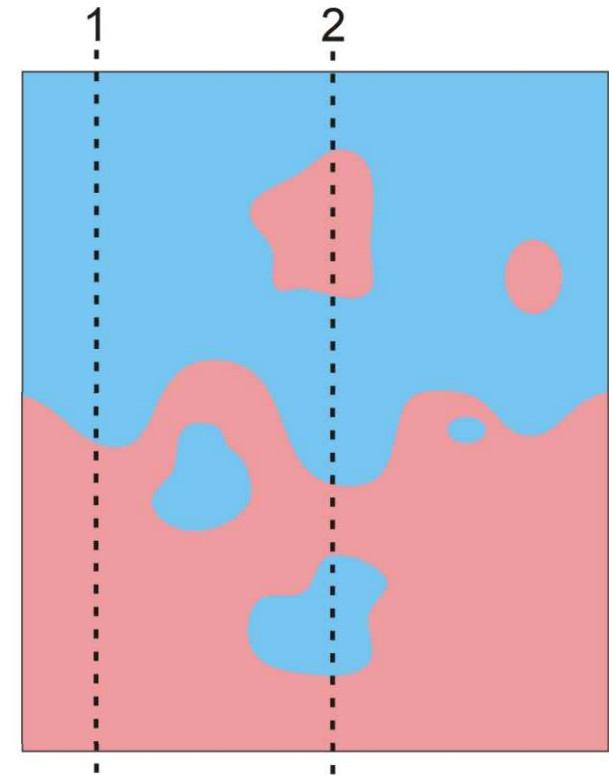

Iris fulva x *I. brevicaulis*:

I. fulva se omezuje na zalesněnější místa

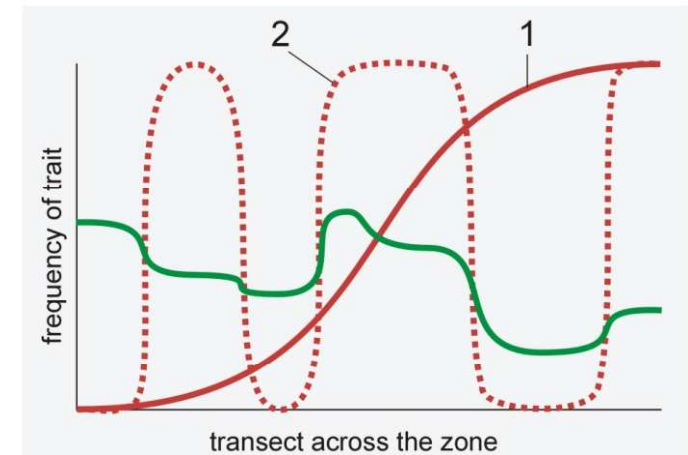

Bombina:



kuňka obecná
B. bombina:

nížiny
převážně ve vodě
větší vodní plochy
tenčí kůže
teritoriální
530 Hz
delší vývoj

v Chorvatsku mozaiková
HZ, v Polsku ne

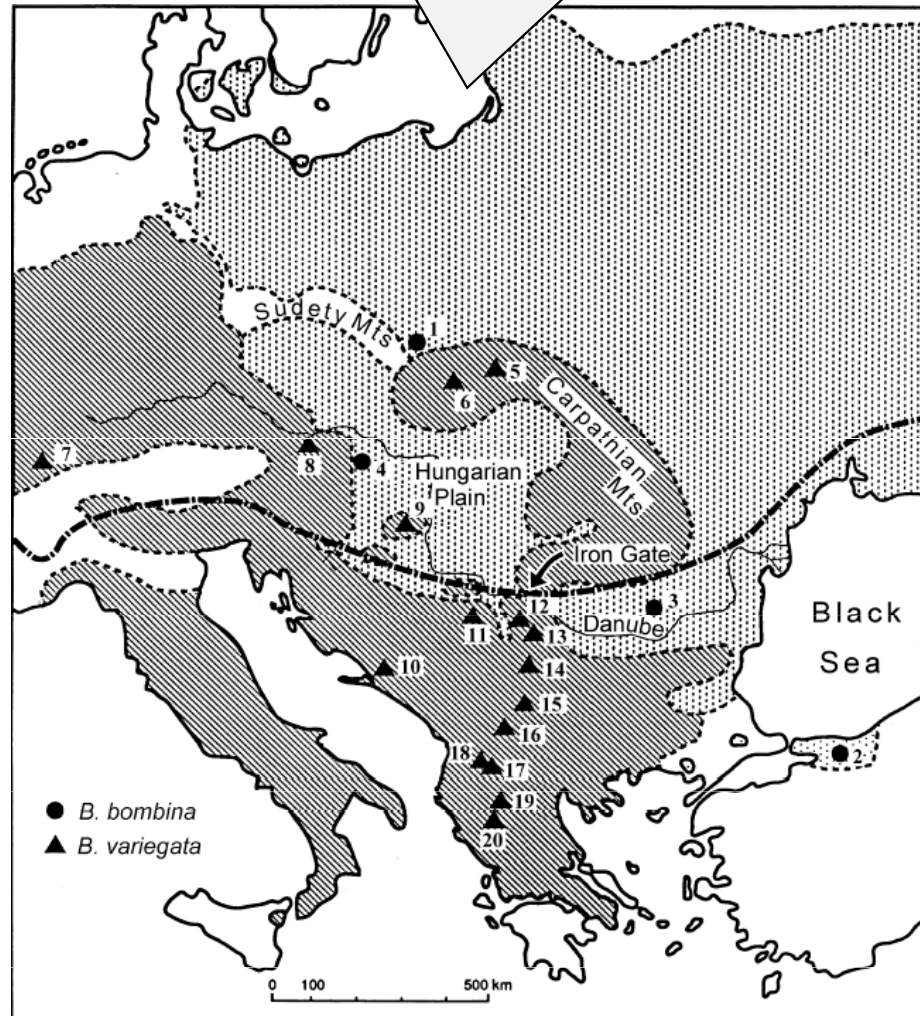

k. žlutobřichá
B. variegata:

hory, pahorkatiny
terestrická
rozmn. v loužích
tlustá kůže
neteritoriální
580 Hz
kratší vývoj



Nick Barton

Most hybrid zones are
tension zones.

... i.e., they are maintained by balance between
dispersal and selection (Barton & Hewitt, 1985)

Tenzní zóna je když...

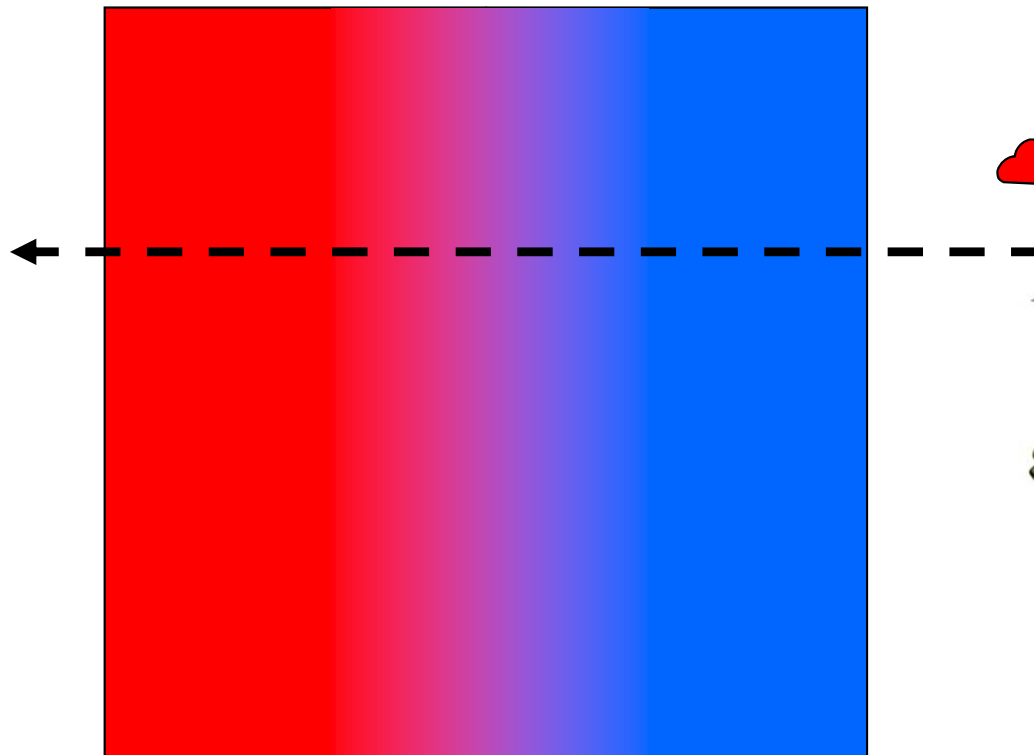

Tenzní zóna je když...

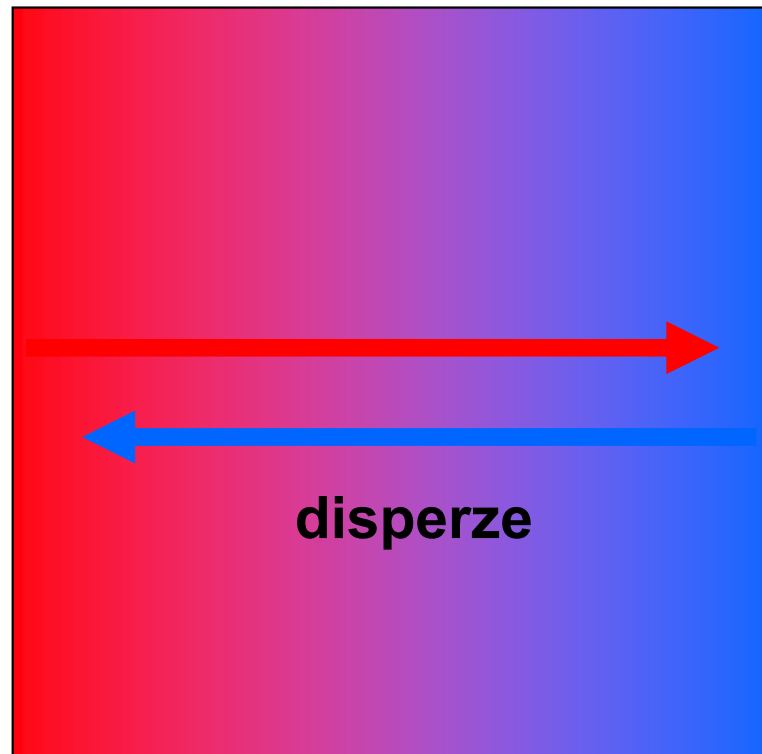

⇒ rozšiřování zóny

Tenzní zóna je když...

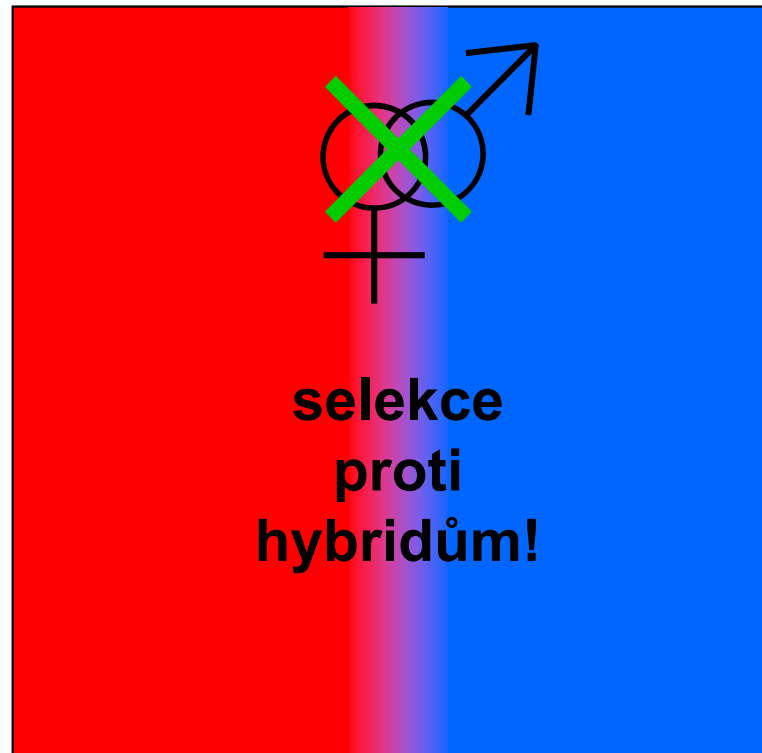

⇒ **zužování zóny**

Tenzní zóna udržována dynamickou rovnováhou mezi *disperzí* a *selekcí*

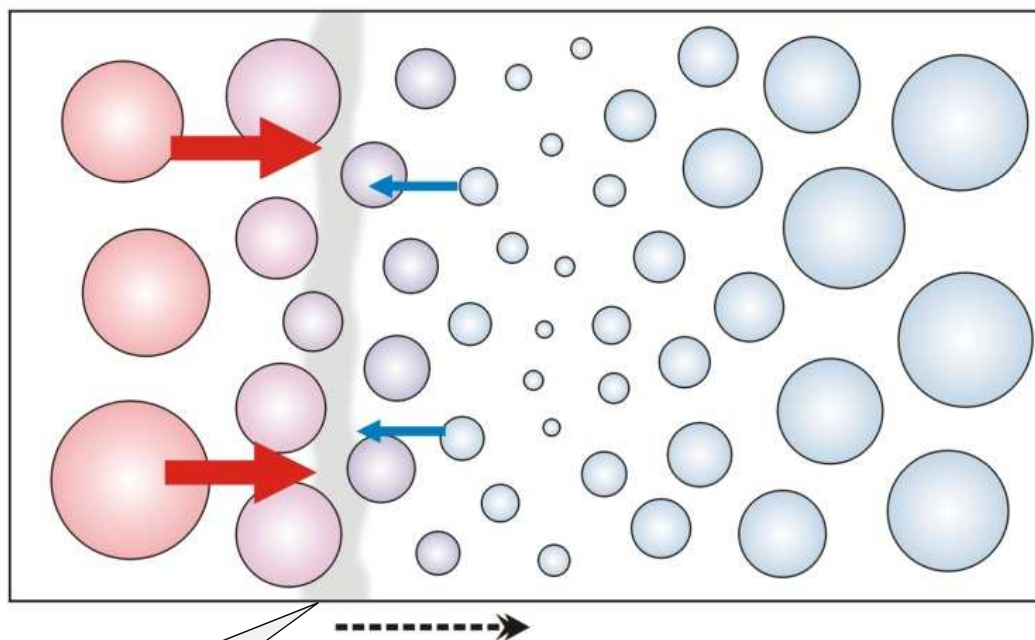

tenzní zóna se pohybuje
ve směru gradientu
populační hustoty

Tenzní zóna není závislá na vnějších podmínkách (*intrinsic selection*)
⇒ její pozice se ustálí na místě geografické překážky
nebo nejnižší populační hustoty („*population trough*“)

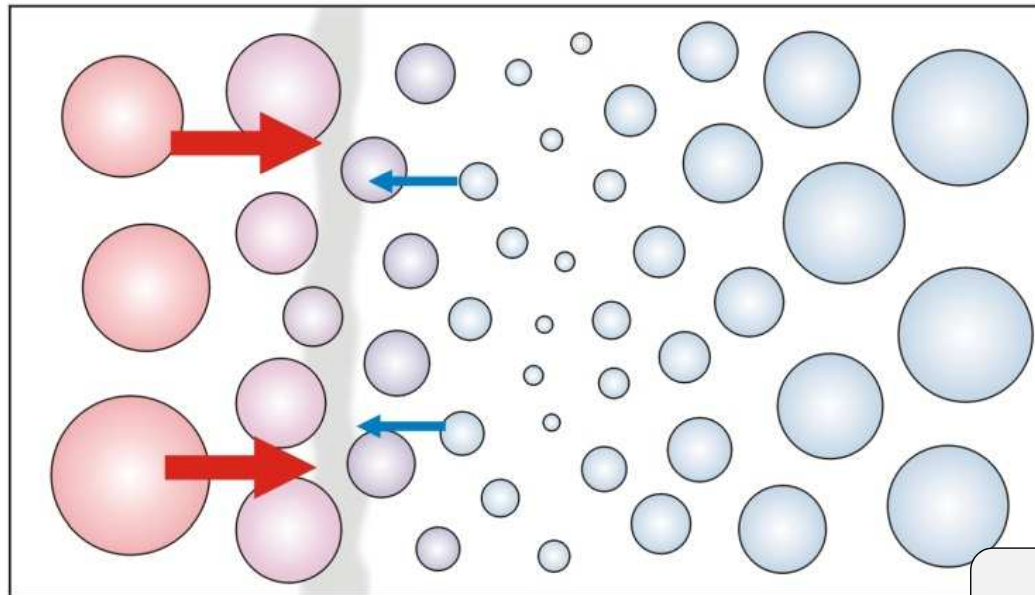

„population trough“

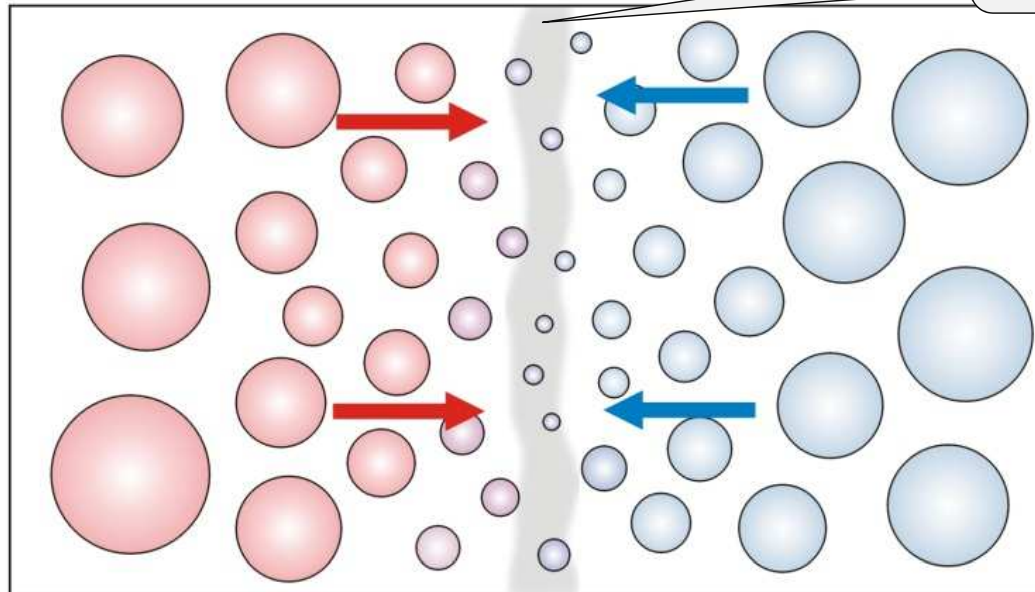

tenzní zóna se pohybuje
ve směru gradientu
populační hustoty

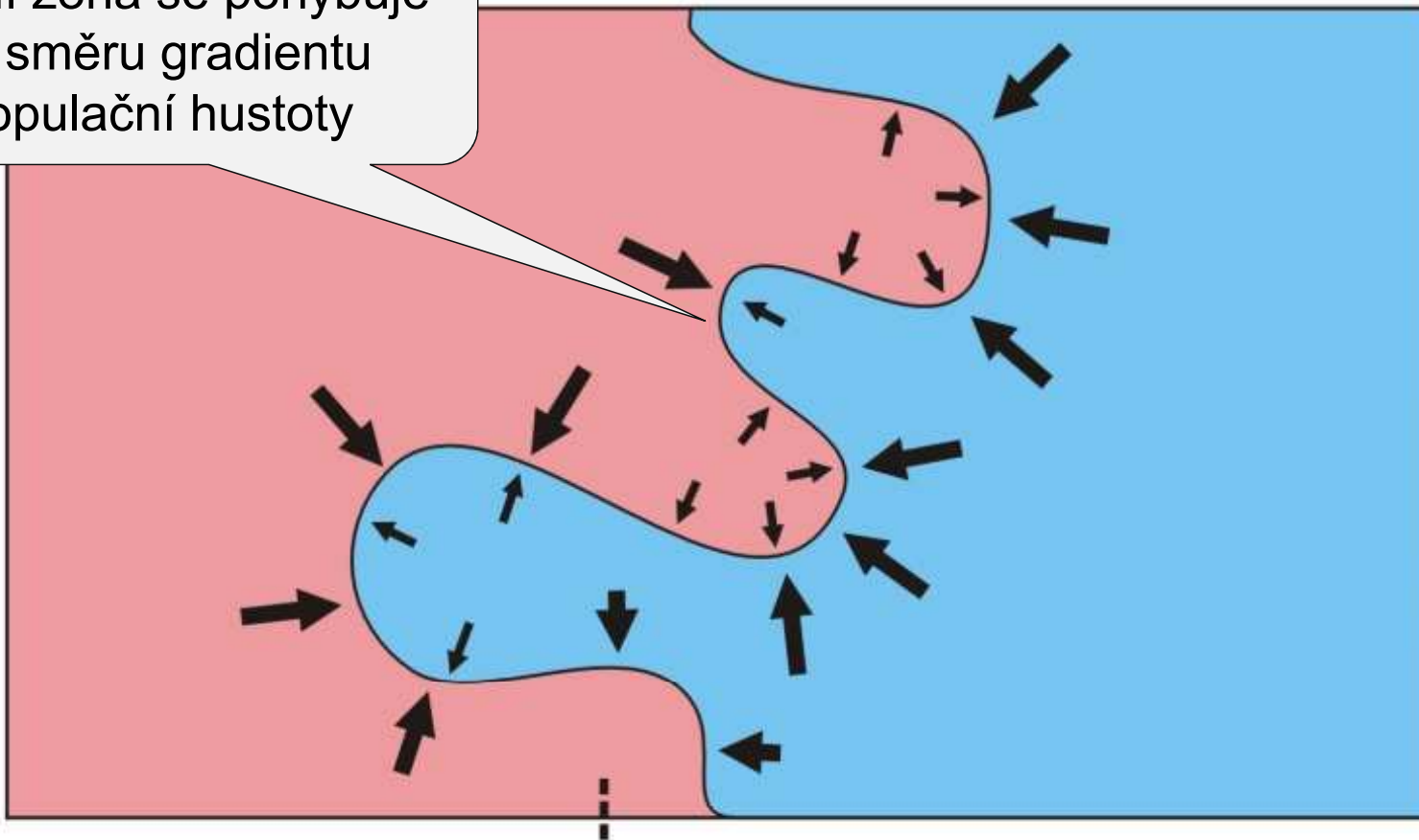

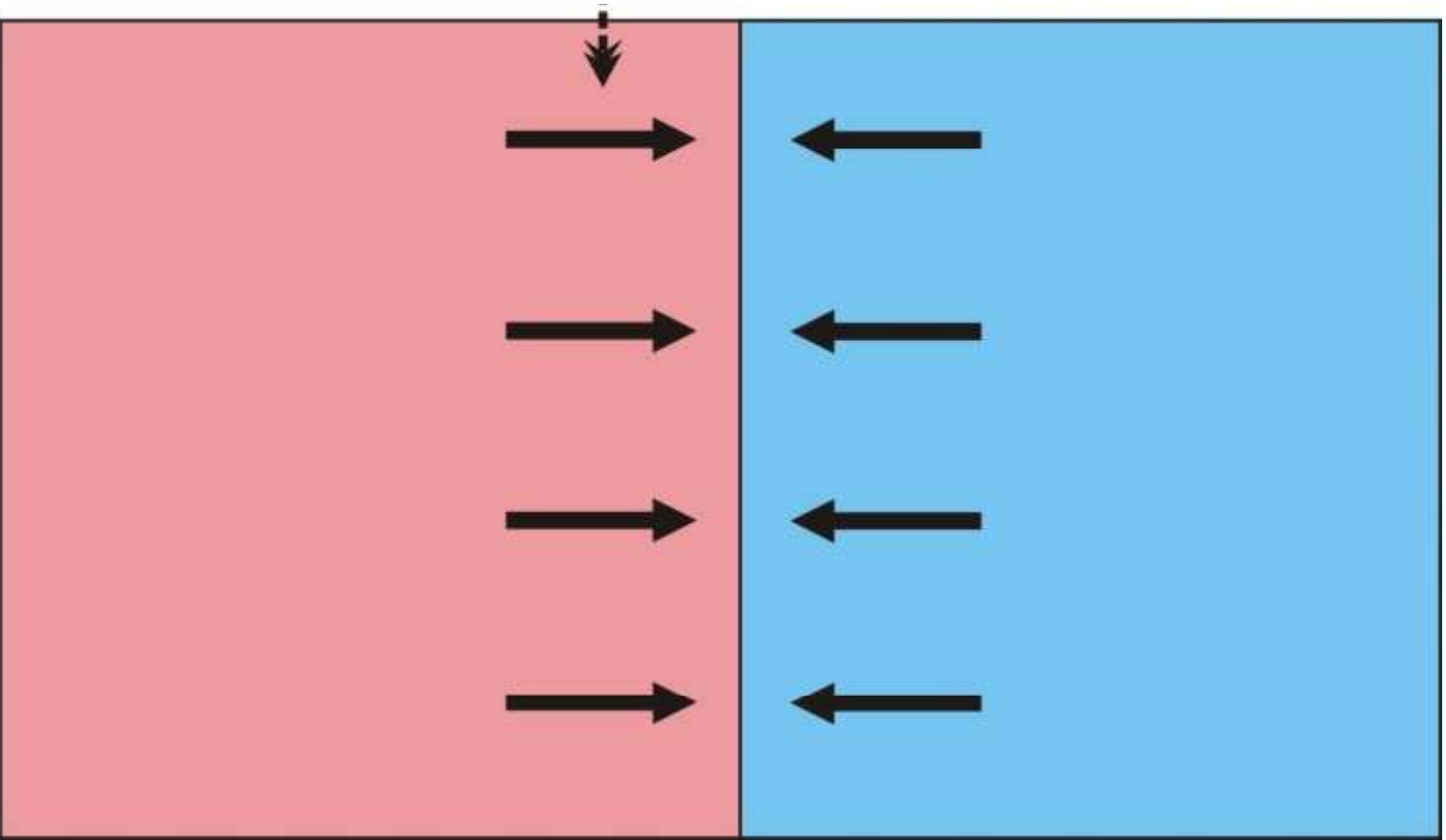

Teorie klin:

sekundární kontakt:  koincidentní a konkordantní klíny

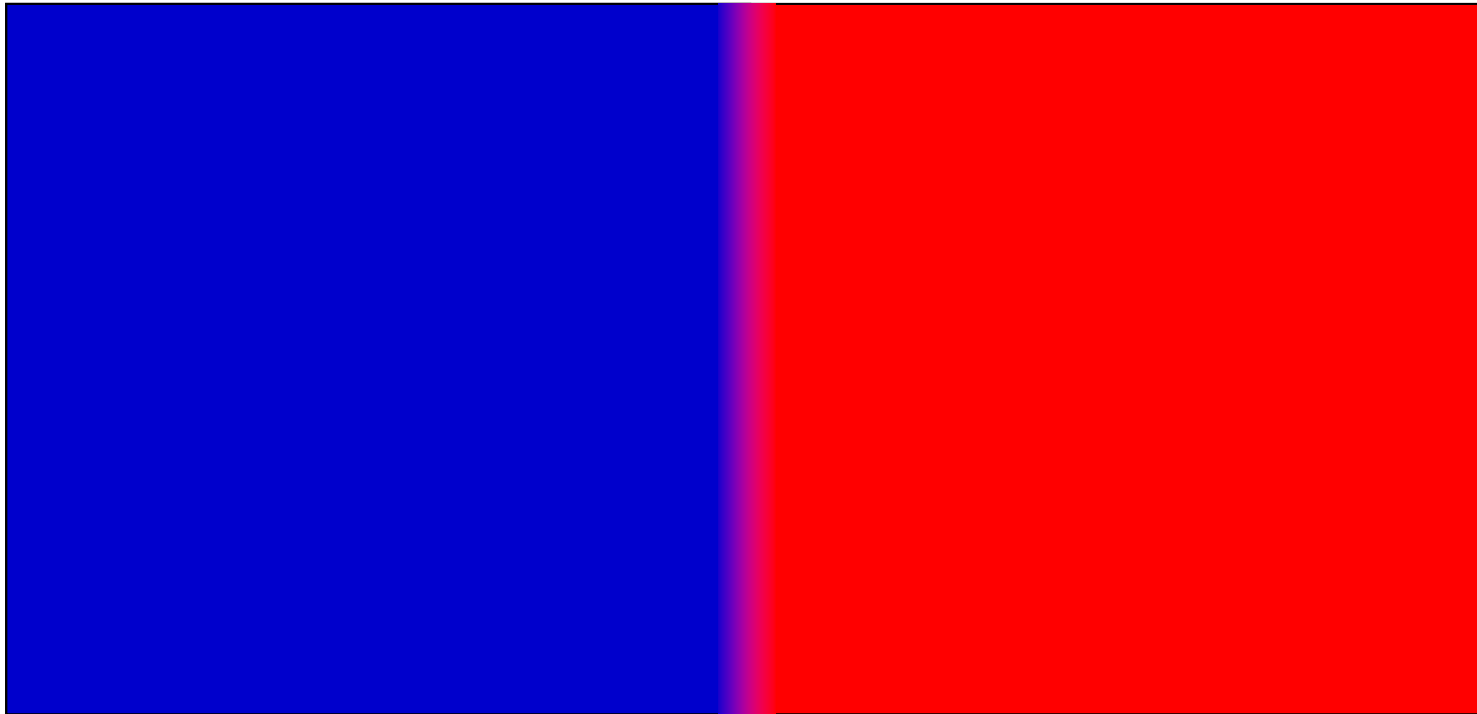

Klína = gradient znaku (např. frekvence alely nebo průměr kvantitativního znaku) přes prostorově kontinuální habitat

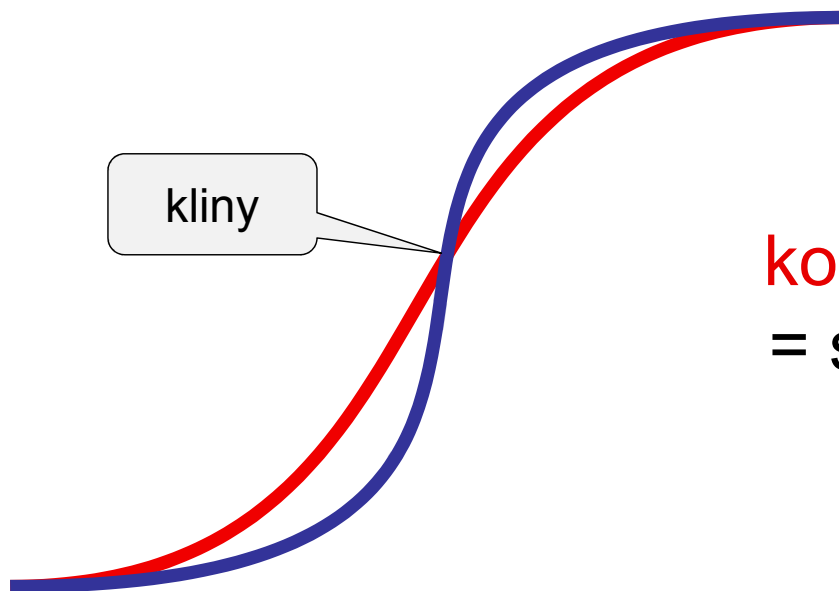

kliny

koincidence (*coincidence*)
= souhlasná pozice středů

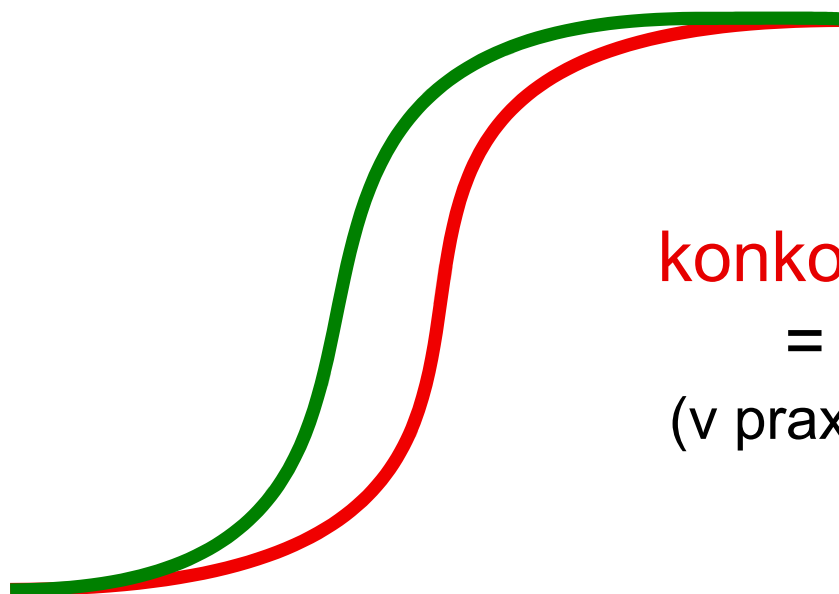

konkordance (*concordance*)
= souhlasný tvar klin
(v praxi většinou souhlasné šířky)

sekundární kontakt

klina

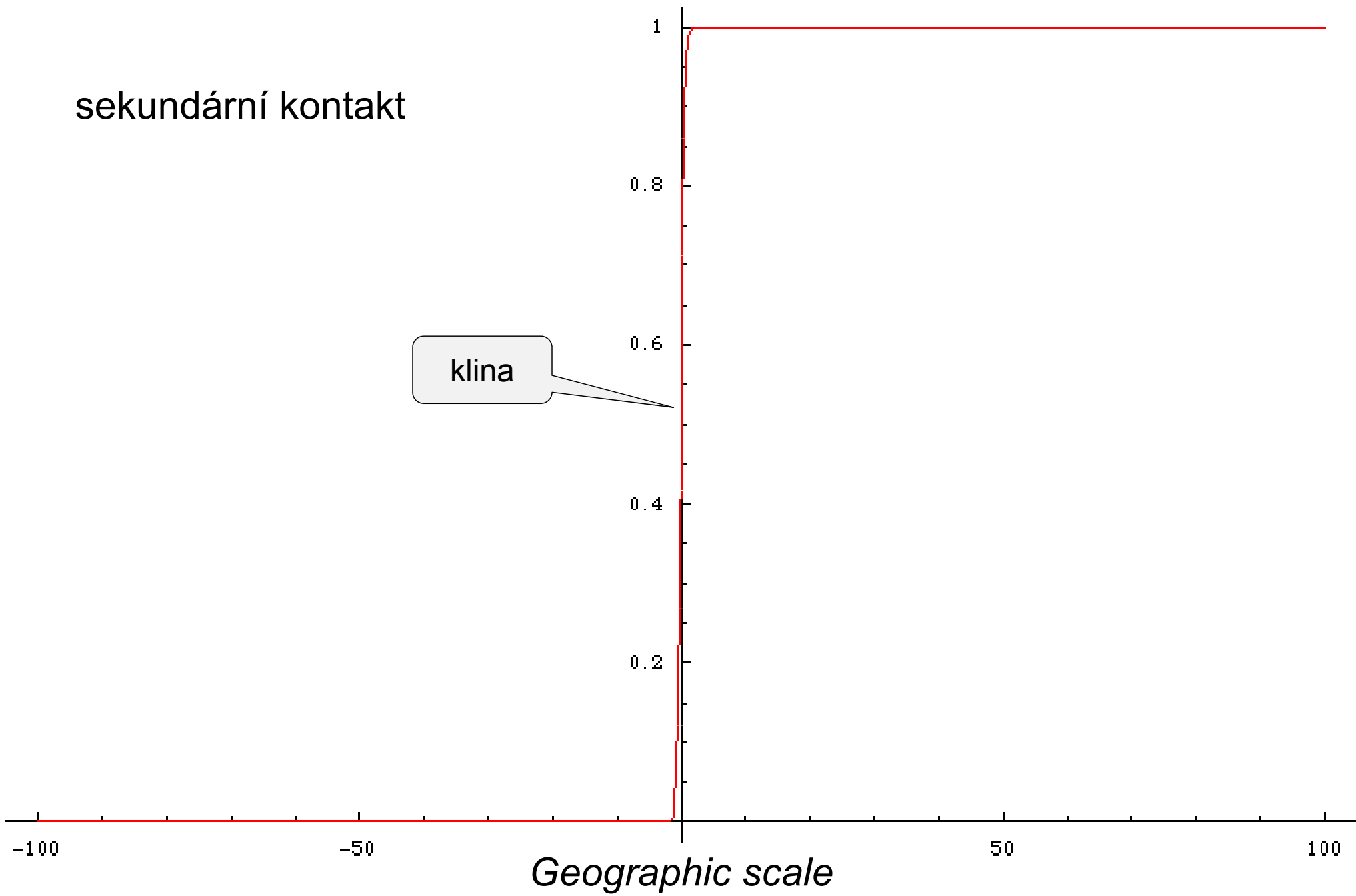

difuze neutrálního markeru

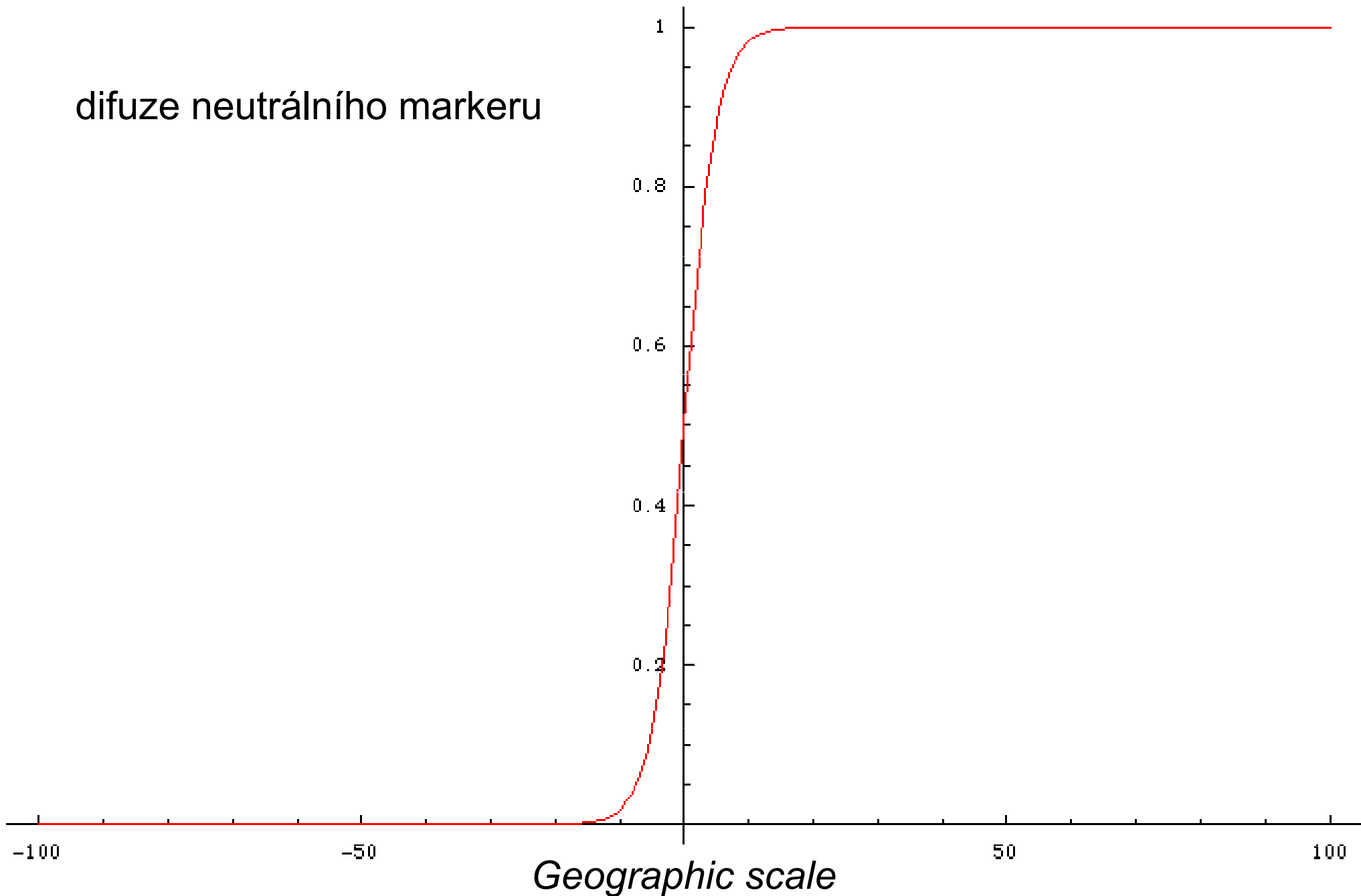

difuze neutrálního markeru

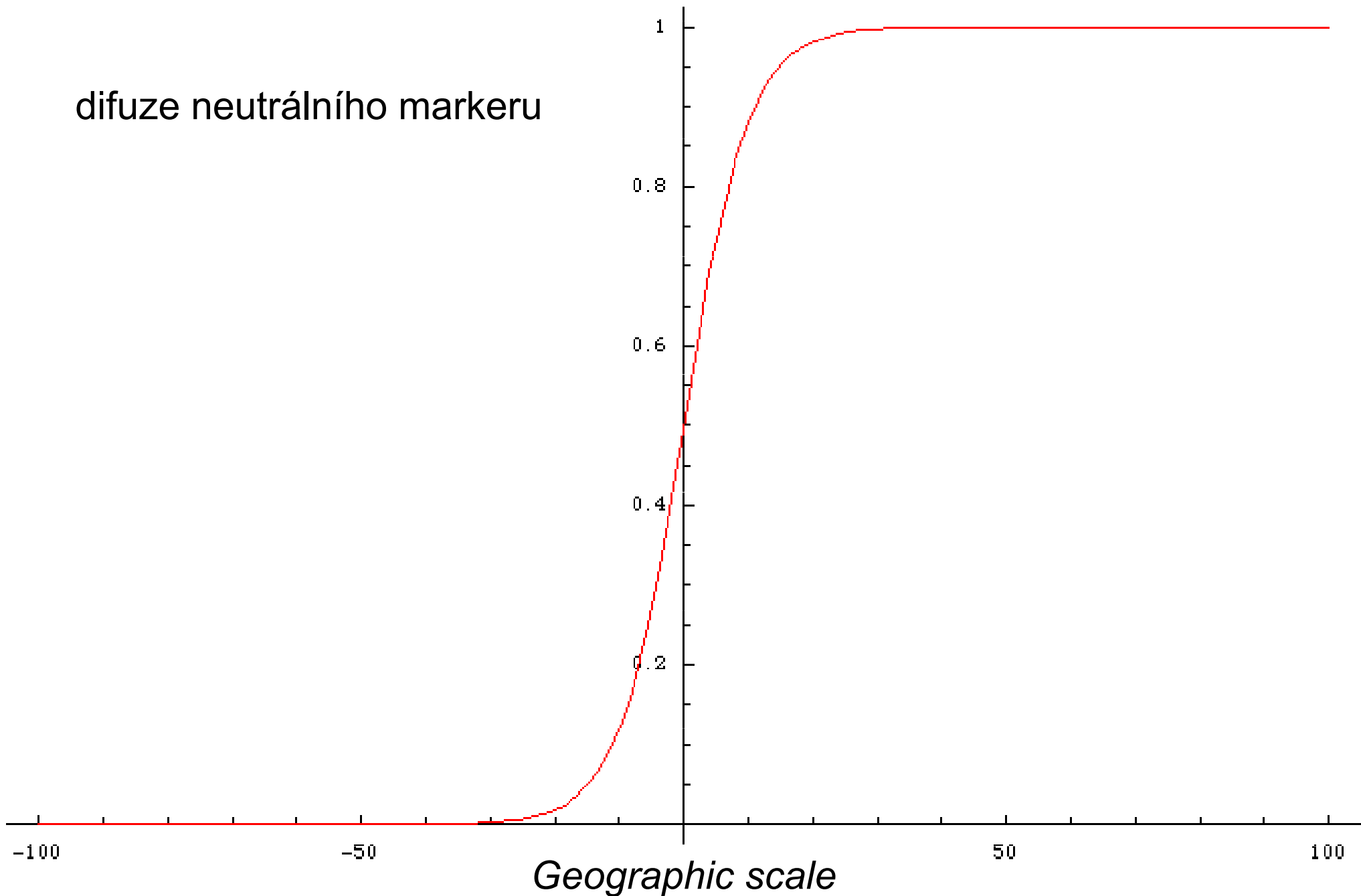

difuze neutrálního markeru

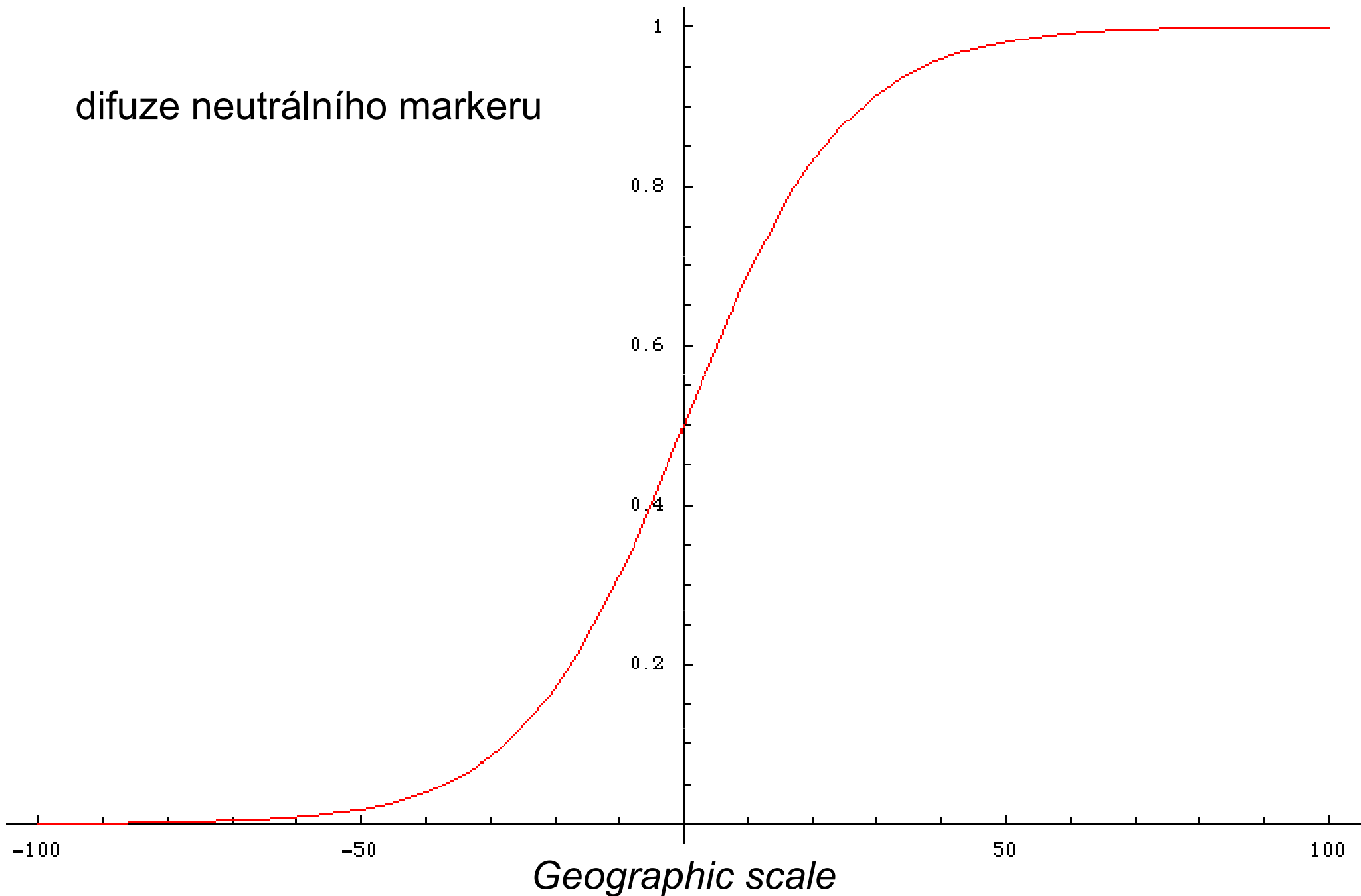

difuze neutrálního markeru

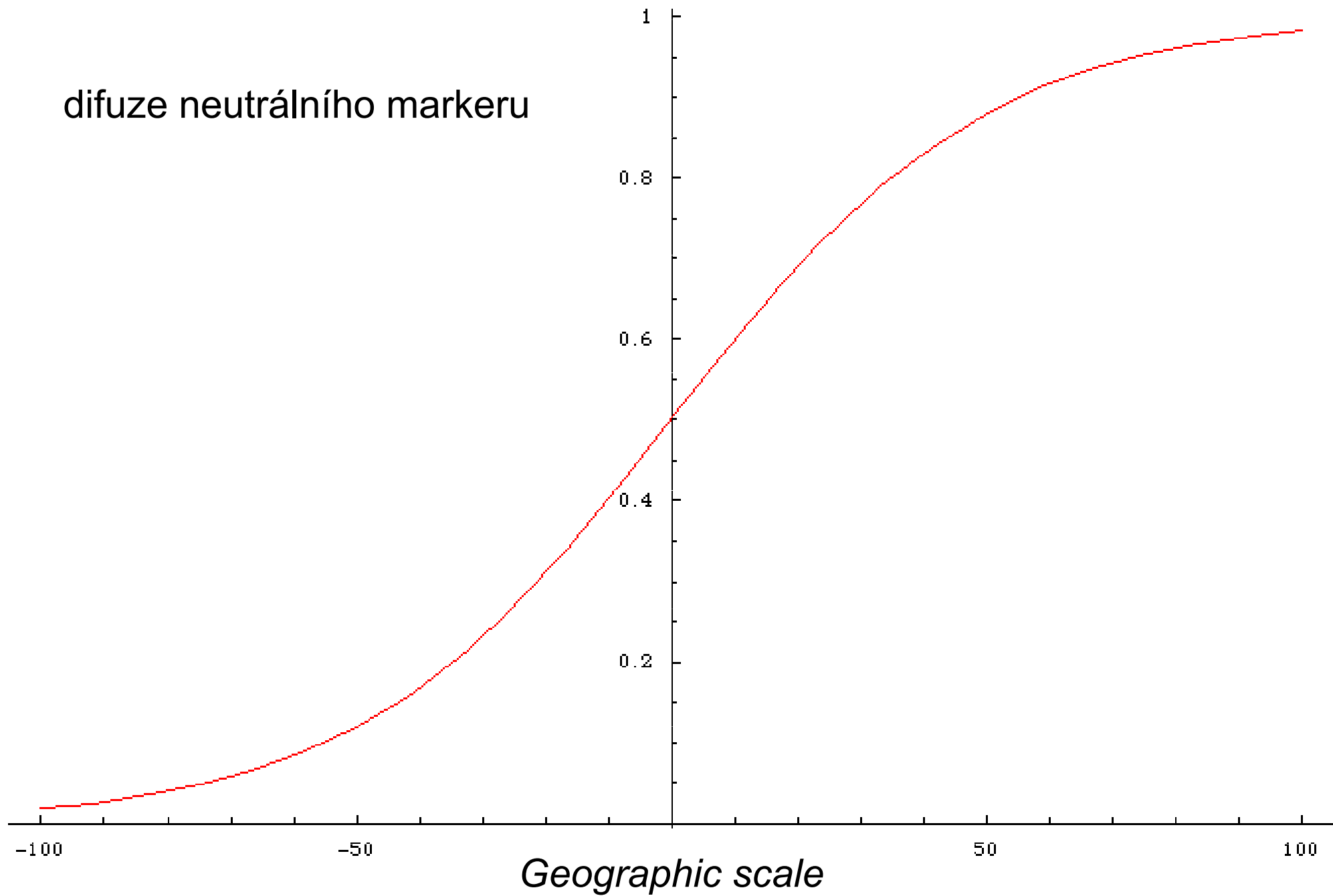

Teorie klin:

neutrální vs. selektované lokusy

neutrální lokus

selekce proti hybridům

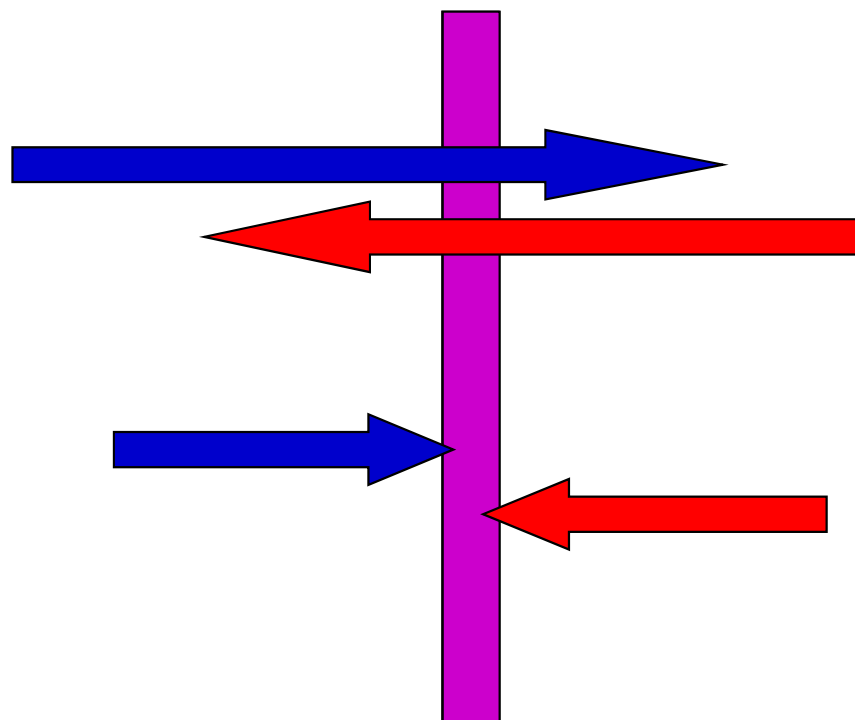

neutrální vs. selektované lokusy

s postupujícím časem konkordance mizí ...

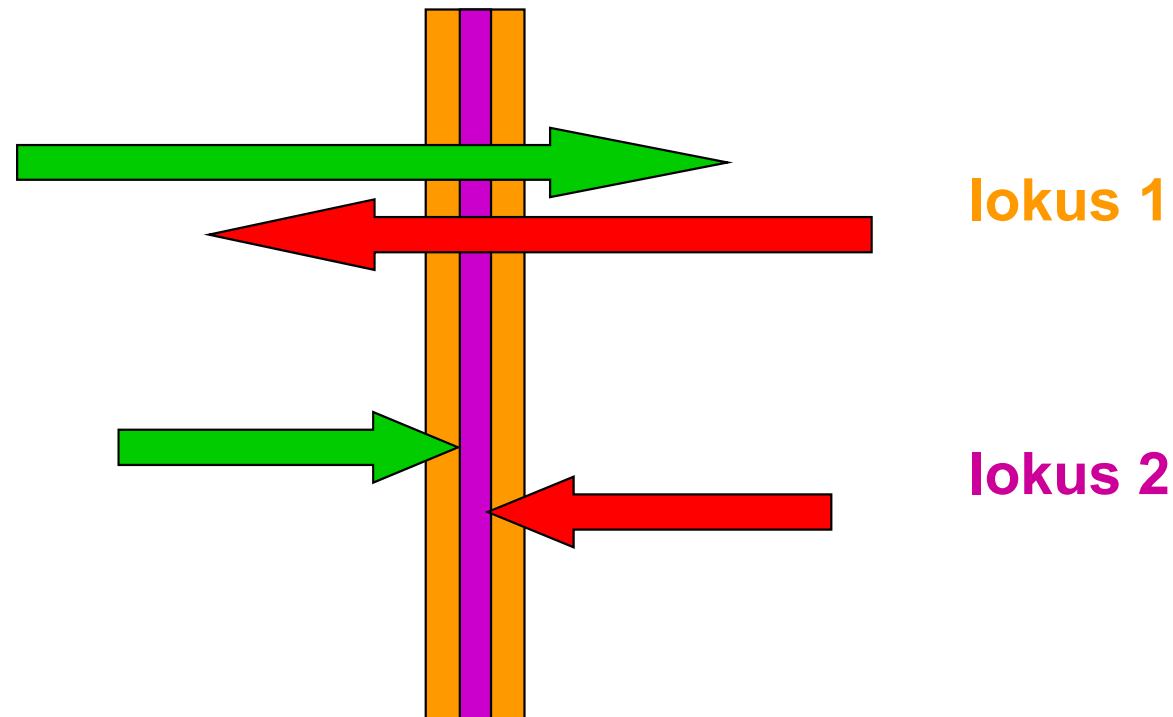

... ale (u tenzní zóny) selekce tlačí klíny pro jednotlivé lokusy k sobě
⇒ udržuje koincidenci

občas ...

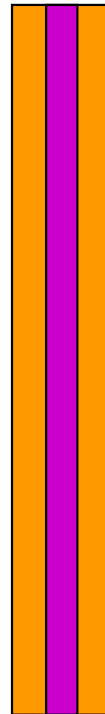

lokus 1

lokus 2

... ale klíny stále paralelní

klinální modely (difuzní aproximace atd.), vazebná nerovnováha,
evoluční parametry

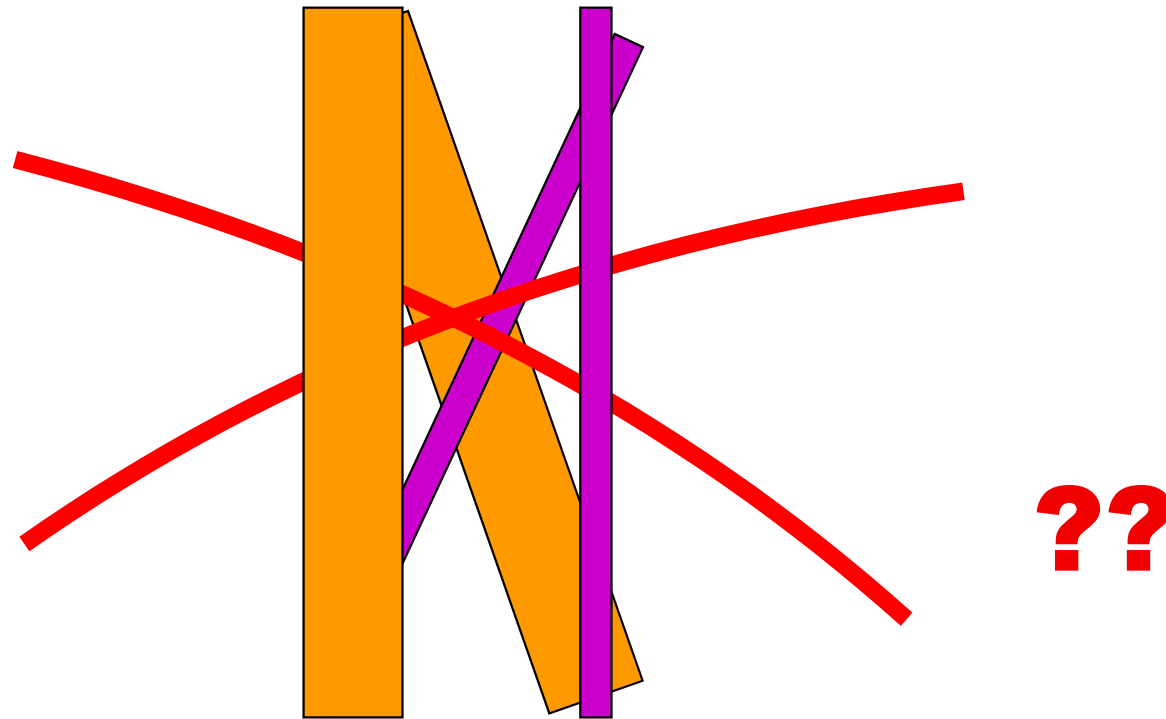

problém, jak analyzovat

Studium hybridní zóny

1. Vzorky podél lineárního nebo 2D transektu, geografické koordináty lokalit
2. Genetická (morfologická, behaviorální atd. analýza)
... problém nezávislosti vzorků (F_{ST} , F_{IS} ... efektivní počet alel)
3. Geografické klíny
4. Odhad disperze, selekce a dalších parametrů
5. Alternativní přístupy:
monotónní klíny
2D analýza
genomické klíny
konkordanční analýza

Případová studie: hybridní zóna domácích myší



musculus



domesticus



Myší kolonizace Evropy

Neolit



Cucchi et al. (2005)

Myší kolonizace Evropy

Doba bronzová a železná

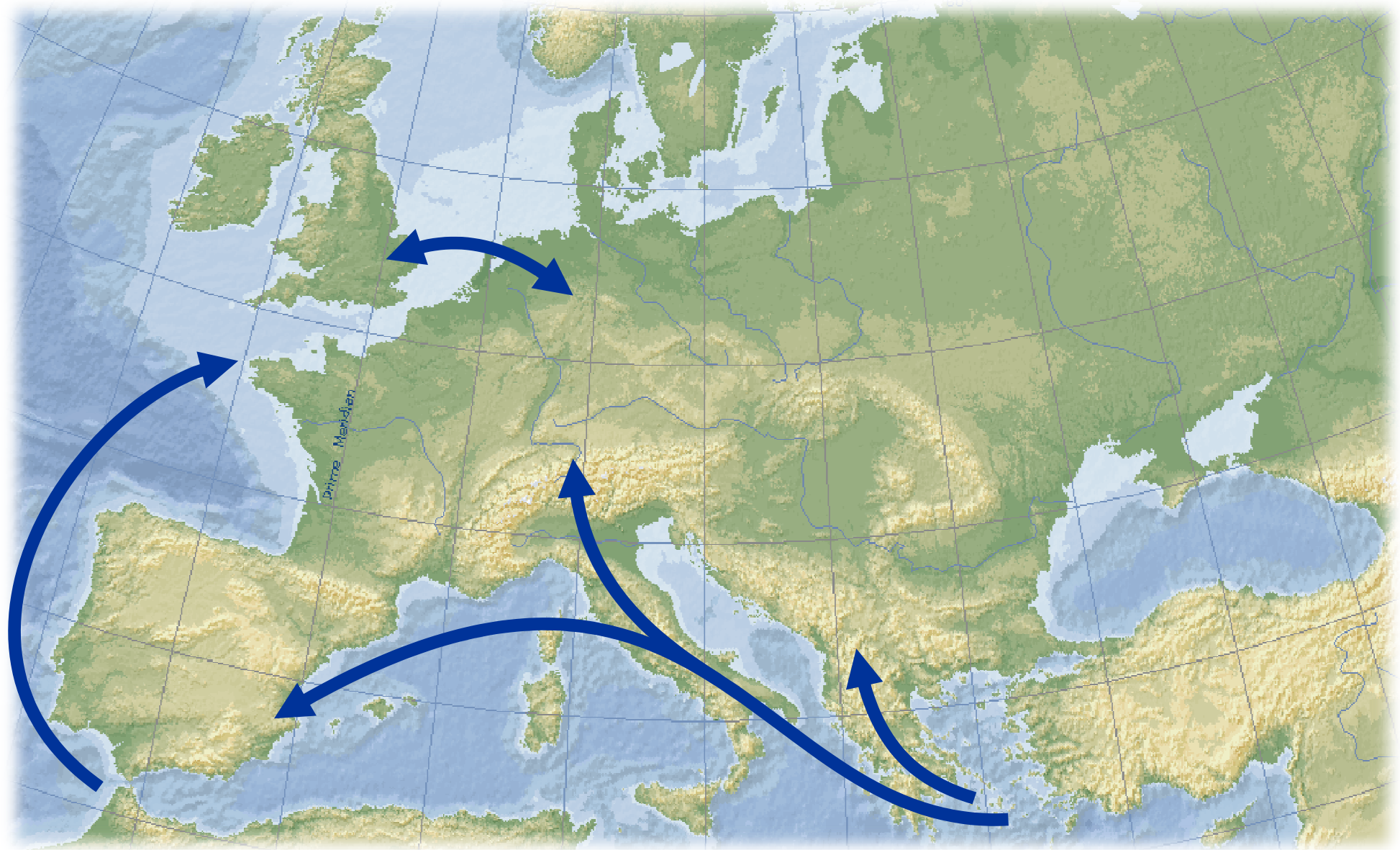

Cucchi et al. (2005)

Myší kolonizace Evropy

Pozdní neolit

pol. 4. tisíciletí BC

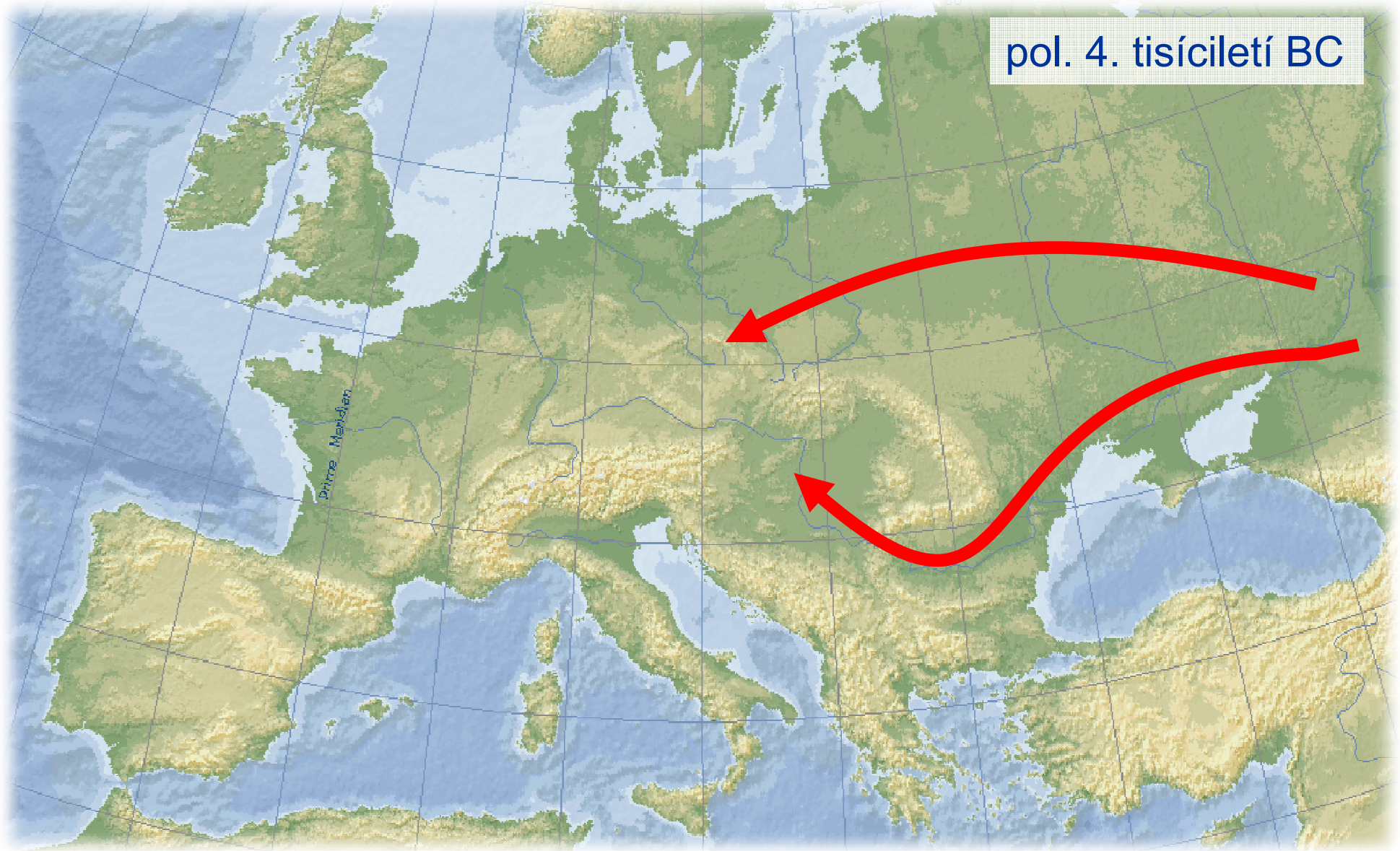

Cucchi et al. (2011)

Myší kolonizace Evropy

Vikingové



Prager et al. (1993); Searle et al. (2009)

Hybridní zóna v Evropě

musculus



neznáme přesně
dobu vzniku...

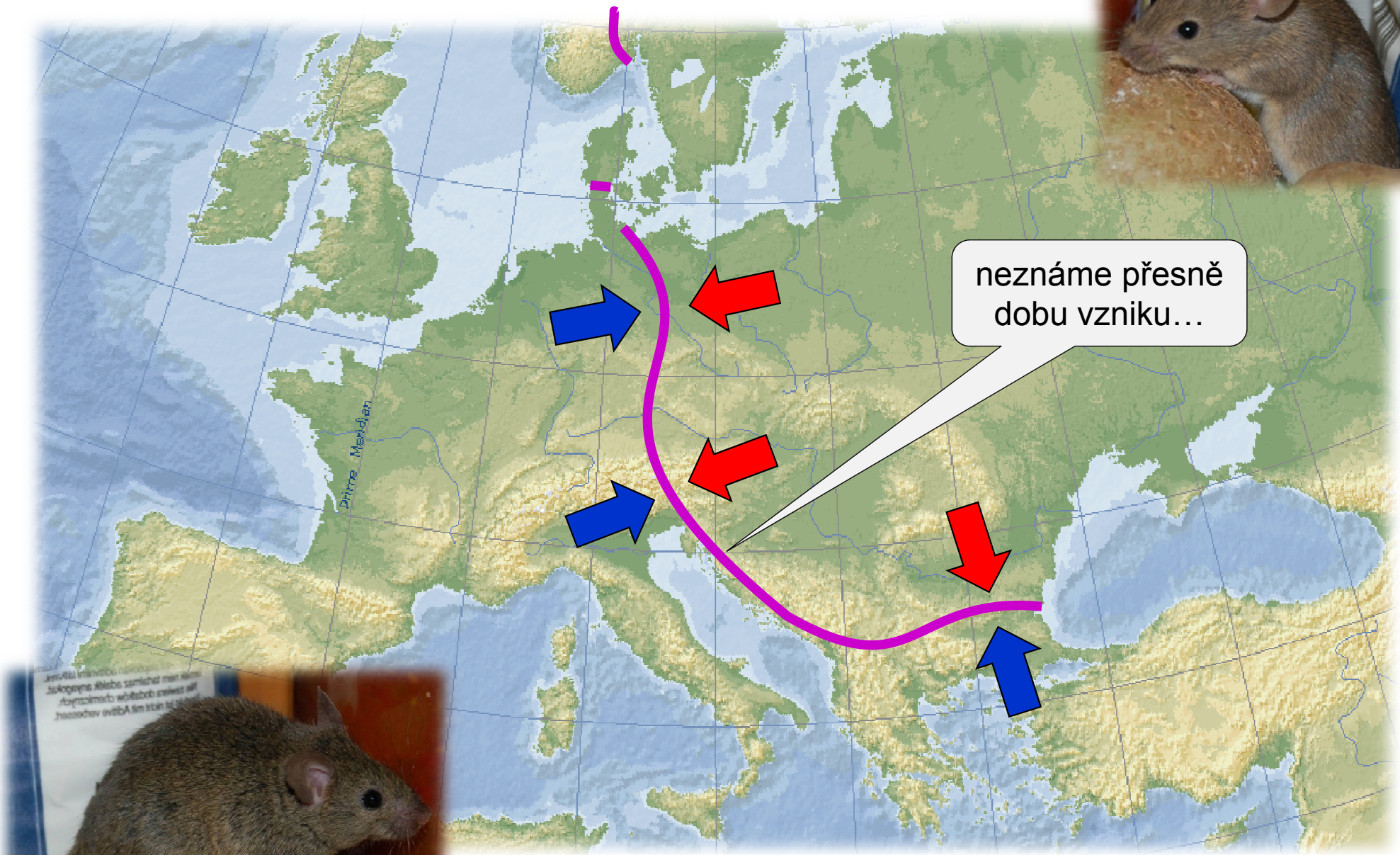

domesticus

Hybridní zóna v Evropě



Co tuto zónu ovlivňuje?

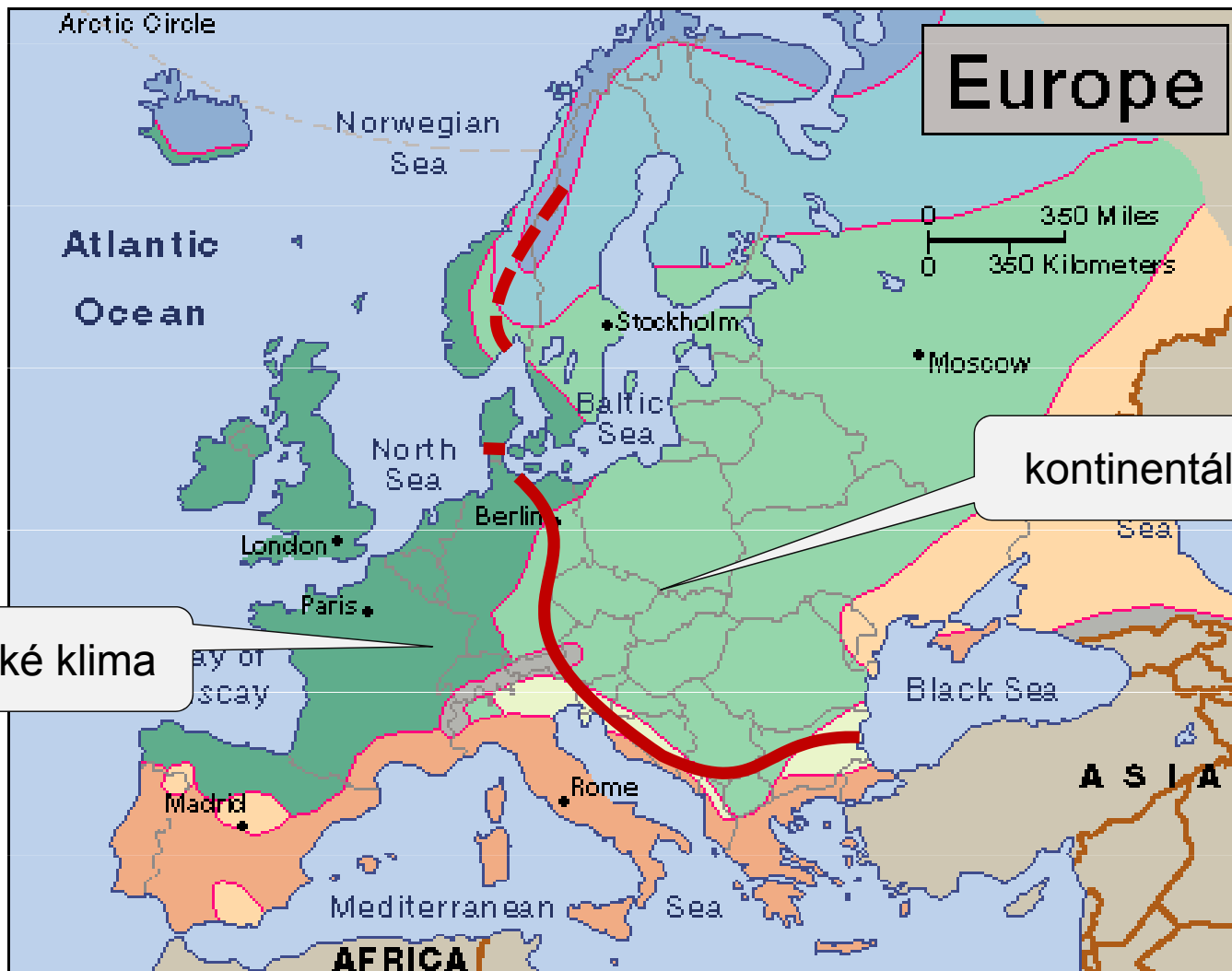

oceánské klima

kontinentální klima

- | | |
|--|---|
|  Semi-arid |  Humid continental |
|  Subtropical dry summer |  Subarctic |
|  Humid subtropical |  Tundra |
|  Humid oceanic |  Highland |

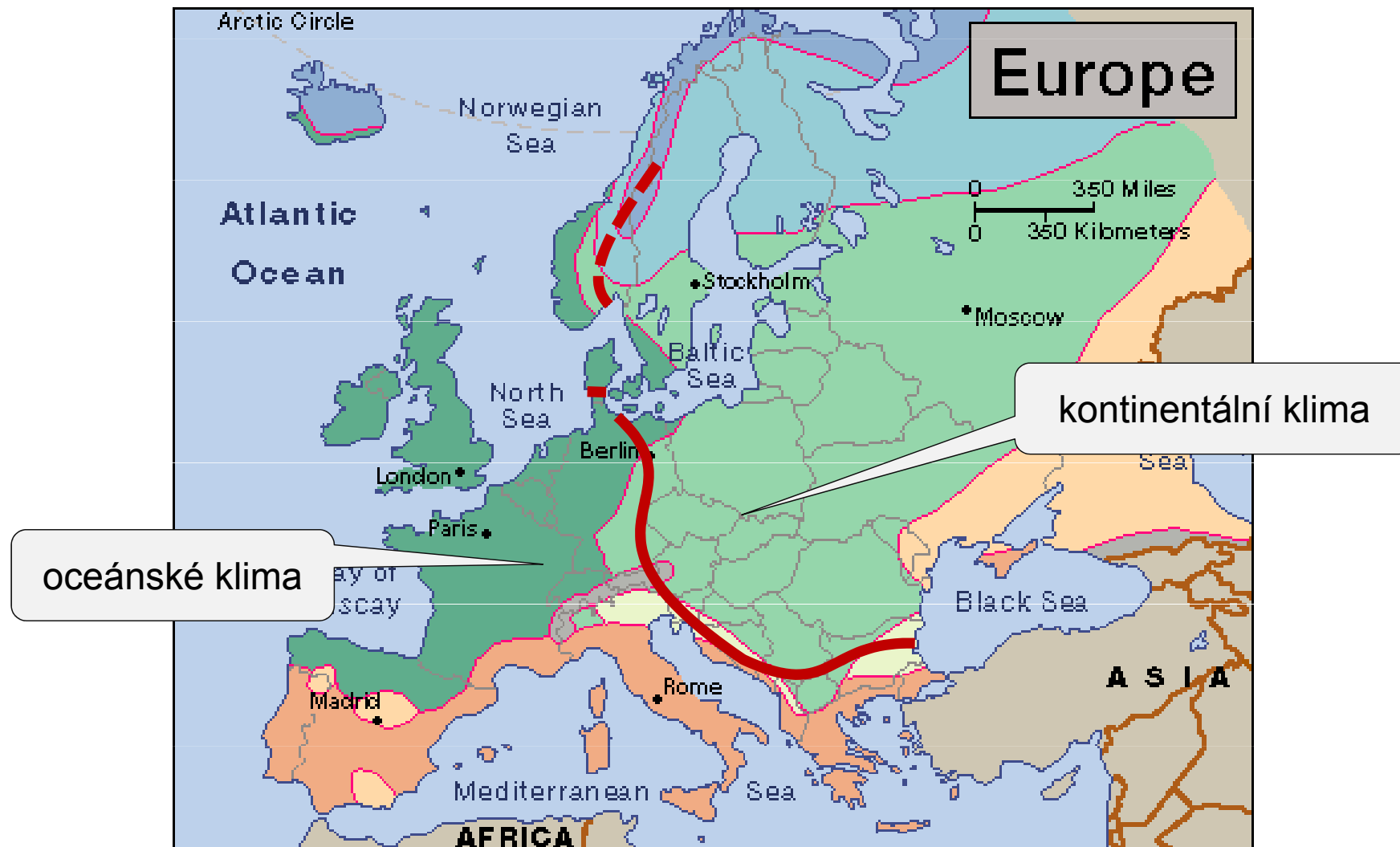

klimatické faktory nehrají roli

Hybridní zóna v Evropě

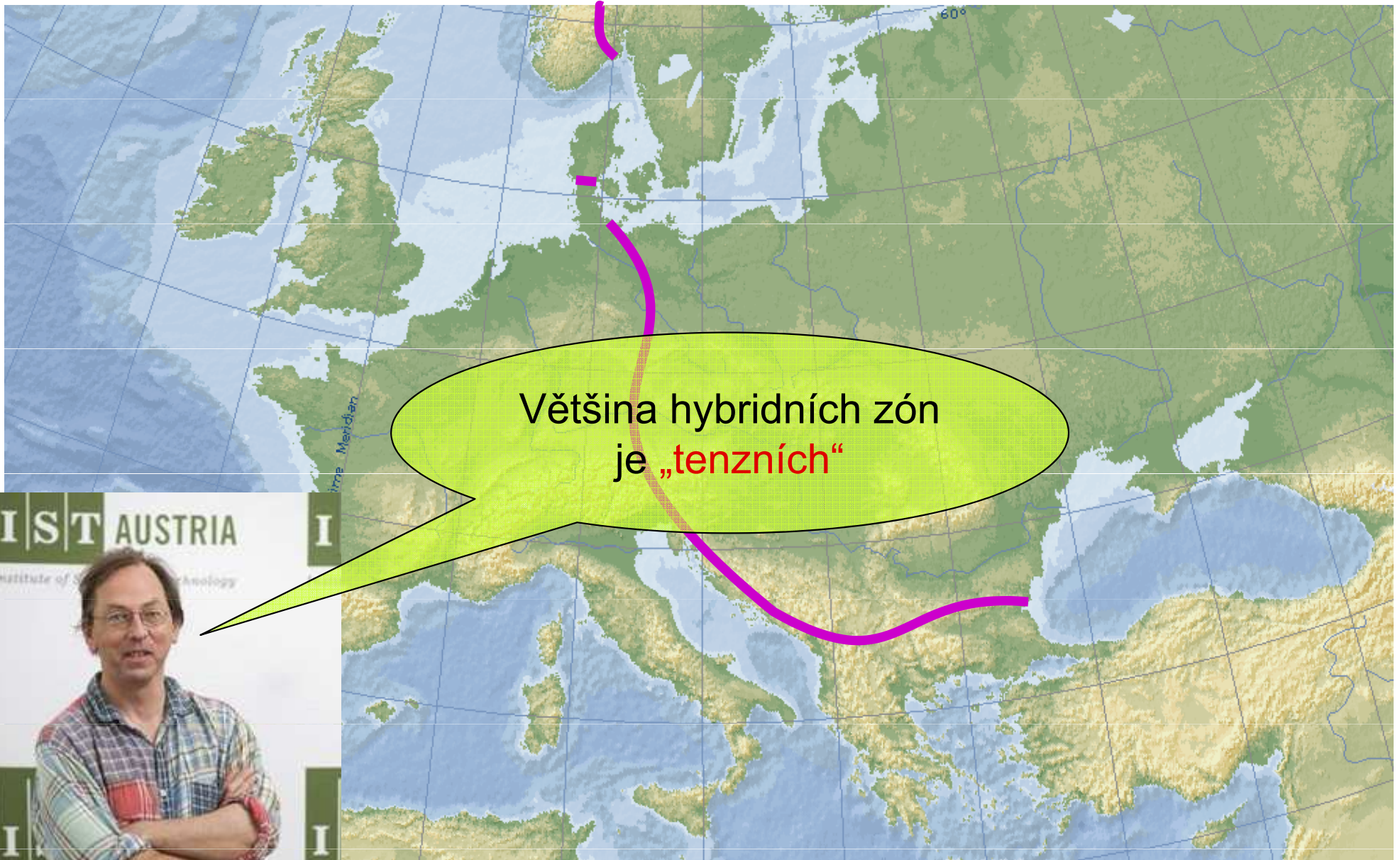

Nick Barton

i myší hybridní zóna je tenzní?

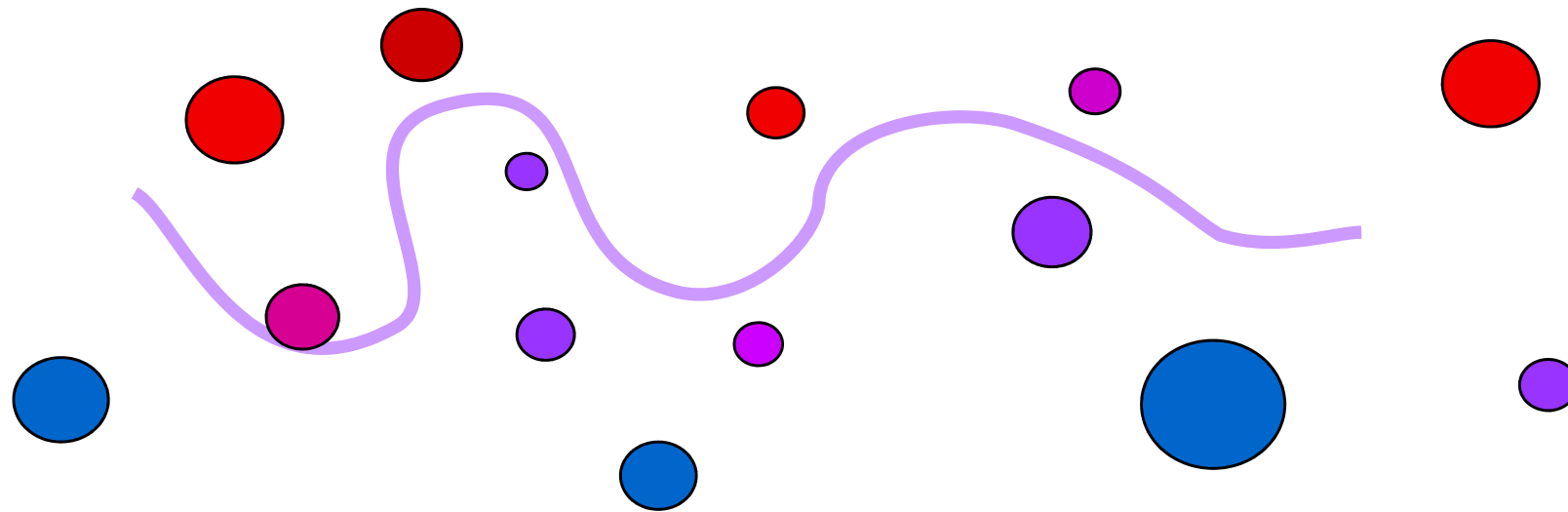

průběh hybridní zóny může být komplikovaný....

... navíc předem většinou neznáme, nebo extrapolujeme z globálního směru

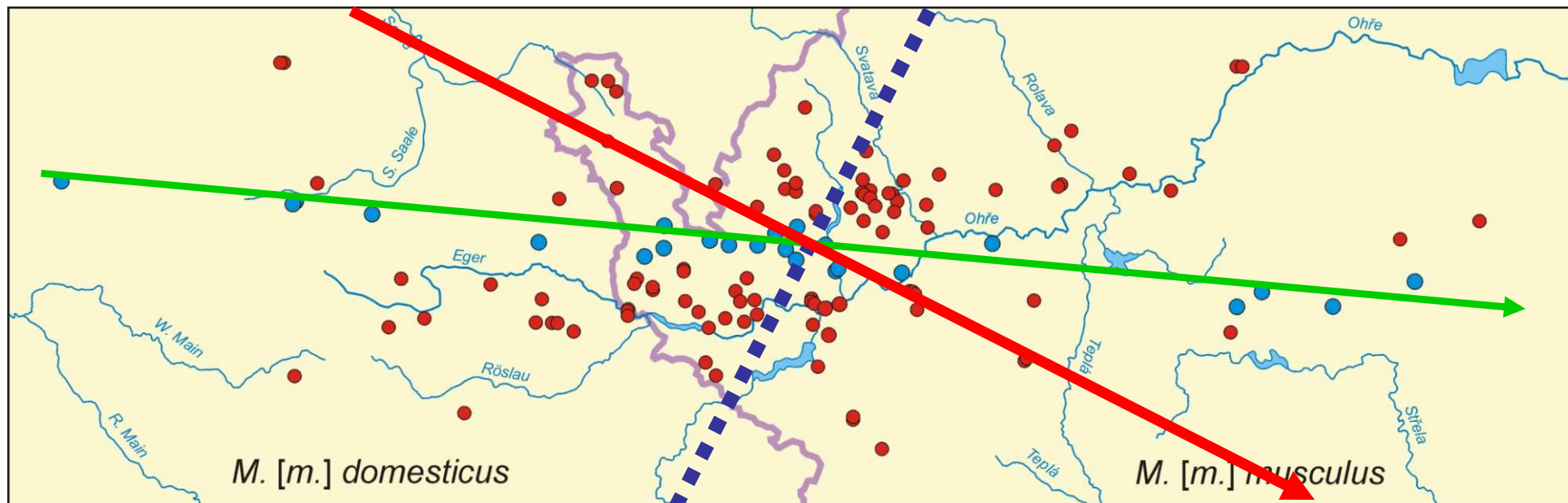

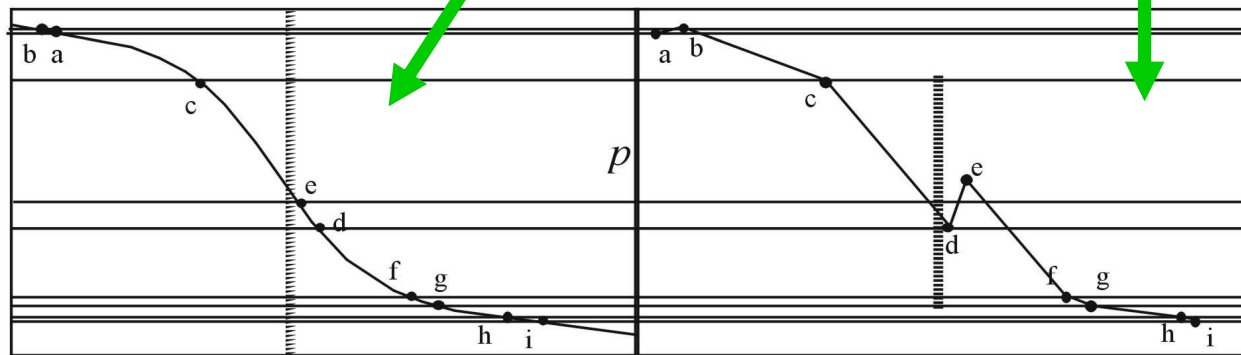
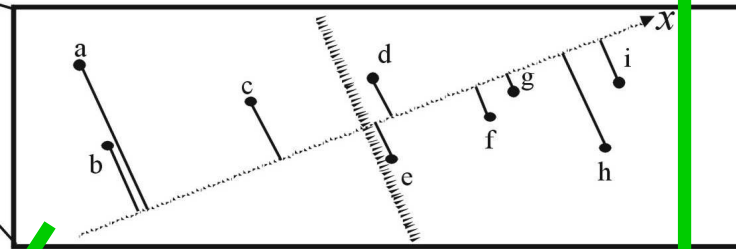
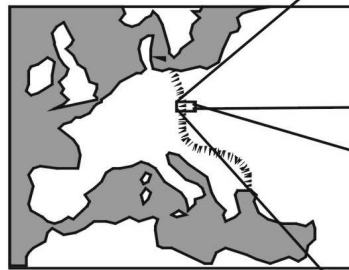
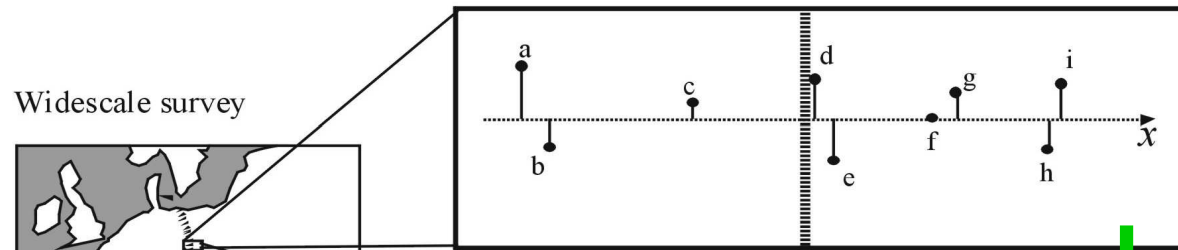

Real local cline

**Cline interpolated
from widescale survey**

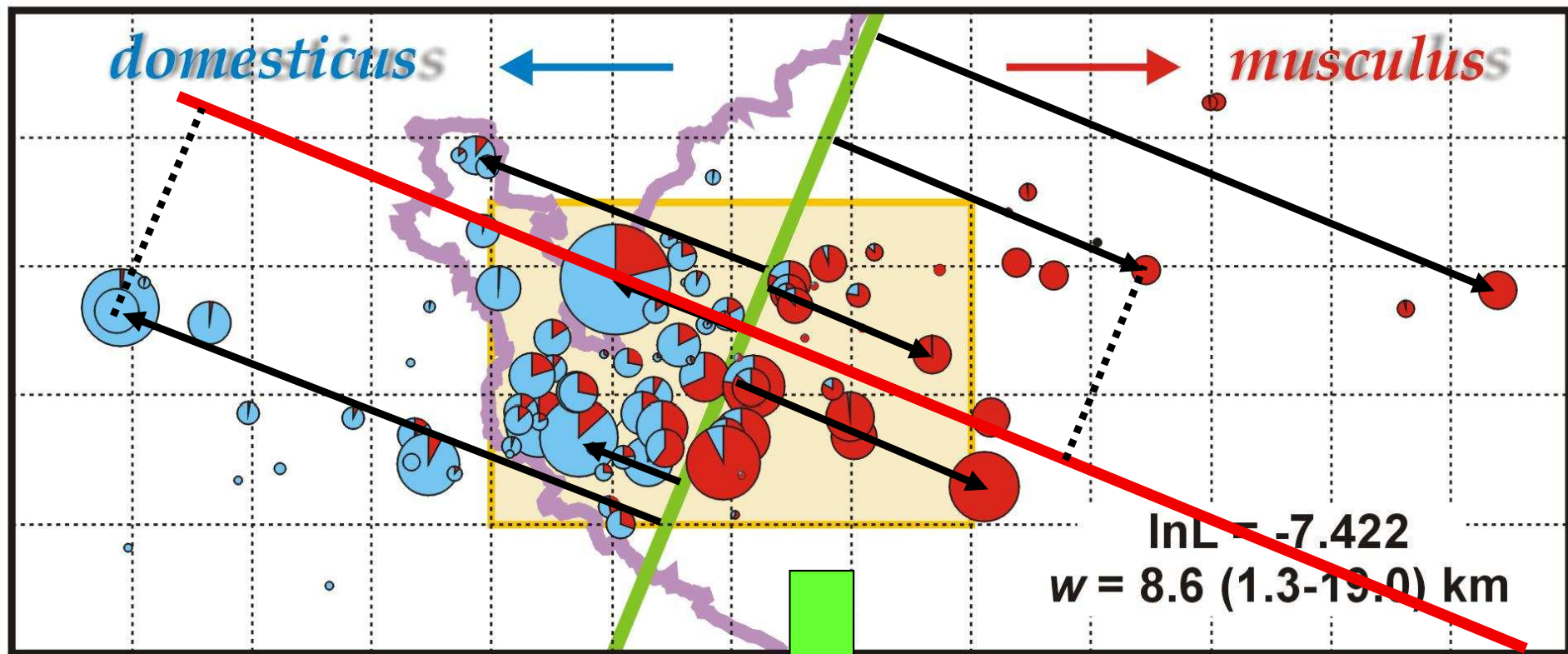

2D → 1D kliny

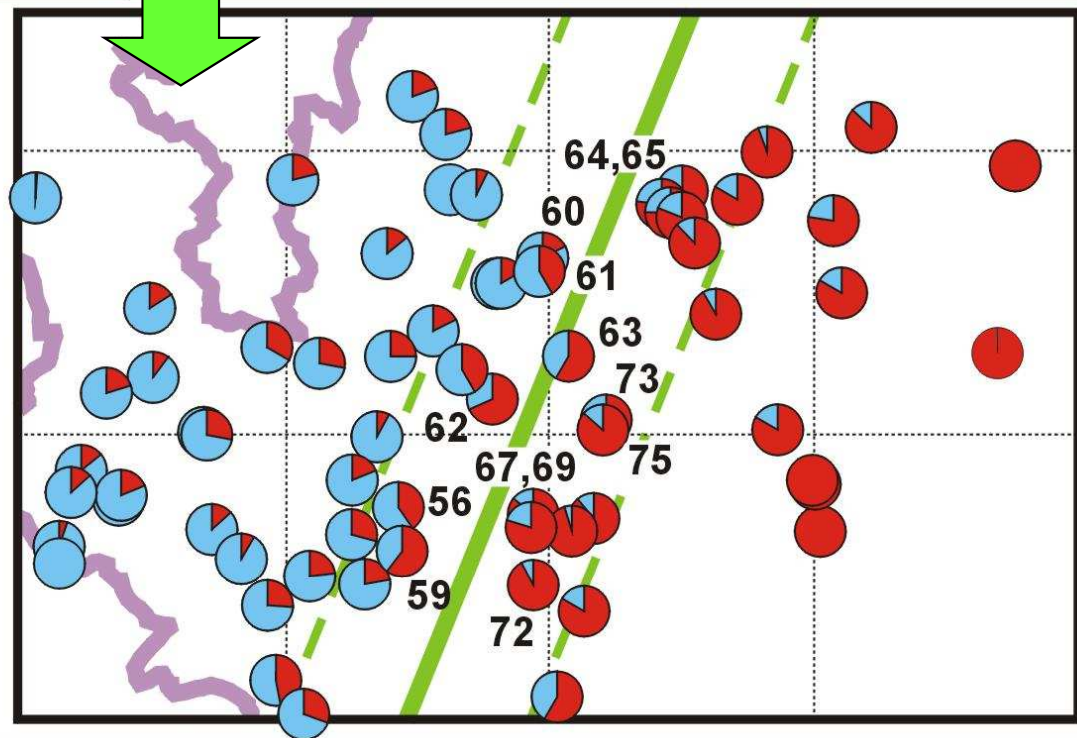

Příklad: M_{pi}

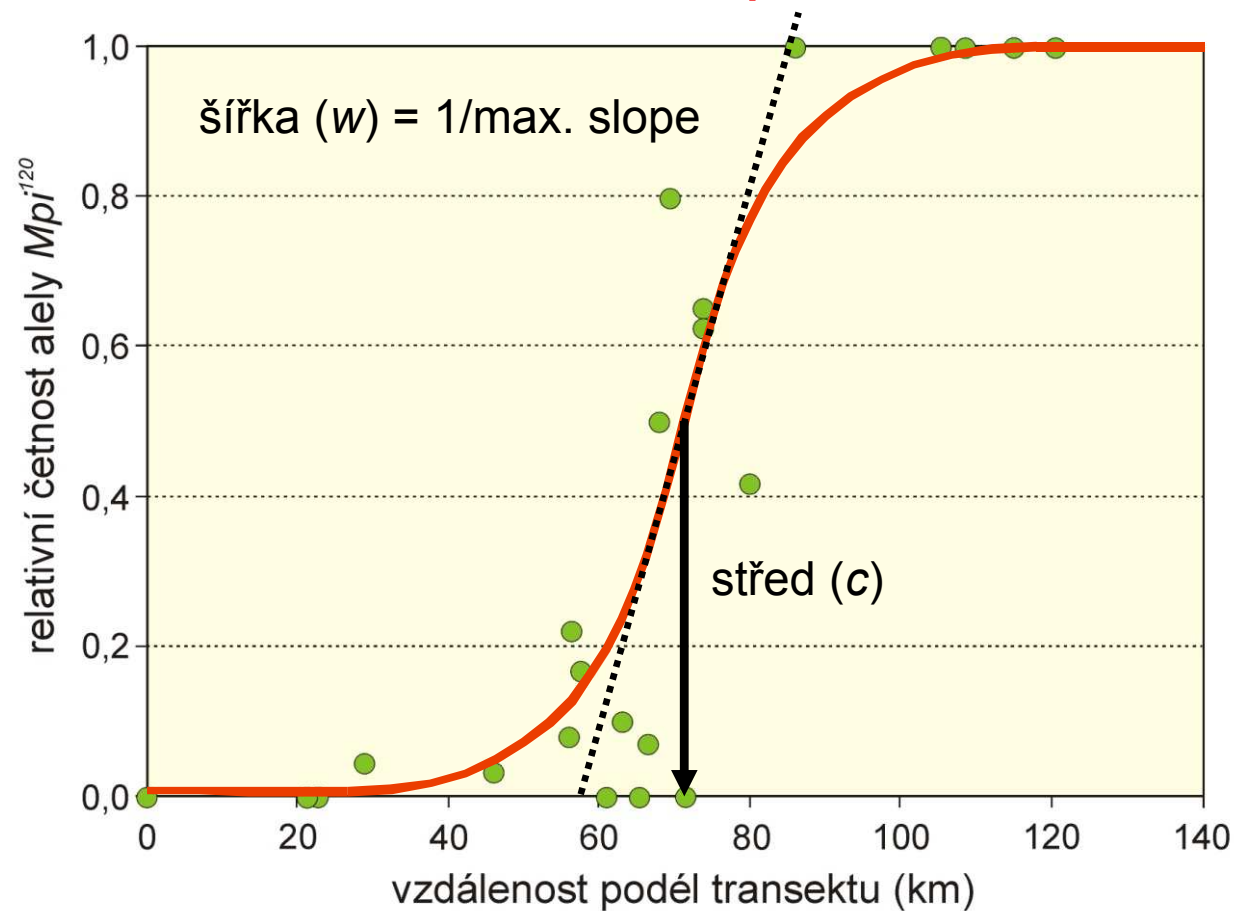

proložení: např. logistická regrese × modely založené na teorii klin

sigmoidní model: hyperbolická tangenciální funkce:

$$p(x_i) = \frac{1}{2} \left[1 + \tanh \left(\frac{2(x_i - c)}{w} \right) \right]$$

Více genů:

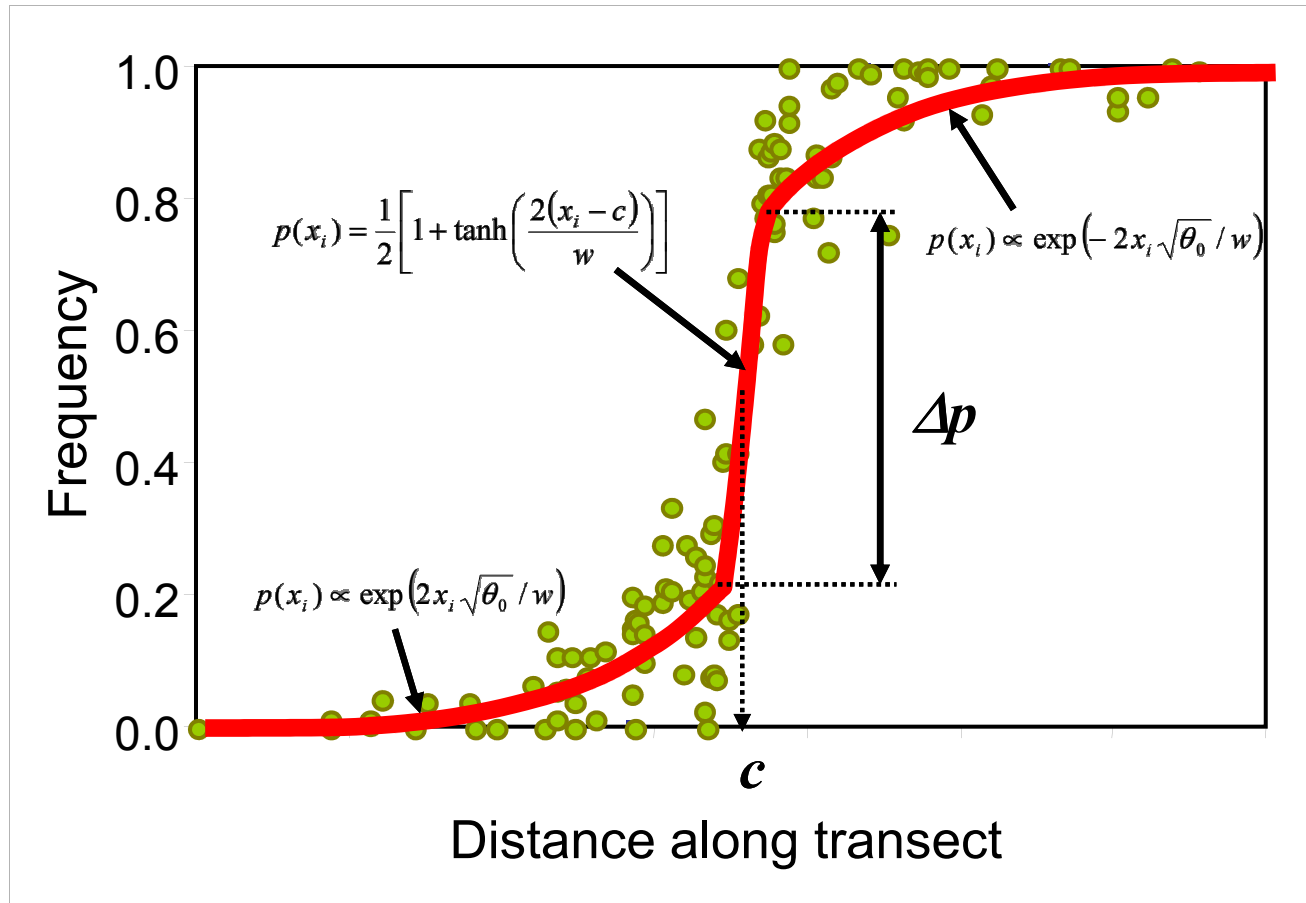

„stepped“ model (symetrický, asymetrický)

vazebná nerovnováha v důsledku přílivu rodičovských kombinací \Rightarrow
zesílení selekce ve středu zóny \Rightarrow centrální schod

introgresní „ocasy“ vypovídají o selekci na jednotlivé lokusy

Z hodnot LD a klinálních parametrů můžeme odhadnout některé další klíčové evoluční parametry:

dispersal: $\sigma = w \sqrt{\frac{R\bar{r}}{1+\bar{r}}}$

effective selection: $s^* = 8 \left(\frac{\sigma}{w} \right)^2$

selection on marker loci: $s_e = s^* \theta$

selection on selected loci: $s = \frac{8\sigma^2}{B^2} \left[\ln \left(\frac{B}{w\Delta u} \right) \right]^2$

fitness of hybrids: $\bar{W}_H = \left(\frac{w\Delta p}{B} \right)^{\bar{r}}$

number of loci under selection: $n = \frac{\bar{r}B^2}{4\sigma^2 \ln \left(\frac{B}{w} \right)}$

srovnání modelů: LRT (jsou „nestované“); d.f. = rozdíl počtu parametrů
 likelihood profiles:

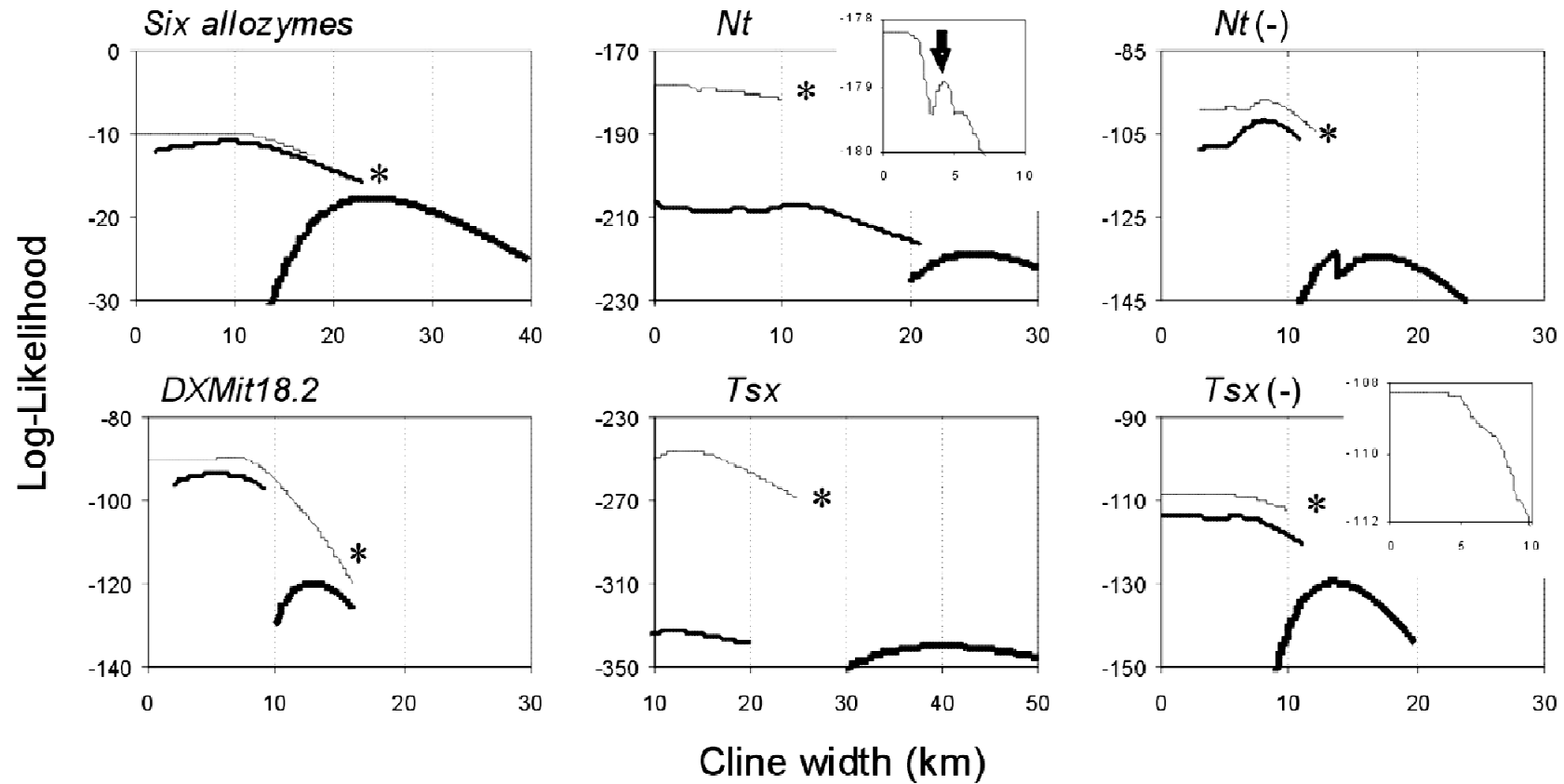

koincidence: $LL_{\Sigma} < \Sigma LL \Rightarrow$ signifikantní rozdíl

hybridní zóna

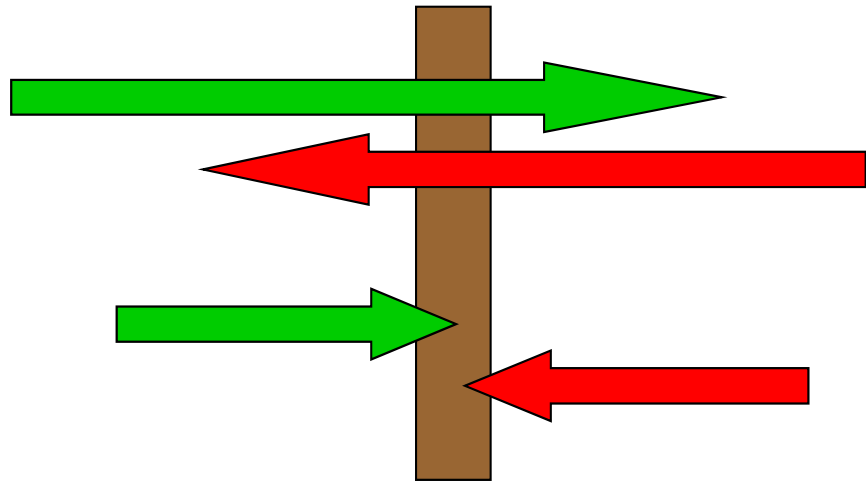

hybrid index

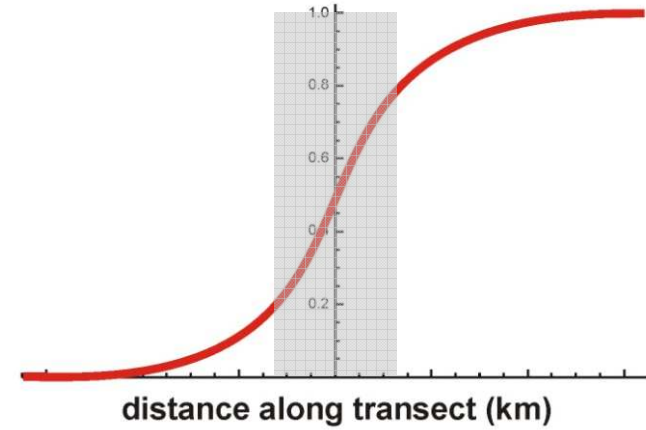

oblasti pod selekcí

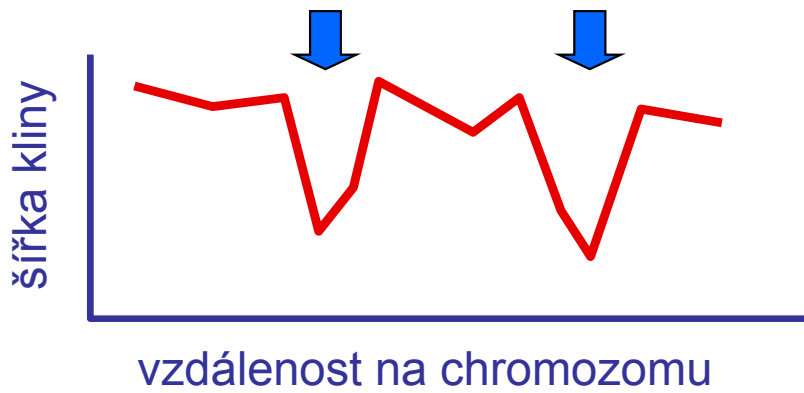

hybrid index

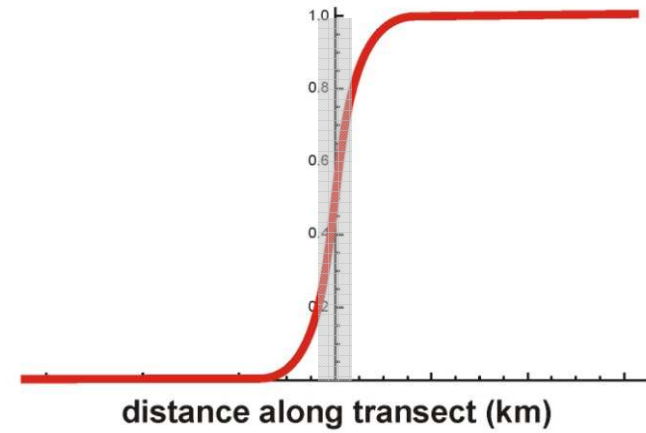

centromera

molekulární markery

Problémy – chromozom Y

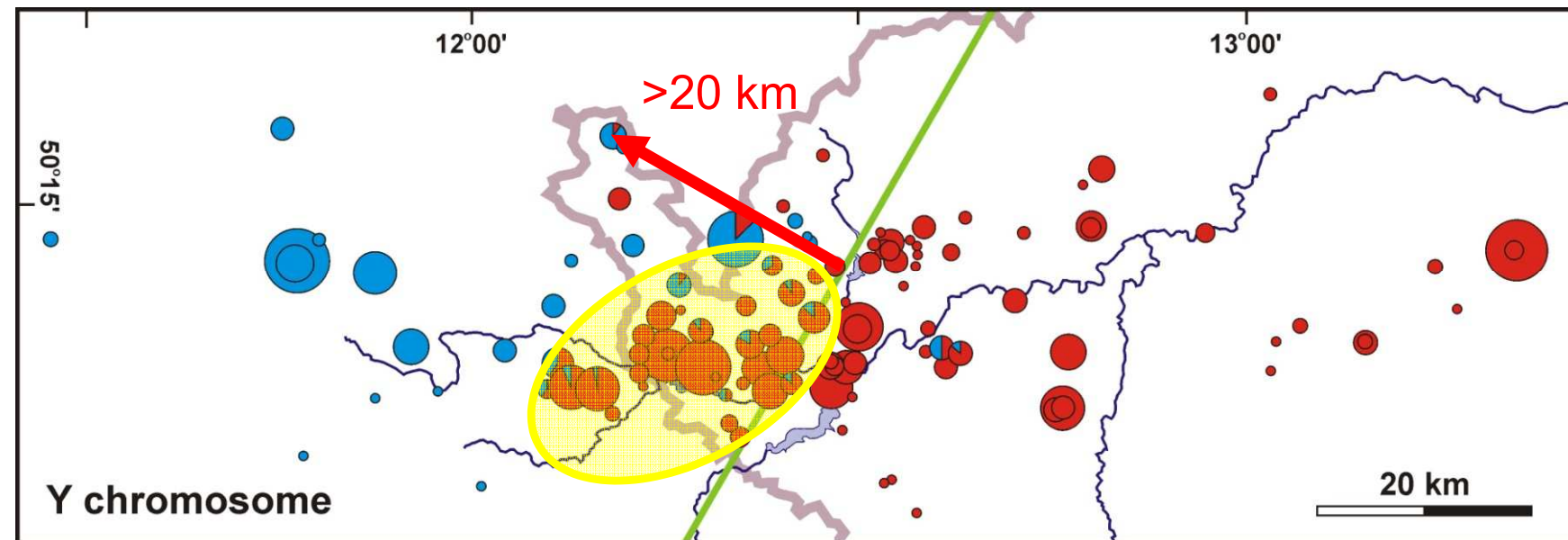
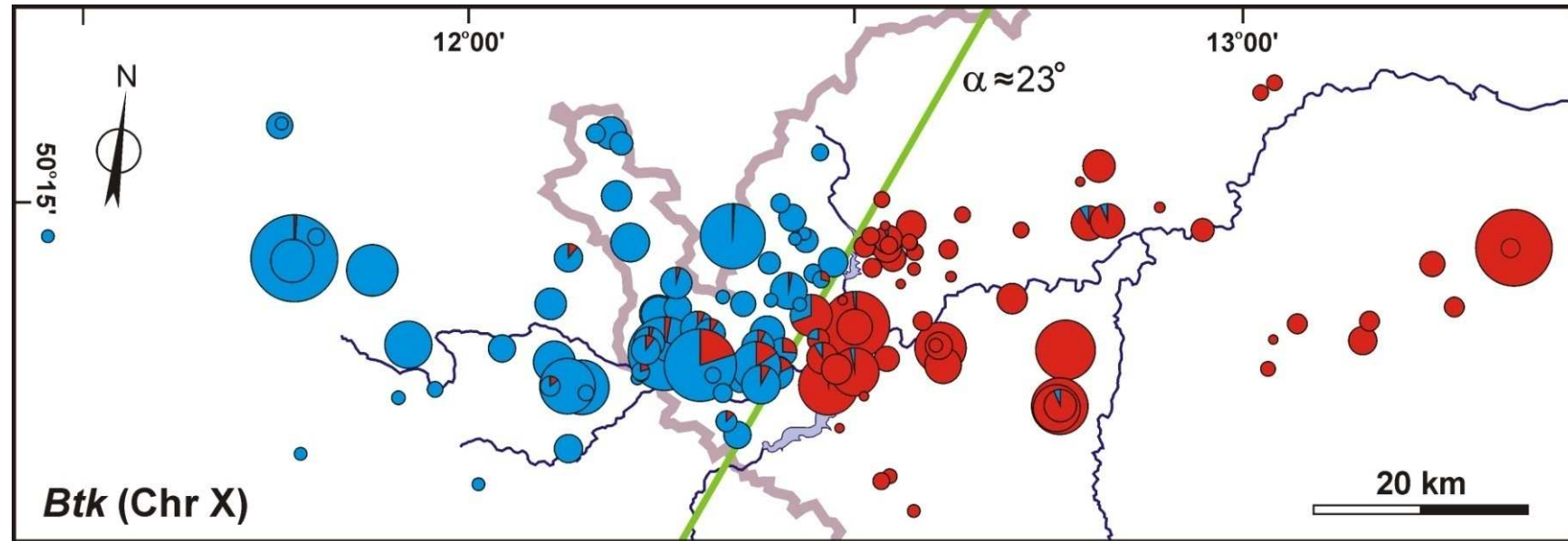

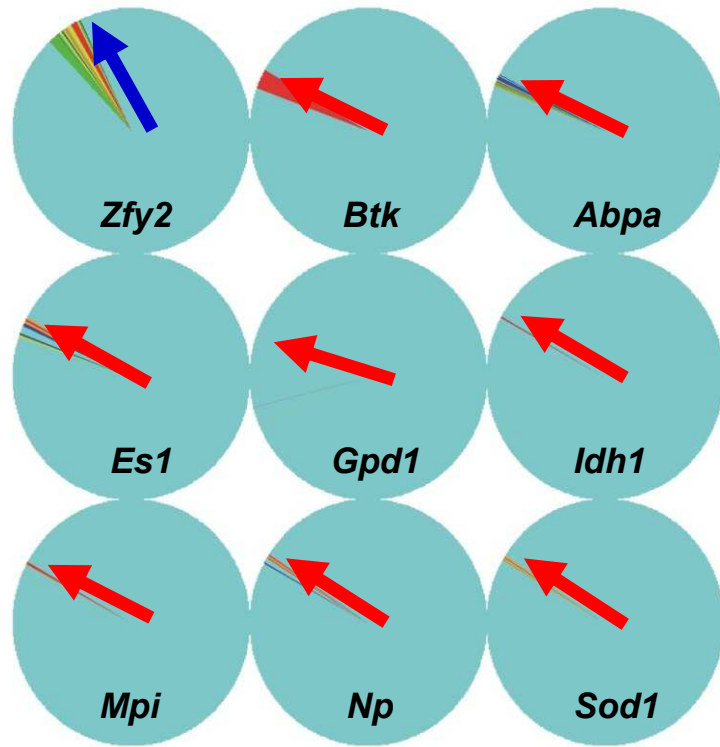

Orientace maximálního gradientu

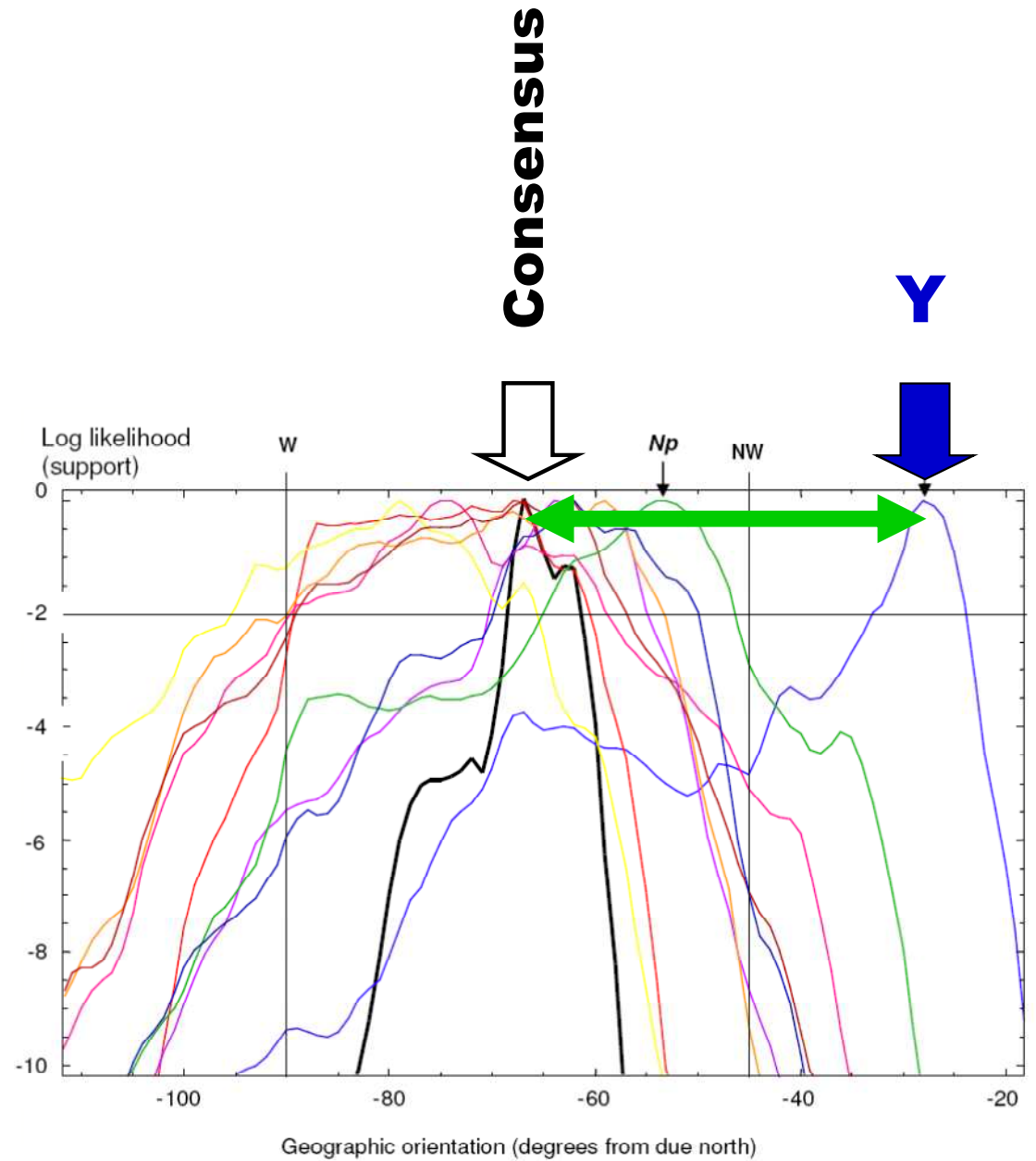

Monotonic clines – consensus orientation

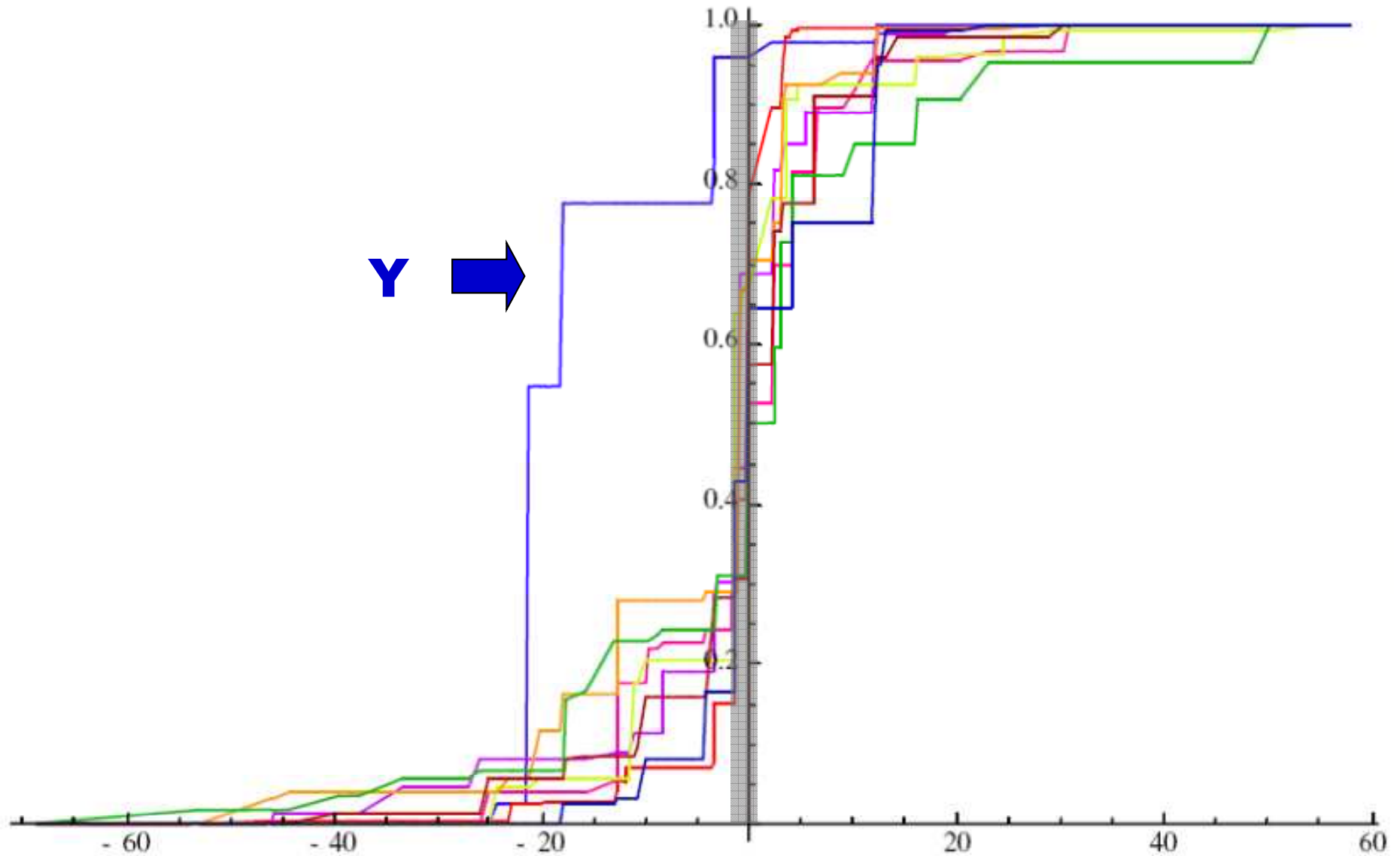

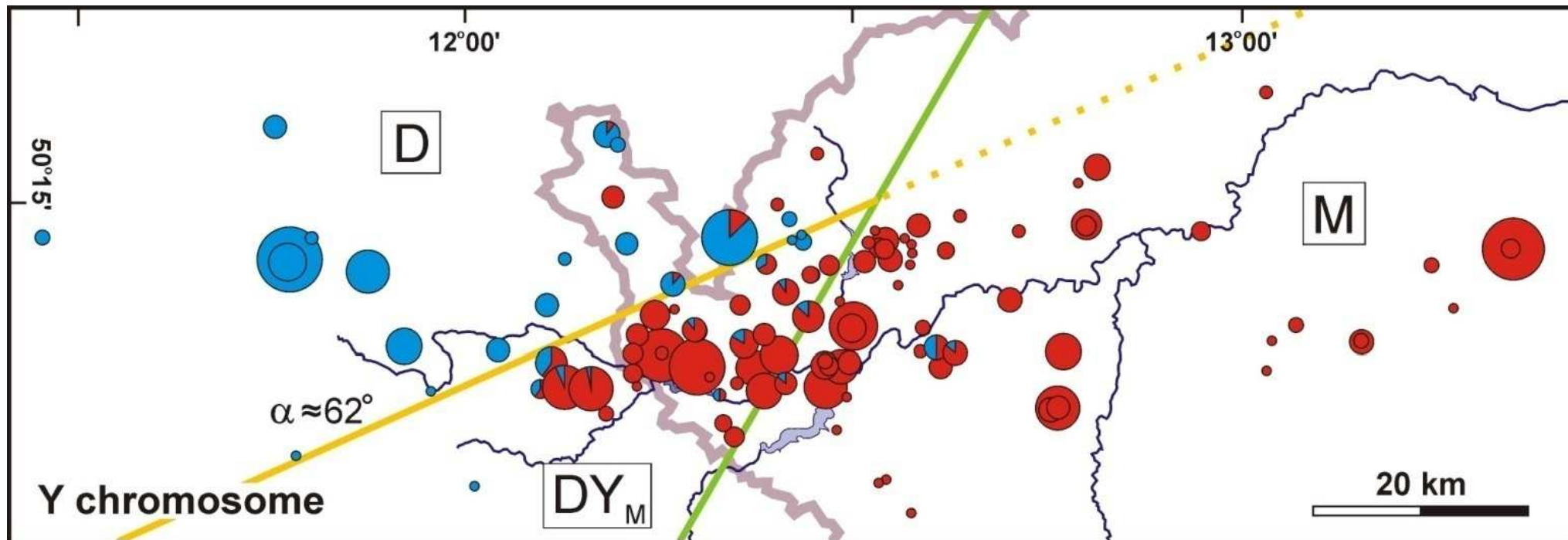

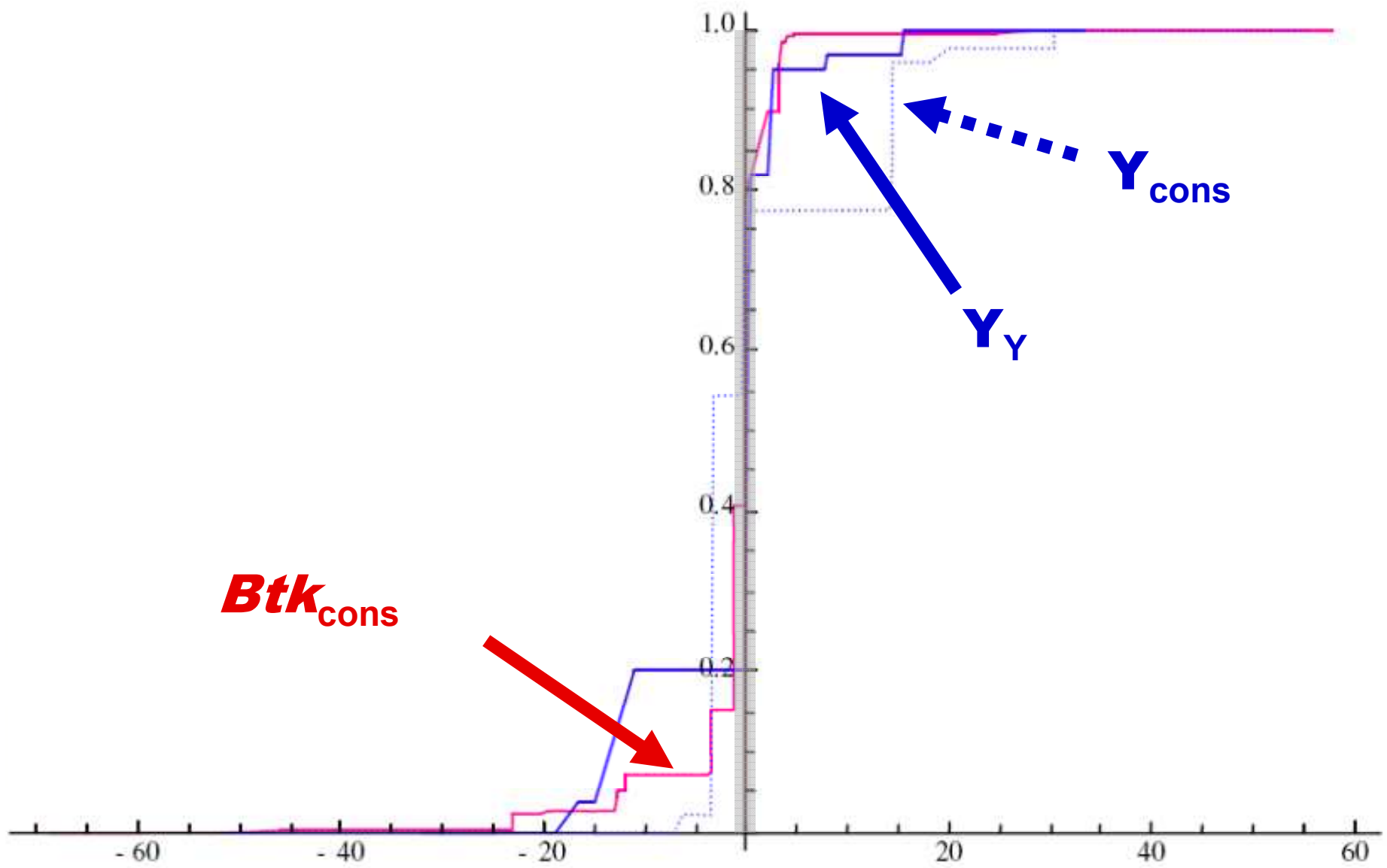

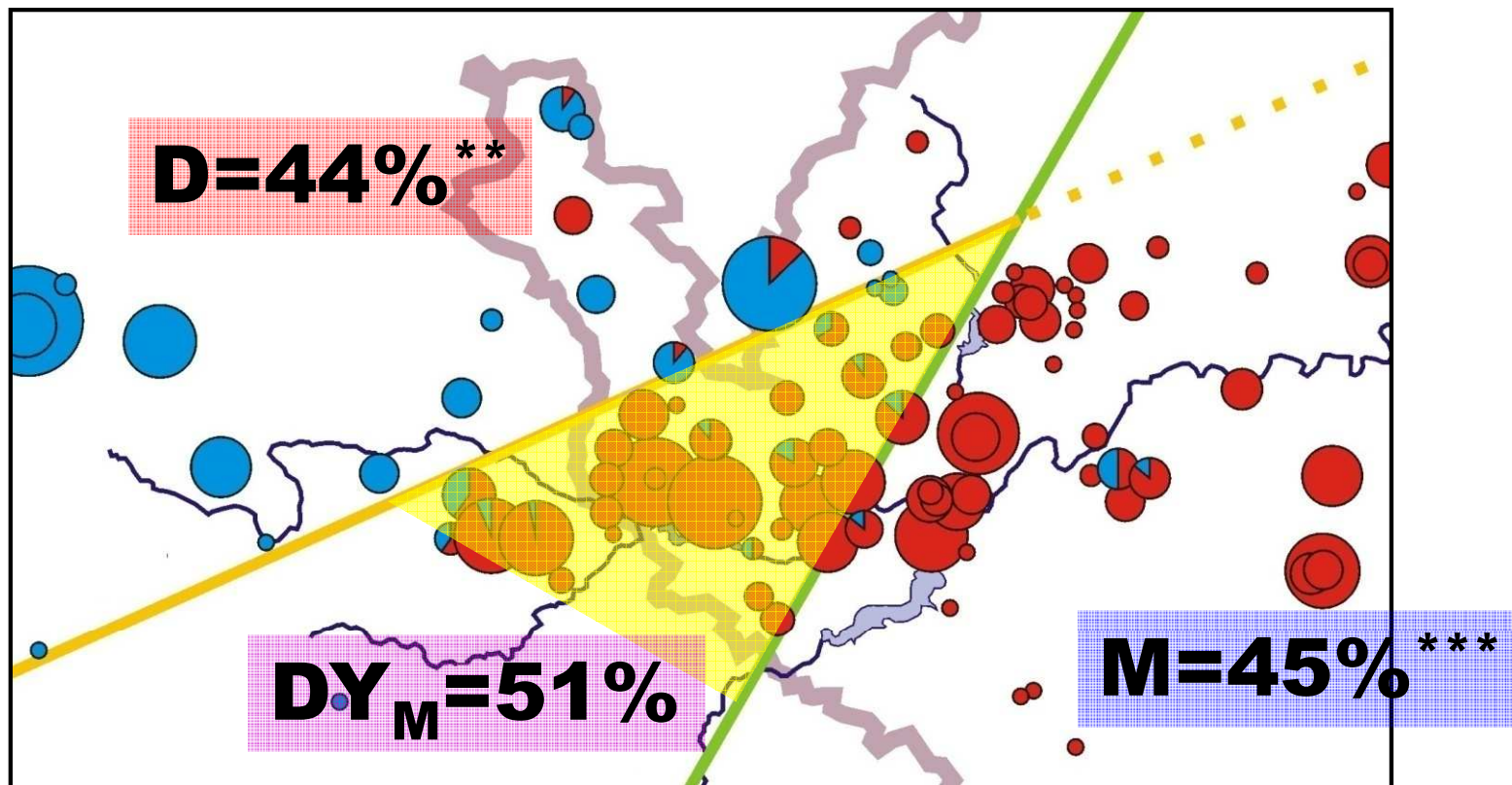
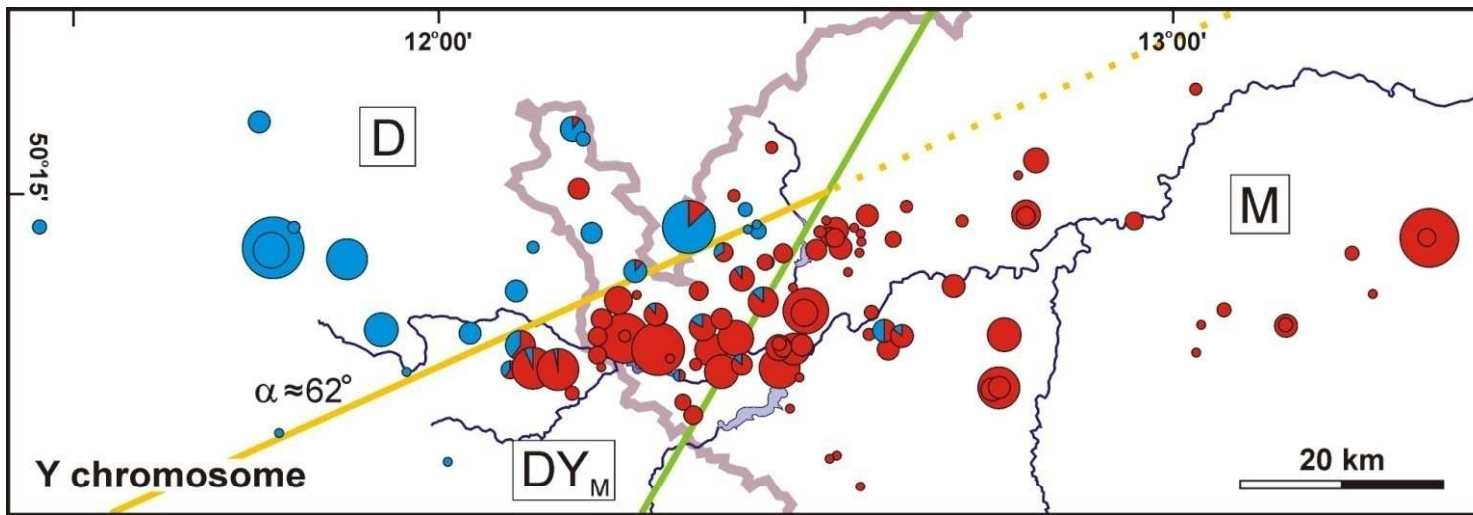

salient/invagination $\approx 330 \text{ km}^2$

Podivné chování chromozomu Y v hybridní zóně – shrnutí:

1. *musculus* Y úspěšnější než *domesticus* Y na jeho vlastním genetickém pozadí
2. větší procento samců ve srovnání s ostatními oblastmi

Bud' náhoda, nebo ...

... nebo genetický konflikt mezi X a Y
a pravděpodobně i některými autozomálními geny





Gregor Mendel

zákon o
segregaci

Aa

A

a

50%

50%

Intragenomový konflikt vede k většímu zastoupení některého genomového elementu v příští generaci



Gregor Mendel

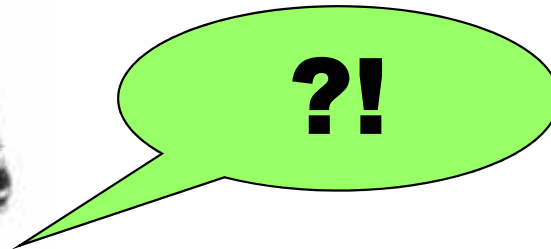

„drive“ (tah)

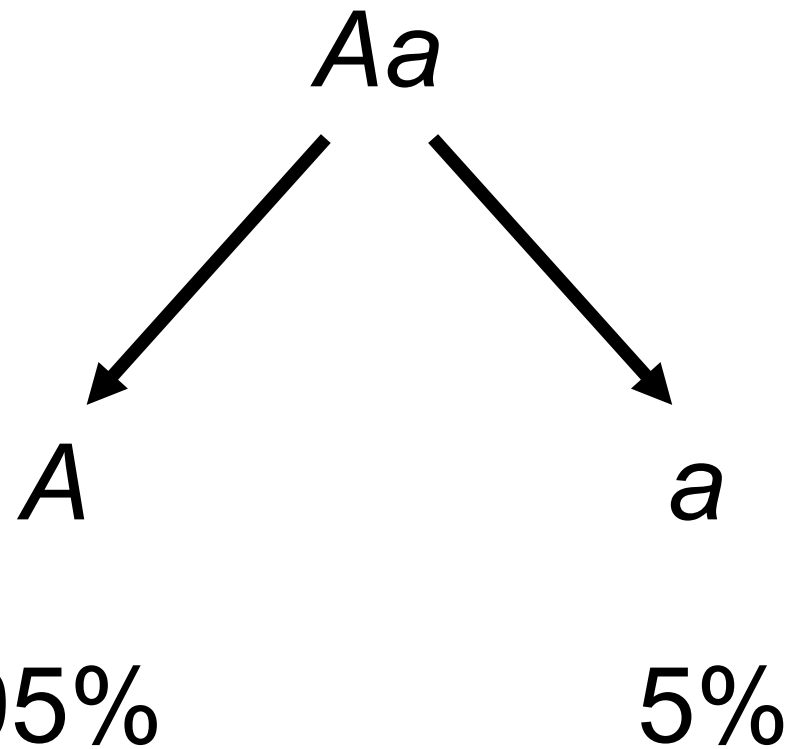

vychýlení segregáčího (transmisního) poměru

= segregation distortion (SD)

= transmission ratio distortion (TRD)

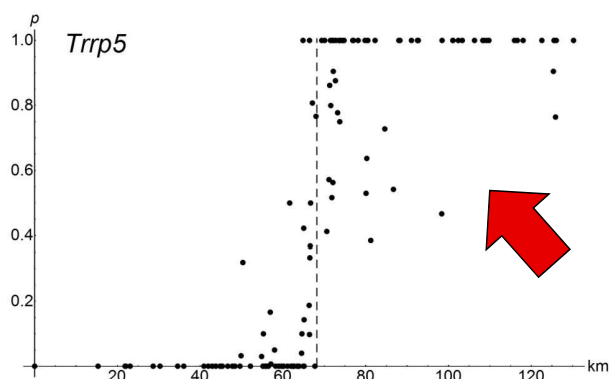
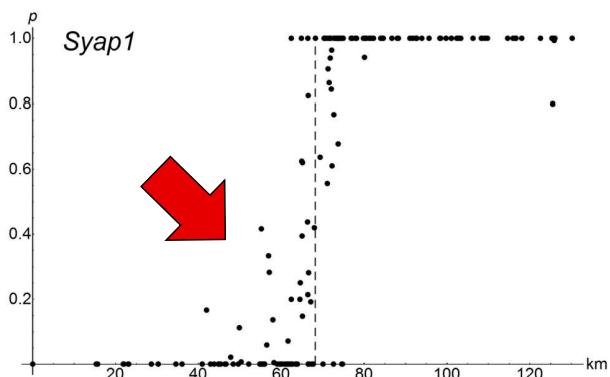
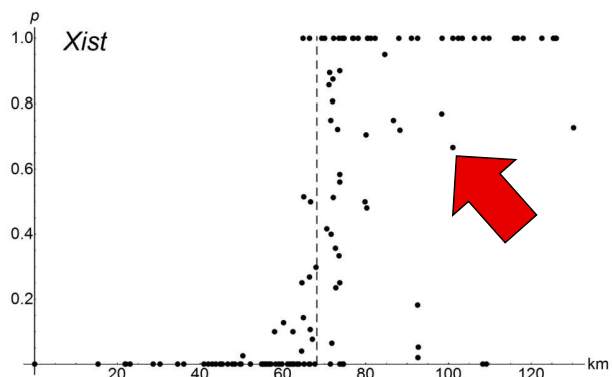
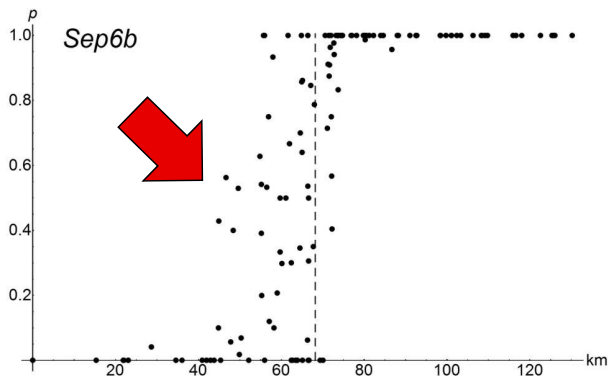
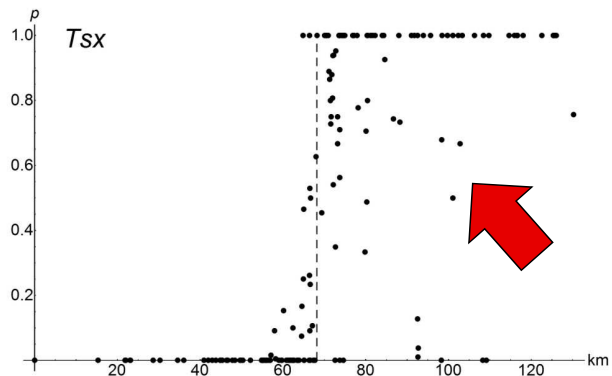
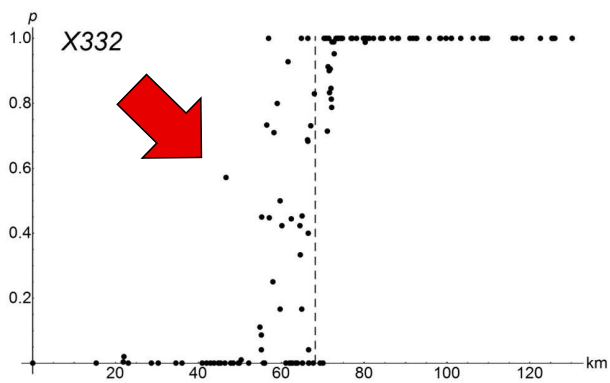
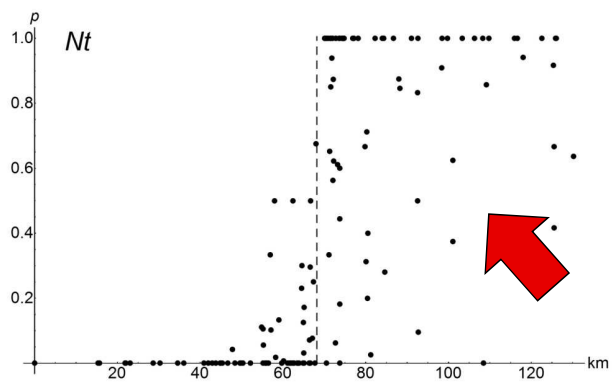

Chromozom X

Chr. X - 2D analýza Geneland

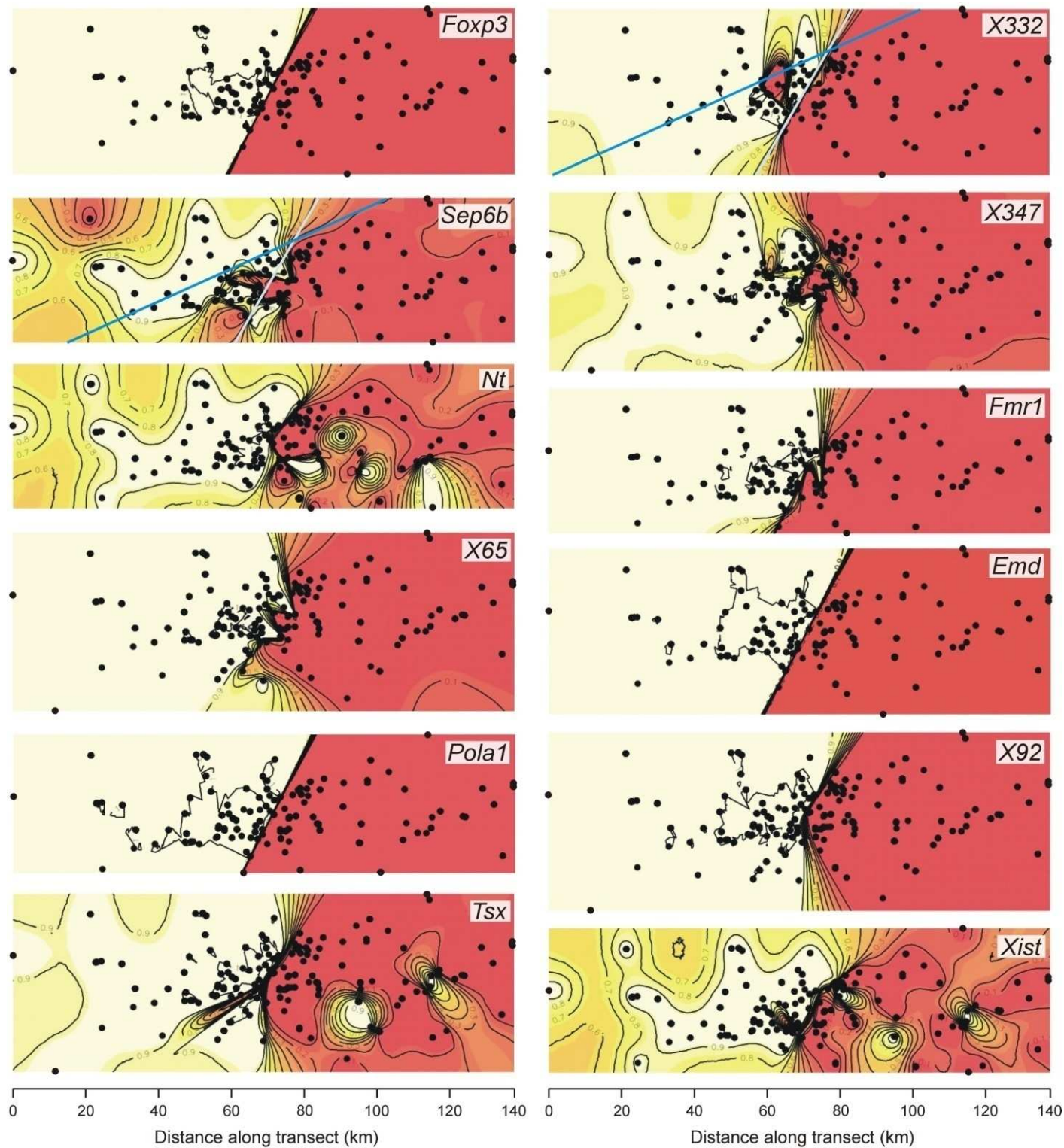

Celogenomová analýza – „genomické klíny“

A. Underdominance

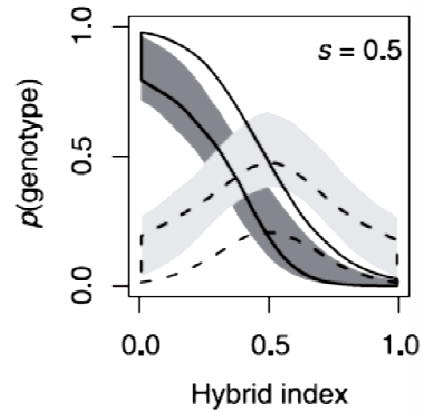
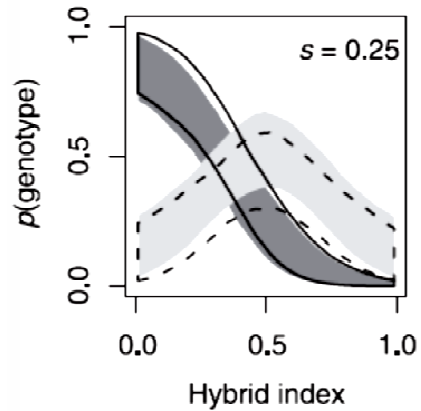

C. Epistasis

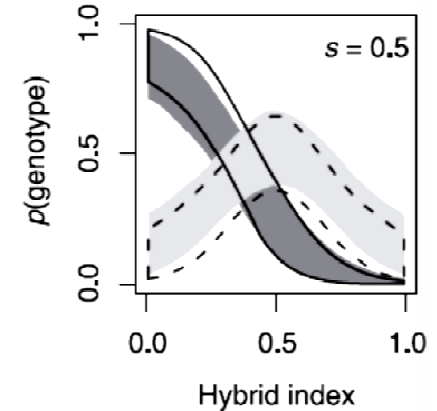
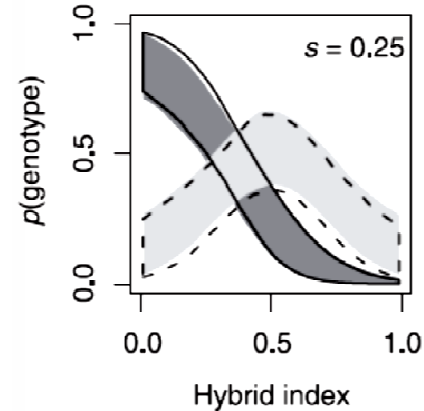

B. Overdominance

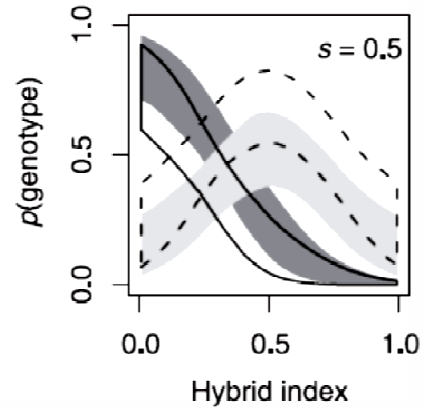
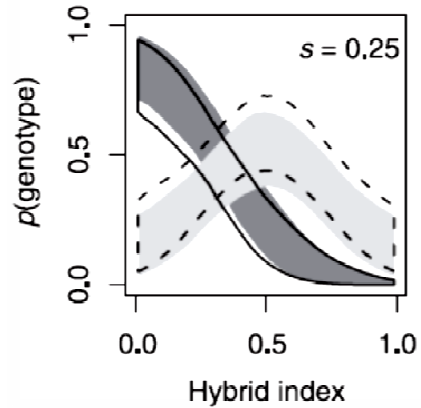

D. Directional selection

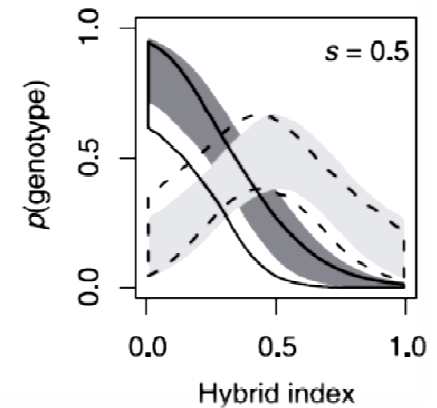
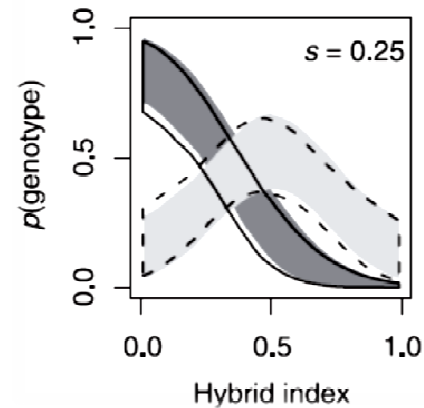

Z. Gompert & A. Buerkle

Konkordanční analýza:

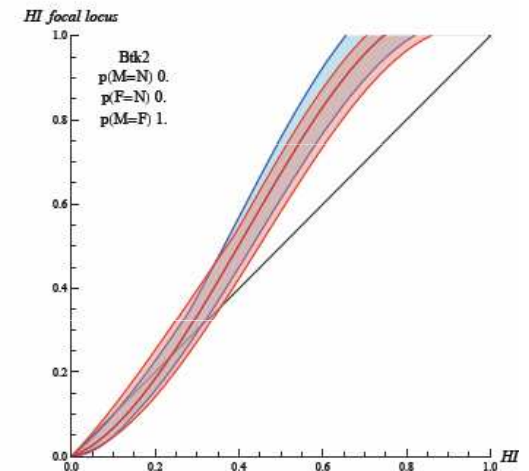
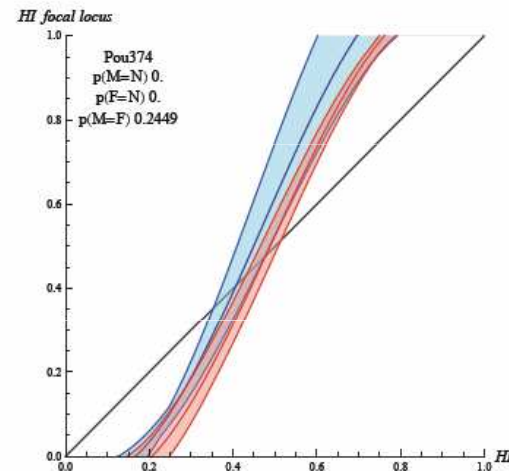
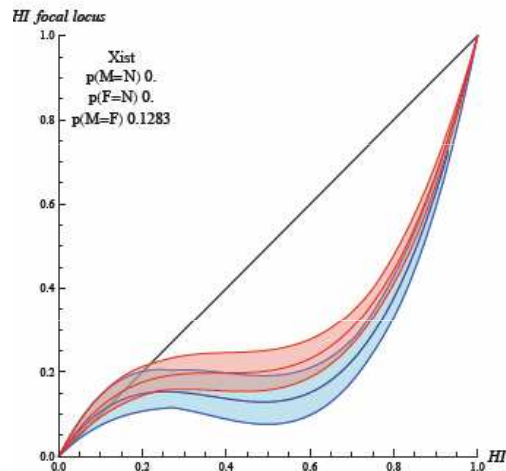
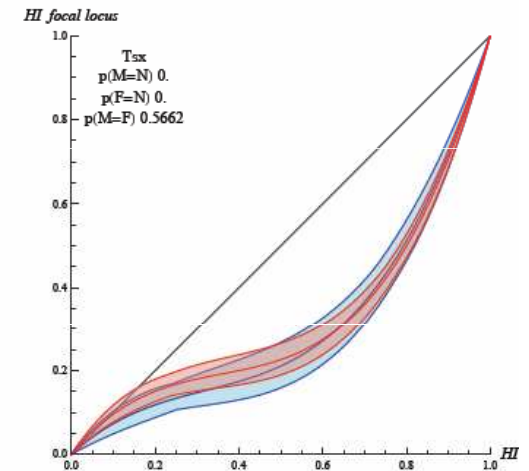
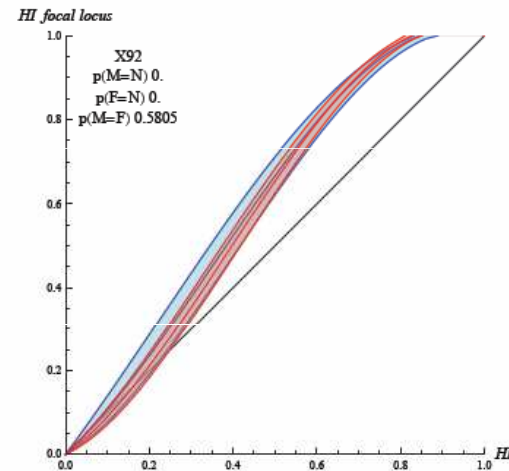
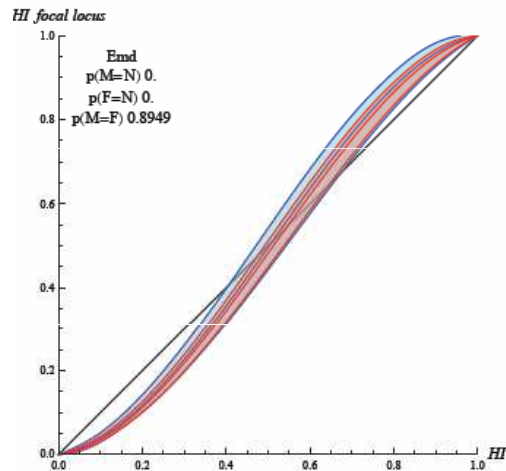
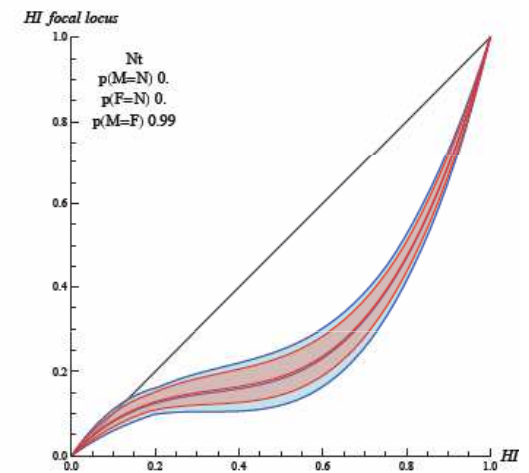
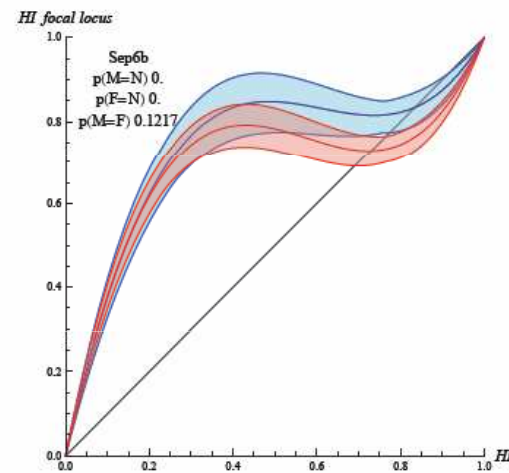
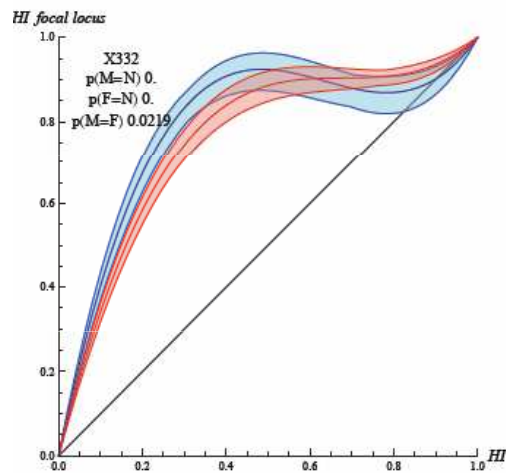

N. Barton
S.J.E. Baird

Konkordanční analýza:

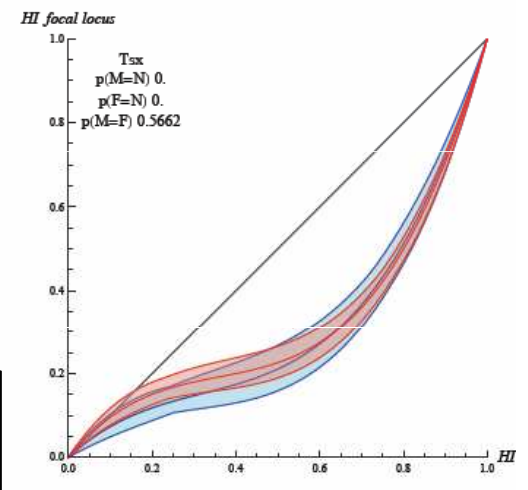
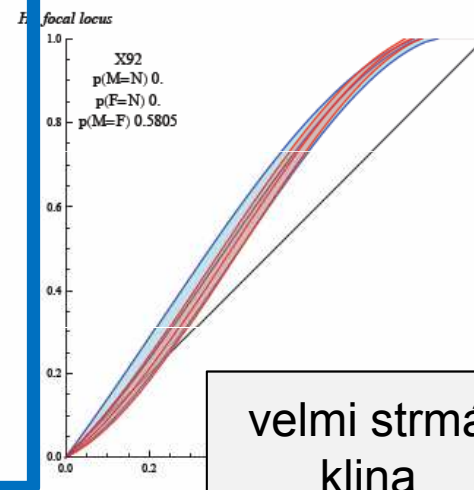
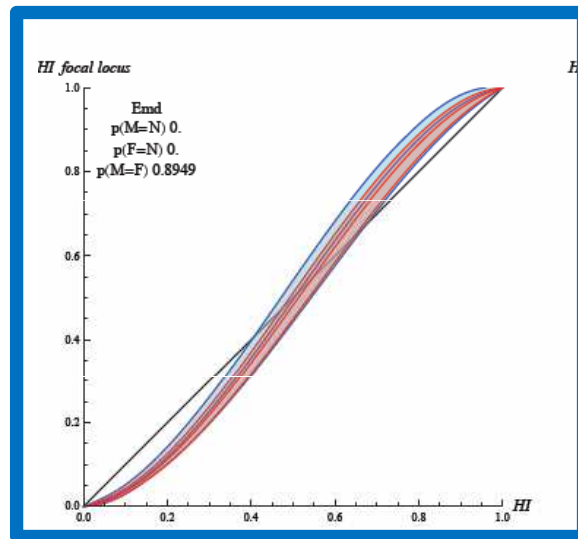
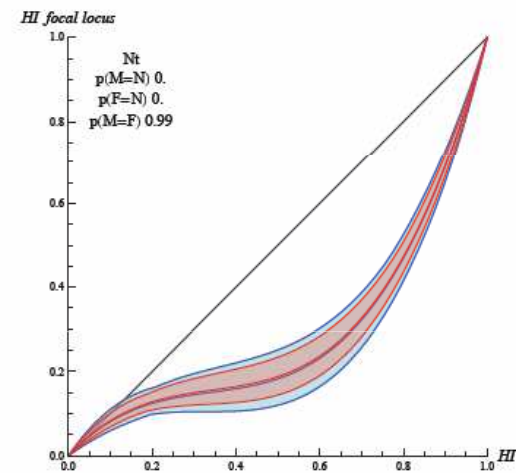
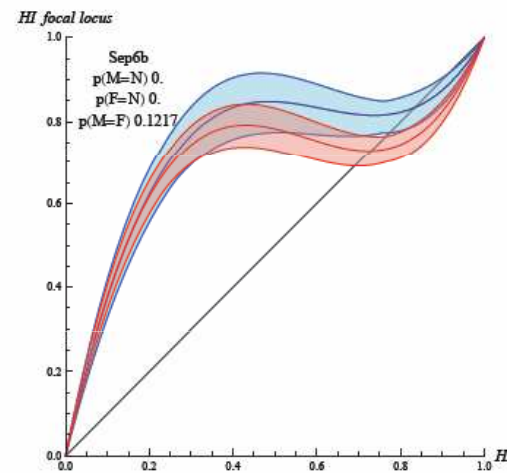
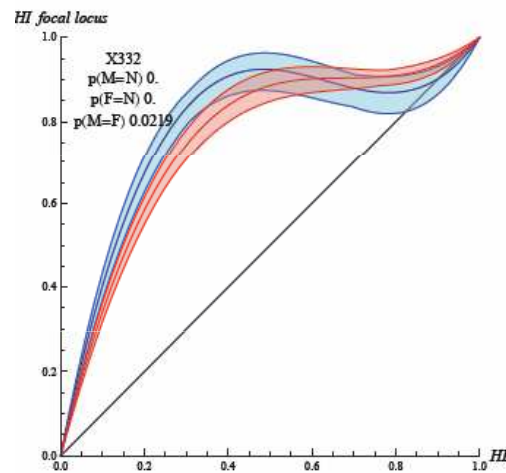

velmi strmá
klina

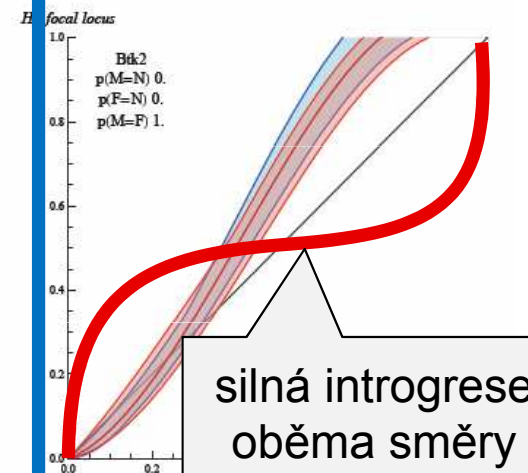
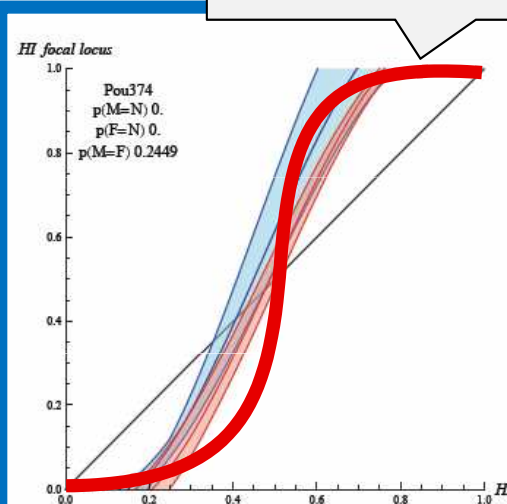
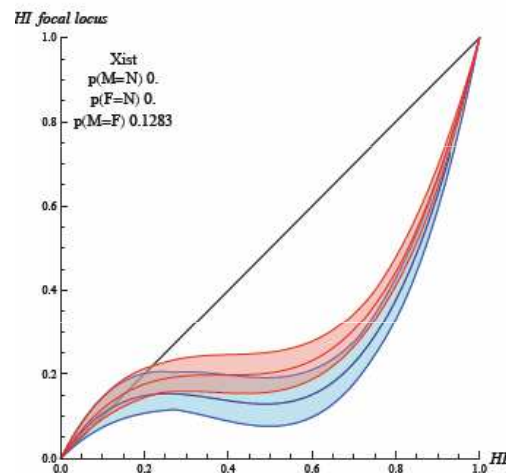

silná introgrese
oběma směry

S.J.E. Baird

Konkordanční analýza:

vychýlení
na západ

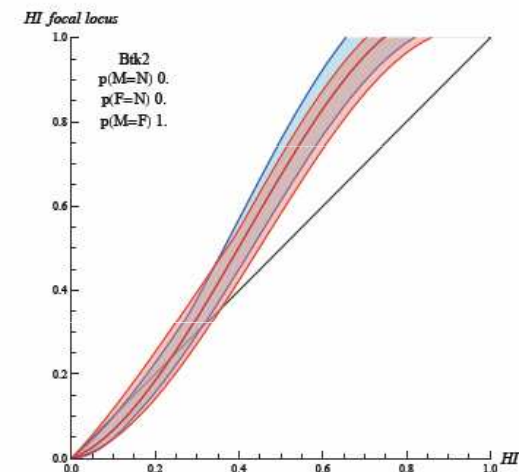
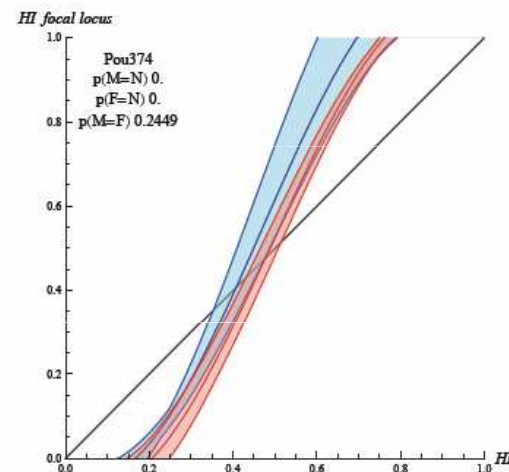
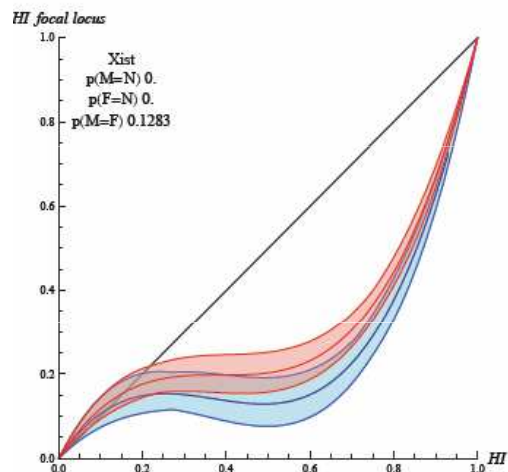
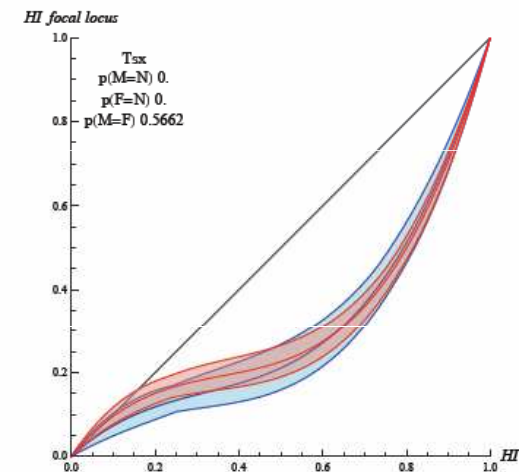
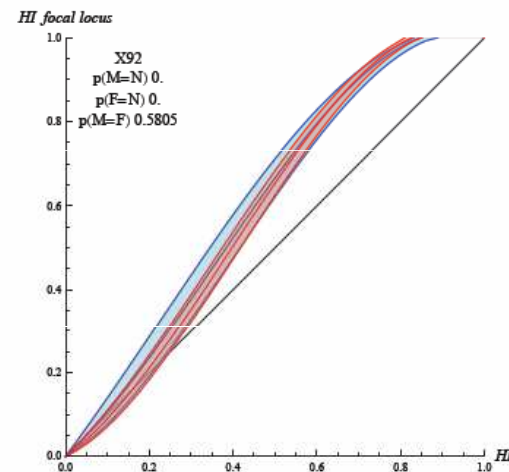
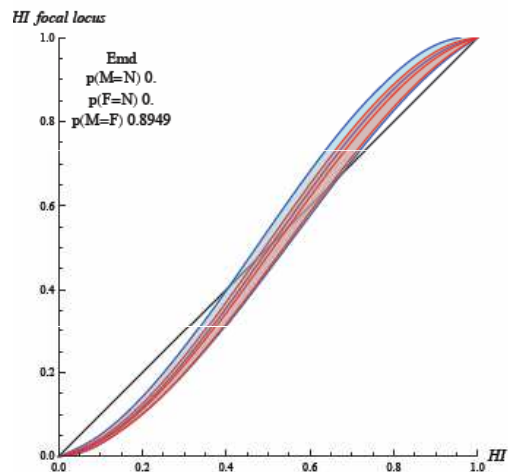
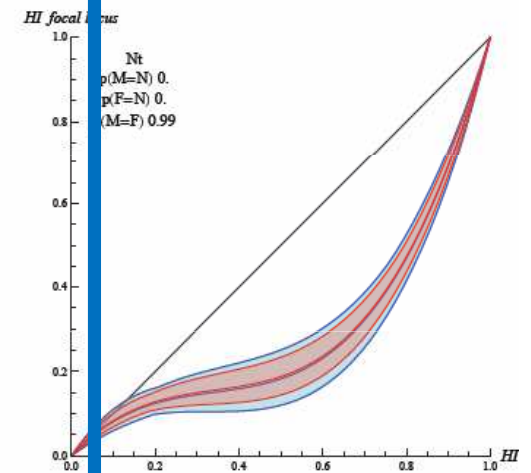
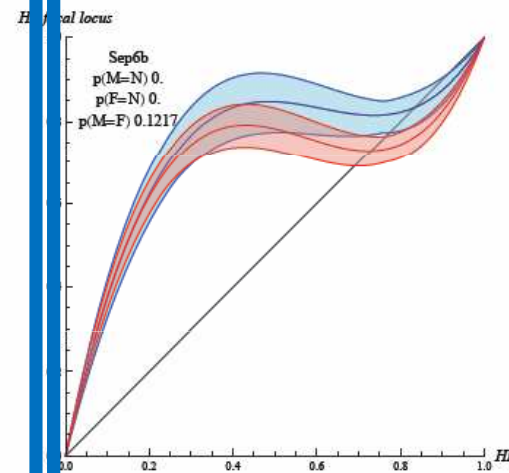
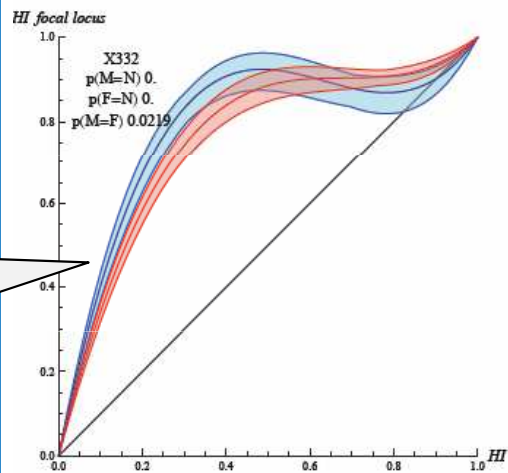

S.J.E. Baird

Konkordanční analýza:

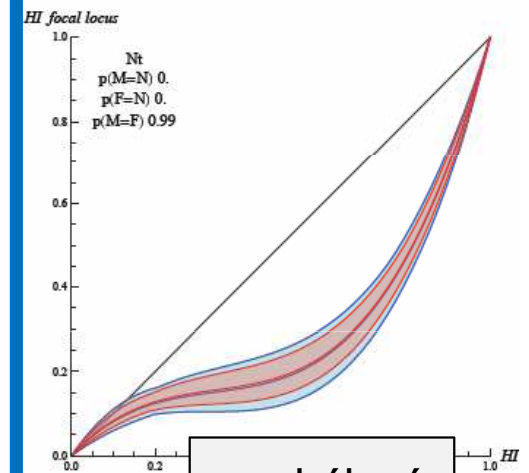
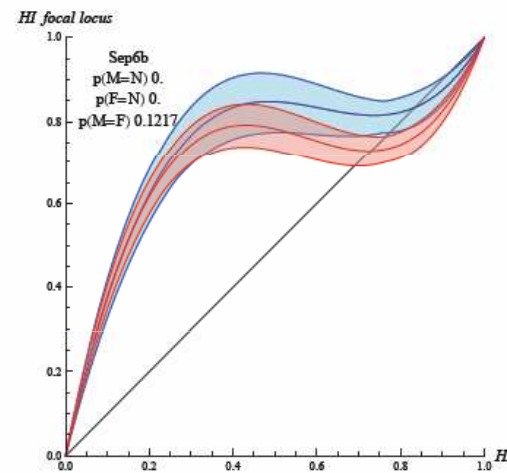
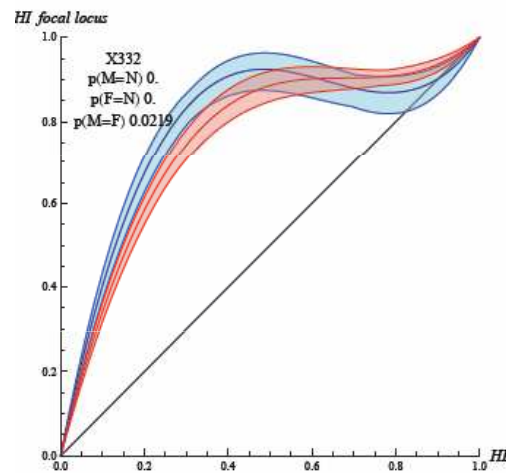

vychýlení
na východ

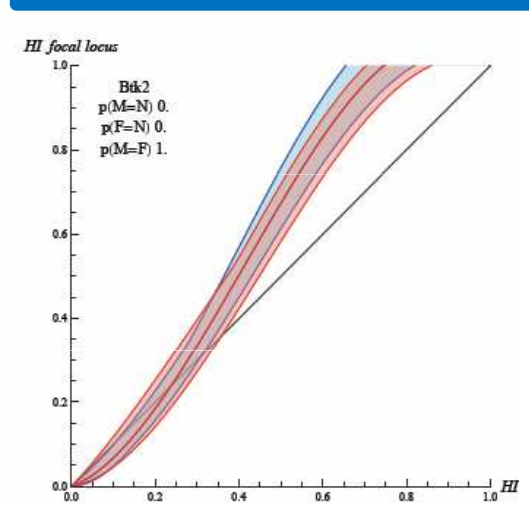
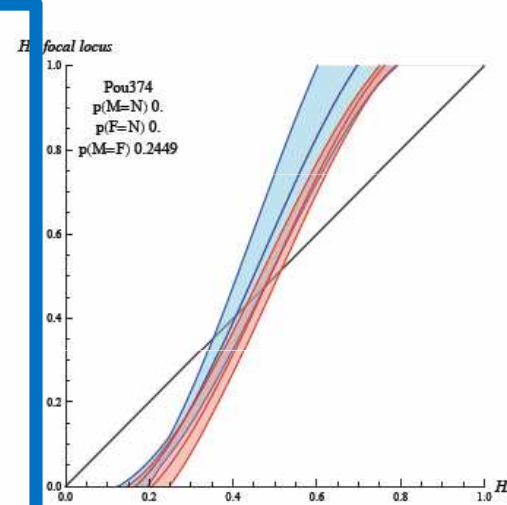
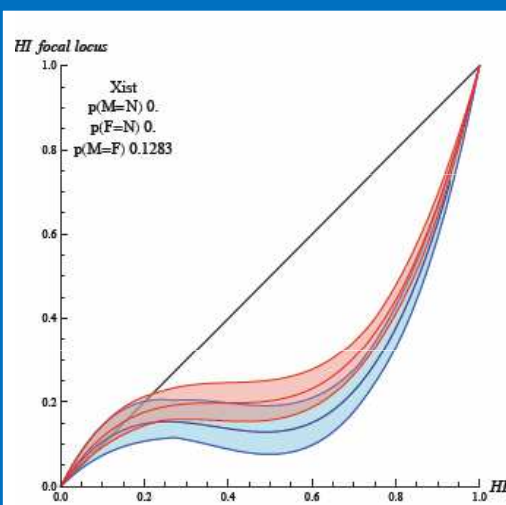
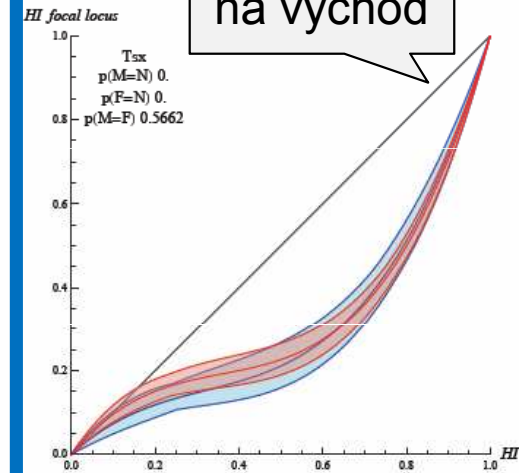
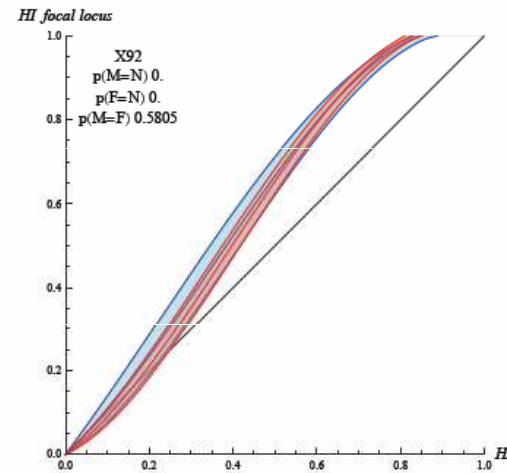
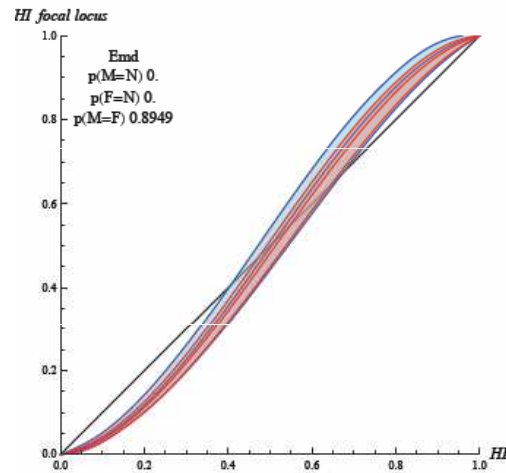

S.J.E. Baird

Proximální marker na chr. X

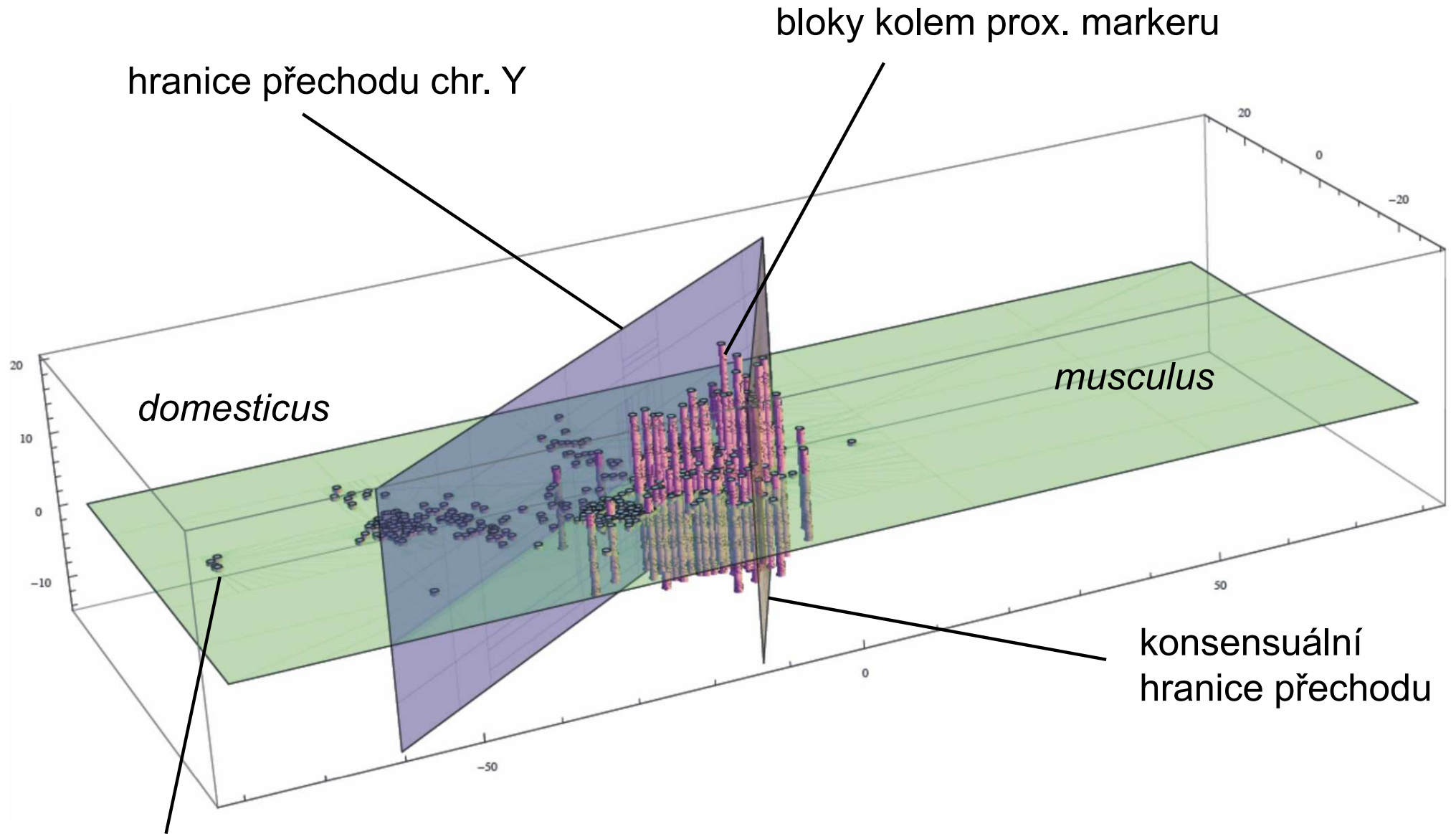

hranice přechodu chr. Y

bloky kolem prox. markeru

domesticus

musculus

konsenzuální
hranice přechodu

lokality bez introgrese

Rekombinace snižuje velikost introgresovaných
bloků směrem od středu zóny

Analýza pachových preferencí přes myšší hybridní zónu: zesílení (*reinforcement*) prezygotickou bariérou

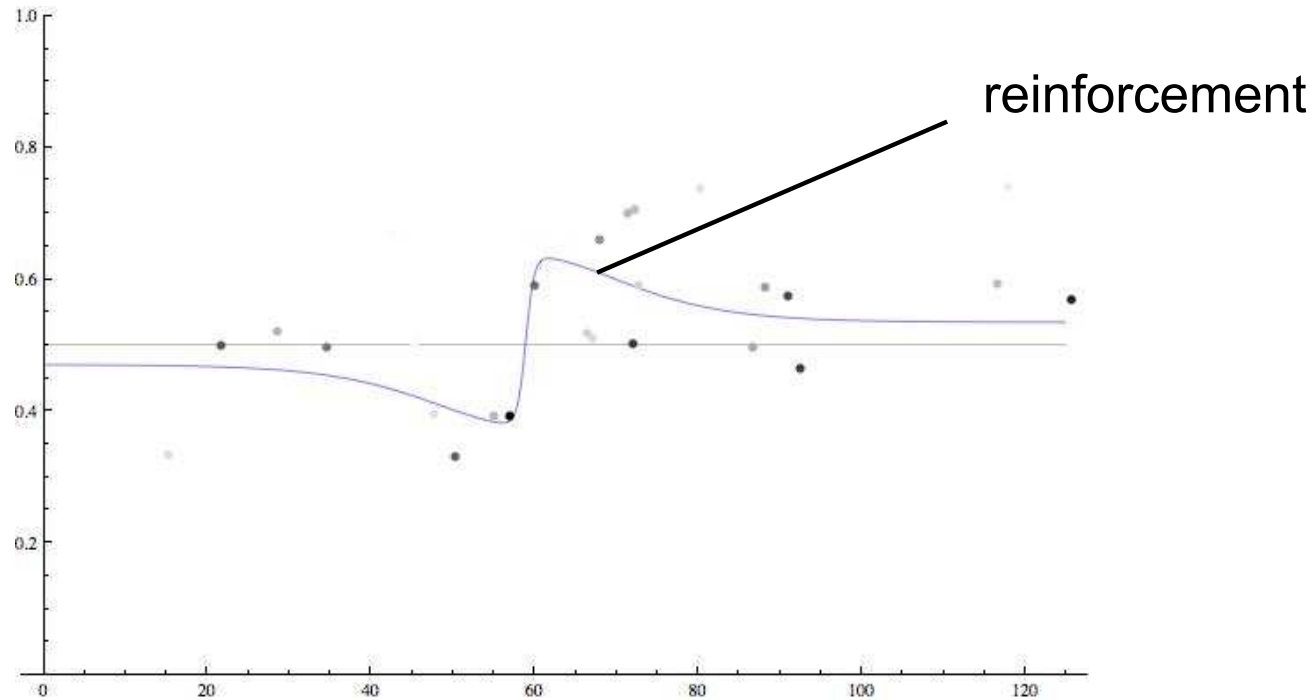

$$p^*(x, c, w, p_0, p_1, R) = p(1 + Kf')dx = p \left[1 + \frac{K}{Rw} \text{Sech}(y)^2 \right]$$

$$= \left(p_0 + \frac{\Delta p}{2} \left[1 + \text{Tanh} \left(\frac{y}{\Delta p} \right) \right] \right) \left(1 + (R - 1) \text{Sech}(y)^2 \right)$$

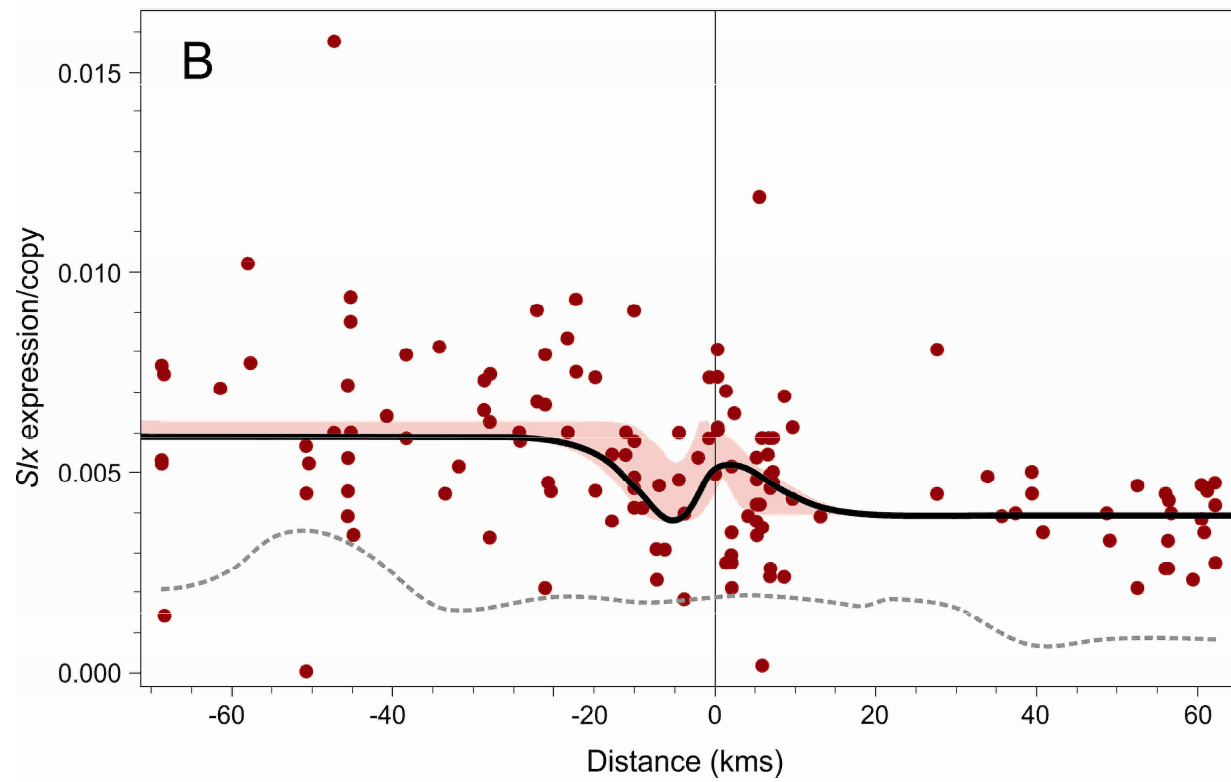
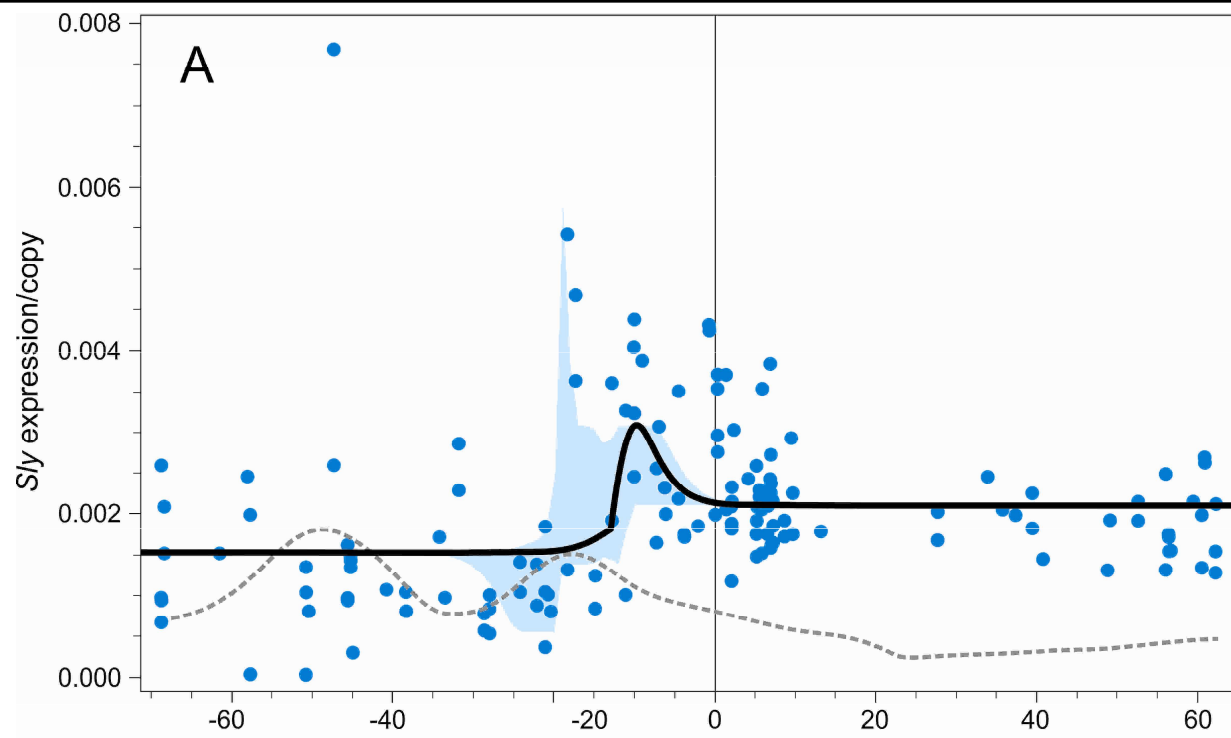

Proč studovat hybridní zóny? - speciace

Dobzhanského-Mullerův model

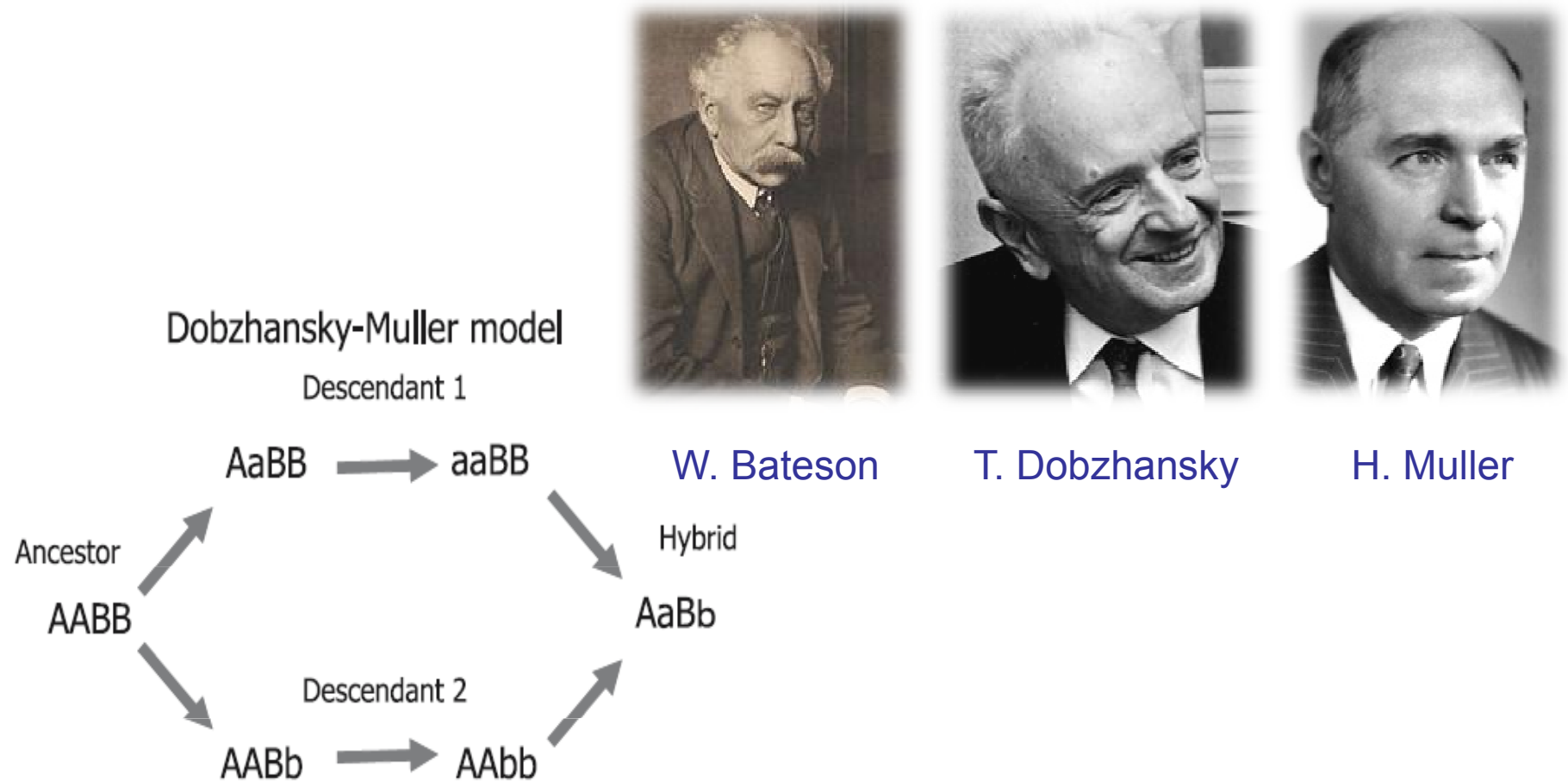
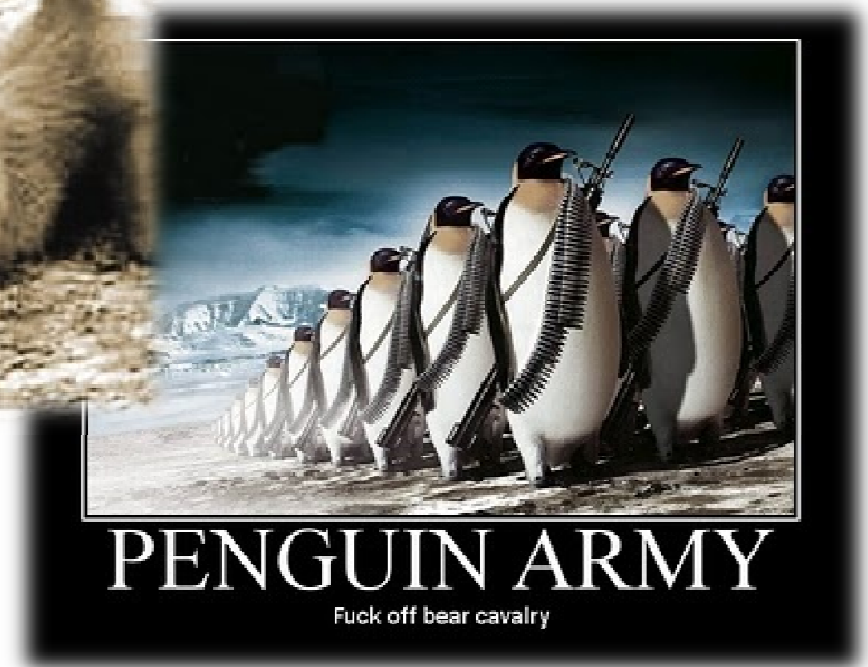
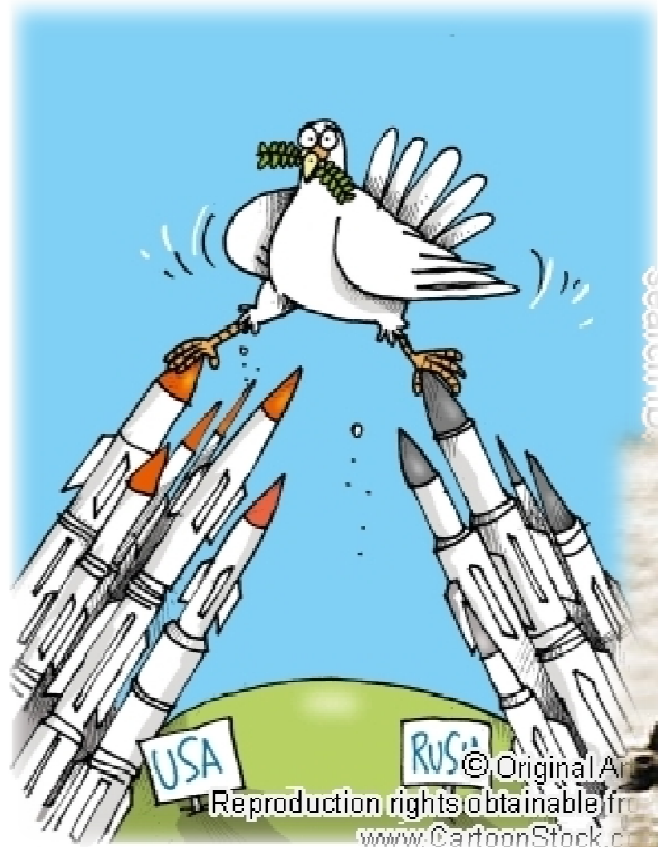
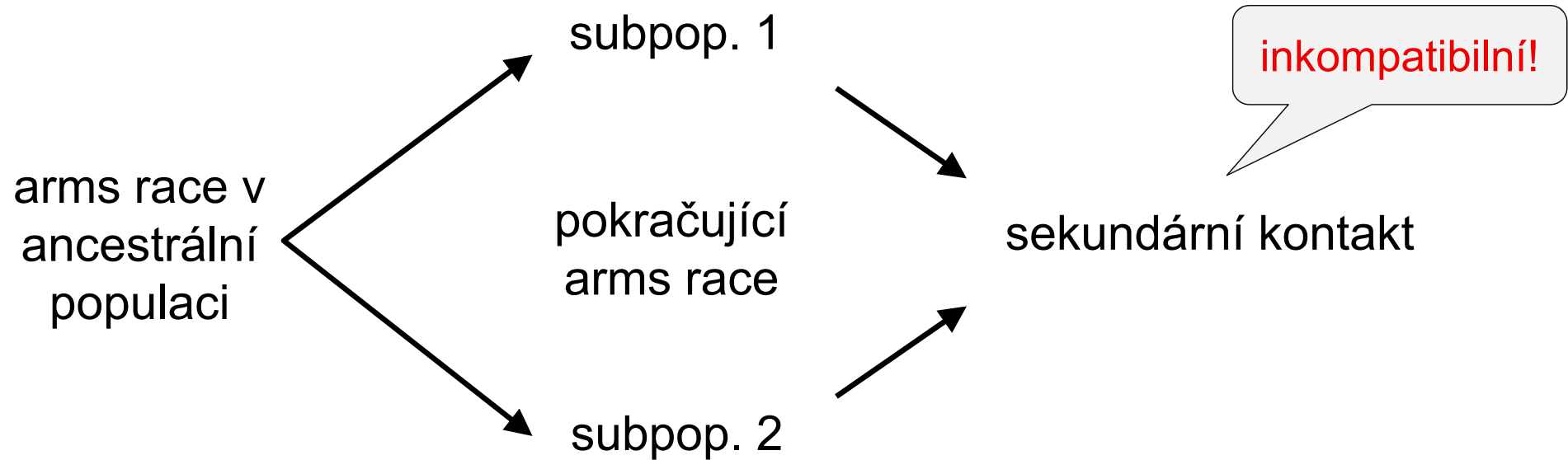

Fig. 1 The Dobzhansky–Muller model for postzygotic isolation (see text for a full explanation)

„Závody ve zbrojení“ a sekundární kontakt



genetický konflikt: "klasický" scénář



genetický konflikt: alternativní scénář

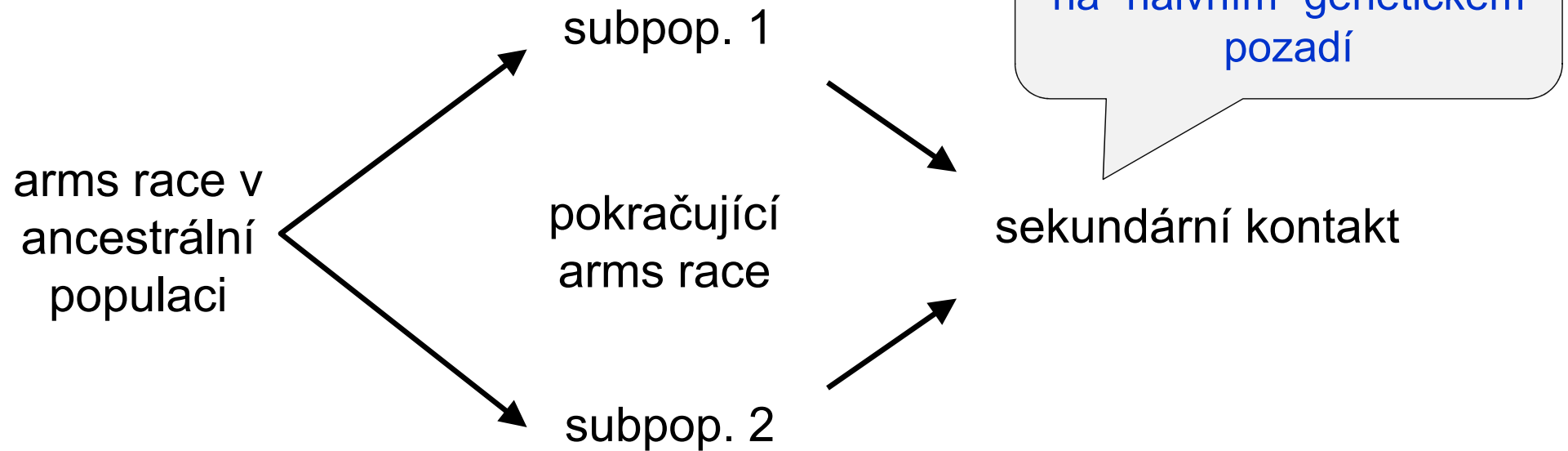

“antispeciační geny”

Proč nepozorujeme častěji?

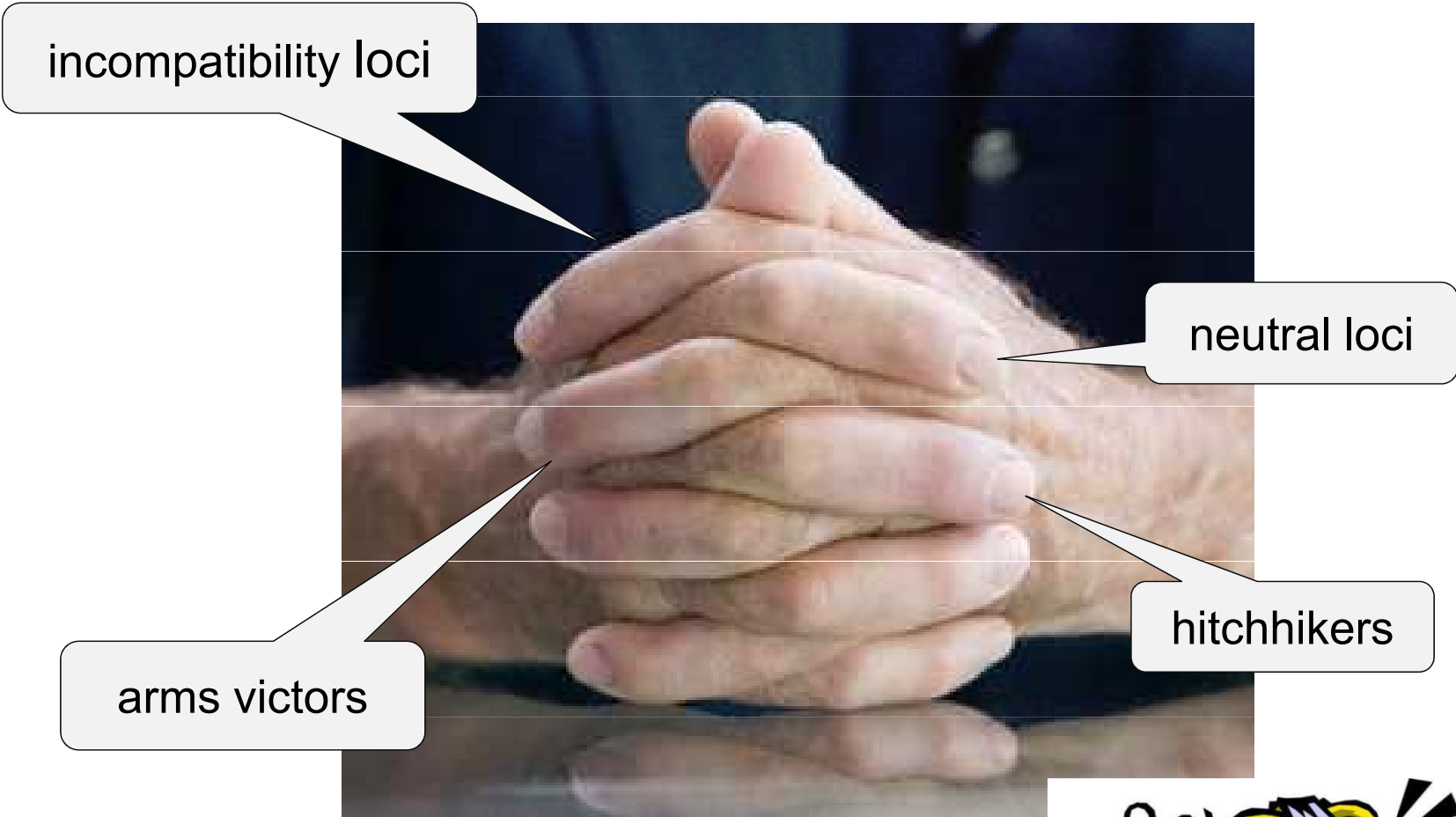

Časovaná bomba...



Cytonukleární nerovnováhy

- = nenáhodné asociace jaderných a cytoplazmatických (mitochondriálních) alel
- 3 × 2 tabulka

	jaderný genotyp:			
mtDNA:	<i>AA</i>	<i>Aa</i>	<i>aa</i>	celkem
<i>M</i>	u_1	v_1	w_1	<i>x</i>
<i>m</i>	u_2	v_2	w_2	<i>y</i>
celkem	<i>u</i>	<i>v</i>	<i>w</i>	1

Absence hybridizace

	jaderný genotyp:		
mtDNA:	AA	Aa	aa
<i>M</i>	+++	0	0
<i>m</i>	0	0	+++

Náhodné křížení, hybridní roj

	jaderný genotyp:		
mtDNA:	AA	Aa	aa
<i>M</i>	obs=exp	obs=exp	obs=exp
<i>m</i>	obs=exp	obs=exp	obs=exp

Hybridizace bez výraznější introgrese, křížení nezávisí na pohlaví

	jaderný genotyp:		
mtDNA:	AA	Aa	aa
<i>M</i>	++	obs=exp	0
<i>m</i>	0	obs=exp	++

Hybridizace bez introgrese, křížení závisí na pohlaví

	jaderný genotyp:		
mtDNA:	AA	Aa	aa
<i>M</i>	++	++	0
<i>m</i>	0	--	++

Programy pro analýzu hybridních zón:

Analyse: Stuart J.E. Baird, Nick H. Barton (Mac)

ClineFit: Adam Porter (PC)

CFit: Thomas Lenormand (PC)

(Geneland)



S.J.E. Baird



A. Porter



T. Lenormand



N.H. Barton

Tok genů – „ostrovy speciace“, „ostrovy divergence“ apod.

$$F_{ST} = \frac{\pi_{between} - \pi_{within}}{\pi_{between}}$$

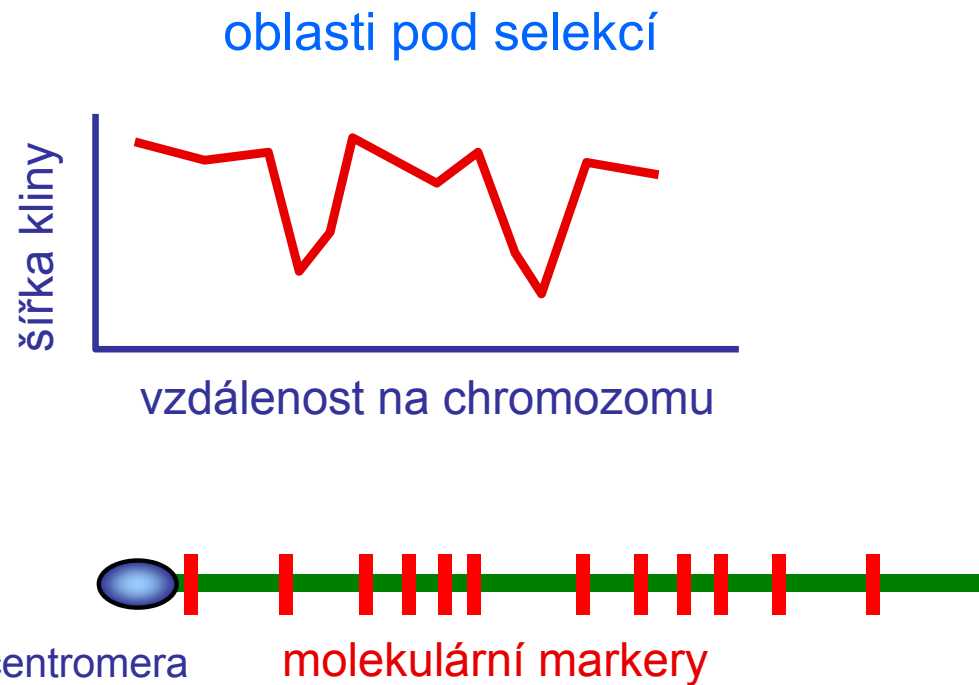

Problém: F_{ST} směšuje genový tok (tj. izolaci) a divergenci!!