

ELEMENTARY BAND THEORY

PHYSICIST

Solid state band
Valence band, VB
Conduction band, CB
Fermi energy, E_F
Bloch orbital, delocalized
n-doping
p-doping
Band gap, E_g
Direct band gap
Indirect band gap
Phonon or lattice vibration
Peierls distortion

CHEMIST

Molecular orbital
HOMO
LUMO
Chemical potential
Molecular orbital, localized
Reduction, pH scale base
Oxidation, pH scale acid
HOMO-LUMO gap
Dipole allowed
Dipole forbidden
Vibrational mode
Jahn-Teller effect

Electronic Structure of Solids

Valence electrons from the atoms spread throughout the entire structure

Molecular orbitals are extended over all the constituent atoms

A large number of overlapping atomic orbitals lead to molecular orbitals with very similar energies = continuous **band**

The bands are separated by **band gaps** (energy values where there are no available levels)

Band Theory

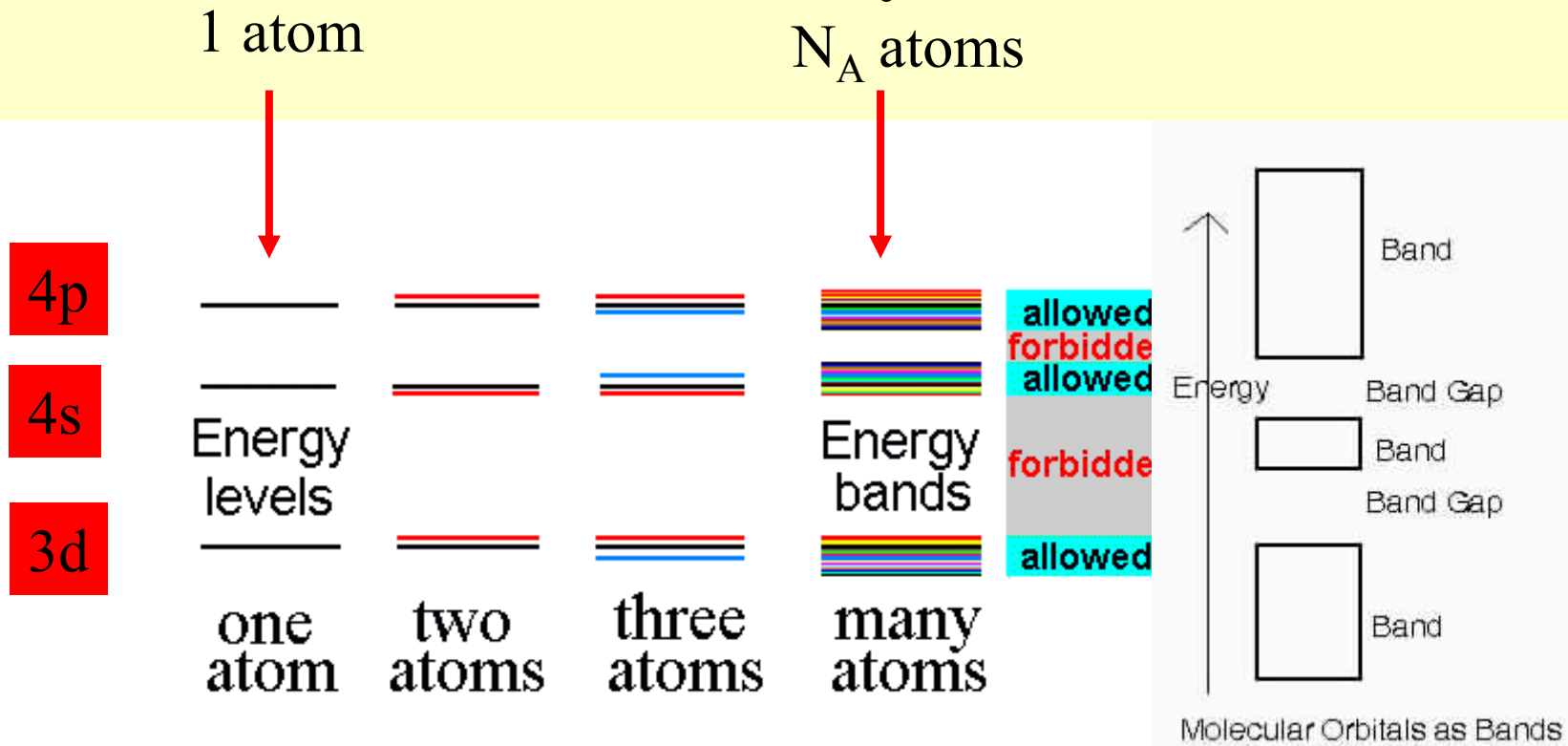

Energies of electrons are quantized = can possess only allowed energies, can occupy only allowed levels, cannot enter forbidden band gaps.

Molecular orbital $\rightarrow\rightarrow\rightarrow\rightarrow\rightarrow\rightarrow\rightarrow\rightarrow\rightarrow$ Electronic band

N atomic orbitals combine to form bonding and antibonding molecular orbitals, **N** energy levels.

Large rings - cyclic boundary condition

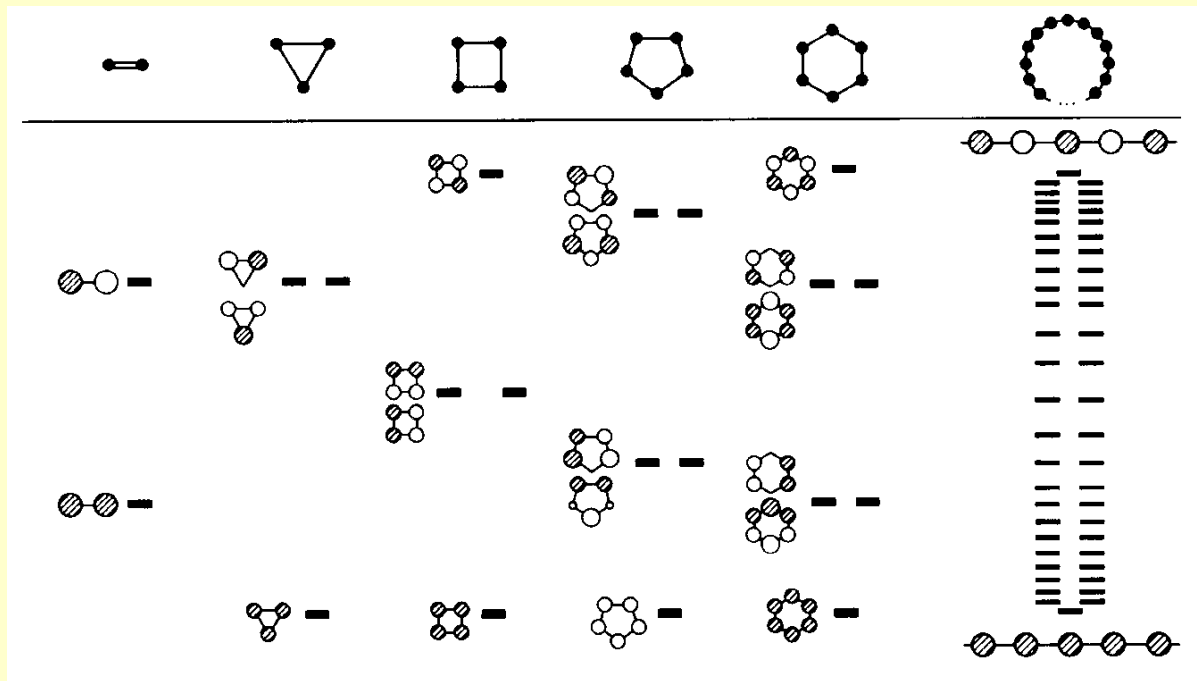

A rough rule of thumb: the separation of the energy levels in the dimer corresponds to about half width of the energy band.

Electronic Bands

As atoms get closer:

- Bands widen
- Bonding/Antibonding orbitals get lower/higher in energy

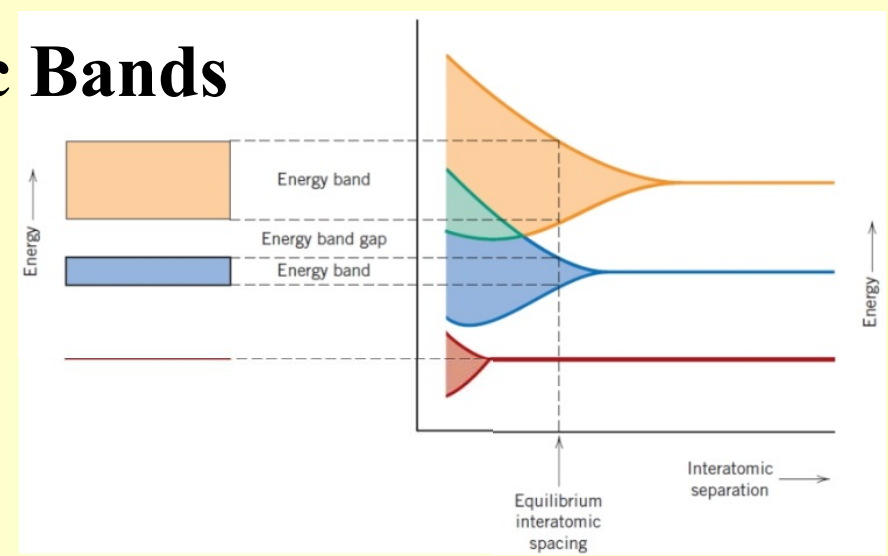

Insulator
Carbon
(diamond)
 $r_0 = 0.17 \text{ nm}$

Semiconductor
Silicon
 $r_0 = 0.24 \text{ nm}$

Periodic table environment of semiconductors

B	C $2p^2$	N
Al	Si $3p^2$	P
Ga	Ge $4p^2$	As
In	Sn $5p^2$	Sb
Tl	Pb $6p^2$	Bi

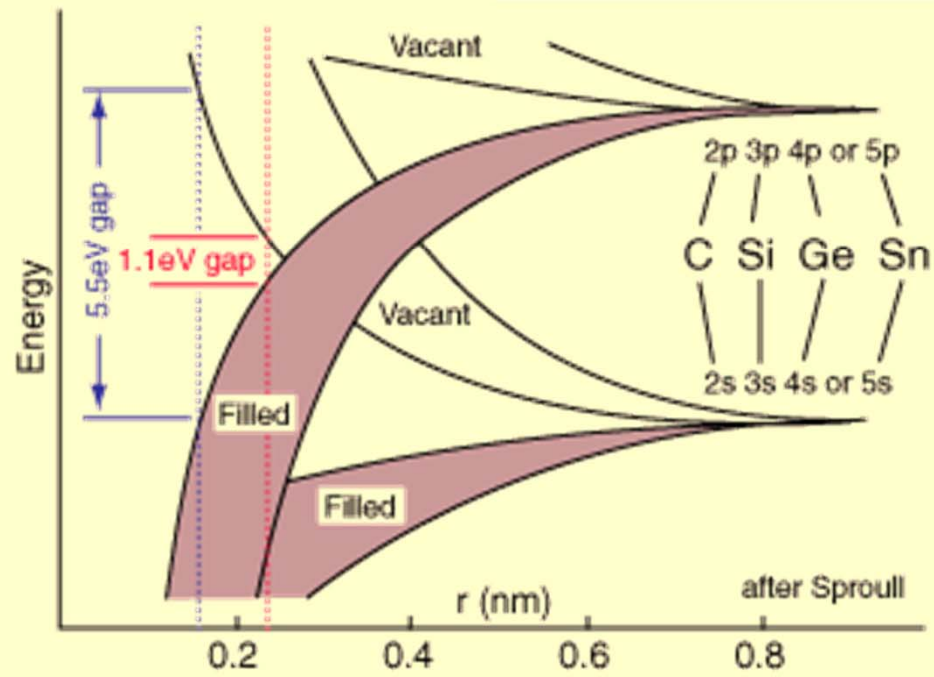

← p - orbital

← s - orbital

Electronic Structure of Solids

Bands arise from many MO's of slightly different energies - different degree of bonding

The **bottom** of the band – the lowest energy MO, all bonding character

The **top** – the highest energy MO with all anti-bonding character

The rest of the band is formed from all the MO's with intermediate bonding character between the two extremes

Crystal Orbitals in 1D - Nodes

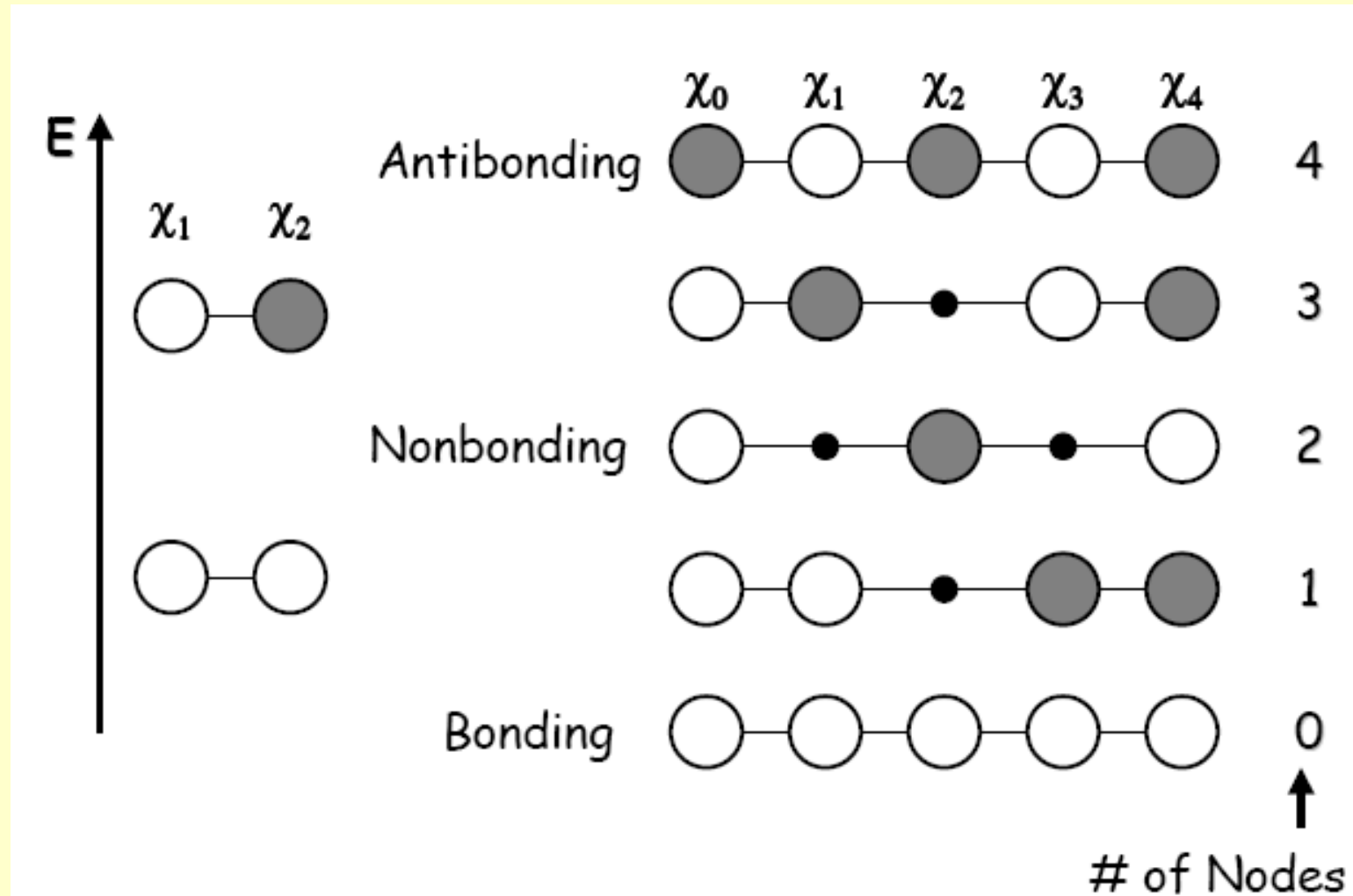

Crystal Orbitals

N atoms in the chain = N energy levels and N electronic states (MO)

The wavefunction for each electronic state:

$$\Psi_{\mathbf{k}} = \sum e^{i\mathbf{k}n\mathbf{a}} \chi_n$$

Where:

a is the lattice constant (spacing between atoms)

n identifies the individual atoms within the chain

χ_n represents the atomic orbitals

k is a quantum number that identifies the wavefunction and the phase of the orbitals

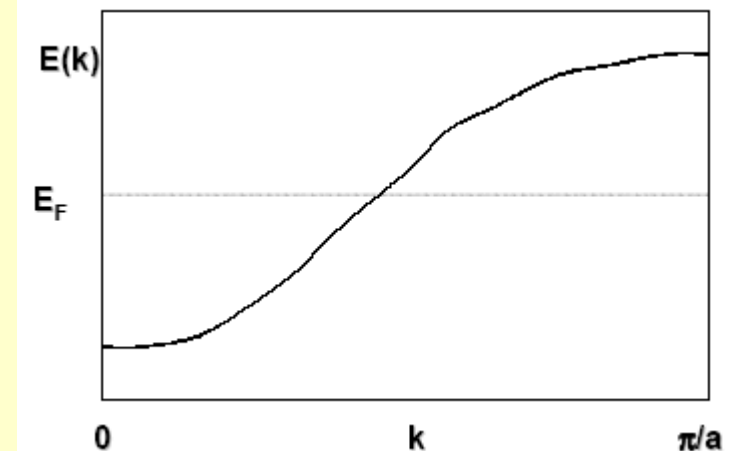
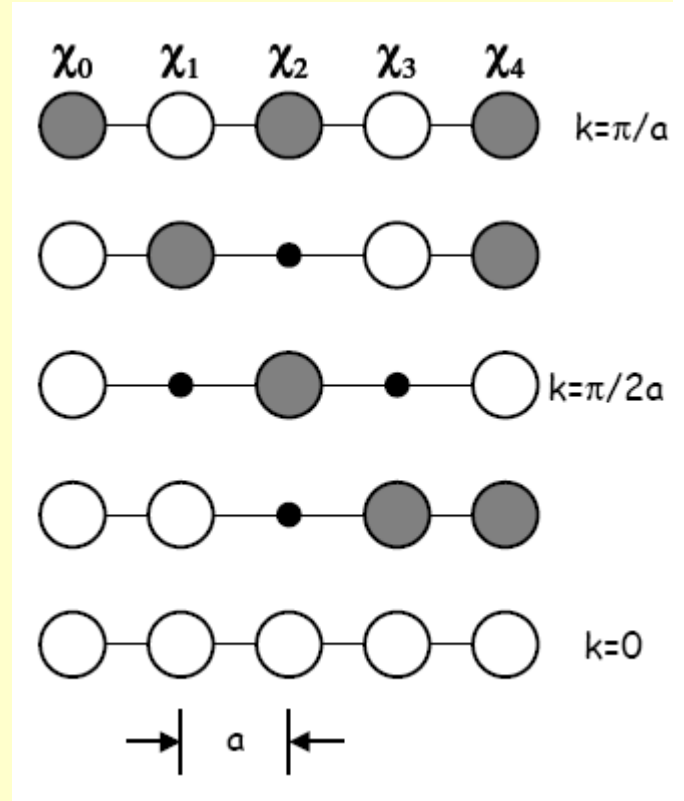

Band Theory

Bloch functions, crystal orbitals
 simple example:
 infinite one-dimensional array of
 s-orbitals

k = wavevector gives the phase of the
 AOs as well as the wavelength of the
 electron wavefunction (crystal
 momentum)
 a = lattice constant
 n = orbital counter

Large number of discrete levels =
 band

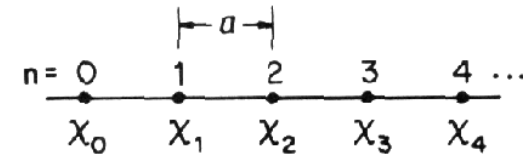

$$\psi_k = \sum_n e^{ikna} \chi_n$$

$$k = \frac{\pi}{a} \quad \psi_{\frac{\pi}{a}} = \sum_n e^{i\pi n} \chi_n = \sum_n (-1)^n \chi_n$$

$$= \chi_0 - \chi_1 + \chi_2 - \chi_3 + \dots$$

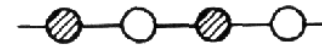

Antibonding

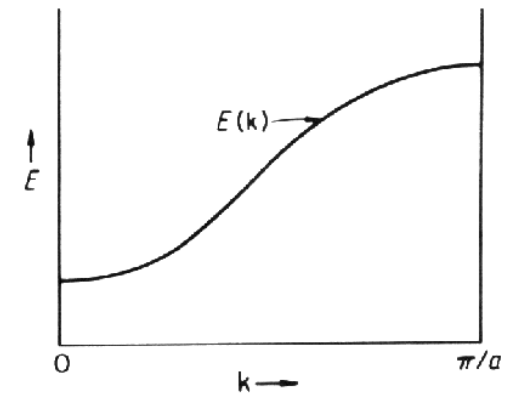

Bonding

$$k = 0 \quad \psi_0 = \sum_n e^{i0} \chi_n = \sum_n \chi_n$$

$$= \chi_0 + \chi_1 + \chi_2 + \chi_3 + \dots$$



Band Theory

Antibonding orbitals

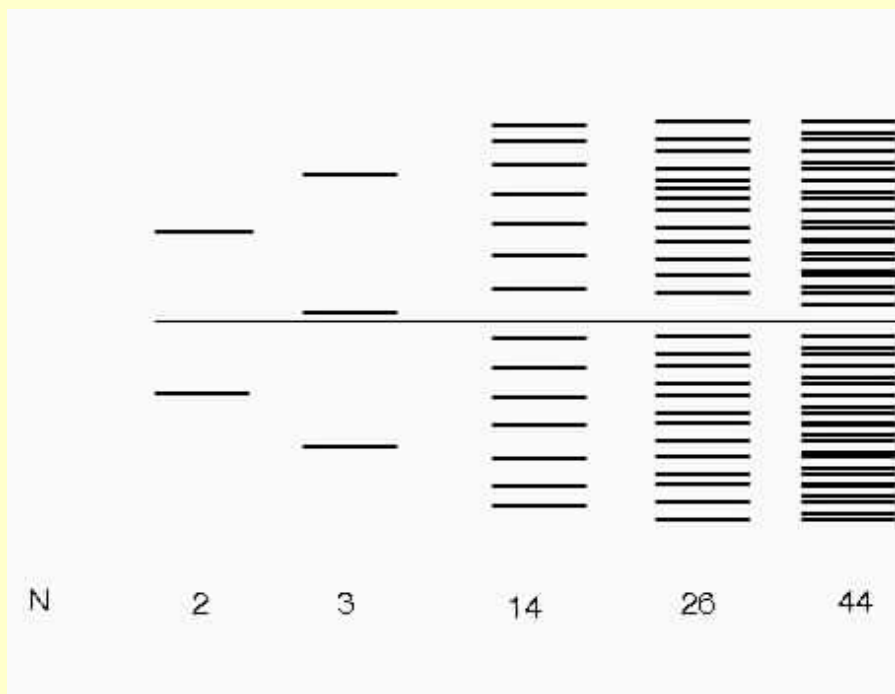

$$k = \frac{\pi}{a} \quad \psi_{\frac{\pi}{a}} = \sum_n e^{i\pi n} \chi_n = \sum_n (-1)^n \chi_n$$

$$= \chi_0 - \chi_1 + \chi_2 - \chi_3 + \dots$$

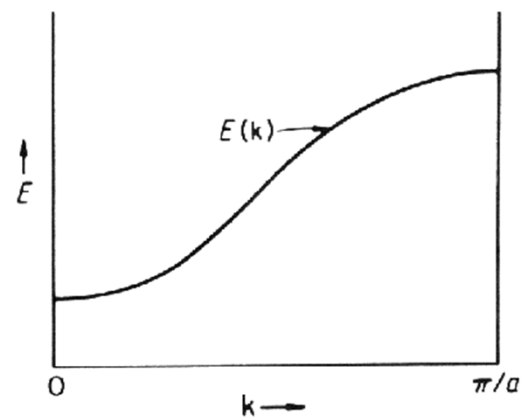
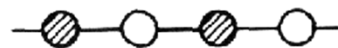

$$k = 0 \quad \psi_0 = \sum_n e^{i0} \chi_n = \sum_n \chi_n$$

$$= \chi_0 + \chi_1 + \chi_2 + \chi_3 + \dots$$



Bonding orbitals

Filling Bands by Electrons

N atoms, 1 electron on each

N levels in a band

Occupied by **pairs** of electrons

$N/2$ levels filled

$N/2$ levels empty

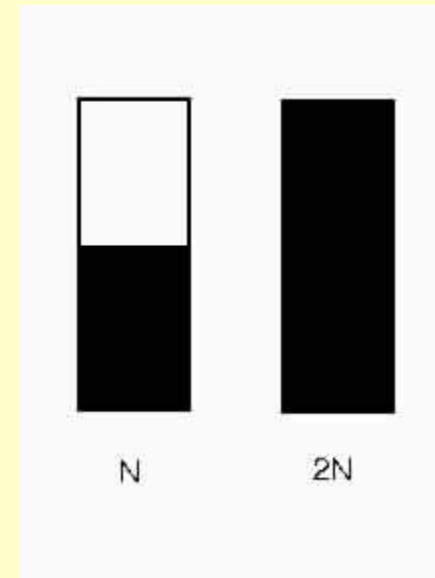

Bands in Metals

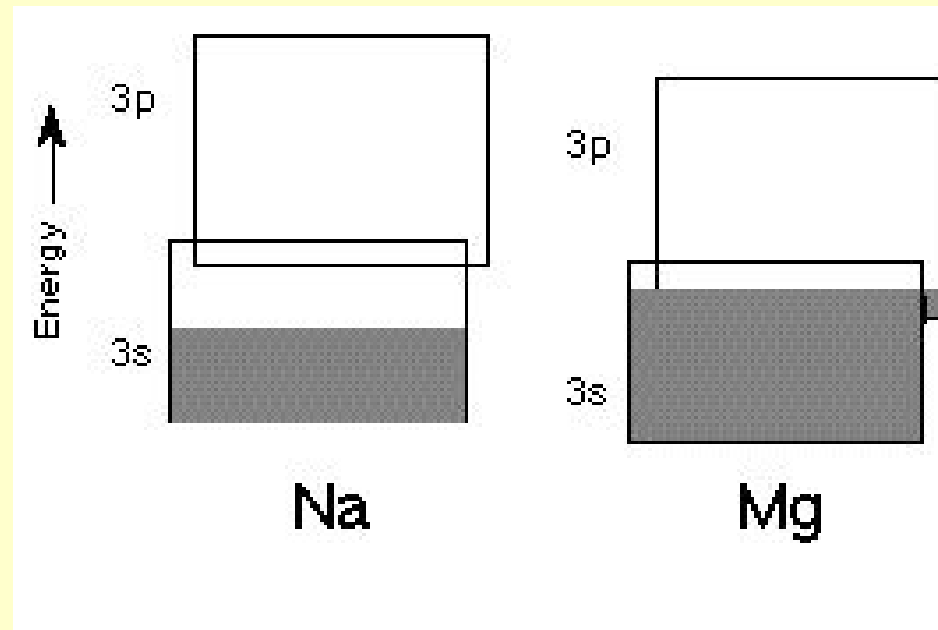
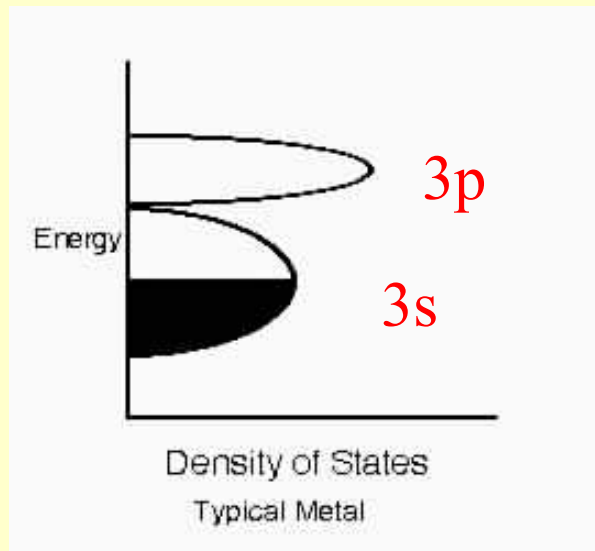

Bandwidth or Band Dispersion

Energy difference between the highest and lowest level

Bandwidth **increases** with better orbital overlap

- shorter interatomic distance
- closer energy match
- topology
- density, oxides more diffuse than halides, wider bands
- localization of electrons – narrow bands

Bandwidth arising from $\sigma > \pi > \delta$ overlap

Core orbitals – narrow bands (0.1 eV), 4f in lanthanides

Valence orbitals, s, p – wide bands (10 eV)

Wide bands = Large intermolecular overlap = delocalized e^-

Narrow bands = Weak intermolecular overlap = localized e^- 13

Bandwidth or Band Dispersion

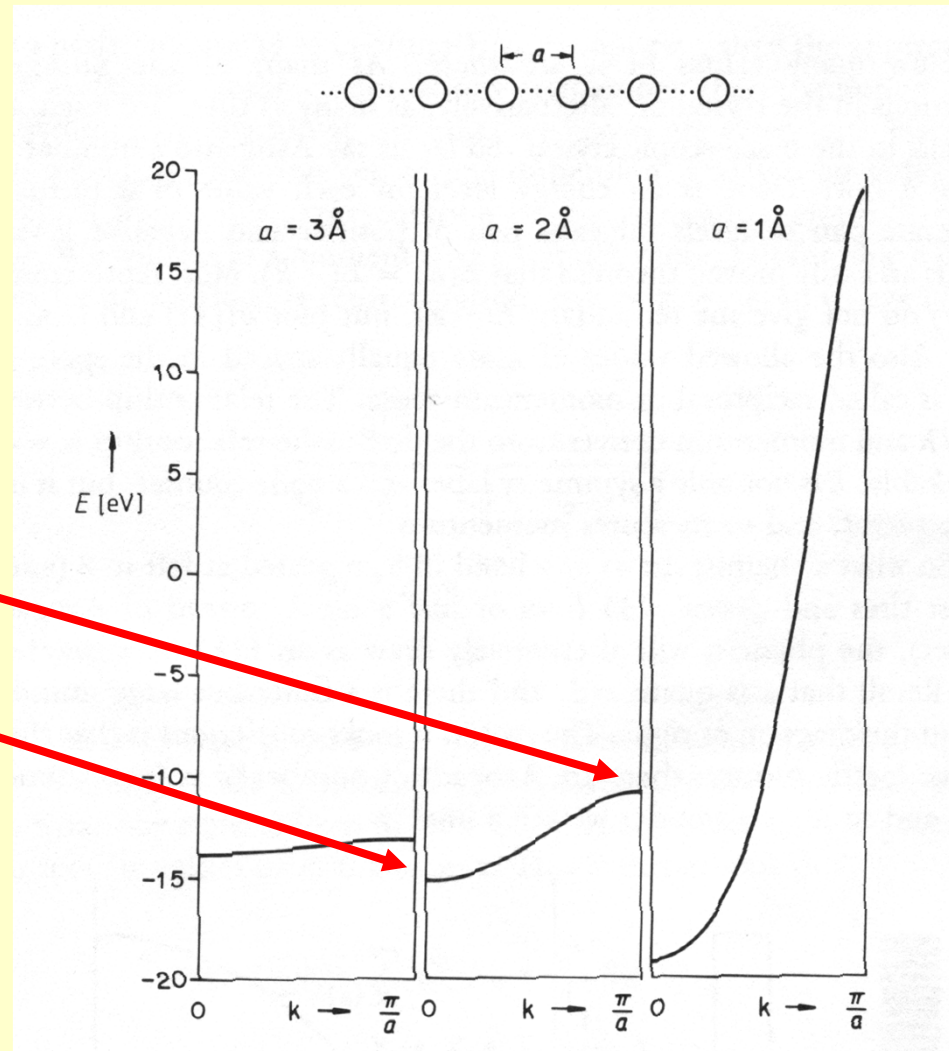

energy difference
between the highest
and lowest level

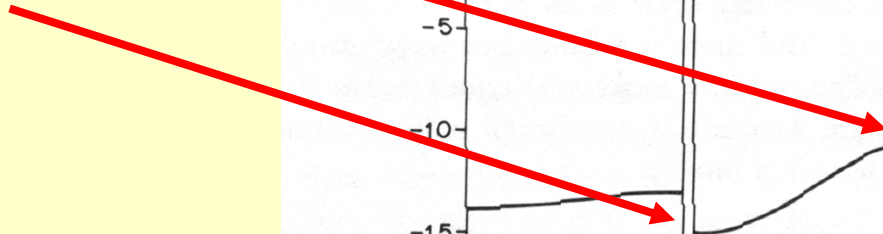
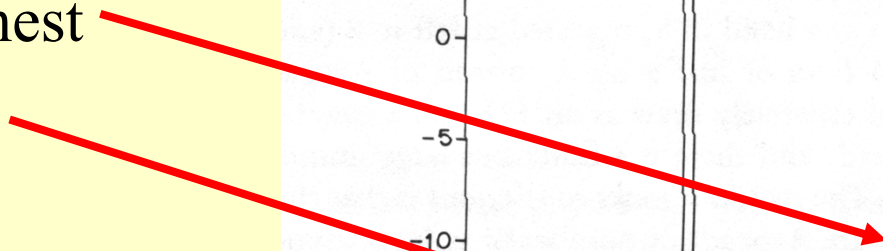

Different types of orbitals
(symmetry) form separate bands
s, p, d bands

distinct bands with a band gap
overlapping bands

depends on the separation of the
orbitals and strength of the
interaction between the atoms

Strong interaction = wide bands and
a greater overlap.

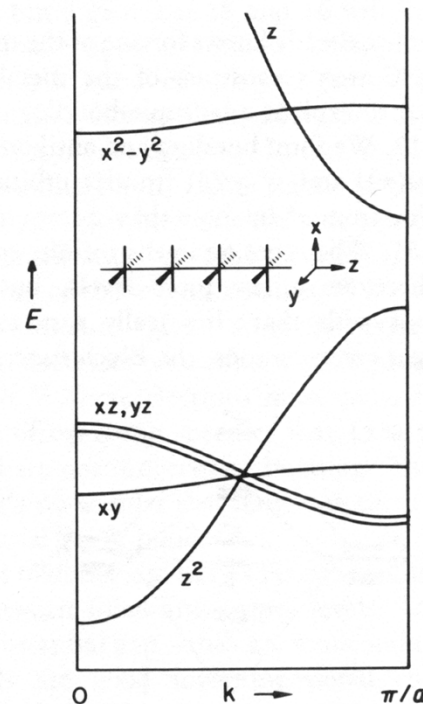
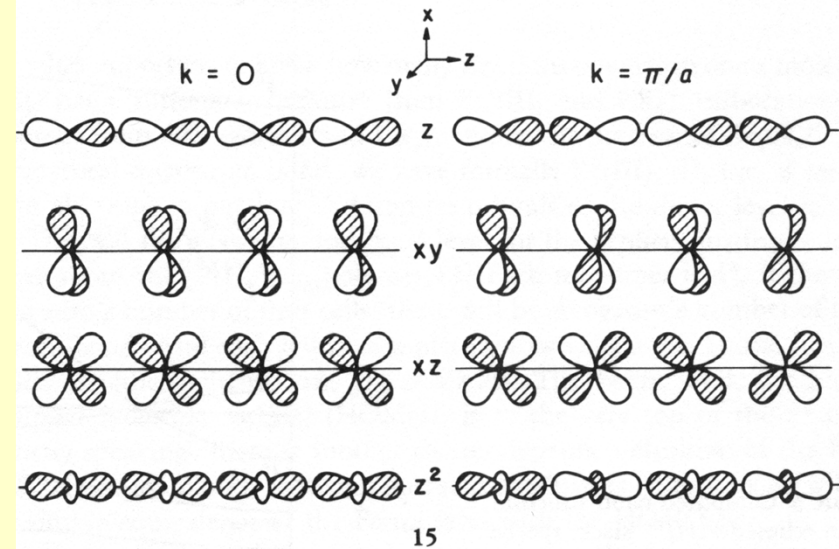

Two dimensional lattice

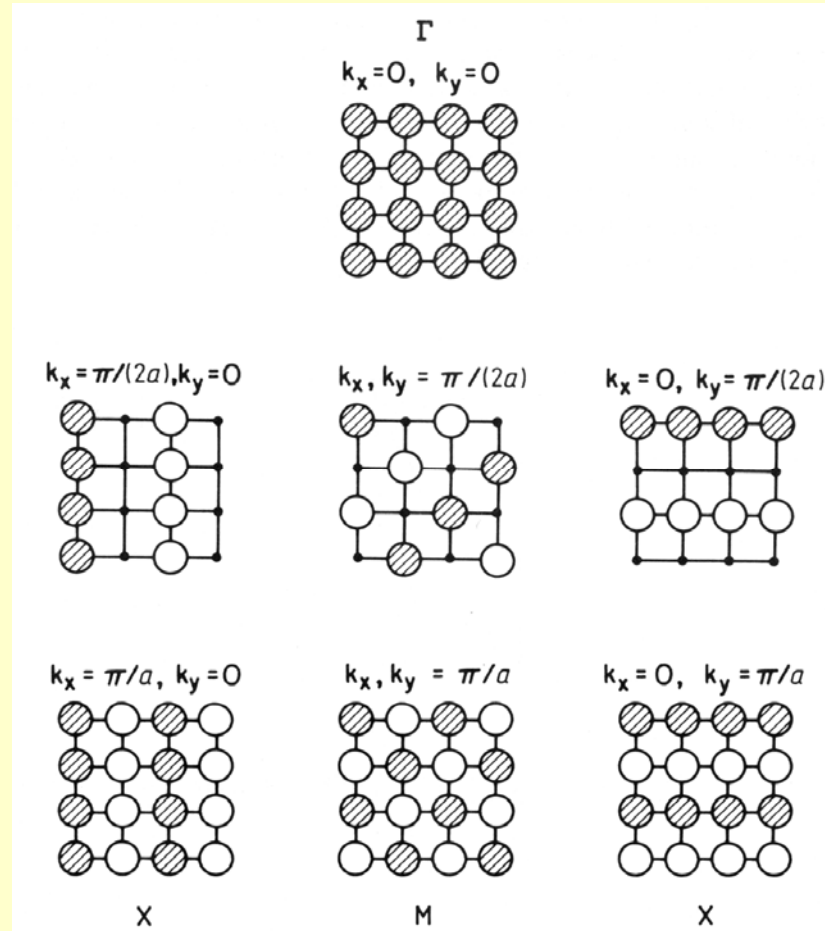

Two dimensional lattice

**Band structure
of a square lattice of H atoms
($d_{\text{HH}} = 2.0 \text{ \AA}$)**

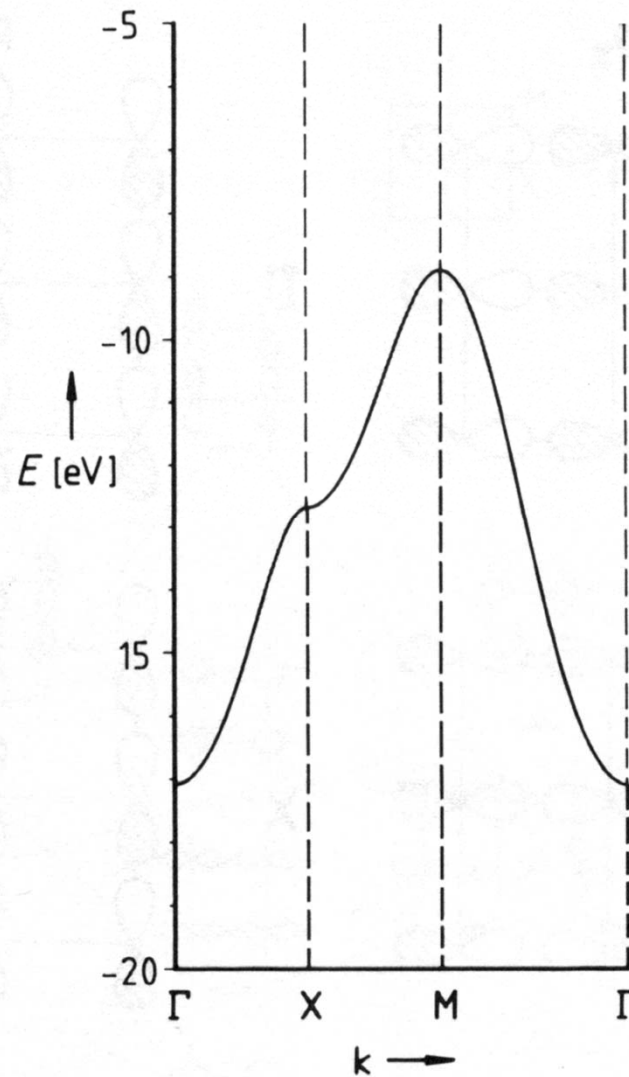

Density of states

a) MO diagram with translational symmetry taken into account

b) Density of states (DOS, $N(E) dE$)

Number of levels available for electrons at different energies per unit volume of the solid. DOS is zero in the band gap

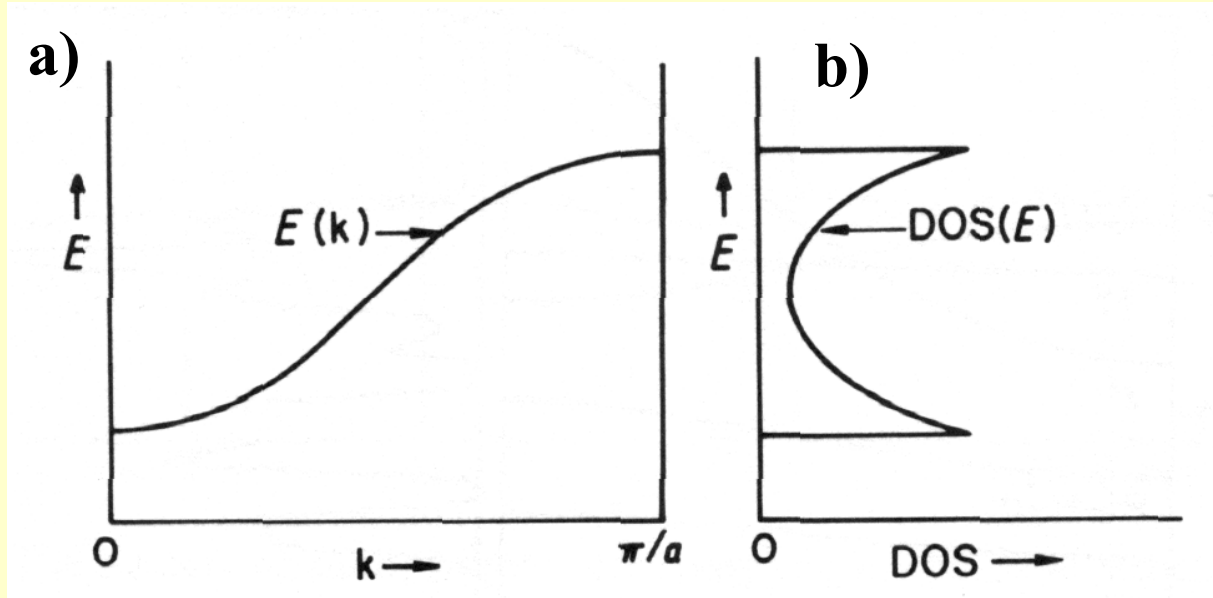

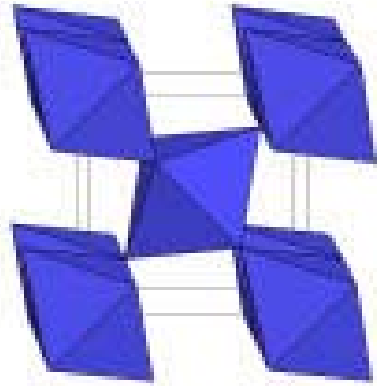

Rutile TiO₂ Band Structure

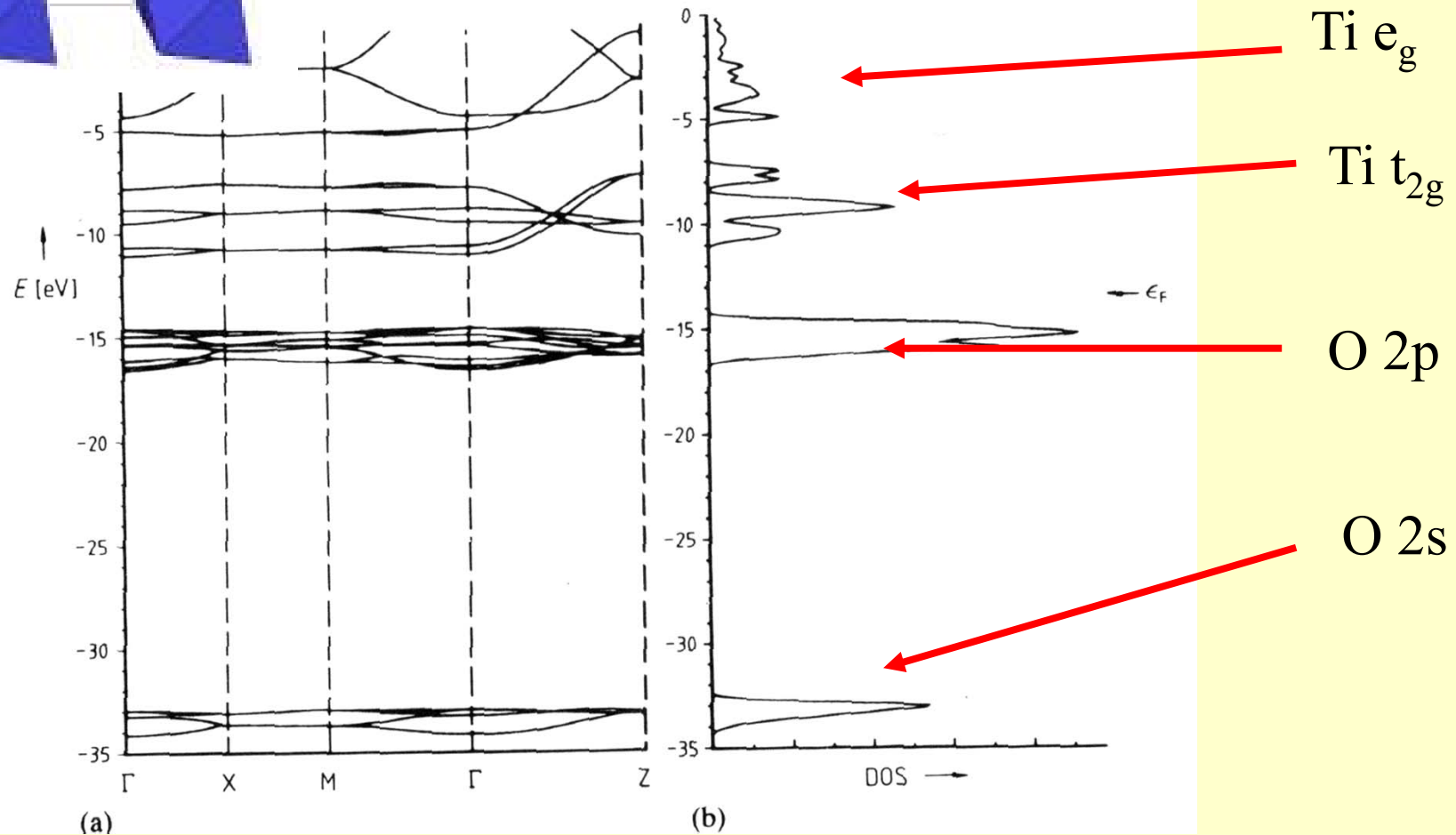

Band structure – spaghetti (a) and DOS (b)

**Contributions to
the total DOS of rutile**

(a) Ti and O

(b) Ti d-orbitals, t_{2g} and e_g

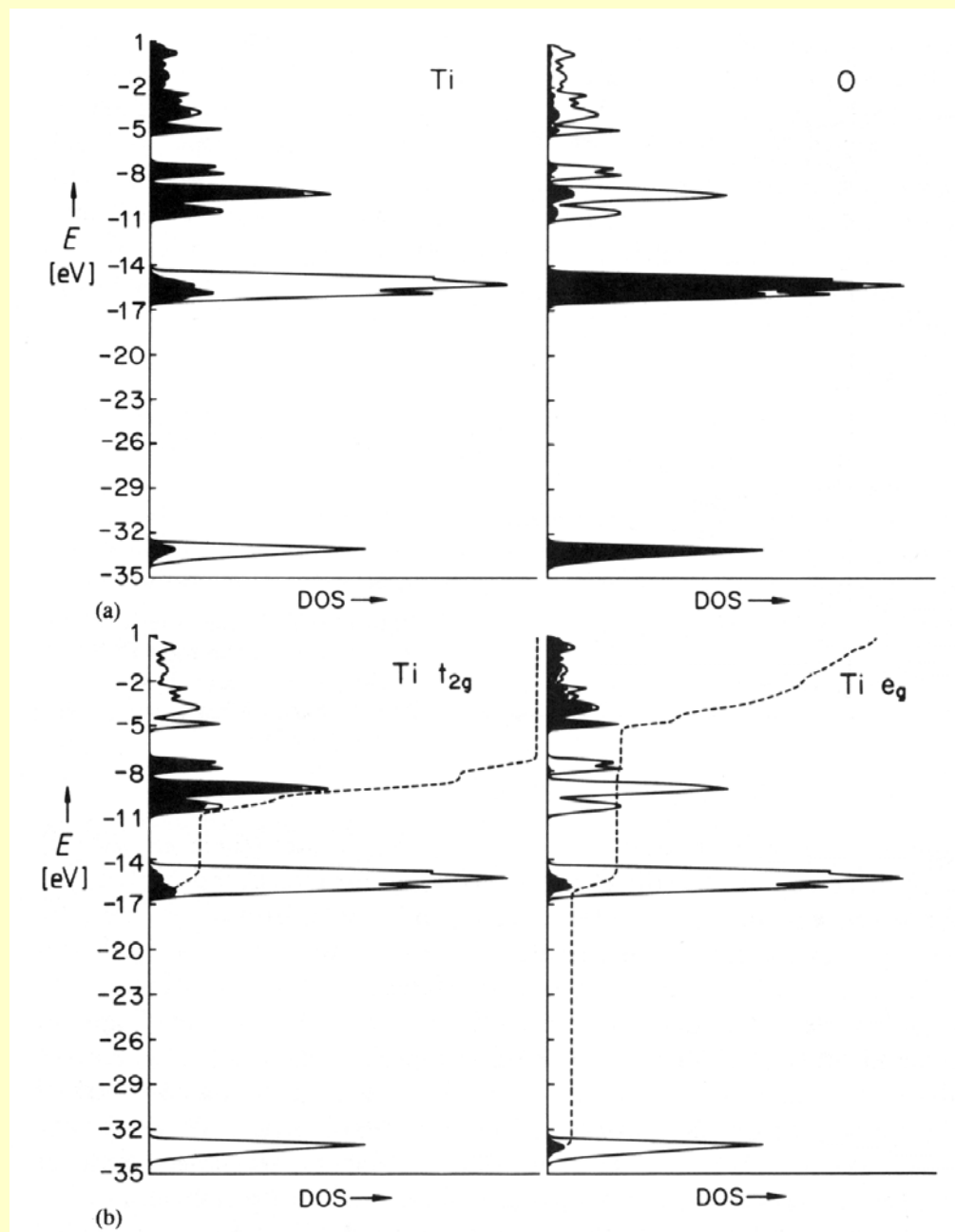

Classification of solids

Molecular solids – N₂, C₆H₆, I₂, ...

Van der Waals forces, little change from the gas phase, electronic bands correspond to empty and filled MOs of the individual molecules.

Ionic solids – NaCl, CaF₂, NiO, ...

Charge transfer from cations to anions, energy bands made up from the atomic orbitals of cations and anions.

NaCl: 3p of Cl is the top filled band, 3s of Na is the lowest empty band.

Covalent solids – diamond, Si,

Overlap of orbitals and electron sharing between adjacent atoms.

Filled bands are made up from bonding MOs, empty bands are made up from antibonding MOs.

Metallic solids – Cu, Mg, W, TiO,

Simple metals – Na

Very strong overlap of atomic orbitals on adjacent atoms, arising bands are very broad, 3s, 3p, and 3d merge into a single wide band, electrons move freely, little attraction to the atomic cores.

Ionic solids

Example NaCl, $E_g = 9$ eV

i = ions in the gas phase

ii = ions in the lattice,
Madelung potential,
filled levels stabilized by positive
potential of cations,
empty levels destabilized

iii = polarization energy

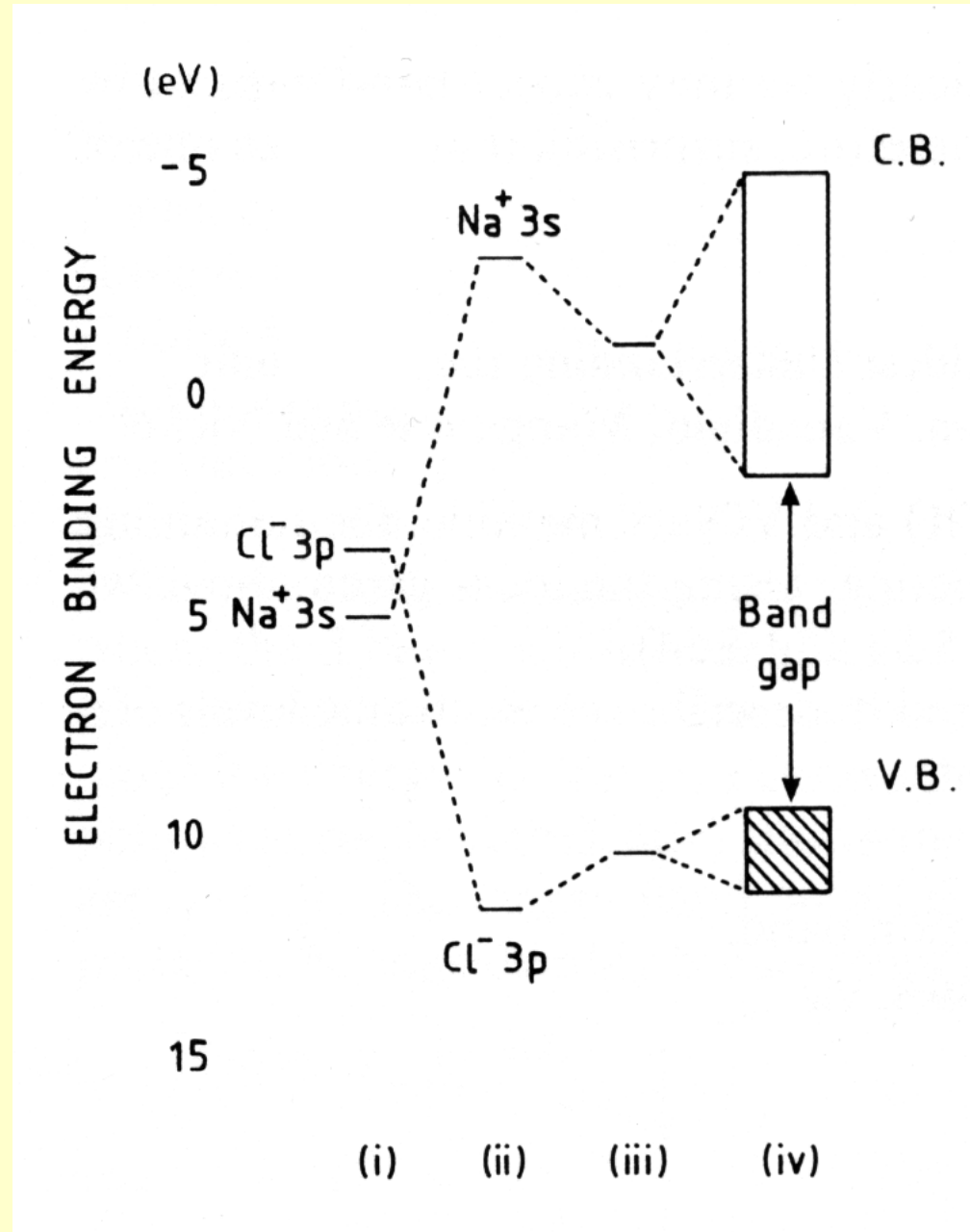

Metallic and Non-metallic Solids

The distinction between metallic and non-metallic solids
- the orbitals filling

Metallic behavior – a partially filled band, no gap between the top filled level (Fermi level) and the lowest empty one

Non-metallic behavior – a completely filled level (the valence band) and an empty one (the conduction band) separated by a band gap

Fermi level

E_F = the thermodynamic chemical potential for electrons in the solid

Metals – boundary between filled and unfilled levels

The Fermi-Dirac distribution function:

$$f(E) = 1/[1 + \exp\{(E - E_F)/kT\}]$$

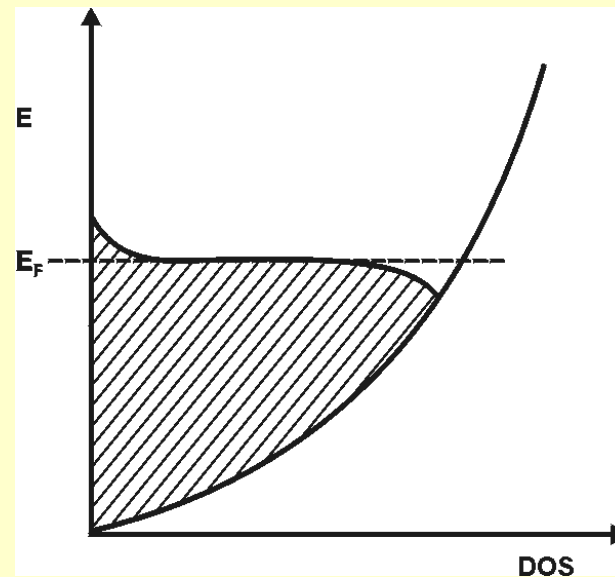
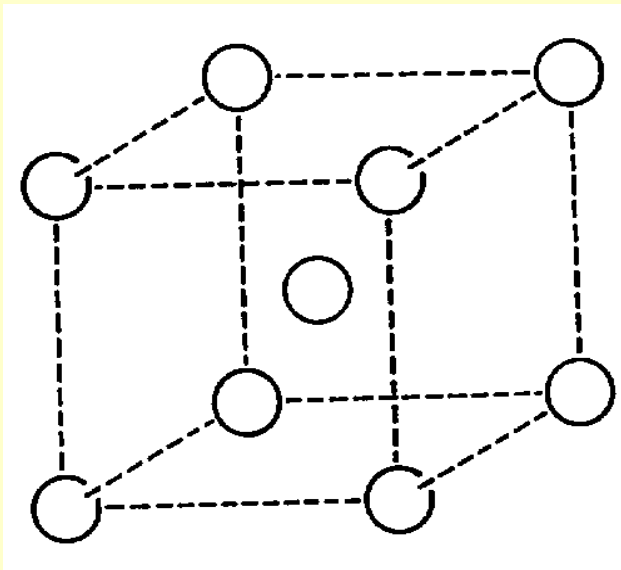

The Fermi level cuts a band in a metal

Fermi Level

E_f occupation probability $\frac{1}{2}$

Levels

$E < E_f$ occupied

$E > E_f$ empty

$$P = \frac{1}{e^{(E-E_f)/kT} + 1}$$

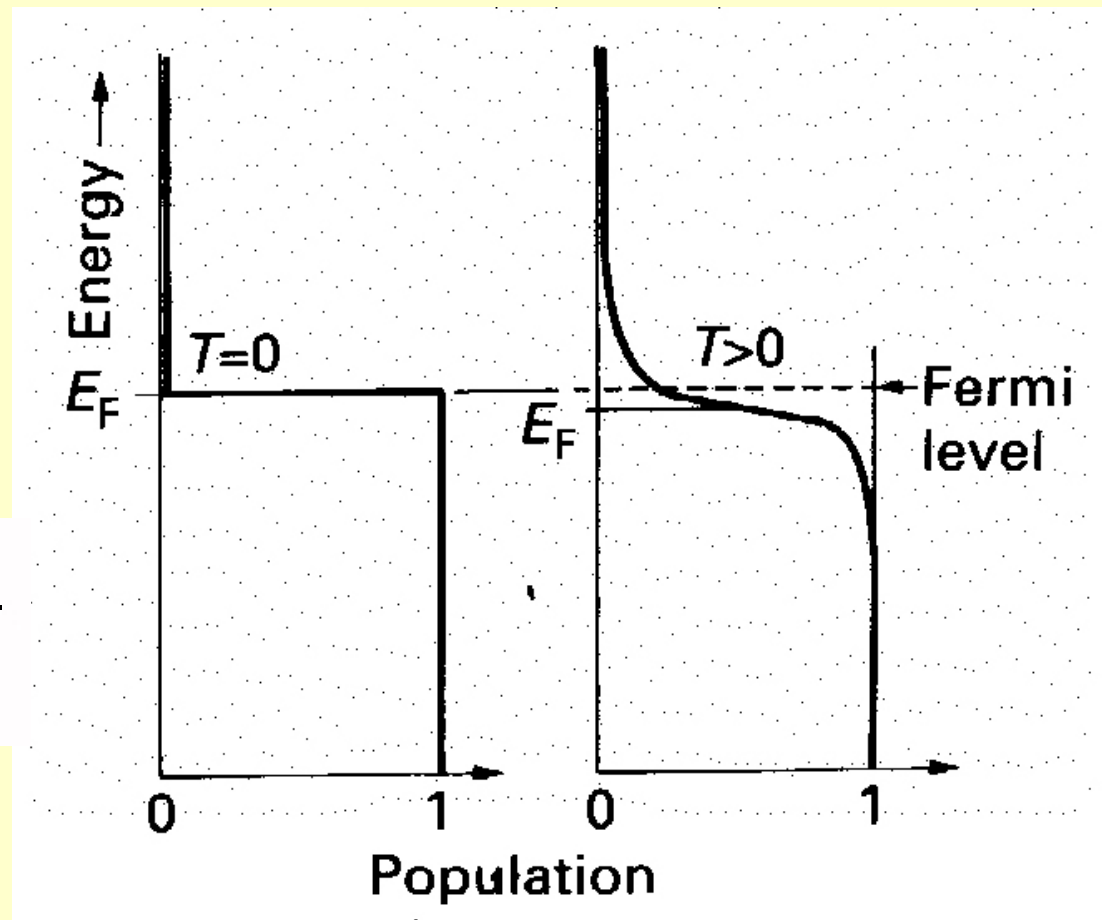

Fermi Level

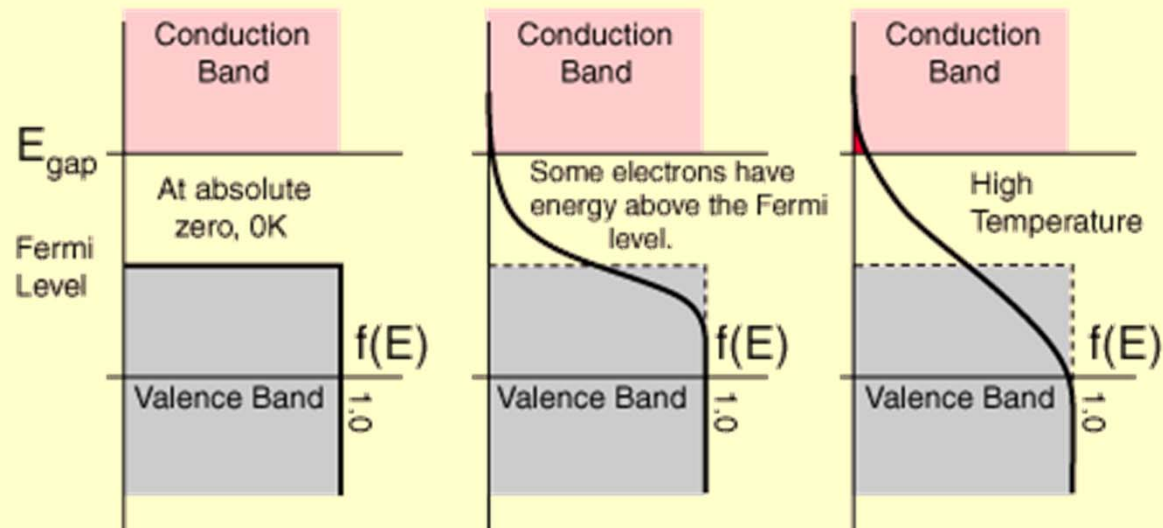

No electrons can be above the valence band at 0K, since none have energy above the Fermi level and there are no available energy states in the band gap.

At high temperatures, some electrons can reach the conduction band and contribute to electric current.

$$P = \frac{1}{e^{(E-E_f)/kT} + 1}$$

Metallic and Non-metallic Solids

In the **filled band** every electron is matched by another - no overall net motion of electric charge

For conduction to occur electrons have to be excited up to the conduction band by overcoming an activation energy and hence, the conduction of these compounds increases with temperature

Metallic and Non-metallic Solids

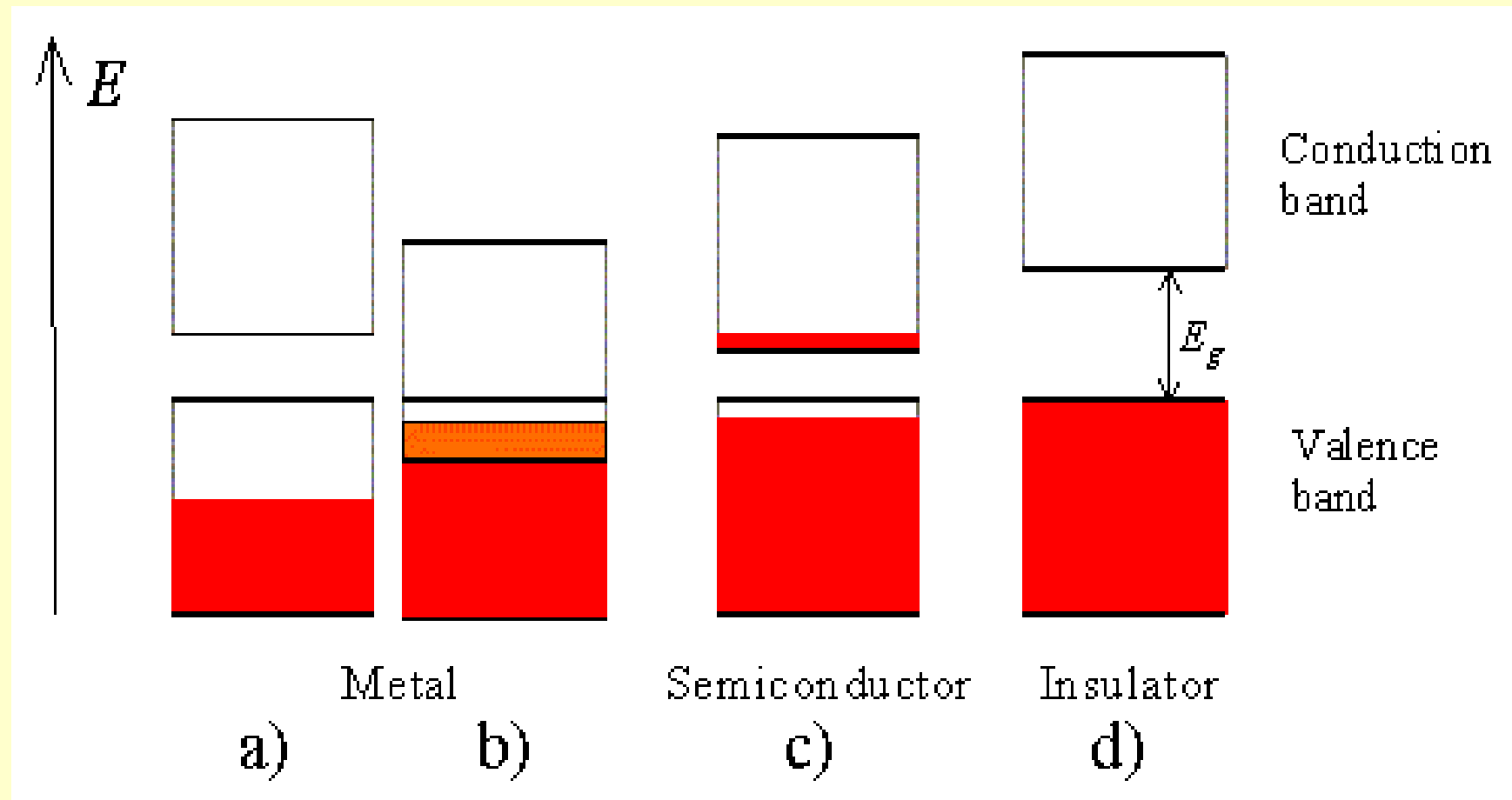

Semiconductors and Insulators

Band gap = the minimum photon energy required to excite an electron up to the conduction band from the valence band
The band gap size determines a semiconductor or an insulator

Insulators - a completely filled valence band separated from the next empty energy band by a large, forbidden gap

Diamond = insulator, a very large band gap of ~ 6 eV
very few electrons have sufficient energy to be promoted and the conductivity is negligibly small

Conductivity of insulators increases with temperature

Band Gap Energies, kJ mol⁻¹

NaCl	840
Diamond	480
ZnO	315
CdO	210
B	170
Si	125
Ge	85
Te, InAs	40
PbTe, InSb	20
α-Sn (grey)	8
Mg, Al, Cu, β-Sn (white).....	0

$$1 \text{ eV} = 1.60210 \cdot 10^{-19} \text{ J}$$

$$1 \text{ eV (molecule)}^{-1} = 1 \text{ eV} \times N_A = 96 \, 485 \text{ J mol}^{-1}$$

Electrical Conductivity

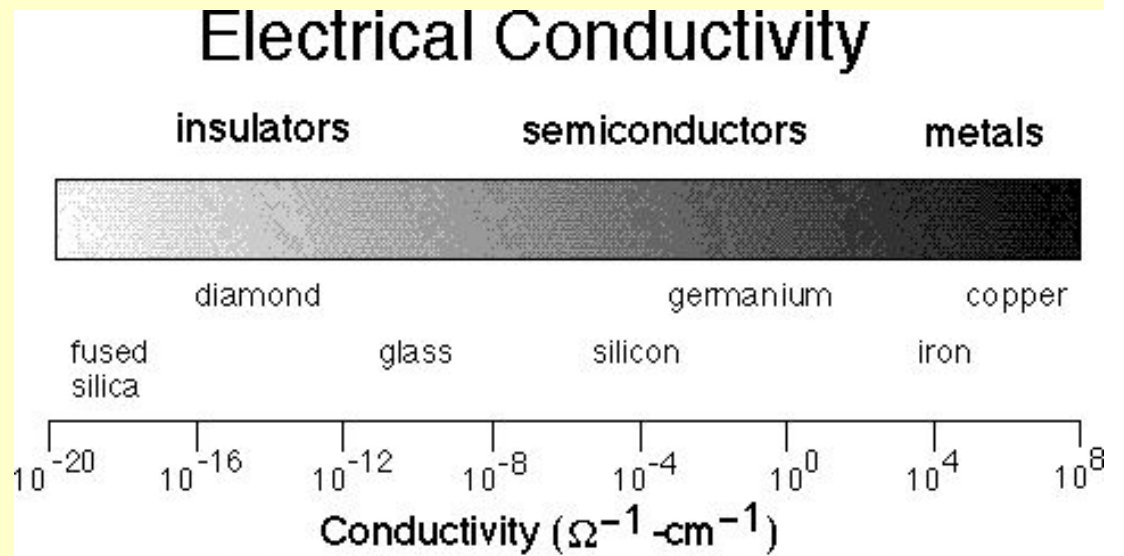
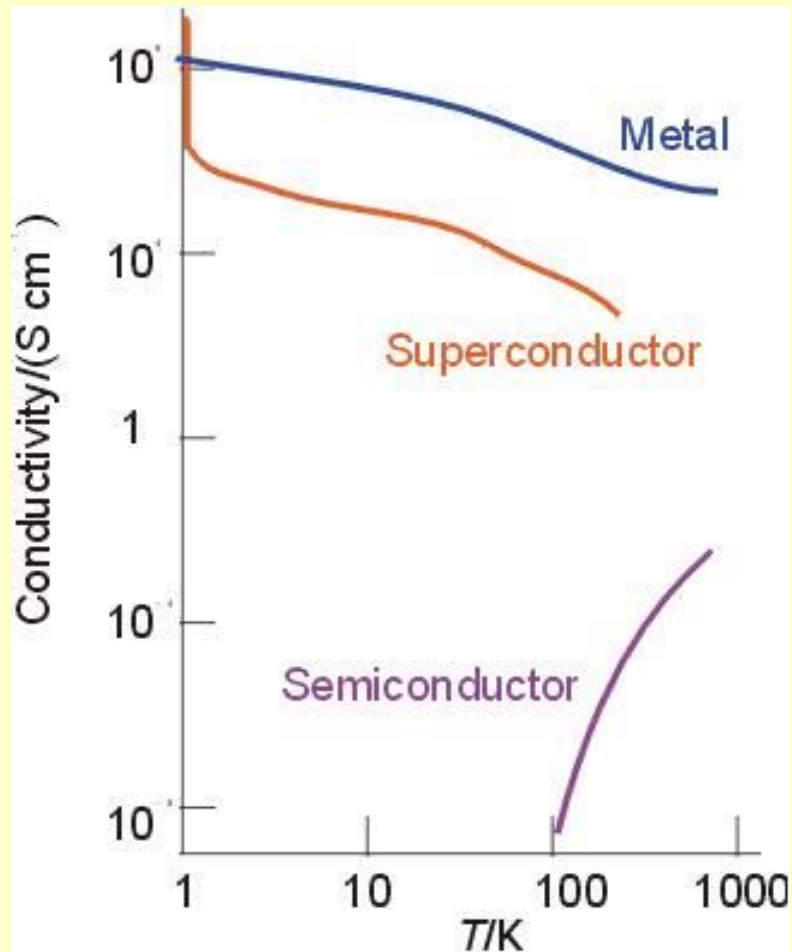

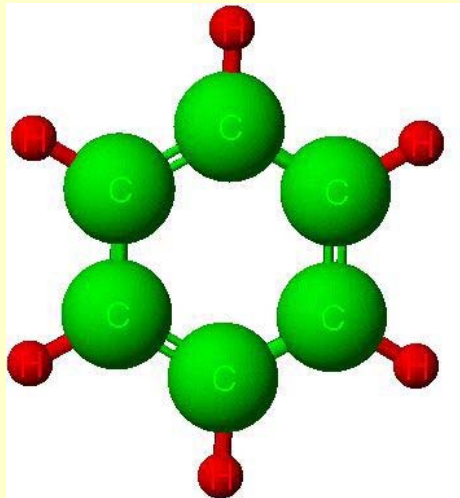

Bands in Graphite

Graphite is a conductor

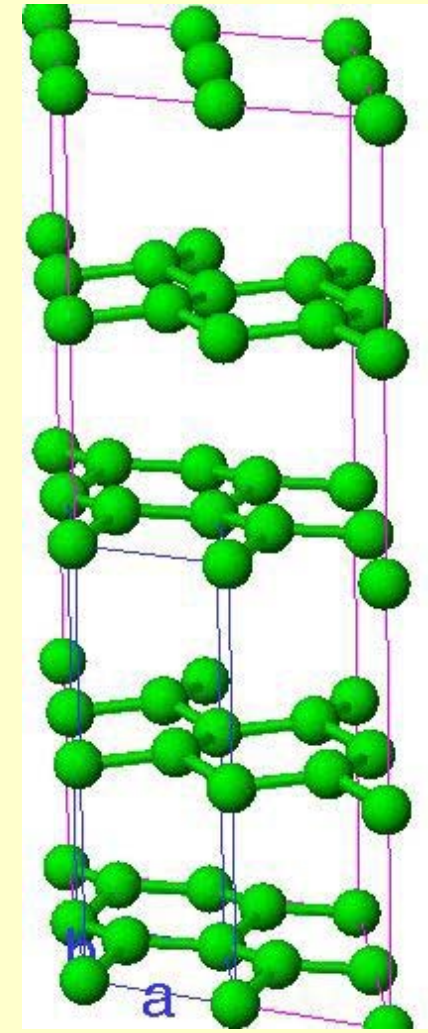
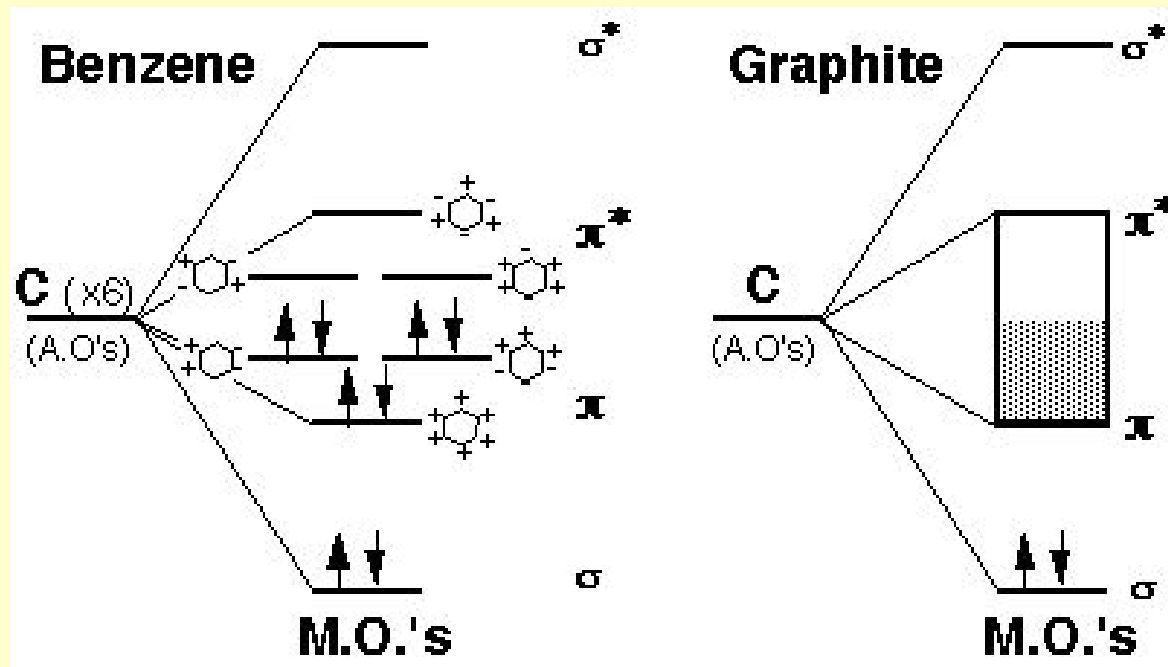

Bands in Diamond

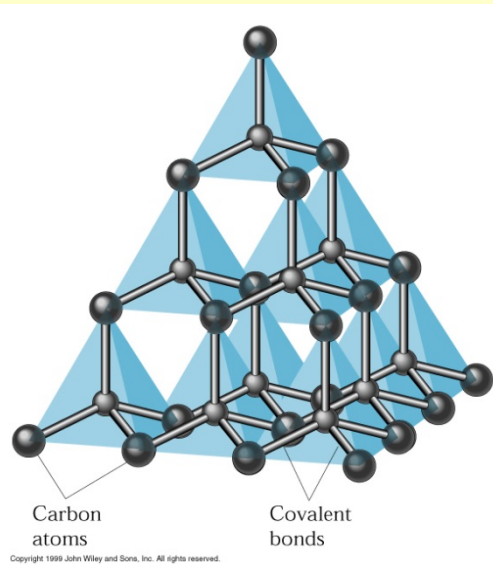
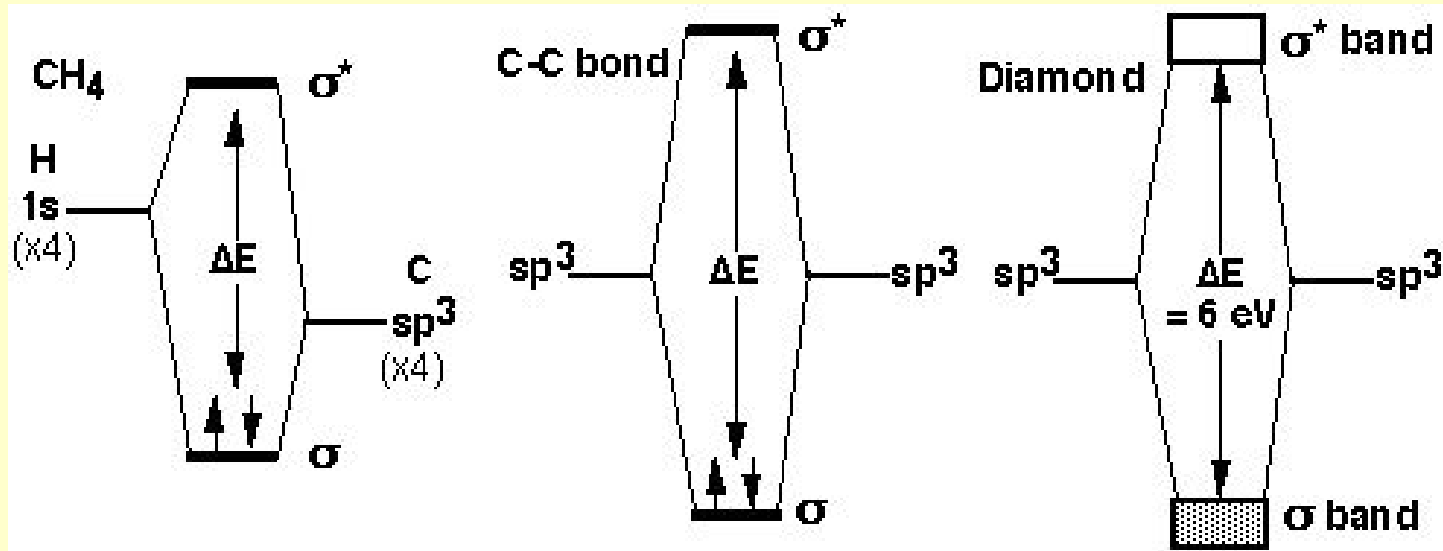

Semiconductors

Semiconductors - a similar band structure to insulators but the band gap is small, some electrons have sufficient thermal energy to be promoted up to the empty conduction band.

Two types of conduction mechanism in semiconductors:

- Electrons promoted into the conduction band = **negative charge carriers**, move towards a positive electrode under an applied potential.

- The holes these electrons leave behind = **positive holes**. Holes move when an electron enters them - new positive hole. The positive holes move in an opposite direction to the electrons.

Semiconductors

INTRINSIC

Intrinsic semiconductors are **pure materials** with the band structure. The number of electrons in the conduction band is determined only by the size of the band gap and the temperature (more electrons with small band gap and high temperature).

EXTRINSIC

Extrinsic semiconductors are materials where the conductivity is controlled by adding **dopants** with different numbers of valence electrons to that of the original material.

Semiconductors

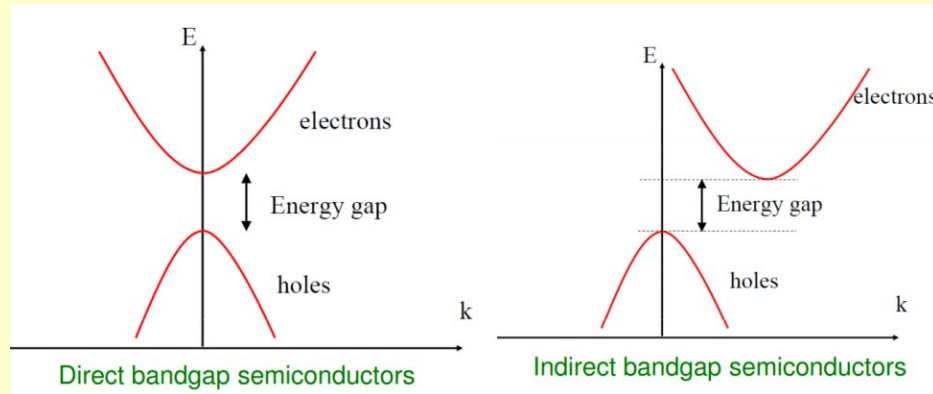

A direct band gap

(InAs, GaAs)

the band edges aligned in k , so that an electron can transit from the valence band to the conduction band, with the emission of a photon, without changing considerably the momentum.

An indirect band gap

(Si, Ge, AlSb)

the band edges are not aligned so the electron does not transit directly to the conduction band. In this process both a photon and a phonon are involved.

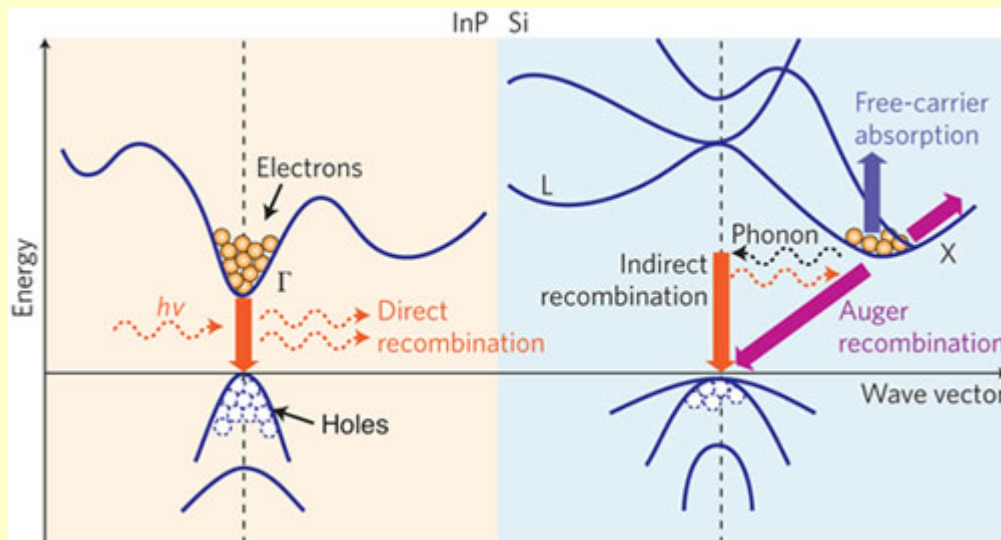

Direct / Indirect Band Gap

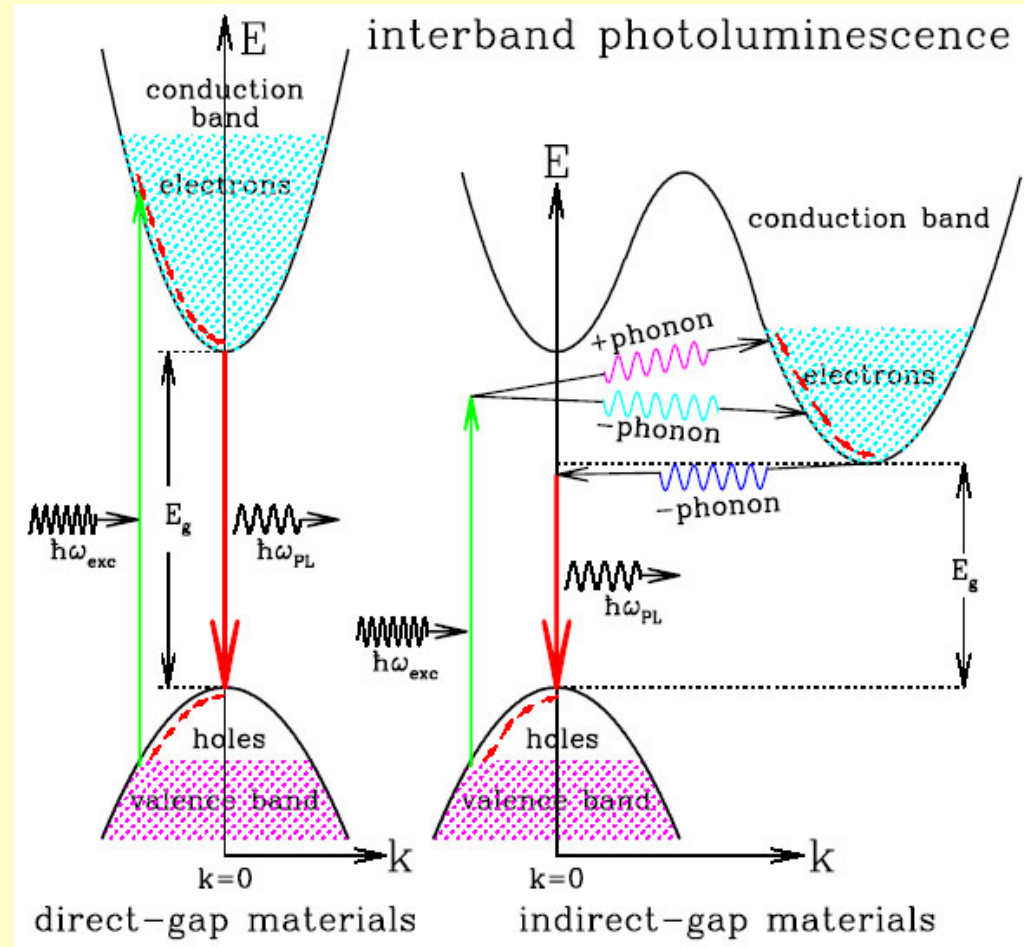

Semiconductors

Two fundamental differences between extrinsic and intrinsic semiconductors:

1) At standard temperatures **extrinsic** semiconductors tend to have significantly **greater conductivities** than comparable **intrinsic** ones.

2) The **conductivity** of an **extrinsic** semiconductor can easily and accurately be **controlled** by controlling the amount of dopant.

Materials can be manufactured to exact specifications of conductivity.

Metals

$T > 0$

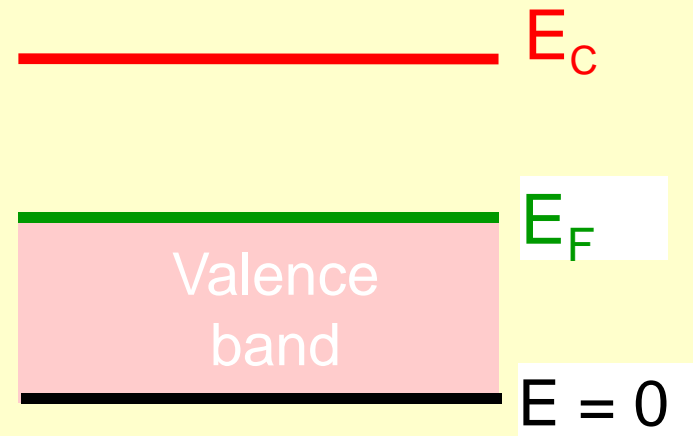
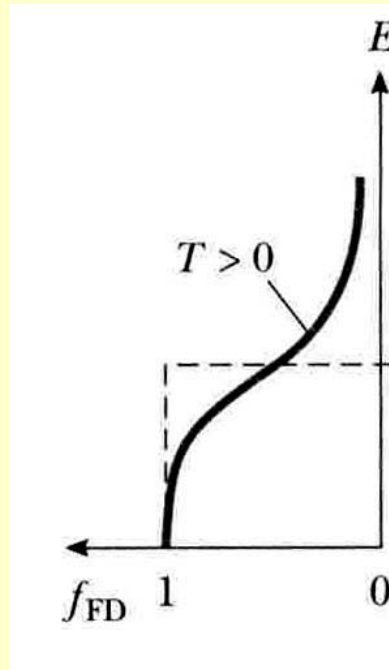

Insulators

$T > 0$

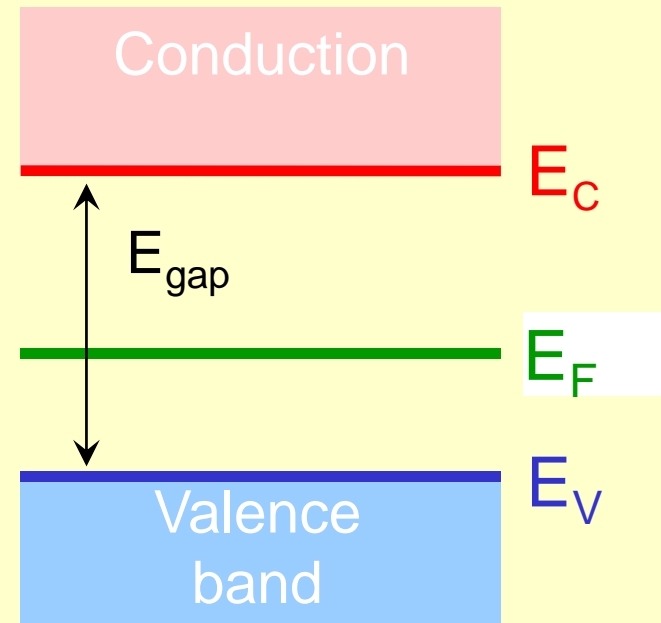
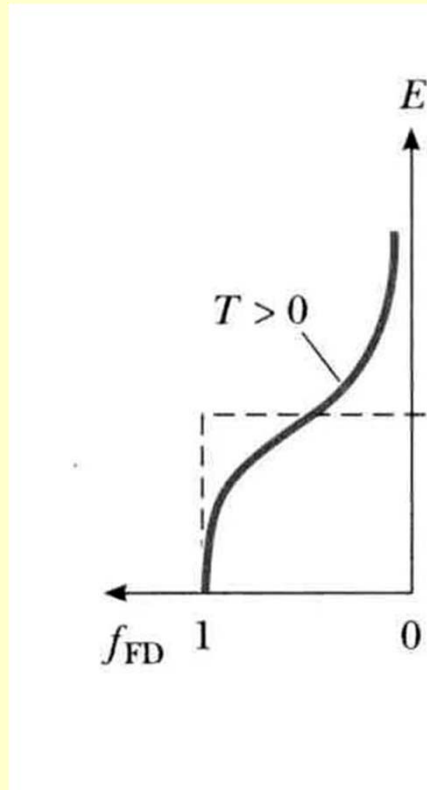

Intrinsic Semiconductors

$T > 0$

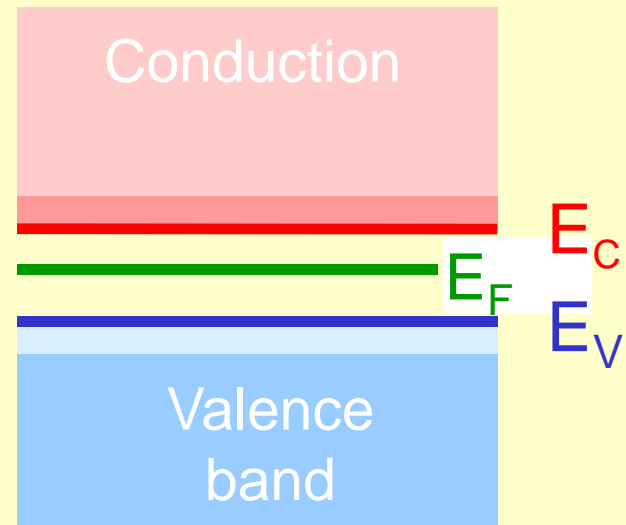
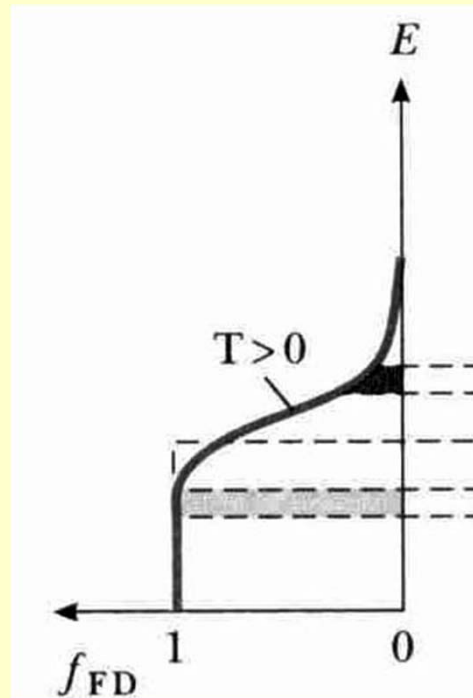

Extrinsic Semiconductors

Semiconductors: n- and p-Type

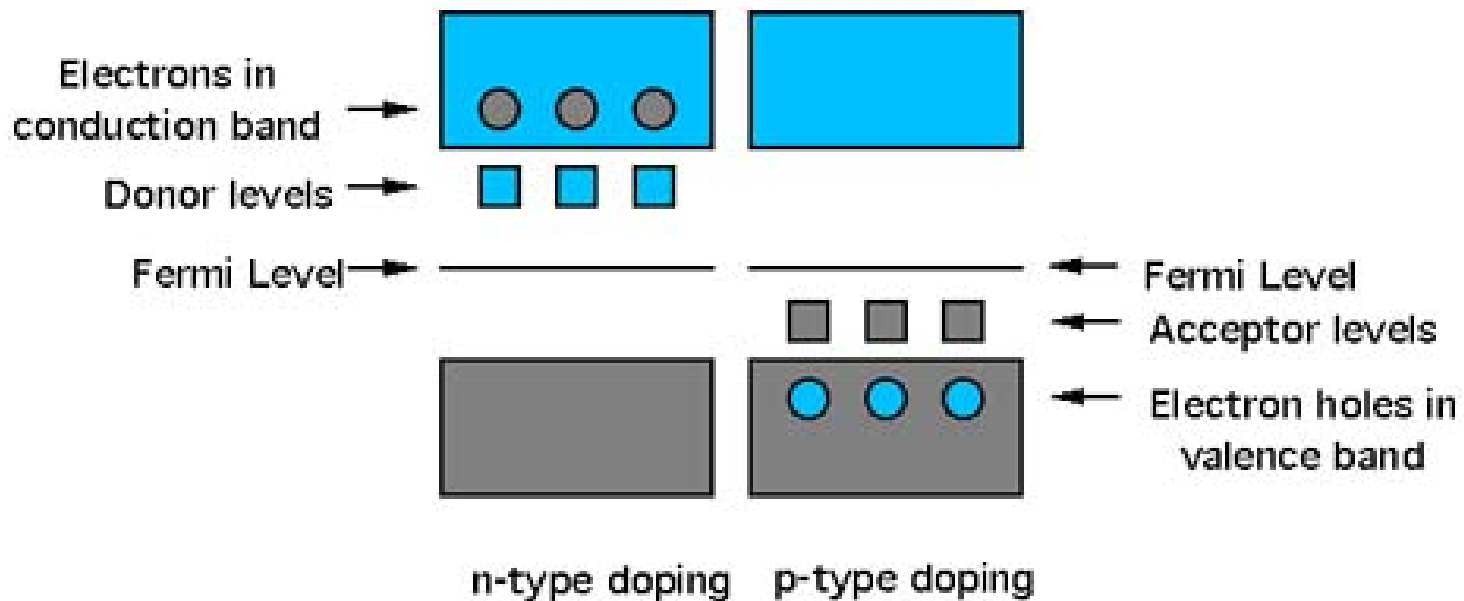

Extrinsic Semiconductors

Doping of semiconductors - introducing atoms with **more or less electrons** than the parent element.

Doping is substitutional, the dopant atoms directly replace the original atoms.

Very low levels of dopant are required, only 1 atom in 10^9 of the parent atoms.

Extrinsic Semiconductors n-type

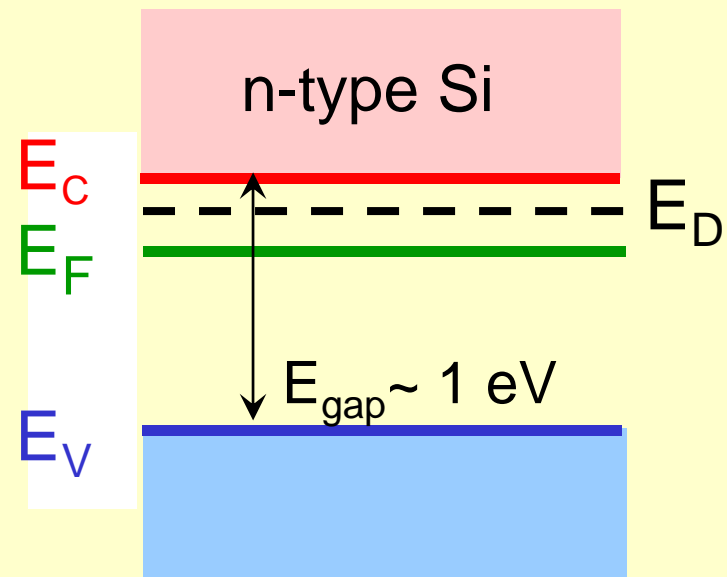

Extrinsic Semiconductors n-type

Silicon - phosphorous atoms introduce extra electrons (one extra valence electron for each dopant atom introduced as P)

The dopant atoms form a set of energy levels that lie in the band gap between the valence and conduction bands, but close to the conduction band.

The electrons in the dopant levels cannot move directly - there is not enough of them to form a continuous band.

The levels act as **donor levels** because the electrons have enough thermal energy to get up into the conduction band where they can move freely.

n-type semiconductors, the negative charge carriers or electrons.

Extrinsic Semiconductors p-type

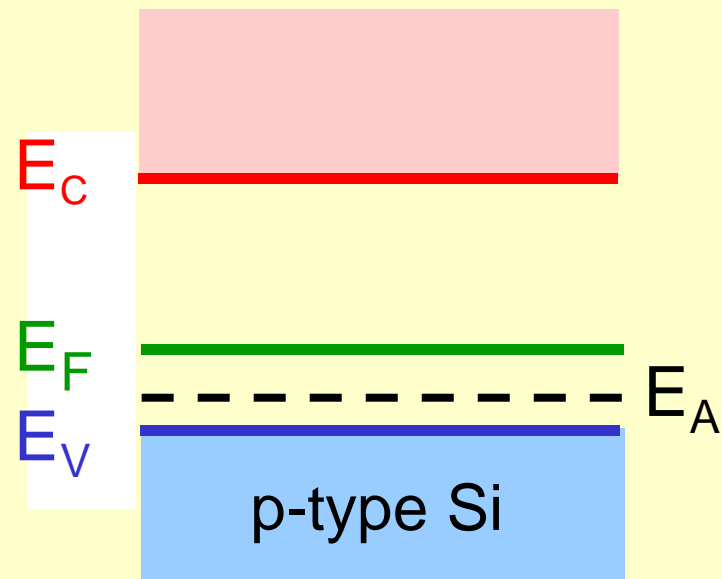

Extrinsic Semiconductors p-type

Doping with an element with one less valence electron such as Ga

For every dopant atom - an electron missing,

form a narrow, empty band consisting of **acceptor levels** which lie just above the valence band, discrete levels if the concentration of gallium atoms is small.

Electrons from the valence band have enough thermal energy to be promoted into the acceptor levels, electrons in the acceptor levels cannot contribute to the conductivity of the material.

The positive holes in the valence band left behind by the promoted electrons are able to move - **p-type semiconductors**, the positive holes.

Electronic Bands in Nanoparticles

