

SAMPLE PREPARATION AND SEQUENCING

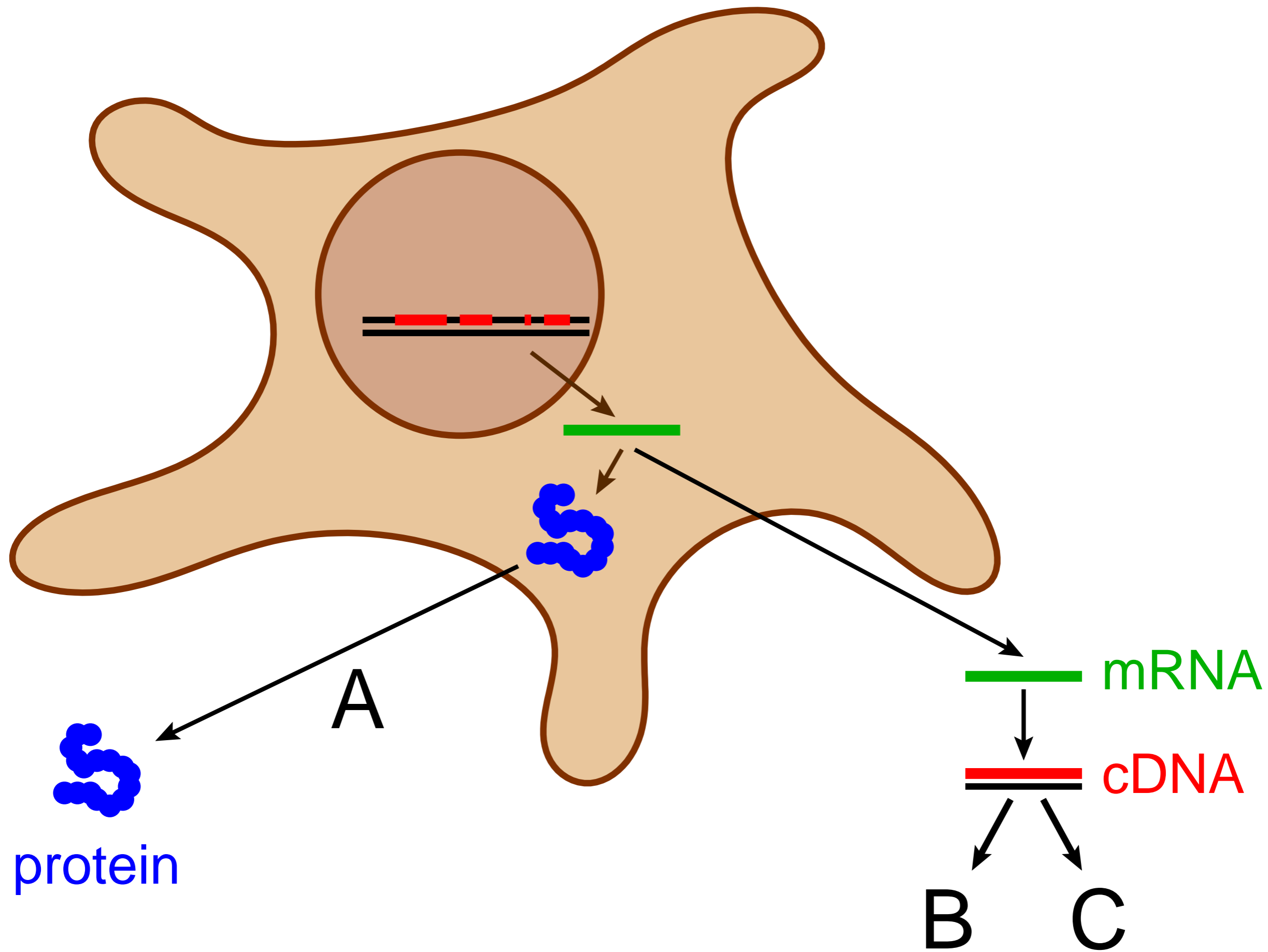

B

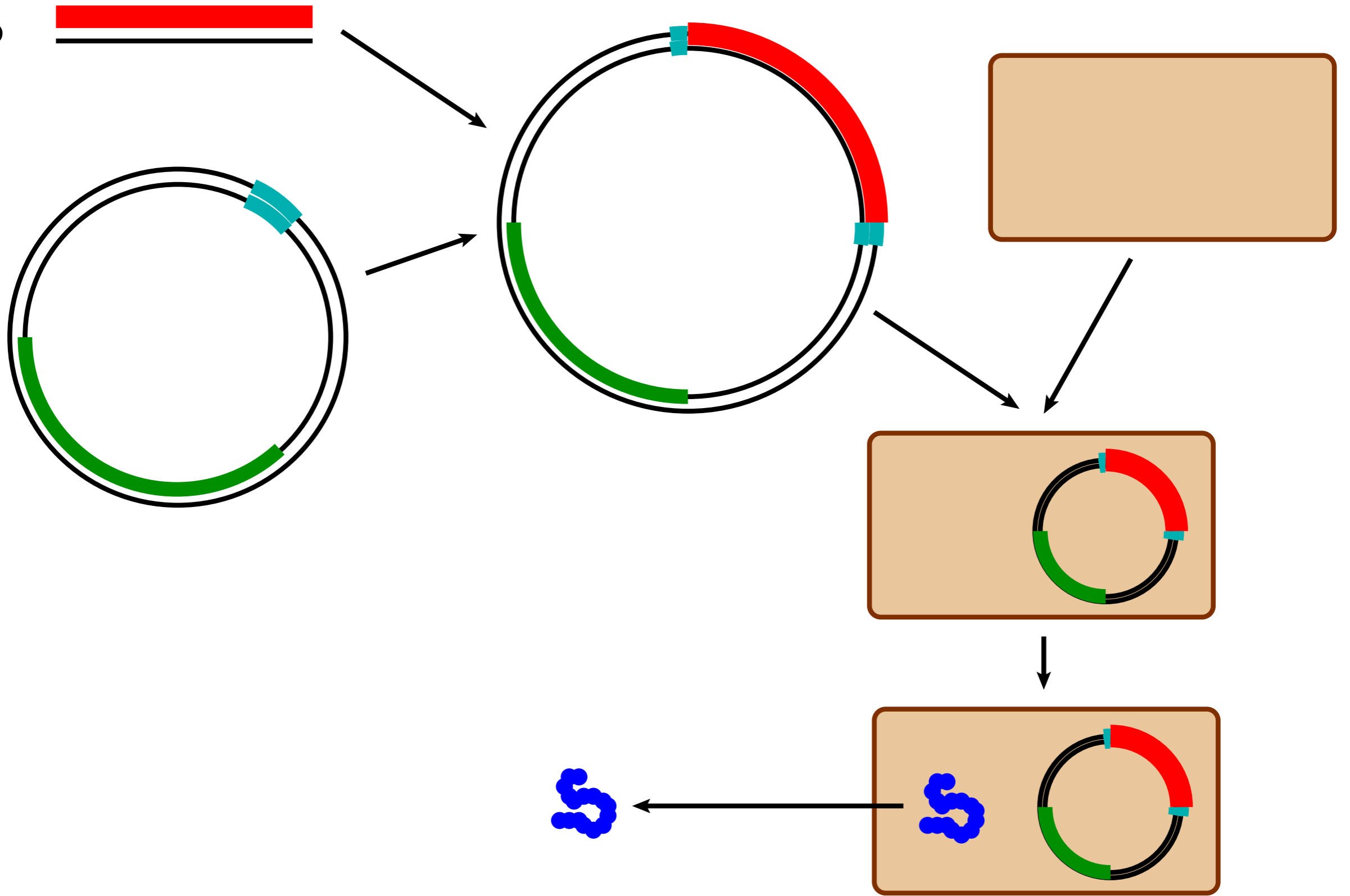

B

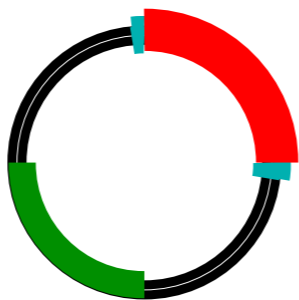
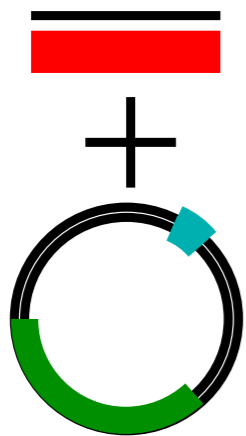

+

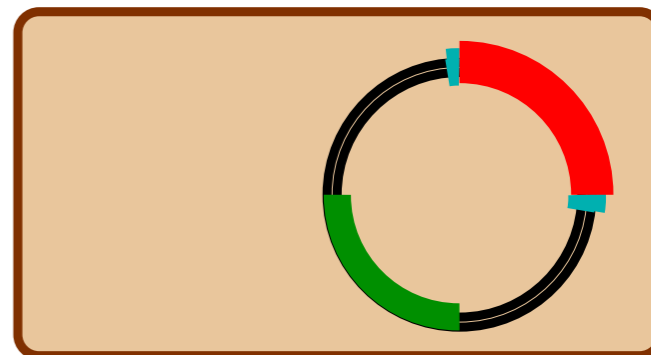
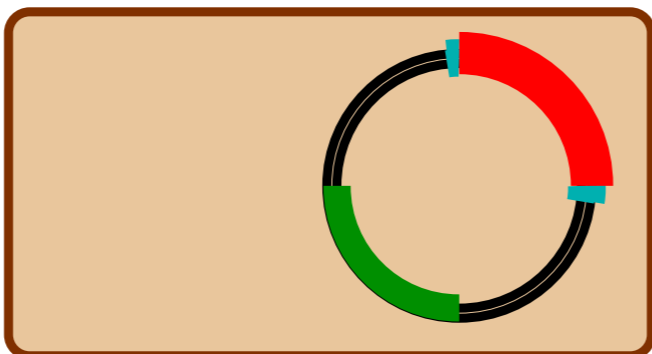
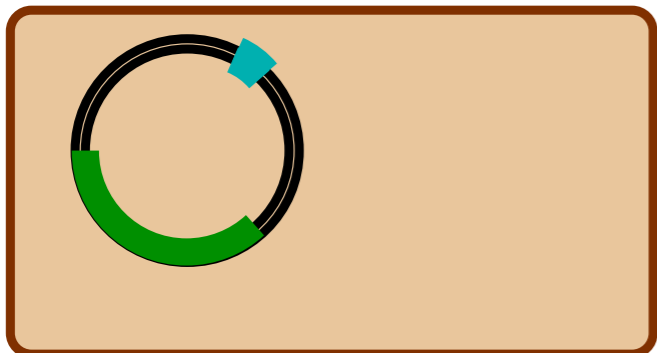

B

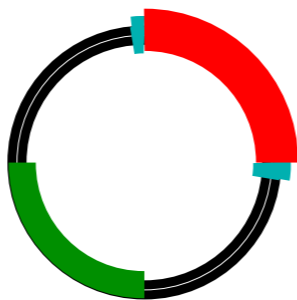
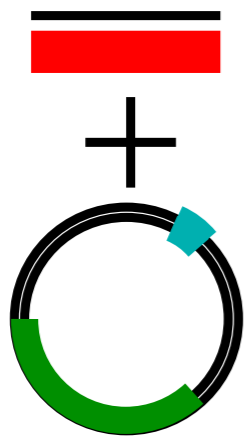

+

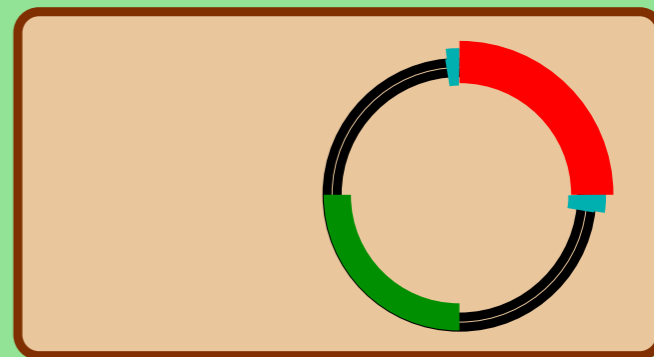
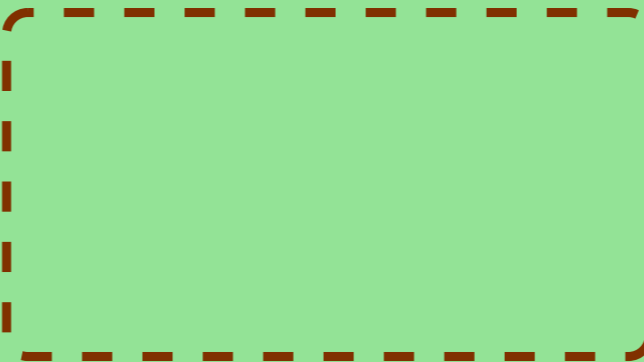
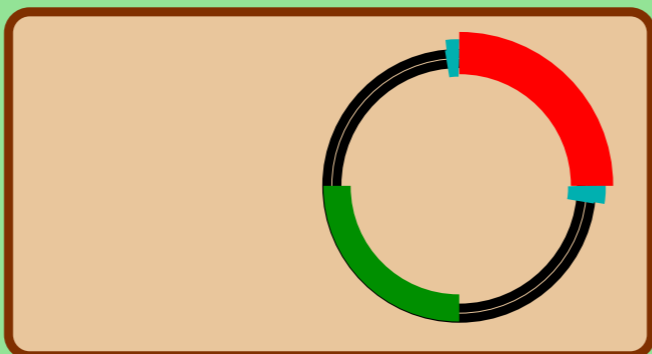
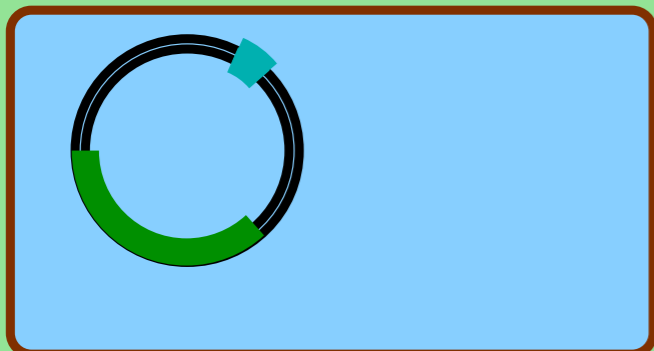

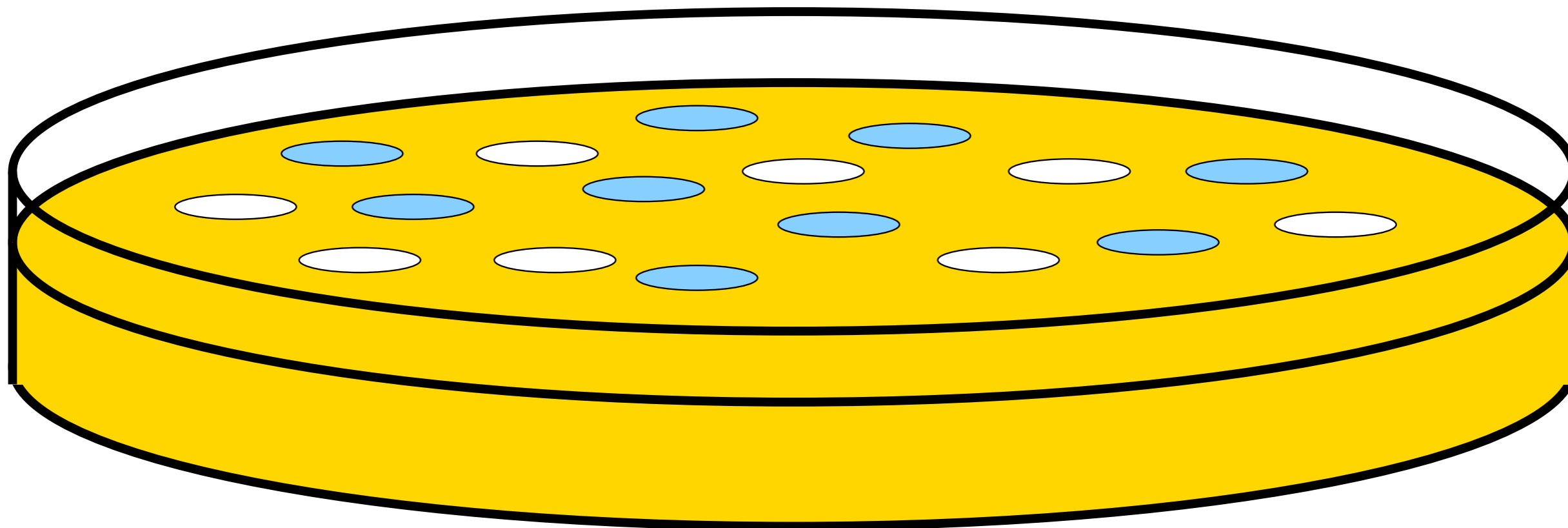

B

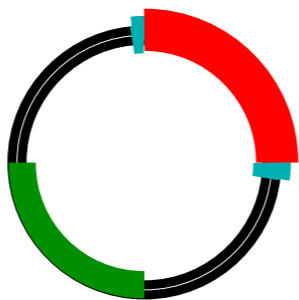
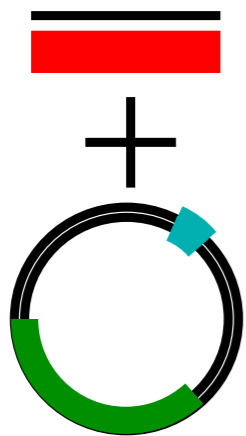

+

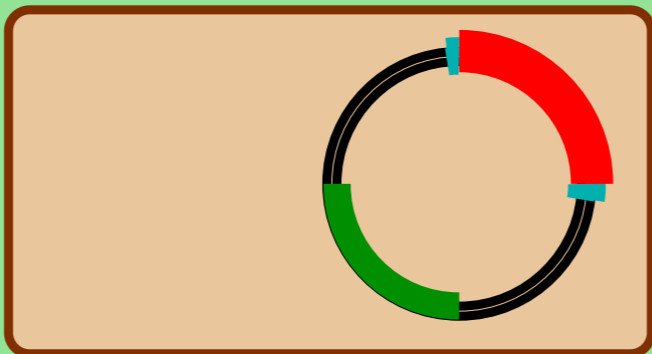

B

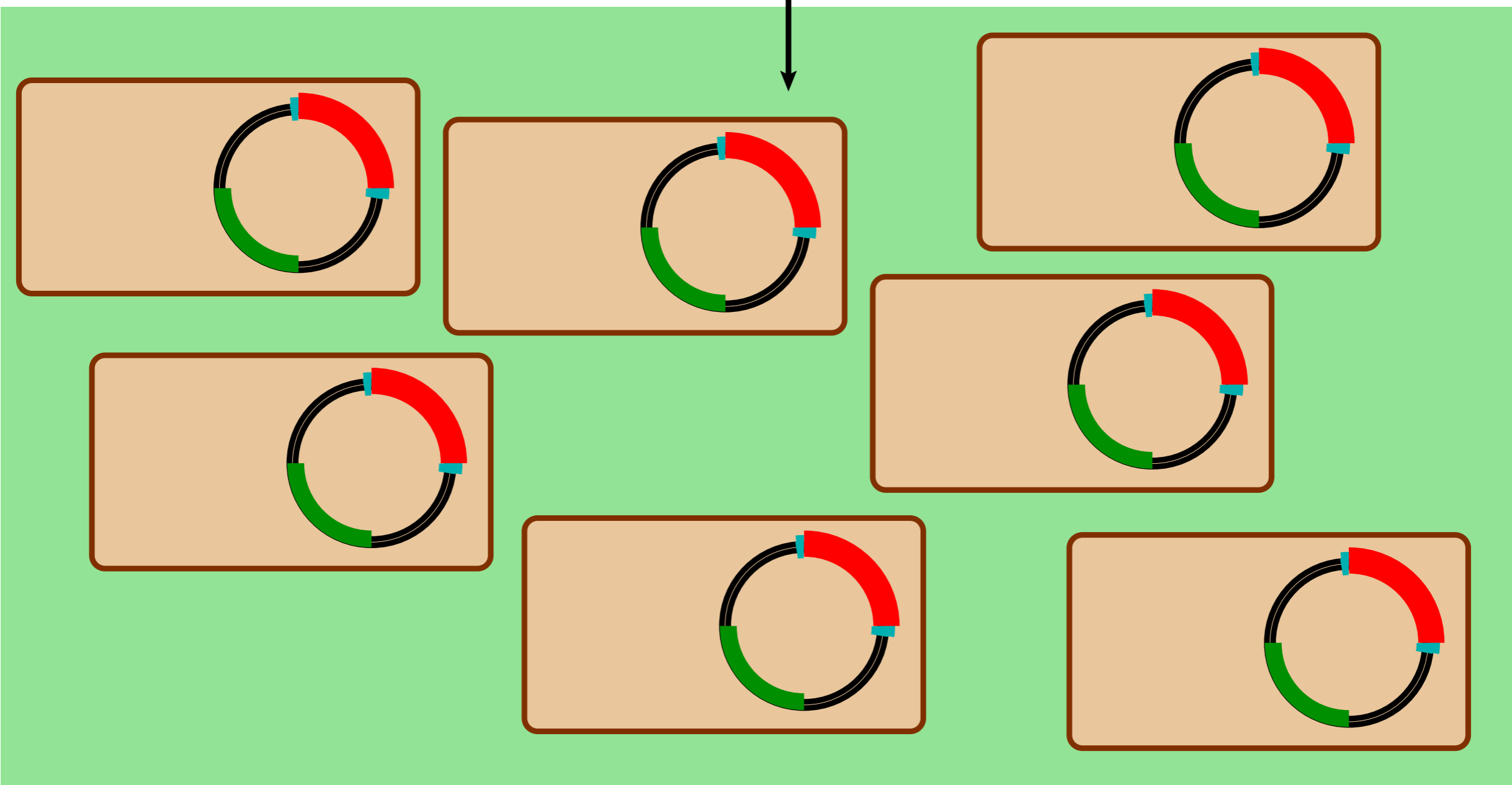
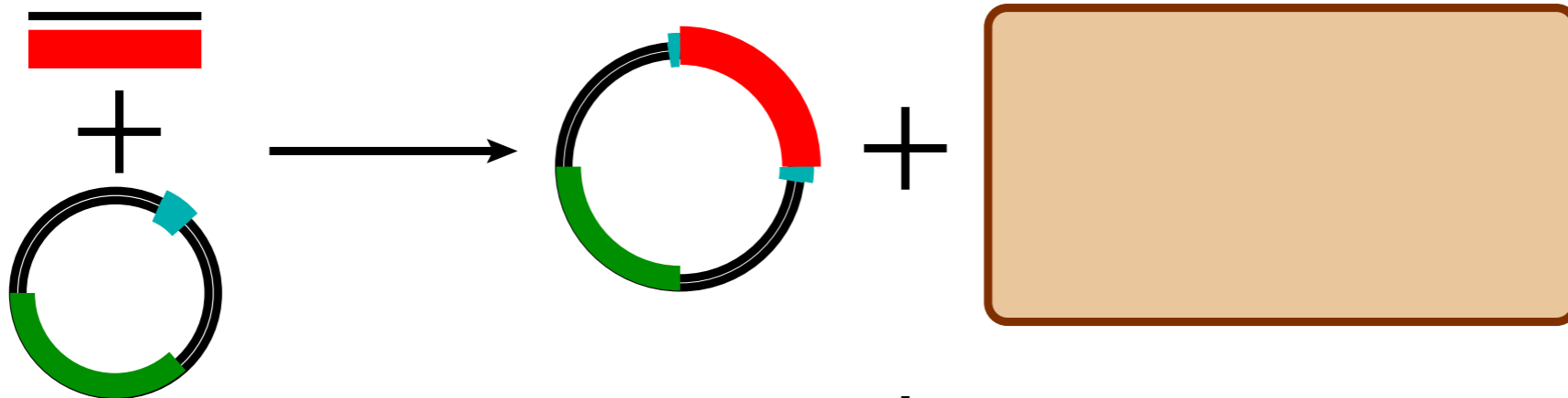

B

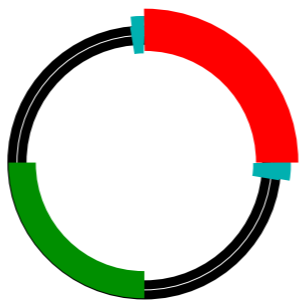
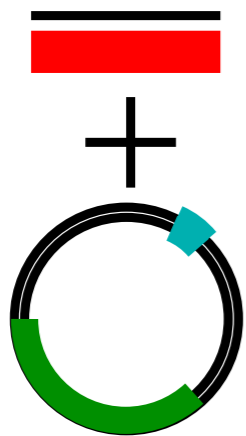

+

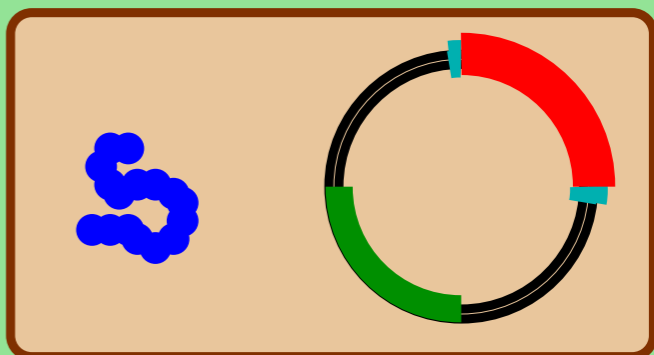
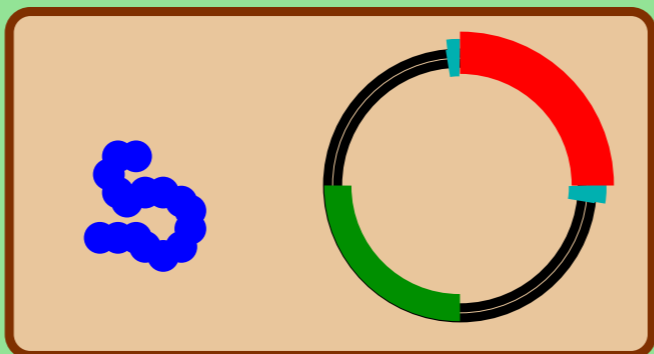
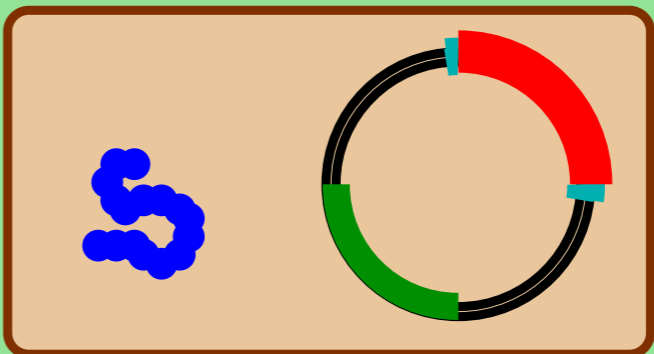
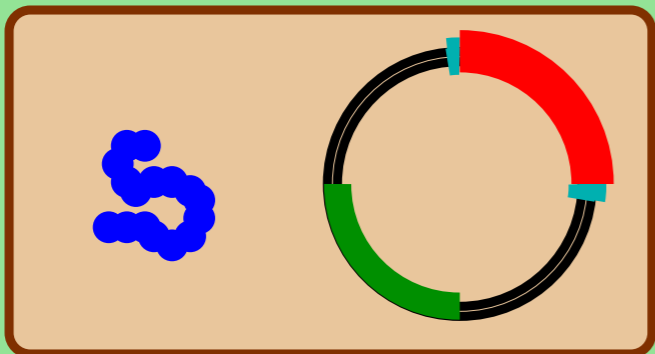
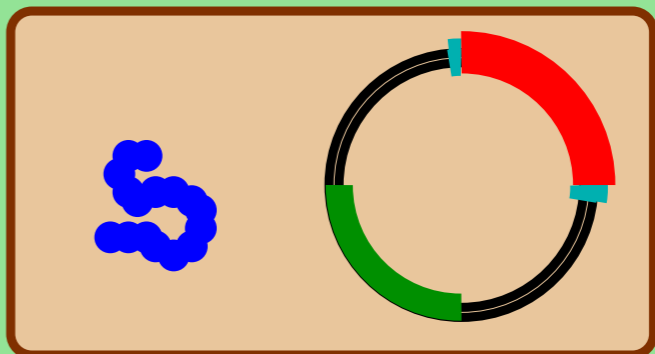
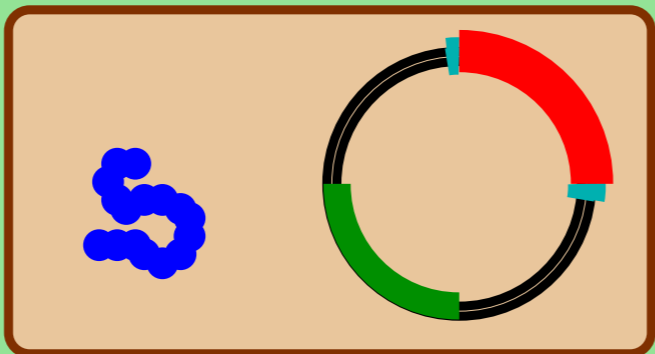
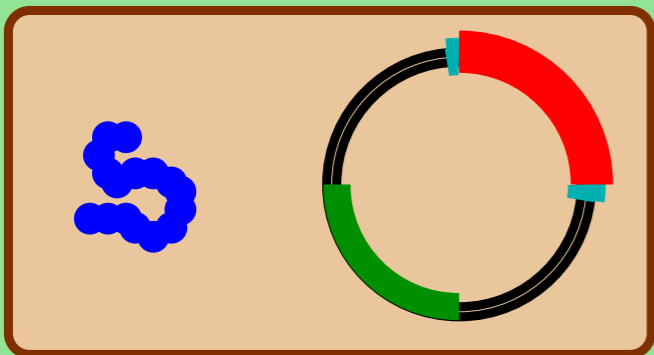

C

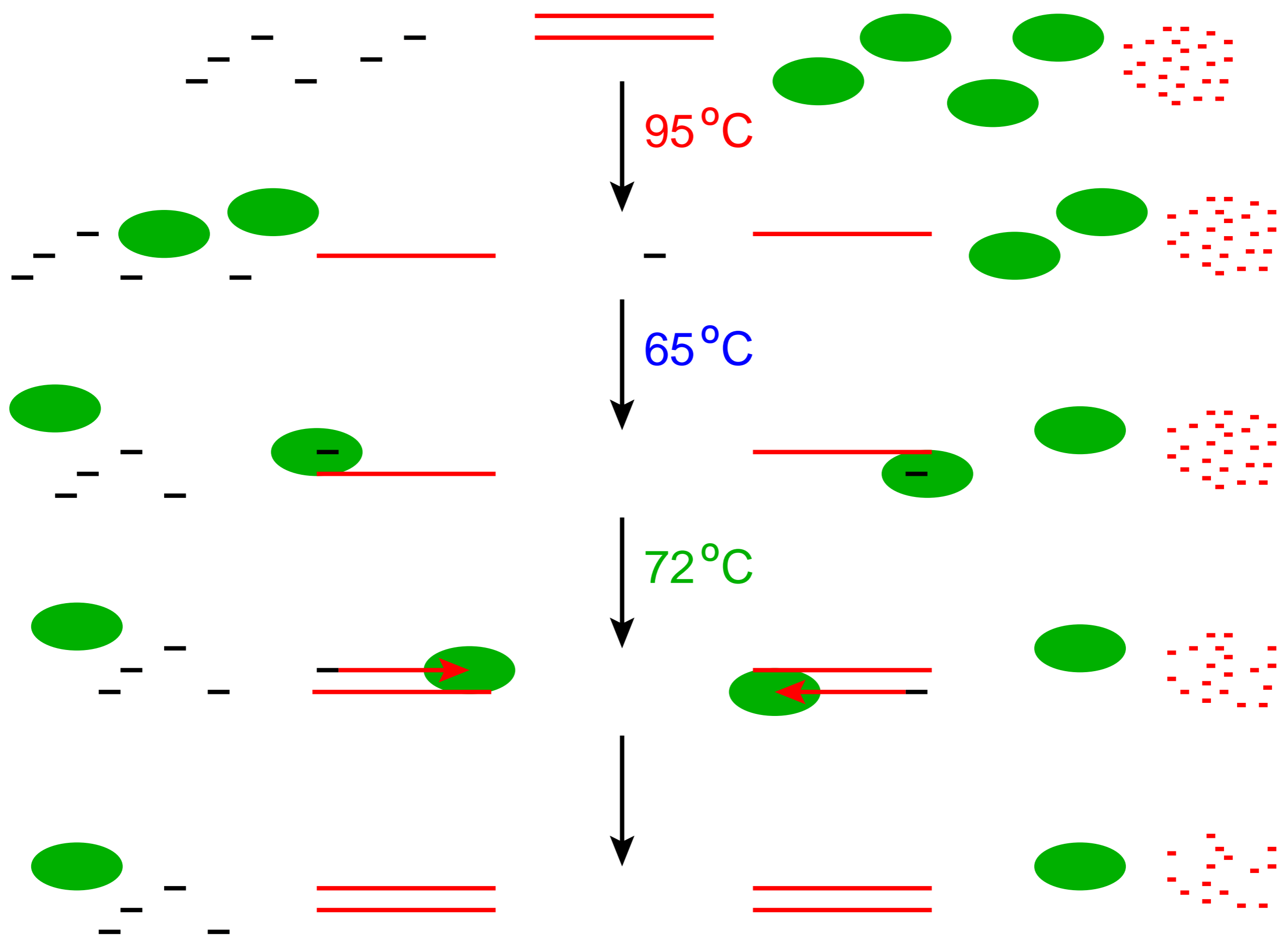

D

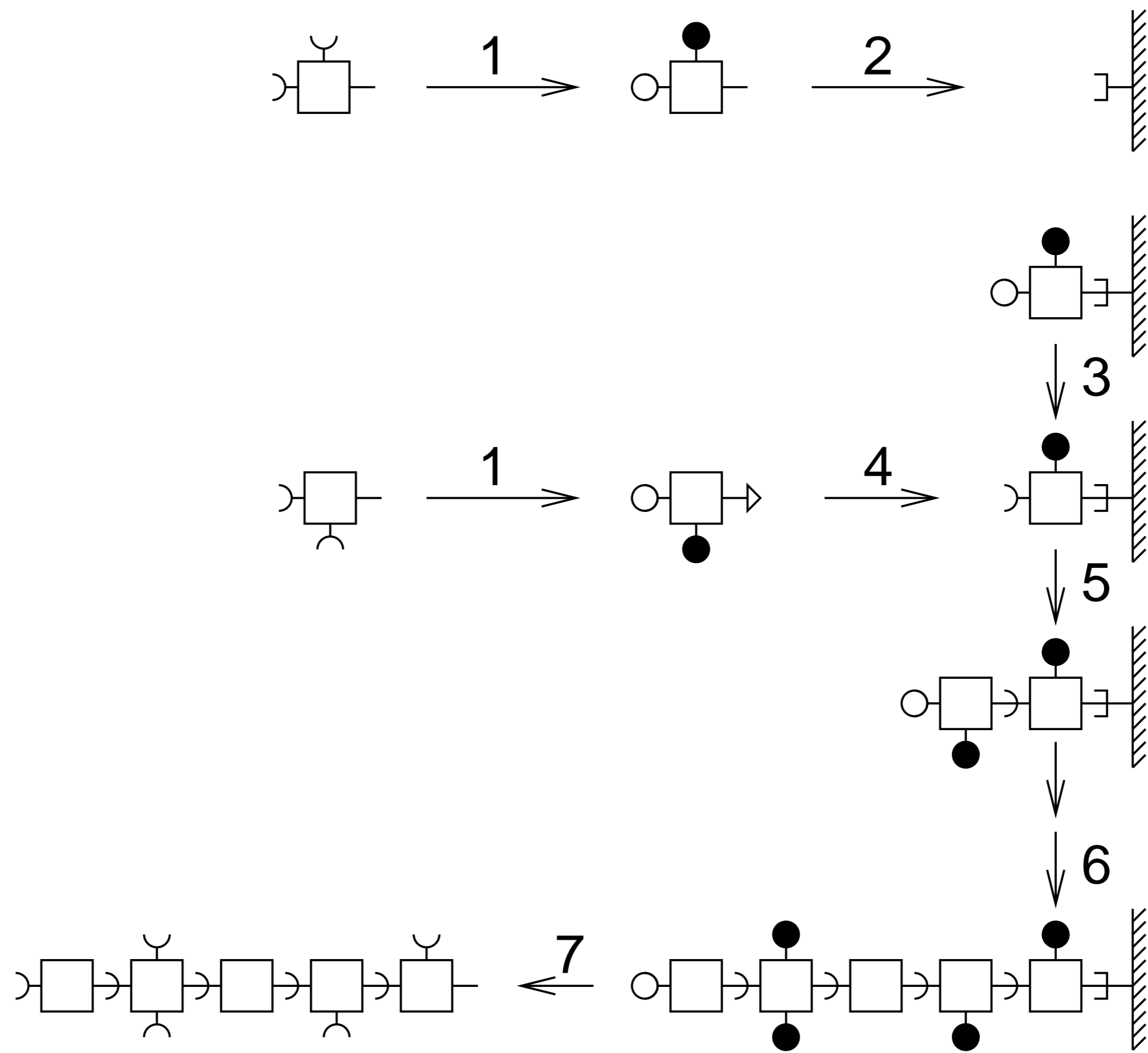

UUU	Phe	UCU	Ser	UAU	Tyr	UGU	Cys
UUC	Phe	UCC	Ser	UAC	Tyr	UGC	Cys
UUA	Leu	UCA	Ser	UAA		UGA	
UUG	Leu	UCG	Ser	UAG		UGG	Trp
CUU	Leu	CCU	Pro	CAU	His	CGU	Arg
CUC	Leu	CCC	Pro	CAC	His	CGC	Arg
CUA	Leu	CCA	Pro	CAA	Gln	CGA	Arg
CUG	Leu	CCG	Pro	CAG	Gln	CGG	Arg
AUU	Ile	ACU	Thr	AAU	Asn	AGU	Ser
AUC	Ile	ACC	Thr	AAC	Asn	AGC	Ser
AUA	Ile	ACA	Thr	AAA	Lys	AGA	Arg
AUG	Met	ACG	Thr	AAG	Lys	AGG	Arg
GUU	Val	GCU	Ala	GAU	Asp	GGU	Gly
GUC	Val	GCC	Ala	GAC	Asp	GGC	Gly
GUA	Val	GCA	Ala	GAA	Glu	GGA	Gly
GUG	Val	GCG	Ala	GAG	Glu	GGG	Gly

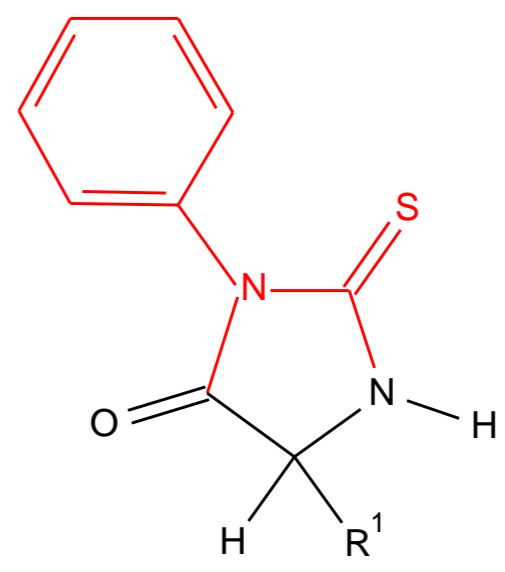
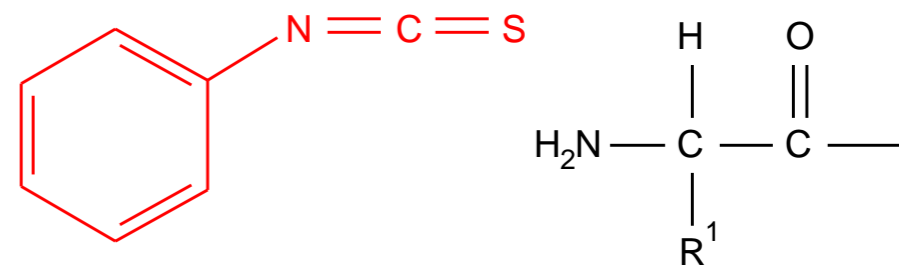
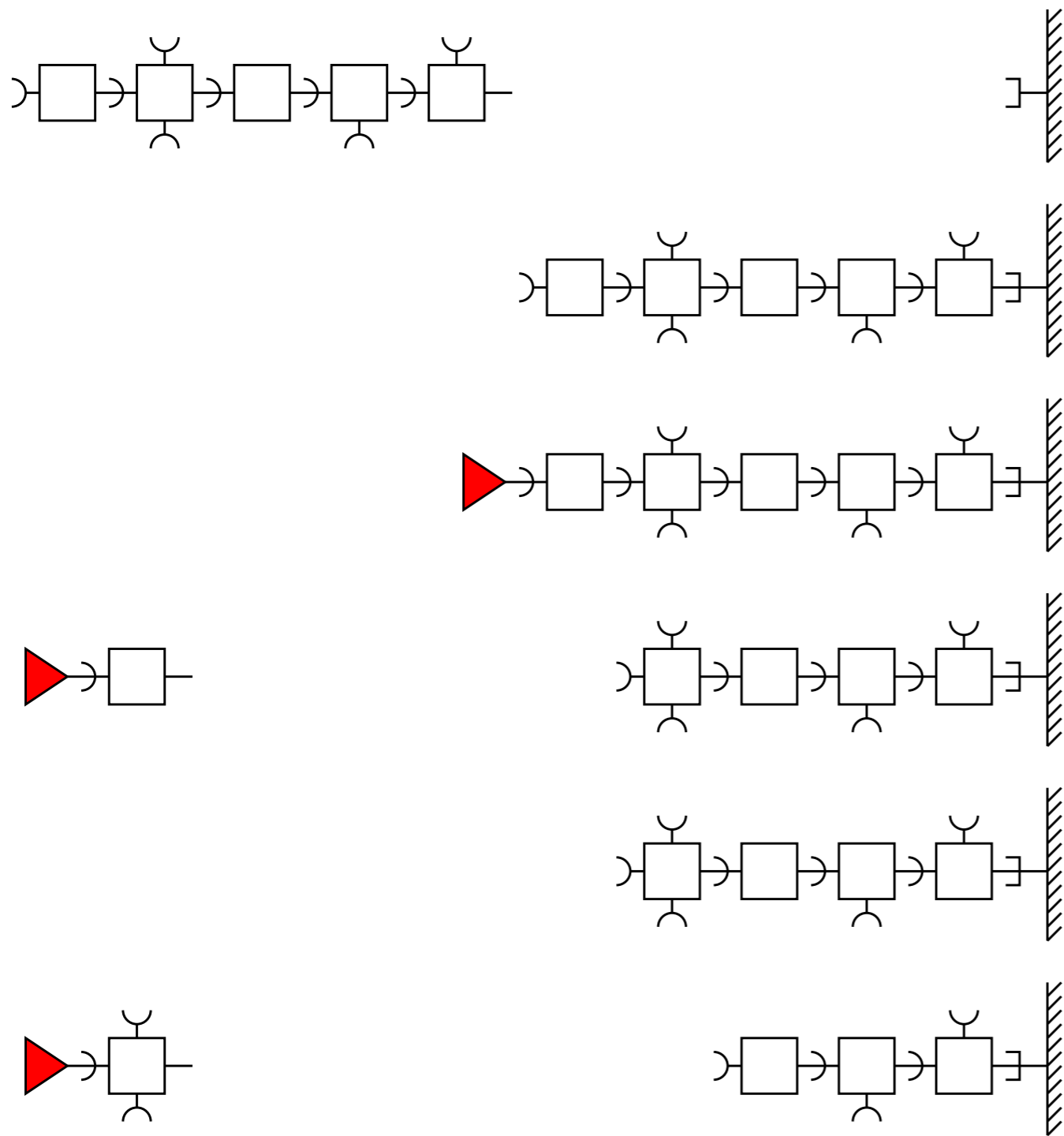

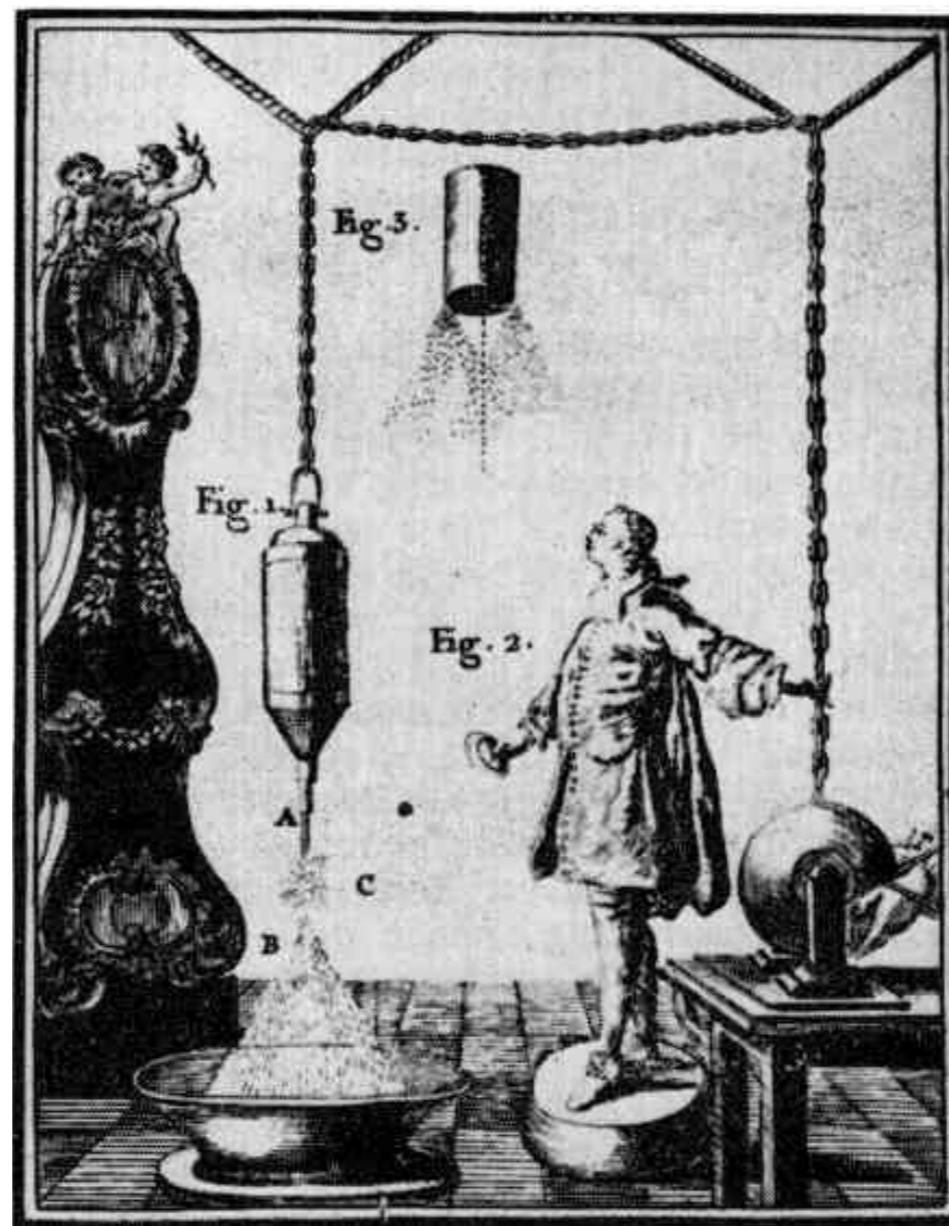

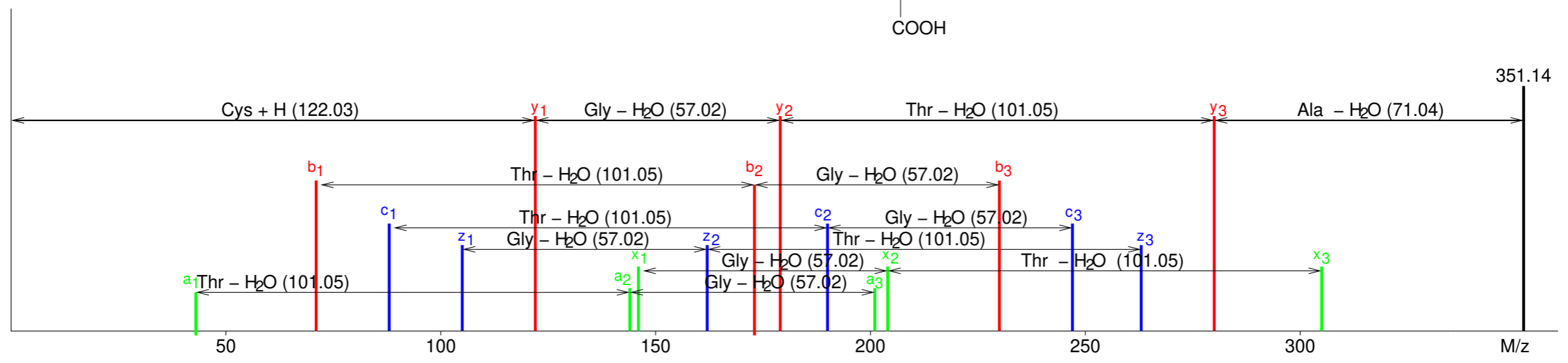
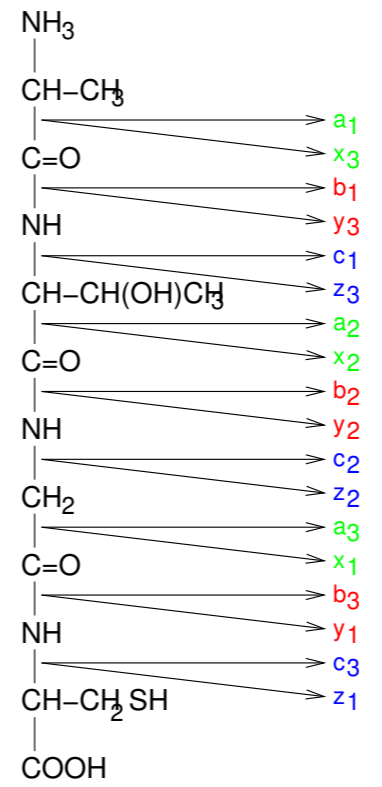
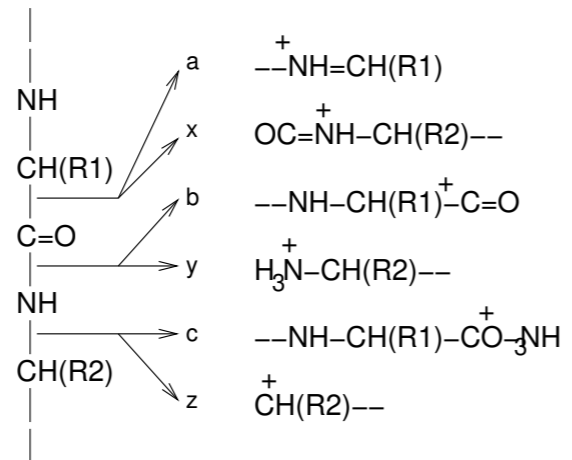

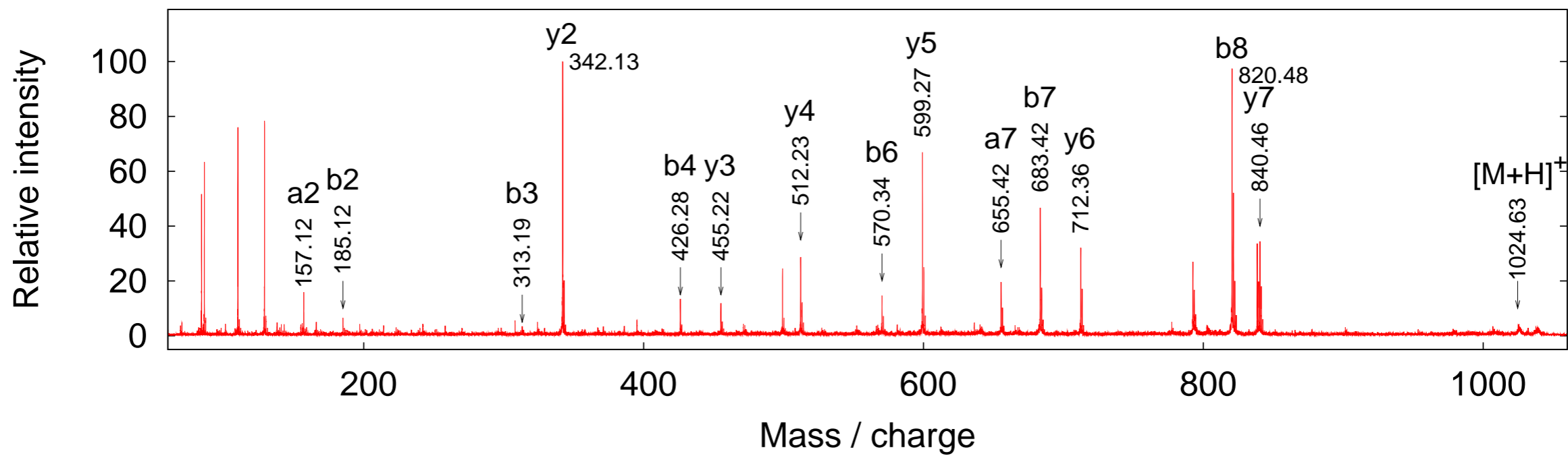

a

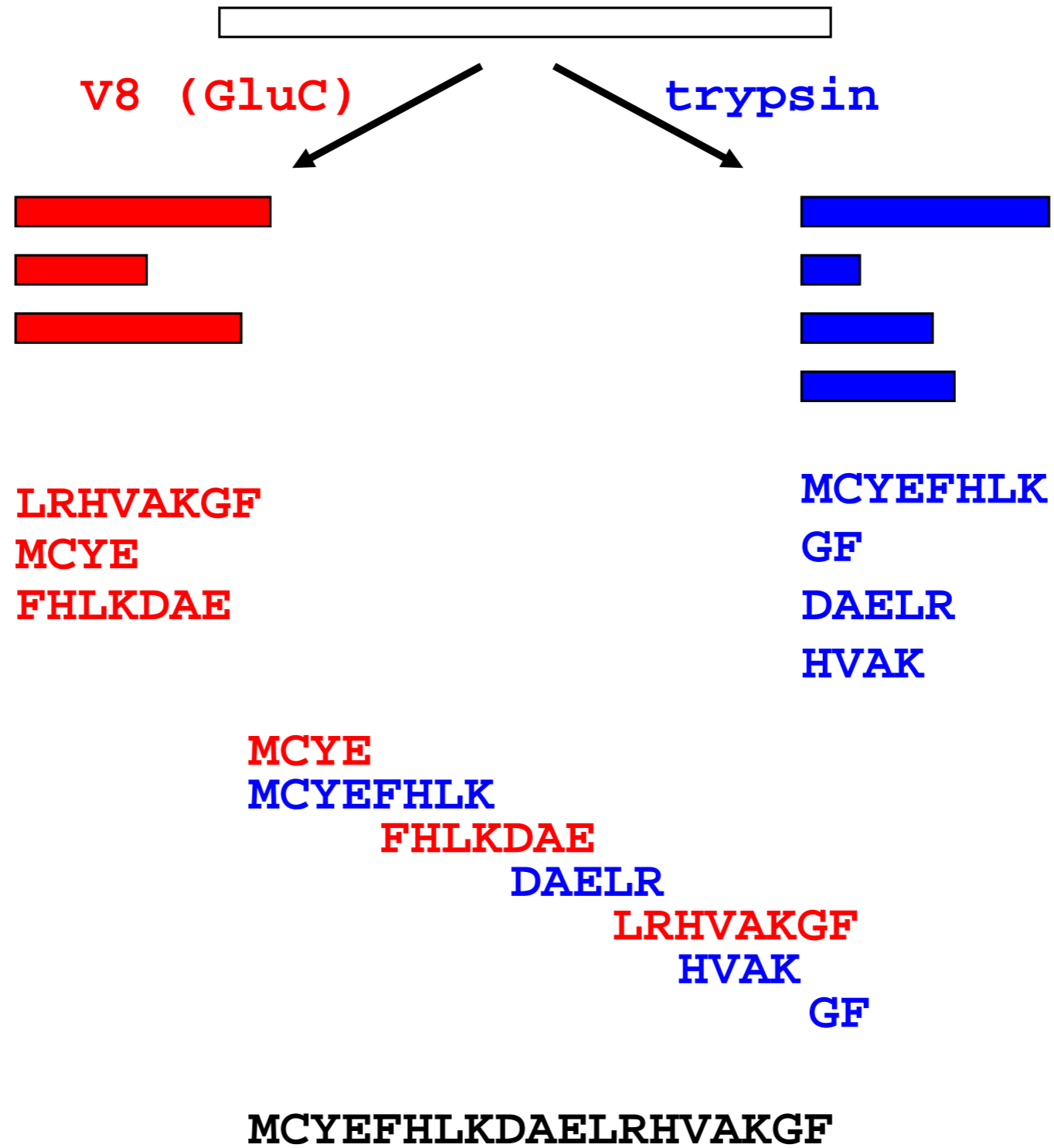

b



UUU	Phe	UCU	Ser	UAU	Tyr	UGU	Cys
UUC	Phe	UCC	Ser	UAC	Tyr	UGC	Cys
UUA	Leu	UCA	Ser	UAA		UGA	
UUG	Leu	UCG	Ser	UAG		UGG	Trp
CUU	Leu	CCU	Pro	CAU	His	CGU	Arg
CUC	Leu	CCC	Pro	CAC	His	CGC	Arg
CUA	Leu	CCA	Pro	CAA	Gln	CGA	Arg
CUG	Leu	CCG	Pro	CAG	Gln	CGG	Arg
AUU	Ile	ACU	Thr	AAU	Asn	AGU	Ser
AUC	Ile	ACC	Thr	AAC	Asn	AGC	Ser
AUA	Ile	ACA	Thr	AAA	Lys	AGA	Arg
AUG	Met	ACG	Thr	AAG	Lys	AGG	Arg
GUU	Val	GCU	Ala	GAU	Asp	GGU	Gly
GUC	Val	GCC	Ala	GAC	Asp	GGC	Gly
GUA	Val	GCA	Ala	GAA	Glu	GGA	Gly
GUG	Val	GCG	Ala	GAG	Glu	GGG	Gly

³²P-CAGGTACGCGAT

hydrazin

hydrazin
+ 2M NaCl

dimethylsulfat

dimethylsulfat



piperidin

piperidin

pH < 7

pH > 7

90 °C, pH > 7

90 °C, pH > 7



³²P-CAGGTACGC

³²P-CAGGTACGC

³²P-CAGGTACGCGA

³²P-CAGGTACGCG

³²P-CAGGTAC

³²P-CAGGTAC

³²P-CAGGTACGCG

³²P-CAGGTACG

³²P-CAGGT

³²P-C

³²P-CAGGTACG

³²P-CAGG

³²P-C

³²P-CAGGTA

³²P-CAG

³²P-CAGG

³²P-CAG

³²P-CA

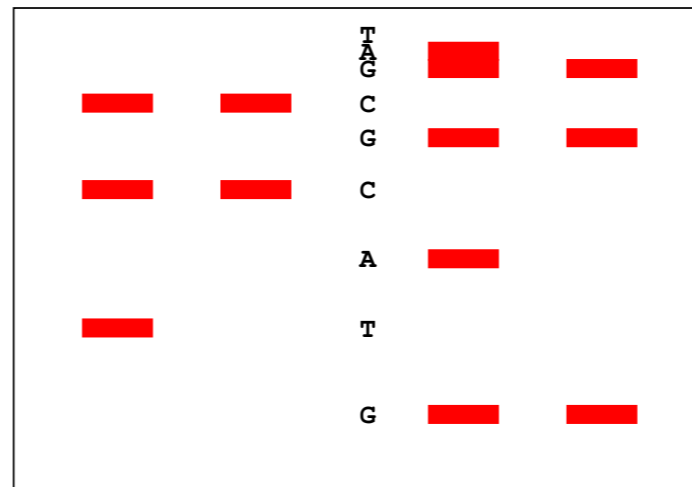
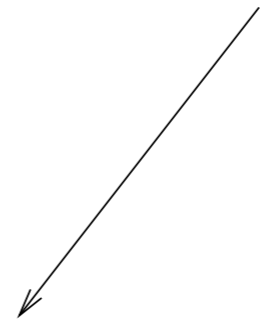
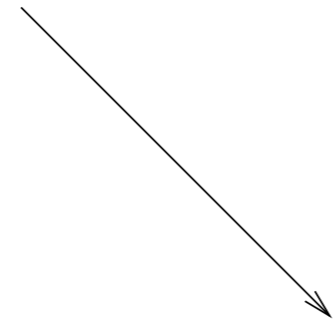

3' CAGGTACGCGAT 5'

dideoxy **A**

dideoxy **T**

dideoxy **C**

dideoxy **G**



PCR



GTCC**A**

GTCCATGCGCT **A**



PCR



GT**T**

GTCC**A**T

GTCCATGCGC **T**



PCR



GT**C**

GT**C**C

GTCCATG **C**

GTCCATGCG **C**



PCR



G

GTCCAT**G**

GTCCATGC **G**

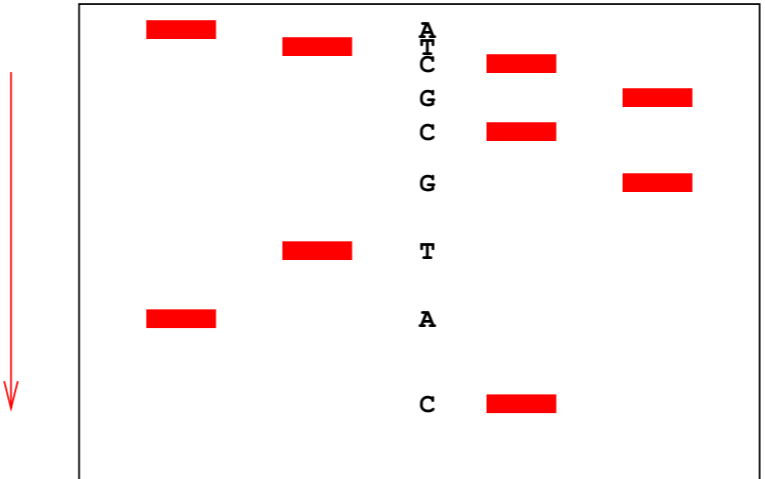
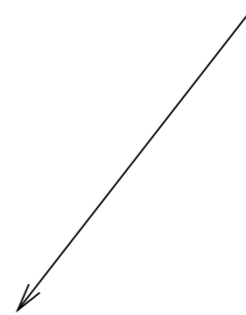
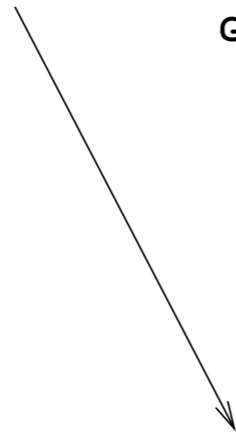

3' CAGGTACGCGAT 5'



dideoxyA

dideoxyT

dideoxyC

dideoxyG



PCR



GTCCA

GT

GTC

G

GTCCATGCGCTA

GTCCAT

GTCC

GTCCATG

GTCCATGCGCT

GTCCATGC

GTCCATGC

GTCCATGCGC

